

SIEMENS

MICROMASTER 420

Operating Instructions

Issue B1



MICROMASTER 420 Documentation

Getting Started Guide

Is for quick commissioning with SDP and BOP.



Operating Instructions

Gives information about features of the MICROMASTER 420, Installation, Commissioning, Control modes, System Parameter structure, Troubleshooting, Specifications and available options of the MICROMASTER 420.



Parameter List

The Parameter List contains the description of all Parameters structured in functional order and a detailed description. The Parameter list also includes a series of function plans.



Reference Manual

The Reference Manual gives detailed information about engineering communication troubleshooting and maintenance.



Catalogues

In the catalogue you will find all the necessary information to select an appropriate inverter, as well as filters, chokes, operator panels and communication options.



SIEMENS

MICROMASTER 420

Operating Instructions
User Documentation

Valid for Release

Inverter Type
MICROMASTER 420

Issue 10/01

Control Version
V1.1

Issue B1

Overview	1
Installation	2
Commissioning	3
Using the MICROMASTER 420	4
System Parameters	5
Troubleshooting	6
MICROMASTER 420 Specifications	7
Options	8
Electro-Magnetic Compatibility (EMC)	9
Appendices	A B C D E F G
Index	

Further information is available on the Internet under:

<http://www.siemens.de/micromaster>

Approved Siemens Quality for Software and Training
is to DIN ISO 9001, Reg. No. 2160-01

The reproduction, transmission or use of this document,
or its contents is not permitted unless authorized in
writing. Offenders will be liable for damages. All rights
including rights created by patent grant or registration of a
utility model or design are reserved.

© Siemens AG 2001. All Rights Reserved.

MICROMASTER® is a registered trademark of Siemens.

Other functions not described in this document may be
available. However, this fact shall not constitute an
obligation to supply such functions with a new control, or
when servicing.

We have checked that the contents of this document
correspond to the hardware and software described.
There may be discrepancies nevertheless, and no
guarantee can be given that they are completely identical.
The information contained in this document is reviewed
regularly and any necessary changes will be included in
the next edition. We welcome suggestions for
improvement.

Siemens handbooks are printed on chlorine-free paper
that has been produced from managed sustainable
forests. No solvents have been used in the printing or
binding process.

Document subject to change without prior notice.

Order Number: 6SE6400-5AA00-0BP0

Siemens-Aktiengesellschaft

Foreword

User Documentation



WARNING

Before installing and commissioning, you must read the safety instructions and warnings carefully and all the warning labels attached to the equipment. Make sure that the warning labels are kept in a legible condition and replace missing or damaged labels.

Information is also available from:

Technical Support Nuremberg

Tel: +49 (0) 180 5050 222

Fax: +49 (0) 180 5050 223

Email: techsupport@ad.siemens.de

Monday to Friday: 7:00 am to 5:00 pm (local time)

Internet Home Address

Customers can access technical and general information at:

<http://www.siemens.de/micromaster>

Contact address

Should any questions or problems arise while reading this manual, please contact the Siemens office concerned using the form provided at the back this manual.

Definitions and Warnings



DANGER

indicates an imminently hazardous situation which, if not avoided, will result in death or serious injury.



WARNING

indicates a potentially hazardous situation which, if not avoided, could result in death or serious injury.



CAUTION

used with the safety alert symbol indicates a potentially hazardous situation which, if not avoided, may result in minor or moderate injury.

CAUTION

used without safety alert symbol indicates a potentially hazardous situation which, if not avoided, may result in a property damage.

NOTICE

indicates a potential situation which, if not avoided, may result in an undesirable result or state.

NOTES

For the purpose of this documentation, "Note" indicates important information relating to the product or highlights part of the documentation for special attention.

Qualified personnel

For the purpose of this Instruction Manual and product labels, a "Qualified person" is someone who is familiar with the installation, mounting, start-up and operation of the equipment and the hazards involved. He or she must have the following qualifications:

1. Trained and authorized to energize, de-energize, clear, ground and tag circuits and equipment in accordance with established safety procedures.
2. Trained in the proper care and use of protective equipment in accordance with established safety procedures.
3. Trained in rendering first aid.

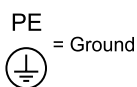

◆ PE – Protective Earth uses circuit protective conductors sized for short circuits where the voltage will not rise in excess of 50 Volts. This connection is normally used to ground the inverter.

◆ - Is the ground connection where the reference voltage can be the same as the Earth voltage. This connection is normally used to ground the motor.

Use for intended purpose only

The equipment may be used only for the application stated in the manual and only in conjunction with devices and components recommended and authorized by Siemens.

Safety Instructions

The following Warnings, Cautions and Notes are provided for your safety and as a means of preventing damage to the product or components in the machines connected. This section lists Warnings, Cautions and Notes, which apply generally when handling MICROMASTER 420 Inverters, classified as **General, Transport & Storage, Commissioning, Operation, Repair and Dismantling & Disposal**.

Specific Warnings, Cautions and Notes that apply to particular activities are listed at the beginning of the relevant chapters and are repeated or supplemented at critical points throughout these chapters.

Please read the information carefully, since it is provided for your personal safety and will also help prolong the service life of your MICROMASTER 420 Inverter and the equipment you connect to it.

General



WARNING

- ◆ This equipment contains dangerous voltages and controls potentially dangerous rotating mechanical parts. Non-compliance with **Warnings** or failure to follow the instructions contained in this manual can result in loss of life, severe personal injury or serious damage to property.
 - ◆ Only suitable qualified personnel should work on this equipment, and only after becoming familiar with all safety notices, installation, operation and maintenance procedures contained in this manual. The successful and safe operation of this equipment is dependent upon its proper handling, installation, operation and maintenance.
 - ◆ Risk of electric shock. The DC link capacitors remain charged for five minutes after power has been removed. **It is not permissible to open the equipment until 5 minutes after the power has been removed.**
 - ◆ **HP ratings are based on the Siemens 1LA motors and are given for guidance only, they do not necessarily comply with UL or NEMA HP ratings.**
-



CAUTION

- ◆ Children and the general public must be prevented from accessing or approaching the equipment!
 - ◆ This equipment may only be used for the purpose specified by the manufacturer. Unauthorized modifications and the use of spare parts and accessories that are not sold or recommended by the manufacturer of the equipment can cause fires, electric shocks and injuries.
-

NOTICE

- ◆ Keep these operating instructions within easy reach of the equipment and make them available to all users
 - ◆ Whenever measuring or testing has to be performed on live equipment, the regulations of Safety Code VBG 4.0 must be observed, in particular § 8 "Permissible Deviations when Working on Live Parts". Suitable electronic tools should be used.
 - ◆ Before installing and commissioning, please read these safety instructions and warnings carefully and all the warning labels attached to the equipment. Make sure that the warning labels are kept in a legible condition and replace missing or damaged labels.
-

Transport & Storage**WARNING**

- ◆ Correct transport, storage, erection and mounting, as well as careful operation and maintenance are essential for proper and safe operation of the equipment.
-

CAUTION

- ◆ Protect the inverter against physical shocks and vibration during transport and storage. Also be sure to protect it against water (rainfall) and excessive temperatures (*see table on page 76*).
-

Commissioning**WARNING**

- ◆ Work on the device/system by **unqualified** personnel or failure to comply with warnings can result in severe personal injury or serious damage to material. Only suitably qualified personnel trained in the setup, installation, commissioning and operation of the product should carry out work on the device/system.
 - ◆ Only permanently-wired input power connections are allowed. This equipment must be grounded (IEC 536 Class 1, NEC and other applicable standards).
 - ◆ If a Residual Current-operated protective Device (RCD) is to be used, it must be an RCD type B. Machines with a three phase power supply, fitted with EMC filters, must not be connected to a supply via an ELCB (Earth Leakage Circuit-Breaker - *see DIN VDE 0160, section 5.5.2 and EN50178 section 5.2.11.1*).
 - ◆ The following terminals can carry dangerous voltages even if the inverter is inoperative:
 - the power supply terminals L/L1, N/L2, L3.
 - the motor terminals U, V, W, DC+, DC-
 - ◆ This equipment must not be used as an 'emergency stop mechanism' (*see EN 60204, 9.2.5.4*)
-

CAUTION

The connection of power, motor and control cables to the inverter must be carried out as shown in Figure 2-7 Seite 29, to prevent inductive and capacitive interference from affecting the correct functioning of the inverter.

Operation



WARNING

- ◆ Motor parameters must be accurately configured for the motor overload protection to operate correctly.
 - ◆ MICROMASTERS operate at high voltages.
 - ◆ When operating electrical devices, it is impossible to avoid applying hazardous voltages to certain parts of the equipment.
 - ◆ Emergency Stop facilities according to EN 60204 IEC 204 (VDE 0113) must remain operative in all operating modes of the control equipment. Any disengagement of the Emergency Stop facility must not lead to uncontrolled or undefined restart.
 - ◆ Wherever faults occurring in the control equipment can lead to substantial material damage or even grievous bodily injury (i.e. potentially dangerous faults), additional external precautions must be taken or facilities provided to ensure or enforce safe operation, even when a fault occurs (e.g. independent limit switches, mechanical interlocks, etc.).
 - ◆ Certain parameter settings may cause the inverter to restart automatically after an input power failure.
 - ◆ This equipment is capable of providing internal motor overload protection in accordance with UL508C section 42. Refer to P0610 and P0335, i²t is ON by default. Motor overload protection can also be provided using an external PTC via a digital input.
 - ◆ This equipment is suitable for use in a circuit capable of delivering not more than 10,000 symmetrical amperes (rms), for a maximum voltage of 230 V / 460 V when protected by a time delay fuse (see *Tables starting on page 77*).
 - ◆ This equipment must not be used as an 'emergency stop mechanism' (see *EN 60204, 9.2.5.4*)
-

Repair



WARNING

- ◆ Repairs on equipment may only be carried out by **Siemens Service**, by repair centers **authorized by Siemens** or by qualified personnel who are thoroughly acquainted with all the warnings and operating procedures contained in this manual.
 - ◆ Any defective parts or components must be replaced using parts contained in the relevant spare parts list.
 - ◆ Disconnect the power supply before opening the equipment for access
-

Dismantling & Disposal

NOTES

- ◆ The inverter's packaging is re-usable. Retain the packaging for future use or return it to the manufacturer.
 - ◆ Easy-to-release screw and snap connectors allow you to break the unit down into its component parts. You can then re-cycle these component parts, dispose of them in **accordance with local requirements or return them to the manufacturer.**
-

Table of Contents

1	Overview	15
1.1	The MICROMASTER 420	16
1.2	Features	17
2	Installation	19
2.1	General.....	21
2.2	Ambient operating conditions.....	21
2.3	Mechanical installation	23
2.4	Electrical installation.....	25
3	Commissioning	31
3.1	Block diagram.....	33
3.2	Commission modes.....	34
3.3	General operation.....	44
4	Using the MICROMASTER 420.....	47
4.1	Frequency setpoint (P1000).....	48
4.2	Command sources (P0700)	49
4.3	OFF and braking functions	49
4.4	Control modes (P1300)	51
4.5	Faults and warnings	52
5	System parameters	53
5.1	Introduction to MICROMASTER system parameters.....	54
5.2	Parameter overview	55
5.3	Parameter list (short form)	56
6	Troubleshooting	67
6.1	Troubleshooting with the SDP.....	68
6.2	Troubleshooting with the BOP	69
6.3	MICROMASTER 420 fault messages.....	70
6.4	MICROMASTER 420 alarm messages.....	72
7	MICROMASTER 420 specifications	75
8	Options	83
8.1	Device-independent options.....	83
8.2	Device-dependent options	83
9	Electro-magnetic compatibility (EMC)	85

9.1	Electro-magnetic compatibility (EMC).....	86
Appendices.....		91
A	Changing the Operator Panel	91
B	Removing Covers Frame Size A	92
C	Removing Covers Frame Size B and C	93
D	Removing 'Y' Cap Frame Size A	94
E	Removing 'Y' Cap Frame Size B and C	95
F	Applicable Standards.....	96
G	List of Abbreviations.....	97
Index	98

List of Illustrations

Figure 2-1	Forming.....	21
Figure 2-2	Ambient operating temperature	21
Figure 2-3	Installation altitude	22
Figure 2-4	Drill pattern for MICROMASTER 420.....	23
Figure 2-5	MICROMASTER 420 connection terminals	26
Figure 2-6	Motor and Power Connections.....	27
Figure 2-7	Wiring Guidelines to Minimize the Effects of EMI	29
Figure 3-1	Inverter block diagram	33
Figure 3-2	Panels available for the MICROMASTER 420 Inverter.....	34
Figure 3-3	DIP switch.....	34
Figure 3-4	Basic operation with SDP	36
Figure 3-5	Buttons on the BOP	39
Figure 3-6	Changing parameters via the BOP	40
Figure 3-7	Typical Motor Rating Plate Example.....	43
Figure 3-8	Motor Overload PTC Connection.....	45
Figure 5-1	Parameter Overview	55

List of Tables

Table 2-1	Dimensions and Torques of MICROMASTER 420	23
Table 3-1	Default settings for operation using the SDP	35
Table 3-2	Default settings for operation using the BOP	38
Table 6-1	Inverter conditions indicated by the LEDs on the SDP	68
Table 7-1	MICROMASTER Performance Ratings	76
Table 7-2	Tightening torques for power terminals.....	76
Table 7-3	MICROMASTER 420 Specifications.....	77
Table 9-1	Permissible harmonic current emissions	87
Table 9-2	Class 1 - General Industrial	88
Table 9-3	Class 2 - Filtered Industrial	88
Table 9-4	Class 3 - Filtered for Residential, Commercial and Light Industry	89
Table 9-5	Compliance Table.....	90

1 Overview

This Chapter contains:

A summary of the major features of the MICROMASTER 420 range.

1.1	The MICROMASTER 420	16
1.2	Features	17

1.1 The MICROMASTER 420

The MICROMASTER 420s are a range of frequency inverters for controlling the speed of three phase AC motors. The various models available range from the 120 W single phase input to the 11 kW three phase input.

The inverters are microprocessor-controlled and use state-of-the-art Insulated Gate Bipolar Transistor (IGBT) technology. This makes them reliable and versatile. A special pulse-width modulation method with selectable Pulse frequency permits quiet motor operation. Comprehensive protective functions provide excellent inverter and motor protection.

The MICROMASTER 420 with its default factory settings, is ideal for a large range of simple motor control applications. The MICROMASTER 420 can also be used for more advanced motor control applications via its comprehensive parameter lists.

The MICROMASTER 420 can be used in both 'stand-alone' applications as well as being integrated into 'Automation Systems'.

1.2 Features

Main characteristics

- Easy installation
- Easy commissioning
- Rugged EMC design
- Can be operated on IT line supplies
- Fast repeatable response time to control signals
- Comprehensive range of parameters enabling configuration for widest range of applications
- Simple cable connection
- Modular design for extremely flexible configuration
- High switching frequencies for low-noise motor operation
- Detailed status information and integrated message functions
- External options for PC communications, Basic Operator Panel (BOP), Advanced Operator Panel (AOP) and Profibus Communications Module

Performance characteristics

- Flux Current Control (FCC) for improved dynamic response and motor control
- Fast Current Limitation (FCL) for operation with trip-free mechanism
- Built-in DC brake
- Compound Braking to improve braking performance
- Acceleration/deceleration times with programmable smoothing
- Closed-loop control using Proportional, Integral (PI) control loop function
- Multi-point V/f characteristic

Protection characteristics

- Overvoltage/undervoltage protection
- Overtemperature protection for the inverter
- Ground fault protection
- Short-circuit protection
- i^2t thermal motor protection
- PTC for motor protection

2 Installation

This Chapter contains:

- General data relating to installation
- Dimensions of Inverter
- Wiring guidelines to minimize the effects of EMI
- Details concerning electrical installation

2.1	General.....	20
2.2	Ambient operating conditions.....	21
2.3	Mechanical installation.....	22
2.4	Electrical installation.....	25



WARNING

- ◆ Work on the device/system by **unqualified** personnel or failure to comply with warnings can result in severe personal injury or serious damage to material. Only suitably qualified personnel trained in the setup, installation, commissioning and operation of the product should carry out work on the device/system.
 - ◆ Only permanently-wired input power connections are allowed. This equipment must be grounded (IEC 536 Class 1, NEC and other applicable standards).
 - ◆ If a Residual Current-operated protective Device (RCD) is to be used, it must be an RCD type B. Machines with a three-phase power supply, fitted with EMC filters, must not be connected to a supply via an ELCB (Earth Leakage Circuit-Breaker EN50178 Section 5.2.11.1).
 - ◆ The following terminals can carry dangerous voltages even if the inverter is inoperative:
 - the power supply terminals L/L1, N/L2, L3.
 - the motor terminals U, V, W, DC+, DC-
 - ◆ Always wait **5 minutes** to allow the unit to discharge after switching off before carrying out any installation work.
 - ◆ This equipment must not be used as an 'emergency stop mechanism' (see *EN 60204, 9.2.5.4*)
 - ◆ The minimum size of the earth bonding conductor must be equal to or greater than the cross-section of the power supply cables.
-

CAUTION

The connection of power, motor and control cables to the inverter must be carried out as shown in Figure 2-7 on page 29, to prevent inductive and capacitive interference from affecting the correct functioning of the inverter.

2.1 General

Installation after a Period of Storage

Following a prolonged period of storage, you must reform the capacitors in the inverter. The requirements are listed below.

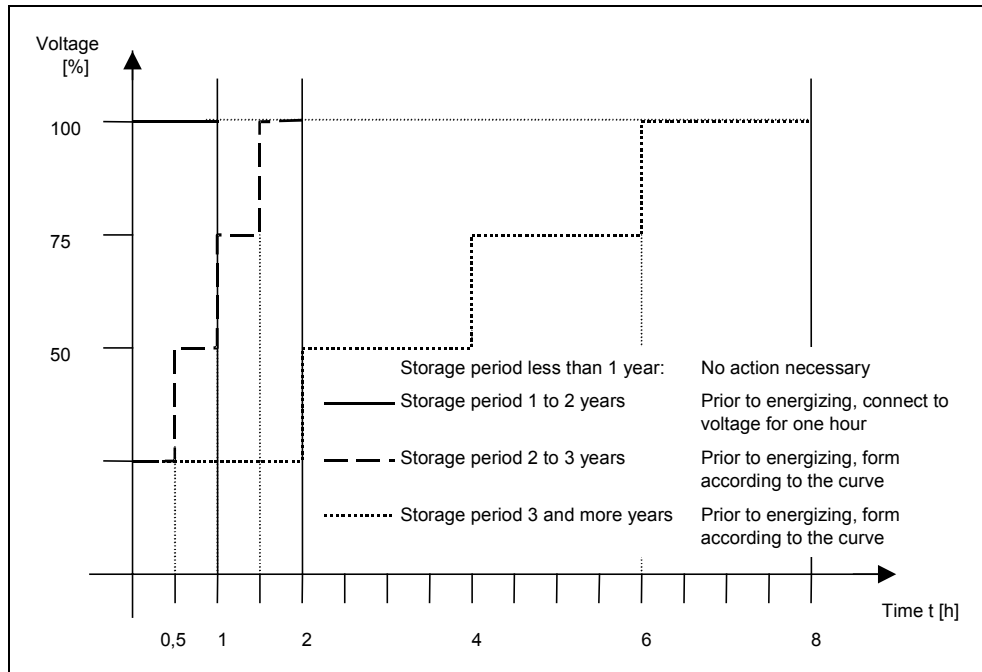

Figure 2-1 Forming

2.2 Ambient operating conditions

Temperature

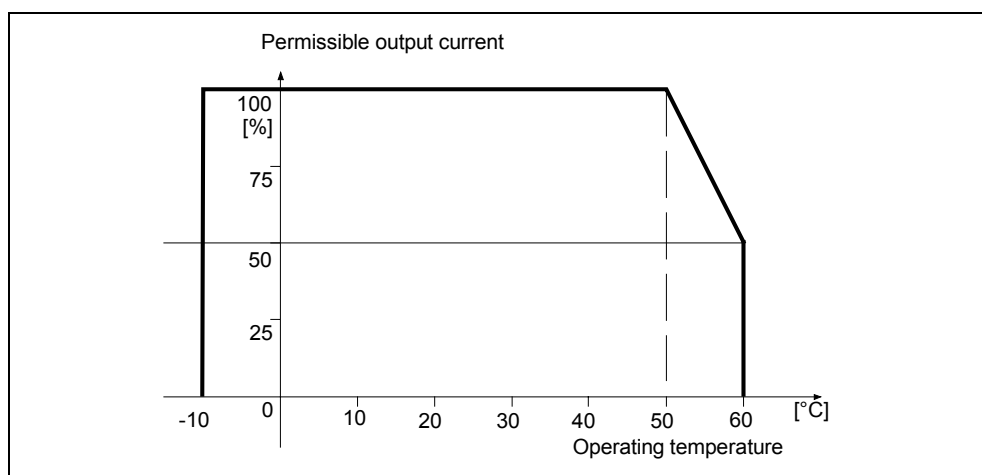

Figure 2-2 Ambient operating temperature

Humidity

Relative air humidity \leq 95% Non-condensing

Altitude

If the inverter is to be installed at an altitude $>$ 1000 m or $>$ 2000 m above sea level, derating will be required:

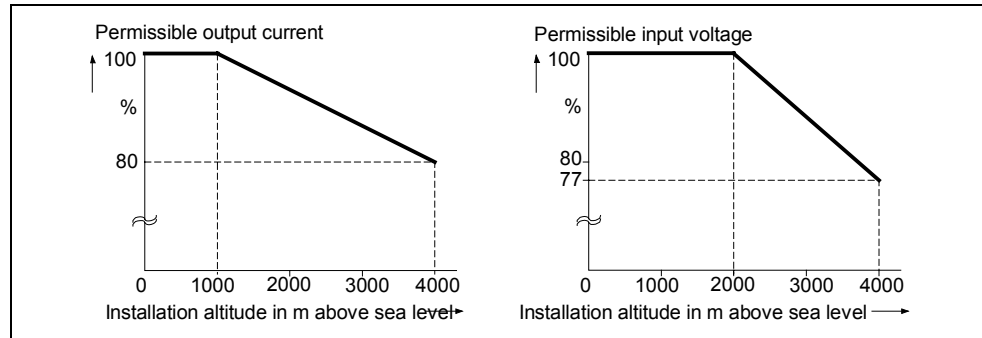

Figure 2-3 Installation altitude

Shock and Vibration

Do not drop the inverter or expose to sudden shock.. Do not install the inverter in an area where it is likely to be exposed to constant vibration.

Mechanical strength to DIN IEC 68-2-6

- Deflection: 0.075 mm (10 ... 58 Hz)
- Acceleration: 9.8 m/s² ($>$ 58 ... 500 Hz)

Electromagnetic Radiation

Do not install the inverter near sources of electromagnetic radiation.

Atmospheric Pollution

Do not install the inverter in an environment, which contains atmospheric pollutants such as dust, corrosive gases, etc.

Water

Take care to site the inverter away from potential water hazards, e.g. do not install the inverter beneath pipes that are subject to condensation. Avoid installing the inverter where excessive humidity and condensation may occur.

Installation and cooling

CAUTION

The inverters **MUST NOT** be mounted horizontally.

The inverters can be mounted without any clearance at either side.

Allow 100 mm clearance above and below the inverter. Make sure that the cooling vents in the inverter are positioned correctly to allow free movement of air.

2.3 Mechanical installation



WARNING

- ◆ To ensure the safe operation of the equipment, it must be installed and commissioned by qualified personnel in full compliance with the warnings laid down in these operating instructions.
- ◆ Take particular note of the general and regional installation and safety regulations regarding work on dangerous voltage installations (e.g. EN 50178), as well as the relevant regulations regarding the correct use of tools and personal protective gear.
- ◆ The mains input, DC and motor terminals, can carry dangerous voltages even if the inverter is inoperative; wait **5 minutes** to allow the unit to discharge after switching off before carrying out any installation work.
- ◆ The inverters can be mounted adjacent to each other. If they are mounted on top of each other, however, a clearance of 100 mm has to be observed.

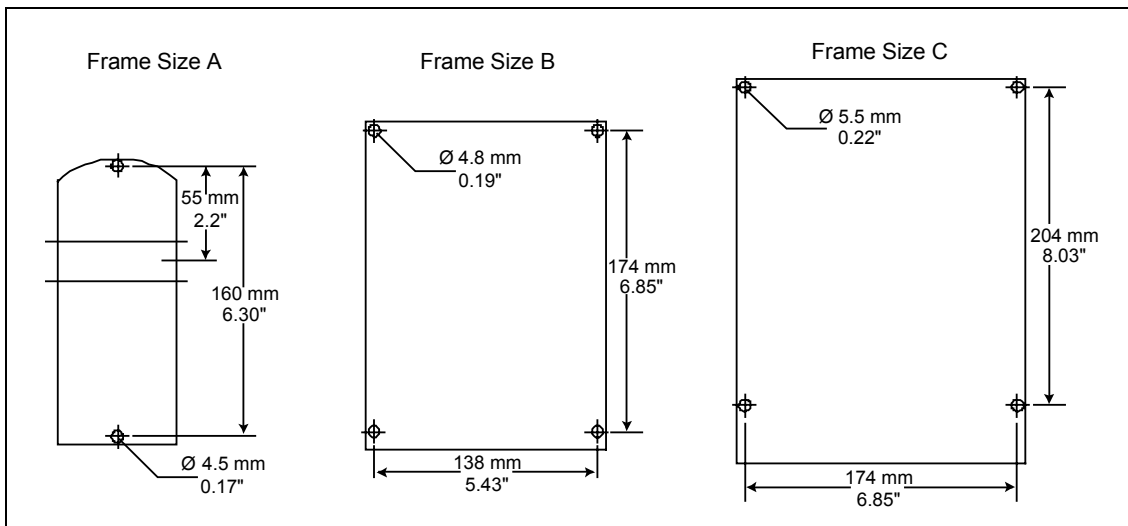

Figure 2-4 Drill pattern for MICROMASTER 420

Table 2-1 Dimensions and Torques of MICROMASTER 420

Frame-Size		Overall Dimensions		Fixing Method	Tightening Torque
A	Width x Height x Depth	mm	73 x 173 x 149	2 x M4 Bolts 2 x M4 Nuts 2 x M4 Washers for mounting on standard rail	2.5 Nm with washers fitted
		inch	2.87 x 6.81 x 5.87		
B	Width x Height x Depth	mm	149 x 202 x 172	4 x M4 Bolts 4 x M4 Nuts 4 x M4 Washers	2.5 Nm with washers fitted
		inch	5.87 x 7.95 x 6.77		
C	Width x Height x Depth	mm	185 x 245 x 195	4 x M5 Bolts 4 x M5 Nuts 4 x M5 Washers	2.5 Nm with washers fitted
		inch	7.28 x 9.65 x 7.68		

2.3.1 Mounting on standard rail, Frame Size A

Fitting the Inverter to a 35 mm standard rail (EN 50022)

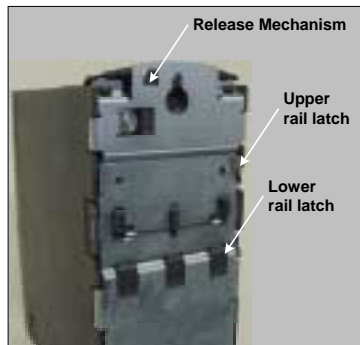

1. Fit the inverter to the rail using the upper rail latch.



2. Push the inverter against the rail and the lower rail latch should click into place.

Removing the Inverter from the rail



1. To disengage the release mechanism of the inverter, insert a screwdriver into the release mechanism.
2. Apply a downward pressure and the lower rail latch will disengage.
3. Pull the inverter from the rail.

2.4 Electrical installation



WARNING

The inverter must always be grounded.

- ◆ To ensure the safe operation of the equipment, it must be installed and commissioned by qualified personnel in full compliance with the warnings laid down in these operating instructions.
- ◆ Take particular note of the general and regional installation and safety regulations regarding work on dangerous voltage installations (e.g. EN 50178), as well as the relevant regulations regarding the correct use of tools and personal protective gear.
- ◆ Never use high voltage insulation test equipment on cables connected to the inverter.
- ◆ The mains input, DC and motor terminals, can carry dangerous voltages even if the inverter is inoperative; wait **5 minutes** to allow the unit to discharge after switching off before carrying out any installation work.

CAUTION

The control, power supply and motor leads **must** be laid separately. Do not feed them through the same cable conduit/trunking.

2.4.1 General



WARNING

The inverter must always be grounded. If the inverter is not grounded correctly, extremely dangerous conditions may arise within the inverter which could prove potentially fatal.

Operation with ungrounded (IT) supplies

The MICROMASTER will operate from ungrounded supplies and will continue to operate if an input phase is shorted to ground. If an output phase is shorted to ground, the MICROMASTER will trip and indicate F0001.

On ungrounded supplies, it will be necessary to remove the 'Y' capacitor from the inside of the unit and fit an output choke. The procedure for removing this capacitor is described in Appendices 0 and 0.

Operation with Residual Current Device

If an RCD (also referred to as ELCB or RCCB) is fitted, the MICROMASTER inverters will operate without nuisance tripping, provided that:

- A type B RCD is used.
- The trip limit of the RCD is 300mA.
- The neutral of the supply is grounded.
- Only one inverter is supplied from each RCD.
- The output cables are less than 50m (screened) or 100m (unscreened).

Operation with long cables

All inverters will operate at full specification with cable lengths up to 50 m screened or 100 m unscreened.

2.4.2 Power and motor connections



WARNING

The inverter must always be grounded.

- ◆ Isolate the mains electrical supply before making or changing connections to the unit.
- ◆ Ensure that the motor is configured for the correct supply voltage: single / three-phase 230 V MICROMASTERS must not be connected to a 400 V three-phase supply.
- ◆ When synchronous motors are connected or when coupling several motors in parallel, the inverter must be operated with voltage/frequency control characteristic (P1300 = 0, 2 or 3).



CAUTION

After connecting the power and motor cables to the proper terminals, make sure that the covers have been replaced properly before supplying power to the unit!

NOTICE

- ◆ Ensure that the appropriate circuit-breakers/fuses with the specified current rating are connected between the power supply and inverter (see *chapter 7, Tables starting on page 77*).
- ◆ Use Class 1 60/75°C copper wire only (for UL compliance). For tightening torque see Table 7-2, page 76.

Access to the power and motor terminals

You can gain access to the mains and motor terminals by removing the covers (see also Appendices 0, B und 0).

The mains and motor connections must be made as shown in Figure 2-6.



Figure 2-5 MICROMASTER 420 connection terminals

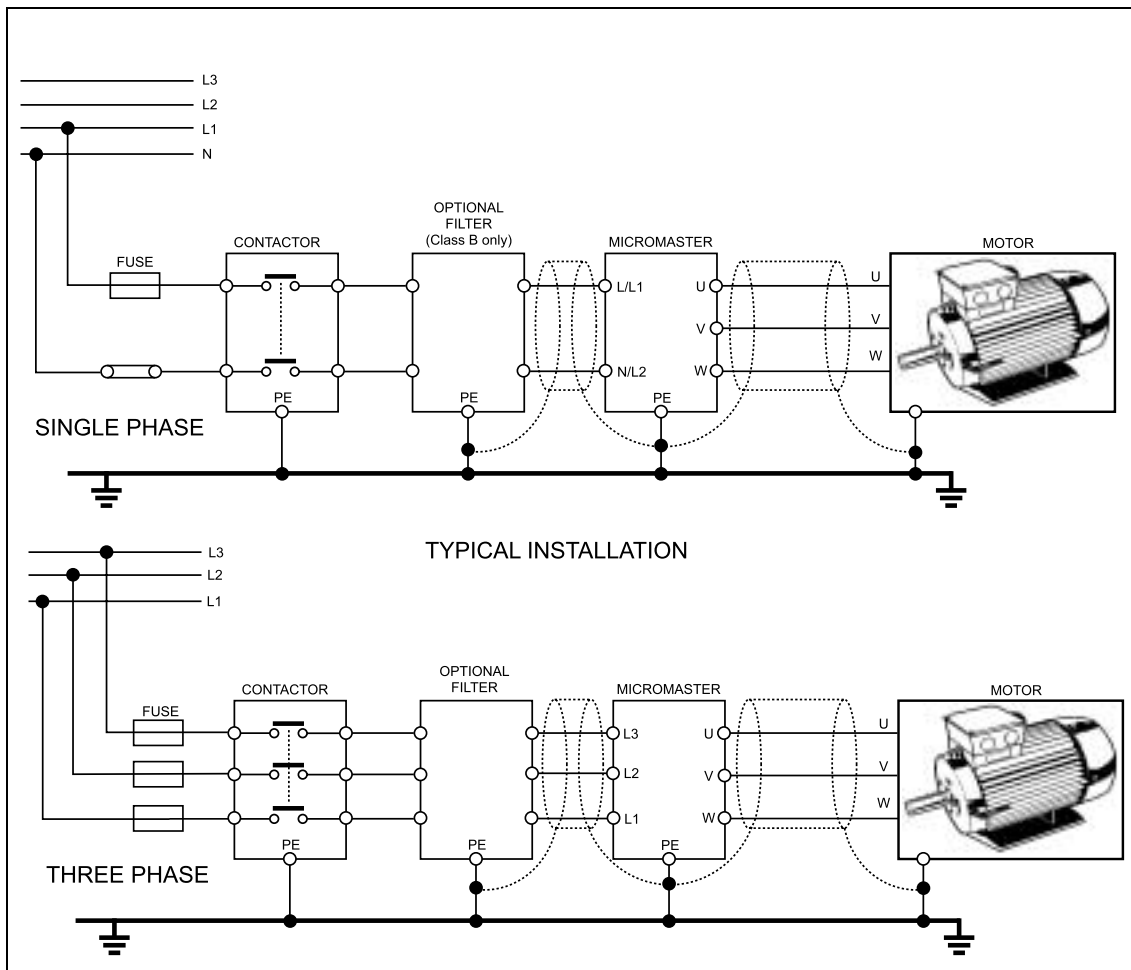

Figure 2-6 Motor and Power Connections

2.4.3 Avoiding Electro-Magnetic Interference (EMI)

The inverters are designed to operate in an industrial environment where a high level of EMI can be expected. Usually, good installation practices will ensure safe and trouble-free operation. If you encounter problems, follow the guidelines stated below.

Action to Take

- Ensure that all equipment in the cubicle is well grounded using short, thick grounding cable connected to a common star point or busbar
- Make sure that any control equipment (such as a PLC) connected to the inverter is connected to the same ground or star point as the inverter via a short thick link.
- Connect the return ground from the motors controlled by the inverters directly to the ground connection (PE) on the associated inverter
- Flat conductors are preferred as they have lower impedance at higher frequencies
- Terminate the ends of the cable neatly, ensuring that unscreened wires are as short as possible
- **Separate the control cables from the power cables as much as possible, using separate trunking, if necessary at 90° to each other.**
- Whenever possible, use screened leads for the connections to the control circuitry
- Ensure that the contactors in the cubicle are suppressed, either with R-C suppressors for AC contactors or 'flywheel' diodes for DC contactors fitted to the coils. Varistor suppressors are also effective. This is important when the contactors are controlled from the inverter relay
- Use screened or armored cables for the motor connections and ground the screen at both ends using the cable clamps



WARNING

Safety regulations **must not** be compromised when installing inverters!

2.4.4 Screening Methods

Gland Plate

The Gland Plate Kit is supplied as an option. It allows easy and efficient connection of the necessary screening. See the Gland Plate Installation Instructions contained on the Docu-CD.

Screening without a Gland Plate

Should a Gland Plate not be available, then the inverter can be screened using the methodology shown in Figure 2-7.

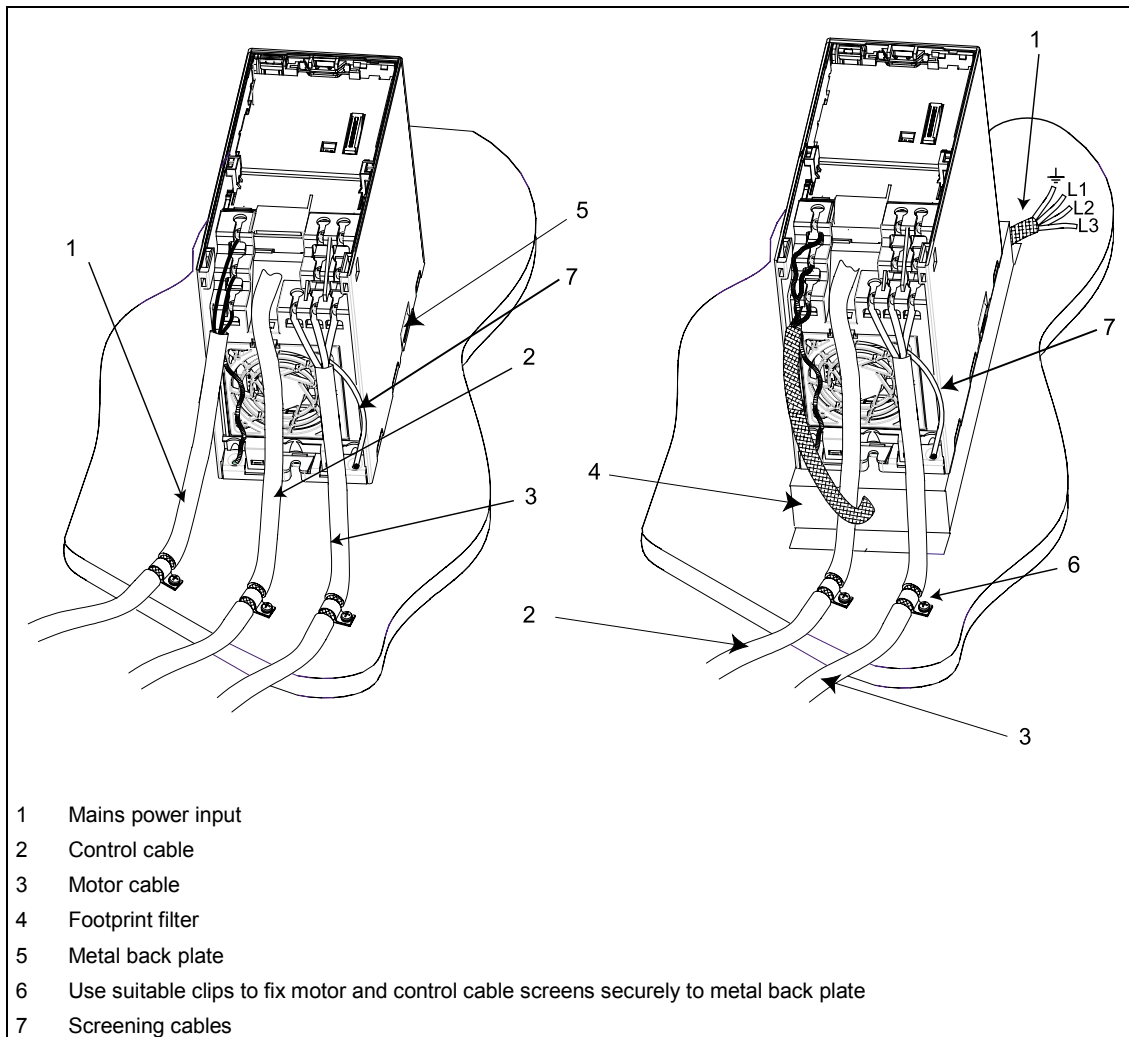

Figure 2-7 Wiring Guidelines to Minimize the Effects of EMI

3 Commissioning

This Chapter contains:

- A schematic diagram of the MICROMASTER 420
- An overview of the commissioning options and the display and operator panels
- An overview of quick commissioning of the MICROMASTER 420

3.1	Block diagram.....	33
3.2	Commission modes.....	34
3.3	General operation.....	44



WARNING

- ◆ MICROMASTERS operate at high voltages.
 - ◆ When operating electrical devices, it is impossible to avoid applying hazardous voltages to certain parts of the equipment.
 - ◆ Emergency Stop facilities according to EN 60204 IEC 204 (VDE 0113) must remain operative in all operating modes of the control equipment. Any disengagement of the Emergency Stop facility must not lead to uncontrolled or undefined restart.
 - ◆ Wherever faults occurring in the control equipment can lead to substantial material damage or even grievous bodily injury (i.e. potentially dangerous faults), additional external precautions must be taken or facilities provided to ensure or enforce safe operation, even when a fault occurs (e.g. independent limit switches, mechanical interlocks, etc.).
 - ◆ Certain parameter settings may cause the inverter to restart automatically after an input power failure.
 - ◆ Motor parameters must be accurately configured for motor overload protection to operate correctly.
 - ◆ This equipment is capable of providing internal motor overload protection in accordance with UL508C section 42. Refer to P0610 and P0335, i^2t is ON by default. Motor overload protection can also be provided using an external PTC via a digital input.
 - ◆ This equipment is suitable for use in a circuit capable of delivering not more than 10,000 symmetrical amperes (rms), for a maximum voltage of 230/460V when protected by a time delay fuse (see *Tables starting on page 77*).
 - ◆ This equipment must not be used as an 'emergency stop mechanism' (see *EN 60204, 9.2.5.4*)
-



CAUTION

Only qualified personnel may enter settings in the control panels. Particular attention must be paid to safety precautions and warnings at all times.

3.1 Block diagram

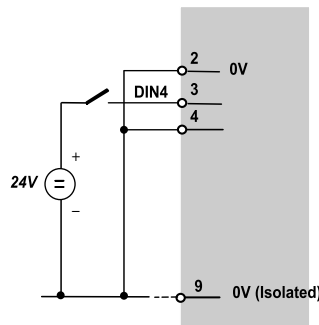
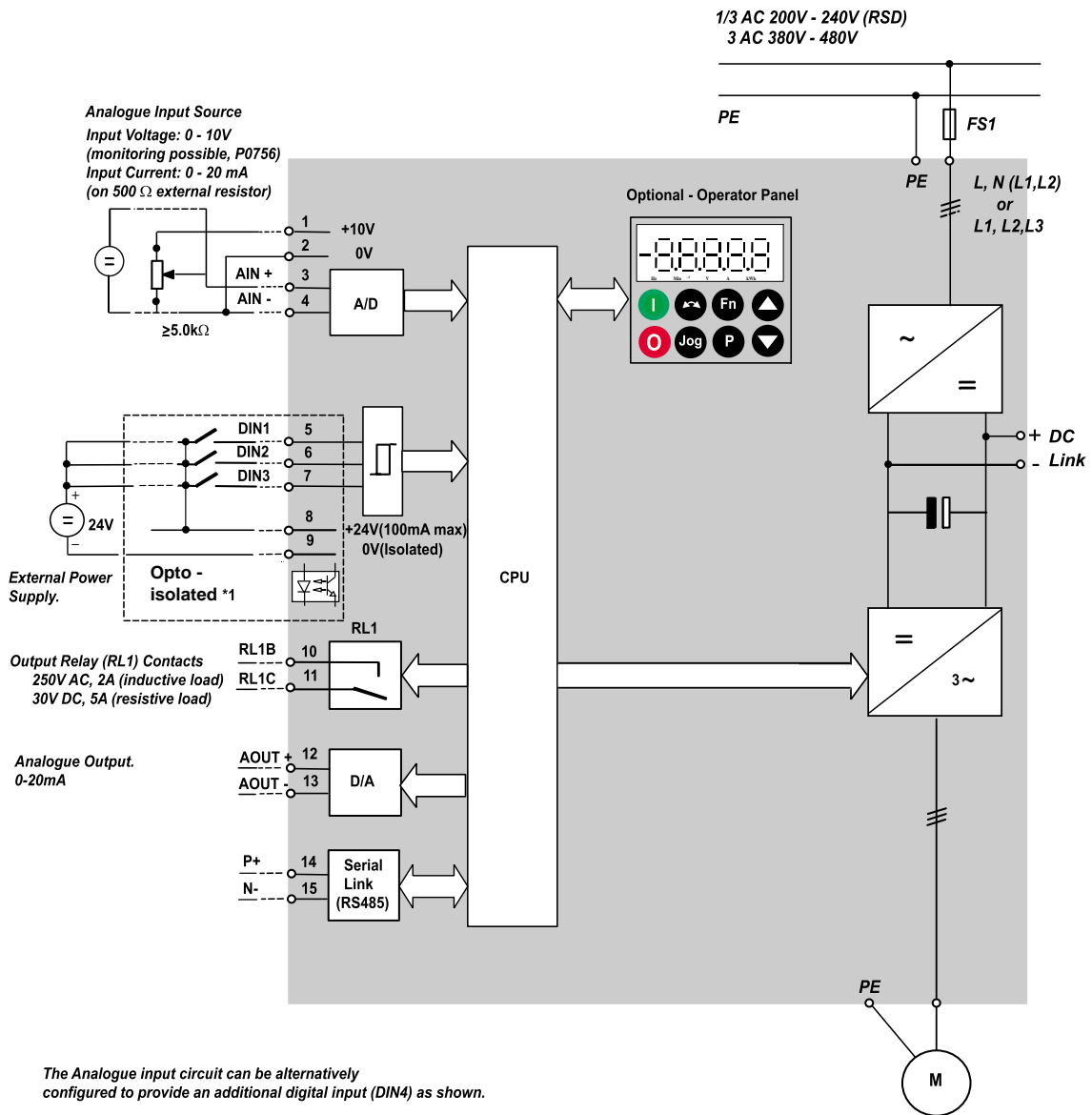

Figure 3-1 Inverter block diagram

3.2 Commission modes

In the standard version, the MICROMASTER 420 is fitted with the Status Display Panel (SDP) (see Figure 3-2) with which it is possible to use the inverter with the pre-assigned factory settings for a large range of applications. If these factory settings are not suitable, you can adapt them to suit your equipment conditions using the Basic Operator Panel (BOP) (see Figure 3-2) or the Advanced Operator Panel (AOP) (see Figure 3-2). The BOP and AOP are available as options. You can also adjust the factory settings using the PC IBN tool "Drive Monitor" or "STARTER". This software is available on the CD ROM which comes with the documentation of the unit.

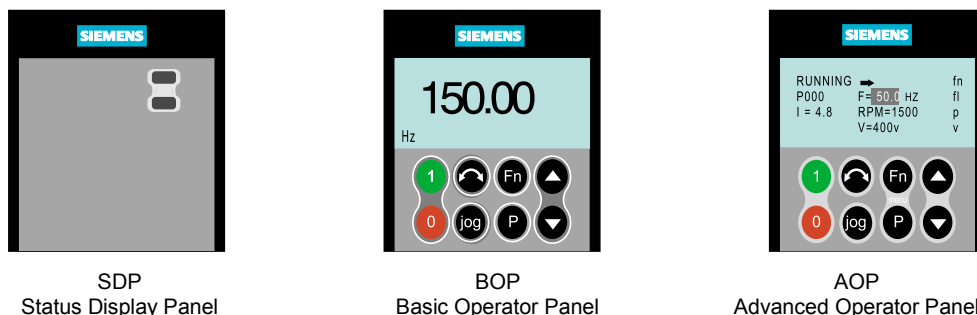

Figure 3-2 Panels available for the MICROMASTER 420 Inverter

For notes on replacing the operator panels please refer to the corresponding annexes 0 to this manual.

NOTICE

The default (factory value) frequency setting can be altered by means of the DIP switch under the SDP. The inverter is delivered as follows::

- DIP switch 2:
 - ◆ Off position: European defaults (50 Hz, kW usw.)
 - ◆ On position: North American defaults (60 Hz, hp usw.)
- DIP switch 1: Not for customer use.

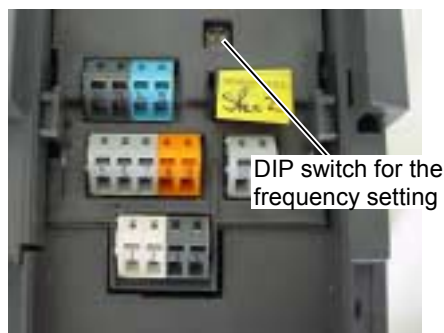
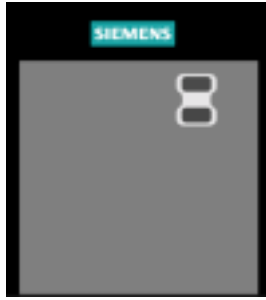

Figure 3-3 DIP switch

3.2.1 Commissioning and Operation with the SDP



The SDP has two LEDs on the front which display the current operating status of the inverter (see Section 6.1).

When the SDP is used, the presets of the inverter must be compatible with the following motor data:

- Rated motor power
- Motor voltage
- Rated motor current
- Rated motor frequency

(A conventional Siemens motor is recommended)

In addition, the following conditions must be met:

- Linear V/f motor speed controlled by an analog potentiometer.
- Maximum speed 3000 rpm at 50 Hz (3600 rpm at 60 Hz); can be controlled by a potentiometer via the analog inputs of the inverter.
- Ramp acceleration time/ramp deceleration time = 10 s

Settings for more complex applications can be found in the parameter list and in Section 3.2.2 "Commission Overview with BOP or AOP".

Table 3-1 Default settings for operation using the SDP

	Terminals	Parameter	Default Operating
Digital Input 1	5	P0701 = '1'	ON right
Digital Input 2	6	P0702 = '12'	Reverse
Digital Input 3	7	P0703 = '9'	Fault Reset
Output Relay	10/11	P0731 = '52.3'	Fault Identification
Analogue Output	12/13	P0771 = 21	Output Frequency
Analogue input	3/4	P0700 = 0	Frequency Setpoint
	1/2		Analog Input supply

Basic operation with SDP

With the **SDP** fitted, the following is possible:

- Start and stopping the motor
- Reversing the motor
- Fault Reset

Controlling the speed of the motor

Connect the terminals as shown in Figure 3-4.

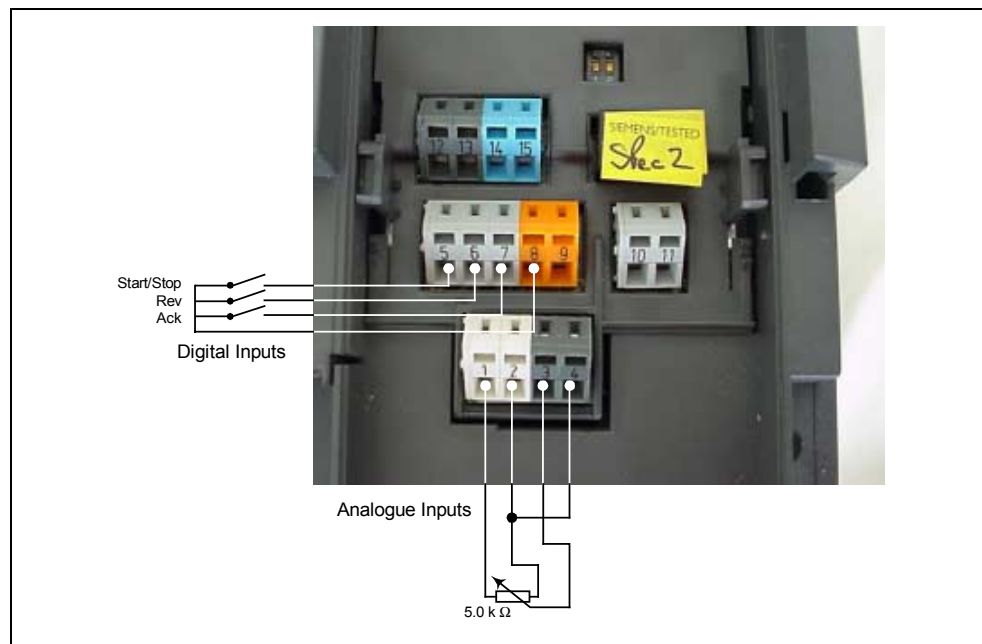
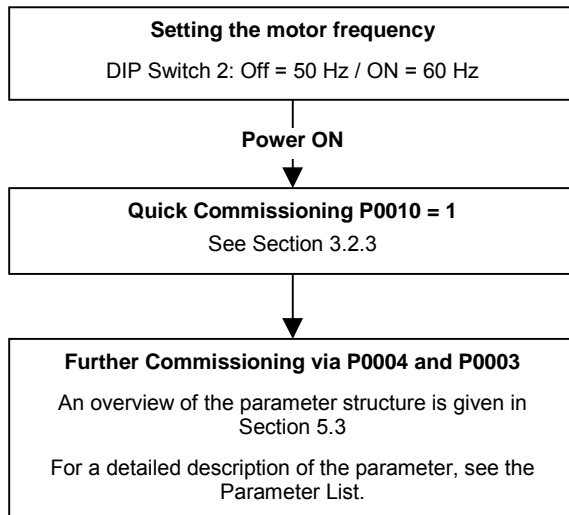

Figure 3-4 Basic operation with SDP

3.2.2 Commission Overview with BOP or AOP

Prerequisites

Mechanical and electrical Installation are completed.



NOTES

We recommend the commissioning according this scheme.

3.2.2.1 Commissioning with the BOP



You can alter parameter values via the BOP. To set parameters on this panel, you must remove the SDP and attach the BOP (see Appendix 0).

The BOP features a five-digit, seven-segment display for showing parameter numbers and values, alarm and fault messages and setpoints and actual values. Parameter information cannot be saved via the BOP.

Table 3-2 shows the factory default settings for operation via the BOP.

NOTICE

- ◆ The BOP motor control functions are disabled by default. To control the motor via the BOP, parameter P0700 should be set to 1 and P1000 set to 1.
- ◆ The BOP can be fitted to and removed from the inverter whilst power is applied.
- ◆ If the BOP has been set as the I/O control (P0700 = 1), the drive will stop if the BOP is removed.

Table 3-2 Default settings for operation using the BOP

Parameter	Meaning	Default Europe (North America)
P0100	Operating Mode Europe/US	50 Hz, kW (60Hz, hp)
P0307	Power (rated motor)	kW (Hp)
P0310	Motor frequency rating	50 Hz (60 Hz)
P0311	Motor speed rating	1395 (1680) rpm [depending on variant]
P1082	Maximum Motor Frequency	50 Hz (60 Hz)

Buttons on the BOP















Panel/Button	Function	Effects
	Indicates Status	The LCD displays the settings currently used by the converter.
	Start converter	Pressing the button starts the converter. This button is disabled by default. To enable this button set P0700 = 1.
	Stop converter	OFF1 Pressing the button causes the motor to come to a standstill at the selected ramp down rate. Disabled by default, to enable set P0700 = 1. OFF2 Pressing the button twice (or once long) causes the motor to coast to a standstill. This function is always enabled.
	Change direction	Press this button to change the direction of rotation of the motor. Reverse is indicated by a minus (-) sign or a flashing decimal point. Disabled by default, to enable set P0700 = 1.
	Jog motor	Pressing this button while the inverter has no output causes the motor to start and run at the preset jog frequency. The motor stops when the button is released. Pressing this button when the motor is running has no effect.
	Functions	This button can be used to view additional information. It works by pressing and holding the button. It shows the following, starting from any parameter during operation: 1. DC link voltage (indicated by d – units V). 2. output current. (A) 3. output frequency (Hz) 4. output voltage (indicated by o – units V). 5. The value selected in P0005 (If P0005 is set to show any of the above (3, 4, or 5) then this will not be shown again). Additional presses will toggle around the above displays. Jump Function From any parameter (rXXXX or PXXXX) a short press of the Fn button will immediately jump to r0000, you can then change another parameter, if required. Upon returning to r0000, pressing the Fn button will return you to your starting point.
	Access parameters	Pressing this button allows access to the parameters.
	Increase value	Pressing this button increases the displayed value. To change the Frequency Setpoint via the BOP set P1000 = 1.
	Decrease value	Pressing this button decreases the displayed value. To change the Frequency Setpoint via the BOP set P1000 = 1.

Figure 3-5 Buttons on the BOP

Changing parameters with the BOP

The procedure for changing the value of parameter P0004 is described below. Modifying the value of an indexed parameter is illustrated using the example of P0719. Follow exactly the same procedure to alter other parameters that you wish to set via the BOP.

Changing P0004 – parameter filter function

Step	Result on display
1 Press  to access parameters	r0000
2 Press  until P0004 is displayed	P0004
3 Press  to access the parameter value level	0
4 Press  or  to the required value	7
5 Press  to confirm and store the value	P0004
6 Only the command parameters are visible to the user.	

Changing P0719 an indexed parameter Selection of command/setpoint source









Step	Result on display
1 Press  to access parameters	r0000
2 Press  until P0719 is displayed	P0719
3 Press  to access the parameter value level	r0000
4 Press  to display current set value	0
5 Press  or  to the required value	12
6 Press  to confirm and store the value	P0719
7 Press  until r0000 is displayed	r0000
8 Press  to return the display to the standard drive display (as defined by the customer)	

Figure 3-6 Changing parameters via the BOP



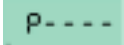

NOTES

In some cases - when changing parameter values - the display on the BOP shows . This means the inverter is busy with tasks of higher priority.

Changing single digits in Parameter values

For changing the parameter value rapidly, the single digits of the display can be changed by performing the following actions:

Ensure you are in the parameter value changing level (see "Changing parameters with BOP").

1. Press  (function button), which causes the right hand digit to blink.
2. Change the value of this digit by pressing  / 
3. Press  (function button) again causes the next digit to blink.
4. Perform steps 2 to 4 until the required value is displayed.
5. Press the  to leave the parameter value changing level.

NOTES

The function button may also be used to acknowledge a fault condition

3.2.2.2 Commissioning with the AOP

The AOP is available as an option. Its advanced features include the following:

- Multilingual clear text display
- Upload/download of multiple parameter sets
- Programmable via PC
- Multidrop capability to drive up to 30 MICROMASTER 4's

Please refer to the AOP Manual for details or contact your local Siemens sales office for assistance.

3.2.3 Commissioning functions with BOP / AOP**3.2.3.1 Quick commissioning (P0010=1)**

It is **important** that parameter P0010 is used for commissioning and P0003 is used to select the number of parameters to be accessed. This parameter allows a group of parameters to be selected that will enable quick commissioning. Parameters such as Motor settings and Ramp settings are included. At the end of the quick commissioning sequence, P3900 should be selected, which, when set to 1, will carry out the necessary motor calculations and clear all other parameters (not included in P0010=1) to the default settings. This will only happen in the Quick Commissioning mode.

Flow chart Quick Commissioning (Level 1 Only)

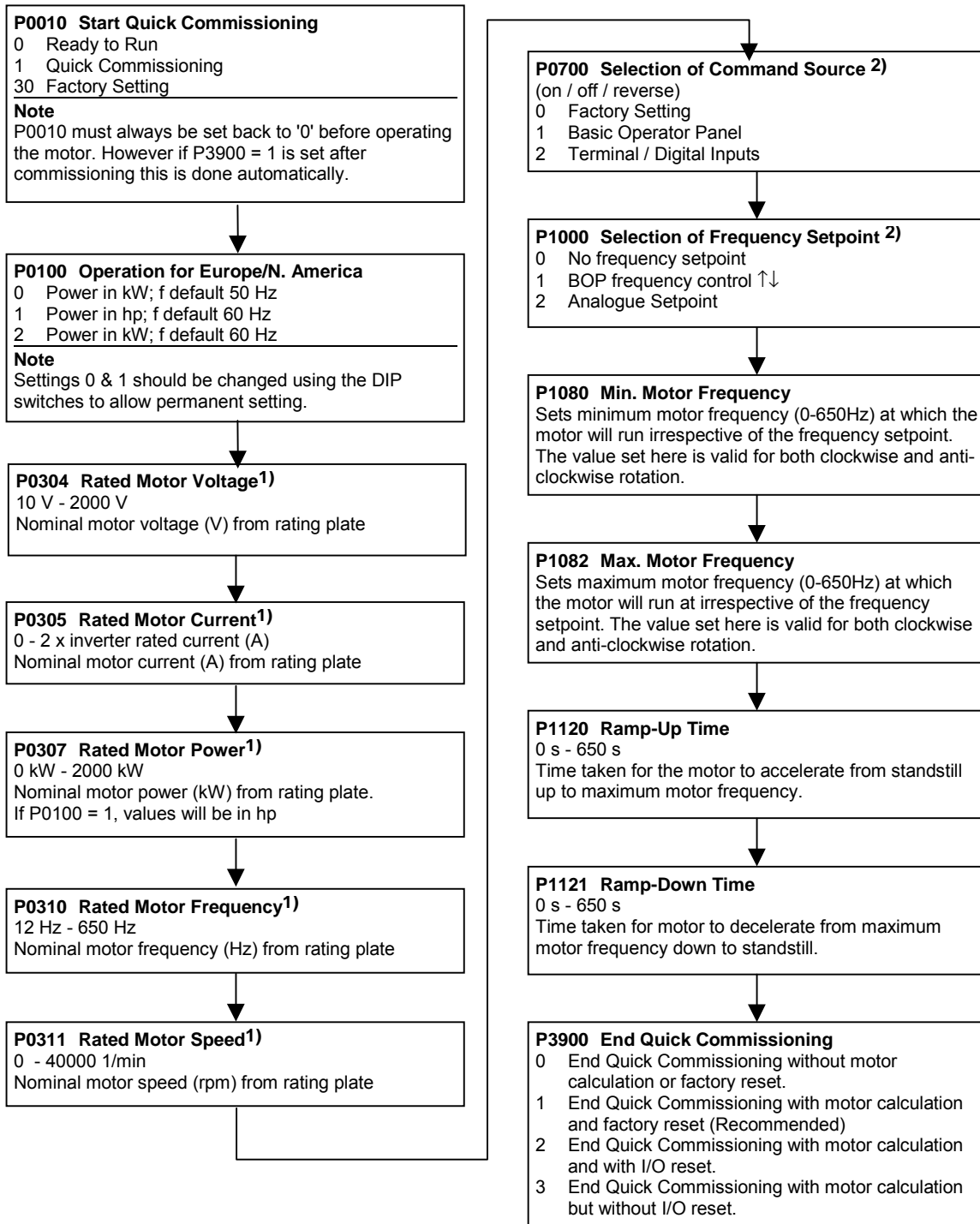

1) Motor-specific parameters – see motor rating plate.

2) The parameters offer more setting options than listed here. See Parameter List for further setting options.

Motor data for parameterization

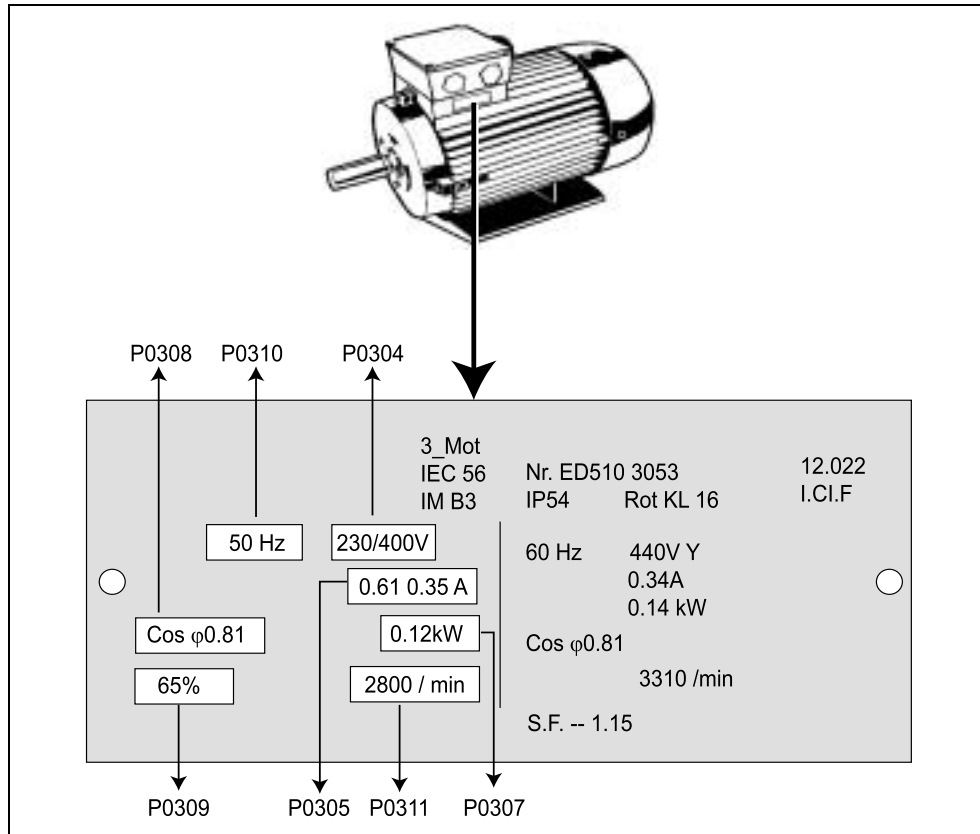

Figure 3-7 Typical Motor Rating Plate Example

NOTICE

- ◆ P0308 & P0309 are only visible if P0003 ≥ 2. Only one of the parameters are shown depending on the settings of P0100.
- ◆ P0307 indicates kW or HP depending upon the setting of P0100. For detailed information, please see the Parameter List.
- ◆ Changing motor parameters is not possible unless P0010=1.
- ◆ Ensure that the inverter is configured correctly to the motor, i.e. in the above example delta terminal connection is for 230 V.

3.2.3.2 Reset to Factory default

To reset all parameters to the factory default settings; the following parameters should be set as follows (BOP, AOP or Communication Option needed):

1. Set P0010 = 30
2. Set P0970 = 1

NOTE

The reset process can take up to 3 minutes to complete.

3.3 General operation

For a full description of standard and extended parameters, please refer to the Parameter List.

NOTICE

1. The inverter does not have a main power switch and is live when the mains supply is connected. It waits, with the output disabled, until the RUN button is pressed or for the presence of a digital ON signal at terminal 5 (rotate right).
2. If a BOP or an AOP is fitted and the output frequency is selected to be displayed (P0005 = 21) the corresponding setpoint is displayed approximately every 1.0 seconds while the inverter is stopped.
3. The inverter is programmed at the factory for standard applications on Siemens four-pole standard motors that have the same power rating as the inverters. When using other motors it is necessary to enter the specifications from the motor's rating plate. See Figure 3-7 for details on how to read motor data.
4. Changing motor parameters is not possible unless P0010 = 1.
5. You must set P0010 back to 0 in order to initiate a run.

Basic operation with the BOP/AOP

Prerequisites

P0010 = 0 (in order to initiate the run command correctly).

P0700 = 1 (enables the start/stop button on the BOP).

P1000 = 1 (this enables the motor potentiometer setpoints).

Press the green Button  to start the motor.

Press the Button  while the motor is turning. Motor speed increases to 50 Hz.

When the inverter reaches 50 Hz, press the Button . Motor speed and display is decreased.

Change the direction of rotation with the Button .

The red button stops the motor .

External motor thermal overload protection

When operated below rated speed, the cooling effect of fans fitted to the motor shaft is reduced. Consequentially, most motors require de-rating for continuous operation at low frequencies. To ensure that the motors are protected against overheating under these conditions, a PTC temperature sensor must be fitted to the motor and connected to the inverter control terminals. P0601 must also be set to 1.

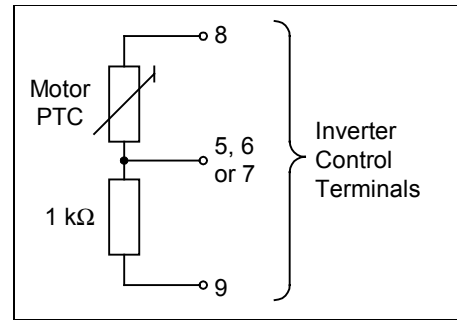

Figure 3-8 Motor Overload PTC Connection

NOTE

To enable the trip function, set parameter P0701, P0702 or P0703 = 29.

4 Using the MICROMASTER 420

This Chapter contains:

- An explanation of the various methods of controlling the inverter
- A summary of the types of control of the inverter

4.1	Frequency setpoint (P1000).....	48
4.2	Command sources (P0700).....	49
4.3	OFF and braking functions.....	49
4.4	Control modes (P1300).....	50
4.5	Faults and warnings.....	51

**WARNING**

- ◆ When operating electrical devices, it is impossible to avoid applying hazardous voltages to certain parts of the equipment.
- ◆ Emergency Stop facilities according to EN 60204 IEC 204 (VDE 0113) must remain operative in all operating modes of the control equipment. Any disengagement of the Emergency Stop facility must not lead to uncontrolled or undefined restart.
- ◆ Wherever faults occurring in the control equipment can lead to substantial material damage or even grievous bodily injury (i.e. potentially dangerous faults), additional external precautions must be taken or facilities provided to ensure or enforce safe operation, even when a fault occurs (e.g. independent limit switches, mechanical interlocks, etc.).
- ◆ MICROMASTERS operate at high voltages.
- ◆ Certain parameter settings may cause the inverter to restart automatically after an input power failure.
- ◆ Motor parameters must be accurately configured for motor overload protection to operate correctly.
- ◆ This equipment is capable of providing internal motor overload protection in accordance with UL508C section 42. Refer to P0610 and P0335, i^2t is ON by default. Motor overload protection can also be provided using an external PTC via a digital input.
- ◆ This equipment is suitable for use in a circuit capable of delivering not more than 10 000 symmetrical amperes (rms), for a maximum voltage of 230/460V when protected by a time delay fuse (see *Tables starting on page 77*).
- ◆ This equipment must not be used as an 'emergency stop mechanism' (see *EN 60204, 9.2.5.4*).

4.1 Frequency setpoint (P1000)

- Standard: Terminal 3/4 (AIN+/ AIN -, 0...10 V corresponds to 0...50/60 Hz)
- Options see P1000

NOTES

For USS see Reference Manual, for PROFIBUS see Reference Manual and Profibus Instructions.

4.2 Command sources (P0700)

NOTICE

The **ramp times** and **ramp-smoothing** functions also affect how the motor starts and stops. For details of these functions, please refer to parameters P1120, P1121, P1130 – P1134 in the Parameter List.

Starting the motor

- Standard Terminal 5 (DIN1, high)
- Options see P0700 to P0704

Stopping the motor

There are several ways to stop the motor:

- Standard:
 - ◆ OFF1 (4.3.1) Terminal 5 (DIN1, low)
 - ◆ OFF2 (4.3.2) Off button on BOP/AOP, pressing the Off button once long (two seconds) or twice (with default settings not possible without BOP/AOP)
 - ◆ OFF3 (4.3.3) Not active in the default (factory) setting
- Options see P0700 to P0704

Reversing the motor

- Standard Terminal 6 (DIN2, high)
- Options see P0700 to P0704

4.3 OFF and braking functions

4.3.1 OFF1

This command (produced by canceling the ON command) causes the inverter to come to a standstill at the selected ramp-down rate.

Parameter to change ramp time see P1121

NOTICE

- ON and the following OFF1 command must have the same source.
 - If the ON/OFF1 command is set to more than one Digital input, only the last set Digital Input is number e.g. DIN3 is active.
 - OFF1 can be combined with DC braking or Compound braking
-

4.3.2 OFF2

This command causes the motor to coast to a standstill.

NOTICE

The OFF2 command can have one or more sources. By default the OFF2 command is set to BOP/AOP. This source still exists even if other sources are defined by **one** of the following parameters, P0700, P0701, P0702, P0703 and P0704.

4.3.3 OFF3

An OFF3 command causes the motor to decelerate rapidly.

For starting the motor when OFF3 is set, the binary input has to be closed (high). If OFF3 is high, the motor can be started and stopped by OFF1 or OFF2.

If OFF3 is low the motor cannot be started.

➤ ramp down time: see P1135

NOTICE

OFF3 can be combined with DC braking or compound braking

4.3.4 DC braking

DC braking is possible together with OFF1 and OFF3. A DC current is applied to stop the motor quickly and hold the shaft stationary until the end of the braking period.

➤ set DC braking: see P0701 to P0704

➤ set braking period: see P1233

➤ set braking current: see P1232

NOTICE

If no digital input is set to DC braking and P1233 \neq 0, DC braking will be active after every OFF1 command.

4.3.5 Compound Braking

Compound Braking is possible with both OFF1 and OFF3. For Compound Braking a DC component is added to the AC current.

set the braking current: see P1236

4.4 Control modes (P1300)

All control modes of the MICROMASTER 420 are based on a V/Hz control. The following different control variants are provided to suit different types of application:

- **Linear V/f control, P1300 = 0**
Can be used for variable and constant torque applications, such as conveyors and positive displacement pumps.
- **Linear V/f control with Flux Current Control (FCC) P1300 = 1**
This control mode can be used to improve the efficiency and dynamic response of the motor.
- **Quadratic V/f control P1300 = 2**
This mode can be used for variable torque loads, such as fans and pumps.
- **Multi-point V/f control P1300 = 3**
For information regarding this mode of operation, please consult the MM420 Reference Manual.

4.5 Faults and warnings

SDP

If an SDP is fitted, the fault states and warnings are indicated by the two LEDs on the panel, see section 6.1 on page 68 for further information.

Fault-free operation of the inverter is indicated by the following sequence of LED displays:

- Green and yellow = Ready to run
- Green = Run

BOP

If a BOP is installed, the last 8 fault conditions (P0947) and warnings (P2110) are displayed if a fault condition occurs. For further information, please refer to the Parameter List.

AOP

If the AOP is fitted, the fault and warning codes are displayed on the LCD panel.

5 System parameters

This Chapter contains:

- An overview of the parameter structure of the MICROMASTER 420
- A parameter list in short form

5.1	Introduction to MICROMASTER system parameters.....	54
5.2	Parameter overview	55
5.3	Parameter list (short form)	56

5.1 Introduction to MICROMASTER system parameters

The parameters can only be changed by using the BOP, the Advance Operator Panel (AOP) or the Serial Interface.

Parameters can be changed and set using the BOP to adjust the desired properties of the inverter, such as ramp times, minimum and maximum frequencies etc. The parameter numbers selected and the setting of the parameter values are indicated on the optional five-digit LCD display.

- rxxxx indicates a display parameter, Pxxxx a setting parameter.
- P0010 initiates “quick commissioning”.
- The inverter will not run unless P0010 is set to 0 after it has been accessed. This function is automatically perform if P3900 > 0.
- P0004 acts as a filter, allowing access to parameters according to their functionality.
- If an attempt is made to change a parameter that cannot be changed in this status, for example, cannot be changed whilst running or can only be changed in quick commissioning, then - - - - - will be displayed.
- **Busy Message**
In some cases - when changing parameter values - the display on the BOP shows P - - - - - for maximum of five seconds. This means the inverter is busy with tasks of higher priority.

5.1.1 Level

There are four levels of user access, Standard, Extended, Expert and Service selectable by parameter P0003. For most applications, Standard (P0003 = 1) or Extended parameters (P0003 = 2) are sufficient.

The number of parameters that appear within each functional group depends on the access level set in parameter P0003. For further details regarding parameters, see the Parameter List on the Documentation CD-ROM.

5.2 Parameter overview

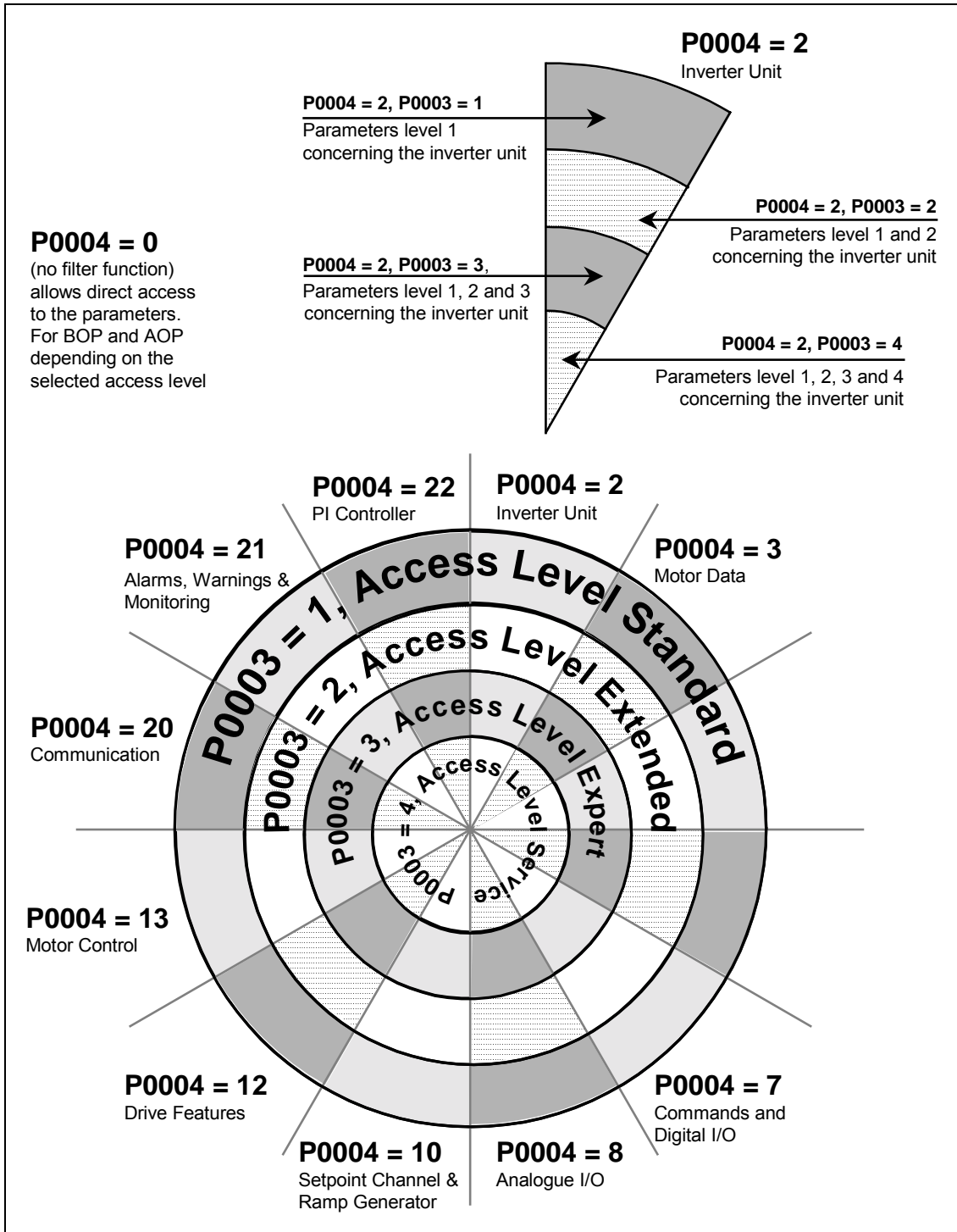

Figure 5-1 Parameter Overview

5.3 Parameter list (short form)

Explanatory information on following table:

- Default: Factory setting
- Level: Access level
- DS Inverter status (Drive State), indicates the inverter state in which a parameter can be modified (see P0010).
 - ◆ C Commissioning
 - ◆ U Run
 - ◆ T Ready to run
- QC Quick Commissioning
 - ◆ Q Parameter can be modified in the Quick Commissioning state.
 - ◆ N Parameter cannot be modified in the Quick Commissioning state.

Always

Par. No.	Parametername	Default	Acc	WS	QC
r0002	Drive state	-	2	-	-
P0003	User access level	1	1	CUT	-
P0004	Parameter filter	0	1	CUT	-
P0010	Commissioning parameter filter	0	1	CT	N
P3950	Access of hidden parameter	0	4	CUT	-

Quick Commissioning

Par.-No.	Parametername	Default	Level	WS	QC
P0100	Europe / North America	0	1	C	Q
P3900	End of quick commissioning	0	1	C	Q

Parameter Reset

Par.-No.	Parametername	Default	Level	WS	QC
P0970	Factory reset	0	1	C	-

Inverter Unit (P0004 = 2)

Par. No.	Parametername	Default	Acc	WS	QC
r0018	Firmware version	-	1	-	-
r0026	CO: Act. DC-link voltage	-	2	-	-
r0037[1]	CO: Drive temperatures	-	3	-	-
r0039	CO: Energy consumpt. meter [kWh]	-	2	-	-
P0040	Reset energy consumption meter	0	2	CT	-
r0200	Act. power stack code number	-	3	-	-
P0201	Power stack code number	0	3	C	-
r0203	Act. Power stack type	-	3	-	-
r0204	Power stack features	-	3	-	-
r0206	Rated inverter power [kW] or [hp]	-	2	-	-
r0207	Rated drive current	-	2	-	-
r0208	Supply voltage	-	2	-	-
P0210	Supply voltage	230	3	CT	-
r0231[2]	Max. cable length	-	3	-	-
P0290	Drive overload reaction	2	3	CT	-
P0291[1]	Config. Of inverter protection	1	3	CT	-
P0292	Drive overload warning	15	3	CUT	-
P0294	Drive I ² t overload warning	95.0	4	CUT	-
P1800	Switching frequency	4	2	CUT	-
r1801	CO: Act. switching frequency	-	3	-	-
P1802	Modulator mode	0	3	CUT	-
P1803[1]	Max. Modulation	106.0	4	CUT	-
P1820[1]	Reverse output phase sequence	0	2	CT	-
R3954[13]	CM version and GUI ID	-	4	-	-
P3980	Commissioning command Selection	-	4	T	-

Motor Data (P0004 = 3)

Par. No.	Parametername	Default	Acc	WS	QC
r0035[3]	CO: Act. motor temperature	-	2	-	-
P0300[1]	Select motor type	1	2	C	Q
P0304[1]	Rated motor voltage	230	1	C	Q
P0305[1]	Rated motor current	3.25	1	C	Q
P0307[1]	Rated motor power [kW] or [hp]	0.75	1	C	Q
P0308[1]	Rated motor cosPhi	0.000	2	C	Q
P0309[1]	Rated motor efficiency	0.0	2	C	Q
P0310[1]	Rated motor frequency	50.00	1	C	Q
P0311[1]	Rated motor speed	0	1	C	Q
r0313[1]	Motor pole pairs	-	3	-	-
P0320[1]	Motor magnetizing current	0.0	3	CT	Q
r0330[1]	Rated motor slip	-	3	-	-
r0331[1]	Rated magnetization current	-	3	-	-
r0332[1]	Rated power factor	-	3	-	-
P0335[1]	Motor cooling	0	2	CT	Q
P0340[1]	Calc motor model and control	0	2	CT	-
P0344[1]	Motor weight	9.4	3	CUT	-
P0346[1]	Magnetization time	1.000	3	CUT	-
P0347[1]	Demagnetization time	1.000	3	CUT	-
P0350[1]	Stator resistance (line-to-line)	4.0	2	CUT	-
r0370[1]	Stator resistance [%]	-	4	-	-
r0372[1]	Cable resistance [%]	-	4	-	-
r0373[1]	Rated stator resistance [%]	-	4	-	-
r0374[1]	Rotor resistance [%]	-	4	-	-
r0376[1]	Rated rotor resistance [%]	-	4	-	-
r0377[1]	Total leakage reactance [%]	-	4	-	-
r0382[1]	Main reactance	-	4	-	-
r0384[1]	Rotor time constant	-	3	-	-
r0386[1]	Total leakage time constant	-	4	-	-
r0395	Total stator resistance [%]	-	3	-	-
P0610	Motor I ² t temperature reaction	2	3	CT	-
P0611[1]	Motor I ² t time constant	100	2	CT	-
P0614[1]	Motor I ² t overload warning level	100.0	2	CUT	-
P0640[1]	Motor current limit	150.0	2	CUT	Q
P1910	Select motor data identification	0	2	CT	Q
r1912	Identified stator resistance	-	2	-	-

Commands and Digital I/O (P0004 = 7)

Par. No.	Parametername	Default	Acc	WS	QC
r0002	Drive state	-	2	-	-
r0019	CO/BO: BOP control word	-	3	-	-
r0052	CO/BO: Status word 1	-	2	-	-
r0053	CO/BO: Status word 2	-	2	-	-
r0054	CO/BO: Control word 1	-	3	-	-
r0055	CO/BO: Control word 2	-	3	-	-
P0700[1]	Selection of command source	2	1	CT	Q
P0701[1]	Selection of digital input 1	1	2	CT	-
P0702[1]	Selection of digital input 2	12	2	CT	-
P0703[1]	Selection of digital input 3	9	2	CT	-
P0704[1]	Selection of digital input 4	0	2	CT	-
P0719	Selection of cmd. & freq. setp.	0	3	CT	-
r0720	Number of digital inputs	-	3	-	-
r0722	CO/BO: Binary input values	-	2	-	-
P0724	Debounce time for digital inputs	3	3	CT	-
P0725	PNP / NPN digital inputs	1	3	CT	-
r0730	Number of digital outputs	-	3	-	-
P0731[1]	BI: Digital output	52:3	2	CUT	-
r0747	CO/BO: State of digital outputs	-	3	-	-
P0748	Invert digital outputs	0	3	CUT	-
P0800[1]	BI: Download parameter set 0	0:0	3	CT	-
P0801[1]	BI: Download parameter set 1	0:0	3	CT	-
P0840[1]	BI: ON/OFF1	722:0	3	CT	-
P0842[1]	BI: ON/OFF1 reverse	0:0	3	CT	-
P0844[1]	BI: 1. OFF2	1:0	3	CT	-
P0845[1]	BI: 2. OFF2	19:1	3	CT	-
P0848[1]	BI: 1. OFF3	1:0	3	CT	-
P0849[1]	BI: 2. OFF3	1:0	3	CT	-
P0852[1]	BI: Pulse enable	1:0	3	CT	-
P1020[1]	BI: Fixed freq. selection Bit 0	0:0	3	CT	-
P1021[1]	BI: Fixed freq. selection Bit 1	0:0	3	CT	-
P1022[1]	BI: Fixed freq. selection Bit 2	0:0	3	CT	-
P1035[1]	BI: Enable MOP (UP-command)	19:13	3	CT	-
P1036[1]	BI: Enable MOP (DOWN-command)	19:14	3	CT	-
P1055[1]	BI: Enable JOG right	0:0	3	CT	-
P1056[1]	BI: Enable JOG left	0:0	3	CT	-
P1074[1]	BI: Disable additional setpoint	0:0	3	CUT	-
P1110[1]	BI: Inhibit neg. freq. setpoint	0:0	3	CT	-
P1113[1]	BI: Reverse	722:1	3	CT	-
P1124[1]	BI: Enable JOG ramp times	0:0	3	CT	-
P1230[1]	BI: Enable DC braking	0:0	3	CUT	-
P2103[1]	BI: 1. Faults acknowledgement	722:2	3	CT	-
P2104[1]	BI: 2. Faults acknowledgement	0:0	3	CT	-
P2106[1]	BI: External fault	1:0	3	CT	-

Par. No.	Parametername	Default	Acc	WS	QC
P2220[1]	Bl: Fixed PID setp. select Bit 0	0:0	3	CT	-
P2221[1]	Bl: Fixed PID setp. select Bit 1	0:0	3	CT	-
P2222[1]	Bl: Fixed PID setp. select Bit 2	0:0	3	CT	-
P2235[1]	Bl: Enable PID-MOP (UP-cmd)	19:13	3	CT	-
P2236[1]	Bl: Enable PID-MOP (DOWN-cmd)	19:14	3	CT	-

Analogue I/O (P0004 = 8)

Par. No.	Parametername	Default	Acc	WS	QC
r0750	Number of ADCs	-	3	-	-
r0751	CO/BO: Status word: ADC-channels	-	4	-	-
r0752[1]	Act. input of ADC [V]	-	2	-	-
P0753[1]	Smooth time ADC	3	3	CUT	-
r0754[1]	Act. ADC value after scaling [%]	-	2	-	-
r0755[1]	CO: Act. ADC after scal. [4000h]	-	2	-	-
P0756[1]	Type of ADC	0	2	CT	-
P0757[1]	Value x1 of ADC scaling	0	2	CUT	-
P0758[1]	Value y1 of ADC scaling	0.0	2	CUT	-
P0759[1]	Value x2 of ADC scaling	10	2	CUT	-
P0760[1]	Value y2 of ADC scaling	100.0	2	CUT	-
P0761[1]	Width of ADC deadband	0	2	CUT	-
P0762[1]	Delay for loss of signal action	10	3	CUT	-
r0770	Number of DACs	-	3	-	-
P0771[1]	Cl: DAC	21:0	2	CUT	-
P0773[1]	Smooth time DAC	2	3	CUT	-
r0774[1]	Act. DAC value	-	2	-	-
r0776[1]	Type of DAC	0	3	CT	-
P0777[2]	Value x1 of DAC scaling	0.0	2	CUT	-
P0778[1]	Value y1 of DAC scaling	0	2	CUT	-
P0779[1]	Value x2 of DAC scaling	100.0	2	CUT	-
P0780[1]	Value y2 of DAC scaling	20	2	CUT	-
P0781[1]	Width of DAC deadband	0	2	CUT	-

Setpoint Channel and Ramp Generator (P0004 = 10)

Par. No.	Parametername	Default	Acc	WS	QC
P1000[1]	Selection of frequency setpoint	2	1	CT	Q
P1001	Fixed frequency 1	0.00	2	CUT	-
P1002	Fixed frequency 2	5.00	2	CUT	-
P1003	Fixed frequency 3	10.00	2	CUT	-
P1004	Fixed frequency 4	15.00	2	CUT	-
P1005	Fixed frequency 5	20.00	2	CUT	-
P1006	Fixed frequency 6	25.00	2	CUT	-
P1007	Fixed frequency 7	30.00	2	CUT	-
P1016	Fixed frequency mode - Bit 0	1	3	CT	-
P1017	Fixed frequency mode - Bit 1	1	3	CT	-
P1018	Fixed frequency mode - Bit 2	1	3	CT	-

Par. No.	Parametername	Default	Acc	WS	QC
r1024	CO: Act. fixed frequency	-	3	-	-
P1031[1]	Setpoint memory of the MOP	0	2	CUT	-
P1032	Inhibit reverse direction of MOP	1	2	CT	-
P1040[1]	Setpoint of the MOP	5.00	2	CUT	-
r1050	CO: Act. Output freq. of the MOP	-	3	-	-
P1058	JOG frequency right	5.00	2	CUT	-
P1059	JOG frequency left	5.00	2	CUT	-
P1060[1]	JOG ramp-up time	10.00	2	CUT	-
P1061[1]	JOG ramp-down time	10.00	2	CUT	-
P1070[1]	CI: Main setpoint	755:0	3	CT	-
P1071[1]	CI: Main setpoint scaling	1:0	3	T	-
P1075[1]	CI: Additional setpoint	0:0	3	CT	-
P1076[1]	CI: Additional setpoint scaling	1:0	3	T	-
r1078	CO: Total frequency setpoint	-	3	-	-
r1079	CO: Selected frequency setpoint	-	3	-	-
P1080	Min. frequency	0.00	1	CUT	Q
P1082	Max. frequency	50.00	1	CT	Q
P1091	Skip frequency 1	0.00	3	CUT	-
P1092	Skip frequency 2	0.00	3	CUT	-
P1093	Skip frequency 3	0.00	3	CUT	-
P1094	Skip frequency 4	0.00	3	CUT	-
P1101	Skip frequency bandwidth	2.00	3	CUT	-
r1114	CO: Freq. setp. after dir. ctrl.	-	3	-	-
r1119	CO: Freq. setpoint before RFG input	-	3	-	-
P1120[1]	Ramp-up time	10.00	1	CUT	Q
P1121[1]	Ramp-down time	10.00	1	CUT	Q
P1130[1]	Ramp-up initial rounding time	0.00	2	CUT	-
P1131[1]	Ramp-up final rounding time	0.00	2	CUT	-
P1132[1]	Ramp-down initial rounding time	0.00	2	CUT	-
P1133[1]	Ramp-down final rounding time	0.00	2	CUT	-
P1134[1]	Rounding type	0	2	CUT	-
P1135[1]	OFF3 ramp-down time	5.00	2	CUT	Q
P1140[1]	BI: RFG enable	1:0	4	CT	-
P1141[1]	BI: RFG start	1:0	4	CT	-
P1142[1]	BI: RFG enable setpoint	1:0	4	CT	-
r1170	CO: Frequency setpoint	-	3	-	-

Drive Features (P0004 = 12)

Par. No.	Parametername	Default	Acc	WS	QC
P0005	Display selection	21	2	CUT	-
P0006	Display mode	2	3	CUT	-
P0007	Backlight delay time	0	3	CUT	-
P0011	Lock for user defined parameter	0	3	CUT	-
P0012	Key for user defined parameter	0	3	CUT	-
P0013[20]	User defined parameter	0	3	CUT	-
P1200	Flying start enable	0	2	CUT	-
P1202[1]	Motor-current: Flying start	100	3	CUT	-
P1203[1]	Search rate: Flying start	100	3	CUT	-
P1204	Status word: Flying start	-	4	-	-
P1210	Automatic restart	1	2	CUT	-
P1211	Number of restart attempts	3	3	CUT	-
P1215	MHB function enable	0	2	T	-
P1216	MHB release delay	1.0	2	T	-
P1217	MHB holding time	1.0	2	T	-
P1232	Current of DC braking	100	2	CUT	-
P1233	Duration of DC braking	0	2	CUT	-
P1236	Compound braking current	0	2	CUT	-
P1240[1]	Configuration of Vdc controller	1	3	CT	-
r1242	CO: Switch-on level of Vdc-max	-	3	-	-
P1243[1]	Dynamic factor of Vdc-max	100	3	CUT	-
P1250[1]	Gain Vdc-controller	1.00	4	CUT	-
P1251[1]	Integration time Vdc-controller	40.0	4	CUT	-
P1252[1]	Differential time Vdc-controller	1.0	4	CUT	-
P1253[1]	Vdc-controller output limitation	10	3	CUT	-
P1254	Auto detect Vdc switch-on levels	1	3	CT	-

Motor Control (P0004 = 13)

Par. No.	Parametername	Default	Acc	WS	QC
r0020	CO: Act. frequency setpoint	-	3	-	-
r0021	CO: Act. frequency	-	2	-	-
r0022	Act. rotor speed	3	N	-	-
r0024	CO: Act. output frequency	-	3	-	-
r0025	CO: Act. output voltage	-	2	-	-
r0027	CO: Act. output current	-	2	-	-
r0034[1]	CO: Motor utilization	-	2	-	-
r0036	CO: Drive utilization	-	4	-	-
r0056	CO/BO: Status of motor control	-	2	-	-
r0067	CO: Act. drive current limit	-	3	-	-
r0071	CO: Max. output voltage	-	3	-	-
r0078	CO: Act. current Isq	-	4	-	-
r0084	CO: Act. Air gap flux	-	4	-	-
r0086	CO: Act. active current	-	3	-	-
P1300[1]	Control mode	1	2	CT	Q
P1310[1]	Continuous boost	50.0	2	CUT	-
P1311[1]	Acceleration boost	0.0	2	CUT	-
P1312[1]	Starting boost	0.0	2	CUT	-
r1315	CO: Total boost voltage	-	4	-	-
P1316[1]	Boost end frequency	20.0	3	CUT	-
P1320[1]	Programmable V/f freq. coord. 1	0.00	3	CT	-
P1321[1]	Programmable V/f volt. coord. 1	0.0	3	CUT	-
P1322[1]	Programmable V/f freq. coord. 2	0.00	3	CT	-
P1323[1]	Programmable V/f volt. coord. 2	0.0	3	CUT	-
P1324[1]	Programmable V/f freq. coord. 3	0.00	3	CT	-
P1325[1]	Programmable V/f volt. coord. 3	0.0	3	CUT	-
P1333	Start frequency for FCC	10.0	3	CUT	-
P1335	Slip compensation	0.0	2	CUT	-
P1336	Slip limit	250	2	CUT	-
r1337	CO: Slip frequency	-	3	-	-
P1338	Resonance damping gain V/f	0.00	3	CUT	-
P1340	Imax controller prop. gain	0.000	3	CUT	-
P1341	Imax controller integral time	0.300	3	CUT	-
r1343	CO: Imax controller freq. output	-	3	-	-
r1344	CO: Imax controller volt. output	-	3	-	-
P1350[1]	Voltage soft start	0	3	CUT	-

Communication (P0004 = 20)

Par. No.	Parametername	Default	Acc	WS	QC
P0918	CB bus address	3	2	CT	-
P0927	Parameter changeable via	15	2	CUT	-
r0964[5]	Firmware version data	-	3	-	-
r0967	Control word 1	-	3	-	-
r0968	Status word 1	-	3	-	-
P0971	Transfer data from RAM to EEPROM	0	3	CUT	-
P2000[1]	Reference frequency	50.00	2	CT	-
P2001[1]	Reference voltage	1000	3	CT	-
P2002[1]	Reference current	0.10	3	CT	-
P2009[2]	USS normalization	0	3	CT	-
P2010[2]	USS baudrate	6	2	CUT	-
P2011[2]	USS address	0	2	CUT	-
P2012[2]	USS PZD length	2	3	CUT	-
P2013[2]	USS PKW length	127	3	CUT	-
P2014[2]	USS telegram off time	0	3	CT	-
r2015[4]	CO: PZD from BOP link (USS)	-	3	-	-
P2016[4]	CI: PZD to BOP link (USS)	52:0	3	CT	-
r2018[4]	CO: PZD from COM link (USS)	-	3	-	-
P2019[4]	CI: PZD to COM link (USS)	52:0	3	CT	-
r2024[2]	USS error-free telegrams	-	3	-	-
r2025[2]	USS rejected telegrams	-	3	-	-
r2026[2]	USS character frame error	-	3	-	-
r2027[2]	USS overrun error	-	3	-	-
r2028[2]	USS parity error	-	3	-	-
r2029[2]	USS start not identified	-	3	-	-
r2030[2]	USS BCC error	-	3	-	-
r2031[2]	USS length error	-	3	-	-
r2032	BO: CtrlWrd1 from BOP link (USS)	-	3	-	-
r2033	BO: CtrlWrd2 from BOP link (USS)	-	3	-	-
r2036	BO: CtrlWrd1 from COM link (USS)	-	3	-	-
r2037	BO: CtrlWrd2 from COM link (USS)	-	3	-	-
P2040	CB telegram off time	0	3	CT	-
P2041[5]	CB parameter	0	3	CT	-
r2050[4]	CO: PZD from CB	-	3	-	-
P2051[4]	CI: PZD to CB	52:0	3	CT	-
r2053[5]	CB identification	-	3	-	-
r2054[7]	CB diagnosis	-	3	-	-
r2090	BO: Control word 1 from CB	-	3	-	-
r2091	BO: Control word 2 from CB	-	3	-	-

Alarms, Warnings and Monitoring (P0004 = 21)

Par. No.	Parametername	Default	Acc	WS	QC
r0947[8]	Fault number	-	2	-	-
r0948[12]	Fault time	-	3	-	-
R0949[8]	Fault value	-	4	-	-
P0952	Total number of faults	0	3	CT	-
P2100[3]	Alarm number stop reaction	0	3	CT	-
P2101[3]	Stop reaction value	0	3	CT	-
r2110[4]	Warning number	-	2	-	-
P2111	Total number of warnings	0	3	CT	-
r2114[2]	Run time counter	-	3	-	-
P2115[3]	AOP real time clock	0	3	CT	-
P2120	Indication counter	0	4	CUT	-
P2150[1]	Hysteresis frequency f,hys	3.00	3	CUT	-
P2155[1]	Threshold frequency f1	30.00	3	CUT	-
P2156[1]	Delay time f1	10	3	CUT	-
P2164[1]	Hysteresis frequency f,hysLeave	3.00	3	CUT	-
P2167[1]	Switch-off frequency f_off	1.00	3	CUT	-
P2168[1]	Delay time Toff (inverter switch-off)	10	3	CUT	-
P2170[1]	Threshold current I,thresh	100.0	3	CUT	-
P2171[1]	Delay time current	10	3	CUT	-
P2172[1]	Threshold voltage Vdc, thresh	800	3	CUT	-
P2173[1]	Delay time Vdc	10	3	CUT	-
P2179	Current limit for no load ident.	3.0	3	CUT	-
P2180	Delay time for no load ident.	2000	3	CUT	-
r2197	CO/BO: Status word 1 of monitor	-	2	-	-
P3981	Reset active fault	0	4	CT	-

PI Controller (P0004 = 22)

Par. No.	Parametername	Default	Acc	WS	QC
P2200[1]	BI: Enable PID controller	0:0	2	CT	-
P2201	Fixed PID setpoint 1	0.00	2	CUT	-
P2202	Fixed PID setpoint 2	10.00	2	CUT	-
P2203	Fixed PID setpoint 3	20.00	2	CUT	-
P2204	Fixed PID setpoint 4	30.00	2	CUT	-
P2205	Fixed PID setpoint 5	40.00	2	CUT	-
P2206	Fixed PID setpoint 6	50.00	2	CUT	-
P2207	Fixed PID setpoint 7	60.00	2	CUT	-
P2216	Fixed PID setpoint mode - Bit 0	1	3	CT	-
P2217	Fixed PID setpoint mode - Bit 1	1	3	CT	-
P2218	Fixed PID setpoint mode - Bit 2	1	3	CT	-
r2224	CO: Act. fixed PID setpoint	-	2	-	-
P2231[1]	Setpoint memory of PID-MOP	0	2	CUT	-
P2232	Inhibit rev. direct. of PID-MOP	1	2	CT	-
P2240[1]	Setpoint of PID-MOP	10.00	2	CUT	-
r2250	CO: Output setpoint of PID-MOP	-	2	-	-
P2253[1]	CI: PID setpoint	0:0	2	CUT	-
P2254[1]	CI: PID trim source	0:0	3	CUT	-
P2255	PID setpoint gain factor	100.00	3	CUT	-
P2256	PID trim gain factor	100.00	3	CUT	-
P2257	Ramp-up time for PID setpoint	1.00	2	CUT	-
P2258	Ramp-down time for PID setpoint	1.00	2	CUT	-
r2260	CO: Act. PID setpoint	-	2	-	-
P2261	PID setpoint filter timeconstant	0.00	3	CUT	-
r2262	CO: Act. PID filtered setpoint	-	3	-	-
P2264[1]	CI: PID feedback	755:0	2	CUT	-
P2265	PID feedback filter timeconstant	0.00	2	CUT	-
r2266	CO: PID feedback	-	2	-	-
P2267	Max. value for PID feedback	100.00	3	CUT	-
P2268	Min. value for PID feedback	0.00	3	CUT	-
P2269	Gain applied to PID feedback	100.00	3	CUT	-
P2270[1]	PID feedback function selector	0	3	CUT	-
P2271	PID transducer type	0	2	CUT	-
r2272	CO: PID scaled feedback	-	2	-	-
r2273	CO: PID error	-	2	-	-
P2280	PID proportional gain	3.000	2	CUT	-
P2285	PID integral time	0.000	2	CUT	-
P2291	PID output upper limit	100.00	2	CUT	-
P2292	PID output lower limit	0.00	2	CUT	-
P2293	Ramp-up /-down time of PID limit	1.00	3	CUT	-
r2294	CO: Act. PID output	-	2	-	-

6 Troubleshooting

This Chapter contains:

- An overview of the operating statuses of the inverter with the SDP
- Notes on troubleshooting with the BOP
- A list of the alarms and fault messages

6.1	Troubleshooting with the	68
6.2	Troubleshooting with the BOP	69
6.3	MICROMASTER 420 fault messages	70

**WARNING**

- ◆ Repairs on equipment may only be carried out by **Siemens Service**, by repair centers **authorized by Siemens** or by qualified personnel who are thoroughly acquainted with all the warnings and operating procedures contained in this manual.
- ◆ Any defective parts or components must be replaced using parts contained in the relevant spare parts list.
- ◆ Disconnect the power supply before opening the equipment for access

6.1 Troubleshooting with the SDP

Table 6-1 explains the meaning of the various states of the LEDs on the SDP.

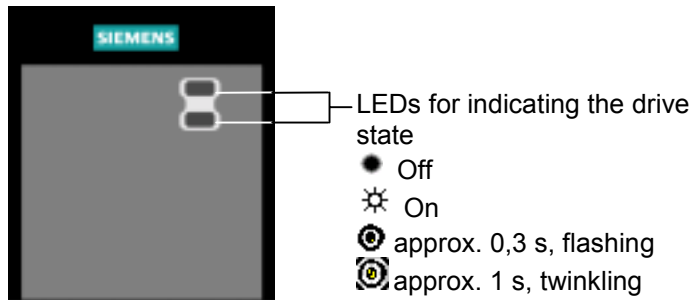

Table 6-1 Inverter conditions indicated by the LEDs on the SDP

●	Mains not present	☀	Fault inverter temperature
☀	Ready to run	⊙	Warning current limit - both LEDs twinkling same time
●	Inverter fault - other than the ones listed below	⊙	Other warnings - both LEDs twinkling alternatively
☀	Inverter running	⊙	Undervoltage trip / undervoltage warning
●	Fault overcurrent	⊙	Drive is not in ready state
⊙	Fault overvoltage	⊙	ROM failure - Both LEDs flashing same time
⊙	Fault motor overtemperature	⊙	RAM failure - Both LEDs flashing alternatively

6.2 Troubleshooting with the BOP

Warnings and faults are displayed on the BOP with Axxx and Fxxx respectively. The individual messages are shown in Section 6.3.

If the motor fails to start when the ON command has been given:

- Check that P0010 = 0.
- Check that a valid ON signal is present.
- Check that P0700 = 2 (for digital input control) or P0700 = 1 (for BOP control).
- Check that the setpoint is present (0 to 10V on Terminal 3) or the setpoint has been entered into the correct parameter, depending upon the setpoint source (P1000). See the Parameter List for further details.

If the motor fails to run after changing the parameters, set P0010 = 30 then P0970 = 1 and press **P** to reset the inverter to the factory default parameter values.

Now use a switch between terminals **5** and **8** on the control board. The drive should now run to the defined setpoint by analogue input.

NOTICE

Motor data must relate to the inverter data power range and voltage.

6.3 MICROMASTER 420 fault messages

In the event of a failure, the inverter switches off and a fault code appears on the display.

NOTE

To reset the fault code, one of three methods listed below can be used:

1. Cycle the power to the drive.
2. Press the  button on the BOP or AOP.
3. Via Digital Input 3 (default setting)

Fault	Possible Causes	Diagnose & Remedy	Reaction
F0001 Overcurrent	<ul style="list-style-type: none"> ➤ Motor power does not correspond to the inverter power ➤ Motor lead short circuit ➤ Earth fault 	Check the following: <ol style="list-style-type: none"> 1. Motor power (P0307) must correspond to inverter power (P0206) 2. Cable length limits must not be exceeded 3. Motor cable and motor must have no short-circuits or earth faults 4. Motor parameters must match the motor in use 5. Value of stator resistance (P0350) must be correct 6. Motor must not be obstructed or overloaded <ul style="list-style-type: none"> ➤ Increase the ramp time ➤ Reduce the boost level 	OFF2
F0002 Overvoltage	<ul style="list-style-type: none"> ➤ DC-link voltage (r0026) exceeds trip level (P2172) ➤ Overvoltage can be caused either by too high main supply voltage or if motor is in regenerative mode ➤ Regenerative mode can be caused by fast ramp downs or if the motor is driven from an active load 	Check the following: <ol style="list-style-type: none"> 1. Supply voltage (P0210) must lie within limits indicated on rating plate 2. DC-link voltage controller must be enabled (P1240) and parameterized properly 3. Ramp-down time (P1121) must match inertia of load 	OFF2
F0003 Undervoltage	<ul style="list-style-type: none"> ➤ Main supply failed ➤ Shock load outside specified limits 	Check the following: <ol style="list-style-type: none"> 1. Supply voltage (P0210) must lie within limits indicated on rating plate 2. Supply must not be susceptible to temporary failures or voltage reductions 	OFF2
F0004 Inverter Over-temperature	<ul style="list-style-type: none"> ➤ Ambient temperature outside of limits, ➤ Fan failure 	Check the following: <ol style="list-style-type: none"> 1. Fan must turn when inverter is running 2. Pulse frequency must be set to default value 3. Air inlet and outlet points are not obstructed Ambient temperature could be higher than specified for the inverter	OFF2
F0005 Inverter I²t	<ul style="list-style-type: none"> ➤ Inverter overloaded ➤ Duty cycle too demanding ➤ Motor power (P0307) exceeds inverter power capability (P0206) 	Check the following: <ol style="list-style-type: none"> 1. Load duty cycle must lie within specified limits 2. Motor power (P0307) must match inverter power (P0206) 	OFF2
F0011 Motor Over-temperature I²t	<ul style="list-style-type: none"> ➤ Motor overloaded ➤ Motor data incorrect ➤ Long time period operating at low speeds 	<ol style="list-style-type: none"> 1. Check motor data 2. Check loading on motor 3. Boost settings too high (P1310, P1311, P1312) 4. Check parameter for motor thermal time constant 5. Check parameter for motor I²t warning level 	OFF1
F0041 Stator resistance measurement failure	Stator resistance measurement failure	<ol style="list-style-type: none"> 1. Check if the motor is connected to the inverter 2. Check that the motor data has been entered correctly 	OFF2

Fault	Possible Causes	Diagnose & Remedy	Reaction
F0051 Parameter EEPROM Fault	Reading or writing of the non-volatile parameter storage has failed	1. Factory reset and new parameterization 2. Change inverter	OFF2
F0052 Powerstack Fault	Reading of the powerstack information has failed or the data is invalid	Change inverter	OFF2
F0060 Asic Timeout	Internal communications failure	1. Acknowledge fault 2. Change inverter if repeated	OFF2
F0070 Communications board setpoint error	No setpoint received from communications board during telegram off time	1. Check connections to the communications board 2. Check the master	OFF2
F0071 No Data for USS (RS232 link) during Telegram Off Time	No response during telegram off time via USS (BOP link)	1. Check connections to the communications board 2. Check the master	OFF2
F0072 No Data from USS (RS485 link) during Telegram Off Time	No response during telegram off time via USS (COM link)	1. Check connections to the communications board 2. Check the master	OFF2
F0080 Analogue input - lost input signal	<ul style="list-style-type: none"> ➤ Broken wire ➤ Signal out of limits 	Check connection to analogue input	OFF2
F0085 External Fault	External fault is triggered via terminal inputs	Disable terminal input for fault trigger	OFF2
F0101 Stack Overflow	Software error or processor failure	1. Run self test routines 2. Change inverter	OFF2
F0221 PI Feedback below minimum value	PID Feedback below minimum value P2268	1. Change value of P2268 2. Adjust feedback gain	OFF2
F0222 PI Feedback above maximum value	PID Feedback above maximum value P2267	1. Change value of P2267 2. Adjust feedback gain	OFF2
F0450 (Service mode only) BIST Tests Failure	Fault value 1 Some of the power section tests have failed 2 Some of the control board tests have failed 4 Some of the functional tests have failed 8 Some of the IO module tests have failed 16 The Internal RAM has failed its check on power-up	1. Inverter may run but certain actions will not function correctly 2. Replace inverter	OFF2

6.4 MICROMASTER 420 alarm messages

Fault	Possible Causes	Diagnose & Remedy	Reaction
A0501 Current Limit	<ul style="list-style-type: none"> ➤ Motor power does not correspond to the inverter power ➤ Motor leads are too short ➤ Earth faults 	<ol style="list-style-type: none"> 1. Check whether the motor power corresponds to the inverter power 2. Check that the cable length limits have not been exceeded 3. Check motor cable and motor for short-circuits and earth faults 4. Check whether the motor parameters correspond with the motor being used 5. Check the stator resistance 6. Increase the ramp-up-time 7. Reduce the boost 8. Check whether the motor is obstructed or overloaded 	--
A0502 Overvoltage limit	<ul style="list-style-type: none"> ➤ Mains supply too high ➤ Load regenerative ➤ Ramp-down time too short 	<ol style="list-style-type: none"> 1. Check that mains supply voltage is within allowable range 2. Increase ramp down times <p>Note: Vdc-max controller is active, ramp-down times will be automatically increased</p>	--
A0503 Undervoltage Limit	<ul style="list-style-type: none"> ➤ Mains supply too low ➤ Short mains interruption 	Check main supply voltage (P0210)	--
A0504 Inverter Over-temperature	Warning level of inverter heat-sink temperature (P0614) is exceeded, resulting in pulse frequency reduction and/or output frequency reduction (depending on parametrization in (P0610))	<ol style="list-style-type: none"> 1. Check if ambient temperature is within specified limits 2. Check load conditions and duty cycle 3. Check if fan is turning when drive is running 	--
A0505 Inverter I²t	Warning level is exceeded; current will be reduced if parameterized (P0610 = 1)	Check if duty cycle is within specified limits	--
A0506 Inverter Duty Cycle	Heatsink temperature and thermal junction model are outside of allowable range	Check if duty cycle are within specified limits	--
A0511 Motor Over-temperature I²t	Motor overloaded	Check the following: <ol style="list-style-type: none"> 1. P0611 (motor I²t time constant) should be set to appropriate value 2. P0614 (Motor I²t overload warning level) should be set to suitable level 3. Are long periods of operation at low speed occurring 4. Check that boost settings are not too high 	--
A0541 Motor Data Identification Active	Motor data identification (P1910) selected or running	Wait until motor identification is finished	--
A0600 RTOS Overrun Warning	Software error		
A0700 CB warning 1	CB (communication board) specific	See CB user manual	--
A0701 CB warning 2	CB (communication board) specific	See CB user manual	--
A0702 CB warning 3	CB (communication board) specific	See CB user manual	--
A0703 CB warning 4	CB (communication board) specific	See CB user manual	--
A0704 CB warning 5	CB (communication board) specific	See CB user manual	--
A0705 CB warning 6	CB (communication board) specific	See CB user manual	--

Fault	Possible Causes	Diagnose & Remedy	Reaction
A0706 CB warning 7	CB (communication board) specific	See CB user manual	--
A0707 CB warning 8	CB (communication board) specific	See CB user manual	--
A0708 CB warning 9	CB (communication board) specific	See CB user manual	--
A0709 CB warning 10	CB (communication board) specific	See CB user manual	--
A0710 CB communication error	Communication with CB (communication board) is lost	Check CB hardware	--
A0711 CB configuration error	CB (communication board) reports a configuration error	Check CB parameters	--
A0910 Vdc-max controller deactivated	Vdc max controller has been deactivated, since controller is not capable of keeping DC-link voltage (r0026) within limits (P2172) <ul style="list-style-type: none"> ➤ Occurs if main supply voltage (P0210) is permanently too high ➤ Occurs if motor is driven by an active load, causing motor to go into regenerative mode ➤ Occurs at very high load inertias, when ramping down 	Check the following: <ol style="list-style-type: none"> 1. Input voltage (P0756) lies within range? 2. Load must match In certain cases apply braking resistor	--
A0911 Vdc-max controller active	Vdc max controller is active; so ramp-down times will be increased automatically to keep DC-link voltage (r0026) within limits (P2172)	<ol style="list-style-type: none"> 1. Check parameter inverter input voltage 2. Check ramp-down times 	--
A0912 Vdc-min controller active	Vdc min controller will be activated if DC-link voltage (r0026) falls below minimum level (P2172) <ul style="list-style-type: none"> ➤ The kinetic energy of the motor is used to buffer the DC-link voltage, thus causing deceleration of the drive! ➤ So short mains failures do not necessarily lead to an undervoltage trip 		--
A0920 ADC parameters not set properly	ADC parameters should not be set to identical values, since this would produce illogical results. <ul style="list-style-type: none"> ➤ Index 0: Parameter settings for output identical ➤ Index 1: Parameter settings for input identical ➤ Index 2: Parameter settings for input do not correspond to ADC type 	Analogue input parameters should not be set to the same value as each other	--
A0921 DAC parameters not set properly	DAC parameters should not be set to identical values, since this would produce illogical results. <ul style="list-style-type: none"> ➤ Index 0: Parameter settings for output identical ➤ Index 1: Parameter settings for input identical ➤ Index 2: Parameter settings for output do not correspond to DAC type 	Analogue Output parameters should not be set to the same value as each other	--
A0922 No load applied to inverter	<ul style="list-style-type: none"> ➤ No Load is applied to the inverter ➤ As a result, some functions may not work as under normal load conditions Low output voltage eg when 0 boost applied at 0 Hz	<ol style="list-style-type: none"> 1. Check that load is applied to the inverter 2. Check motor parameters correspond to motor attached 3. As a result, some functions may not work correctly, because there is no normal load condition 	--

Fault	Possible Causes	Diagnose & Remedy	Reaction
A0923 Both JOG Left and JOG Right are requested	Both JOG right and JOG left (P1055/P1056) have been requested. This freezes the RFG output frequency at its current value. JOG right and JOG left signals active together	Make sure that JOG right and JOG left signals are not applied simultaneously	--

7 MICROMASTER 420 specifications

This Chapter contains:

- Table 7-1 contains the general technical specifications for the MICROMASTER 420 inverter
- Table 7-2 contains terminal tightening torques
- Table 7-3 includes various tables of specific technical data for individual MICROMASTER 420 inverters

Table 7-1 MICROMASTER Performance Ratings

Feature	Specification
Mains operating voltage and Power ranges	1 AC 200 V to 240 V \pm 10 % 0,12 kW – 3,0 kW (0,16 hp – 4,0 hp) 3 AC 200 V to 240 V \pm 10 % 0,12 kW – 5,5 kW (0,16 hp – 7,5 hp) 3 AC 380 V to 480 V \pm 10 % 0,37 kW – 11,0 kW (0,50 hp – 15,0 hp)
Input frequency	47 Hz to 63 Hz
Output frequency	0 Hz to 650 Hz
Power factor	\geq 0,7
Inverter efficiency	96 % to 97 %
Overload capability	50 % overload capability for 60 s within 5 min period referred to the rated output current
Inrush current	Less than nominal input current
Control method	Linear V/f Control; Linear V/f with Flux Current Control (FCC), Quadratic V/f Control; Multi-point V/f control
Pulse frequency	2 kHz to 16 kHz (2 kHz steps)
Fixed frequencies	7, programmable
Skip frequencies	4, programmable
Setpoint resolution	0.01 Hz Digital, 0.01 Hz Serial, 10 bit Analogue (motor potentiometer 0.1 Hz [0.1% (in PID mode)])
Digital inputs	3, programmable (isolated), switchable active high / active low (PNP/NPN)
Analogue input	1, (0 to 10 V) used for frequency setpoint or PI feedback signal, scalable or usable as 4 th digital input
Relay outputs	1, programmable 30 V DC / 5 A (resistive), 250 V AC / 2 A (inductive)
Analogue output	1, programmable (0 mA to 20 mA)
Serial interface	RS-485, Option RS-232
Electromagnetic compatibility	Optional EMC filters to EN55011 Class A or B, also Internal Class A filters available
Braking	DC braking, compound braking
Protection level	IP20
Temperature range	-10 °C to +50 °C (14 °F to 122 °F)
Storage temperature	-40 °C to +70 °C (-40 °F to 158 °F)
Humidity	< 95 % RH – non-condensing
Operational altitudes	up to 1000 m above sea level without derating
Protection features	Undervoltage, Overvoltage, Overload, Ground Faults, Short circuit, Stall Prevention, Motor Blocking Protection, Motor Overtemperature, Inverter Overtemperature, Parameter Interlock
Standards	UL, cUL, CE, C-tick
CE Marked	Conformity with EC Low Voltage Directive 73/23/EEC and Electromagnetic Compatibility Directive 89/336/EEC

Table 7-2 Tightening torques for power terminals

Frame size		A	B	C
Tightening torque	[Nm]	1,1	1,5	2,25
	[lbf.in]	10	13,3	20

Table 7-3 MICROMASTER 420 Specifications

In order to have a UL compliant installation fuses from the SITOR range with the appropriate current rating must be used.

Input voltage range **1 AC 200 V – 240 V, ± 10 %**
(with built in Class A Filter)

Order No.	6SE6420-	2AB11-2AA0	2AB12-5AA0	2AB13-7AA0	2AB15-5AA0	2AB17-5AA0	2AB21-1BA0	2AB21-5BA0	2AB22-2BA0	2AB23-0CA0
Motor Output Rating	[kW]	0,12	0,25	0,37	0,55	0,75	1,1	1,5	2,2	3,0
	[hp]	0,16	0,33	0,5	0,75	1,0	1,5	2,0	3,0	4,0
Output Power	[kVA]	0,4	0,7	1,0	1,3	1,7	2,4	3,2	4,6	6,0
Output Current Max.	[A]	0,9	1,7	2,3	3,0	3,9	5,5	7,4	10,4	13,6
Input Current	[A]	2	4	5,5	7,5	9,9	14,4	19,6	26,4	35,5
Recommended Fuse	[A]	10	10	10	10	16	20	20	25	32
		3NA3803	3NA3803	3NA3803	3NA3803	3NA3805	3NA3807	3NA3807	3NA3810	3NA3812
Input Cable Min.	[mm ²]	1,0	1,0	1,0	1,0	1,0	2,5	2,5	4,0	6,0
	[awg]	17	17	17	17	17	17	15	11	9
Input Cable Max.	[mm ²]	2,5	2,5	2,5	2,5	2,5	6,0	6,0	6,0	10,0
	[awg]	13	13	13	13	13	9	9	9	7
Output Cable Min.	[mm ²]	1,0	1,0	1,0	1,0	1,0	1,0	1,0	1,0	1,5
	[awg]	17	17	17	17	17	17	17	17	15
Output Cable Max.	[mm ²]	2,5	2,5	2,5	2,5	2,5	6,0	6,0	6,0	10,0
	[awg]	13	13	13	13	13	9	9	9	7
Weight	[kg]	1,2	1,2	1,2	1,3	1,3	3,3	3,6	3,6	5,2
	[lbs]	2,6	2,6	2,6	2,9	2,9	7,3	7,9	7,9	11,4
Dimensions	w [mm]	73,0	73,0	73,0	73,0	73,0	149,0	149,0	149,0	185,0
	h [mm]	173,0	173,0	173,0	173,0	173,0	202,0	202,0	202,0	245,0
	d [mm]	149,0	149,0	149,0	149,0	149,0	172,0	172,0	172,0	195,0
	w [inches]	2,87	2,87	2,87	2,87	2,87	5,87	5,87	5,87	7,28
	h [inches]	6,81	6,81	6,81	6,81	6,81	7,95	7,95	7,95	9,65
	d [inches]	5,87	5,87	5,87	5,87	5,87	6,77	6,77	6,77	7,68

**Input voltage range 3 AC 200 V – 240 V, ± 10 %
(with built in Class A Filter)**

Order No.	6SE6420-	2AC23- 0CA0	2AC24- 0CA0	2AC25- 5CA0
Motor Output Rating	[kW]	3,0	4,0	5,5
	[hp]	4,0	5,0	7,5
Output Power	[kVA]	6,0	7,7	9,6
Output Current Max.	[A]	13,6	17,5	22,0
Input Current	[A]	15,6	19,7	26,3
Recommended Fuse	[A]	25	32	35
		3NA3810	3NA3812	3NA3814
Input Cable Min.	[mm ²]	2,5	2,5	4,0
	[awg]	13,0	13,0	11,0
Input Cable Max.	[mm ²]	10,0	10,0	10,0
	[awg]	7,0	7,0	7,0
Output Cable Min.	[mm ²]	1,5	2,5	4,0
	[awg]	15,0	13,0	11,0
Output Cable Max.	[mm ²]	10,0	10,0	10,0
	[awg]	7,0	7,0	7,0
Weight	[kg]	5,2	5,7	5,7
	[lbs]	11,4	12,5	12,5
Dimensions	w [mm]	185,0	185,0	185,0
	h [mm]	245,0	245,0	245,0
	d [mm]	195,0	195,0	195,0
	w [inches]	7,28	7,28	7,28
	h [inches]	9,65	9,65	9,65
	d [inches]	7,68	7,68	7,68

**Input voltage range
(Unfiltered)** **1 AC / 3 AC 200 V – 240 V, ± 10 %**

Order No.	6SE6420-	2UC11 -2AA0	2UC12 -5AA0	2UC13 -7AA0	2UC15 -5AA0	2UC17 -5AA0	2UC21 -1BA0	2UC21 -5BA0	2UC22 -2BA0	2UC23 -0CA0
Motor Output Rating	[kW]	0,12	0,25	0,37	0,55	0,75	1,1	1,5	2,2	3,0
	[hp]	0,16	0,33	0,5	0,75	1,0	1,5	2,0	3,0	4,0
Output Power	[kVA]	0,4	0,7	1,0	1,3	1,7	2,4	3,2	4,6	6,0
Output Current Max.	[A]	0,9	1,7	2,3	3	3,9	5,5	7,4	10,4	13,6
Input Current, 3 AC	[A]	0,7	1,7	2,4	3,1	4,3	6,2	8,3	11,3	15,6
Recommended Fuse	[A]	10	10	10	10	10	16	16	20	25
		3NA3803	3NA3803	3NA3803	3NA3803	3NA3803	3NA3805	3NA3805	3NA3807	3NA3810
Input Current, 1 AC	[A]	2	4	5,5	7,5	9,9	14,4	19,6	26,4	35,5
Recommended Fuse	[A]	10	10	10	10	16	20	20	25	32
		3NA3803	3NA3803	3NA3803	3NA3803	3NA3805	3NA3807	3NA3807	3NA3810	3NA3812
Input Cable Min.	[mm ²]	1,0	1,0	1,0	1,0	1,0	1,0	1,0	1,0	2,5
	[awg]	17	17	17	17	17	17	17	17	13
Input Cable Max.	[mm ²]	2,5	2,5	2,5	2,5	2,5	6,0	6,0	6,0	10,0
	[awg]	13	13	13	13	13	9	9	9	7
Output Cable Min.	[mm ²]	1,0	1,0	1,0	1,0	1,0	1,0	1,0	1,0	1,5
	[awg]	17	17	17	17	17	17	17	17	15
Output Cable Max.	[mm ²]	2,5	2,5	2,5	2,5	2,5	6,0	6,0	6,0	10,0
	[awg]	13	13	13	13	13	9	9	9	7
Weight	[kg]	1,2	1,2	1,2	1,2	1,2	2,9	2,9	3,1	5,2
	[lbs]	2,6	2,6	2,6	2,6	2,6	6,4	6,4	6,8	11,4
Dimensions	w [mm]	73,0	73,0	73,0	73,0	73,0	149,0	149,0	149,0	185,0
	h [mm]	173,0	173,0	173,0	173,0	173,0	202,0	202,0	202,0	245,0
	d [mm]	149,0	149,0	149,0	149,0	149,0	172,0	172,0	172,0	195,0
	w [inches]	2,87	2,87	2,87	2,87	2,87	5,87	5,87	5,87	7,28
	h [inches]	6,81	6,81	6,81	6,81	6,81	7,95	7,95	7,95	9,65
	d [inches]	5,87	5,87	5,87	5,87	5,87	6,77	6,77	6,77	7,68

Input voltage range (Unfiltered) 3 AC 200 V – 240 V, ± 10 %

Order No.	6SE6420-	2UC24-0CA0	2UC25-5CA0
Motor Output Rating	[kW]	4,0	5,5
	[hp]	5,0	7,5
Output Power	[kVA]	7,7	9,6
Output Current Max.	[A]	17,5	22
Input Current	[A]	19,7	26,3
Recommended Fuse	[A]	32	35
		3NA3812	3NA3814
Input Cable Min.	[mm ²]	2,5	4,0
	[awg]	13,0	11,0
Input Cable Max.	[mm ²]	10,0	10,0
	[awg]	7,0	7,0
Output Cable Min.	[mm ²]	2,5	4,0
	[awg]	13,0	11,0
Output Cable Max.	[mm ²]	10,0	10,0
	[awg]	7,0	7,0
Weight	[kg]	5,5	5,5
	[lbs]	12,1	12,1
Dimensions	w [mm]	185,0	185,0
	h [mm]	245,0	245,0
	d [mm]	195,0	195,0
	w [inches]	7,28	7,28
	h [inches]	9,65	9,65
	d [inches]	7,68	7,68

Input voltage range 3 AC 380 V – 480 V, ± 10 %
(with built in Class A Filter)

Order No.	6SE6420-	2AD22-2BA0	2AD23-0BA0	2AD24-0BA0	2AD25-5CA0	2AD27-5CA0	2AD31-1CA0
Motor Output Rating	[kW]	2,2	3,0	4,0	5,5	7,5	11,0
	[hp]	3,0	4,0	5,0	7,5	10,0	15,0
Output Power	[kVA]	4,5	5,9	7,8	10,1	14,0	19,8
Output Current Max.	[A]	5,9	7,7	10,2	13,2	18,4	26,0
Input Current	[A]	7,5	10	12,8	17,3	23,1	33,8
Recommended Fuse	[A]	16	16	20	20	25	35
		3NA3805	3NA3805	3NA3807	3NA3807	3NA3810	3NA3814
Input Cable Min.	[mm ²]	1,0	1,0	1,5	2,5	4,0	6,0
	[awg]	17	17	15	13	11	9
Input Cable Max.	[mm ²]	6,0	6,0	6,0	10,0	10,0	10,0
	[awg]	9	9	9	7	7	7
Output Cable Min.	[mm ²]	1,0	1,0	1,0	1,5	2,5	4,0
	[awg]	17	17	17	15	13	11
Output Cable Max.	[mm ²]	6,0	6,0	6,0	10,0	10,0	10,0
	[awg]	9	9	9	7	7	7
Weight	[kg]	3,1	3,3	3,3	5,4	5,7	5,7
	[lbs]	6,8	7,3	7,3	11,9	12,5	12,5
Dimensions	w [mm]	149,0	149,0	149,0	185,0	185,0	185,0
	h [mm]	202,0	202,0	202,0	245,0	245,0	245,0
	d [mm]	172,0	172,0	172,0	195,0	195,0	195,0
	w [inches]	5,87	5,87	5,87	7,28	7,28	7,28
	h [inches]	7,95	7,95	7,95	9,65	9,65	9,65
	d [inches]	6,77	6,77	6,77	7,68	7,68	7,68

**Input voltage range 3 AC 380 V – 480 V, ± 10 %
(Unfiltered)**

Order No.	6SE6420-	2UD13 -7AA0	2UD15 -5AA0	2UD17 -5AA0	2UD21 -1AA0	2UD21 -5AA0	2UD22 -2BA0	2UD23 -0BA0	2UD24 -0BA0	2UD25 -5CA0	2UD27 -5CA0	2UD31 -1CA0
Motor Output Rating	[kW] [hp]	0,37 0,5	0,55 0,75	0,75 1,0	1,1 1,5	1,5 2,0	2,2 3,0	3,0 4,0	4,0 5,0	5,5 7,5	7,5 10,0	11,0 15,0
Output Power	[kVA]	0,9	1,2	1,6	2,3	3,0	4,5	5,9	7,8	10,1	14,0	19,8
Output Current Max.	[A]	1,2	1,6	2,1	3,0	4,0	5,9	7,7	10,2	13,2	18,4	26,0
Input Current	[A]	1,6	2,1	2,8	4,2	5,8	7,5	10,0	12,8	17,3	23,1	33,8
Recommended Fuse	[A]	10	10	10	10	10	16	16	20	20	25	32
		3NA3803	3NA3803	3NA3803	3NA3803	3NA3803	3NA3805	3NA3805	3NA3807	3NA3807	3NA3810	3NA3814
Input Cable Min.	[mm ²] [awg]	1,0 17	1,0 17	1,0 17	1,0 17	1,0 17	1,0 17	1,0 17	1,5 15	2,5 13	4,0 11	6,0 9
Input Cable Max.	[mm ²] [awg]	2,5 13	2,5 13	2,5 13	2,5 13	2,5 13	6,0 9	6,0 9	6,0 9	10,0 7	10,0 7	10,0 7
Output Cable Min.	[mm ²] [awg]	1,0 17	1,0 17	1,0 17	1,0 17	1,0 17	1,0 17	1,0 17	1,0 17	1,5 15	2,5 13	4,0 11
Output Cable Max.	[mm ²] [awg]	2,5 13	2,5 13	2,5 13	2,5 13	2,5 13	6,0 9	6,0 9	6,0 9	10,0 7	10,0 7	10,0 7
Weight	[kg] [lbs]	1,3 2,9	1,3 2,9	1,3 2,9	1,3 2,9	1,3 2,9	3,1 6,8	3,3 7,3	3,3 7,3	5,2 11,4	5,5 12,1	5,5 12,1
Dimensions	w [mm]	73,0	73,0	73,0	73,0	73,0	149,0	149,0	149,0	185,0	185,0	185,0
	h [mm]	173,0	173,0	173,0	173,0	173,0	202,0	202,0	202,0	245,0	245,0	245,0
	d [mm]	149,0	149,0	149,0	149,0	149,0	172,0	172,0	172,0	195,0	195,0	195,0
	w [inches]	2,87	2,87	2,87	2,87	2,87	5,87	5,87	5,87	7,28	7,28	7,28
	h [inches]	6,81	6,81	6,81	6,81	6,81	7,95	7,95	7,95	9,65	9,65	9,65
	d [inches]	5,87	5,87	5,87	5,87	5,87	6,77	6,77	6,77	7,68	7,68	7,68

8 Options

An overview of the options available for the MICROMASTER 420 is given in this section. For further information about options, please refer to the catalog or the documentation CD.

8.1 Device-independent options

- Basic Operator Panel (BOP)
- Advanced Operator Panel (AOP)
- PROFIBUS module
- PC to inverter connection kit
- PC to AOP connection kit
- BOP/AOP door mounting kit for single inverter control
- AOP door mounting kit for multiple inverter control
- "DriveMonitor" and "Starter" commissioning tool

8.2 Device-dependent options

- EMC filter, Class A
- EMC filter, Class B
- Additional EMC filter, Class B
- Low leakage Class B filter
- Line commutating choke
- Output choke
- Gland plate

9 Electro-magnetic compatibility (EMC)

This Chapter contains:

EMC information.

9.1	Electro-magnetic compatibility (EMC).....	86
-----	---	----

9.1 Electro-magnetic compatibility (EMC)

All manufacturers / assemblers of electrical apparatus which “performs a complete intrinsic function and is placed on the market as a single unit intended for the end user” must comply with the EMC directive 89/336/EEC.

There are three routes for the manufacturer/assembler to demonstrate compliance:

9.1.1 Self-certification

This is a manufacturer's declaration that the European standards applicable to the electrical environment for which the apparatus is intended have been met. Only standards that have been officially published in the Official Journal of the European Community can be cited in the manufacturer's declaration.

9.1.2 Technical construction file

A technical construction file can be prepared for the apparatus describing its EMC characteristics. This file must be approved by a ‘Competent Body’ appointed by the appropriate European government organization. This approach allows the use of standards that are still in preparation.

9.1.3 EC type examination certificate

This approach is only applicable to radio communication transmitting apparatus. All MICROMASTER units are certified for compliance with the EMC directive, when installed in accordance with the recommendations in Section 2.

9.1.4 EMC Directive Compliance with Imminent Harmonics Regulations

From 1st January 2001 all electrical apparatus covered by the EMC Directive will have to comply with EN 61000-3-2 "Limits for harmonic current emissions (equipment input ≤ 16 A per phase)".

All Siemens variable speed drives of the MICROMASTER, MIDIMASTER, MICROMASTER Eco and COMBIMASTER ranges, which are classified as "Professional Equipment" within the terms of the standard, fulfill the requirements of the standard.

Special considerations for 250 W to 550 W drives with 230 V 1ac mains supplies when used in non-industrial applications

Units in this voltage and power range will be supplied with the following warning: *"This equipment requires supply authority acceptance for connection to the public supply network"*. Please refer to EN 61000-3-12 sections 5.3 and 6.4 for further information. Units connected to Industrial Networks¹ do not require connection approval (see EN 61800-3, section 6.1.2.2).

The harmonic current emissions from these products are described in the table below:

Table 9-1 Permissible harmonic current emissions

Rating	Typical Harmonic Current (A)					Typical Harmonic Current (%)					Typical Voltage Distortion		
	Distribution Transformer Rating									10 kVA	100 kVA	1 MVA	
	3 rd	5 th	7 th	9 th	11 th	3 rd	5 th	7 th	9 th	11 th	THD (%)	THD (%)	THD (%)
250 W 1AC 230 V	2.15	1.44	0.72	0.26	0.19	83	56	28	10	7	0.77	0.077	0.008
370 W 1AC 230 V	2.96	2.02	1.05	0.38	0.24	83	56	28	10	7	1.1	0.11	0.011
550 W 1AC 230 V	4.04	2.70	1.36	0.48	0.36	83	56	28	10	7	1.5	0.15	0.015

The allowed harmonic currents for "professional equipment" with an input power > 1 kW are not yet defined. Therefore, any electrical apparatus containing the above drives which has an input power > 1 kW will not require connection approval.

Alternatively, the necessity to apply for connection approval can be avoided by fitting the input chokes recommended in the technical catalogues (except 550 W 230 V 1ac units).

¹ Industrial Networks are defined as those which do not supply buildings used for domestic purposes.

9.1.5 Classification of EMC performance

Three General classes of EMC performance are available as detailed below:

Class 1: General Industrial

Compliance with the EMC Product Standard for Power Drive Systems EN 68100-3 for use in **Second Environment (Industrial)** and **Restricted Distribution**.

Table 9-2 Class 1 - General Industrial

EMC Phenomenon	Standard	Level
Emissions:		
Radiated Emissions	EN 55011	Level A1
Conducted Emissions	EN 68100-3	Limits under consideration
Immunity:		
Electrostatic Discharge	EN 61000-4-2	8 kV air discharge
Burst Interference	EN 61000-4-4	2 kV power cables, 1 kV control
Radio Frequency Electromagnetic Field	IEC 1000-4-3	26-1000 MHz, 10 V/m

Class 2: Filtered Industrial

This level of performance will allow the manufacturer/assembler to self-certify their apparatus for compliance with the EMC directive for the industrial environment as regards the EMC performance characteristics of the power drive system. Performance limits are as specified in the Generic Industrial Emissions and Immunity standards EN 50081-2 and EN 50082-2.

Table 9-3 Class 2 - Filtered Industrial

EMC Phenomenon	Standard	Level
Emissions:		
Radiated Emissions	EN 55011	Level A1
Conducted Emissions	EN 55011	Level A1
Immunity:		
Supply Voltage Distortion	IEC 1000-2-4 (1993)	
Voltage Fluctuations, Dips, Unbalance, Frequency Variations	IEC 1000-2-1	
Magnetic Fields	EN 61000-4-8	50 Hz, 30 A/m
Electrostatic Discharge	EN 61000-4-2	8 kV air discharge
Burst Interference	EN 61000-4-4	2 kV power cables, 2 kV control
Radio Frequency Electromagnetic Field, amplitude modulated	ENV 50 140	80-1000 MHz, 10 V/m, 80% AM, power and signal lines
Radio-frequency Electromagnetic Field, pulse modulated	ENV 50 204	900 MHz, 10 V/m 50% duty cycle, 200 Hz repetition rate

Class 3: Filtered - for residential, commercial and light industry

This level of performance will allow the manufacturer / assembler to self-certify compliance of their apparatus with the EMC directive for the residential, commercial and light industrial environment as regards the EMC performance characteristics of the power drive system. Performance limits are as specified in the generic emission and immunity standards EN 50081-1 and EN 50082-1.

Table 9-4 Class 3 - Filtered for Residential, Commercial and Light Industry

EMC Phenomenon	Standard	Level
<i>Emissions:</i>		
Radiated Emissions*	EN 55011	Level B
Conducted Emissions	EN 55011	Level B
<i>Immunity:</i>		
Supply Voltage Distortion	IEC 1000-2-4 (1993)	
Voltage Fluctuations, Dips, Unbalance, Frequency Variations	IEC 1000-2-1	
Magnetic Fields	EN 61000-4-8	50 Hz, 30 A/m
Electrostatic Discharge	EN 61000-4-2	8 kV air discharge
Burst Interference	EN 61000-4-4	2 kV power cables, 2 kV control
Radio Frequency Electromagnetic Field, amplitude modulated	ENV 50 140	80-1000 MHz, 10 V/m, 80% AM, power and signal lines
Radio-frequency Electromagnetic Field, pulse modulated	ENV 50 204	900 MHz, 10 V/m 50% duty cycle, 200 Hz repetition rate

* These limits are dependent on the inverter being correctly installed inside a metallic switchgear enclosure. The limits will not be met if the inverter is not enclosed.

NOTICE

- To achieve these performance levels, you must not exceed the default Pulse frequency nor use cables longer than 25 m.
- The MICROMASTER inverters are intended **exclusively for professional applications**. Therefore, they do not fall within the scope of the harmonics emissions specification EN 61000-3-2.
- Maximum mains supply voltage when filters are fitted is 460 V.

Table 9-5 Compliance Table

Model	Remarks
Class 1 – General Industrial	
6SE6420-2U***-**A0	Unfiltered units, all voltages and powers.
Class 2 – Filtered Industrial	
6SE6420-2A***-**A0	All units with integral Class A filters
6SE6420-2A***-**A0 with 6SE6400-2FA00-6AD0	Frame size A units 400-480 V with external Class A footprint filters
Class 3 – Filtered for residential, commercial and light industry	
6SE6420-2U***-**A0 with 6SE6400-2FB0*-***0	Unfiltered units fitted with external Class B footprint filters.
* denotes any value is allowed.	

Appendices

A Changing the Operator Panel

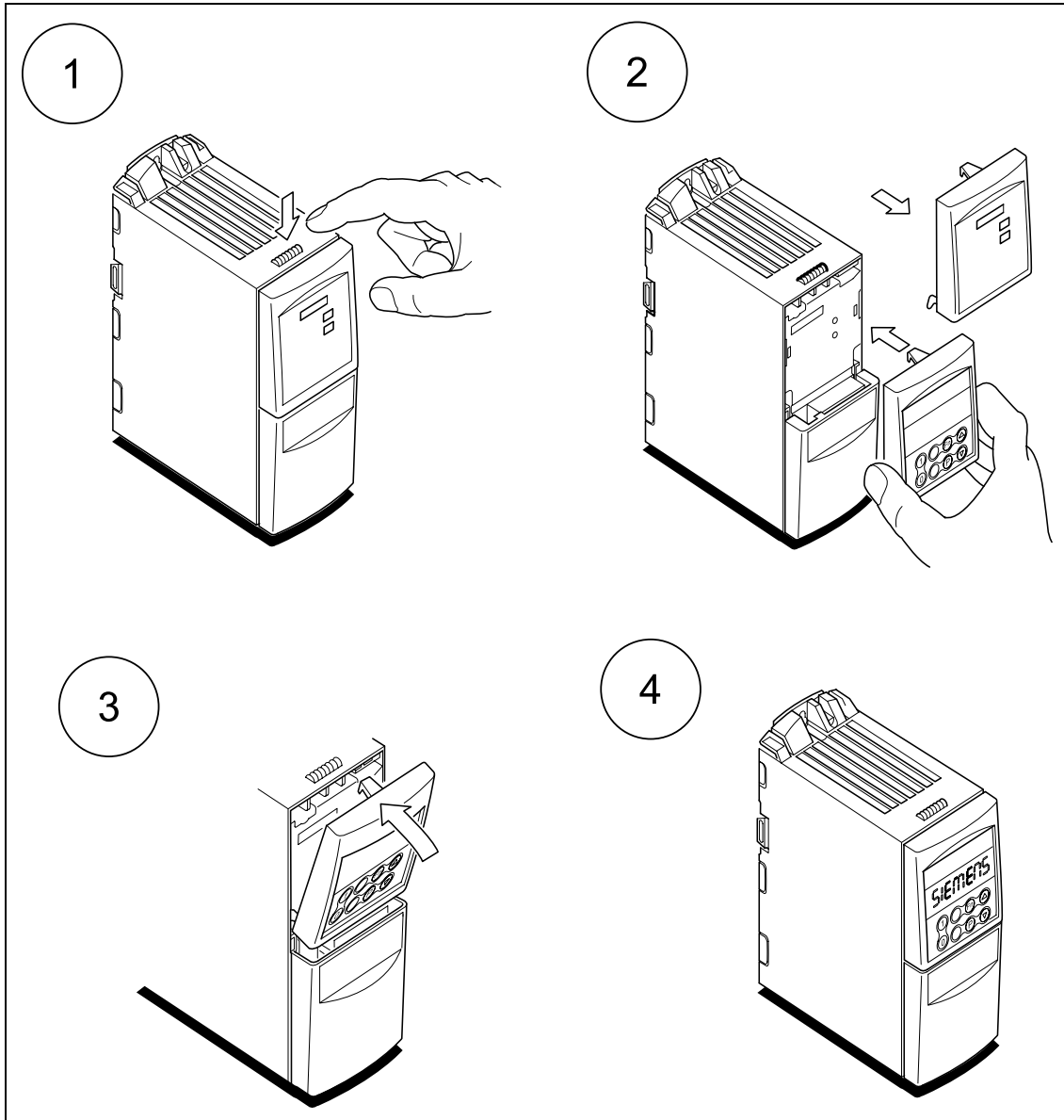

B Removing Covers Frame Size A

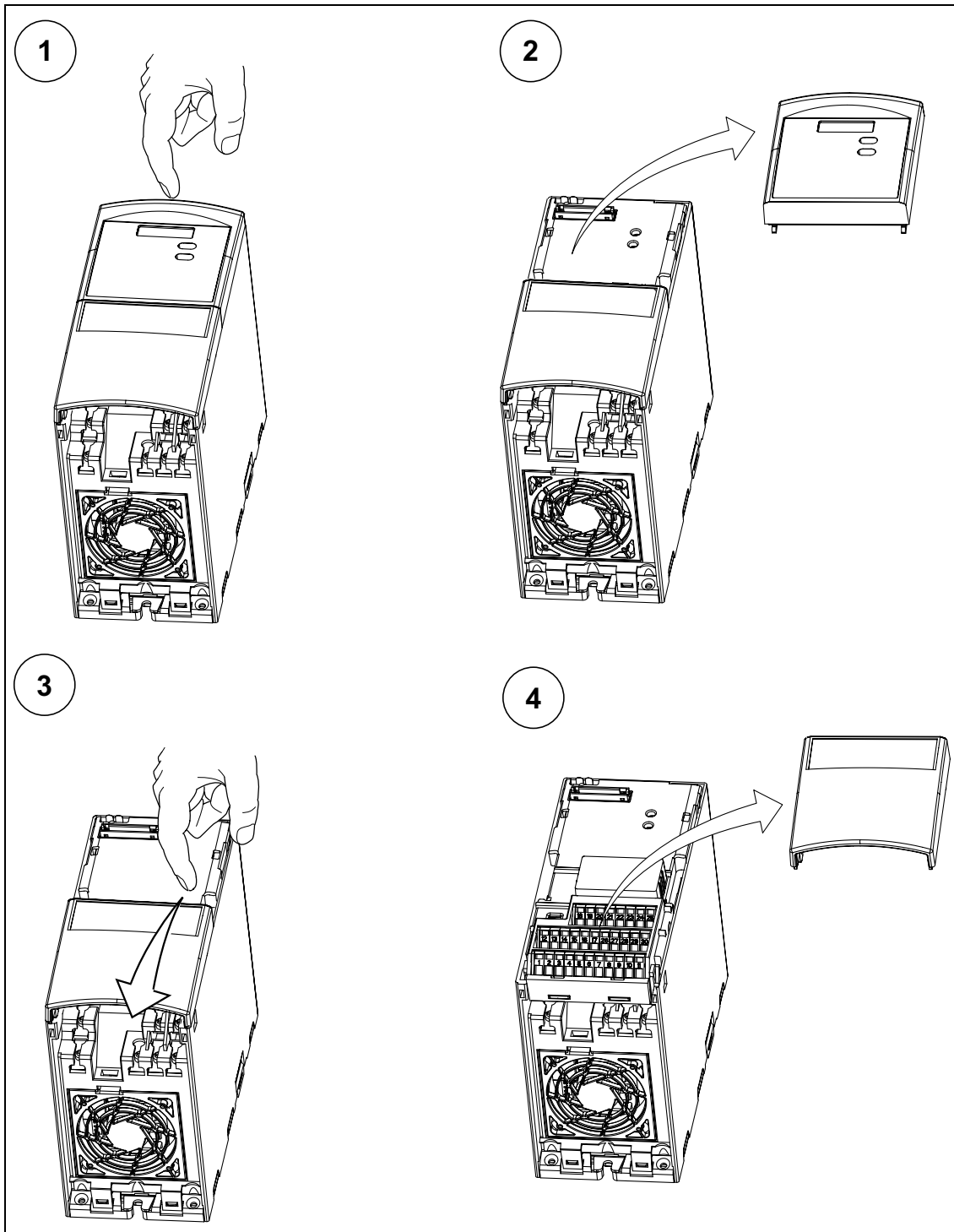

C Removing Covers Frame Size B and C

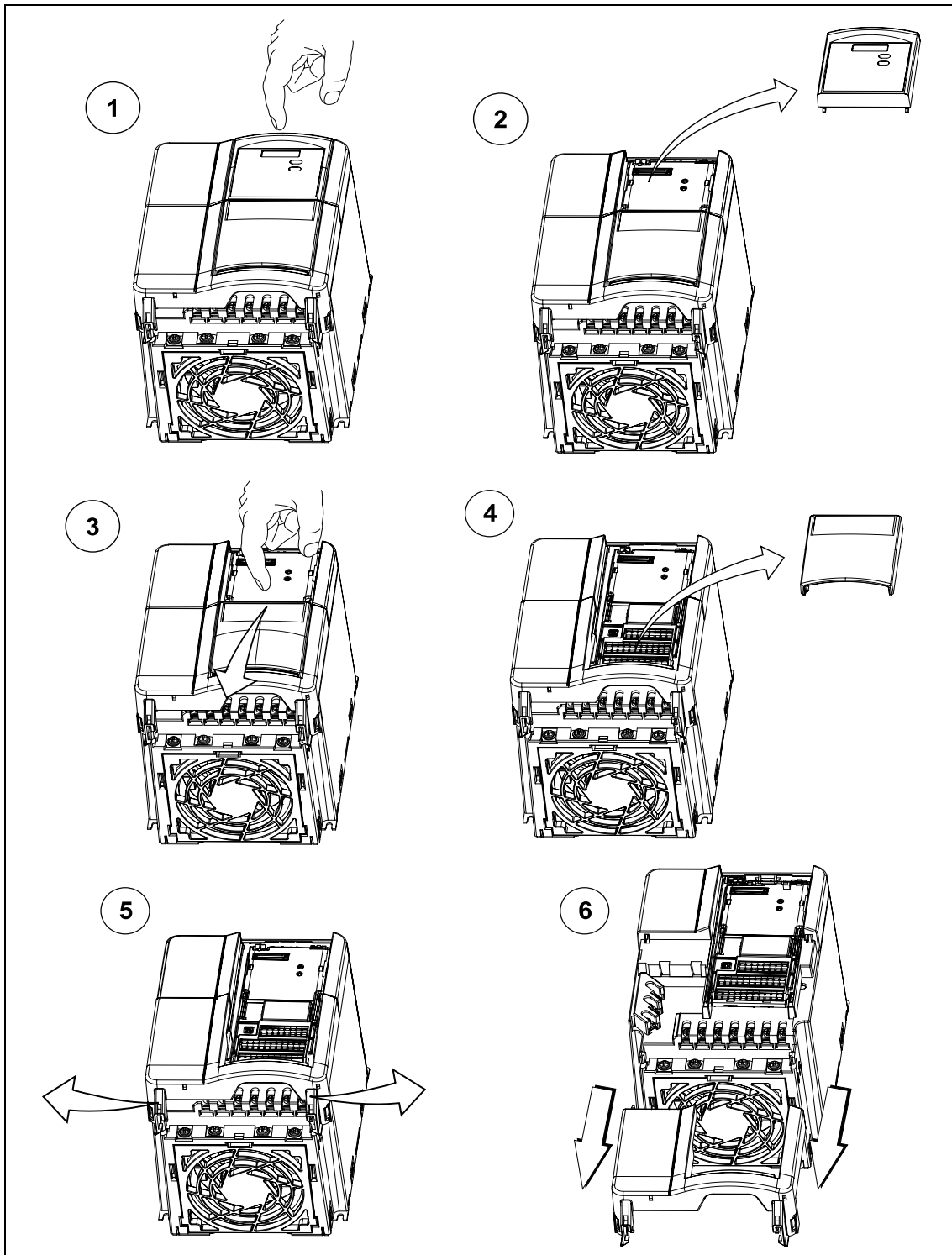

D Removing 'Y' Cap Frame Size A

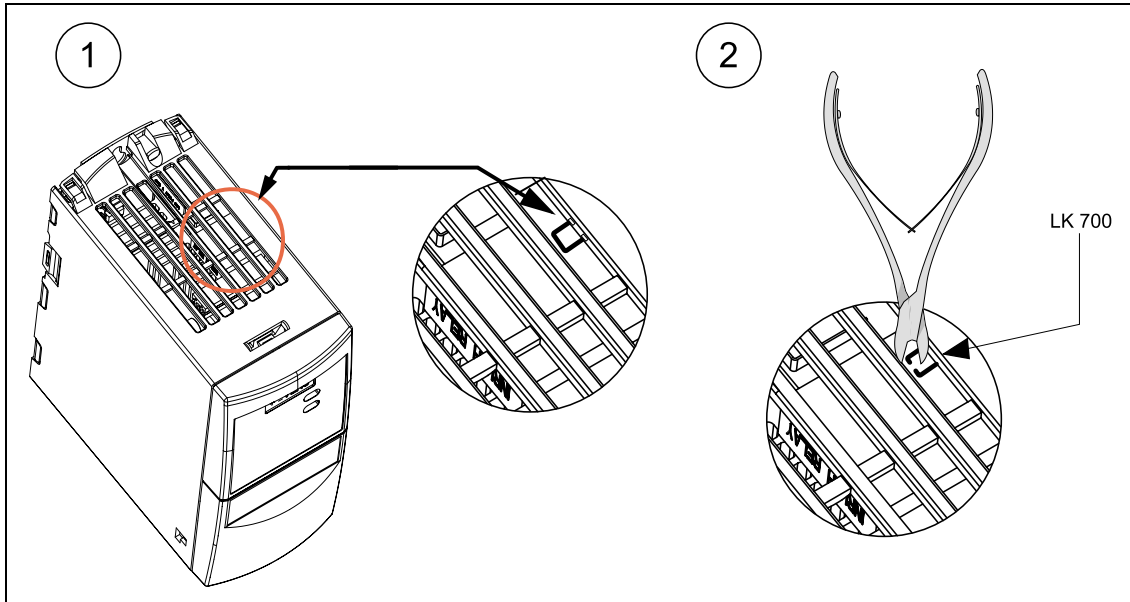

E Removing 'Y' Cap Frame Size B and C

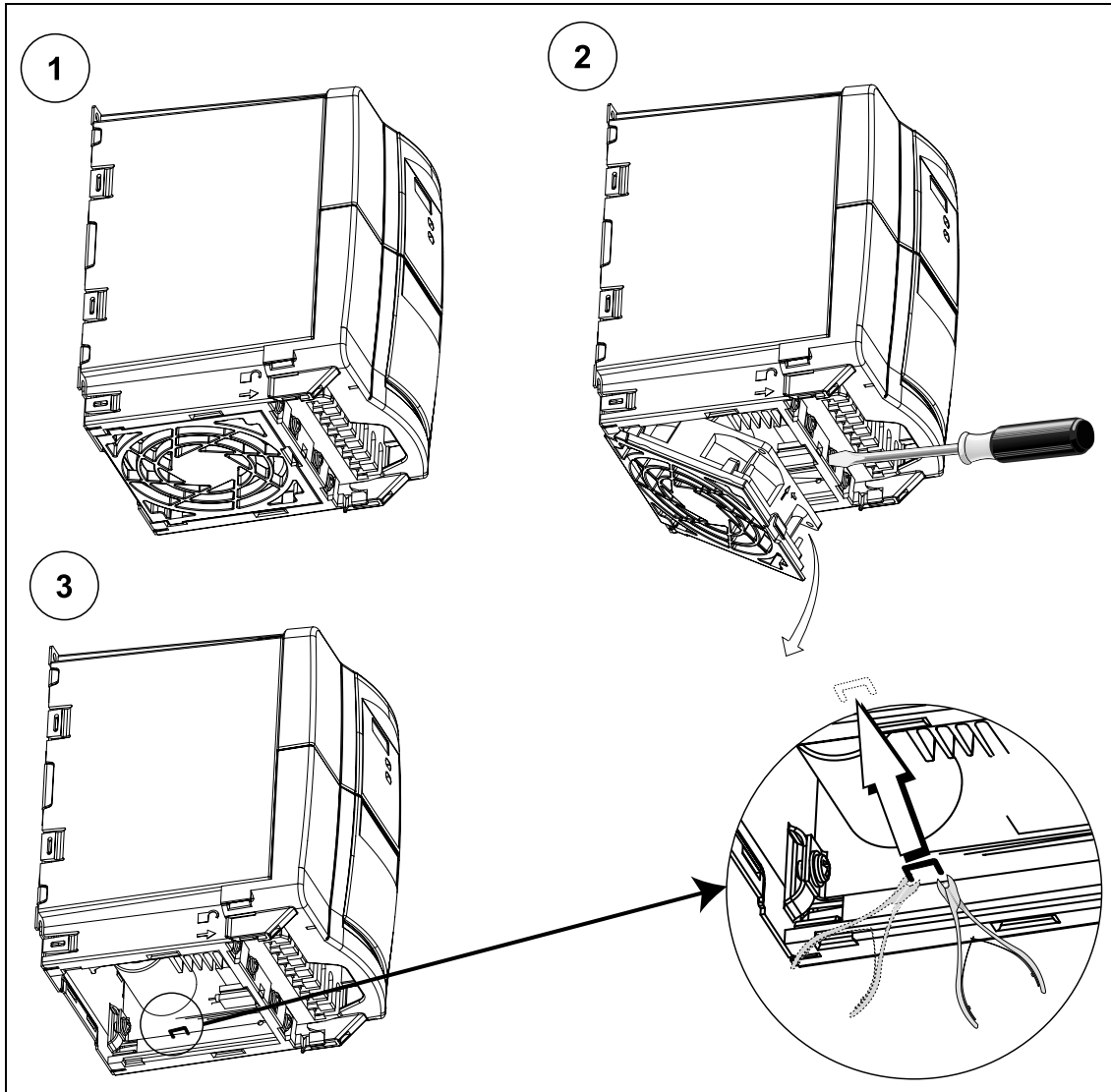

F Applicable Standards



European Low Voltage Directive

The MICROMASTER product range complies with the requirements of the Low Voltage Directive 73/23/EEC as amended by Directive 98/68/EEC. The units are certified for compliance with the following standards:

EN 60146-1-1 Semiconductor inverters - General requirements and line commutated inverters

EN 60204-1 Safety of machinery - Electrical equipment of machines

European Machinery Directive

The MICROMASTER inverter series does not fall under the scope of the Machinery Directive. However, the products have been fully evaluated for compliance with the essential Health & Safety requirements of the directive when used in a typical machine application. A Declaration of Incorporation is available on request.

European EMC Directive

When installed according to the recommendations described in this manual, the MICROMASTER fulfils all requirements of the EMC Directive as defined by the EMC Product Standard for Power Drive Systems EN61800-3.



Underwriters Laboratories

UL and CUL LISTED POWER CONVERSION EQUIPMENT 5B33 for use in a pollution degree 2

ISO 9001

Siemens plc operates a quality management system, which complies with the requirements of ISO 9001.

G List of Abbreviations

AC	Alternating Current
AIN	Analog Input
AOP	Advanced Operator Panel
BOP	Basic Operator Panel
CT	Constant Torque
DC	Direct Current
DIN	(Digital Input
DS	Drive State
EEC	European Economic Community
ELCB	Earth Leakage Circuit Breaker
EMC	Electro-Magnetic Compatibility
EMI	Electro-Magnetic Interference
FAQ	Frequently Asked Questions
FCC	Flux Current Control
FCL	Fast Current Limitation
I/O	Input and Output
IGBT	Insulated Gate Bipolar Transistor
LCD	Liquid Crystal Display
LED	Light Emitting Diode
PID	Proportional, Integral und Differential
PLC	Programmable Logic Controller
PTC	Positive Temperature Coefficient
QC	Quick Commissioning
RCCB	Residual Current Circuit Breaker
RCD	Residual Current Device
RPM	Revolutions Per Minute
SDP	Status Display Panel
VT	Variable Torque

Index

A

Altitude	22
Ambient operating conditions	21
Altitude	22
Atmospheric Pollution	22
Electromagnetic Radiation	22
Humidity	22
Installation und Kühlung.....	22
Shock	22
Temperature.....	21
Vibration	22
Water hazard.....	22
AOP	
operation with AOP	41
Applicable standards	
European EMC Directive.....	96
European Low Voltage Directive.....	96
European Machinery Directive	96
ISO 9001	96
Underwriters Laboratories.....	96
Atmospheric Pollution	22

B

Basic operation	
changing parameters with BOP	40
external motor thermal overload protection.....	43, 45
general	44
with BOP	44
with SDP.....	36
BOP	
Default settings	38
BOP	
available buttons	39
operation with BOP	38

C

Changing the Operator Panel.....	91
Commissioning	31
Compound Braking.....	50
Contact address.....	5
Control Modes (P1300).....	51

D

DC braking	50
Default settings for operation using the SDP	35
Dimensions and Torques	23
Drill pattern for MICROMASTER 420.....	23

E

Electrical Installation.....	25
Electro-Magnetic Compatibility	
EC type-examination certificate.....	86
general.....	85
general.....	86
self-certification.....	86
technical construction file	86
Electro-Magnetic Interference	28
avoiding EMI	28
Electromagnetic Radiation	22
EMC.....	86
EMC Directive Compliance	87
EMC performance	
filtered for residential, commercial and light industry.....	89
filtered industrial class	88
general industrial class	88
EMI	28

F

Fault messages	
with the BOP fitted	69
with the SDP fitted	68
Faults and warnings	
AOP fitted	52
BOP fitted	52
SDP fitted.....	52
Features	17
Foreword	5
Frequency Setpoint (P1000)	48

H

Humidity.....	22
---------------	----

I		P	
Installation	19	Parameters	
after a period of storage	21	changing parameters with BOP	40
Installation und Kühlung	22	system parameters	53
Internet Home Address	5	Performance characteristics	17
Inverter		Power and motor connections	26
block diagram	33	Power connections	26
L		Protection characteristics	17
Linear V/f control with Flux Current Control (FCC)P1300 = 1	51	Q	
Linear V/f control, P1300 = 0	51	Quadratic V/f control P1300 = 2	51
Long cables		Qualified personnel	6
operation with	25	Quick commissioning	41
M		R	
Main characteristics	17	Removing 'Y' Cap Frame Size A	94
Mechanical Installation	23	Removing 'Y' Cap Frame Size B and C ...	95
MICROMASTER 420		Removing Covers Frame Size A	92
fault messages	70	Removing Covers Frame Size B and C ...	93
general	16	Reset to Factory default	43
main characteristics	17	Residual Current Device	
performance characteristics	17	operation with	25
protection characteristics	17	S	
specifications	75	Safety instructions	7
MICROMASTER 420 Specifications	77	Screening Methods	29
MICROMASTER Performance Ratings ...	76	SDP	
Motor connections	26	default settings with BOP	38
Mounting on Hutschiene	24	operation with SDP	35
Multi-point V/f control P1300=3	51	Shock	22
O		T	
Operation		Technical Support	5
starting and stopping the motor	49	Temperature	21
Operation with		Troubleshooting	67
long cables	25	U	
Residual Current Device	25	Ungrounded (IT) supplies	
ungrounded IT supplies	25	operation with	25
Operator panel		V	
front panel controls	34	Vibration	22
Operator panels		W	
AOP	41	Warnings, cautions & notes	
BOP	38	commissioning	8
SDP	35	dismantling & disposal	9
Options		general	7
Device-dependent options	83		
Device-independent options	83		
Overview	15		

operation	9	Water hazard	22
repair	9	Wiring Guidelines EMI	29
transport & storage.....	8		

Suggestions and/or Corrections

<p>To: Siemens AG Automation & Drives Group SD VM 4 Postfach 3269 D-91050 Erlangen Bundesrepublik Deutschland</p> <p>Email: Technical.documentation@con.siemens.co.uk</p>	<p>Suggestions</p> <p>Corrections</p>
<p>From</p> <p>Name:</p> <p>Company/Service Department</p> <p>Address: _____</p> <p>_____</p> <p>Telephone: _____ / _____</p> <p>Telefax: _____ / _____</p>	<p>For Publication/Manual: MICROMASTER 420</p> <p>User Documentation</p> <p>Operating Instructions</p> <p>Order Number: 6SE6400-5AA00-0BP0</p> <p>Date of Issue: 10/01</p> <p>Should you come across any printing errors when reading this publication, please notify us on this sheet. Suggestions for improvement are also welcome.</p>

View of Unit

Frame Size A

Frame Size B & C

SDP fitted



Power Terminal Connections



Control Terminal Connections



Access to "Y Cap "



Siemens AG
Bereich Automation and Drives (A&D)
Geschäftsgebiet Standard Drives (SD)
Postfach 3269, D-91050 Erlangen
Federal Republic of Germany

© Siemens AG, 2001
Subject to change without prior notice

Siemens Aktiengesellschaft

Order No.: 6SE6400-5AA00-0BP0
Date: 10/01

