

Introduction

Micros 60

OS/OT

User Manual



P/N: RAB042DA



ABX Diagnostics
BP 7290
34184 MONTPELLIER Cedex 4- FRANCE



Micros 60

1. Revisions

Index	Technical note	Software rev.	Section	Date
Ba	RAH911AA	V1.4	All	05/23/02
Bb	RAH911AA	V1.4	1,3,6	11/04/02
Ca	RAH939AA	V1.6	All	12/10/02
Cb	ECR1354	V1.6 UL correction	1	01/09/03
Da	RAH986AA	V1.6 CE IVD Norms	Intro, 1	16/09/03

- This Document applies to the most latest software version.
- When a Subsequent software changes the information in this document, a new section and/or sections will be released.

① Notice of Liability

The information in this manual is distributed on an «as is» basis, without warranty. While every precaution has been taken in the preparation of this manual, **ABX Diagnostics** will not assume any liability to any persons or entities with respect to loss or damage, caused or alleged to be caused directly or indirectly by the instructions contained in this manual or by the computer software and hardware products described herein.

① Trademarks

Other Product names mentioned within this publication may be trademarks or registered trademarks of other companies.

① Copyright © 2003 by **ABX DIAGNOSTICS**

All rights reserved. No part of this manual may be reproduced or transmitted in any way, shape, or form, or by means of any electronic, mechanical, photocopying, recording, or otherwise, without the written consent of **ABX DIAGNOSTICS**.

① Potential hazards

To alert the operator of potentially hazardous conditions, one of the bold captioned headings which are described below is provided wherever necessary throughout this text.

WARNING: Flags a procedure that if not followed properly, can prove to be extremely hazardous to either the operator or the environment or both.

CAUTION: Emphasizes operating procedures that must be followed to avoid possible damage to or destruction the instrument.

IMPORTANT: Emphasizes operating procedures that must be followed to avoid erroneous results.

NOTE: Emphasizes the important information especially helpful to the operator before, during or after a specific operational function.

ABX DIAGNOSTICS.

B.P. 7290

Rue du caducée

Parc Euromédecine

34184 MONTPELLIER Cedex 04 - FRANCE

Tel: (33) 4 67 14 15 16

Fax: (33) 4 67 14 15 17

2. Warning and precautions

User manual must be entirely read and understood prior to the installation and functioning of the instrument. The user always operates with full knowledge and appreciation of instrument warnings, alarms and flags.

Should the user requires training in complement to information provided in the User manual, please contact youe **ABX DIAGNOSTICS** representative.

Always refer to labeling and **ABX DIAGNOSTICS** instructions in order to avoid to compromised system integrity.

The *ABX MICROS 60* responds to the standards and directives named in the Declaration of Conformity added at the beginning of this manual.

MICROS 60 OS/OT



The reagents and accessoires stipulated by **ABX DIAGNOSTICS** have been validated in accordance with the European Directive for in-vitro medical devices (98/79/CE).

The use of any other reagents and accessories may place at risk the performance of the instrument, engaging the Users responsibility. In this case, **ABX DIAGNOSTICS** takes no responsibility for the device nor for the results rendered.

Disposal gloves, eyes protection and lab coat must be worm by the operator.

Local or national regulations must be applied in all the operations.

Portable/ mobile telephones should not be used in proximity of the instrument.

All peripheral devices should be IEC compatible.

2.1 Limited garantee

The duration of guarantee is stipulated in the Sales conditions associated with the purchase of this instrument. To validate the guarantee, ensure the following is adhered to:

- 1 - The system is operated under the instructions of this manual.
- 2 - Only software or hardware specified by **ABX Diagnostics** is installed on the instrument. This software must be the original copyrighted version.
- 3 - Services and repairs are provided by an **ABX Diagnostics** authorized technician, using only **ABX Diagnostics** approved spare parts.
- 4 - The electrical supply of the laboratory follows the national regulations.
- 5 - Specimens are collected and stored in normal conditions.
- 6 - Reagents used are those specified in this user manual.
- 7 - Proper tools are used when maintenance or troubleshooting operations are performed

MICROS 60 OS/OT



If this instrument has been supplied to you by anyone other than **ABX Diagnostics** or an authorised representative, **ABX Diagnostics** cannot guarantee this product in terms of specification, latest revision and latest documentation. Further information may be obtained from your authorised representative.

2.2 Safety precautions

Electronic and moving parts:

The following parts must not be handled or checked by the user:

- Electrical power supply (bottom of the instrument)
- Electronic components.

Operator injury may occur from an electric shock. Electronic components can shock and injure the user. Do not tamper with the instrument and do not remove any components (covers, doors, panels and so on) unless otherwise instructed within this document.

Moving parts: It is strictly forbidden to disable sensors as it may cause operator injuries. Protections covers must not be opened during instrument operations,

Danger! The battery may explode if it is not replaced correctly! Replace only with the same or equivalent type recommended by the manufacturer. Dispose of used batteries according to the manufacturer's instructions.

2.3 Biological risks

MICROS 60 OS/OT



Consider all Specimens, Reagents, Calibrators, Controls, etc... that contain human blood or serum as potentially infectious! Use established, good laboratory working practices when handling specimens. Wear protective gear, Gloves, Lab coats, Safety glasses and/or Face shields, and follow other bio-safety practices as specified in OSHA Blood borne Pathogens Rule (29 CFR part 1910. 1030) or equivalent bio-safety procedures.

ABX Diagnostics uses disinfectant product for instrument decontamination and highly recommends it to decontaminate your instrument (refer to: Instrument general cleaning to perform the instrument decontamination procedure).

Micros 60

2.4 Instrument general cleaning

2.4.1 Instrument external cleaning

The external surfaces of the instrument must be decontaminated considering the biological environment.

MICROS 60 OS/OT



- 1 - Never spill liquids on the instrument
- 2 - Never use Disinfectant product that contains alcohol

- **All contaminated surfaces (covers, counting assembly area,...):**

Slightly wet a sponge with disinfectant product (See 1) and wipe the dirty surfaces.

- **Stainless steel parts**

Slightly wet a sponge with disinfectant product (See 1) and wipe the dirty surfaces. Dry with a soft cloth.

1 Products having the following microbiological properties:

- .Bactericidal
- .Fungicidal
- .Active on *Aspergillus fumigatus*
- .Active on *Mycobacterium tuberculosis* (B.K)
- .Antiviral (VIH, HBV and rotavirus)

Product Example validated by ABX Diagnostics:

ANIOS detergent disinfectant ; WIP'ANIOS ; ref: 1316.424

MICROS 60 OS/OT



Please also refer to the W.H.O (World Health Organization) guidelines: «Laboratory Biosafety Manual, 2nd edition», for further information.

2.4.2 Instrument internal cleaning

- **Concentrated cleaning**

Counting chambers and hydraulics parts are decontaminated by using the «Concentrated cleaning» function as described in Section 6 (Maintenance and troubleshooting) page 5.

- **Sampling probe**

Sampling probe must be decontaminated as follows:

- 1- Prepare a solution of Sodium Hypochlorite to 100ml/l.
- 2- Fill a 5ml tube with this solution.
- 3- Run 5 analysis on bleach

MICROS 60 OS/OT



Please also refer to the W.H.O (World Health Organization) guidelines: «Laboratory Biosafety Manual, 2nd edition», for further information.

3. Working Conditions

3.1. Environment

The operation of the **ABX MICROS 60** should be restricted to indoor location use only! Operation of the instrument at altitudes of over 2000 Meters (6000 feet) is not recommended. The instrument is designed for safety from voltages surges according to INSTALLATION CATEGORY II and POLLUTION DEGREE 2(IEC EN 61010-1), Please contact your local ABX Diagnostics representative for information regarding operation locations, when it does not comply with the recommended specifications.

3.2. Location

The **ABX MICROS 60** should be placed on a clean and level table or workbench.

Please note that the **ABX MICROS 60**, printer, and reagent weights are approximately 30 kilograms (66 lbs.).

Avoid exposure to sunlight.

Proper ventilation requires adequate space behind the instrument. At least 20 cm (8 inches) must be maintained behind the instrument.

Place your instrument where it is not exposed to water or vapor.

Place your instrument where it is free from vibration or shock.

Place your instrument where an independent power receptacle can be used.

Use a receptacle different from the one used by a device that easily generate noise such as a centrifuge, etc...

Provide a space of at least 20 cm (8 inches) at the back of the instrument for arranging the power cable and tubings.

The Power switch and Input voltage supply connection should always be accessible!

When positioning the system for operational use, leave the required amount of space for easy accessibility to these items.

Micros 60

3.3. Grounding

Proper grounding is required when connecting the **ABX MICROS 60** to an electrical power outlet. Have the facilities electrician check that the (earth) ground connection is correct and solid. A dedicated outlet is the best connection possible for reduction of electronic interference. If there is “No” ground, then use a ground Stake. Current electrical safety standards must be applied when using the ground stake!

3.4. Humidity and Temperature Conditions

- The **ABX MICROS 60** must operate between temperature of 18 to 32°C, (65 to 90°F). Maximum relative humidity should be 80% for temperature up to 31°C (88°F) decreasing linearity to 50% relative humidity at 40°C (104°F). If it is kept at a temperature less than 10°C (50°F), the instrument should be allowed to sit for an hour at the correct room temperature before use.

3.5. Electromagnetic Environment Check

- The **ABX MICROS 60** has been designed to produce less than the required level of electromagnetic interference in order to operate in conformity with its destination. The electromagnetic interferences caused by the **ABX MICROS 60** are limited to a level allowing the correct operation of other instruments in conformity with their destination.
- In case of instrument problems, check that the instrument is not placed in proximity of electromagnetic fields, or short wave emissions (radars, X-rays, Scanners, Cell phones, etc...).

3.6. Environmental Protection

Disposal Used accessories and consumables:

Must be collected by a laboratory specialized in elimination and recycling of this kind of material according to the local legislation.

Disposal Micros 60 instrument:

It should be disposed of, in accordance with local legislation, and should be treated as being contaminated with blood. The appropriate biological precautions should be taken.

If any doubt, please contact your ABX Diagnostics representative service department.

3.7. Transportation and Storage Conditions























Storage temperature: -20°C +50°C

MICROS 60 OS/OT



Caution: Prior to the shipping of an instrument by transporter, whatever the destination, an external decontamination of the instrument must be carried out.

4. Graphics and Symbols

	Switch off position		Switch on position
	Alternative current		Manufacturer
	In Vitro Diagnostic Medical Device		This product conforms to the EEC directives and standards named in the Declaration of conformity
	Caution, consult accompanying documents		Biological risks
	Reagent		Up
	Fragile, Handle with care		Keep dry
	Do not stack		Temperature limitation
	Batch code		Catalogue number
	Use by		Consult Instructions before use
	Calibrator		Control
	Content		
	Ground		

MICROS 60 OS/OT



All graphics including screens and printouts, photographs are for illustrations purposes only and are not contractual.

5. Labels

5.1. Main power label

In order to replace the (2) 1A Fuses located under the power plug connection on the back of the analyzer, carry out the following procedure:

- Do Not remove the instrument protection cover.
- Power "OFF" the analyzer.
- Disconnect the main power cable from the back power cord receptacle on the analyzer.
- Pull open the little flap marked (250V fuse).
- Remove the fuses from their holding receptacle
- Check for the correct ohms on each fuse.
- Use only "Slow-blow" internal fuses.
- Use only fuses having the following characteristics:
 - for 100/120Vac supply: 1A 250V SB
 - for 220/240Vac supply: 1A 250V SB

5.2. Input/Output Label

Waste: Connect the waste output line to the (Waste position) fitting. Note the Waste label for Waste output "Only"!

Diluent: Connect the Diluent input line to the (Diluent position) fitting. Note the Diluent label for Diluent input "Only"!

Lyse: Connect the Clear tubing marked with a "MINILYSE" label to a straw and place it into the Lyse reagent container.

Miniclean: Connect the Blue tubing marked with a "MINICLEAN" label to a straw and place it into the Miniclean reagent container.

RS-232 output connection: Used only by **ABX DIAGNOSTICS** qualified Engineers.

Printer connection: Do Not connect any printer which has not been recommended by a **ABX DIAGNOSTICS** qualified Engineer.

5.3. Identification Label



6. Intended Use

The **ABX MICROS 60-OS/OT** is a fully automated (*Microprocessor controlled*) Hematology analyzer used for in-vitro diagnostics testing of Whole Blood specimens, Platelet PRP samples, and Whole Blood component concentrates.

MICROS 60 OS/OT



Important: When analyzing Whole Blood component concentrates, you must consider the Linear Range of the component parameter and its associated parameters if any! These concentrates may prematurely pollute the counting aperture when analyzing them. It is suggested that you perform 3 Backflushes and/or a Concentrated Cleaning after analyzing the concentrates!

The **ABX MICROS 60-OS/OT** is available in 5, 8, 16, and 18 parameters. These parameters are noted according to the system setup.

System Parameters and their specific meaning:

WBC	:	White Blood Cell count
RBC	:	Red Blood Cell count
HGB	:	Hemoglobin
HCT	:	Hematocrit
MCV	:	Mean Cell Volume
MCH	:	Mean Copuscular Hemoglobin
MCHC	:	Mean Corpuscular Hemoglobin Concentration
RDW	:	Red Cell distribution Width
PLT	:	Platelet count
MPV	:	Mean Platelet Volume
LYM %	:	Lymphocyte percentage
LYM #	:	Lymphocyte number
MON %	:	Monocyte percentage
MON #	:	Monocyte number
GRA %	:	Granulocyte percentage
GRA #	:	Granulocyte number
PDW*	:	* Platelet Distribution Width
PCT*	:	* Plateletcrit

MICROS 60 OS/OT



* Note: PCT and PDW have not been established as indications for this product, in the United States. The use of PCT and PDW should be restricted to Research Use Only.

The Rate of determination is approximately 60 samples per hour in the optimum configuration. The system is totally automated, including an internal dilution system, and a Graphic printer for recording all test results including flags and graphics.

7. Parameter Availability

Parameter setup availability options:

MICROS 60 Parameters	OS/OT-5	OS/OT-8	OS/OT-16	OS/OT-18
WBC	X	X	X	X
RBC	X	X	X	X
HGB	X	X	X	X
HCT	X	X	X	X
MCV	X	X	X	X
MCH		X	X	X
MCHC		X	X	X
RDW			X	X
PLT		X	X	X
MPV			X	X
LYM %			X	X
LYM #			X	X
MON %			X	X
MON #			X	X
GRA %			X	X
GRA #			X	X
*PCT				X
*PDW				X
WBC Distribution Curve			X	X
RBC Distribution Curve	X	X	X	X
PLT Distribution Curve		X	X	X

MICROS 60 OS/OT



* Note: PCT and PDW have not been established as indications for this product, in the United States. The use of PCT and PDW should be restricted to Research Use Only.

8. Presentation

The **ABX MICROS 60**, which is small in size, has 8 main parts.

- 1 - The Electrical supply.
- 2 - The Electronic Main board.
- 3 - The Dilution Pneumatics.
- 4 - The Control panel, including a key pad and LCD screen.
- 5 - A Reagent compartment.
- 6 - A Printer that prints out results and Distribution curves.
- 7 - A Smart Card Reader (optional) for Quality Control result records and Patient result records.
- 8 - A Barcode reader (optional) for a direct entry of the Alphanumerical identifications.

8.1. Micros 60 Models Available

The **ABX MICROS 60** is available in 4 different models as indicated:

- The **ABX MICROS 60-OT**: This model is an “Open Tube” unit “Without” a Smart Card reader. The operator must remove the cap from the blood collection tube before analyzing any sample.
- The **ABX MICROS 60-OS**: This model is an “Open Tube” unit “With” a Smart Card reader. The Smart Card reader gives the operator the ability to record results and perform automated Quality Control. The operator must remove the cap from the blood collection tube before analyzing any sample.
- The **ABX MICROS 60-CT**: This model is a “Closed Tube” unit “Without” a Smart Card reader. This unit has a Blood collection tube cap-piercing mechanism which allows the operator place the tube directly into the analyzer for analysis, without removing the cap.
- The **ABX MICROS 60-CS**: This model is a “Closed Tube” unit “With” a Smart Card reader. The Smart Card reader gives the operator the ability to record results and perform automated Quality Control. This unit has a Blood collection tube cap-piercing mechanism which allows the operator place the tube directly into the analyzer for analysis, without removing the cap.

Note: **OT, OS, CT, and CS** are indicated in the instrument Serial number that identifies the unit and model!

9. Installation

9.1. Inspection

A thorough inspection is carried out on the **ABX MICROS 60-OT** before sending it. We, nevertheless, recommend checking the total system as soon as it is received to report any anomalies to the carrier. The installation procedures must imperatively be followed in the order given below.

9.2. Unpacking

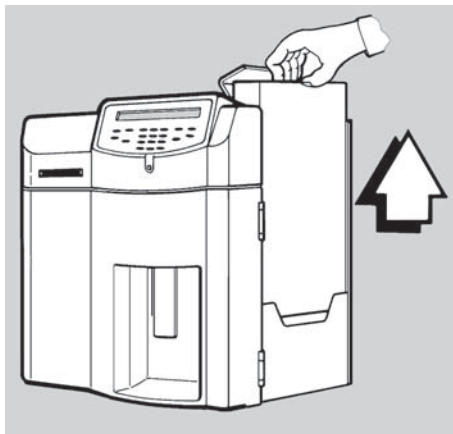

Diag.9.1

The instrument is enveloped in a special, protective foam before being placed in a cardboard box. Cut the four angles of the box to unpack the system. Remove the cardboard box containing the **ABX MICROS 60-OT** installation kit from its location (see Diag. 9.1).

Two different installation kits are available according to the instrument type :

- A **ABX MICROS 60-OT** "bottle" installation kit : XEA 314 A
- A **ABX MICROS 60-OT** "pack" installation kit : XEA 332 A

Two different printers are available according to the country specifications :

- Printer European model (230V, 50/60Hz) : XAA 398 A
- Printer US model (120V, 50/60Hz) : XAA 399 A

9.3. Package content

The **ABX MICROS 60-OT** boxes contain the following parts :

- **ABX MICROS 60-OT**
 - Printer
 - User's manual (english) : RAB 042 D
 - **ABX MICROS 60-OT** power cable (european) : DAC 011 A
- or
- **ABX MICROS 60-OT** power cable (US) : DAC 012 A

- The **ABX MICROS 60-OT** "bottle" installation kit (XEA 314 A) includes :

DESIGNATION	PART NUMBER	QTY
Reagent straw L=270 mm	XEA017A	3
Sampling needle ABX MICROS 60-OT	GBC069AS	1
Diluent/Waste male connector	EAC019A	2
Cristal tube 3x6	EAE011A	4
O' ring 6x1.5	FAA036A	1
O' ring 1.4x1.25	FAA0053A	2
Rubber stopper 2 holes	FBL001A	1
Reagent bottle stopper	XDA566A	2
ABX MICROS 60 common installation kit	XEA312A	1

The **ABX MICROS 60-OT** "pack" installation kit (XEA 332 A) includes :

DESIGNATION	PART NUMBER	QTY
Sampling needle ABX MICROS 60-CT	GBC069AS	1
O' ring 6x1.5	FAA036A	2
O' ring 0.74x1.02	FAA053A	2
ABX MICROS 60 common installation kit	XEA312A	1

Micros 60

9.4. Visual checks

9.4.1. Mechanical check



Diag.9.2

Using the key contained into the installation kit, turn the locker as shown on the Diag. 9.2 in order to open the pneumatic protection door.

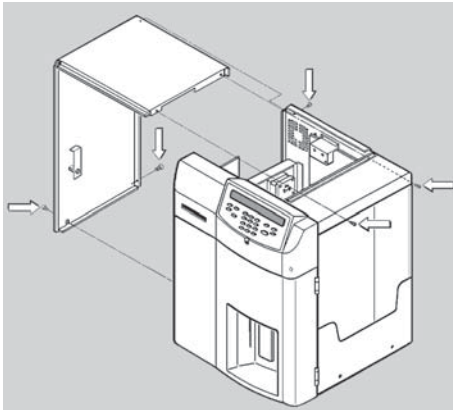

Diag. 9.3

Unscrew the 5 cover fixation screws and remove the cover : pull it backward and lift it up to the rear of the instrument (Diag. 9.3).

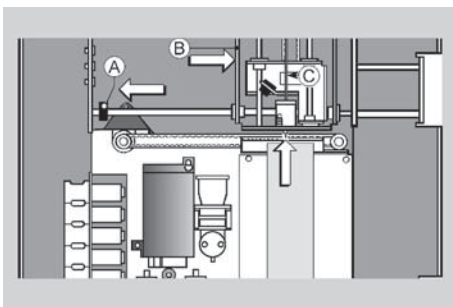

Diag. 9.4

Push the white plastic carriage locking clip (A) as far as possible to the left and place the sample needle carriage (B) as far forward as possible to the right-hand side, as shown in Diag. 9.4. Check that the needle (C) is not bent and make sure it is in its upper position.

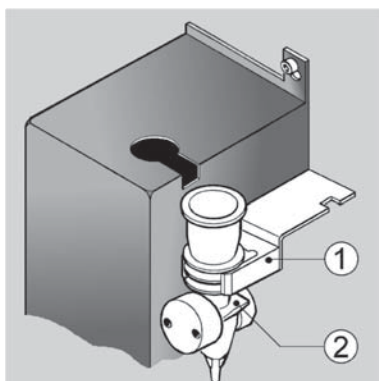

Diag. 9.5

Check the position of the RBC/PLT chamber as shown in Diag. 9.5. The chamber should be in its proper position with its clips and the electrode block is attached firmly to the RBC/PLT chamber.

1 - Clip 2 - RBC/PLT chamber

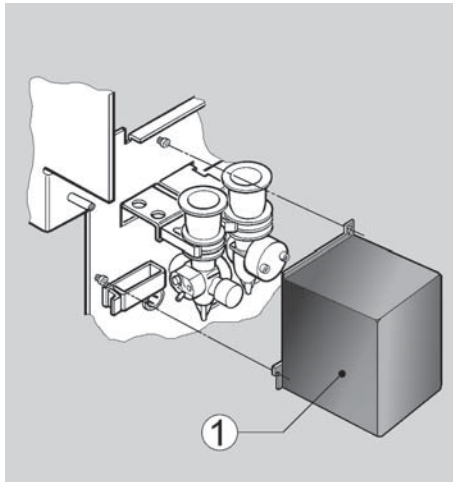

Diag. 9.6

Unscrew slightly the 2 screws of the WBC/Hgb chamber protection cover <1>. Remove the cover and check that the chamber is fixed properly in its clips and the electrode block is attached firmly to the chamber (Diag. 9.6).

Re-install the HGB/WBC chamber cover

9.4.2. Connection check

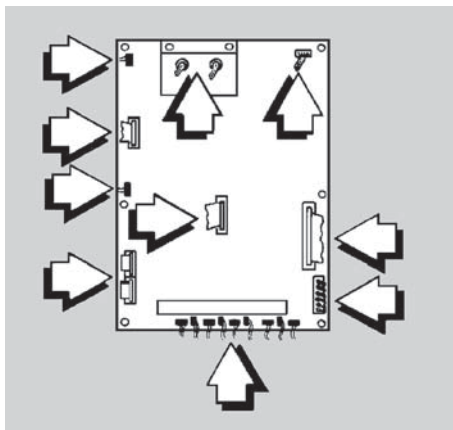

Diag. 9.7

Check that the connectors on the printed circuit board are securely in place (Diag. 9.7).

Re-install the instrument cover.

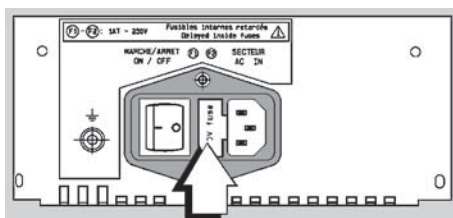

Diag. 9.8

Remove the fuse holder from its location on the rear panel pressing on the holder lock (Diag. 9.8) and check the fuse characteristics : they should be 1 Ampere, 250 Volts Slow-Blow.

Micros 60

9.5. Reagent connections

Two reagent packages are available :

- Bottles and containers.
- Reagent pack.

9.5.1. Bottle connections

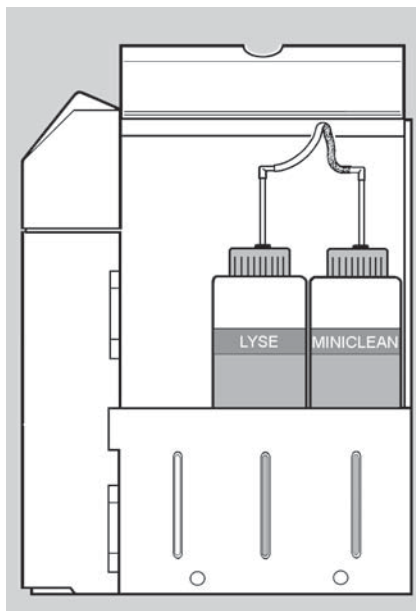

Diag. 9.9

Lyse and cleaning reagents are placed inside the reagent compartment as shown in the Diag. 9.9. Install the reagent straws and the bottle stoppers. Connect the blue tube to the MINICLEAN bottle and the white tube to the LYSE bottle. Close the compartment cover.

MICROS 60 OS/OT



Important: When the ABX MICROS 60-OT is set up with the 16 or 18 parameters mode, it is mandatory to use specific LYSE LMG and MINIDIL LMG

MICROS 60 OS/OT



The Diluent container will be located on the bench at the same level than the instrument.

9.5.2. Waste connection

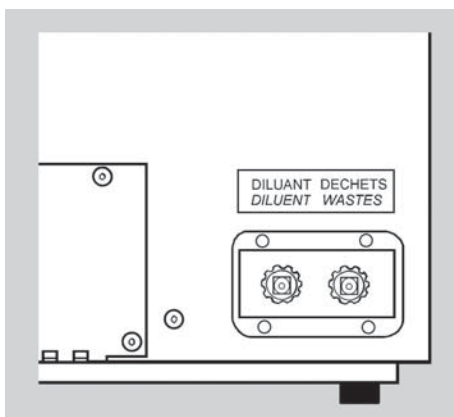

Diag. 9.10

Install the male connectors included in the installation kit at the liquid input and output located at the bottom of the instrument rear panel (Diag. 9.10).

Connect the diluent container (see CAUTION above) using the diluent straw and a 3x6 cristal tube (1 meter maximum) on the diluent input located at the bottom of the instrument rear panel (Diag. 2.10). Connect the waste container using the cristal tube 3 x 6 on the waste output, and place the waste container below the instrument level (under the bench).

MICROS 60 OS/OT



Warning: If required, waste can be neutralized before being discarded. Follow your laboratory's protocol when neutralizing and disposing of waste. Dispose of the waste container according to the local or national regulatory requirements

9.5.3. Reagent pack connection

The Reagent Pack includes the entire set of reagents in a "Pack" and is able to receive the waste liquids. Three soft pockets contain the 3 reagents MINIDIL LMG, MINICLEAN and LYSE LMG and are closed by means of the valve connectors located at the bottom of the pack. The fourth pocket is empty and is intended for receiving waste liquids. Remove the reagent output protections, as well as the waste input protection (Diag.9.11)

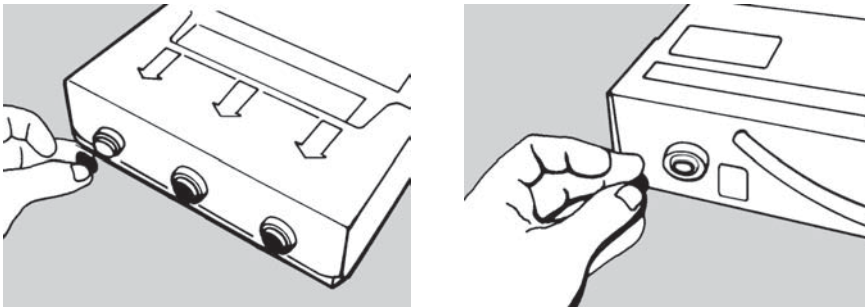

Diag. 9.11

Install the pack directly into the compartment of the instrument as shown on the Diag. 9.12. Push the pack down in order to plug correctly the pack on the male connectors.

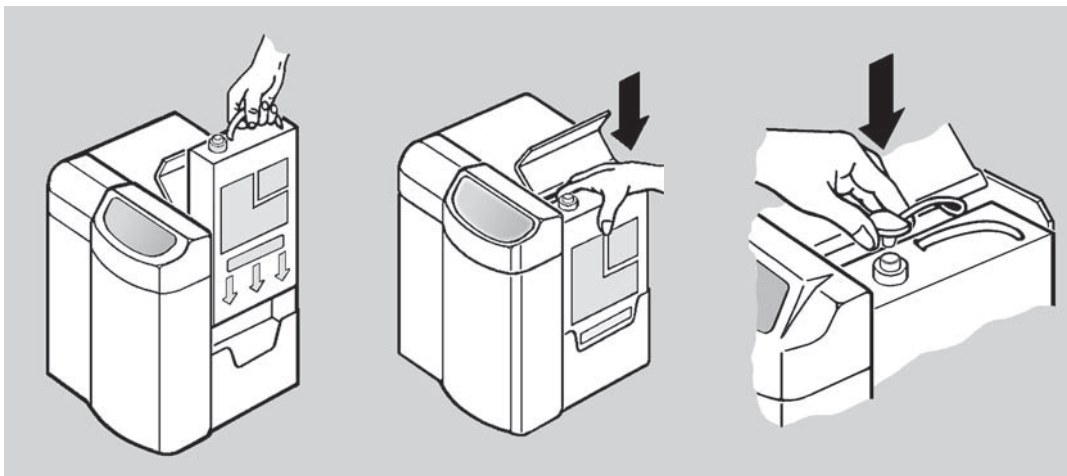

Diag. 9.12

The free male connector (see Diag. 9.12) must be plugged on the pack upper valve in order to receive the waste liquids.

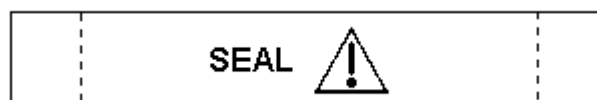

Diag. 9.13

MICROS 60 OS/OT



Warning: If Seal (Diag.9.13) is broken, this Minipack should be treated as a Biohazardous Waste.



Warning: In order to avoid leak problems it is recommended not to unplug several times the same reagent pack.

9.6. Reagent Waste Handling Precautions

Reagents have to be stored at room temperature (15°C to 25°C; 59°F to 77°F). Operating conditions are given in section 2.4. Lyse reagent contains cyanides and have to be handled according to the local or national regulations. Always follow the recommended precautions (see section 3.3 for the reagent specifications).



Note: For instruments equipped with the reagent pack, all the waste generated is collected during testing to facilitate compliance with the latest environmental regulations.

9.7. Electrical connections

The **ABX MICROS 60-OT** is connected to the laboratory electrical supply using the power cable included in the installation kit. Connect the power cable to the plug located on the rear left-hand side of the device (Diag. 9.13).

Two 1A fuses are located, under the power plug. The instrument can be operated at any other voltage (from 100 to 240V) or frequency (from 50 to 60Hz) without modification.

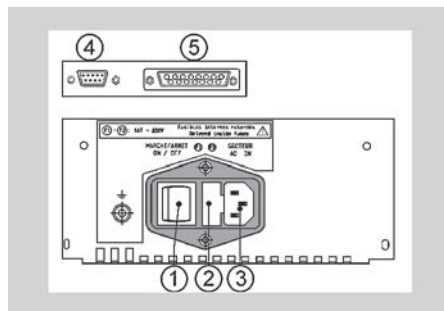

- 1 - ON/OFF SWITCH
- 2 - FUSE HOLDER
- 3 - MAIN SUPPLY PLUG
- 4 - RS232 OUTPUT
- 5 - PRINTER OUTPUT

Diag. 9.13

If the instrument has to be connected to a laboratory computer, use the plug (4) RS232.

9.8. Printer



Caution: It is mandatory to connect a printer which fulfills the following conditions :

- the printer is recommended by an *ABX Diagnostics* authorized technician,
- the printer is compatible with IEC standards.
- the printer is a listed printer.

9.9. Reagent priming

When the **ABX MICROS 60-07** is first installed, it contains no reagents. All the reagents have to be primed now. Turn ON instrument by pressing the ON/OFF switch located on the rear panel. When the instrument turns on, the display shows :

PLEASE WAIT FOR 3 MIN
ESCAPE : ESC

This time is required at the startup for the instrument initialization and stabilization, specifically for the HGB diode to reach its operational temperature. After three minutes, the LED of the front panel turns from red to green and the display shows the following :

STARTUP NOT INITIATED
PRESS A KEY TO CONTINUE...

This message appears when the instrument is setup with the manual startup cycle to prevent any analysis cycle before running a startup cycle. Press any key, the main menu is displayed :

MAIN MENU 1 RESULTS
HH : MM 2 QC

9.9.1. Bottles and containers set

Install the reagent bottle and carry out a PRIME cycle to clear the reagent line of air bubbles. This procedure should be done whenever a new bottle of reagent is installed.

From the MAIN MENU, move the cursor to the function **4** SERVICE and press ENTER. The service menu is displayed :

SERVICE 1 BACK FLUSH
HH : MM 2 DRAIN CHAMBERS ▼

Move the cursor to function **3** PRIME REAGENTS and press ENTER. The PRIME menu is displayed :

PRIME 1 ALL REAGENTS
HH : MM 2 DILUENT ▼

Select either the function **1** prime ALL REAGENTS or move the cursor next to the required reagent and press ENTER.

Micros 60

ALL REAGENTS WAIT FOR 2 MN 3 S

MICROS 60 OS/OT

 **Important:** Before analyzing samples, visually inspect reagent lines and pumps for air bubbles. Repeat priming if air bubbles are still present. Call the *ABX representative service department* if priming does not eliminate air bubbles.

MICROS 60 OS/OT

 **Caution:** Never initiate two Lyse prime cycles back-to-back. This causes excessive foaming in the waste chamber. Run a blank cycle between each Lyse prime cycle.

9.9.2. Reagent pack

From the MAIN MENU, move the cursor to the function **4** SERVICE and press ENTER.

The service menu is displayed :

SERVICE > 2 DRAIN CHAMBER ▲
HH : MM 3 PRIME REAGENTS ▼

Move the cursor to **3** PRIME REAGENTS and press the ENTER key. Select the function

1 CHANGE PACK and follow the instructions given by the LCD in order to install the pack.

REAGENT PACK > 1 CHANGE PACK
HH : MM 2 CBC LEFT < 150> ▼

Once the new PACK is installed a priming cycle will be automatically carried out and the following menu is displayed.

PRIME WAIT FOR 2 MIN 3 S

MICROS 60 OS/OT

 **Important:** Before analyzing samples, visually inspect reagent lines and pumps for air bubbles. Repeat priming if air bubbles are still present. Call the *ABX representative service department* if priming does not eliminate air bubbles.

From the REAGENT PACK menu, the function **2** "CBC LEFT" displays the number of analysis cycles left to run with the same pack.

It is also possible to run a priming cycle at any time using the selection **3** "PRIME REAGENTS" of the SERVICE menu.

MICROS 60 OS/OT



Caution: It is recommended not to remove the pack several times before the reagents are totally used in order to avoid leak problems.

10. Manual Contents

section 1: Specifications

section 2: Description & Technology

section 3: Startup and Sample Run

section 4: Calibration and Quality Control

section 5: Instrument Configuration

section 6: Maintenance & Troubleshooting

Contents

1. Technical Specifications (V1.6)	2
1.1. Parameters	2
1.2. Throughput Analysis	4
1.3. Memory Capacity (Smart Cards)	4
1.4. Statistics and Quality Control	4
1.5. Reagents	4
1.6. Calibration	4
1.7. Measurements and Computation	4
1.8. Outputs	4
1.9. Display	4
1.10. Barcode Reader Options	4
2. Physical Specifications	5
2.1. Power Requirements	5
2.2. Operating Temperature/Humidity	5
2.3. Dimensions and Weight	5
2.4. Wastes	5
2.5. Minimum Sample Volume	5
2.6. Dilution Ratios	5
2.7. Counting Aperture Diameter	5
2.8. Hemoglobin Measurement	5
3. Summary of Performance Data (V1.6)	6
3.1. Precision (Reproducibility)*	6
3.2. Precision Claims*	7
3.3. Precision (Repeatability)	7
3.4. Linearity*	9
3.5. Carry-over:	9
3.6. Normal Ranges	10
3.7. Accuracy	11
3.8. Leucocytes Differential count	11
3.9. Sample stability study	11
4. Limitations	12
4.1. Maintenance	12
4.2. Blood Specimens	12
4.3. Known Interfering Substances	14
5. Reagent Specifications	19
5.1. General Recommendations	19
6. Waste Handling Procedure	20
7. Reagent Consumption	20

1. Technical Specifications (V1.6)

- WBC, RBC, and PLT Histograms
- Quantitative Flags
- Parameter selection by choice of Software

MICROS 60 OS/OT



Note: The **ABX MICROS 60 OS/OT** performs automated blood counts and requires No manual operations for aspirating blood, dilutions, measuring, calculations, print-outs, and computer transfer of data. The parameters are given according to the Internal Setup

1.1. Parameters

ABX MICROS 60 OS/OT-5	
5 - Parameters	
WBC	White Blood Cells
RBC	Red Blood Cells
HGB	Hemoglobin
HCT	Hematocrit
MPV	Mean Platelet Volume
RBC Distribution Curve	

ABX MICROS 60 OS/OT-8	
8 - Parameters	
WBC	White blood cells
RBC	Red blood cells
HGB	Hemoglobin
HCT	Hematocrit
MCV	Mean Corpuscular Volume
MCH	Mean Corpuscular Hemoglobin
MCHC	Mean Corpuscular Hemoglobin Concentration
PLT	Platelets
RBC and PLT Distribution Curves	

Specifications

ABX MICROS 60 OS/OT-16	
16 - Parameters	
WBC	White blood cells
LYM %	Lymphocyte Percentage
LYM #	Lymphocyte Absolute number
MON %	Monocyte Percentage
MON #	Monocyte Absolute number
GRA %	Granulocyte Percentage
GRA #	Granulocyte Absolute number
RBC	Red blood cells
HGB	Hemoglobin
HCT	Hematocrit
MCV	Mean Corpuscular Volume
MCH	Mean Corpuscular Hemoglobin
MCHC	Mean Corpuscular Hemoglobin Concentration
RDW	Red cell Distribution Width
PLT	Platelets
MPV	Mean Platelet Volume
WBC, RBC, and PLT Distribution Curves	

ABX MICROS 60 OS/OT-18	
18 - Parameters	
WBC	White blood cells
LYM %	Lymphocyte Percentage
LYM #	Lymphocyte Absolute number
MON %	Monocyte Percentage
MON #	Monocyte Absolute number
GRA %	Granulocyte Percentage
GRA #	Granulocyte Absolute number
RBC	Red blood cells
HGB	Hemoglobin
HCT	Hematocrit
MCV	Mean Corpuscular Volume
MCH	Mean Corpuscular Hemoglobin
MCHC	Mean Corpuscular Hemoglobin Concentration
RDW	Red cell Distribution Width
PLT	Platelets
MPV	Mean Platelet Volume
PDW	Platelet Distribution Width
PCT	Plateletcrit
WBC, RBC, and PLT Distribution Curves	

MICROS 60 OS/OT



Note: PCT and PDW are Not available in the United States. These parameters are Strictly used for research and investigational purposes “Only”!

1.2. Throughput Analysis

- Approximately 60 Samples/ hour.

1.3. Memory Capacity (*Smart Cards*)

- Last sample “ONLY” Internal Memory capacity
- 60 Samples Memory Smart Card option
- 99 Samples Quality Control Smart Card option

1.4. Statistics and Quality Control

- Extended Quality Control package (Optional).
- Quality Control Smart Card option.

1.5. Reagents

3 Reagents, 1 Pack of Reagents

- **ABX MINIDIL LMG** (10L)
- **ABX MINICLEAN** (1L)
- **ABX LYSE** (0.4L)
- **ABX MINIPAK LMG** (4.2L)

ABX Minipak contains all 3 Reagents for a Total Volume of 4.2L

1.6. Calibration

- Automatic Calibration procedure.
- Direct entering of Calibration Coefficients.

1.7. Measurements and Computation

- Impedance change for WBC, RBC, PLT
- Spectrophotometry for HGB
- Impedance change for LYM%, MON%, GRA%
- Computation from stored Data that was directly measured for MCV, MCH, MCHC, RDW, MPV, LYM#, MON#, GRA#

1.8. Outputs

- Hard Copy printing
- External output (RS232)

1.9. Display

LCD Screen: 2 Lines of 40 Characters, Backlighted

1.10. Barcode Reader Options

EAN 8, EAN 13, C 39, C 128, ITF (2of5), CODABAR, STF, and C 93 with or without Checksum.

2. Physical Specifications

2.1. Power Requirements

- Power supply: 100V, 110V (+/- 10%)
220V, 240V (+/- 10%)
50/60Hz
- Power Consumption: Maximum: 150Vac (-30%, +10%)
In use: 110Vac (-30%, +10%)
Stand-by mode: 35Vac (-30%, +10%)

2.2. Operating Temperature/Humidity

- 18 to 32°C or 65 to 90°F
- Maximum relative Humidity, 80% for temperatures up to 31°C or 88°F.
- Decreasing linearity to 50% relative Humidity at 40°C of 104°F.
- Avoid exposure to direct Sunlight.
- Avoid exposure to Air conditioning and or Heating ducts.

2.3. Dimensions and Weight

- Height: Approximately 440mm (16.5 inches)
- Width: Approximately 360mm (14.2 inches)
- Depth: Approximately 330mm (12.6 inches)
- Weight: Approximately 14Kgs (31 lbs)

2.4. Wastes

- Automatic disposal.
- Waste handling according to Local/National regulations.

2.5. Minimum Sample Volume

- Minimum blood sample requirement: 50µl
- Analyzer sample volume: 10µl

2.6. Dilution Ratios

- WBC: Approximately 1/250
- RBC/PLT: Approximately 1/15000

2.7. Counting Aperture Diameter

- WBC: 80µm
- RBC: 50µm

2.8. Hemoglobin Measurement

- Performed in the WBC/HGB Chamber
- Light source: LED(Light Emiting Diode) at Wavelength 550nm

3. Summary of Performance Data (V1.6)

3.1. Precision (Reproducibility)*

The Micros 60 was initially calibrated with Minocal Calibrator (Lot N° MCAL 325 Expiry Date: 11-05-2002).

Three levels of ABX Minotrol 16 control material (Lot N°: M243) were run in duplicate twice daily for 20 days. The results were used to quantify within run precision, SD of the run means, SD of the daily means, and the Total Imprecision with the NCCLS EP-5 Guidelines.

Parameter	MINOTROL 16 Control	Within run SD	SD of run Means	SD of Daily Means	Total imprecision SD
WBC	M243 High	0.23	0.20	0.19	0.29
	M243 Normal	0.10	0.08	0.11	0.14
	M243 Low	0.06	0.03	0.04	0.06
RBC	M243 High	0.05	0.04	0.04	0.06
	M243 Normal	0.05	0.04	0.04	0.06
	M243 Low	0.04	0.03	0.03	0.04
HGB	M243 High	0.31	0.23	0.40	0.49
	M243 Normal	0.12	0.16	0.43	0.45
	M243 Low	0.09	0.22	0.29	0.33
HCT	M243 High	0.52	0.79	0.96	1.17
	M243 Normal	0.56	0.51	0.74	0.91
	M243 Low	0.26	0.26	0.32	0.42
PLT	M243 High	13.71	6.49	9.07	14.04
	M243 Normal	9.17	7.23	5.87	10.13
	M243 Low	5.83	3.78	3.69	4.97

Parameter	MINOTROL 16 Control	Within run CV%	CV% of run Means	CV% of Daily Means	Total imprecision (CV%)
WBC	M243 High	1.19	1.01	0.96	1.46
	M243 Normal	1.39	1.11	1.46	1.93
	M243 Low	3.06	1.68	1.93	3.13
RBC	M243 High	0.9	0.62	0.78	1.1
	M243 Normal	1.02	0.88	0.8	1.24
	M243 Low	1.46	1.07	1.15	1.72
HGB	M243 High	1.72	1.28	2.23	2.7
	M243 Normal	0.85	1.17	3.17	3.33
	M243 Low	1.49	3.5	4.65	5.37
HCT	M243 High	1.06	1.62	1.96	2.39
	M243 Normal	1.51	1.38	2	2.47
	M243 Low	1.6	1.6	1.96	2.53
PLT	M243 High	2.89	1.37	1.91	2.96
	M243 Normal	9.17	7.23	5.87	10.13
	M243 Low	5.14	6.87	6.70	9.04

*Source 510K submission # K030799

Evaluation of Precision Performance of Clinical Chemistry Devices; Approved Guidelines, NCCLS document EP-5 (ISBN 1-56238-145-8) 1999.

3.2. Precision Claims*

Parameters	%CV	Nominal Values
WBC	<2.5%	10.0 x 10 ³ /μL
RBC	<2.0%	5 x 10 ⁶ /μL
HGB	<1.5%	15 g /dL
HCT	<2.0%	45 %
PLT	<5.0%	300 x 10 ³ /μL

*Source 510K submission # K030799

3.3. Precision (Repeatability)

Based on (20) consecutive samplings from (1) Fresh Normal Whole Blood, without any alarms.

Precision Table: N = 20		
Parameters	%CV	Test Level
WBC	<2.5%	10.0 x 10 ³ /μL
RBC	<2.0%	5 x 10 ⁶ /μL
HGB	<1.5%	15 g /dL
HCT	<2.0%	45 %
PLT	<5.0%	300 x 10 ³ /μL

3.4. Linearity*

•**Linearity range:** The Manufacturer’s tested linearity zone of the instrument using linearity kits and/or human blood.

•**Linearity limits:** Maximum and minimum values within the instrument returns no dilution alarm.

•**Visible Range:** Range values given by the instrument. These values (above linearity limits) are given as an indication. They are given associated with a “D” flag. This Visible range is outside Manufacturer’s range.

•Linearity Kits:

Linearity was tested using available “Low Range” and “Full Range” Linearity Test kits. The Test kits were analyzed and data was computed according to the Manufacturer’s instructions.

•Human Blood:

Linearity was also obtained on human blood, using a minimum of 5 dilution point. The results of this study are as followed:

Parameters	Linearity Range	Linearity limits	Visible Range	Difference (Which ever is greater)	
WBC ($10^3/mm^3$)	0.5 - 122	0 - 100	100 - 150	± 0.3	± 5 %
RBC ($10^6/mm^3$)	0.2 - 8.7	0 - 8	8 - 18	± 0.07	± 3 %
PLT ($10^3/mm^3$) (A)	10 - 2327	0 - 2200	2200 - 6000	± 10	± 10%
PLT ($10^3/mm^3$) (B)	25 - 4990	0 - 4000	4000 - 6000	± 10	± 10%
HGB (g/dL)	2.0 - 27	0 - 26	26 - 30	± 0.3	± 3 %
HCT (%)	1.8 - 82.3	0 - 80	80 - 90	± 2.0	± 3 %

A: for HGB > 2 g/dL and RBC > $0.5 \times 10^6/\mu L$

B: for HGB < 2 g/dL and RBC > $0.5 \times 10^6/\mu L$

*Source 510K submission # K030799

3.5. Carry-over:

Carry-over was tested by analyzing samples with “High Concentrations” of WBC’s, RBC’s, HGB, and PLT’s. Each sample was analyzed in triplicate, followed by (3) Background cycles. The % Carry-over is calculated by using the following formula:

$$\text{Carry-over} = \frac{\text{Background1} - \text{Background3}}{\text{Sample3} - \text{Background3}} \times 100$$

Parameters, Units	WBC 10 ³ /mm ³	RBC 10 ⁶ /mm ³	HGB g/dl	PLT 10 ³ /mm ³
Blood count Level	63.0	7.58	23.4	988
% Carry-over (Actual)	0.3	0.00	0.0	0.0
% Carry-over (Claimed)	< 0.5%	<0.5%	<0.5%	<0.5%

Micros 60

3.6. Normal Ranges

These Normal ranges were established from a study performed in Somerville, NJ. (U.S.A.) This study encompasses the central 95% of the values, in the distribution of (43) Normal, Healthy, and Drug Free individuals. These Ranges are as followed:

Parameters	Male (N=21)	Female (N=22)
WBC (10 ³ /mm ³)	4.7 - 9.6	4.9 - 12.3
Lymphocytes (%)	23 - 47	19 - 41
Monocytes (%)	3 - 6	2 - 6
Granulocytes (%)	49 - 74	53 - 79
RBC (10 ⁶ /mm ³)	4.37 - 5.63	3.90 - 5.10
HGB (g/dl)	13.5 - 16.5	12.0 - 15.0
HCT (%)	41 - 50	37 - 45
MCV (μm ³)	83 - 101	84 - 96
MCH (pg)	26 - 34	27 - 34
MCHC (g/dl)	32 - 35	32 - 35
RDW (%)	12 - 16	12 - 14
PLT (10 ³ /mm ³)	145 - 355	150 - 330
MPV (μm ³)	7.3 - 9.0	8 - 10

PCT and PDW have not been established as indications for this product, in the United States. The use of PCT and PDW should be restricted to Research Use Only.

MICROS 60 OS/OT



Important: Expected values will vary with sample population and/or geographical location. It is highly recommended that each Laboratory establish its own Normal ranges based upon the local population!

3.7. Accuracy

The Accuracy performance was proven by analyzing approximately (200) patient specimens on the **ABX MICROS 60** along with a commercially available Reference Analyzer, located in (3) different locations throughout the United States. The following table summarizes the data:

Parameters	Site 1		Site 2		Site 3	
	n	R ²	n	R ²	n	R ²
WBC (10 ³ mm ³)	198	0.992	209	0.997	203	0.995
RBC (10 ⁶ mm ³)	198	0.995	212	0.995	204	0.990
HGB (g/dl)	188	0.994	212	0.998	204	0.985
HCT (%)	198	0.980	212	0.994	204	0.982
MCV (µm ³)	198	0.988	212	0.987	204	0.980
MCH (pg)	188	0.969	212	0.962	204	0.962
MCHC (g/dl)	188	0.311	212	0.654	204	0.471
RDW (%)	198	0.950	212	0.944	204	0.895
PLT (10 ³ mm ³)	169	0.994	201	0.981	198	0.926
MPV (µm ³)	191	0.639	204	0.709	203	0.863
Lymphocytes (%)	98	0.975	110	0.991	119	0.461
Monocytes (%)	98	0.552	104	0.787	119	0.461
Granulocytes (%)	98	0.969	105	0.990	119	0.968
Reference Analyzers	Baker System 9000		Coulter S Plus IV		Coulter JT	

n: Number of specimens analyzed

R²: Correlation coefficient from the regression curve Reference/**ABX MICROS 60**

As mentioned above, this clinical study was performed at (3) different sites throughout the United States.

3.8. Leucocytes Differential count

Not available at the time of publication

3.9. Sample stability study

Not available at the time of publication

4. Limitations

MICROS 60 OS/OT



WARNING: Whilst every effort is taken by ABX Diagnostics to investigate and indicate all known interference's, it is by no means possible to guarantee that all interference's have been identified. At all times, results should be validated and communicated only once all information relating to the patient has been assessed and taken into account.

4.1. Maintenance

In this Manual, specific Start-up, Shutdown, and Maintenance procedures are listed. The Maintenance procedures listed in this manual are mandatory for the proper use and operation of the **ABX MICROS 60**.

MICROS 60 OS/OT



Caution: Failure to execute any of these maintenance procedures may result in "Decreased Reliability" of the system. High emphasis on maintaining the system is strongly suggested!

4.2. Blood Specimens

• Sample Collection and mixing

All Blood samples should be collected using proper technique!

MICROS 60 OS/OT



WARNING: Potential Biohazard!

Consider all Specimens, Reagents, Calibrators, Controls, etc... that contain Human blood or serum as potentially infectious! Use established, good laboratory working practices when handling specimens. Wear protective gear, Gloves, Lab coats, Safety glasses or Face shields, and follow other biosafety practices as specified in OSHA Bloodborne Pathogen Rule (29 CFR Part 1910, 1030) or other equivalent biosafety procedures.



When collecting blood specimens, Venous blood is recommended, but Arterial blood may also be used in extreme cases. Blood collection must be placed in Vacuum or atmospheric sample collection tubes.

• Sample Collection and mixing continued:

MICROS 60 OS/OT



Note: (For USA Only). For additional information on collecting venous and capillary samples, refer to NCCLS document H3-A4 and NCCLS document H4-A4 (sept. 1999)

MICROS 60 OS/OT



Important: The sample collection tube must be filled to the exact quantity of blood indicated on the tube itself. Any incorrectly measured blood sample collections will show a variation in results.

• Sample Stability

Fresh Whole Blood specimens are recommended! The ICSH (*International Committee for Standardization in Hematology*) defines a Fresh blood specimen as “One processed within 4 hours after collection”.

Well mixed Whole Blood specimens, collected in EDTA anti-coagulant and run within eight hours after collection, provide the most accurate results for all parameters. The White cell size distribution may shift when specimens are assayed between **5 and 20 Minutes** after collection and more than **8** hours after collection.

• Anti-coagulants and their effects: (on Whole Blood)

MICROS 60 OS/OT



Caution: Anti-Coagulants used in blood collection may vary in the effects of changing the characteristics of the blood components. Caution is advised when selecting an anti-coagulant for analysis on the **ABX MICROS 60**.

This is a list of commonly used anti-coagulants used for whole blood collections:

- **Heparin:** Causes an increase in cell clumping, (WBC's and PLT's) and modifies cytoplasmic color with Romanowsky staining (Blue background).
An increase in HCT and MCV with high Heparin concentrations > 7.5UL /capillary tube.

- **Trisodium Citrate:** Because the anti-coagulant is liquid, it includes a dilution estimated at 10/11 when filling 5ml tubes with whole blood. This anti-coagulant is used in Coagulation. It is sometimes used in Hematology when an EDTA - induced *Pseudothrombocytopenia* is suspected.

- **Acid Citrate Dextrose (ACD) and Citrate Phosphate Dextrose with Adenine (CPDA):** The most commonly used anti-coagulants for cell concentrates (in particular Platelet concentrates) is normally not used for cell counting. There is no seriously known interference.

- **EDTA:** Among the EDTA salts, EDTA K₂ (USA and Japan), EDTA K₃ (USA and Europe), and sometimes NA₂ EDTA are used. EDTA K₂ and EDTA K₃ are the most frequently used anti-coagulants for Hematology testing Worldwide. Mainly because they have been recommended by ICSH since 1993. The other EDTA salts are acceptable as well. EDTA can include *Pseudothrombocytopenia* (estimated frequency : 1/800) through Platelet clumping.

- **Fluoride:** Was used before EDTA replaced it. NO side affects as known so far.

• Sample collection tube Caps

Some sample collection tube Caps are more adaptable to “Cap-piercing” sampling systems. Obviously, Plastic caps cannot be used. Rubber caps can have a variation of materials that they are made from. It is highly recommended to use the best quality of material in order to avoid any rubber particles entering the sample tube when piercing the tube. It is also recommended to use caps specifically designed to avoid any blood retention in the upper portion of the cap!

4.3. Known Interfering Substances

MICROS 60 OS/OT



Note: Verification of any “Abnormal” test result, (*including Flagged results or results Outside their normal range*) should be performed using Reference methods or other Standard Laboratory procedures for the conclusive verification of these abnormal results. The section below starts the list of the known limitations of automated blood cell counters which use the principle of Impedence.

- **WBC White Blood Cells (Leukocytes)**

WBC results that exceed the linearity limits of the system will require a Dilution of the blood sample. Re-assaying the diluted blood sample will help to obtain the correct assay value. As in some Leukemia patients.

NRBC - Immature (Nucleated Red Blood Cells) will be counted in the WBC (*White Blood Cell*) parameter. If the number of Nucleated Red Blood cells is sufficient enough to activate an “L1 Alarm”, such interference will be detected. However, a Manual differential white blood cell count, performed on a stained blood smear, will confirm the presence of NRBC’s.

Following the Manual differential white blood cell count, the WBC assay value “Must be corrected to subtract the NRBC’s from the total white blood cell count. This will give a true and correct count of the actual WBC’s.

When NRBC’s are present in the WBC count, the formula for correcting the WBC parameter is as followed:

$$\text{Corrected WBC} = \frac{\text{Counted WBC's} \times 100}{100 + (\# \text{ of NRBC's}/100 \text{ WBC})}$$

- **WBC White Blood Cells (Leukocytes)** continued:

Non-lysed Red Cells - In particularly rare instances, the erythrocytes in the blood sample may not completely lyse when lysing reagent is added in the WBC Chamber. These non-lysed Red blood cells may be detected on the WBC Histogram with an “L1 Alarm” or as an elevated baseline on the (*Left leading edge*) of the Lymphocytes population in the WBC Histogram. Non-lysed erythrocytes will also cause a falsely elevated WBC count.

Multiple Myeloma - The precipitation of proteins in Multiple Myeloma patients may give elevated WBC counts.

Hemolysis - Hemolyzed specimens contain Red cell Stroma which may elevate WBC counts.

Leukemia - A very low WBC count may result in this disease state because of possible increased fragility of the leukocytes leading to some destruction of these cells during counting. These white cell fragments will also interfere with the white cell partial differential parameters: LYM % and #, MON % and #, GRA % and #. A suspiciously low WBC count may also be seen in patients with Lymphocytic Leukemias due to the presence of abnormally “Small” lymphocytes which may not be counted by the instrument.

Chemotherapy - Cytotoxins and Immunosuppressive drugs may increase the fragility of the leukocytes which may cause low WBC counts.

- **WBC White Blood Cells (Leukocytes)** continued:

Cryoglobulins - Increased levels of Cryoglobulins that may be associated with Myeloma, Carcinoma, Leukemia, Macroglobulinemia, Lymphoproliferative disorders, Metastatic tumors, Auto-immune disorders, Infections, Idiopathic disease, Aneurism, Pregnancy, Thromboembolic phenomena, Diabetes,etc, which can elevate the WBC, RBC, and PLT counts along with the HGB value. The specimen can be warmed up to 37°C and re-analyzed immediately. If warming the specimen has no effect on the count, a Manual WBC, RBC, and or PLT count can be performed.

Increased Turbidity - may also be seen in cases where the red blood cells are resistant to the lysing action. This condition will cause a falsely elevated Hemoglobin result, but may be detected by observing the abnormal MCH and MCHC values, also the increased baseline on the (*Left leading edge*) of the WBC Histogram. Erroneous Hemoglobin results will also cause the results of the MCH and MCHC to be erroneous as well.

Fetal Bloods - The mixing of fetal and maternal bloods may produce a falsely elevated Hemoglobin value.

- **HCT (Hematocrit)**

Red Blood cell Agglutination - May produce erroneous HCT and MCV values. Red blood cells agglutination may be detected by observing abnormal MCH and MCHC values, as well as examination of a stained blood smear in such cases. Manual Laboratory methods may be required to obtain an accurate HCT value.

- **RBC Red Blood Cells (Erythrocytes)**

The Red blood cell dilution contains all the formed elements in the blood: Erythrocytes, Leukocytes, and Platelets. During the counting of the RBC's, Platelets are below the RBC size Minimum Threshold, therefore they are not counted as RBC's.

Leukocytes - (White Blood cells) on the other hand, are included in the RBC count. However, since the normal ratio between Red blood cells and White blood cells is so extreme, the influence of counting the WBC's during the RBC count is negligible.

High WBC's - In rare cases where the WBC's are extremely high, the RBC count may be corrected, especially if the RBC count is extremely low in comparison to the high WBC count.

Agglutinated Red Blood cells - May cause a falsely low RBC count. Blood samples containing the agglutinated Red blood cells may be identified by observing abnormal MCH and MCHC values, as well as examination of a stained blood smear.

Cold Agglutinins - IgM Immunoglobulins which are elevated in Cold Agglutinins disease, may lower RBC and PLT counts and increase the MCV.

Micros 60

- **HGB** (Hemoglobin)

Turbidity of the Blood sample - Any number of physiologic and/or therapeutic factors may produce falsely elevated Hemoglobin results. To obtain accurate HGB results when increased turbidity of the blood sample occurs, determine the cause of the turbidity and follow the appropriate Method below:

1. Elevated WBC: An extremely elevated WBC will cause excessive light scatter from the L.E.D. In these cases, use Reference (Manual) methods. The Diluted sample should be Centrifuged, and the Supernatant fluid measured with a Spectrophotometer.

2. Elevated Lipids: Elevated Lipids in the blood will give the plasma a “milky” appearance. This condition can occur with Hyperlipidemia, Hyperproteinemia (as in *gammopathies*), and Hyperbilirubinemia. Accurate Hemoglobin measurement can be achieved by using reference (Manual) methods and a plasma blank

Increase in Turbidity may also be seen in cases where the Red blood cells are resistant to the Lysing action. This condition will cause a falsely elevated HGB result, but may be detected by observing the abnormal MCH and MCHC values, and the increased baseline on the (*Left leading edge*) of the WBC Histogram. Erroneous HGB results will cause the results of the MCH and MCHC to be erroneous as well.

Fetal Bloods - The mixing of fetal and maternal bloods may produce a Falsely elevated Hemoglobin value.

- **MCV** (Mean Corpuscular Volume)

Red Blood cell Agglutination - May produce an erroneous MCV value. Red blood cell agglutination may be detected by observing abnormal MCH and MCHC values, as well as examination of a stained blood smear. In such cases, Manual methods may be required to obtain an accurate MCV value.

Excessive Numbers of Large Platelets - and /or the presence of an excessively High WBC count may interfere with the accurate determination of the MCV value. Careful examination of a stained blood smear may reveal the error.

- **MCH**
(Mean Corpuscular Hemoglobin)

The MCH is determined, according to the HGB value and the RBC count. The Limitations listed for HGB and RBC will have an effect on the MCH and may cause erroneous values.

- **MCHC**
(Mean Corpuscular Hemoglobin Concentration)

The MCHC is determined, according to the HGB and HCT values. The Limitations listed for HGB and HCT will have an effect on the MCHC and may cause erroneous values.

- **RDW** (Red cell Distribution Width)

The Red blood cell distribution width is determined, according to the RBC count. The red blood cells pass through a Micro-aperture that will generate electronic pulses, as the cells pass through it. These pulses are then Grouped according to size, Thresholded, and calculated to form a Histogram (Distribution curve). This distribution curve is then used to calculate the distribution of the Red blood cells as a percentage of the curve. This curve is then used in determining the RBC size abnormalities as in Anisocytosis.

Agglutinated Red Blood cells - May cause a falsely low RBC count and erroneous RDW's. Blood samples containing the agglutinated RBC's may be detected by observing abnormal MCH and MCHC values, as well as examination of a stained blood smear.

Nutritional Deficiency or Blood Transfusion - May cause elevated RDW results due to Iron, Vitamin B12, or Folate conditions. High RDW's may also be present from Bi-modal RBC distribution from Transfused Blood. This will be detected by the RBC Histogram showing (2) distinctive peaks on the distribution curve.

- **PLT** (Platelets)

Very Small Erythrocytes - (Microcytes), Erythrocyte's fragments - (Schizocytes), and WBC fragments may interfere with the proper counting of Platelets, and cause elevated Platelet counts.

Agglutinated Red Blood cells - May trap platelets, causing an erroneously Low platelet count. The presence of agglutinated RBC's may be detected by observing abnormal MCH and MCHC values, and by careful examination of a stained blood smear.

Giant Platelets in Excessive Numbers - May cause an erroneously low platelet count since these Large platelets may exceed the Upper Threshold limit for platelets, and are not counted as platelets.

Chemotherapy - Cytotoxic and Immunosuppressive drugs may increase the fragility of these cells which may cause Low platelet counts. Reference (Manual) methods may be necessary to obtain an accurate platelet count.

Hemolysis - Hemolyzed specimens contain Red blood cell Stroma which may cause elevated platelet counts.

A.C.D. Blood - Blood anti-coagulated with Acid-Citrate-Dextrose may contain Platelet Aggregates which could give falsely low platelet counts.

RBC Inclusions - Erythrocyte inclusions such as Howell-Jolly bodies, Heinz bodies, Siderotic and Basophilic granules,.....etc, may produce considerably elevated platelet counts.

Platelet Agglutination - *Clumped Platelets* due to poor collection techniques or platelet Satellitosis caused by EDTA activation of Immunoglobulins may cause a Low platelet count and/or an elevated WBC count. These types of specimens should be re-collected in Sodium-citrate anticoagulant and re-analyzed "For Platelets Only"!

- **MPV** (Mean Platelet Volume)

MICROS 60 OS/OT



Important: Blood Samples collected in EDTA will not maintain a stable Mean Platelet Volume. Platelets collected in EDTA will swell with Time and Temperature!

Giant Platelets - that exceed the Upper Thresholding of the Platelet channels, may not be counted as platelets. Consequently, these larger platelets will not be included in the instrument's calculations of the Mean Platelet Volume.

Agglutinated Red Blood cells - May trap Platelets, causing an erroneous MPV result. The presence of Agglutinated erythrocytes may be detected by observing abnormal MCH and MCHC values, and by careful examination of a stained blood smear.

Very Small Erythrocytes - (Microcytes), Erythrocyte fragments - (Schizocytes), and White Blood cell fragments may interfere with the proper sizing and counting of the Platelets.

Chemotherapy - May also affect the Sizing of Platelets.

- **LYM #**

(Lymphocyte count Absolute Number)

The Lymphocyte count is derived from the WBC count. The presence of Nucleated Red Blood cells (NRBC), certain Parasites, and erythrocytes that are resistant to the Lysing action, may interfere with an accurate LYM # count. Limitations listed for the WBC count pertain to the LYM # count as well.

- **LYM %** (Lymphocyte Percentage)

The Lymphocyte percentage is determined, according to the WBC count and the Number of Lymphocytes. The presence of NRBC's, certain Parasites, and erythrocytes that are resistant to the Lysing action, may interfere with an accurate LYM % count. Limitations listed for the WBC count pertain to the LYM % count as well.

- **MON #**

(Monocyte count Absolute Number)

The Mononuclear cell count is derived from the WBC count. The percentage of Large Lymphocytes, Atypical Lymphocytes, Lymphoblasts, and an excessive number of Basophils may interfere with an accurate Monocyte count.

- **MON %** (Monocyte Percentage)

The Monocyte percentage is determined, according to the WBC count and the number of Monocytes. The presence of Large Lymphocytes, Atypical Lymphocytes, Lymphoblasts, and an excessive number of Basophils may interfere with an accurate Monocyte % count.

- **GRA #**

(Granulocyte count Absolute Number)

The Granulocyte cell count is derived from the WBC count. The excessive presence of Eosinophils, Metamyelocytes, Myelocytes, Promyelocytes, Myeloblasts, and Plasma cells may interfere with an accurate Granulocyte # count.

- **GRA %** (Granulocyte Percentage)

The Granulocyte percentage is determined, according to the WBC count and the number of Granulocytes. The excessive presence of Eosinophils, Metamyelocytes, Myelocytes, Promyelocytes, Myeloblasts, and Plasma cells may interfere with an accurate Granulocyte % count.

5. Reagent Specifications

MICROS 60 OS/OT



The **ABX Diagnostics** reagents specified for this instrument may have followed one or both of the approval methods below:

- 1 - have been registered by the **A.F.S.S.A.P.S.** «**Agence Française de Sécurité Sanitaire des Produits de Santé**» according to the procedure relative to laboratory reagents used for biological analyses.
- 2 - or approved in accordance with the European Directive 98/79/CE (Annex III) for in-vitro medical devices.

Please refer to the packaging of each reagent concerned to establish the approval method.

Refer to **Reagent Leaflets** for all reagent specifications.

MICROS 60 OS/OT



Caution: **ABX DIAGNOSTICS** Manufactures and Markets Reagents, Calibrators, and Quality Control bloods specially designed for use with the **ABX MICROS 60 OS/OT** analyzers. The use of products not recommended by **ABX DIAGNOSTICS** may give erroneous results or instrument operation problems. Contact your local **ABX DIAGNOSTICS** center for all information regarding the recommended products!

5.1. General Recommendations

Reagents used on the **ABX MICROS 60** for Analysis, Rinsing, and Cleaning are described on the following pages. The recommendations for Use, Handling, and Storage of these reagents must be followed to their fullest extent!!!

- Regularly check the Expiration date of your reagents!

- Check with your Shipping company and verify that your reagent shipment has not encountered important Temperature differences during transportation.

- Allow your reagents to return to Room Temperature before use, to avoid Gas bubble emissions.

- “Never” pour the remaining quantity of a reagent perviously being used into the New reagent replacing it. This will eliminate any Cross Contamination to the New Reagent.

- “Never” leave a reagent container “Open” during use. Use the appropriate Caps provided with the instrument. Order New Reagent caps if lost or Misplaced!

- Do Not use the instrument operational caps when reagents are left off the instrument.

- Clean any reagent spillage with water as soon as possible in order to prevent Crystallization of the reagent and Oxidation of the metal parts of the instrument.

- “Never” pour reagents into the Laboratory waste water drainage system. Follow Local/ National regulations for Chemical waste disposal. Apply neutralization procedures when necessary.

- It is Necessary to Flush the reagent lines with Distilled water, then dry them when the instrument is going to be shipped to any location or will be left without operating for an extended period of time. Contact your Local **ABX SERVICE CENTER** for more information about this procedure.

- These reagents are used for (Invitro), *out side the body*, diagnostics.

- All these reagents are Manufactured by:

ABX DIAGNOSTICS

Rue du Caducée
Parc Euromédecine
34184MONTPELLIER CEDEX
FRANCE

Tel: (33) 4 67 14 15 16

Fax: (33) 4 67 14 15 17

6. Waste Handling Procedure

MICROS 60 OS/OT



When disposing of waste, protective clothing must be worn (lab coat, gloves, eye protection, etc...). Follow your local and /or national guidelines for biohazard waste disposal.

If required, waste can be neutralized before being discarded. Follow your laboratory's protocol when neutralizing and disposing of waste.
Dispose of the waste container according to the local or national regulatory requirements

7. Reagent Consumption

Reagent consumption is given in milliliters (ml). It has been calculated from an average on 100 cycles for a specific program version.

Program version: V1.6

Consumption (ml per cycle)				
Cycle	Minidil	Lyse	Miniclean	Minoclair
Startup	21.0	0.6	///	///
Standby	///	///	13.6	///
Analysis	17.5	0.6	0.85	///
Prime All Reagents	40.0	11.6	5.2	///
Prime Diluent	27.0	///	///	///
Prime Lyse	///	11.6	///	///
Prime Cleaner	///	///	6.3	///
Auto Clean	16.4	0.6	15.2	///
Concentrated Cleaning	16.4	0.6	1.5	6.0
Cal Photometer	6.0	1.3	///	///
Backflush	///	///	///	///

Hematology ABX Devices (for in vitro diagnostic use)

ABX Minipack LMG

02/10/03
A95A00032-A

Exclusive use:

Hematology ABX device Exclusive
 Micros 45 / 60 ✓
 Argos & Helios
 Micros CRP
 Pentra 60
 Pentra 60 C+
 Pentra 80
 Pentra XL 80
 Pentra 120
 Pentra 120 Retic
 Pentra DX 120
 Slide Preparation System

REF 0602050

REAGENT 1 0,5L

REAGENT 2 0,3L

REAGENT 3 3,4L

IVD 

ABX Diagnostics
 BP 7290 - 34187 Montpellier
 cedex 4 - France

1. Functions

R1: Enzymatic solution with proteolytic action for the cleaning of ABX blood cell counters.

R2: Erythrocyte lysing agent for white blood cell counting, and differentiation and hemoglobin determination on ABX blood cell counters.

R3: Buffered isotonic solution for the determination and the differentiation of blood cells, and the measurement of hematocrit on ABX blood cell counters.

Measurement procedure to be followed in using the device:

Principle of the method, specific analytical performance characteristics, analytical sensitivity, diagnostic sensitivity, analytical specificity, diagnostic specificity, accuracy, repeatability, reproducibility (including control of known relevant interference), limits of detection, limitations of the method and information about the use of available reference measurement procedures and materials by the user: see «Section: Specifications» in the instrument User Manual.

2. Conservation & Expiration

Storage conditions: Stored at 18°C (65°F) to 25°C (77°F).

Expiration date: refer to «expiration date» reagent packaging label.

3. Measurements, principles & results

Directions for use: see «Section: Reagent Location and connection» in the instrument User Manual.

Measuring Principles : see «Section: Technology» in the instrument User Manual.

Results: Refer to the instrument User Manual

Performance data: see «Section: Specifications» in the instrument User Manual.

Note: if performance changes, call your ABX Diagnostics representative.

4. Composition & Handling precautions

R1: Organic Buffer < 20%
 Proteolytic enzyme < 1%

pH: 9,6 +/- 0,4 (T = 20°C)

Resistivity: 72 +/- 2 Ω (T = 20°C)

Description: Colorless liquid.

R2: Potassium cyanide < 0,03%
 Quaternary Ammonium salt < 20%

pH: 10 +/- 0,5 (T = 20°C)

Resistivity: 213 +/- 10 Ω (T = 20°C)

Description: Colorless liquid.

R3: Sodium fluoride < 3%
Sodium Azide < 0,1%
Sodium Hydroxyde < 1%
Dimethylourea 0,1%

pH: 7 +/- 0,1 (T = 20°C)

Resistivity: 60 +/- 6 Ω (T = 20°C)

Description: Limpid and odourless aqueous solution.

Handling Precautions: Avoid contact with eyes, skin and clothing. Wear laboratory gloves when handling the product. The product may be harmful if ingested or inhaled. Keep the bottle closed when not in use. Please refer to the MSDS associated with the reagent.



Once the waste seal has been broken, the Minipack must be considered as potentially infectious! Use established, good laboratory working practices when handling the Pack.

Specimen Collection and Mixing: see «Section: Specimen collection and Mixing» in the instrument User Manual.

5. Limitations & waste disposal

Limitations: see «Section: Specifications» in the instrument User Manual.

Safe Waste Disposal: Follow your laboratory's protocol when neutralizing and disposing of waste. Please refer to the MSDS associated with the reagent.

Hematology ABX Devices (for in vitro diagnostic use)

ABX Miniclean

Exclusive use:

Hematology ABX device	Exclusive
Micros 45 / 60	✓
Argos & Helios	
Micros CRP	✓
Pentra 60	
Pentra 60 C+	
Pentra 80	
Pentra XL 80	
Pentra 120	
Pentra 120 Retic	
Pentra DX 120	
Slide Preparation System	

23/09/03
A95A00031-A

REF 0403010 (1L)

REAGENT 1L

IVD 



ABX Diagnostics
BP 7290 - 34187 Montpellier
cedex 4 - France

1. Functions

Enzymatic solution with proteolytic action for the cleaning of ABX blood cell counters.

Measurement procedure to be followed in using the device:

Principle of the method, specific analytical performance characteristics, analytical sensitivity, diagnostic sensitivity, analytical specificity, diagnostic specificity, accuracy, repeatability, reproducibility (including control of known relevant interference), limits of detection, limitations of the method and information about the use of available reference measurement procedures and materials by the user: see «Section: Specifications» in the instrument User Manual.

2. Conservation & Expiration

Storage conditions: Stored at 18°C (65°F) to 25°C (77°F).

Expiration date: refer to «expiration date» reagent packaging label.

3. Measurements, principles & results

Directions for use: see «Section: Reagent Location and connection» in the instrument User Manual.

Measuring Principles : see «Section: Technology» in the instrument User Manual.

Results: Refer to the instrument User Manual

Performance data: see «Section: Specifications» in the instrument User Manual.

Note: if performance changes, call your ABX Diagnostics representative.

4. Composition & Handling precautions

Composition:

Organic Buffer < 20%

Proteolytic enzyme < 1%

pH: 9,6 +/- 0,4 (T = 20°C)

Resistivity: 72 +/- 2 Ω (T = 20°C)

Description: Colorless liquid.

Handling Precautions: Avoid contact with eyes, skin and clothing. Wear laboratory gloves when handling the product. The product may be harmful if ingested or inhaled. Keep the bottle closed when not in use. Please refer to the MSDS associated with the reagent.

Specimen Collection and Mixing: see «Section: Specimen collection and Mixing» in the instrument User Manual.

5. Limitations & waste disposal

Limitations: see «Section: Specifications» in the instrument User Manual.

Safe Waste Disposal: Follow your laboratory's protocol when neutralizing and disposing of waste. Please refer to the MSDS associated with the reagent.

Hematology ABX Devices (for in vitro diagnostic use)

ABX Minidil UMG

Exclusive use:

Hematology ABX device Exclusive
Argos / Helios (3&5DIFF)
Micros 60 (18P) ✓
Micros CRP ✓
Pentra 60
Pentra 60 C+
Pentra 80
Pentra XL 80
Pentra 120
Pentra 120 Retic
Pentra DX 120
Slide Preparation System

15/09/03
A95A00006-A

REF 0802010 (10L)

REAGENT 10L

IVD 



ABX Diagnostics
BP 7290 - 34187 Montpellier
cedex 4 - France

1. Functions

Buffered isotonic solution for the determination of blood cell counting and the measurement of hematocrit on ABX blood cell counters

Measurement procedure to be followed in using the device:

Principle of the method, specific analytical performance characteristics, analytical sensitivity, diagnostic sensitivity, analytical specificity, diagnostic specificity, accuracy, repeatability, reproducibility (including control of known relevant interference), limits of detection, limitations of the method and information about the use of available reference measurement procedures and materials by the user: see «Section: Specifications» in the instrument User Manual.

2. Conservation & expiration

Storage conditions: Stored at 18 to 25°C and away from the light.

Expiration date: refer to «expiration date» reagent packaging label.

3. Measurements, principles & results

Directions for use: see «Reagent Location and connection» in the instrument User Manual.

Measuring Principles : see «Measuring Principles» in the instrument User Manual.

Results: Refer to the instrument User Manual

Performance data: see «Section: Specifications» in the instrument User Manual.

Note: if performance changes, call your ABX Diagnostics representative.

4. Composition & handling precautions

Composition:

Sodium fluoride < 3%
Sodium Azide. < 0,1%
Sodium Hydroxyde. < 1%
Dimethylourea 0,1%

pH: 7.0 +/- 0.1 (T = 20°C)

Resistivity: 60 +/- 6 Ω (T = 20°C)

Description: Limpid and odourless aqueous solution.

Handling Precautions: Avoid contact with eyes, skin and clothing. Wear laboratory gloves when handling the product. Keep the bottle closed when not in use. Please refer to the MSDS associated with the reagent.

Specimen Collection and Mixing: see «Section: Preparation before analysis and Startup» in the instrument User Manual.

5. Limitations & waste disposal

Limitations: see «Section: Specifications» in the instrument User Manual

Safe Waste Disposal: see «Section: Installation» in the instrument User Manual. Please refer to the MSDS associated with the reagent.

Hematology ABX Devices (for in vitro diagnostic use)

ABX Minilyse

Exclusive use:

Hematology ABX device	Exclusive
Micros CRP	✓
Micros 45(8P) / 60(8P)	✓
Pentra 60	
Pentra 60 C+	
Pentra 80	
Pentra XL 80	
Pentra 120	
Pentra 120 Retic	
Pentra DX 120	
Slide Preparation System	

21/09/03
A95A00024-A

REF 0701010 (1L)

REAGENT 1L

IVD 



ABX Diagnostics
BP 7290 - 34187 Montpellier
cedex 4 - France

1. Functions

Erythrocyte lysing reagent for white blood cell counting, and hemoglobin determination on ABX blood cell counters.

Measurement procedure to be followed in using the device:

Principle of the method, specific analytical performance characteristics, analytical sensitivity, diagnostic sensitivity, analytical specificity, diagnostic specificity, accuracy, repeatability, reproducibility, limits of detection, limitations of the method and information about the use of available reference measurement procedures and materials by the user: see «Section: Specifications» in the instrument User Manual.

2. Conservation & expiration

Storage conditions: stored at 18°C (65°F) to 25°C (77°F). Product will degrade if exposed to air, keep cap / probe assembly securely tightened.

Expiration date: refer to «expiration date» reagent packaging label.

3. Measurements, principles & results

Directions for use: see «Section: Reagent Location and connection» in the instrument User Manual. This reagent is for professional *in-vitro* diagnostic use only.

Measuring Principles : see «Section: Technology» in the instrument User Manual.

Results: see «Section: Results» in the instrument User Manual.

Performance data: see «Section: Specifications» in the instrument User Manual.

Note: if performance changes, call your ABX Diagnostics representative.

4. Composition & handling precautions

Composition:

Potassium Cyanide	< 0.1%
Sodium Azide	< 0.1%
EDTA	< 25%
Potassium chloride	< 20%
Propanol-2	< 20%
Quaternary ammonium salt	< 20%

pH: 10.2 +/- 0.4 (T=20°C)

Resistivity: 131 +/- 6 Ω (T=20°C)

Description: aqueous solution, limpid.

Handling Precautions: Avoid contact with eyes, skin and clothing. Wear laboratory gloves when handling the product. The product may be harmful if ingested. The product can be absorbed through an open wound, or inhalation. Please refer to the MSDS associated with the reagent.

Special precautions: Avoid contact with acid and aqueous acid environment: extremely toxic cyanide acid vapour can be formed. Please refer to the MSDS associated with the reagent.

Specimen Collection and Mixing: see «Section: Specimen collection and Mixing» in the instrument User Manual

Limitations: see «Section: Specifications» in the instrument User Manual

Safe Waste Disposal: Follow your laboratory's protocol when neutralizing and disposing of waste. Please refer to the MSDS associated with the reagent

Hematology ABX Devices (for in vitro diagnostic use)

ABX Minidil

Exclusive use:

Hematology ABX device Exclusive
Micros 60 (8P) ✓
ABC Vet
Micros CRP
Pentra 60
Pentra 60 C+
Pentra 80
Pentra XL 80
Pentra 120
Pentra 120 Retic
Pentra DX 120
Slide Preparation System

12/09/03
A95A00021-A

REF 0801010 (10L)

REAGENT 10L

IVD 



ABX Diagnostics
BP 7290 - 34187 Montpellier
cedex 4 - France

1. Functions

Buffered isotonic solution for the determination of blood cell counting, and the measurement of hematocrit on ABX blood cell counters

Measurement procedure to be followed in using the device:

Principle of the method, specific analytical performance characteristics, analytical sensitivity, diagnostic sensitivity, analytical specificity, diagnostic specificity, accuracy, repeatability, reproducibility (including control of known relevant interference), limits of detection, limitations of the method and information about the use of available reference measurement procedures and materials by the user: see «Section: Specifications» in the instrument User Manual.

2. Conservation & expiration

Storage conditions: Stored at 18 to 25°C.

Expiration date: refer to «expiration date» reagent packaging label.

3. Measurements, principles & results

Directions for use: see «Section: Installation / Reagent Location and connection» in the instrument User Manual.

This reagent is for professional *in-vitro* diagnostic use only.

Measuring Principles: see «Section: Description & technology» in the instrument User Manual.

Results: see «Section: Description & technology» in the instrument User Manual.

Performance data: see «Section: Specifications» in the instrument User Manual.

Note: if performance changes, call your ABX Diagnostics representative.

4. Composition & handling precautions

Composition:

Potassium Chloride . . . < 20%
Sodium Azide < 0.1%
EDTA < 25%

pH: 7.2 +/- 0.1 (T = 20°C)

Resistivity: 63.7 +/- 6 Ω (T = 20°C)

Description: Limpid and odourless aqueous solution.

Handling Precautions: Avoid contact with eyes, skin and clothing. Wear laboratory gloves when handling the product. Keep the bottle closed when not in use. Please refer to the MSDS associated with the reagent.

Specimen Collection and Mixing: see «Section: Introduction» in the instrument User Manual.

5. Limitations & waste disposal

Limitations: see «Section: Specifications» in the instrument User Manual

Safe Waste Disposal: see «section: Specifications» in the instrument user manual. Please refer to the MSDS associated with the reagent.

Hematology ABX Devices (for in vitro diagnostic use)

ABX Lysebio

Exclusive use:

Hematology ABX device	Exclusive
Micros 60	✓
ABC Vet	
Micros CRP	
Pentra 60	✓
Pentra 60 C+	✓
Pentra 80	✓
Pentra XL 80	✓
Pentra 120	✓
Pentra 120 Retic	✓
Pentra DX 120	✓
Slide Preparation System	

23/04/03
A95A00011-A

REF 0906013 (0,4L)
0906012 (1L)

REAGENT 0,4L or 1L

IVD 



ABX Diagnostics
BP 7290 - 34187 Montpellier
cedex 4 - France

1. Functions

This reagent is used on ABX blood cell counters to lyse red blood cells and determine hemoglobin concentration.

Measurement procedure to be followed in using the device:

Principle of the method, specific analytical performance characteristics, analytical sensitivity, diagnostic sensitivity, analytical specificity, diagnostic specificity, accuracy, repeatability, reproducibility (including control of known relevant interference), limits of detection, limitations of the method and information about the use of available reference measurement procedures and materials by the user: see «Section: Specifications» in the instrument User Manual.

2. Conservation & expiration

Storage conditions: Stored at 15°C (59°F) to 30°C (86°F) away from light.

Expiration date : refer to «expiration date» reagent packaging label

3. Measurements, principles & results

Directions for use: see «Section: Maintenance & Troubleshooting / Reagent Location and connection» in the instrument User Manual.

Measuring Principles : see «Section: Description & technology» in the instrument User Manual.

Results: see «Section: Workflow» in the instrument User Manual

Performance data: see «Section: Specifications» in the instrument User Manual.

Note: if performance changes, call your ABX Diagnostics representative.

4. Composition & handling precautions

Composition :

Quarternary ammonium salt < 5%
Non ionic based surfactant < 3%

pH: 6,95 +/- 0,1 (T = 25°C)

Resistivity: 40 +/- 1 Ω

Description: Colorless, odourless.

Handling Precautions: Avoid contact with eyes, skin and clothing. Wear laboratory gloves when handling the product. The product may be harmful if ingested or inhaled. Keep the bottle closed when not in use. Please refer to the MSDS associated with the reagent

Specimen Collection and Mixing: see «Section: Workflow» in the instrument User Manual

5. Limitations & waste disposal

Limitations: see «Section: Specifications» in the instrument User Manual

Safe Waste Disposal: see «Section: Specifications» in the instrument User Manual. Please refer to the MSDS associated with the reagent.

Hematology ABX Devices (for in vitro diagnostic use)

ABX Minilyse LMG

Exclusive use:

Hematology ABX device Exclusive
Micros CRP
Micros 45(18P) / 60(18P) ✓
Pentra 60
Pentra 60 C+
Pentra 80
Pentra XL 80
Pentra 120
Pentra 120 Retic
Pentra DX 120
Slide Preparation System

21/09/03
A95A00010-A

REF 0702010 (1L)

REAGENT 1L

IVD CE



ABX Diagnostics
BP 7290 - 34187 Montpellier
cedex 4 - France

1. Functions

Erythrocyte lysing reagent for white blood cell counting and differentiation, and hemoglobin determination on ABX blood cell counters.

Measurement procedure to be followed in using the device:

Principle of the method, specific analytical performance characteristics, analytical sensitivity, diagnostic sensitivity, analytical specificity, diagnostic specificity, accuracy, repeatability, reproducibility, limits of detection, limitations of the method and information about the use of available reference measurement procedures and materials by the user: see «Section: Specifications» in the instrument User Manual.

2. Conservation & expiration

Storage conditions: stored at 18°C (65°F) to 25°C (77°F). Product will degrade if exposed to air, keep cap / probe assembly, securely tightened.

Expiration date: refer to «expiration date» reagent packaging label.

3. Measurements, principles & results

Directions for use: see «Section: Reagent Location and connection» in the instrument User Manual. This reagent is for professional *in-vitro* diagnostic use only.

Measuring Principles : see «Section: Technology» in the instrument User Manual.

Results: see «Section: Results» in the instrument User Manual.

Performance data: see «Section: Specifications» in the instrument User Manual.

Note: if performance changes, call your ABX Diagnostics representative.

4. Composition & handling precautions

Composition:

Potassium Cyanide < 0.1 %
Quaternary Ammonium Salt. < 20%

pH: 10 +/- 0.5 (T=20°C)

Resistivity: 213 +/- 10 Ω (T=20°C)

Description: aqueous solution, limpid.

Handling Precautions: Avoid contact with eyes, skin and clothing. Wear laboratory gloves when handling the product. The product may be harmful if ingested. The product can be absorbed through an open wound, or inhalation. Please refer to the MSDS associated with the reagent.

Special precautions: Avoid contact with acid and aqueous acid environment: extremely toxic cyanide acid vapour can be formed. Please refer to the MSDS associated with the reagent.

Specimen Collection and Mixing: see «Section: Specimen collection and Mixing» in the instrument User Manual

Limitations: see «Section: Specifications» in the instrument User Manual

Safe Waste Disposal: Follow your laboratory's protocol when neutralizing and disposing of waste. Please refer to the MSDS associated with the reagent

Hematology ABX Devices (for in vitro diagnostic use)

ABX Minoclair

Exclusive use:

Hematology ABX device	Exclusive	Concentrated cleaning use
Minos	✓	
ABC Vet		✓
Micros 60, Micros CRP		✓
Pentra 60		✓
Pentra 60 C+		✓
Pentra 80		✓
Pentra XL 80		✓
Pentra 120		
Pentra 120 Retic		
Pentra DX 120		
Slide Preparation System		

03/11/03
A95A00029-B

REF 0401005

REAGENT 0,5L

IVD 



ABX Diagnostics
BP 7290 - 34187 Montpellier
cedex 4 - France

1. Functions

Cleaning and bleaching solution for ABX blood cell counters.

Measurement procedure to be followed in using the device:

Principle of the method, specific analytical performance characteristics : see «Section: Specifications» in the instrument User Manual.

2. Conservation & Expiration

Storage conditions: Stored at 18°C (65°F) to 25°C (77°F).

Expiration date: refer to «expiration date» reagent packaging label.

3. Measurements, principles & results

Directions for use: see «Section: Reagent Location and connection» in the instrument User Manual.

Measuring Principles : see «Section: Technology» in the instrument User Manual.

Results: Refer to the instrument User Manual

Performance data: see «Section: Specifications» in the instrument User Manual.

Note: if performance changes, call your ABX Diagnostics representative.

4. Composition & Handling precautions

Composition:

Sodium hypochlorite: 9 % v/v at 13% of active chloride.
Sodium hydroxide: 0,26%

pH: 12,4 +/- 0,5 (T = 20°C)

Resistivity: Not available

Description: Yellowish liquid.

Handling Precautions: Avoid contact with eyes, skin and clothing. Wear laboratory gloves when handling the product. The product may be harmful if ingested or inhaled. Keep the bottle closed when not in use. Please refer to the MSDS associated with the reagent.

Specimen Collection and Mixing: see «Section: Specimen collection and Mixing» in the instrument User Manual.

5. Limitations & waste disposal

Limitations: see «Section: Specifications» in the instrument User Manual.

Safe Waste Disposal: Follow your laboratory's protocol when neutralizing and disposing of waste. Please refer to the MSDS associated with the reagent.

6. Concentrated cleaning exclusive use

Minoclair may also be used as disinfectant and cleaning product on ABX Blood cell counters: see «Section: Concentrated cleaning» in the user manual, on the following instruments: ABC vet, Micros 60, Micros CRP, Pentra 60, Pentra 60C+, Pentra 80, Pentra XL80.

Description & Technology

Contents

1. DESCRIPTION	2
2. TECHNOLOGY	3
2.1. Sampling	3
2.2. Dilutions	3
2.3. CBC Measurement Principles	4
2.4. LMG Differential Measuring Principles	6

Micros 60

1. Description

- 1 LCD Display Screen
- 2 Key Pad Control Panel
- 3 Smart Card Reader (Optional)
- 4 Reagents Compartment

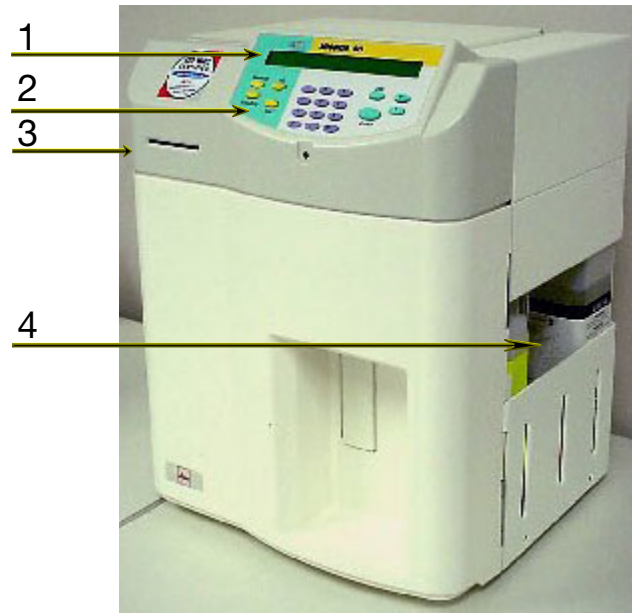

© Micros, Front view

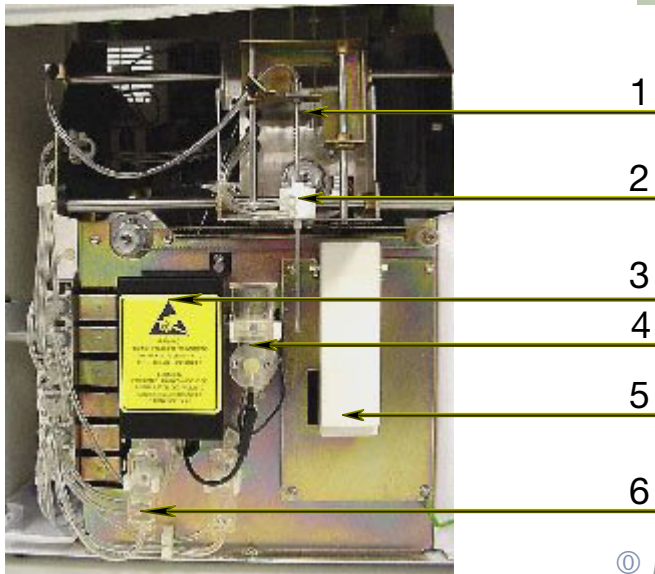

© Micros, Left side view

- 1 Sample Probe and Carriage Assembly
- 2 Manual Sample Probe Assembly
- 3 WBC/HGB Chamber
- 4 RBC Chamber
- 5 Manual Sample Start Bar
- 6 Overflow Protection Tanks
- 7 Diluent Temperature Sensor
- 8 Liquid Syringe
- 9 Valve Block
- 10 Vacuum/Waste Chamber
- 11 Liquid Sensor

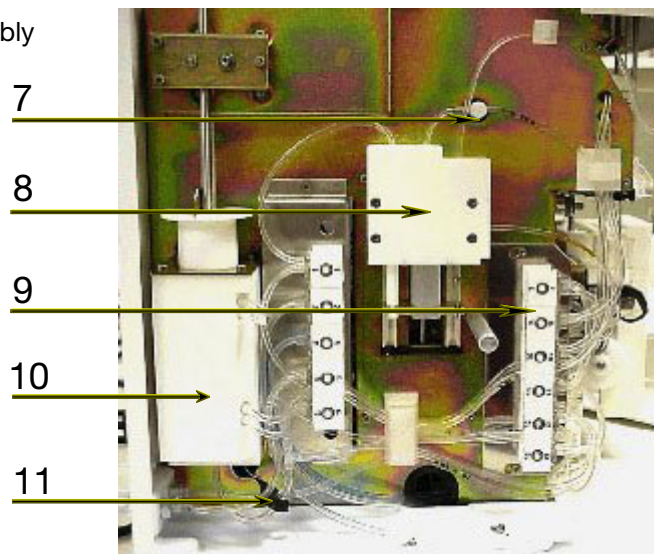

2. Technology

2.1. Sampling

Manual

- 1 - Blood Collection tube cap is removed
- 2 - The Tube is placed beneath the sample probe.
- 3 - The Tube is move upwards and the sample probe enters into the blood.
- 4 - The Manual sample bar is pressed and Aspiration of 10 μ l of Blood occurs.
- 5 - Needle Carriage assembly moves to the Left, over the WBC/HGB Chamber.
- 6 - The External Sample probe rinses.
- 7 - Blood sample is delivered into the WBC Chamber for the First dilution.
- 8 - Aspiration of 28.3 μ l of diluted blood from the WBC Chamber.
- 9 - Needle Carriage assembly moves to the Right, over the RBC/PLT Chamber.
- 10 - The External Sample probe rinses.
- 11 - Diluted Blood sample is delivered into the RBC Chamber for the RBC/PLT measurement.

2.2. Dilutions

WBC/HGB	Dilution
Initial blood volume	10.0 μ l
Volume of ABX Minidil LMG	2.1 ml
Volume of ABX Alphalyse	0.52 ml
Final dilution ratio	1/260
WBC Measurement	
Method	Impedance
Aperture diameter	80 μ m
Count Vacuum	-200mb
Count period	2 x 5 seconds
Temperature reaction	ambient
HGB Measurement	
Method	Photometry
Wavelength	550nm
Count period	2 x 5 seconds
Temperature reaction	ambient

10 μ l of blood sample contained in the sample probe is pushed with 1.2ml of **ABX Minidil LMG** along with 0.5ml of **ABX Minidil LMG** from the outer probe into the WBC/HGB Chamber.

0.4ml of **ABX Minidil LMG** is added the WBC/HGB Chamber making the diluent volume 2.1ml.

0.52ml of **ABX Alphalyse** is added to the mixture. This makes the total dilution for WBC/HGB.

RBC/PLT	Dilution
Initial Diluted blood volume	28.3 μ l
Volume of ABX Diluent	2.5ml
Final dilution ratio	1/15,000
RBC/PLT Measurement	
Method	Impedance
Aperture diameter	50 μ l
Count Vacuum	-200mb
Count period	2 x 5 seconds
Temperature reaction	ambient

28.3 μ l of diluted blood is aspirated from the WBC chamber. The Needle carriage assembly moves to the Right over the RBC/PLT chamber. 2.0ml of **ABX Minidil LMG** and the 28.3 μ l of diluted blood is injected into the RBC/PLT chamber from the inner Sample probe. 0.5ml of **ABX Minidil LMG** is added to the dilution in the chamber from the outer sample probe. This makes the total dilution for the RBC/PLT.

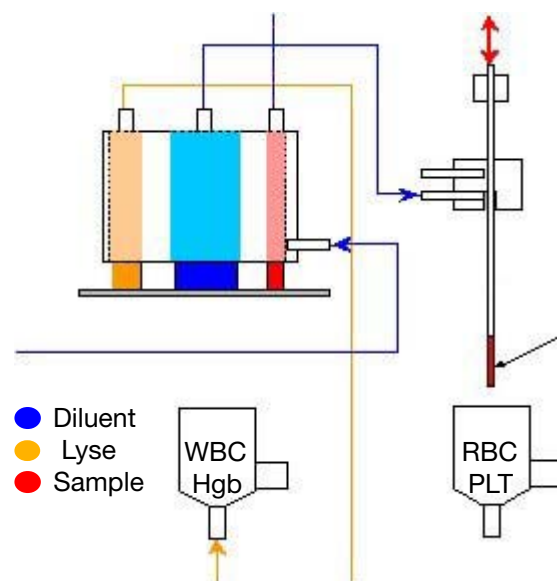

Micros 60

2.3. CBC Measurement Principles

Ⓞ RBC / PLT

The RBC's and PLT's are measured by an Electronic Impedance Variation principle. This means that an electronic field is generated around the micro-aperture in which the Blood cells pass through. The cells create a resistance in the electronic field as they pass through the Calibrated micro-aperture. This inturn causes an electronic pulse to be generated which is amplified, measured, and then mathematically calculated to create a numerical value.

First the 28.3µl Diluted Blood sample is diluted in an Electrolytic Diluent (*electronic current conducting fluid*) mixed, then pulled through a Calibrated micro-aperture. There are two electrodes that are placed on each side of the aperture and a constant electronic current passes between them.

As the Blood cells pass through the aperture, they create resistance (*Impedence*) in the electronic field between the two electrodes. Since the Current is constant and remains unchanged, the Larger the cell is, the "more" resistance it has. The Smaller the cell is, the "less" resistance it has. The Voltage which measures the cells is proportional to the cell size. The Larger the cell, the higher the voltage will be. The Smaller the cell, the lower the voltage will be.

These Electronic Voltages vary in pulse size as cells pass through the aperture. The Pulses are then Channeled according to pulse size. The pulses are then Thresholded, grouped, then mathematically calculated to create a Numerical value for the determination of RBC's and PLT's.

Ⓞ Results

A certain amount of cells will pass through the Calibrated Micro-aperture within a specific time frame. They are then measured by pulse height, Thresholded, grouped by size, and Mathematically calculated along with the Calibration Coefficient to give a final numerical value for both RBC's and PLT's.

Ⓞ RBC and PLT Histograms

The RBC and PLT Histograms are determined by Thersholding of the electrical pulses. These pulses are then Grouped according to size by Channeling the pulses into the correct size category. The electronic pulses are smoothed Mathematically, and plotted on a graph.

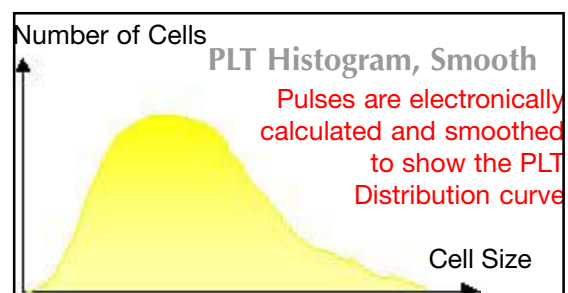
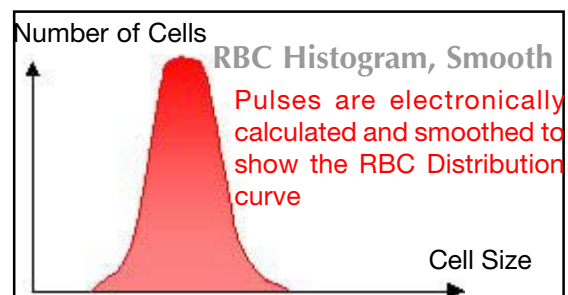
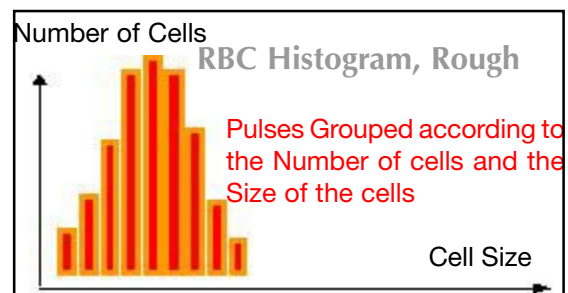
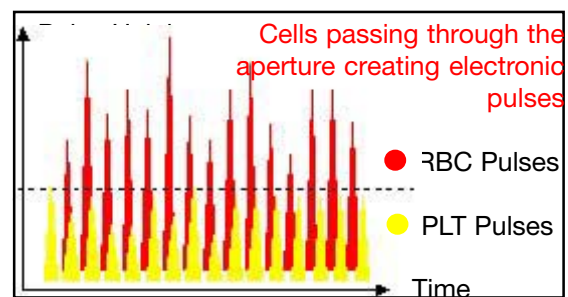

Description & Technology

① RBC and PLT Histograms continued:

RBC Histogram: is an Electronic Distribution and Mathematical calculation of the RBC's placed into 256 Channels of Volumetric sizing from 30fl to 300fl.

PLT Histogram: is an Electronic Distribution and Mathematical calculation of the PLT's placed into 128 Channels of Volumetric sizing from 2fl to a Mobile Threshold between the High end Platelets to the Low end Red Blood Cell Thresholds.

(fl = femtoliters) *A Microscopic volumetric unit of measurement. This is a 3-dimensional measurement used to determine the volume of Microscopic particles.*

① HGB

The Hemoglobin measurement is based on a STARTUP cycle. This cycle includes a Hemoglobin Blank test sequence which includes (2) Hemoglobin blank measurements. Each analysis cycle run after Start-up also has a Hgb Blank measurement which is compared to the initial Start-up Hgb Blank. Each analysis cycle run thereafter compares the Hgb Blank reading to the previous cycle Hgb Blank reading.

During the WBC analysis cycle, 0.52ml of Lyse Reagent is added to 2.05ml of diluted blood in the WBC Chamber. The Lyse Reagent contains potassium ferricyanide [Fe(Cn)]K, and potassium cyanide [KCN]. This Lysing reagent breaks down the RBC Cell membrane and releases the Hemoglobin within the RBC.

The Hemoglobin then combines with the potassium cyanide to form a chromogenous cyanmethemoglobin compound. This chemical compound is measured by Spectrophotometry, through the optical pathway in the WBC chamber. The light wavelength of measurement is at 550nm.

Results, The Hgb results are given as such:
 $HGB = \text{Log}(\text{blank value}/\text{Sample value}) \times \text{the Calibration Coefficient.}$

① HCT

The Hematocrit is a combination measurement of electronic pulses and mathematical calculations. All the RBC pulses are grouped into various sizes. Each group pulse height is then averaged. All the pulse height averages are then averaged one final time for a Mean average of all the RBC pulse heights. This is a function of the numeric integration of the MCV. Results are given as a percentage of this integration.

① MCV, MCH, and MCHC

- MCV (*Mean Cell Volume*), is calculated directly from the entire RBC histogram.
- MCH (*Mean Cell Hemoglobin*), is calculated from the Hemoglobin value and the RBC count.
- Calculations are as followed:

$$MCH \text{ (pg)} = \frac{HGB}{RBC} \times 10$$

Results

The MCH Results are given in Picograms (pg)

- MCHC (*Mean Corpuscular Hemoglobin Concentration*), is calculated according to the Hemoglobin and Hematocrit values.
- Calculations are as followed:

$$MCHC \text{ (g/dl)} = \frac{HGB}{HCT} \times 100$$

Results

The MCHC Results are given in Grams per Deciliter (g/dl)

Micros 60

① RDW

- The RDW (*Red cell Distribution Width*) is used to determine erythrocyte abnormalities linked to Anisocytosis. The RDW will enable you to follow the evolution of the width of the RBC Histogram in relation to the number of cells and their average volume. This is also a calculation of the RBC Histogram.
- Calculations are as followed:

$$\text{RDW (\%)} = \frac{K \text{ SD}}{\text{MCV}}$$

K : Calibration Coefficient for RDW.

SD : Standard Deviation according to statistical studies on cell distribution within the RBC Histogram.

MCV : (Mean Cell Volume) of the erythrocytes.

① MPV

The MPV (*Mean Platelet Volume*), is directly calculated from the Platelet Histogram distribution curve. This calculation is almost the same as the MCV.

① PCT

Thrombocrit (*Plateletcrit*), is calculated according to the formula:

$$\text{PCT \%} = \frac{\text{PLT (10}^3/\text{mm}^3) \times \text{MPV (}\mu\text{m}^3\text{)}}{10,000}$$

① PDW

The PDW (*Platelet Distribution Width*) is calculated from the Platelet Histogram/ Distribution curve.

The PDW is represented by the width of the curve between 15% of the number of platelets starting from the Low Threshold 2fl (S1) and 15% of the number of platelets beginning with the Variable High Threshold (S2).

① PDW continued:

The PDW determination area is shown by the distribution curve below.

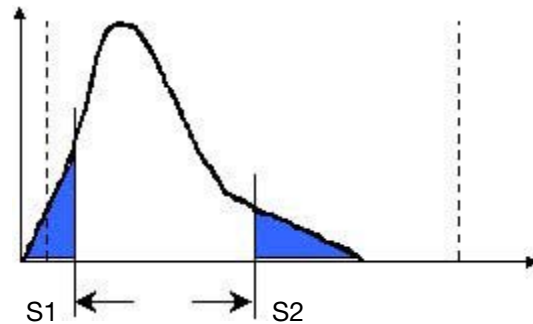

MICROS 60 OS/OT



Note: PCT and PDW are not available in the United States. These parameters are strictly used for Research and Investigational purposes "Only"!!!

① WBC

The WBC Measurement principles are based upon the same as the RBC / PLT measuring principles. The WBC count is performed in the WBC/HGB Chamber. The electronic signal processing device places an electronic Threshold between the WBC's and the PLT's. The electronic pulses are then placed into 256 Channels according to pulse size. The pulses are then Thresholded, grouped, then mathematically calculated to create a Numerical value for the determination of WBC's.

① WBC Histogram

The WBC Histogram is a distribution study that reveals the following (3) types of White blood cell sub-populations: (*Lymphocytes, Monocytes, and Granulocytes*). The Diluent and Lyse of the **ABX MICROS 60** play a very important part when sizing the WBC sub-populations in the WBC distribution curve.

2.4. Differential Measuring principles

Diluent and Lysing action:

The Diluent preserves and prepares the WBC cell membrane for the differential reaction. The Lysing reagent has a differential mode of action on the WBC cytoplasmic membranes.

When the Lyse reacts with the *Lymphocyte* cytoplasmic membrane, it allows the release of water soluble cytoplasm and shrinks the membrane around the nucleus.

When the Lyse reagent reacts with the *Monocyte* cytoplasmic membrane, it has an intermediate reaction which keeps the cell somewhat stable, maintaining its large size in comparison to the lymphocytes.

When the Lyse reagent reacts with the *Granulocytes*, it has a limited reaction due to a molecule in their cytoplasmic structure which protects them from shrinking action of the lyse. This in turn makes the Granulocytes the larger of the WBC sub-populations in the cell differentiation.

After the Differential lysing action, the **ABX MICROS 60** analyses the height of each electronic pulse as the WBC's pass through the Micro-aperture. The pulses are then Channeled, Thresholded, grouped according to their size from 30fl - > 450fl, and calculated Mathematically to create the WBC distribution curve which in turn is known as the WBC Histogram.

The (3) sub-populations of WBC's are placed accordingly as to the number of cells and size of the cells in each group. The distribution of the WBC sub-populations are as followed:

The *Lymphocytes* are between 30 - 100fl.
 The *Monocytes* are between 100 - 150fl.
 The *Granulocytes* are between 150 - > 450fl.

This in turn creates the term (LMG's) for a (3) part WBC differential on the **ABX MICROS 60**.

MICROS 60 OS/OT



Note: • The *Granulocytes* sub-population of the WBC's contains (3) sub-populations within itself, which are somewhat the same in nature. They all contain Cytoplasmic granular material which stain various colors when viewed microscopically. These (3) sub-populations are as followed:

- *Neutrophils*
- *Eosinophils*
- *Basophils*

The distribution of these cells depends on the pathological and physiological conditions of the individuals analyzed!

MICROS 60 OS/OT



Note: Pathological cells will, of course, place themselves in different zones within the WBC distribution curve. Mobile and Fixed Alarm flags will alert the lab operator of the presence of these Pathological elements!

Results

The Lymphocytes, Monocytes, and Granulocytes results are given as a percentage of the entire WBC count, along with absolute numbers, as well, to reflect on the actual WBC count itself. They are presented as followed:

LYM %	LYM #
MON %	MON #
GRA %	GRA #

Micros 60

© Differential measuring continued:

Cells passing through the aperture creating electronic pulses.

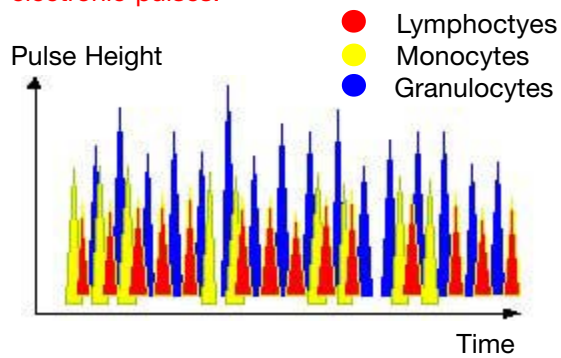

Pulses are grouped according to the Number of cells and the Size of the cells.

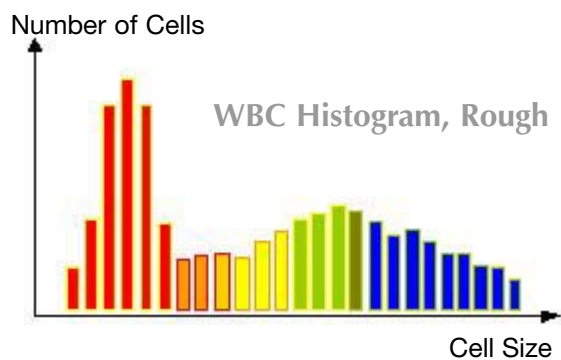

Pulses are electronically calculated and smoothed to show the WBC Distribution curve.

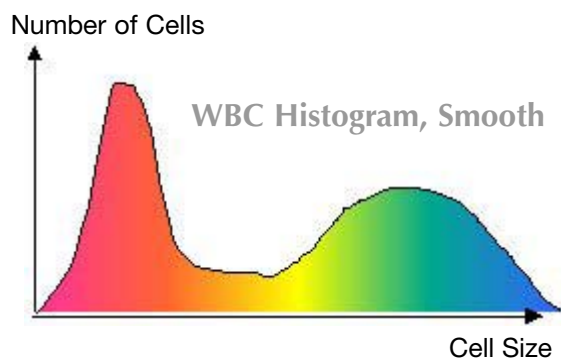

Contents

1. STARTUP CHECKS	2
1.1. Reagent Level checks for Bottle Units	2
1.2. Reagent Level checks for Pack units	2
1.3. Printer Power and on-line checks	2
1.4. Instrument Startup	2
1.5. Blood sample collection (Reference)	3
1.6. Daily Quality Control and Calibration verification notice	3
2. SAMPLE SELECTION AND IDENTIFICATION	4
2.1. Sample Identification modes	4
2.2. Analysis	5
3. RUNNING SAMPLES	5
3.1. Sample Identification	5
3.2. Automatic Cleaning cycle	6
3.3. End of the Day rinsing	6
4. RESULTS	6
4.1. ABX MICROS 60-OS/OT8	6
4.2. ABX MICROS 60-OS/OT16	10
4.3. ABX MICROS 60-OS/OT18	13
5. FLAGS	13
5.1. Normal limits	13
5.2. Flags causing default analysis	13
5.3. Morphology flags	14

Micros 60

1.1. Reagent Level Checks

(Bottled Units) Individual Reagents.

First thing prior to Startup is Checking the levels of each Reagent before operating the system. If a reagent level is “Low”, Replace the reagent and Prime the new reagent using the following steps through the instrument Menus.

From the *Main Menu*, select 4 - SERVICE, 3 - PRIME, then select the reagent or reagents that need to be primed.

- 1 - All Reagents
- 2 - Diluent
- 3 - Lyse
- 4 - Cleaner

MICROS 60 OS/OT



Warning: “Never” pour Reagent from one container into another! Any type of Contamination present in the old reagent will affect the New reagent. Unacceptable Background counts will most likely occur especially for PLT’s (*Platelets*). Always use the reagent Caps provided with the instrument to prevent Reagent pollution or oxidation.

Check the Waste container. Empty the Waste when necessary and follow the Waste disposal guide lines according to your Local and/or National regulations.

MICROS 60 OS/OT



Note: If your Local or National Organizations require Waste Neutralization before disposal, Waste Liquids of the **ABX MICROS 60** can be Neutralized by using the following procedure:

For **20 Liters** of waste liquid, add **50ml** of Sodium Hydroxide solution at 200g/L.

Then add **100ml** of Ammonium Persulfate at 500g/L, prepared daily. Or add **50ml** of Sodium Hydroxide at 200g/L, then add **500ml** of Sodium Hypochlorite solution (Bleach) at 30% of full strength.

1.2. Reagent Level Checks

(Minipak Units) All Reagents and a Waste bladder are contained in One Minipak .

When a Reagent Pack runs low, the instrument will display a message stating that the reagent pack is low. This warning message is given according to the numbers of CBC cycles left in the pack. The warning message is as followed:

WARNING : PACK LOW LEVEL : 5
ESC TO EXIT START TO CONFIRM

To replace the Minipak, follow these steps through the menus. From the *Main Menu*, select 4 - SERVICE, 3 - PRIME, then 3 - PRIME PACK. The **ABX MICROS 60** will show the remaining steps to follow on the LCD display. Once this Pack replacement is complete, the instrument automatically resets the CBC cycle counter to (160) cycles.

1.3. Printer Power and On-line Checks

Prior to Instrument Startup, always check the Printer to verify that the Power is turned “ON” and that the LED’s are in the Ready state. Check that the Printer has sufficient paper for the daily operations. Check the alignment of the paper if your printer is a Tractor Feed printer.

1.4. Instrument Startup

Power “ON” the Instrument by pressing the ON/OFF switch, located on the back, lower center of the rear panel. The LCD display will show the following:

PLEASE WAIT FOR 3 MIN
ESCAPE : ESC

This indicates an instrument warm-up period for the internal electronics.

Startup and Sample Run

① Instrument Startup continued:

Once the Instrument warm-up phase is complete, the Front panel L.E.D. will turn from “Red” to “Green” indicating that the initialization phase is complete. The **ABX MICROS 60** will now automatically run a **STARTUP CYCLE**, if and only if the instrument has been programmed for an **AUTO-Startup cycle**.

If the **ABX MICROS 60** does not automatically run a Startup cycle after the initialization phase is complete, press the “**STARTUP**” key on the instrument front panel to initiate the cycle.

The **ABX MICROS 60** will perform a Startup cycle which primes all the reagents, checks the electronics, and Mechanical movements. Then the instrument will perform a Blank Cycle for a Background Count (*An analysis cycle based on Reagents without any Blood sample*). The instrument then prints out the Blank cycle results.

② Background Limits

Check and verify that the Background counts do not exceed the following parameter Limits:

WBC	0.3	10³/ mm³
RBC	0.02	10⁶/ mm³
HGB	0.0	g/dl
HCT	0	%
PLT	10	10³/ mm³

If the Background count is above any of the parameter limits, the **ABX MICROS 60** will automatically perform another **STARTUP** cycle. If the Problem persists after (3) consecutive cycles, a message will be printed out stating “Startup Failed, Check Reagents”! Refer to the “Maintenance and Troubleshooting” section in this Manual for identifying and resolving the problem in question.

MICROS 60 OS/OT



Note: If the HGB Blank test is unacceptable during the first **STARTUP** Cycle, (2) more Startup cycles will be performed. If all (3) Startup cycles fail the HGB Blank test, an error message will be printed out stating “Startup Failed, HGB Reference Failed”!

MICROS 60 OS/OT



Note: If any analysis cycles are run prior to a Startup cycle, a message will be displayed on the LCD and printed out stating: “**STARTUP NOT INITIATED**”!

When the **ABX MICROS 60** has not been used within (4) hours of the last cycle, it is necessary to perform a **STARTUP** cycle before running an analysis cycle.

1.5. Blood Sample Collection

Refer to **Section 1- Specifications**, 4.2. Blood Specimens (*Sample collection and mixing*). for collection requirements.

Blood samples must be Gently and Thoroughly mixed with a rocking or tilting motion just before pressing the Manual Sample Bar for the analysis cycle.

1.6. Daily Quality Control and Calibration Verification note

Before analyzing any patient blood samples, it is recommended that the Operator performs Quality Control analysis on (3) levels of Control Blood Material, (*Low, Normal, and High*), to verify that the **ABX MICROS 60** is performing within the specified ranges of the Quality control material.

2. Sample Selection and Identification

2.1. Sample Identification Modes

① US Mode

MICROS 60 OS/OT



Note: The Sample Identification Modes are selected from the Set-up Menu in the system configuration. Refer to **Section 5 - Instrument Configuration, 3 - Special Functions, (3.7. Sample Identification Modes)** for selecting the Mode for your daily operations.

This Mode requires a patient Identification on each analysis run, *(This Mode also allows the use of a Barcode Reader if Applicable).*

US Mode Identification “Without” a Barcode Reader is a simple and easy task. Just press the “ID” key on the front panel to enter the sample ID. The Identification menu will be displayed on the LCD as indicated:

PAT. ID. ? :	EXIT : ECS
CURRENT	SAVE : ENTER

The sample Identification can be entered using up to 13 Alphanumeric (*Numbers and/or Letters*) characters. Letters can be entered by using the “Up” and “Down” arrow keys (▲ ▼), on the front panel. Press the “ENTER” key after each Alpha character entry.

The Number keys can be used up to 13 consecutive characters if No alpha characters are used before pressing the “ENTER” key.

The sample Identification will be held in Memory until the cycle is complete.

US Mode Identification “With” a Barcode Reader is performed by pressing the “ID” key on the front panel.

MICROS 60 OS/OT



Important: The Barcode Reader is a special setup function in the system configuration. Before using this setup, the Barcode Reader must be configured on the Main Circuit board of the **ABX MICROS 60**. If you require a Barcode Reader for sample Identification, please contact your local **ABX Service Representative** for Installation and setup of this device!

Place the sample in front of the reader so that the Label can be identified. When the reading is complete, a “Beep” tone is heard and the label identification will be displayed on the LCD screen. Press the “ENTER” key to save the current identification or press the Escape “ESC” key to display the previous identification.

① Standard Mode

If the Standard Mode identification was selected from the set-up menu, Press the “ID” key on the front panel to enter the sample “RUN #”. The following menu will be displayed on the LCD as indicated:

RUN # ? :	EXIT : ESC
NEXT :	SAVE : ENTER

The Run Number can be entered by using the Number keys “Only”! Enter a run number from (1 to 99999) then press the “ENTER” key when finished to save the current Run # or press the Escape “ESC” key to display the previous Run #.

Once the Modes of Identification have been entered, a message will appear on the LCD display stating “PRESS THE SAMPLING BAR”, press the manual sampling bar or press the “START” key on the front panel of the **ABX MICROS 60** to start the analysis cycle.

2.2. Analysis (Quick Reference)

- Mix the sample Gently and Thoroughly.
- Remove the cap from the sample tube.
- Place the sample beneath the sample probe.
- Raise up the tube so that the sample probe lowers into the blood, and press the Manual Sample Bar or press the “START” key.
- The analysis cycle will begin.

MICROS 60 OS/OT



Note: If the instrument has not been in operation for 1/2 hour and an analysis cycle is initiated, the **ABX MICROS 60** will start a HGB Reference cycle. The message “PLEASE WAIT” will be displayed on the LCD screen. Once the HGB reference cycle is complete, the message “PRESS THE SAMPLING BAR” will appear.

The Analysis cycle will take approximately 60 seconds. At the end of the cycle, the result prints out, the LED on the front panel turns from “Red” to “Green”, and the **ABX MICROS 60** is ready for the next analysis.

If any results are out of their acceptable ranges, Controls and Normal Patient samples, perform the following steps:

- 1 - Rerun the Control or patient sample.
- 2 - Clean the system, see **Section 6 - Maintenance and Troubleshooting**, Service functions, (*Concentrated Cleaning*). Re-run the sample.
- 3 - Open a New vial of Control material.
- 4 - Call your local **ABX Technical Support Representative** before re-Calibrating the system.

3. Running Samples

3.1. Sample Identification

Run the Quality Control blood, all (3) levels and verify that the results are within their specified limits. Run the patient blood samples.

Follow the steps listed:

- 1 - Mix the blood sample gently and thoroughly.
- 2 - Press the “ID” key and enter the patient Identification if (US Mode) is selected in set-up. Press the “ID” key and enter the Run # if (Standard Mode) is select in set-up.
- 3 - Remove the cap from the sample tube.
- 4 - Place the sample beneath the sample probe, raise the sample tube upwards so that the sample probe enters into the blood.
- 5 - Press the Manual Sample Bar and analysis will begin. Press the “START” key on the front panel if the system does not respond to the Manual sample bar.

Micros 60

3.2. Automatic Cleaning Cycle

The **ABX MICROS 60** will perform an Automatic cleaning cycle once the analysis cycles have reached the programmed cycle limit set in the Set-up Menu. The standard Default automatic cycle limit is set at **(50)** analysis cycles per day.

This Cleaning cycle number can be changed in the Set-up menu. See **Section - 5 Instrument Configuration, 3 - Special functions, (3.4. Autocleaning frequency)**. The Operator has the option of changing this cleaning frequency number to allow for cleaning intervals dependant on the number of blood samples run during each day.

When an Automatic cleaning cycle begins a message will appear on the LCD screen stating:

```
AUTO CLEANING  PLEASE WAIT 2mn 13s
*****
```

The Operator may also request an AutoClean at any time needed. From the *Main Menu*, select **4 - SERVICE**, then **8 - AUTO CLEAN**.

3.3. End of the Day Rinsing

It is necessary to run a STANDBY/Shutdown cycle at the end of each day. Press the "STANDBY" key on the front panel. The **ABX MICROS 60** performs a complete cleaning with the enzymatic detergent (Miniclean) , and puts the system into a Standby mode.

The **ABX MICROS 60** can then be switched "OFF" at the end of the working day or left in this Standby mode until the next working day. It also may be left in the Standby mode between long breaks during the day.

MICROS 60 OS/OT



Important: When the **ABX MICROS 60** is left in the Standby Mode, it is mandatory to perform a "STARTUP" cycle before returning to any analysis cycles.

Startup and Sample Run

4. Results

When an analysis cycle is complete, Results are displayed and printed out according to the Set-up of the Instrument.

4.1. Micros 60-OS/OT8

① Displayed Results

The Parameter results are as displayed on the LCD screen once the analysis cycle is complete:

WBC	RBC	HGB	HCT	MCV	MCH	MCHC	PLT	△
7.5	5.22	15.6	46.5	89	29.9	33.5	233	▽

① Identification

1 - (US Mode) sample Identification can be reviewed on the LCD screen, in the "RESULTS" menu by moving the "Up" or "Down" Arrow keys as shown:

01/20/2002	PAT ID : 0123456789ABC	△
09:25		▽

2 - (Standard Mode) The Patient Run # can be reviewed on the LCD screen, in the "RESULTS" menu by moving the "Up" or "Down" Arrow keys as shown:

01/20/2002	RUN # : 12345	△
09:25		▽

① Flags

The PLT flags can be reviewed on the LCD screen, in the "RESULTS" menu by moving the "Up" or "Down" Arrow keys as shown:

PLT Flags :	△
	▽

MICROS 60 OS/OT



Note: The Last sample result run can be displayed again at any time before running the next analysis. From the *Main Menu*, select *1 - RESULTS*. Use the "Up and Down" arrow keys to view any part of the Last sample results.

Micros 60

4.1. Micros 60-OS/OT8 continued:

Ⓞ Results Printout (US Mode)

RESULTS					
DATE :	01/20/2002	TIME :	09:25		
ID :	SMITH_1234567				
SEQ. # :	27				
STARTUP PASSED					
Plt Flags :					
WBC :	10.0	10 ³ /mm ³	MCV :	90	μm ³
RBC :	4.90	10 ⁶ /mm ³	MCH :	30.6	Pg
HGB :	15.0	g/dl	MCHC :	34.1	g/dl
HCT :	43.9	%	PLT :	287	10 ³ /mm ³

On the Printout, the information printed is as followed:

- 1 - The "Date" the sample was analyzed
- 2 - The "Time" the sample was analyzed
- 3 - The Sample "Identification" that the Operator had entered either (Manually or Barcode).
- 4 - The "Sequence" number of the sample run
- 5 - The Instrument "STARTUP" status.
- 6 - The "PLT flags" if any were reported
- 7 - The 8 Parameter CBC results with Limit flags and units.

MICROS 60 OS/OT



Note: The Sequence Number is updated to the number (1) each calendar day. The Number increases by increments of (1) each analysis cycle sequentially. This Sequential number can not be modified by the Operator!

Startup and Sample Run

① Results Printout (Standard Mode)

RESULTS							
DATE : 01/20/2002				TIME : 09:25			
RUN # : 12345							
SEQ. # : 27							
Plt Flags :							
WBC :	10.0	10 ³ /mm ³	MCV :	90	μm ³		
RBC :	4.90	10 ⁶ /mm ³	MCH :	30.6	Pg		
HGB :	15.0	g/dl	MCHC :	34.1	g/dl		
HCT :	43.9	%	PLT :	287	10 ³ /mm ³		

On the Printout, the information printed is as followed:

- 1 - The "Date" the sample was analyzed
- 2 - The "Time" the sample was analyzed
- 3 - The Sample "RUN #" that was entered by the Operator
- 4 - The "Sequence" number of the sample run
- 5 - The "PLT flags" if any were reported
- 6 - The 8 Parameter CBC results with Limit flags and units.

MICROS 60 OS/OT



Note: The Sequence Number is reset to the number 1 each calendar day. The Number increases by increments of (1) each analysis cycle, sequentially. This Sequential number can not be modified by the Operator!

Micros 60

4.2. ABX Micros 60-OS/OT16

① Displayed Results

The first group of Parameter results are as displayed on the LCD screen once the analysis cycle is complete:

WBC	RBC	HGB	HCT	MCV	MCH	MCHC	PLT	△
7.5	5.22	15.6	46.5	89	29.9	33.5	233	▽

The second group of parameter results can be displayed by pressing the “Up” arrow key when in the results display.

MPV	RDW	%LYM	%MON	%GRA	#LYM	#MON	△
#GRA							▽
8.8	13.0	39.3	7.3	53.4	2.21	0.41	3.00

① Identification

1 - (US Mode) sample Identification can be reviewed on the LCD screen, in the “RESULTS” menu by moving the “Up” or “Down” Arrow keys as shown:

01/20/2002	PAT ID : 0123456789ABC	△
09:25		▽

2 - (Standard Mode) The Patient Run # can be reviewed on the LCD screen, in the “RESULTS” menu by moving the “Up” or “Down” Arrow keys as shown:

01/20/2002	RUN # : 12345	△
09:25		▽

① Flags

The PLT and WBC flags can be reviewed on the LCD screen, in the “RESULTS” menu by moving the “Up” or “Down” Arrow keys as shown:

PLT Flags :	△
WBC Flags :	▽

Startup and Sample Run

MICROS 60 OS/OT



Note: The Last sample result run can be displayed again at any time before running the next analysis. From the *Main Menu*, select *1 - RESULTS*. Use the “Up and Down” arrow keys to view any part of the Last sample results.

Ⓞ Results Printout (US Mode)

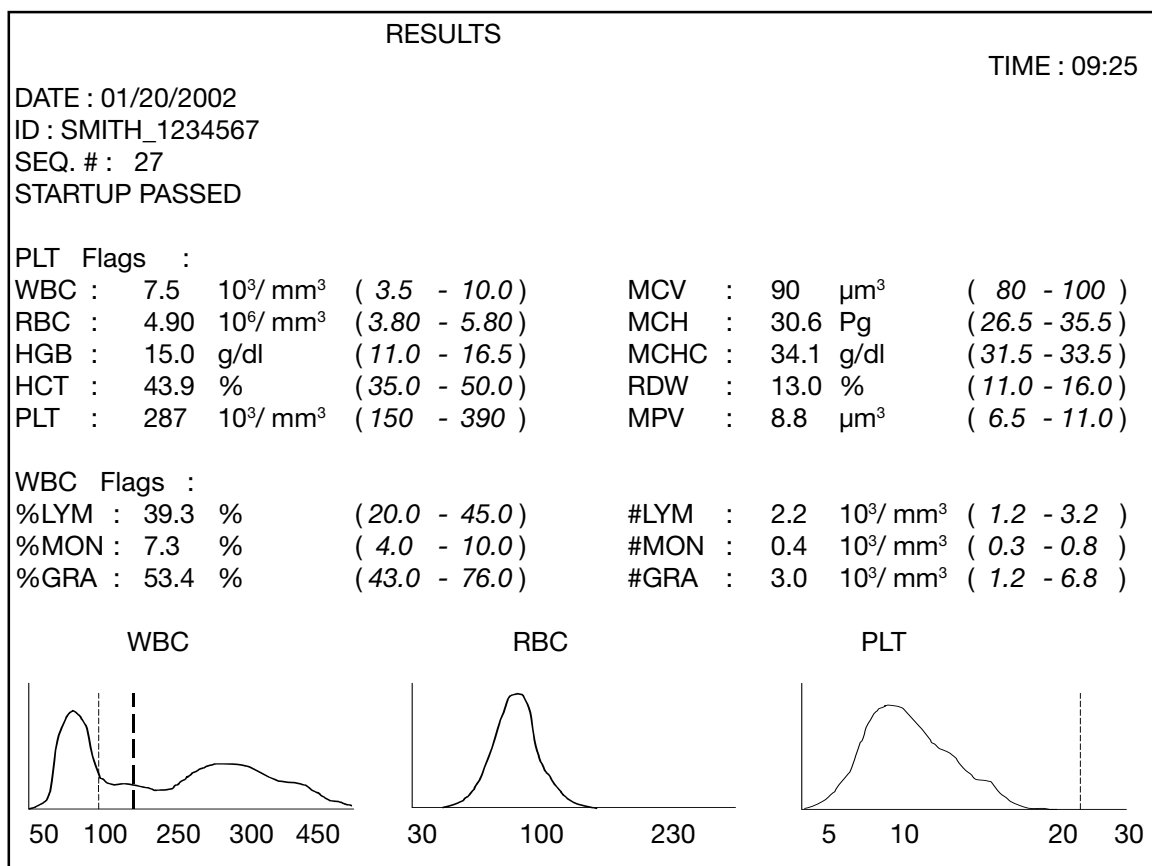

On the Printout, the information printed is as followed:

- 1 - The “Date” the sample was analyzed
- 2 - The “Time” the sample was analyzed
- 3 - The Sample “Identification” that the Operator had entered either (Manually or Barcode).
- 4 - The “Sequence” number of the sample run
- 5 - The Instrument “STARTUP” status.
- 6 - The “PLT flags” if any were reported
- 7 - The 16 Parameter CBC results with Limit flags and units.
- 8 - The “WBC flags” if any were reported
- 9 - The (3) part Differential (LMG) results.
- 10 - The WBC, RBC, and PLT Histograms.

Micros 60

MICROS 60 OS/OT



Note: The Last sample result run can be displayed again at any time before running the next analysis. From the *Main Menu*, select *1 - RESULTS*. Use the “Up and Down” arrow keys to view any part of the Last sample results.

Ⓞ Results Printout (Standard Mode)

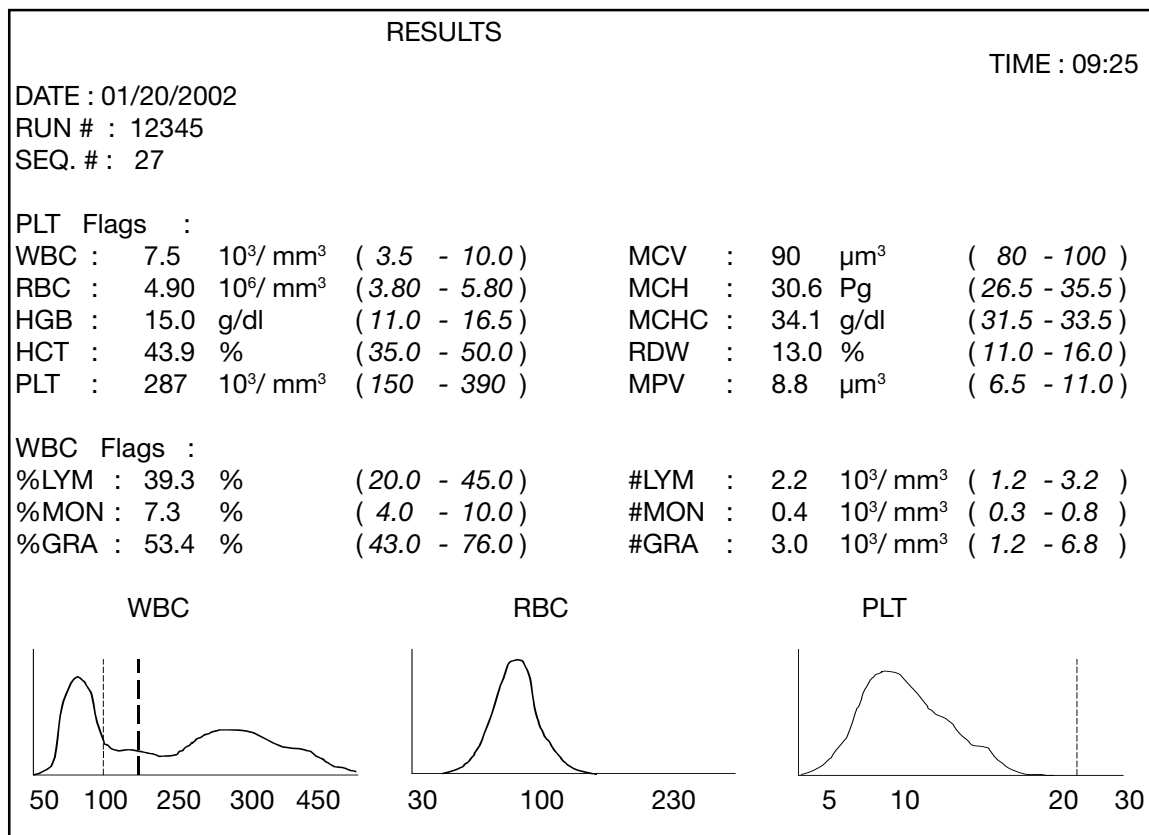

On the Printout, the information printed is as followed:

- 1 - The “Date” the sample was analyzed
- 2 - The “Time” the sample was analyzed
- 3 - The Sample “RUN #” that was entered by the Operator
- 4 - The “Sequence” number of the sample run
- 5 - The “PLT flags” if any were reported
- 6 - The 16 Parameter CBC results with Limit flags and units.
- 7 - The “WBC flags” if any were reported
- 8 - The (3) part Differential (LMG) results.
- 9 - The WBC, RBC, and PLT Histograms.

Startup and Sample Run

4.3. Micros 60-OS/OT18

MICROS 60 OS/OT



Note: The **ABX MICROS 60-OS/OT18** has all the same characteristics as the **MICROS 60-OS/OT16** with the exception (2) parameters, PCT and PDW which are reported on the **MICROS 60-OS/OT18** results.

5. Flags

These Instrument flags and alarms can be classified in (5) different groups:

- 1 - Flags and alarms linked to a result when it exceeds normal limits.
- 2 - Flags and alarms linked to a result or to the operation of the Instrument, leading to a "Default analysis".
- 3 - Flags and alarms linked to the Morphology of a blood cell population.
- 4 - Flags and alarms linked to the statistical functions of the instrument.
- 5 - Flags and alarms linked to Instrument operation.

5.1. Normal Limits

- The "**H**" flag located next to a parameter result indicates that the value is "Above" the Upper limit set by the operator. See **Section 5 - Instrument Configuration, 2 - Change Laboratory Limits, (2.2. Result High limits)**.

- The "**L**" flag located next to a parameter result indicates that the value is "Below" the Lower limit set by the operator. See **Section 5 - Instrument Configuration, 2 - Change Laboratory Limits, (2.1. Result Low limits)**.

MICROS 60 OS/OT



Important: Results exceeding the "**H**" and "**L**" limits should be re-analyzed and questioned as to the pathological condition of the patient or the operation of the instrument!

5.2. Flags causing Default Analysis

These flags are shown in different ways as indicated:

- Results Defaulted to 0.0.
- Results associated with an Asterisk (*), Dollar sign (\$), or Exclamation mark for HGB (!).
- Results exceeding the Linear range of the analyzer. (see tables below)

① Results Exceeding Linear range

Results displayed:

VISIBLE	LIMITS	RANGE	RANGE
WBC(x10 ⁹ /mm ³)	«result»	«result»+ «D»	DIL
RBC(x10 ⁶ /mm ³)	«result»	«result»+ «D»	DIL
PLT(x10 ⁹ /mm ³) HGB≥2g/dL	«result»	«result»+ «D»	DIL
HGB<2g/dL	«result»	«result»+ «D»	DIL
HGB(g/dL)	«result»	«result»+ «D»	DIL
HCT(%)	«result»	«result»+ «D»	DIL

Result printout and transmitted:

VISIBLE	LIMITS	RANGE	RANGE
WBC(x10 ⁹ /mm ³)	«result»	«result»+ «D»	-- + D or -- + 0
RBC(x10 ⁶ /mm ³)	«result»	«result»+ «D»	-- + D or -- + 0
PLT(x10 ⁹ /mm ³) HGB≥2g/dL	«result»	«result»+ «D»	-- + D or -- + 0
HGB<2g/dL	«result»	«result»+ «D»	-- + D or -- + 0
HGB(g/dL)	«result»	«result»+ «D»	-- + D or -- + 0
HCT(%)	«result»	«result»+ «D»	-- + D or -- + 0

MICROS 60 OS/OT



Important: Whole Blood parameter results within visible range will still give a result value with a "**D**" indication. These results require a dilution (or PRP analysis for PLT) of the sample.

⓪ Results Rejected

A “Reject” flag, shown by an asterisk (*) following the Parameters WBC, RBC, HCT, or PLT indicates that the **ABX MICROS 60** has analyzed that parameter for a maximum of (3) counts. All (3) counts were outside the system precision limits for that specific parameter. The results should be verified by re-running the sample.

⓪ Results Comparable

A reportable result shown by a Dollar sign (\$) following the parameters WBC, RBC, HCT, or PLT indicates that the **ABX MICROS 60** has analyzed that parameter for a maximum of (3) counts. Two out of three counts were within the system precision limits for that specific parameter.

The results can be reported, but the parameter should be monitored for the next sample analyzed.

•⓪ HGB Blank Reference

A suspicious flag, shown by an Exclamation (!) located next to the Hemoglobin result shows that the HGB Blank carried out during the analysis differs from the previous cycle’s HGB Blank. This (!) means that both HGB blanks were outside the Instrument precision limits.

This result can be reported, but the parameter should be monitored for the next sample analyzed.

The MCH and MCHC may also be affected by this (!) flag depending on the severity of the results.

MICROS 60 OS/OT



Important: If the Exclamation (!) flag occurs more than (3) consecutive sample runs, troubleshoot the HGB parameter in the following section of this manual. See **Section 6 - Maintenance and Troubleshooting, Troubleshooting Parameters, (HGB)**!

5.3. Morphology Flags

⓪ Flags on PLT Distribution curve

The PLT Histogram has 128 channels between 2fl and 30fl. A mobile Threshold (*Positioned to 25fl by default*) moves according to the Microcyte population present in the Platelet analysis area.

The PLT flags are as followed:

1 - An excessive presence of cells to the right of the Threshold area (25fl) will trigger the “**MIC**” (Microcytes) flag.

The Mobile threshold looks for a valley between the (25fl standard value) and 18fl.

2 - When there is No valley between PLT and RBC populations, a reject PLT (*) flag is triggered. PLT results are not reliable and must be verified by a Manual Platelet Count.

3 - If the number of particles between 18fl and 25fl are too high, the “**SCH**” (Schizocytes) flag will be triggered. The “SCH” flag will cause a Platelet reject (*) flag.

Suspected abnormalities include:

- Presence of Schizocytes
- Presence of Platelet aggregates

Verify the Platelet results on a stained blood smear.

4 - The “**SCL**” (Small cells) flag indicates the presence of small cells in the 2fl to 3fl zone. The PLT results may be reported as (---) and there may also be No PLT Histogram.

MICROS 60 OS/OT



Important: All Platelet results with these specific flags should be re-verified by *Platelet Rich Plasma (PRP)* analysis and/or Manual Platelet Counts.

Startup and Sample Run

Ⓞ Flags on WBC Distribution curve

The **ABX MICROS 60 OS/OT16 and OS/OT18** has a system of WBC Differential flags alerting the operator to the possible presence of Pathological cells, Abnormal volume distribution histograms, or Abnormal elevated populations such as the excessive presence of Eosinophils and Basophils.

1 - Flag "**L1**" indicates an abnormal number of cells, in comparison with the Lymphocytes, in the **(30fl to 60fl zone)**. The pathological elements which may be found in this area will include:

- Platelet aggregates
- Nucleated Red blood cells
- Atypical Lymphocytes

This flag corresponds to the number of cells counted in the first (5) channels, out of the total number of Lymphocytes.

2 - The "**M2**" flag indicates an excessive number of cells in the **(130fl to 160fl zone)**. The Pathological elements which may be found in this area will include:

- Lymphoblasts
- Myelocytes
- Abnormal Lymphocytes
- Basophilia (too Many Basophils)

This flag corresponds to the number of cells counted in the detection zone in comparison to the total number of Granulocytes.

3 - The "**G1**" flag indicates an excessive number of cells in the **(160fl to 220fl zone)**. The pathological elements which may be found in this area will include:

- Eosinophilia (too many Eosinophils)
- Myelocytes
- Neutrophile polynucleose

This flag corresponds to the number of cells counted in the detection zone in comparison to the total number of Granulocytes.

4 - The "**G2**" flag indicates an excessive number of cells in the **(220fl to 250fl zone)**. This flag makes it possible to follow an abnormal Granulocyte peak displacement. Some of the cell variances will include:

- Anomalies in the cell membrane of the Granulocytes
- possible Lyse flow error
- Fluidic errors
- Old blood (after 6 to 8 hours) un-refrigerated
- Granulocyte cell size less than 250fl.

5 - The "**G3**" flag indicates an excessive number of cells larger than **400fl**. The pathological elements which may be found in this area will include:

- Metamyelocytes
- Many types of Large Immature Cells

This flag corresponds to the number of cells counted in the detection zone in comparison to the total number of Granulocytes. This cell count will be Higher than the set level!

MICROS 60 OS/OT



Important: All Anomalies and/or Abnormal distribution flags given by the **ABX MICROS 60** should be Manually verified by the examination of a stained peripheral blood smear for the presence of pathological elements. As a result of the Differential resistance of cytoplasmic membranes in the different cell types, Pathological elements can be found in a number of different zones. This also applies to presence of Normal or non-pathological cells that have been subjected to Chemotherapy or some other form of treatment which affects the alarm zones. These types of treatments will result in "False" alarms.

Micros 60

Ⓞ **Flags on WBC Distribution curve**
continued:

MICROS 60 OS/OT



Note: All Morphology flags can be adjusted by the operator. See **Section 5 - Instrument Configuration, 2 - Change Laboratory Limits, (2.4. Flag Limits)**. The Factory “Default” flag values programmed on the **ABX MICROS 60** were set, based on a study of Normal cell populations. These Default values can be adjusted to accommodate specific Populations and/or Geographical locations based on those specific studies. It is highly recommended to calculate the percentage of flags in a specific population before making any adjustments!

Calibration & Quality Control

Contents

1. CALIBRATION PROGRAM	2
1.1. Calibration	2
1.2. Calibration passed	6
1.3. Calibration failed	7
1.4. RDW Calibration	9
1.5. Calibration coefficients	10
2. QUALITY CONTROL	13
2.1. Quality Control options	13
2.2. Q.C. Automatic	14
2.3. Accepting or Rejecting QC results	19
2.4. Q.C. Analysis	20
2.5. Q.C. Print Targets	21
2.6. Q.C. Statistics	22
2.7. Q.C. Graphs	23

1. Calibration Program

The **ABX MICROS 60** Calibration can be achieved in (2) different ways.

1 - Calibration is performed using a Calibrator Blood sample.

MICROS 60 OS/OT



Important: It is highly recommended that you use the **ABX MINOCAL** Calibration product when calibrating the **ABX MICROS 60** analyzer. This product is specifically designed for use with the **ABX MICROS 60** analyzer. Call your local **ABX DIAGNOSTICS Customer Service Representative** for information and ordering of this specialized product.

2 - Known Calibration Coefficients can be directly entered by selecting a Calibration Menu option.

MICROS 60 OS/OT



Important: Before performing an instrument Calibration, it is mandatory to:

1 - perform a *Concentrated Cleaning* to ensure the cleanliness of the Counting Chambers and Apertures!
 2 - Run a *Blank Cycle* to assure that all the Background values are at their lowest possible limits. (See **Section 3 - Startup and Sample Run, 1.4. Instrument Startup, (Background Limits)**).

3 - Run *Reproducibility* on a Fresh Normal patient blood sample (**10**) times and calculate the Coefficient of Variation (CV%) for WBC, RBC, HGB, HCT, PLT, and MPV. Note the Percent CV's in this section of the Manual.

These 3 factors will ensure a clean and precise instrument when calibrating. If your **ABX MICROS 60** does not pass a Background or Reproducibility check, contact your local **ABX Technical Support representative!!!**

To enter into the Calibration Menu from the *Main Menu*, select 3 - CALIBRATION. The following menu will be displayed on the LCD screen as shown:

```
CALIBRATION    > 1- AUTO CALIBRATION
09:25          2- COEFFICIENTS
```

1.1. Calibration

① Calibration Procedures

1 - From the Calibration Menu, select 1 - AUTOCALIBRATION.

2 - Select one of the (4) Operators (O.P) which may be entered in the System Set-up menu. (See Section 5 - Instrument Configuration, 3 - Special Functions, (3.1. Changing Operator Identification). After selecting one of (4) operators, press the "ENTER" key.

The LCD will display a message as indicated:

```
ERROR : NO SMART CARD ... NO : ESC
INSERT NEW CARD             YES : ENTER
```

Press the Escape "ESC" key. This will allow you to enter into the Calibration menu and edit all the calibration information Manually.

① Change Lot number

1 - Press the "ENTER" key to enter the new lot number of the calibrator material.

```
LOT # ? : _      EXIT : ESC
CURRENT : MCAL121  SAVE : ENTER
```

2 - Enter the new "Lot Number" of the current calibrator from the Assay sheet that comes with the calibration material. Use the "Up" and "Down" arrow keys to enter the Alpha characters. Use the Numeric keys to enter the Numbers. Press the "ENTER" key to save the new lot number and move to the next entry. As indicated:

```
LOT # : MCAL175      EXIT : ESC
CURRENT : MCAL121   SAVE : ENTER
```

Calibration & Quality Control

① Change Expiration date

3 - The next screen will indicate changing the Expiration date of the new calibrator.

```
CHANGE EXP. DATE ? (MM.DD.YY) NO : ESC
CURRENT : 11/20/01                YES : ENTER
```

4 - Press the “ENTER” key, enter the new expiration date from the Calibration Assay sheet. Use the “Period” key after entering the Month. Use the “Period” key after the Day. Press the “ENTER” key to save the new expiration date and move to the next entry as indicated:

```
EXP. DATE : (01.20.02)   EXIT : ESC
CURRENT : 11/20/01      SAVE : ENTER
```

② Change Target values

5 - The next screen will indicate changing the WBC Target value.

```
CHANGE TARGET WBC ?   NO : ESC
CURRENT : 8.2          YES : ENTER
```

6 - Press the “ENTER” key and enter the new target value for WBC from the Calibration Assay sheet as indicated:

```
TARGET WBC : 10.2     EXIT : ESC
CURRENT : 8.2         SAVE : ENTER
```

7 - Press the “ENTER” key to save the new target value and move to the next entry as indicated:

8 - The next screen will indicate changing the RBC Target value. Repeat Steps **6 through 8** for RBC, HGB, HCT, PLT, and MPV. When the MPV target value has been entered, the next screen that will appear will ask if you want to change the number of samples to be run for calibration.

A Calibration “Reminder”!!!

MICROS 60 OS/OT



Note: The number of samples you can run for calibration is a Minimum of (3) and a Maximum of (11). In order for the instrument to provide the best mathematical data for a good calibration, a Minimum of (6) sample runs is highly recommended for quality statistical calibration data!

③ Change Number of Calibration Samples

After all the Target values have been entered, the next screen will indicate:

```
CHANGE SAMPLE # ?   NO : ESC
CURRENT : 8         YES : ENTER
```

9 - Press the “ENTER” key to change the number of samples. The next screen will indicate entering the sample number.

```
SAMPLE # 10         NO : ESC
CURRENT : 8         YES : ENTER
```

10 - Press the “ENTER” key and enter the number of samples you wish to run for calibration or press the Escape “ESC” key if the number of samples desired is already present.

The LCD will now state, as indicated:

```
RUN CAL ?         NO : ESC
                  YES : ENTER
```

11 - Press the “ENTER” key to start the calibration process. A message will be displayed on the LCD as the **ABX MICROS 60** performs a Prime cycle prior to aspirating the first sample.

```
RUN CAL
10:23          PLEASE WAIT
```

Micros 60

① Calibration Procedures continued:

When the cycle is complete, another message will appear stating, as indicated:

START CALIBRATION # 1 / 6
ESC TO EXIT PRESS START TO ASPIRATE

12 - Now gently and thoroughly mix the Calibrator material as indicated on the Instruction sheet that comes with the calibrator.

13 - Place the calibrator beneath the sample probe, and raise the vial upwards so that the sample probe enters into the blood.

14 - Press the "START" key on the front panel to initiate the cycle of the first sample, or press the Manual Sample Bar
The cycle will begin and the sample will be aspirated.

MICROS 60 OS/OT



Important: Wipe any excess blood from the Cap and Threads of the calibrator vial with a *Lint-free tissue* to prevent any dried blood from re-entering into the calibrator material. Dried Blood re-entering into the vial may give Error flags and reject the sample runs!

15 - Place the cap back onto the vial, gently and thoroughly mix the material for the next calibration sample run.

When the first sample is complete, the results will be displayed on the LCD screen as indicated:

WBC RBC HGB HCT PLT MPV PRESS ENTER
9.8 4.56 13.4 35.9 267 7.6 TO CONTINUE

Verify that the results are within 20% of each parameter target value indicated on the Calibrator Assay sheet. Press the "ENTER" key to continue.

16 - The next LCD display will ask you if you want to Accept or Reject the results, if and only if the results were not rejected previously.

MICROS 60 OS/OT



Important: Calibration results having Error flags such as (\$, *, or ! for HGB) will automatically be rejected! The system will automatically re-set itself to rerun that sample. If you acquire (3) rejects continuously on the same number sample, abort Calibration and contact your local *ABX Technical Support representative!*

The LCD display will indicate:

VALID CALIBRATION # 1 / 6
ESC TO DISCARD ENTER TO VALID

If the results are "Not" within acceptable limits, it is possible to reject the results and restart that sample run. Press the Escape "ESC" key on the front panel to "Reject" the results. The instrument will re-start the sample at the same number.

17 - If the results are good, press the "ENTER" key to accept the first sample into the calibration data. The LCD screen will display the next sample to be run as indicated:

START CALIBRATION # 2 / 6
ESC TO EXIT PRESS START TO ASPIRATE

18 - Run the remaining calibrator samples, repeating Steps **13 through 17 for each sample**. Remember to Gently and thoroughly mix the calibrator material between each sample run! Also Wipe the cap and threads of the vial between each run.

When the last sample result has been validated, the *ABX MICROS 60* calculates the statistical calibration factors for each parameter.

Calibration & Quality Control

These statistical calculations include the *Mean, Target, Coefficient of Variation, Percent difference between the Target value and the Mean, Previous Calibration coefficients, and the New Calibration Coefficients*. The Status will indicate on the printout if a parameter has Passed or Failed Calibration.

① Verify Calibration

1 - Once the calibration is complete and has Passed the Calibration criteria, Press the Escape “ESC” ket until you have returned to the Main Menu.

2 - Run the remaining Calibrator material (3) times as a regular patient analysis. (*Remember to gently and thoroughly mix the material between each sample run.*)

3 - When each cycle is complete, record the results in (*Table 3. Verify Calibration*) on the Minocal Assay sheet.

4 - Once all results have been entered, calculate the Total and Mean values for each parameter listed.

5 - Now compare the Mean value for each parameter to the Assay Mean values and ranges listed for the **ABX MICROS² 60**.

6 - Verify that all the calculated parameters fall within the specific parameter Ranges on the Assay sheet.

7 - If all parameters are within their specified ranges, Calibration is complete.

8 - Run Quality Control and verify that all (3) levels of control results are within their specified ranges. Verify that all control parameter results are without Flags (**H, L, *, \$, and !** for HGB).

Micros 60

1.2. Calibration Passed

In order for **ABX MICROS 60** to “Pass” Calibration, the data must meet the statistical criteria which contain (2) conditions.

1. The Coefficient of Variations must be within their limits as indicated in the table below.
2. The difference between the “Target value” and the “Mean” for each parameter calibrated, must be less than 20%.

COEFFICIENT of Variation Limits						
Parameters	WBC	RBC	HGB	HCT	PLT	MPV
CV %	≤ 2.5	≤ 2.0	≤ 1.5	≤ 2.0	≤ 5.0	≤ 3.0

“Passed” Calibration printout is as indicated:

CALIBRATION						
DATE : 01/20/2002	TIME : 09 : 48					
OPERATOR : ABC						
LOT # : MCAL212						
RUN	WBC	RBC	HGB	HCT	PLT	MPV
1 P	10.2	4.50	14.0	38.0	242	7.6
2	9.9	4.45	14.0	37.4	246	7.9
3	9.7	4.41	14.0	37.2	237	7.7
4	10.0	4.51	14.2	37.9	251	7.7
5	9.9	4.43	14.1	37.2	254	7.5
6	9.8	4.38	14.1	36.8	248	7.5
MEAN	9.9	4.44	14.1	37.3	247	7.7
TARGET	9.9	4.54	13.5	37.2	260	7.7
C V	1.0	1.0	0.7	1.0	2.3	1.8
% CHG	0.0	2.25	4.26	0.27	5.26	0.0
OLD CAL .	1.09	0.89	1.11	1.08	1.20	0.94
CURRENT	1.09	0.91	1.07	1.08	1.26	0.94
STATUS	OK	OK	OK	OK	OK	OK

Calibration & Quality Control

MICROS 60 OS/OT



Note: The “P” to the right of RUN # 1 indicates that the first calibration sample is not included in the statistical calculations. This first sample is considered as a Calibrator material ”Prime”!

Once the calibration information has printer out, the screen will indicate:

CALIBRATION ENDED WITH NEW COEFF.
PRESS A KEY TO CONTINUE....

Press any key to return to the *MAIN MENU* of the *ABX MICROS 60!*

1.3. Calibration Failed

In order for *ABX MICROS 60* to “Fail” Calibration, the data must meet the statistical criteria which contain (2) conditions.

1. The Coefficient of Variations are out of thier specified limits as shown on *Page 6 in this Section*.
2. The difference between the “Target value” and the “Mean” for each parameter that failed calibration, is greater than 20%.

When *ABX MICROS 60* “Fails calibration”, the results will be printed out, the Calibration coefficients are “Rejected”, and the previous coefficients will remain unchanged in memory.

Once the calibration information has printed out, the screen will indicate:

CALIBRATION FAILED !!!
PRESS A KEY TO CONTINUE....

MICROS 60 OS/OT



Note: When the Calibration STATUS indicates “FAILED” on one or more parameters, even though stating “OK” on the other parameters, Calibration will not take place!

MICROS 60 OS/OT



Note: When the Calibration Fails, the operator may restart the calibration again or call your local *ABX Technical Support representative* for further instructions!

Micros 60

If the calibration fails and the Printer is not used, the following menu will be displayed on the LCD as indicated:

SAVED COEFF. WBC	0.97	RBC	0.88	HGB	0.95	△
REJECT. COEFF.	1.16		0.90		0.90	▽

Rejected and saved coefficients can be displayed by using the “Up” and “Down” arrow keys on the front panel. Press the Escape “ESC” key to return to the *Main Menu*.

“Failed” Calibration printout is as indicated:

CALIBRATION						
DATE : 01/20/2002		TIME : 09 : 48				
CALIBRATION FAILED						
OPERATOR : ABC						
LOT # : MCAL212						
RUN	WBC	RBC	HGB	HCT	PLT	MPV
1 P	10.2	4.50	14.0	38.0	242	7.6
2	9.9	4.45	14.0	37.4	246	7.9
3	9.7	4.41	14.0	37.2	237	7.7
4	10.0	4.51	14.2	37.9	251	7.7
5	9.9	3.65	14.1	31.8	254	7.5
6	9.8	4.38	14.1	36.8	248	7.5
MEAN	9.9	4.32	14.1	36.5	247	7.7
TARGET	9.9	4.54	13.5	37.2	260	7.7
C V	1.0	7.7	0.7	6.3	2.3	1.8
% CHG	0.0	5.09	4.26	1.92	5.26	0.0
REJ. COEFF	1.09	0.89	1.11	1.08	1.20	0.94
CURRENT	1.09	1.05	1.07	1.02	1.26	0.94
STATUS	OK	FAILED	OK	FAILED	OK	OK

Calibration & Quality Control

1.4. RDW Calibration

The RDW calibration is a separate calibration outside the Auto-calibration menu.

MICROS 60 OS/OT



Note: The RDW calibration is normally performed by taking blood samples from (100) Healthy, Normal, and Drug-free individuals. These blood samples are then analyzed on a instrument that has been calibrated for RDW determination. The Mean and Standard Deviation are then calculated from that population analyzed. The same (100) samples are then analyzed on the **ABX MICROS 60**. A Population Mean is calculated and then compared to the known calculated Mean from the comparison instrument. The RDW calibration coefficient for the **ABX MICROS 60** is then calculated from the difference of the two Mean values.

MICROS 60 OS/OT



Note: Expected RDW values may vary with sample population and/or geographical location. It is highly recommended that each Laboratory establish its own normal ranges based on the local population!

The RDW calibration coefficient default value is normally set at (1.00). It can be edited by entering into the *Calibration Menu and selecting 2 - COEFFICIENTS, 1 - CALIB. COEFF.*, enter the password (123), or the password that has been defined by the operator in the set-up menu. See **Section 5 - Instrument Configuration, 3 - Special functions, (3.2. Change Password)**.

The Instrument Default password is normally set to (123) before operator intervention. Press the "ENTER" key and the following menu will be displayed as indicated:

```
CALIB. COEFF. >1 - WBC < 0.97 >
10:42          2 - RBC < 0.98 > ▾
```

1 - Select the number (7) key on the key pad or use the "Down" arrow key to select the RDW coefficient as indicated on the display:

```
CALIB. COEFF. >7 - RDW COEFF < 1.00 ▴
10:23          8 - PDW          < 1.00 >
```

2 - Once the RDW coefficient has been selected, press the "ENTER" key to edit the coefficient as indicated on the display:

```
RDW COEFF ? : _      EXIT : ESC
CURRENT : 1.00      SAVE : ENTER
```

3 - Enter the RDW coefficient value which has been calculated from the comparison study. Press the "ENTER" key to accept the new value.

4 - Press the Escape "ESC" key until you return to the Main Menu.

① RDW Calibration form a Quality Control Standard

The RDW may also be calibrated by using a known Quality Control Standard.

DEFINITION: A Quality Control Standard is defined as a Commercial blood product which has been specifically developed and Assayed with set parameter Target values and ranges. This product is designed to precisely measure the accuracy and linearity of the analyzer.

1 - Take the **ABX Minotrol - Controls** and bring them to room temperature. Gently and thoroughly mix the control material as indicated on the instruction sheet that comes with the control kit.

2 - Run the *Normal Level control* (6) times, as a regular patient analysis. When the cycles are complete, note only the RDW results. Write down these result for future reference use.

3 - Calculate the Mean value for all (6) results and write it down for future reference use.

Micros 60

① RDW Calibration form a Quality Control Standard continued:

4 - Take the Minotrol Assay sheet that comes with the control kit and note “Only”, the Normal Control Mean Assay value for RDW.

5 - Calculate the New RDW coefficient as followed:

- Take the Normal Control Mean Assay value for RDW,
- Divide it by the Mean value of the Normal control ran (6) times as a sample,
- Times the current RDW calibration coefficient, This will equal the New RDW Calibration coefficient.

6 - To Enter into the calibration coefficient menu, from the *Main Menu*, select 3 - CALIBRATION, 2 - COEFFICIENTS, 1 - CALIB. COEFF., enter the password, and use the “Down” arrow key to 7 - RDW.

7 - Press the “ENTER” key to enter the New coefficient for RDW. Press the “ENTER” key again to accept the New coefficient after it has been entered.

8 - Press the Escape “ESC” key until you return to the Main Menu.

9 - Now take all (3) *Levels of controls, LOW, NORMAL, HIGH*, and run them (1) time each as a regular patient analysis. When the cycles are complete, note only the RDW results and compare them to the Minotrol control Assay values for RDW, on the Assay sheet. Verify that the RDW results are somewhat close to the Mean Assay values and within the Ranges as specified for all (3) Levels.

10 - The RDW calibration is now complete. Be sure to monitor your RDW results and verify that they fall within your patient population.

Verify that Normal RDW results will be within the established ranges set in the set-up menu. See **Section 5 - Instrument Configuration, 2 - Change Laboratory Limits, (2.1./2.2. Result Low Limits - Result High Limits)**.

MICROS 60 OS/OT



Note: Certain Pathological conditions will affect the RDW results. See **Section 1 - Specifications, 4-Limitations, (4.3. Known Interfering substances)**

1.5. Calibration Coefficients

Calibration may also be achieved by changing the “Calibration Coefficients” directly. From the *Mani Menu*, select 3 - CALIBRATION, 2 - COEFFICIENTS. The following menu will be displayed on the LCD screen as indicated:

COEFFICIENTS	1 - CALIB. COEFF.
10:23	2 - PRINT COEFF.

In this Menu, the operator has the option of either “Editing” the current calibration coefficients or “Printing” the current calibration coefficients.

MICROS 60 OS/OT



Important: The **ABX MICROS 60** is an accurate and reliable instrument when properly maintained. Should any variation of Quality Control results outside the Assayed ranges occur after calibration, it is Highly suggested that you contact your local **ABX Technical Support Representative** before Manually editing the calibration coefficients!!!

① Changing Calibration Coefficients

When in the Coefficients menu, manually editing the calibration coefficients is performed by selecting 1 - CALIB. COEFF. The LCD screen on the **ABX MICROS 60** will then ask for the password which allows the operator to enter into and edit the coefficients. The display will state as indicated:

PASSWORD ? :
10:24

Calibration & Quality Control

A specific password is required to enter into the coefficients menu. Enter the password (**123**), or the password that has been defined by the operator in the set-up menu. See **Section 5 - Instrument Configuration**, 3-Special functions, (3.2. *Change Password*). The Instrument Default password is normally set to (**123**) before any operator intervention.

After entering the password, press the “ENTER” key and the following menu will be displayed as indicated:

```
CALIB. COEFF. >1 - WBC < 0.97 >
10:42          2 - RBC < 0.98 > ▾
```

To Edit any coefficient in this menu, place the cursor next the the coefficient to be edited by press the “Up” or “Down” arrow keys. Once you have selected the coefficient to be edited. follow the steps indicated.

```
CALIB. COEFF. 1 - WBC < 0.97 >
10:42          > 2 - RBC < 0.98 > ▾
```

1 - Once the coefficient has been selected, press the “ENTER” key. The following menu will be displayed as indicated:

```
RBC      ? : _      EXIT : ESC
CURRENT  : 0.98     SAVE : ENTER
```

2 - Enter the New coefficient derived from using the following formula, at the bottom of this page:

3 - Once New coefficient has been entered, press the “ENTER” key to accept the coefficient. The display will return to the Calibrate Coefficient Menu with the new coefficient displayed as indicated:

```
CALIB. COEFF. 1 - WBC < 0.97 >
10:42          > 2 - RBC < 1.03 > ▾
```

4 - Continue to use the “Up” or “Down” arrow keys to select the next coefficient to be edited. Use the same formula below to calculate the remaining coefficients.

5 - Repeat steps **1 through 3** for each remaining coefficient. Once all New coefficients have been entered, press the Escape “ESC” key until you return to the Main Menu.

MICROS 60 OS/OT



Important: After manually editing the calibration coefficients, it is Highly recommended to run Quality Control. Verify that all levels of control material are within their specified parameter ranges. Verify that there are no error flags (**H, L, *, \$, !** for HGB) associated with all levels of Quality control results.

MICROS 60 OS/OT



Note: PCT and PDW are not available in the United States! These parameters are Strictly used for research and investigational purposes “Only”!

Calibration Coefficients are as listed:

WBC
RBC
HGB
HCT
PLT
MPV
RDW COEFF.
PDW COEFF.

$$\frac{\text{Parameter Target value}}{\text{Parameter Mean value}} \times \text{Current parameter coefficient} = \text{New parameter coefficient}$$

Micros 60

① Print Coefficients

From the Calibration Menu, select 2 - COEFFICIENTS, 2 - PRINT COEFF. The current calibration coefficients will automatically printout as indicated:

COEFFICIENTS						
DATE	: 01/20/2002			TIME	: 14:26	
CURRENT	WBC	RBC	HGB	HCT	PLT	MPV
	0.97	0.88	1.13	1.08	0.95	0.92
RDW COEFF	:		1.00			
PDW COEFF	:		1.00			

MICROS 60 OS/OT



Note: PCT and PDW are not available in the United States! These parameters are Strictly used for research and investigational purposes "Only"!

① Calibration Coefficient limits

After any calibration has been performed on the **ABX MICROS 60**, Verify that all parameter calibration coefficients are within their specified ranges as indicated:

Parameters	WBC	RBC	HGB	HCT	PLT	MPV	RDW	PDW
Coefficient limits								
Minimum	0.89	0.73	0.83	0.87	0.99	0.75	0.75	0.75
Target	1.09	0.89	1.11	1.08	1.20	0.94	1.00	1.00
Maximum	1.29	1.05	1.39	1.29	1.41	1.13	1.25	1.25

If any of the Calibration coefficients are out of their specified ranges after calibrating the **ABX MICROS 60**, contact your local **ABX Technical Support Representative!**

Calibration & Quality Control

2. Quality Control Program

2.1. Quality Control Options

MICROS 60 OS/OT



Important: It is highly recommended that you use the **ABX MINOTROL** Quality Control blood product when running Q.C. on the **ABX MICROS 60** analyzer. This product is specifically designed for use with the **ABX MICROS 60** analyzers. Call your local **ABX DIAGNOSITCS Customer Service Representative** for information and ordering of this specialized product.

The **ABX MICROS 60-OS/OT** Quality Control program contains (5) different functions in its Menu.

1. **AUTOMATIC** - The function of this Q.C. sub-menu is to allow the operator to analyze Commercial Control blood products (MINOTROL), and store the results on the **Quality Control Smart Card**.

2. **ANALYSIS** - The function of this Q.C. sub-menu is to allow the operator to analyze Commercial Control blood products (MINOTROL), with fixed WBC Thresholds specifically for use "Without" a Smart Card.

3. **PRINT TARGETS** - The function of this Q.C. sub-menu is to allow the operator to print the Target values of the Commercial Control blood products from the **Quality Control Smart Card "Only"!!!**

4. **STATISTICS** - The function of this Q.C. sub-menu is to allow the operator to print the cumulative statistics for the Commercial Control blood products from the **Quality Control Smart Card "Only"!!!**

5. **GRAPHS** - The function of this Q.C. sub-menu is to allow the operator to print the Levey Jennings graphs of the Commercial Control blood products from the **Quality Control Smart Card "Only"!!!**

MICROS 60 OS/OT



Caution: When running Quality Control "Without" the use of a Smart Card, pay close attention to the Result parameter Limits, if the system was programmed to print out the limits. These limits "Are not" Quality Control limits. These limits are the ones that were established in the set-up menu. See **Section 5 - Instrument Configuration, 2-Change Laboratory Limits, (2.1./2.2. Result Low Limits and Result High Limits)**. Verify your control results with the Assay sheet that comes with the control material. Verify that each Control level parameter is within its assayed limits!!!

To enter into the Q.C. menu from the *Main Menu*, select 2 - Q.C., then press the "ENTER" key. The menu will displayed as indicated:

Q.C.	>1 - AUTOMATIC	▽
09:23	2 - ANALYSIS	

•2.2. Q.C.- Automatic (With Q.C. Smart Card)

1 - Remove the Minotrol Quality Control blood from the refrigerator and bring it to room temperature.

2 - From the Q.C. Menu, select 1 - **AUTOMATIC**. This menu will move the operator through the automatic quality control process once the Smart Card is inserted. Operator selection, Lot # identification, Expiration date,etc. will be displayed between each step of the process.

3 - Insert the **Quality Control Smart Card** into the card reader with a firm push until you here it "click" into place.

Micros 60

① Q.C.- Automatic

(With Q.C. Smart Card) continued:

The first step that takes place is that the **ABX MICROS 60** checks for the presence of a CARD READER.

If a Card Reader is not present, or if there is a technical failure with the present reader, the Q.C. PROGRAM will be aborted and the following message will appear on the LCD display as indicated:

ERROR : NO SMART CARD READER
PRESS A KEY TO CONTINUE....

Once a key has been pressed, the analyzer automatically returns to the Q.C. menu because it is impossible to run Q.C. Automatic without a Smart Card Reader!

The second step that takes place is that the **ABX MICROS 60** checks for the presence of a *Quality Control Smart Card!*

If the card has not been inserted, or if the card has been inserted incorrectly, or if there is a technical failure with the present reader, the following message will appear on the LCD display as indicated:

ERROR : NO SMART CARD... NO : ESC
INSERT NEW CARD YES : ENTER

MICROS 60 OS/OT



Caution: The **ABX MICROS 60** will only accept the *Quality Control Smart Card* while in the Q.C. program! It will not accept:

- 1 - A Q.C. card that has expired!
- 2 - A Memory Card!

If you have the correct card and are still having the Error messages indicated above, contact your local **ABX Technical Support Representative** for further instructions regarding this issue!!!

If the Escape “ESC” key is pressed, the analyzer automatically returns to the Q.C. menu because it is impossible to run Q.C. Automatic without a Q.C.Smart Card!

If the Q.C. smart card is in the reader and the previous Error messages do not appear, the **ABX MICROS 60** will automatically read the card and display the Lot # and Expiration date of the current card as indicated:

LOT # M211 NEW Q.C. NO : ESC
EXP DATE 01/20/02 YES : ENTER

MICROS 60 OS/OT



Caution: It is mandatory to verify that the Quality Control Smart card being used matches the Instrument Type (Micros 60), the Lot #, and Expiration date of the Quality Control material being used for this program!

① Q.C.- Smart Card Messages

“**NEW QC**” means that this card is being used for the very first time.

“**XX QC RUN**” When the card already has Q.C. data on it, the display will show the next sample run for Quality control, i.e. **18 QC RUN** in place of New QC. This number indicates the next Q.C. run after the stored runs.

For example: 1 complete QC RUN contains all (3) levels of controls, *Low, Normal, and High* analyzed 1 time each.

“**QC DIFF**” means that there is a difference between the QC index in the **ABX MICROS 60** and the QC index on the QC Smart card. This usually occurs when there is confusion between 2 QC Smart cards.

If the operator presses the “ENTER” key, the analyzer accepts the differences and automatically equals the indexes between the **ABX MICROS 60** and QC Smart Card.

If the operator presses the Escape “ESC” key, the analyzer requests a New Card, reads the New card information, and displays it.

Calibration & Quality Control

“**SMART CARD FULL**” means that the QC Smart Card has reached its limit on stored QC data and cannot store anymore on that specific card.

A Maximum of **(33)** QC runs can be stored on QC Smart Card. 1 complete QC RUN contains all (3) levels of controls, *Low, Normal, and High*, analyzed 1 time each.

When the card is full, you must insert a New Card and press the “ENTER” key to accept the new card information!

① Select Operator

Once you have accepted the QC Smart card information , the display will prompt you to select an Operator (OP). Use the “Down” arrow key to select one of (4) operators which can be previously programmed in the system set-up menu. See **Section 5 - Instrument Configuration, 3-Special functions, (3.1. Change Operator).**

4 - Select one of the (4) operators and then press the “ENTER” key. A star (*) will be placed next to the chosen operator as indicated on the display:

```
SELECT OP          > * 1 - OP. 1  ▾  
13:22              2 - OP. 2
```

5 - Once the operator has been select, press the “ENTER” key and the menu will be displayed.

① Select Commercial Control Level

The next display to appear will ask you as to which level of commercial control you would like to analyze first. the Display is as indicated:

```
SELECT LEVEL > * 1 - LOW BLOOD  
13:24        2 - NORMAL BLOOD ▾
```

6 - Use the “Down” arrow key to select 1 of 3 levels of commercial control to analyze, *Low, Normal, or High*. Once the selection has been made, press the “ENTER” key to accept that level.

A message “LOADING LEVEL PLEASE WAIT” will be displayed for about one half of a second. The information on the QC Smart card is read at this time. After the information is read off of the card, *ABX MICROS 60* will ask if you want to run the level of commercial control selected as indicated on the display:

```
M211      LOW      START QC  
ESC TO EXIT PRESS START TO ASPIRATE
```

7 - Verify that the lot number on the screen matches the lot # on the Commercial control blood.

① Run Commercial Control Blood

8 - Once the Control blood has equilibrated to room temperature, Gently and thoroughly mix the level of control blood indicated on the display. Follow the product instructions that come with the Minotrol control kit for proper mixing.

9 - Remove the cap and place the vial beneath the sample probe, raise the vial upwards so that the sample probe enters into the blood.

10 - Press the “START” key on the front panel to start the cycle. A brief prime cycle will occur if the *ABX MICROS 60* has not been used in the last 15 minutes. When this brief cycle is complete, the display will indicate:

```
M211      LOW  
PRESS START TO ASPIRATE
```

11 - Press the “START” key or the Manual Sample Bar, the control analysis cycle will begin.

Micros 60

Ⓞ Run Commercial Control Blood continued:

When the control analysis cycle is complete, the results are displayed as indicated:

WBC	RBC	HGB	HCT	△
2.2	2.36	5.6 L	15.9	▽

12 - To view the remaining results on the display, use the “Up” and “Down” arrow keys to scroll through the results.

The control results are printed out as indicated:

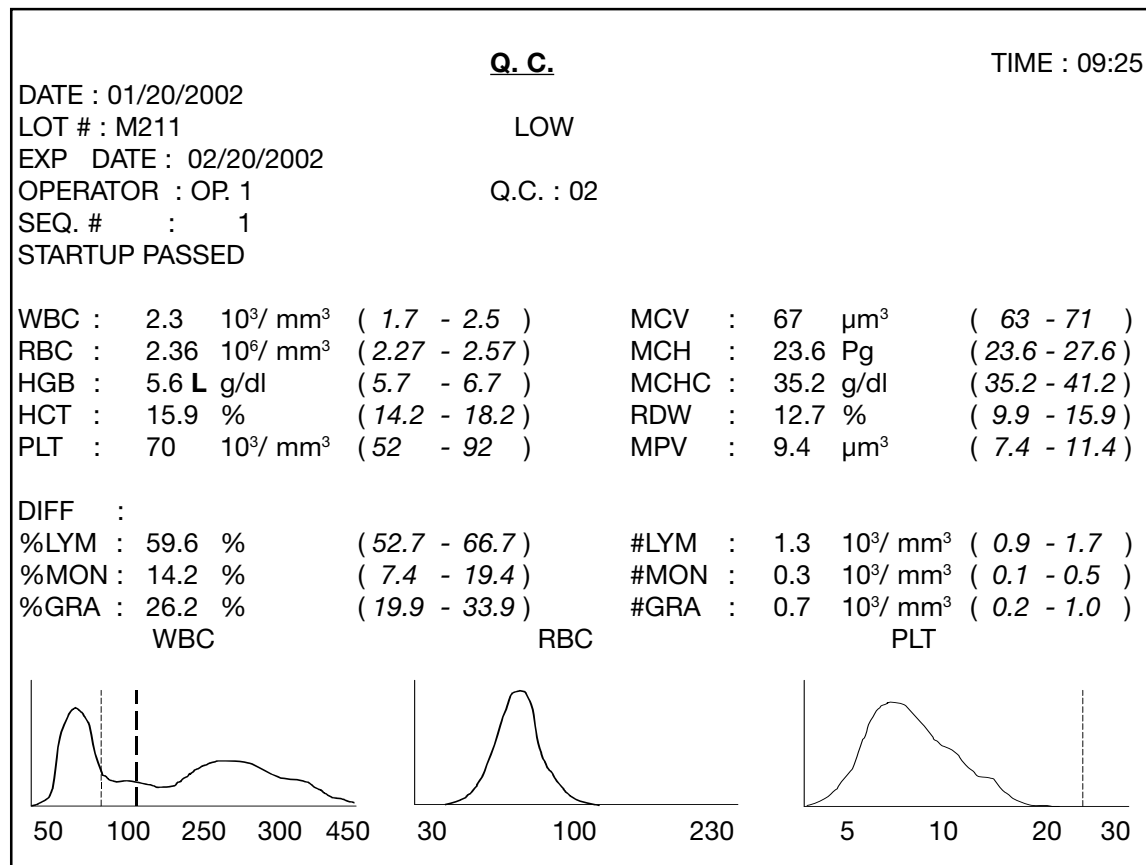

MICROS 60 OS/OT



Note: Printed results may vary on the amount of data displayed on the printout. *Limits, LMG's, Histograms, and Parameters* are all dependant upon the initial instrument setup. See **Section 5 - Instrument Configuration**, 1-Results Options, (*Printout, Print Limits, Print LMG's*).

Micros 60

① Rejecting Results continued:

MICROS 60 OS/OT



Important: If a control level blood displays any Error flags (**H, L, *, \$, !** for HGB) after being analyzed **Twice** in sequence for the same level. **ABORT Q.C.** and contact your local **ABX Technical Support Representative** before continuing with Quality Control analysis!

After pressing any key, the analyzer returns you to the Q.C. menu as indicated on the display:

```
Q.C.          > 1 - AUTOMATIC
09:23        2 - ANALYSIS      ▾
```

① Valid Q.C.

If the QC is accepted and validated, the index is increased on the QC Smart card and the **ABX MICROS 60** internal index is increased as well.

① Invalid Q.C.

If the QC is rejected and not validated, the following message appears on the display:

```
QC NOT VALID
PRESS A KEY TO CONTINUE....
```

Results are not stored on the QC Smart Card at the time of exit.

① Exiting Q.C.- Automatic

If the operator needs to Exit Q.C. at any time before all levels of control bloods are analyzed, it is possible to do so by following these simple steps:

1 - Wait until the cycle of the control level blood being analyzed is complete.

2 - Press the Escape "ESC" key and the **ABX MICROS 60** will ask you if you want to accept or reject the results as indicated on the display:

```
VALID          ? LEVEL      NO : ESC
                                     YES : ENTER
```

3 - Press the escape "ESC" key and the display will return to **START QC** display as indicated:

```
M211          ? LEVEL      START QC
ESC TO EXIT   PRESS START TO ASPIRATE
```

4 - Press the Escape "ESC" key and the **ABX MICROS 60** will ask you if you want **EXIT QC** ? as indicated on the display:

```
EXIT QC ?          NO : ESC
                                     YES : ENTER
```

5 - Press the "ENTER" key and the analyzer will state that control blood results were not stored on the QC Smart card as indicated on the display:

```
QC NOT VALID
PRESS A KEY TO CONTINUE....
```

2.4. Q.C. Analysis

(Without Q.C. Smart Card)

1 - Remove the Minotrol Quality Control blood from the refrigerator and bring it to room temperature.

2 - From the Q.C. Menu, *select 2 - ANALYSIS*. This menu will allow the operator to run a control level blood as a normal analysis cycle "Without" the use of a Smart Card, but with specific LMG Thresholds for control level bloods. (*Independant from the Temperature*)

3 - The **ABX MICROS 60** will display a menu which will ask you for a **LOT #** and show a current lot number if any, as indicated:

```
LOT # : _          EXIT : ESC
CURRENT : M167     SAVE : ENTER
```

4 - Enter a Lot number, anywhere from **1** to **10** Alphanumeric characters. Use the Number keys to enter the numbers directly. Use the "Up" or "Down" arrow keys to select each Alpha character, pressing the "ENTER" key after each Alpha entry.

Calibration & Quality Control

5 - Once you have entered the Lot number, press the "ENTER" key to accept it. A brief HGB Blank reference measurement is performed before the analysis cycle. a Message is displayed as indicated:

PLEASE WAIT.....

6 - When the HGB Blank reference measurement is complete, a message is displayed as indicated:

ANALYSIS
PRESS START TO ASPIRATE

7 - Once the Control blood has equilibrated to room temperature, Gently and thoroughly mix the level of control blood to be analyzed . Follow the product instructions that come with the Minotrol control kit for proper mixing.

8 - Remove the cap and place the vial beneath the sample probe, raise the vial upwards so that the sample probe enters into the blood.

9 - Press the "START" key or press the Manual Sample Bar. The control analysis cycle will begin.

10 - When the analysis cycle is complete, the results are displayed and printed out as on *Page 18 of this Section*.

11 - See *Quality Control Reminder in the next column!!!*

MICROS 60 OS/OT



Caution: When running Quality Control "Without" the use of a Smart Card, pay close attention to the Result parameter Limits, if the system was programmed to print out the limits. These limits "Are not" Quality Control limits. These limits are the ones that were established in the set-up menu. See **Section 5 - Instrument Configuration, 2-Change Laboratory Limits, (2.1./2.2. Result Low Limits and Result High Limits)**. Verify your control results with the Assay sheet that comes with the control material. Verify that each Control level parameter is within its assayed limits!!!

2.5. Q.C. Print Targets

(Only with Q.C. Smart Card)

This Q.C. sub-menu allows you to print out the Assay ranges of all (3) levels of commercial control blood from the Q.C. Smart Card.

1 - Insert the Q.C. Smart Card into the reader with a firm push until it "clicks" into place.

2 - From the Q.C. Menu, *select 3 - PRT. TARGETS*. The display on the **ABX MICROS 60** will show the Lot # identification and Expiration date of the control blood product as indicated:

LOT # M211 NO : ESC
EXP DATE 01/20/02 YES : ENTER

3 - Press the "ENTER" key and the analyzer will load the information from the Q.C. Smart Card and print out all (3) level assay ranges. A message will appear on the display as indicated:

LOADING LEVELS
07:16 PLEASE WAIT....

4 - The printout will show *Low limit* and *High limit* for each parameter, for each assayed level of control. *HIGH, NORMAL, and LOW*.

Micros 60

2.6. Q.C. Statistics (Only with Q.C. Smart Card)

This Q.C. sub-menu allows the operator to print out all the stored cumulative data for all (3) levels on the commercial control blood. The information printed out will contain all the necessary statistical data for each level. The levels can be selected individually or all at once.

MICROS 60 OS/OT



Important: It is highly recommended to print out all Quality Control Statistical data at the end of each month for hard copy verification of control data.

Each File printout contains the following information: *File Name (Blood Level), Lot # of the Control, Expiration date of the control, Date and Time of the print data request, Date and Time of each control run, Operator and Parameter results of each control run, the Reference Assay Mean, Upper, and Lower limits, the Actual Mean results of the total control runs, the 2 Standard Deviation value, and the Percent Coefficient of Variation.*

① Select Statistics

1 - From the Q.C. Menu , select 4 - STATISTICS, then press the “ENTER” key to enter into the sub-menu as indicated on the display:

```
SELECT LEVEL          > * 1 - ALL
13:42                 2 - LOW BLOOD
```

2 - Use the “Down” arrow key to select one of (3) levels to be printed out or select “ALL” to print out a (3) levels. Selection will be indicated on the display:

```
SELECT LEVEL          > * 3 - NORMAL BLOOD
13:56                 4 - HIGH BLOOD
```

3 - Once your selection has been made, press the “ENTER” key to print out the statistical data. The display will state as indicated:

```
LOADING LEVEL
14:06                PLEASE WAIT...
```

```
PROCESSING RESULTS
14:06                PLEASE WAIT...
```

```
SENDING RESULTS
14:06                PLEASE WAIT...
```

Calibration & Quality Control

5 - When the statistical data has been printed out, it will state as indicated below:

6 - Maintain a copy of these results each month for Quality Control Analysis verification!

<u>Q.C.</u>											
NORMAL										TIME : 07 : 31	
LOT # : M211										DATE : 03/01/02	
EXP DATE : 02/20/02											
No	DATE	TIME	OP	WBC	RBC	HGB	HCT	MCV	MCH	MCHC	PLT
1	01/03/02	09:57	OP. 2	7.4	4.58	13.6	36.3	79	29.7	37.5	279
2	01/04/02	08:23	OP. 1	7.3	4.52	13.2	35.3	78	29.2	37.4	247
3	01/05/02	10:57	OP. 3	7.3	4.47	13.4	35.2	79	29.9	38.0	254
--	-----	-----	-----	----	-----	-----	-----	----	-----	-----	-----
--	-----	-----	-----	----	-----	-----	-----	----	-----	-----	-----
ETC.....											
REFERENCE :											
				WBC	RBC	HGB	HCT	MCV	MCH	MCHC	PLT
MEAN				7.4	4.52	13.4	35.7	79	29.6	37.5	249
LOW				6.8	4.34	12.8	33.7	75	27.6	34.5	219
HIGH				8.0	4.70	14.0	37.7	83	31.6	40.5	279
ACTUAL :											
				WBC	RBC	HGB	HCT	MCV	MCH	MCHC	PLT
MEAN				7.4	4.54	13.3	35.5	78	29.4	37.5	252
2SD				0.13	0.06	0.16	0.59	0.63	0.43	0.53	11.22
C V				1.70	1.37	1.18	1.67	0.80	1.46	1.40	4.45
ETC.....											

Micros 60

2.7. Q.C. Graphs (Only with Q.C. Smart Card)

The **ABX MICROS 60** plots Levey-Jennings charts for each parameter of the Quality Control files stored on the Q.C. Smart card. Each Levey-Jennings chart will plot (1) data point per parameter, per control run, for every control data point stored.

① Select Graphs

1 - From the Q.C. Menu, select 5 - GRAPHS, then press the "ENTER" key to enter into the Graphs sub-menus as indicated on the display:

```
SELECT LEVEL          > * 1 - ALL
13:42                2 - LOW BLOOD
```

2 - Use the "Down" arrow key to select one of (3) levels to be printed out or select "ALL" to print out a (3) levels. Selection will be indicated on the display:

```
SELECT LEVEL          > * 3 - NORMAL BLOOD
13:56                4 - HIGH BLOOD
```

3 - Once your selection has been made, press the "ENTER" key to print out the Levey-Jennings charts. The display will state as indicated:

```
LOADING LEVEL
14:06                PLEASE WAIT...
```

```
PROCESSING RESULTS
14:06                PLEASE WAIT...
```

```
SENDING RESULTS
14:06                PLEASE WAIT...
```

4 - The parameter charts are determined by the internal software setup of the **ABX MICROS 60**. See **Section 1 - Specifications**, 1. Technical Specifications, (1.1. Parameters) for the parameters that are printed out on the Levey-Jennings charts.

MICROS 60 OS/OT



Note: Printed results may vary on the amount of data displayed on the printout. *Limits, LMG's, Histograms, and Parameters* are all dependant upon the initial instrument setup. See **Section 5 - Instrument Configuration**, 1-Results Options, (*Printout, Print Limits, Print LMG's*).

Calibration & Quality Control

Levey-Jennings charts are printed out with the following information included: *File Name (Blood Level), Lot # of the Control, Expiration date of the control, Date and Time of the print data request, the Parameter Name, and the Parameter graph with (40) total data points.* Below each graph, the *Reference Assay Mean, Upper, and Lower limits, the Actual Mean results of the total control runs, the 2 Standard Deviation value, and the Percent Coefficient of Variation.*

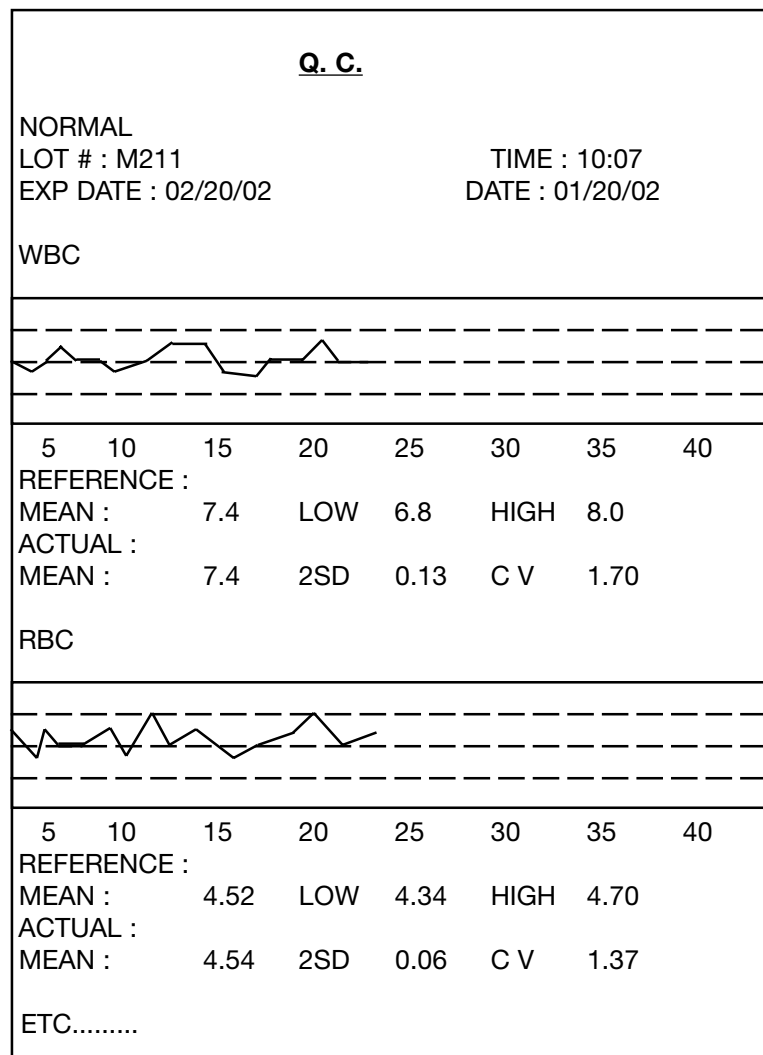

MICROS 60 OS/OT



Note: Q.C. Graphs will be printed out even when the parameter results are equal to zero!

Micros 60

Instrument Configuration

1. RESULTS OPTIONS	2	7. MEMORY CARD (Patient samples "Only")	17
1.1. Reprint results	2	7.1. Memo On / Off	18
1.2. Printout	2	7.2. Running patient samples	18
1.3. Units	3	7.3. Transmission of results	19
1.4. Printer selection	4	7.4. Print List	19
1.5. Temperature printout	4	7.5. Reprint one result (TR. ONE)	20
1.6. Print limits	4	7.6. Reprint all results (TR. ALL)	20
1.7. Print LMG results	5	7.7. Print From / to	20
		7.8. Clear Card	21
2. CHANGE LABORATORY LIMITS	5		
2.1. Results Low limits	5		
2.2. Results High limits	6		
2.3. Print Limits and Flag values	6		
2.4. Morphology Flag limits	8		
3. SPECIAL FUNCTIONS	10		
3.1. Change Operator	10		
3.2. Change Password	11		
3.3. Startup cycle	12		
3.4. Autocleaning frequency	12		
3.5. Print Instrument configuration	13		
3.6. Buzzer (audible signal)	14		
3.7. Sample Identification mode	14		
4. DATE AND TIME	15		
4.1. Change Time	15		
4.2. Change the Date format	15		
4.3. Change the date	15		
5. HOST COMPUTER OPTIONS	16		
5.1. Host communications	16		
5.2. Baud rate	16		
5.3. Transmission Send	17		
6. BARCODE SETUP	17		

Micros 60

① Menu/Setup

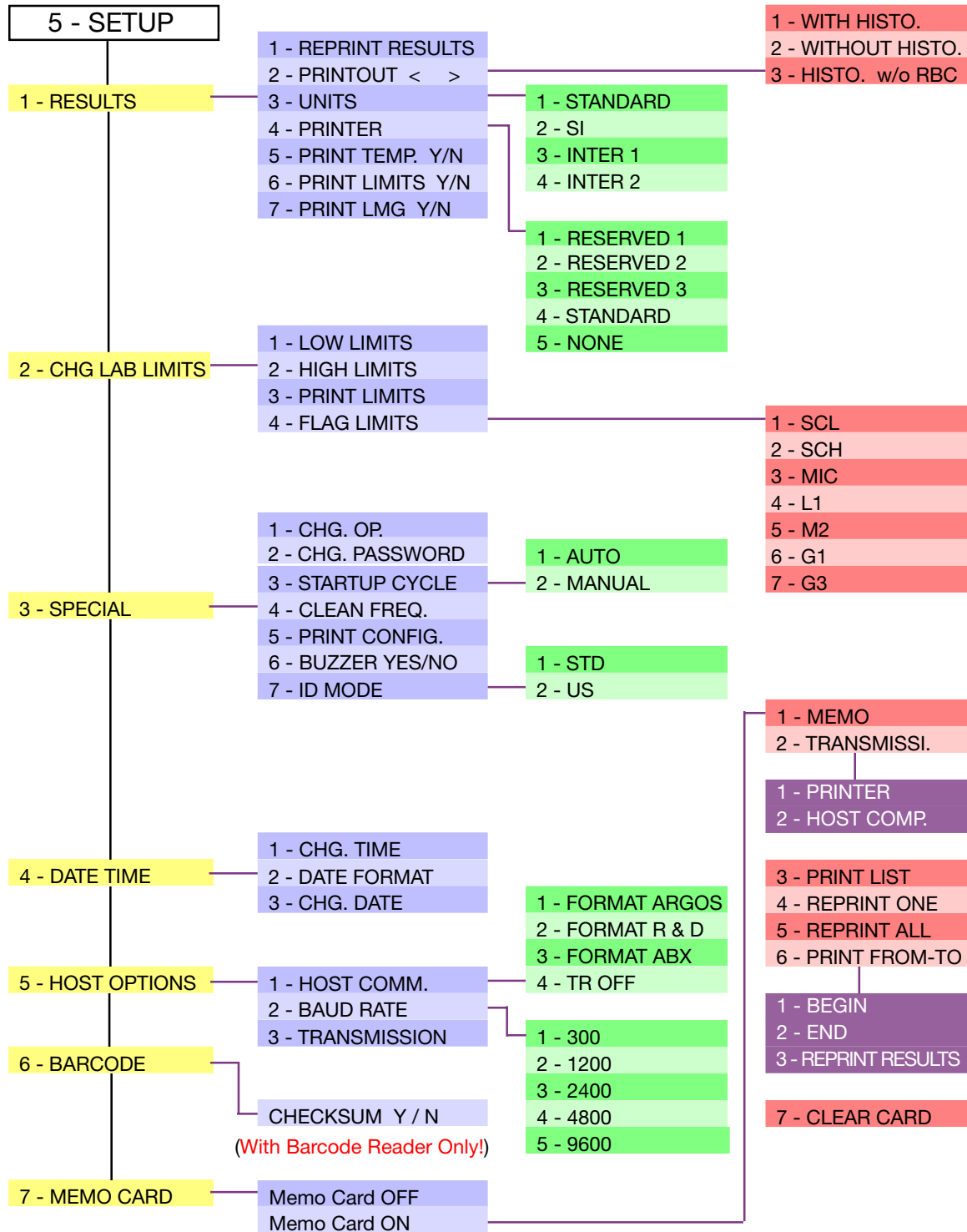

Instrument Configuration

The **ABX MICROS 60** has several operator options in this section.

- Specific Laboratory limits
- Date and Time formats
- Results format
- RS 232 options
- Special functions

These options can be configured according to the operator's needs, through the SETUP Menu functions.

Ⓞ Access Setup Menu

To access the Set-up Menu, from the Main Menu, use the "Down" arrow key and select 5 - *SETUP*, then press the "ENTER" key. Or select the number "5" key on the number pad. *MAIN MENU, 5 - SETUP.*

1. Results Options

The 1 - RESULTS Sub-menu will allow the operator to access and edit some of the following sub-menu functions, such as:

- Reprint the result of the last sample in the system Memory.
- To select the Histograms to be printed out or not to be printed out on the results.
- To select the Unit of Measurement type.
- To select the type of printer.
- To select the Temperature to be printed out or not to be printed out on the results.
- To select the Patient Parameter limits to be printed out or not to be printed out on the results.
- To select the LMG's (*Lymphs, Monos, and Grans*) to be printed out or not to be printed out on the results. (*Available only for ABX MICROS 60-OS/OT16 or OS/OT18 parameter analyzers*)

From the Set-up Menu, select 1 - *RESULTS*, then press the "ENTER" key to enter into the Results sub-menu. As shown on the display:

```
SETUP          > 1 - RESULTS
10:20          2 - CHG LAB LIMITS
```

1.1. Reprint Results

This sub-menu allows the operator to reprint the results of the last sample ran.

MICROS 60 OS/OT



Important: The **ABX MICROS 60** will only hold (1) result in the system Memory. This result is usually the very last sample analyzed, either a Patient sample or a Quality Control level blood only! A Calibrator blood result is stored in an entirely different system format.

1 - From the Results Menu, select 1 - *REPRINT RESULTS*, as indicated on the display:

```
RESULTS      > 1 - REPRINT RESULTS
10:26        2 - PRINTOUT < > ▾
```

2 - The last results in memory will automatically printout with the following information:

- Date and Time,
- the associated Identification,
- Sample run and Sequence Number,
- Possible Flags if any,
- the Histograms (*if selected in the setup*).

1.2. Printout

This sub-menu allows the operator select or not to select the WBC, RBC, and PLT Histograms for the results printout.

1 - From the Results Menu, select 2 - *PRINTOUT* using the "Down" arrow key, as indicated on the display:

```
RESULTS      1 - REPRINT RESULTS
10:26        > 2 - PRINTOUT < > ▾
```

There are (3) options in the Printout Menu as followed:

- Results printed out *WITH HISTOGRAMS*
- Results printed out *WITHOUT HISTOGRAMS*
- Results printed out *WITHOUT RBC HISTOGRAM*

Micros 60

① Printout continued:

2 - Use the “Up” or “Down” arrow keys to make your selection of the (3) OPTIONS as indicated on the display:

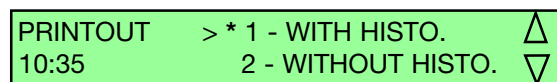

From the Results Menu, use the “Down” arrow key to select 3 - UNITS.

1 - Use the “Down” arrow to move the cursor to select the Units required for your applications, as indicated on the display:

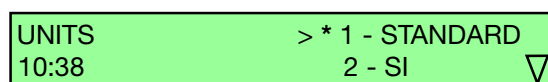

MICROS 60 OS/OT



Note: The Printout WITHOUT RBC HISTOGRAMS option is Highly recommended on the CITIZEN Model printer. This option gives less print time on the Citizen printer.

3 - Press the “ENTER” key once you have made your selection.

1.3. Units

This sub-menu allows the operator to select between (4) different Units of Measurement. These Units vary from Country to Country and are designed for International applications. The choices are listed on the chart as indicated:

The Units are as listed:

- 1 - *STANDARD*, used in the United States and in most European countries.
- 2 - *SI*, used in some European countries and in Research Laboratories.
- 3 - *INTER 1*, are used Internationally, but Not in the United States.
- 4 - *INTER 2* are used Internationally, but Not in the United States.

2 - Once your selection has been made, press the “ENTER” key to accept your choice.

Parameters					
	Units	Standard	SI	International 1	International 2
Country		U.S. / Eur.	Eur. / R Lab	Not in U.S.	Not in U.S.
WBC		10 ³ / mm ³	10 ⁹ /L	10 ³ / mm ³	10 ⁹ /L
RBC		10 ⁶ / mm ³	10 ¹² /L	10 ⁶ / mm ³	10 ¹² /L
HGB		g/dl	mmol/L	g/dl	g/L
HCT		%	l/L	%	l/L
PLT		10 ³ / mm ³	10 ⁹ /L	10 ³ / mm ³	10 ⁹ /L
MCV		µm ³	fl	fl	fl
MCH		pg	fmol	pg	pg
MCHC		g/dl	mmol/L	g/dl	g/L
MPV		µm ³	fl	fl	fl
LYM %		%	%	%	%
LYM #		#	#	#	#
MON %		%	%	%	%
MON #		#	#	#	#
GRA %		%	%	%	%
GRA #		#	#	#	#

R Lab. = Research Laboratories

Instrument Configuration

1.4. Printer Selection

This sub-menu allows the operator to select the type of printer to be used along with the **ABX MICROS 60**. There are (4) basic different model types of printers that are specifically designed to operate with the **ABX MICROS 60** analyzer.

To enter into the Printer sub-menu, from the Results Menu, use the “Down” arrow key and select 4 - PRINTER. press the “ENTER” key to enter into this sub-menu as indicated on the display:

```
PRINTER          > * 1 - RESERVED 1  ▲
10:42           2 - RESERVED 2  ▼
```

1 - Use the “Down” arrow to select the printer type and press the “ENTER” key to accept that selection.

The Printer types are as listed:

- 1 - RESERVED 1, for (Epson LX series) printers.
- 2 - RESERVED 2, for (Star) printers.
- 3 - RESERVED 3, for (Seiko Thermal) printers.
- 4 - STANDARD, for (Citizen Dot Matrix) printers.
- 5 - NONE, for (Use with External Computers).

MICROS 60 OS/OT



Note: The (5 - NONE) printer selection is used for an External Computer that is specifically use as an Extended Q.C. Package or and L.I.S. connection. This selection is also used if a printer is not going to be used in conjunction with the **ABX MICROS 60** analyzer.

2 - Once the Printer type has been selected, verify that a result will print from your selection.

3 - From the Set-up Menu, select 1 - RESULTS, 1 - REPRINT RESULTS. Now verify that the last result ran will transmit to the printer and printout from the printer selection previously made.

1.5. Temperature Printout

This sub-menu allows the operator to have visual confirmation of the Diluent Temperature displayed on the results printout.

MICROS 60 OS/OT



Important: The operating temperature of the Diluent during analysis must remain between the specified limits (18° C - 32° C) or (65° F to 85° F). Results obtained in temperatures outside these limits are questionable and may not be valid!!!

To enter into the Print Temp sub-menu, from the Results Menu, use the “Down” arrow key and select 5 - PRINT TEMP.Y/N, then press the “ENTER” key. The display will show as indicated:

```
RESULTS 4 - PRINTER <RESERVED 1> ▲
10:45   > 5 - PRT. TEMP. <NO     > ▼
```

1 - Use the “Up” or “Down” arrow keys to select
1 - YES, Print with Temperature
2 - NO, Print without Temperature
then press the “ENTER” key to accept the change as indicated on the display:

```
PRT. TEMP.          > 1 - YES  ▲
10:46              * 2 - NO    ▼
```

The asterisk (*) indicates the current state

1.6. Print Limits

This sub-menu allows the operator to have the option of printing out the Laboratory Limits with the results printout.

To enter into the Print Limits sub-menu from the Results Menu, use the “Down” arrow key to select 6 - PRINT LIMITS Y/N, then press the “ENTER” key. The display will indicate the selection:

Micros 60

① **Print Limits** continued:

PRT. LIMITS	> * 1 - YES	▲
10:46	2 - NO	▼

The asterisk (*) indicates the current state.

1 - Use the “Up” or “Down” arrow keys to select
 1 - YES, print “With” limits
 2 - NO, print “Without” limits
 then press the “ENTER” key to accept the change.

1.7. Print LMG Results

MICROS 60 OS/OT



Note: This Menu function is available “Only” on **ABX MICROS 60-16 and 18** parameter systems!

This sub-menu allows the operator to have the option of printing out the 3 part Differential results with the results printout.

To enter into the Print LMG results sub-menu from the Results Menu, use the “Down” arrow key to select 7 - PRINT LMG Y/N, then press the “ENTER” key. The display will indicate the selection:

PRT. LMG	> * 1 - YES	▲
10:46	2 - NO	▼

The asterisk (*) indicates the current state.

1 - Use the “Up” or “Down” arrow keys to select
 1 - YES, print “With” LMG results
 2 - NO, print “Without” LMG results
 then press the “ENTER” key to accept the change.

2. Change Laboratory Limits

MICROS 60 OS/OT



Note: Laboratory Limits are commonly known as Normal Patient Ranges. These Limits will vary with Population and/or Geographical location. The Default limits set on the **ABX MICROS 60** are based on a study of Normal, Healthy, and Drug-free individuals. Your limits may vary based upon the Applications for intended use!

The 2 - CHG LAB LIMITS sub-menu will allow the operator to access and edit some of the following sub-menu functions, such as:

- Changing the Low parameter Laboratory limits
- Changing the High parameter Laboratory limits
- Printing the Current Laboratory limits
- Changing all Morphology Flag limits.

From the Set-up Menu, select 2 - CHG LAB LIMITS, then press the “ENTER” key to enter into the Chg. Lab. Limits sub-menu. As shown on the display:

SETUP	1 - RESULTS	▲
10:20	> 2 - CHG LAB LIMITS	▼

1 - Use the “Up” or “Down” arrow keys to select the 1 - LOW LIMITS sub-menu as indicated on the display:

2.1. Results Low Limits

CHG LAB LIMITS	> 1 - LOW LIMITS	▲
10:25	2 - HIGH LIMITS	▼

2 - Press the “ENTER” key to enter into the parameter Low Limits sub-menu as indicated on the display:

LOW LIMITS	> 1 - WBC LOW < 3.50 >	▲
10:25	2 - RBC LOW < 3.80 >	▼

Instrument Configuration

Ⓞ Results Low Limits continued:

3 - Select 1 - WBC LOW and Press the “ENTER” key to edit the WBC Low value as indicated on the display:

```
WBC LOW ? : _      EXIT : ESC
CURRENT : 3.50     SAVE : ENTER
```

4 - Enter the New value with the “Number” keys and use the “Decimal” (.) key for placing the decimal point in the correct order.

5 - Once you have entered the correct value, press the “ENTER” key to accept the change. The display will return to the LOW LIMITS Menu as indicated:

```
LOW LIMITS > 1 - WBC LOW < 3.50 > Δ
10:25        2 - RBC LOW < 3.80 > ▽
```

6 - Use the “Up” or “Down” arrow keys to select the next Low Parameter to be edited.

7 - Repeat Steps 4 through 6 to edit the remaining Low parameters.

8 - Once you have edited the necessary parameters, press the Escape “ESC” key to exit back to the Chg. Lab Limits Menu as indicated on the Display:

```
CHG LAB LIMITS > 1 - LOW LIMITS Δ
10:25          2 - HIGH LIMITS ▽
```

2.2. Results High Limits

1 - Use the “Up” or “Down” arrow keys to select the 2 - HIGH LIMITS sub-menu as indicated on the display:

```
CHG LAB LIMITS 1 - LOW LIMITS Δ
10:25          > 2 - HIGH LIMITS ▽
```

2 - Press the “ENTER” key to enter into the parameter High Limits sub-menu as indicated on the display:

```
HIGH LIMITS > 1 - WBC HIGH < 10.00 > Δ
10:25        2 - RBC HIGH < 5.80 > ▽
```

3 - Select 1 - WBC HIGH and Press the “ENTER” key to edit the WBC High value as indicated on the display:

```
WBC HIGH ? : _      EXIT : ESC
CURRENT : 10.00     SAVE : ENTER
```

4 - Enter the New value with the “Number” keys and use the “Decimal” (.) key for placing the decimal point in the correct order.

5 - Once you have entered the correct value, press the “ENTER” key to accept the change. The display will return to the HIGH LIMITS Menu as indicated:

```
HIGH LIMITS > 1 - WBC HIGH < 10.00 > Δ
10:25        2 - RBC HIGH < 5.80 > ▽
```

6 - Use the “Up” or “Down” arrow keys to select the next High Parameter to be edited.

7 - Repeat Steps 4 through 6 to edit the remaining High parameters.

8 - Once you have edited the necessary parameters, press the Escape “ESC” key to exit back to the Chg. Lab Limits Menu as indicated on the Display:

```
CHG LAB LIMITS 1 - LOW LIMITS Δ
10:25          > 2 - HIGH LIMITS ▽
```

2.3. Print Limits

This CHG LAB LIMITS sub-menu allows the operator to printout the current Laboratory Limits and Morphology Flag values.

1 - From the Chg. Lab Limits Menu, use the “Down” arrow key to select 3 - PRINT LIMITS as indicated on the display:

```
CHG LAB LIMITS 2 - HIGH LIMITS Δ
10:25          > 3 - PRT. LIMITS ▽
```

2 - Press the “ENTER” key. The current Laboratory Limits will automatically print out as indicated on page 7 in this section.

Micros 60

Laboratory Limits are printed as followed:

		LIMITS	
DATE : 01/20/2002		TIME : 10:54	
		LOW	HIGH
WBC	:	3.5	10.0 10 ³ / mm ³
RBC	:	3.80	5.80 10 ⁶ / mm ³
HGB	:	11.0	16.5 g/dl
HCT	:	35.0	50.0 %
MCV	:	80	97 μm ³
MCH	:	26.5	33.5 pg
MCHC	:	31.5	35.0 g/dl
PLT	:	150	390 10 ³ / mm ³
MPV	:	6.5	11.0 μm ³
RDW	:	10.0	15.0 %
%LYM	:	17.0	48.0 %
%MON	:	4.0	10.0 %
% GRA	:	43.0	76.0 %
# LYM	:	1.2	3.2 10 ³ / mm ³
# MON	:	0.3	0.8 10 ³ / mm ³
# GRA	:	1.2	6.8 10 ³ / mm ³
PLT Flags	:		
SCL%	:	8.0	
SCH%	:	8.0	
MIC%	:	8.0	
WBC Flags	:		
L1%	:	8.0	
M2%	:	8.0	
G1%	:	15.0	
G3%	:	8.0	

3 - Once the Limits have printed out, Verify your entries. Check each parameter to make sure that you have entered the correct number and placement of the decimal point.

MICROS 60 OS/OT



Note: PCT and PDW are not available in the United States. These parameters are strictly use for Research and Investigational purposes "Only"!

Instrument Configuration

2.4. Morphology Flag Limits

MICROS 60 OS/OT



Important: The Factory “Default” flag values programmed on the **ABX MICROS 60** were set, based on a study of Normal cell populations. These Default values can be adjusted to accommodate specific Populations and/or Geographical locations based on those specific studies. It is highly recommended to maintain the Default values unless population and/or geographical location studies are known!

MICROS 60 OS/OT



Important: Numerous factors can contribute to constant Morphology flagging. If you are experiencing constant flagging, see **Section 8 - Maintenance and Troubleshooting**, (Morphology flags). Also see **Section 1 - Specifications**, 4 - Limitations, (4.3. Known Interfering substances, PLT).

This CHG. LAB LIMITS sub-menu allows the operator to adjust the Morphology flag percentages to the specific needs of the population and/or geographical location.

All the Morphology flag percentages can be adjusted from **(0.01% to 25.00%)**.

-If you **“Lower”** the present Default percentages of the flags, you will make the flagging criteria **“More Sensitive”** and may increase your flagging alarms on sample analysis!

- If you **“Raise”** the present Default percentages of the flags, you will make the flagging criteria **“Less Sensitive”** and may decrease your flagging alarms on sample analysis!

① Platelet Flags

Factory Default adjustment values are as indicated:

SCL : 8.00
SCH : 8.00
MIC : 8.00

To enter into the Flag Limits menu from the Chg. Lab Limits menu, use the “Down” arrow key to 4 - **FLAG LIMITS**.

1 - Press the “ENTER” key to enter into this sub-menu as indicated on the display:

```
FLAG LIMITS      > 1 - SCL < 8.00 >  Δ
10:56            2 - SCH < 8.00 >  ▽
```

2 - Use the “Down” arrow key to select the Morphology flag that you would like to edit.

3 - Once your selection has been made, press the “ENTER” key to edit that value which is indicated:

```
SCL   ? : _      EXIT : ESC  Δ
CURRENT : 8.00   SAVE : ENTER ▽
```

4 - Use the “Number” keys and the “Decimal (.)” key for placing the decimal point in the correct order. Once you have entered the correct number, press the “ENTER” key to accept the New value. The display will return to the Flag Limits menu as indicated.

```
FLAG LIMITS      > 1 - SCL < 8.00 >  Δ
10:56            2 - SCH < 8.00 >  ▽
```

5 - Use the “Up” or “Down” arrow keys to select the next Flag Limit to be edited.

6 - Repeat Steps **3 through 5** to edit the remaining Flag Limits if necessary.

7 - Once you have edited the necessary Flag Limits, press the Escape “ESC” key to exit back to the Chg. Lab Limits Menu as indicated on the Display:

```
CHG LAB LIMITS   3 - PRINT LIMITS Δ
11:03            > 4 - FLAG LIMITS  ▽
```

Micros 60

Ⓞ WBC Morphology Flags

MICROS 60 OS/OT



Important: The WBC Morphology flags may also be adjusted by the operator according to the populations of samples to be analyzed. Hospitals, Reference Laboratories, and Outpatient facilities have different flagging criteria depending on the areas of specialty. Note the area of Specialty before making any adjustments!

Factory Default adjustment values are as indicated:

L1 : 8.00
M2 : 8.00
G1 : 15.00
G3 : 8.00

1 - From the Flag Limits Menu, use the “Down” arrow key to option 4 - L1. press the “ENTER” key to edit the L1 value as indicated:

```
FLAG LIMITS      3 - SCL < 8.00 >  Δ
10:56           > 4 - L 1 < 8.00 >  ▽
```

2 - Press the “ENTER” key to edit the flag value as indicated:

```
L1      ? : _      EXIT : ESC  Δ
CURRENT : 8.00    SAVE : ENTER ▽
```

3 - Use the “Number” keys and the “Decimal (.) key for placing the decimal point in the correct order. Once you have entered the correct number, press the “ENTER” key to accept the New value. The display will return to the Flag Limits menu as indicated.

```
FLAG LIMITS      > 4 - L 1 < 8.00 >  Δ
10:57           5 - M 2 < 8.00 >  ▽
```

4 - Use the “Up” or “Down” arrow keys to select the next Flag Limit to be edited.

5 - Repeat Steps **2 through 4** to edit the remaining Flag Limits if necessary.

6 - Once you have edited the necessary Flag Limits, press the Escape “ESC” key to exit back to the Chg. Lab Limits Menu as indicated on the Display:

```
CHG LAB LIMITS   3 - PRINT LIMITS  Δ
11:03           > 4 - FLAG LIMITS  ▽
```

3. Special Functions

The 3 - SPECIAL sub-menu will allow the operator to access and edit some of the following sub-menu functions, such as:

- Changing (4) Operator identifications
- Changing the User Password if necessary.
- Choosing the STARTUP Modes.
- Changing the cycle number for the cleaning frequency.
- Printing the Internal Instrument Setup.
- Turning the audible cycle signal ON or OFF.
- Choosing the Identification mode.
- Choosing the START analysis mode.

To enter into the Special Functions Menu from the 5 - SETUP Menu, use the “Down” arrow key to *select 3 - SPECIAL* as indicated.

```
SETUP           2 - CHG LAB LIMITS  Δ
11:06          > 3 - SPECIAL        ▽
```

1 - Press the “ENTER” key to access the Special Functions Menu. The display will ask for a “Password” to be entered as indicated:

```
PASSWORD ? : _
```

2 - Enter the system Default password < **123** > then press the “ENTER” key. *The password will not be visible to the operator as it is being entered.*

Instrument Configuration

MICROS 60 OS/OT



Note: The system Default password is normally set as (123). If you enter this password correctly and display still indicates 3 - SPECIAL, call your local *ABX Technical Support Representative* for further instructions!

3.1. Change Operator

Once you have entered the Special Functions menu, the first sub-menu option will give the operator the ability to change the Operator Identifications for (4) different operators.

Some of the Instrument functions such as (*Quality Control and Calibration*) ask for an operator identification when utilizing these functions. The (4) different operator identifications can be modified at any time by the user.

1 - From the Special Menu, select 1 - CHG. OP. then press the "ENTER" key to access that sub-menu as indicated:

```
SPECIAL > 1 - CHG. OP.
11:10 > 2 - CHG. PASS. < 123 > ▾
```

2 - Select one of any (4) operator ID's to be edited as indicated:

```
CHG. OP. > * 1 - O.P. 1 < O.P. 1 >
11:12 > 2 - O.P. 2 < O.P. 2 > ▾
```

When entering an operator identification, the user has the ability to enter up to (4) Alphanumeric characters. Use the "Number keys" to enter up to 4 numbers or use the "Up" or "Down" arrow keys to enter Alphabetical characters. Press the "ENTER" key after entering "Each Alpha character".

3 - Press the "ENTER" key to edit the operator selected as indicated:

```
O.P. 1 ? : _ EXIT : ESC
CURRENT : O.P. 1 SAVE : ENTER
```

4 - Once you have edited the operator ID, press the "ENTER" key to return to the Change Operator CHG. O.P. Menu.

5 - Use the "Up" or "Down" arrow keys to select the next operator ID to be edited.

6 - Repeat Steps 3 through 5 to edit the remaining operator ID's.

3.2. Change (the User) Password

This Instrument password is an important step in accessing some of the Menus in the Instrument program setup. The use of this password allows the operator to:

- Change the Calibration Coefficients.
- Enter the Special Functions Menu.
- Change the Password itself.

1 - From the Special Menu, select 2- CHG. PASSWORD then press the "ENTER" key to access that sub-menu as indicated:

```
SPECIAL 1 - CHG. OP.
11:10 > 2 - CHG. PASS. < 123 > ▾
```

2 - Use the "Number" keys to enter any combination of (3) numbers as indicated:

```
CHG.PASS. ? : _ EXIT : ESC
CURRENT : 123 SAVE : ENTER
```

MICROS 60 OS/OT



Important: If the user edits the Default password from (123) to any other combination of numbers, it is mandatory to record this new number and have it accessible to all users who need access to the menu functions which require this password! This will secure specific operator intervention in these menus!!!

3 - Press the "ENTER" key to accept the password change. Press the Escape "ESC" to save the previous password.

Micros 60

3.3. Start-up Cycle

The STARTUP cycle is used daily, prior to any normal operation to ensure that Detergent from the STANDBY cycle is completely rinsed out of the system.

This daily STARTUP cycle is very important to operation of the system. It includes a Background count which must be verified prior to any analysis of samples. This is necessary to ensure that there are “No” extraneous interferences that may be detected as background noise which will affect the cell count.

See **Section 5 - Startup and Sample Run, 1 - Startup Checks, (1.4. Instrument Startup)** for more information regarding Startup.

This Special functions sub-menu will allow the operator to choose between an Automatic or a Manual Startup.

To enter into the Startup menu from the 3 - SPECIAL Menu, use the “Down” arrow key and *select 3 - STARTUP* as indicated:

```
SPECIAL    2 - CHG. PASS. < 123 > ▲
11:13      > 3 - STARTUP  < AUTO > ▼
```

1 - Press the “ENTER” key to access this sub-menu.

2 - Choose between 1 - AUTO or 2 - MANUAL for your instrument Startup choices as indicated:

```
STARTUP    > * 1 - AUTO  ▲
11:20      2 - MANUAL  ▼
```

The Asterisk (*) indicates the current selection

1- AUTO, will automatically run a Startup after the instrument warmup period, once the **ABX MICROS 60** has been powered “ON”.

2 - MANUAL, will allow the operator to Manually press the “STARTUP” key to initiate the Instrument Startup cycle after instrument warmup.

3 - Press the “ENTER” key to accept the change once you have made your selection.

MICROS 60 OS/OT



Note: If the message “STARTUP NOT INITIATED” appears on the display after selecting the mode for startup, press the Escape “ESC” key until you return to the Main Menu then press the “STARTUP” key to initiate the Startup cycle. This will prevent the “STARTUP NOT INITIATED” message from appearing on the printout of any analysis cycle run prior to instrument Stratup.

3.4. Autocleaning frequency

This sub-menu allows the operator to change the cycle frequency of the automatic cleaning cycle which occurs when the cycle number programmed, has been reached.

The Default Cleaning cycle number is factory set to **(50)** analysis cycles. The user has the option of changing this number from **(1 to 99,999)**.

This Automatic Cleaning cycle involves the use of the solution ABX Miniclean which is an enzymatic cleaner. This solution breaks down protien buildup in the Counting Chambers and Apertures.

To enter into this sub-menu from the 3 - SPECIAL Menu, use the “Down” arrow key and *select 4 - CLEAN_FREQ.* as indicated:

```
SPECIAL    3 - STARTUP  < AUTO > ▲
11:13      > 4 - CLEAN_FREQ. < 50 > ▼
```

1 - Press the “ENTER” key to enter into Clean Frequency Menu as indicated on the display:

```
CLEAN_FREQ. ? : _      EXIT : ESC
CURRENT : 50           SAVE : ENTER
```

Instrument Configuration

MICROS 60 OS/OT



Important: It is Highly recommended to set this cycle number based on the number of analysis cycles run during each operating day. All facilities are different as to the number of blood samples run each day. If the operator knows the number of samples to set the cleaning cycle by, they may do so in the following procedures listed below. If the operator has any questions regarding the autoclean frequency, contact your local **ABX Technical Support Representative** for suggestions about specific applications.

2 - Enter the desired number of the analysis cycles to be run before cleaning, as indicated:

```
CLEAN FREQ. ? : _      EXIT : ESC
CURRENT : 50          SAVE : ENTER
```

3 - Press the "ENTER" key to accept the new number or press the Escape "ESC" key to save the previous number.

3.5. Print Instrument Configuration

(Internal Setup in System Memory)

This sub-menu allows the operator to print out the internal Instrument settings from all the menus which allow user intervention.

To enter into the Internal setting print menu, from the 3 - SPECIAL Menu, use the "Down" arrow key to 5 - PRINT CONFIG. as indicated on the display:

```
SPECIAL      4 - CLEAN FREQ. < 50 > ▲
11:30        > 5 - PRT. CONFIG. ▼
```

1 - Press the "ENTER" key to print out the internal instrument setup. The LCD Display will indicate:

```
PRT. CONFIG.
11:32        PLEASE WAIT....
```

The following information will be printed out as noted:



- Date and Time of print request.
- Laboratory Limits and Flag values.
- Instrument Configuration heading.
- Date and Time of print request.
- Last operator to use Quality Control.
- Latest Calibration Lot Number
- The most current Calibration Coefficients and last calibrator Target values
- The most current RDW calibration coeff.
- Most current instrument software version.
- Type of analyzer
- Open or Closed tube system
- Reagent Pack, Yes or No, "Yes" for Reagent pack. "No" for separate Reagents.
- Startup mode
- Number of parameters that the instrument reports.
- Cycle alarm On or Off. (audible tone)
- Type of Unit Measurements.
- Type of printer selected.
- result printout options with or without histograms.
- Print out the LMG's, Yes or No.
- Print the Laboratory limits with the results, Yes or No.
- Type of Host Computer communications.
- Barcode reader, Yes or No.
- Checksum with barcode reader, Yes or No.
- The date format MM-DD-YY or DD-MM-YY
- Sample Identification mode
- Smart Card reader, Yes or No.
- The Memo card option, On or Off.
- The Instrument Run mode set for USER and USER "Only"!
- The Cycle Start mode, Auto or Manual.
- The temperature of the Diluent
- The last (5) digits of the Instrument serial number. Complete number is on the back panel of the unit.
- The Number of Startup cycles ran.
- The Number of Standby cycles ran.
- The number of CBC cycles ran.
- The number of cycles to be run before the cleaning cycle starts.
- The User Password.
- The Number of samples to be run during calibration.
- Stepper motor steps.
- (4) operator ID's

Micros 60

3.6. Buzzer (audible signal) Cycle End

This sub-menu allows the operator to set an audible tone “Beep” when the analysis cycle is complete.

To enter into the Buzzer Menu from the 3 - SPECIAL Menu, use the “Down” arrow key to 6 - BUZZER Y/N as indicated on the display:

```
SPECIAL 5 - PRT. CONFIG.   
11:30 > 6 - BUZZER Y/N < YES > 
```

1 - Press the “ENTER” key to access this sub-menu.

2 - Use the “Up” or “Down” arrow keys to make your selection and then press the “ENTER” key to accept the choice.



3.7. Sample Identification Mode

This sub-menu will allow the operator to select as to how they want to identify their blood samples. (2) options are available in this sub-menu.

1 - US Mode: allows the operator to type in up to **13** Alphanumeric characters for a blood sample identification. See **Section 4 - Startup and Sample Run, 2 - Sample Selection and Identification, (2.1. Sample Identification Modes)** for details.

2 - STANDARD Mode: allows the operator to enter numbers “Only” from **1 to 99999**. See **Section 4 - Startup and Sample Run, 2 - Sample Selection and Identification, (2.1. Sample Identification Modes)** for details.

To enter into the ID Mode menu, from the 3 - SPECIAL Menu, use the “Down” arrow key to 7 - ID MODE as indicated:

```
SPECIAL 6 - BUZZER Y/N < YES >   
11:30 > 7 - ID MODE < US > 
```

1 - Press the “ENTER” key to access the sub-menu.

2 - Select a mode of sample identification and press the “ENTER” key to accept the mode. *Remember, Startup results “Will Not” be printed out if STANDARD Mode is selected!!!*

MICROS 60 OS/OT



Important: Startup Results will be printed out in the US MODE “Only”!!! If STANDARD Mode is select for sample identification, the Startup results “Will Not” be printed out nor will it print out the Startup status unless Startup has “Failed”!!!

Instrument Configuration

4. Date and Time

This SETUP sub-menu will allow the operator to change Time, Date format, and Date on the instrument to accommodate different Time zones and Geographical locations when needed.

To access this sub-menu from the SETUP menu, use the “Down” arrow key and select 4 - DATE TIME as indicated:

```
SETUP          3 - SPECIAL  ▲
11:36         > 4 - DATE TIME ▼
```

Press the “ENTER” key to access the Date and time sub-menu as indicated:

```
DATE TIME >1 - CHG. TIME
11:40      2 - DATE FMT. < MM-DD-YY >
```

4.1. Change Time

1 - Select 1 - CHG. TIME and the display will indicate:

```
NEW TIME (HH.MM) ? : _   EXIT : ESC
CURRENT : 11:40   SAVE : ENTER
```

3 - Enter the Hours (set for 24 hr.) then press the Decimal (.) key. Now enter the Minutes.

MICROS 60 OS/OT



Important: An Error message “BAD TIME ! TRY AGAIN” will occur if you don’t enter the time correctly. Make sure to use the decimal (.) key between the hours and minutes when entering the time correctly!!!

4 - Press the “ENTER” key to accept the new time.

4.2. Change the Date Format

This sub-menu will allow the operator to change to format of the date according the Country’s specifications.

To enter into the Date format menu, from the Date Time menu, use the “Down” arrow key to select 2 - DATE FMT. as indicated on the display:

```
DATE TIME 1 - CHG. TIME
11:40     > 2 - DATE FMT. < MM-DD-YY >
```

1 - Press the “ENTER” key to enter into this sub-menu.

This sub-menu has (4) different date formats as indicated:

- Month, Day, Year (MM-DD-YY)
- Day, Month, Year (DD-MM-YY)
- Year, Month, Day (YY-MM-DD)
- Year, Day, Month (YY-DD-MM)

2 - Use the “Down” arrow key to select the format which is specific for your applications as indicated:

```
DATE FMT. > * 1 - MM-DD-YY
11:52     2 - DD-MM-YY
```

3 - Press the “ENTER” key to accept that specific date format.

4.3. Change Date

This sub-menu allows the operator to change the actual date once the correct format has been selected.

To enter into the Change Date Menu, from the DATE TIME Menu, use the “Down” arrow key and select 3 - CHG. DATE as indicated:

```
DATE TIME 2 - DATE FMT. < MM-DD-YY >
11:40     > 3 - CHG. DATE ▼
```

1 - Press the “ENTER” key to access this sub-menu, as indicated on page 16.

Micros 60

① Change Date continued:

2 - Enter the first 2 numbers then press the Decimal (.) key. Enter the second 2 numbers then press the decimal (.) key again. Now enter the last 2 numbers and press the “ENTER” key to save the new date as indicated:

```
NEW DATE (MM.DD.YY) ? : _ EXIT : ESC
CURRENT : 01.20.02 SAVE : ENTER
```

MICROS 60 OS/OT



Important: An Error message “BAD DATE ! TRY AGAIN” will occur if you don’t enter the date correctly. Make sure to use the decimal (.) key after the first 2 numbers and after the second 2 numbers when entering the date correctly!!!

3 - Press the Escape “ESC” key to exit the DATE TIME Menu.

5. Host Computer Options

The **ABX MICROS 60** is capable of transmitting data to an External Computer by way of the RS-232 interface connection, on the back panel of the analyzer.

MICROS 60 OS/OT



Important: The external computer Communication format must be set up according to the computer Vendor’s specifications. The output formats must match those specifications! If there are any questions regarding output format setup, contact your local **ABX Technical Support Representative** for information on the specific output format types!

To enter into the Host Options Menu, from the SETUP Menu, use the “Down” arrow key to select 5 - HOST OPTIONS as indicated on the display:

```
SETUP          4 - DATE TIME  ▲
11:36         > 5 - HOST OPTIONS ▼
```

Press the “ENTER” key to access the sub-menu.

5.1. Host Communications

This sub-menu will allow the operator to select from (4) different Output format options for an external computer.

- 1 - FORMAT ARGOS, No character identifiers
- 2 - FORMAT R & D, No character identifiers
- 3 - FORMAT ABX, with character identifiers
- 4 - TR OFF, Transmission Off.

1 - Use the “Down” arrow key to select 1 - HOST COMM. Press the “ENTER” key to access the Host Comm. sub-menu as indicated:

```
HOST OPTIONS >1 - HOST COMM <FORMAT>
11:52        2 - BAUD RATE <9600 >
```

2 - Select one of the (4) different output options and press the “ENTER” key to accept that specific output format.

5.2. Baud Rate

This sub-menu allows the operator to select the rate of transmitted data to the host computer. There are (5) different rates to select from:

- 1 - 300
- 2 - 1200
- 3 - 2400
- 4 - 4800
- 5 - 9600

1 - Use the “Down” arrow key to select 2 - BAUD RATE. Press the “ENTER” key to access the Baud Rate sub-menu as indicated on the next page:

Instrument Configuration

Ⓞ Baud Rate continued:

BAUD RATE	1 - 300
11:48	2 - 1200 ▾

2 - Use the “Down” arrow key to select one of (5) different transmission rates for your specific applications, then press the “ENTER” key to accept that rate.

5.3. Transmission Send

This sub-menu will allow the operator to send the last sample results in memory to the Host computer as a transmission acceptance verification.

This function is mainly used to verify transmission from the **ABX MICROS 60** to a host computer.

To enter into the Transmission sub-menu, from the Host Options Menu, use the “Down” arrow key to **3 - TRANSMISSION** as indicated on the display:

HOST OPTIONS	2 - BAUD RATE < 9600 > ▴
11:52	> 3 - TRANSMISSION

1 - Press the “ENTER” key to send the last sample results to the Host computer. The transmission should be complete if the output format was set up correctly.

6. Barcode Setup

This sub-menu will allow the operator to select the types of Barcode labels to be read by the reader. Turning the Checksum “ON” or “OFF” gives the operator this capability once the Barcode reader has been installed correctly.

From the SETUP Menu, use the “Down” arrow key to **select 6 - BARCODE**, as indicated:

SETUP	5 - HOST OPTIONS ▴
11:36	> 6 - BARCODE ▾

1 - Press the “ENTER” key to access the CHECKSUM Yes or No sub-menu.

2 - Press the “ENTER” key to accept the change

MICROS 60 OS/OT



Important: The Barcode Reader is a special setup function in the system configuration. Before using this setup, the Barcode Reader must be configured on the Main Circuit board of the **ABX MICROS 60**. If you require a Barcode Reader for sample Identification, please contact your local **ABX Service Representative** for Installation and setup of this device!

MICROS 60 OS/OT



Important: Verify that the “US MODE” has been selected in the SPECIAL Menu under the sub-menu 7 - ID MODE. The Barcode reader will only work with this mode selected.

7. Memory Card

This menu will allow the operator to have the option of storing Patient samples on a Memory card or having the Memory card function turned “Off”. This Memory card option allows the operator to store up to **(60)** patient results on the card if the instrument has a card reader installed.

*Remember, the **ABX MICROS 60** will only hold the “last sample analyzed” in the Internal memory.*

The Memory Card option will allow the operator to perform the following tasks from the memory card:

- It will allow the operator to turn the memory card function “On or Off”.
- Print a list of all the sample Identifications that have been stored on the card.
- Select one sample result to Print.
- Select all sample results to Print.
- To select from a specific number of samples to be printed.
- The ability to erase all the samples stored and re-use the card if necessary.

Micros 60

① Memory Card continued:

- To transmit your results from the memory card to a printer or to a host computer.

To enter into the Memo Card Menu, from the SETUP Menu, use the “Down” arrow key to 7 - MEMO CARD as indicated:

```
SETUP          6 - BARCODE  ▲
11:36         > 7 - MEMO CARD ▼
```

1 - Press the “ENTER” key to access this sub-menu as indicated:

7.1. Memo On / Off

```
MEMO CARD > 1 - MEMO    < OFF    >
11:39       2 - TRANSMISSI. < PRINTER ▼
```

2 - Select the first option 1 - MEMO. This will allow you to:

1 - MEMO-ON, will allow you to use the Memory card.

2 - MEMO-OFF, if you do not want to use a memory card for sample results storage.

MICROS 60 OS/OT



Note: If you choose 1 - MEMO-ON and are not using the memory card, a message “NO SMART CARD” will appear on the display when you start a sample analysis cycle.! You must use a memory card when analyzing samples. If you don not want to use a memory card, make sure that the Memo card sub-menu is selected for 2 - MEMO-OFF.

3 - Press the “ENTER” key once you have made your selection.

MICROS 60 OS/OT



Note: If the STANDARD ID Mode was previously select before turning the memo card function “On”, the ID mode will automatically change to US MODE!

7.2. Running Patient Samples

1 - Place the sample beneath the Samplr probe and press the Manual Sample Bar to start the cycle.

Or press the “START” key to start the cycle.

2 - Enter the sample identification. Up to (13) Alphanumeric characters. Use the “Number” keys to enter the numbers directly. Use the “Up” and “Down” arrow keys to select each Alpha character, then press the “ENTER” key after each Alphabetical selection.

3 - After the sample identification has been entered, the analyzer checks to see if there is a memory card present in the card reader.

If the memory card has not been inserted, a message will appear on the display as indicated:

```
ERROR : NO SMART CARD... NO : ESC
INSERT NEW CARD          YES : ENTER
```

Insert the memory card and press the “ENTER” key.

If the operator inserts a Quality Control or a Calibrator Smard card instead of a memory card, a message will appear on the display as indicated:

```
ERROR : BAD SMART CARD... NO : ESC
INSERT NEW CARD          YES : ENTER
```

Remove the card, insert a memord card and press the “ENTER” key.

If the operator inserts the memory card in the wrong direction, a message will appear on the display as indicated:

```
ERROR : BAD CARD INSERTION...NO : ESC
INSERT NEW CARD          YES : ENTER
```

Remove the memory card, place the chip in the “Up” position and forward to the point of insertion. Insert the card and press the “ENTER” key.

Instrument Configuration

Ⓞ Running Samples continued:

If the operator inserts the memory card, presses the “ENTER” key, and a message appears on the display:

```
ERROR : MEMORY CARD FULL...NO : ESC  
INSERT NEW CARD                YES : ENTER
```

Remove the Full card, insert a New memory card, and press the “ENTER” key.
Or Print out all the results on the Full card, clear the results from the card, and re-insert the memory card, then press the “ENTER” key.

MICROS 60 OS/OT



Note: The Memory card can store up to (60) results for the **ABX MICROS 60-CS16 or CS18**. When the card is “Full”, it is highly suggested to print out “All” the stored results from the card before using a new card or clearing the full card! This recommendation is suggested due to Lost, Stolen, or Damaged cards. If all results have been printed, a hard copy can be filed and viewed for future reference.

7.3. Transmission of Results

This sub-menu allows the operator to select as to where they want the results from the memory card to be transmitted to. Printer or External computer?

The Memo functions for both printer and external computer include:

- Print list of sample ID’s to Printer or Computer
- Print one result to Printer or Computer
- Print all results to Printer or Computer
- Print specific numbers of sample results to Printer or Computer.

To enter into the Transmissi. sub-menu, from the MEMO CARD Menu, use the “Down” arrow key to select 2 - TRANSMISSI. as indicated:

```
MEMO CARD > 2 - TRANSMISSI. < PRINTER >  
11:39          3 - PRT. LIST
```

1 - Press the “ENTER” key to access this mode of transmission sub-menu.

2 - Choose one of (2) options, to have your results from the memory card sent to:

1 - PRINTER, the printer that is attached to the **ABX MICROS 60**.

2 - HOST COMP., a Host Computer that is attached to the RS-232 port of the **ABX MICROS 60**.

3 - Press the “ENTER” key after making your selection.

7.4. Print List

This Memory card sub-menu allows the operator to print out a complete list of all the sample Identification numbers on the card. This Sample Identification list will include the following information:

- MEMO Number in sequence.
- The date of the analysis.
- The Time of the analysis.
- The Sample Identification number entered by the operator.

To enter into the Print List sub-menu, from the MEMO CARD Menu, use the “Down” arrow key to select 3 - PRT. LIST as indicated:

```
MEMO CARD  2 - TRANSMISSI. < PRINTER >  
11:39      > 3 - PRT. LIST
```

1 - Press the “ENTER” key to Print the complete sample identification list from the memory card.

PRT. LIST			
MEMO	DATE	TIME	NAME
1	07/21/1999	11:45	12
2	07/21/1999	11:47	456
3	07/21/1999	11:48	675
4	07/21/1999	11:53	984
5	07/21/1999	11:55	R456
6	07/21/1999	13:34	ABC123
etc.....			

Micros 60

7.5. Reprint One Result (TR. ONE)

This Memory card sub-menu allows the operator to select one specific sample results from the card to be printed out. That one sample results will be printed out according to the Results printout options from the RESULTS Menu such as:

- PRINTOUT, With Histograms, Without Histograms, Without RBC Histogram “Only”
- UNITS, Standard, SI, Inter-1, Inter-2
- PRINT LIMITS, Yes or No
- PRINT LMG’s, Yes or No

1 - Place the Memory card in the reader.

2 - From the Memo Card Menu, select 3 - *PRT. LIST*. Wait until all the Sample Identification list is completely printed out.

3 - From the Memo Card Menu, select 4 - *TR. ONE* and press the “ENTER” key. The display will indicate:

```
MEMO ? : _          EXIT : ESC
CURRENT : 26        SAVE : ENTER
```

4 - Select the Sample identification number from the list that you want the results printed from. Note the MEMO number next to that ID number. Enter the MEMO number next to the sample ID number and press the “ENTER” key. That sample results will now print out.

7.6. Reprint All Results (TR. ALL)

This Memory card sub-menu will allow the operator to select all the results on the card to be printed out.

Verify that you have a sufficient quantity of paper in the printer for this function. Each individual results will be printed out on a separate sheet of paper.

MICROS 60 OS/OT



Note: Line Mode Results (All results printed on 1 sheet of paper starting from left to right in a line form) are not available with the use of the memory card. All sample results are printed individually on a separate sheet of paper!

To enter into the Reprint All sub-menu, from the MEMO CARD Menu use the “Down” arrow key to 5 - *TR. ALL* as indicated:

```
MEMO CARD          4 - TR. ONE  ▲
12:02              > 5 - TR. ALL ▼
```

1 - Place the Memory card in the reader.

2 - Select 5 - *TR. ALL* then press the “ENTER” key. All complete results from the memory card will be printed out.

MICROS 60 OS/OT



Note: If you selected 5 *TR. ALL* by error, remove the memory card from the reader and press the Escape “ESC” key. Wait until the printer has stopped before continuing through the sub-menu.

7.7. Reprint From / To (TR. FROM TO)

This memory card sub-menu will allow the operator to print out a specified group of sample results starting from a specified number and ending with a specified number.

1 - Place the Memory card in the reader.

2 - From the Memo Card Menu, select 3 - *PRT. LIST*. Wait until all the Sample Identification list is completely printed out.

3 - From the Memo Card Menu, select 6 - *TR. FROM TO* and press the “ENTER” key.

Instrument Configuration

The Display will indicate:

```
TR. FROM TO > 1 - BEGIN < 6 >
12:08 2 - END < 13 > ▾
```

4 - Select 1 - *BEGIN* and press the “ENTER” key to access this sub-menu.

5 - Review the printed list and enter the beginning MEMO number that you wish to start with as indicated:

```
BEGIN ? : _ EXIT : ESC
CURRENT : 6 SAVE : ENTER
```

6 - Press the “ENTER” key to accept the starting MEMO number.

7 - Use the “Down” arrow key to 2 - *END* and press the “ENTER” key to access this sub-menu.

8 - Review the printed list and enter the ending MEMO number that you wish to end with as indicated:

```
END ? : _ EXIT : ESC
CURRENT : 13 SAVE : ENTER
```

9 - Press the “ENTER” key to accept the ending MEMO number.

10 - Use the “Down” arrow key to 3 - *SEND RESULT* and press the “ENTER” key to send the specific group of results to the printer and / or the host computer as indicated:

```
TR. FROM TO 2 - END < 13 >
12:08 > 3 - SEND RESULTS ▾
```

11 - The specific group of sample results will now print out individually on separate sheets of paper.

7.8. Clear Card

(Erasing All Results from the Card)

This Memory card sub-menu will allow the operator to delete all the Patient sample results from the card.

MICROS 60 OS/OT



Caution: It is highly recommended to print out all the complete results from the card before performing this function!!! The Clear card function deletes “ALL” results, no partial clearing! Once results have been cleared from the card, they cannot be retrieved at any time!!!

To enter into the Clear Card sub-menu, from the MEMO CARD Menu, use the “Down” arrow key to select 7 - *CLEAR CARD* as indicated:

```
MENO CARD 6 - TR. FROM TO Δ
12:02 > 7 - CLEAR CARD
```

1 - Place the Memory card in the reader.

2 - Press the “ENTER” key. A message will appear on the display as indicated:

```
VALID ? NO : ESC
YES : ENTER
```

3 - Press the “ENTER” key to clear the card or press the Escape “ESC” key to retain the results on the card.

4 - When you have completed this function, press the Escape “ESC” key until you return to the MAIN MENU.

Micros 60

Maintenance & Troubleshooting

1. MAINTENANCE	2
1.1. Overview	2
1.2. Daily Maintenance	2
1.3. Service Functions	3
1.4. Instrument Cycles	6
1.5. Technician Functions	7
1.6. Automatic Cleaning	7
2. TROUBLESHOOTING	7
2.1. Overview	7
2.2. Problem Identification	7
2.3. Troubleshooting parameters	9
2.4. Troubleshooting System operations	13
2.5. Troubleshooting “ERROR” messages	14
3. SOFTWARE MENU OVERVIEW	16
4. “QUICK” OPERATIONS REFERENCE	18

Micros 60

① Menu/Service

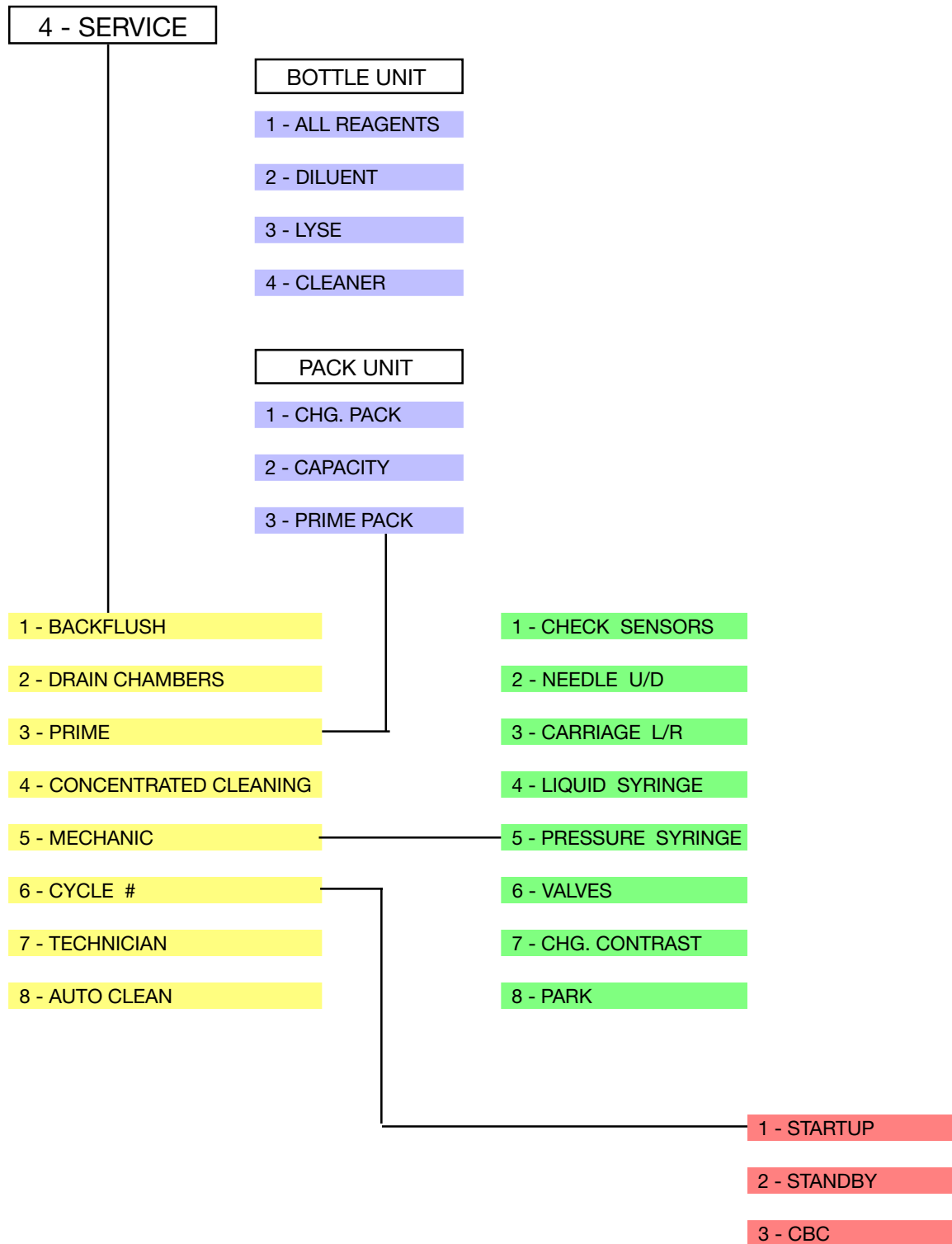

Maintenance & Troubleshooting

1. Maintenance

1.1. Overview

One of the principle factors contributing to accurate and reliable results is a well-maintained instrument. The **ABX MICROS 60** is designed to keep this maintenance automatically to a minimum providing that the operator is aware of its schedule. This section of the manual will describe the daily and periodic maintenance procedures.

1.2. Daily Maintenance

These cleaning procedures are required daily to maintain optimum performance of your **ABX MICROS 60**.

MICROS 60 OS/OT



Warning: Failure to perform any of these recommended cleaning procedures can result in decreased reliability of your system. It is important that you monitor your analyzer for the types of specimens that may cause pre-mature cleaning other than routine!

① Startup and Standby Cycles

At the beginning of each business day, a Startup cycle must be performed. This can be done either automatically or just by pressing the “**STARTUP**” key on the front of the instrument panel, which ever the system has been set up for in **Section - 5 Instrument Configuration, 3 - Special functions, (3.3. Startup Cycle)**.

At the end of each business day, a Standby cycle should be performed. Press the “**STANDBY**” key on the front of the instrument panel to start the cycle. This cycle takes about 1 minute. Once the Standby cycle is complete you may Power “Off” the instrument or leave it in the standby mode Overnight.

MICROS 60 OS/OT



Important: The Standby mode introduces MINICLEAN into the chambers for the enzymatic cleaning of Protein build-up on the counting chambers and apertures. This standby cycle is a very important step in daily maintenance!

① Automatic Cleaning

This Automatic cleaning cycle is automatically performed when the number of analysis cycles has been reached to initiate the auto-clean cycle. This cleaning frequency cycle can be programmed by the operator to adjust for the workload of the Laboratory. See **Section - 5 Instrument Configuration, 3 - Special Functions, (3.4. Autocleaning Frequency)** for editing the cycle number.

This Automatic cleaning cycle can also be activated manually by entering the “**SERVICE MENU**”. From the Main Menu, select **4 - SERVICE**, use the “Down” arrow key to select **8 - AUTO CLEAN**, then press the “**ENTER**” key to activate the cycle.

① General Cleaning of the Instrument

In General, the **ABX MICROS 60** should be wiped down on a daily basis for dried blood deposits. Use warm water and a drop of liquid soap on a damp cloth if necessary to clean the outside of the instrument.

MICROS 60 OS/OT



Warning: Never use solvents or abrasive materials to clean the instrument. Wipe off any trace of blood spillage as soon as possible. Always disconnect the main electrical supply before cleaning the exterior of the analyzer. Make sure that the instrument is completely dry before re-connecting the electrical power!

Micros 60

1.2. Service Functions

Several service functions are available for the operator to clean and check the instrument. These functions are accessible from the Main Menu. Use the “Down “ arrow to *select 4 - SERVICE*. Press the “ENTER” key to access these sub-menus as indicated on the display:

```
SERVICE    > 1 - BACKFLUSH
12:20      2 - DRAIN CHAMBERS ▾
```

① Backflush

This service function will allow the operator to clean the counting chamber apertures in case of blockage. From the Service Menu, *select 1 - BACKFLUSH, then press the “ENTER” key to start the process*. This cycle takes approximately (20) seconds to complete.

- Open the instrument door and verify that liquid is being pulled through the apertures. (*watch for few micro-bubbles in the count tubing, coming from the count head*).
- When the backflushing starts, verify that liquid is being pushed back through the apertures. (*watch for few micro-bubbles coming into the chambers through the count head*).
- If you cannot see any micro-bubbles moving through tubing or in the chambers, the aperture may still be blocked. In this case, perform a Concentrated Cleaning.

① Drain Chambers

This service function will allow the operator to check for proper chamber draining and to maintain some of the parts of the hydraulic manifold as it flushes waste out of the instrument.

- This cycle takes approximately (7) seconds to complete. From the Service Menu, *select 2 - DRAIN CHAMBERS, then press the “ENTER” key to drain the chambers*.

- Verify the proper draining of the waste through the waste tubing located on the back of the instrument. If it is not flushing waste sufficiently, check the waste tubing connection and verify that there is no blockage or crimping of the tubing.

- Verify that both the WBC and RBC chamber are draining properly, not slow but fairly rapid. If not, view the troubleshooting section.

① Prime Reagents

This service function will allow the operator to prime reagents either individually or all at once, depending on the type of system you have. (*Separate Reagents or Minipak*).

- From the Service Menu, *select 3 - PRIME REAGENTS*. There are (2) types of **ABX MICROS 60** systems:

1 - BOTTLE SYSTEM (*Separate reagents*). The prime reagents sub-menu will indicate:

- 1 - ALL REAGENTS
- 2 - DILUENT
- 3 - LYSE
- 4 - CLEANER

- Press the “ENTER” key to access this sub-menu for bottled units. Select the reagent or reagents to be primed, then press the “ENTER” key to start the prime cycle.

2 - PACK SYSTEM (**ABX Minipak**-all reagents contained in (1) pack). Diluent, Lyse, and Cleaner. The Prime reagents sub-menu will indicate:

- 1 - CHANGE PACK
- 2 - CAPACITY
- 3 - PRIME PACK

- Press the “ENTER” key to access this sub-menu. Select either Changing the Pack if the present pack is low, or Priming the current pack if the cycles are sufficient. Step by Step instructions will be given on the display when installing a Minipak.

Maintenance & Troubleshooting

① Prime Reagents continued:

MICROS 60 OS/OT



Note: When priming reagents or pack, verify that Reagent is being primed. View the Chambers for reagent priming. Verify that reagent is coming in and draining out of the chambers when a cycle is initiated. Verify that there are No "Air" Bubbles in the reagent lines when priming.

① Concentrated Cleaning

This service function allows the operator to perform a very strong cleaning of the WBC and RBC counting chambers and apertures. This cycle time may vary due to the Revision of Software.

This service function is utilized when frequent parameter and/or morphology flags a present on normal patient analysis.

- From the Service Menu, use the "Down" arrow and select 4 - *CONCENTRATED CLEANING*. (2) solutions are recommended for this procedure:

1 - *ABX MINOCLAIR*: a solution which contains about 25% bleach.

2 - 75% Regular *CLOROX* bleach solution - 3 parts Bleach, 1 part Deionized Water.

- Both solutions described above will work, depending the severity of the blockage in the chamber or aperture.

- Press the "ENTER" key to access this function and follow the steps that appear on the displays indicated:

1 - Open the main cover door of the *ABX MICROS 60* as indicated:

PLEASE OPEN COVER DOOR
PRESS A KEY TO CONTINUE...

2 - If the *ABX MICROS 60* has a cover over the WBC/HGB chamber, dispense which ever solution you choose into the RBC chamber and into the hole on the top of the WBC chamber cover so that it goes into the chamber.

- If the *ABX MICROS 60* has a cover on both WBC and RBC chambers, dispense which ever solution you choose into the holes on top of both chamber covers so that is goes into the chambers.

POUR 3ml OF CLEANER IN THE WBC CHAMBER
PRESS A KEY TO CONTINUE...

POUR 3ml OF CLEANER IN THE RBC CHAMBER
PRESS A KEY TO CONTINUE...

3 - After the solution has been added to both chambers, press any key to continue. The cleaning cycle will begin and a cleaning time will be displayed. This time will vary depending on the revision of software that is currently on the analyzer.

- This concentrated cleaning cycle involves different cycles, Backflush, Aspiration, Rinsing, which allow a good cleaning of the chambers and apertures. After this procedure is complete, perform a "STARTUP" cycle to verify that the background parameters are within their limits.

4 - Once the Startup cycle has passed, sample analysis may begin.

MICROS 60 OS/OT



Important: Severe Fibrin clots in the chambers and apertures may require this concentrated cleaning procedure to be run more that once with (3) Backflushes before the cleaning cycle and (3) Backflushes after the cleaning cycle to ensure the dislodging of any clot prior to sample analysis!

Micros 60

Ⓞ Mechanical Checks

This service function will allow the operator to move through a sub-menu full of mechanical movements that will allow them to select a specific mechanism for function verification. If the operator suspects a specific mechanical failure, they may then verify it in this menu.

From the Service Menu, use the “Down” arrow to select 5 - *MECHANIC*, then press the “ENTER” key to access these sub-menus as indicated:

```
MECHANIC    > 1 - CHECK SENSORS
12:32       2 - NEEDLE U/D
```

There are (8) mechanical functions in this sub-menu.

1 - *SENSORS*: Needle and Carriage. This allows the operator to check the homing sensors of the Sample probe and the Sample carriage.

2 - *NEEDLE U/D*: This allows the operator to check the “Up” and “Down” movement of the sample probe.

3 - *CARRIAGE L/R*: This allows the operator to check the “Left” to “Right” movement of the sample carriage.

4 - *LIQUID SYRINGE*: This allows the operator to check syringe block that moves Sample, Diluent, and Lyse into the chambers.

5 - *PRESSURE SYRINGE*: This allows the operator to check the Vacuum/Waste syringe for complete movement up and down.

6 - *VALVES*: This allows the operator to operate all valves on the analyzer in a sequential order from 1 to 13.

7 - *CHG. CONTRAST*: This allows the operator to change the contrast of the LCD display.

8 - *PARK*: This allows the operator to place the Vacuum/Waste syringe in a position suitable for long term storage of the analyzer.

1 - To access the Check Sensors Menu, place the cursor on 1 - *CHECK SENSORS* and press the “ENTER” key. The display will indicate:

```
NEEDLE SENSOR : 0
CARRIAGE SENSOR : 0
```

• **NEEDLE SENSOR: 2** - Open the main door of the *ABX MICROS 60* and move the sample needle upwards by the top support bracket. If the sensor is good, it turns from “0 to 1” followed by 10 stars.

• **CARRIAGE SENSOR: 3** - With the sample needle in the “Up” position, move the sample carriage towards the right. If the sensor is good, it turns from “0 to 1” followed by 10 stars as indicated below:

```
NEEDLE SENSOR : 1 *****
CARRIAGE SENSOR : 1 *****
```

4 - Press any key to exit the function. If any of these sensors remain at 0 when the mechanism has been moved, call your local *ABX Technical Support Representative* for assistance with this issue.

5 - To access any other mechanical function, place the cursor by the mechanism and press the “ENTER” key to access that specific function. The display will step you through the function.

6 - Press the Escape “ESC” key to exit any function.

Maintenance & Troubleshooting

① LCD Contrast Adjustment

The LCD Contrast can be adjusted as followed:

1 - from the Mechanic Menu, *select 7 - CHG. CONTRAST* then press the “ENTER” key to access that function as indicated:

```
CONTRAST + : ▲ PRESS ENTER TO VALID
12:40      - : ▼
```

2 - Press the “UP” arrow key to increase the contrast, or press the “DOWN” arrow key to reduce the contrast.

3 - When the contrast is set, press the “ENTER” key to accept the change in contrast.

MICROS 60 OS/OT



Note: The Contrast Menu can be accessed at any time from any other menu. Press and hold the Delete (DEL) key and Period (.) key simultaneously. The contrast menu will appear for adjustment.

① Park

This Service function allows the operator to place the Vacuum/Waste syringe in a position so that the instrument can be placed in storage or shutdown for a long period of time.

From the Mechanic Menu, *select 8 - PARK* then press the “ENTER” key to place the syringe in the park position.

1.4. Instrument Cycles

This Service function allows the operatr to view the number of cycles the **ABX MICROS 60** has run. This Cycle Menu will contain (3) cycles to view as indicated:

1 - STARTUP: the number of Startup cycles that the instrument has ran.

2 - STANDBY: the number of Standby cycles that the instrument has ran.

3 - CBC: the number of analysis cycles that the instrument has ran.

From the Service Menu select 6 - CYCLES, then press the “ENTER” key to access this menu as indicated:

```
CYCLES > 1 - STARTUP < 4097 >
12:30  2 - STANDBY < 6234 >
```

Micros 60

1.5. Technician Functions

This Service function allows the operator to work with *ABX Technical Support* in resolving, checking, and/or adjusting some Technical interventions on the *ABX MICROS 60*.

This Service Menu is mainly used by the Engineers to make adjustment in the technical areas of the analyzer.

MICROS 60 OS/OT



Note: This Technician Functions Menu can be accessed only by a special password. When troubleshooting your instrument in this area, call your local *ABX Technical Support Representative* for the special password and instructions in this menu area!

1.6. Automatic Cleaning

This Service function allows the operator select a Cleaning cycle at any time that they wish to clean the instrument. This cleaning cycle is the same cycle as the programmed cleaning cycle frequency. See **Section 5 - Instrument Configuration**, 3 - Special Functions, (3.4. *Autocleaning Frequency*).

From the Service Menu select 8 - *AUTO CLEAN*, then press the “ENTER” key to start the cleaning cycle. The display will indicate that a cleaning cycle is in progress and the duration time may vary depending on the revision of software on the unit.

MICROS 60 OS/OT



Important: This Auto Clean cycle is a short cycle and may not provide enough cleaning action for Fibrin clots in the apertures and/or chambers. If this is the case, a Concentrated Cleaning is highly recommended!

2. Troubleshooting

2.1. Overview

Your *ABX MICROS 60* may occasionally require troubleshooting if:

- System operations are faulty.
- The Background count is unacceptably high.
- Your Quality Control values are out-of-range, or patient results are suspicious, e.g.(*consistently high RBC counts, or the inability to verify results by manual methods*).
- Percision is poor.
- Calibration is drifting.

2.2. Problem Identification

The first step in any troubleshooting session is to identify the source of the system malfunction.

- System operation
- Percision
- Quality Control
- Calibration

These steps should be carried out in sequence as described below:

① System Operations

The *ABX MICROS 60* software identifies most of the mechanical or hydraulic problems. A “Mechanical” problem gives an alarm message and stops the current cycle in progress.

A “Hydraulic” problem can be noted by parameter and/or morphology flags. The Waste sensor also gives an error message if a hydraulic problem exists.

If this is the case, Power “OFF” the *ABX MICROS 60*, Power “ON” the system, and run a Startup. If the problem persists during or after startup, identify the source of the malfunction and initiate the appropriate troubleshooting procedures.

Maintenance & Troubleshooting

① Reagents

If your Background count is unacceptable, Quality Control values are out-of-range, or your patient results are suspicious, Reagent deterioration or contamination may be suspected.

Replace your reagents and perform a Concentrated Cleaning procedure.

If the background count is acceptable, but the Quality Control values are still out-of-range or patient results are still suspicious, continue with the identification procedure. If replacing the reagents performing a concentrated cleaning procedure does not correct the background count problem, call your local *ABX Technical Support Representative* for further instructions!

① Precision

In order to verify the precision of the instrument, it is recommended to run a Fresh, Normal Whole blood sample (10) times, mixing between each analysis cycle. after all 10 run are complete, calculate the Coefficient of Variation percentage (CV %). Compare the CV % results with those listed in **Section - 1 Specifications, 3 - Summary of Performance Data, (3.1. Repeatability)**. If the precision of any parameter is not within these specifications, identify the out-of-range parameter(s) and initiate appropriate troubleshooting procedures.

① Calculation factors for CV% determination (as noted):

$$\bar{X} = \frac{\sum X}{n} \quad SD = \sqrt{\frac{\sum (\bar{X} - X_i)^2}{n - 1}}$$

DEFINITIONS:

\bar{X} = the calculated Mean

\sum = the Sum of

n = the total number of samples

X_i = the individual parameter value

SD = Standard Deviation

① Calculation factors for CV% determination (as noted) continued:

$$CV \% = \frac{SD \times 100}{\bar{X}}$$

Once the CV%'s have been calculated, compare them to the specified limits.

① Calibration

If the system seems to be operating properly, fresh uncontaminated reagents are being used, and the precision is within the specifications, the *ABX MICROS 60* may need calibration. Refer to **Section 3 - Calibration & Quality Control, 1 - Calibration Program** for calibration instructions.

2.3. Troubleshooting Parameters

The procedures described below should be performed whenever the precision of a parameter is not within its CV specifications or the parameter is incorrect or suspicious.

When all parameters are affected, it is necessary to look for a common cause e.g.(*Vacuum, pressure, sample aspiration, chamber filling and draining correctly, common reagent pollution, etc....*).

When only one parameter is affected, it is necessary to look for a cause in this specific area of analysis. The different tables listed, give the noted problems for the parameter in question, possible cause of the problem, and the necessary user action to correct the problem.

① Problems on all Parameters

Problem Noted:	Possible Cause	Corrective Action
• Startup Failed, check reagents - High Background counts	• Out of Reagent(s)	• Check and/or replace Reagent(s) if necessary
	• Contaminated Reagent(s)	• Check and/or replace Reagent(s) if necessary
	• Possible dirty Apertures	• Perform a Concentrated cleaning, re-run Startup
• No results in analysis	• Blocked sample probe	• Remove and flush out sample probe
	• Possible defective Pre-amp on _Main Board	• Call ABX Technical support for assistance
• Suspicious patient results	• Possible dirty Apertures	• Perform a Concentrated cleaning, re-run Sample
	• Possible partial blocked sample probe	• Remove and flush out sample probe
	• Possible leakage from syringe block	• Check 3 syringe block for leakage and call ABX Technical support
	• Possible Fibrin clot in "T" fitting below WBC chamber	• Call ABX Technical support for assistance
• Alarm flags on most parameters	• Possible dirty Apertures	• Perform a Concentrated cleaning, re-run Sample
	• Possible Fibrin clot in "T" fitting below WBC chamber	• Call ABX Technical support for assistance
• QC outside acceptable limits	• Possible dirty Apertures	• Perform a Concentrated cleaning, re-run Sample
	• Possible leakage from syringe block	• Check 3 syringe block for leakage and call ABX Technical support
	• Possible Fibrin clot in "T" fitting below WBC chamber	• Call ABX Technical support for assistance
	• Poor calibration	• Call ABX Technical support for assistance
• Poor Repeatability	• Possible dirty Apertures	• Perform a Concentrated cleaning, re-run Sample
	• Possible leakage from syringe block	• Check 3 syringe block for leakage and call ABX Technical support
	• Possible Fibrin clot in "T" fitting below WBC chamber	• Call ABX Technical support for assistance
	• Poor calibration	• Call ABX Technical support for assistance
• Poor Chamber drainage	• Possible Fibrin clot in "T" fitting below WBC chamber	• Call ABX Technical support for assistance
	• Possible Vacuum/Waste syringe malfunction	• Select 4 - Service, 5 - Mechanic, 5 - Pressure syringe, check operation

Maintenance & Troubleshooting

① Problems on RBC/PLT Parameters Only!

Problem Noted:	Possible Cause	Corrective Action
<ul style="list-style-type: none"> Startup Failed, check reagents - High Background counts 	<ul style="list-style-type: none"> Possible dirty Aperture 	<ul style="list-style-type: none"> Perform a Concentrated cleaning, re-run Startup
	<ul style="list-style-type: none"> Possible Partial blockage in sample probe 	<ul style="list-style-type: none"> Remove and flush out sample probe
	<ul style="list-style-type: none"> Possible Leakage from syringe block 	<ul style="list-style-type: none"> Check 3 syringe block abd call ABX Technical support
	<ul style="list-style-type: none"> Possible contaminated Reagent(s) 	<ul style="list-style-type: none"> Check and/or replace Reagent(s) if necessary, re-run Startup
<ul style="list-style-type: none"> No results in analysis 	<ul style="list-style-type: none"> Possible dirty Aperture 	<ul style="list-style-type: none"> Perform a Concentrated cleaning, re-run Sample
	<ul style="list-style-type: none"> Possible RBC chamber not filling 	<ul style="list-style-type: none"> Check for diluent in chamber during cycle, call ABX Technical support
<ul style="list-style-type: none"> Suspicious patient results 	<ul style="list-style-type: none"> Possible dirty Aperture 	<ul style="list-style-type: none"> Perform a Concentrated cleaning, re-run Sample
	<ul style="list-style-type: none"> Possible dirty chamber 	<ul style="list-style-type: none"> Perform a Concentrated cleaning, re-run Sample
	<ul style="list-style-type: none"> Possible Leakage from syringe block 	<ul style="list-style-type: none"> Check 3 syringe block for leakage and call ABX Technical support
<ul style="list-style-type: none"> QC results are outside of the acceptable limits 	<ul style="list-style-type: none"> Possible dirty Aperture 	<ul style="list-style-type: none"> Perform a Concentrated cleaning, re-run Sample
	<ul style="list-style-type: none"> Poor calibration 	<ul style="list-style-type: none"> Re-calibrate and re-run QC
	<ul style="list-style-type: none"> Possible Leakage from syringe block 	<ul style="list-style-type: none"> Check 3 syringe block for leakage and call ABX Technical support
<ul style="list-style-type: none"> Poor Repeatability 	<ul style="list-style-type: none"> Possible dirty Aperture 	<ul style="list-style-type: none"> Perform a Concentrated cleaning, re-run Sample
	<ul style="list-style-type: none"> Possible dirty chamber 	<ul style="list-style-type: none"> Perform a Concentrated cleaning, re-run Sample
	<ul style="list-style-type: none"> Possible Leakage from syringe block 	<ul style="list-style-type: none"> Check 3 syringe block for leakage and call ABX Technical support
	<ul style="list-style-type: none"> Incorrect sample mixing 	<ul style="list-style-type: none"> Mix sample just before pressing ther Manual Sample Bar for each sample

ⓐ Problems on WBC/HGB Parameters Only!

Problem Noted:	Possible Cause	Corrective Action
<ul style="list-style-type: none"> Startup Failed, check reagents - High Background counts 	<ul style="list-style-type: none"> Possible dirty Aperture 	<ul style="list-style-type: none"> Perform a Concentrated cleaning, re-run Startup
	<ul style="list-style-type: none"> Possible Partial blockage in sample probe 	<ul style="list-style-type: none"> Remove and flush out sample probe
	<ul style="list-style-type: none"> Possible Leakage from syringe block 	<ul style="list-style-type: none"> Check 3 syringe block abd call ABX Technical support
	<ul style="list-style-type: none"> Possible contaminated Reagent(s) 	<ul style="list-style-type: none"> Check and/or replace Reagent(s) if necessary, re-run Startup
<ul style="list-style-type: none"> Startup Failed, check reagents - HGB Reference Failure No results in analysis 	<ul style="list-style-type: none"> Possible Hgb blank reference voltage 	<ul style="list-style-type: none"> Call ABX Technical support for assistance
	<ul style="list-style-type: none"> Possible dirty Aperture 	<ul style="list-style-type: none"> Perform a Concentrated cleaning, re-run Sample
<ul style="list-style-type: none"> Very high results on WBC/Hgb 	<ul style="list-style-type: none"> Possible WBC chamber not filling 	<ul style="list-style-type: none"> Check for diluent in chamber during cycle, call ABX Technical support
	<ul style="list-style-type: none"> Possible Lyse flow error 	<ul style="list-style-type: none"> Check and/or replace Lyse reagent
<ul style="list-style-type: none"> (!) on HGB results only 	<ul style="list-style-type: none"> Possible Fibrin clot in "T" fitting below WBC chamber 	<ul style="list-style-type: none"> Call ABX Technical support for assistance
	<ul style="list-style-type: none"> Possible debris in Hgb measurement pathway 	<ul style="list-style-type: none"> Perform a Concentrated cleaning, re-run Sample
<ul style="list-style-type: none"> Suspicious patient results 	<ul style="list-style-type: none"> Possible Hgb blank reference failure 	<ul style="list-style-type: none"> Call ABX Technical support for assistance
	<ul style="list-style-type: none"> Possible dirty Aperture 	<ul style="list-style-type: none"> Perform a Concentrated cleaning, re-run Sample
	<ul style="list-style-type: none"> Possible dirty chamber 	<ul style="list-style-type: none"> Perform a Concentrated cleaning, re-run Sample
	<ul style="list-style-type: none"> Possible Leakage from syringe block 	<ul style="list-style-type: none"> Check 3 syringe block for leakage and call ABX Technical support
<ul style="list-style-type: none"> QC results are outside of the acceptable limits 	<ul style="list-style-type: none"> Possible dirty Aperture 	<ul style="list-style-type: none"> Perform a Concentrated cleaning, re-run Sample
	<ul style="list-style-type: none"> Poor calibration 	<ul style="list-style-type: none"> Re-calibrate and re-run QC
	<ul style="list-style-type: none"> Possible Leakage from syringe block 	<ul style="list-style-type: none"> Check 3 syringe block for leakage and call ABX Technical support
<ul style="list-style-type: none"> Poor Repeatability 	<ul style="list-style-type: none"> Possible dirty Aperture 	<ul style="list-style-type: none"> Perform a Concentrated cleaning, re-run Sample
	<ul style="list-style-type: none"> Possible dirty chamber 	<ul style="list-style-type: none"> Perform a Concentrated cleaning, re-run Sample
	<ul style="list-style-type: none"> Possible Leakage from syringe block 	<ul style="list-style-type: none"> Check 3 syringe block for leakage and call ABX Technical support
	<ul style="list-style-type: none"> Incorrect sample mixing 	<ul style="list-style-type: none"> Mix sample just before pressing the Manual Sample Bar for each sample

Maintenance & Troubleshooting

• 2.4. Troubleshooting System Operations!

Problem Noted:	Possible Cause	Corrective Action
• No Power to the unit	• Unit is powered “Off” and/or power cord is disconnected from power source	• Power “On” unit and/or plug in power cord to power source
	• Possible blown power fuses	• Call ABX Technical support for assistance
• No Display on LCD screen	• Possible disconnection of cable to display	• Call ABX Technical support for instructions on re-connection of cable
	• Possible incorrect adjustment on LCD contrast	• Press “DEL” key and Period (.) key simultaneously, re-adjust contrast
• Motor Errors on any motor	• Possible Motor failure	• From Main Menu, select 4 - SERVICE, 5 - MECHANIC, then select the Motor in question for movement
	• Possible disconnected cable to motor on main board	• Remove main cover of the unit, check all connectors, call ABX Technical support for assistance

2.5. Troubleshooting Specific “ERROR” Messages

“ERROR” Message	Corrective Action
<ul style="list-style-type: none"> • Startup Failed, Check Reagents 	<ul style="list-style-type: none"> • Check and/or replace reagent(s) • Perform a Concentrated cleaning, re-run startup. • Remove and flush out sample probe, re-run startup • Check 3-syringe block for leakage, call ABX Technical support • Possible electronic interference, call, ABX Technical support
<ul style="list-style-type: none"> • Startup Failed, Check reagents. -HGB Reference Fail 	<ul style="list-style-type: none"> • Check and/or replace reagent(s) • Perform a Concentrated cleaning, re-run startup. • Possible HGB Reference voltage is out of range, call ABX Technical support for assistance
<ul style="list-style-type: none"> • Pressure syringe motor error, “Pack” Units 	<ul style="list-style-type: none"> • For “Pack” units, remove Waste line from pack, push down on and hold in pack waste valve, push on side of pack to force air out of waste badder. Reconnect waste line.
<ul style="list-style-type: none"> • Pressure syringe motor error, “Separate reagent” Units 	<ul style="list-style-type: none"> • Check for obstruction or restriction of Waste line • Waste container must be vented • Possible defective motor, call ABX Technical support
<ul style="list-style-type: none"> • Liquid syringe motor error 	<ul style="list-style-type: none"> • Check for 3-syringe block moving smoothly, call ABX Technical support • Possible disconnected cable from main board, remove unit cover, check all connectors. • Possible defective motor, call ABX Technical support
<ul style="list-style-type: none"> • Carriage motor error 	<ul style="list-style-type: none"> • Possible restriction of movement from the chambers to home position, check for restriction • Possible defective carriage sensor. From main menu, select 4-SERVICE, 5-MECHANIS, 1 SENSORS. Move carriage to right from home position, sensor should turn from 0 to 1**** if good. • Possible defective motor, call ABX Technical support
<ul style="list-style-type: none"> • Needle motor error 	<ul style="list-style-type: none"> • Possible restriction of movement from the “Down” position to “Up” home position, check for restriction • Possible defective needle sensor. From main menu, select 4-SERVICE, 5-MECHANIS, 1 SENSORS. Move needle down then “Up” to home position, sensor should turn from 0 to 1**** if good. • Possible defective motor, call ABX Technical support

Maintenance & Troubleshooting

① Specific “ERROR” Messages continued:

“ERROR” Message	Corrective Action
<ul style="list-style-type: none"> No printer error 	<ul style="list-style-type: none"> Printer is Off Line, reset printer. From Main menu, select 5 -SETUP, 1-RESULTS, 1-REPRINT RESULTS
<ul style="list-style-type: none"> Printer not selected error 	<ul style="list-style-type: none"> Power "On" and/or reconnect printer to unit. From Main menu, select 5-SETUP, 1-RESULTS, 1 REPRINT RESULTS
<ul style="list-style-type: none"> Bad Date, Try again! error 	<ul style="list-style-type: none"> Incorrect printer setup. Select correct printer from Main menu, 5-SETUP, 1-RESULTS, 4 PRINTER.
<ul style="list-style-type: none"> Bab Time, Try again! error 	<ul style="list-style-type: none"> Use the Period(.) key between each group of numbers when entering the date.
<ul style="list-style-type: none"> Startup not initiated error 	<ul style="list-style-type: none"> Possible wrong date format, check for the correct date format, re-enter the date. Use the Period(.) key between each group of numbers when entering the date.
<ul style="list-style-type: none"> Bad Value... MINI : XXX, MAXI : XXX error 	<ul style="list-style-type: none"> Use the Period(.) key between each group of numbers when entering the time.
	<ul style="list-style-type: none"> Press the “STARTUP” key to run a Startup.
	<ul style="list-style-type: none"> Enter correct value between (0 to 99,999) for sample Run #
	<ul style="list-style-type: none"> Out of range Target value in Autocalibration. Enter the correct target value
	<ul style="list-style-type: none"> Out of range run number in Autocalibration. Enter the correct run number between (3 to 11)
	<ul style="list-style-type: none"> Cal coefficient out of range. Enter the coefficient within the range specified in Calibration & Quality Control section

MICROS 60 OS/OT



Note: Minimum and Maximum values are displayed with the corresponding error message! Correct your value to be within the specified ranges given. If unable to be within the range specified, call your local **ABX Technical Support Representative**.

Micros 60

① Menu/Overview

ABX MICROS 60

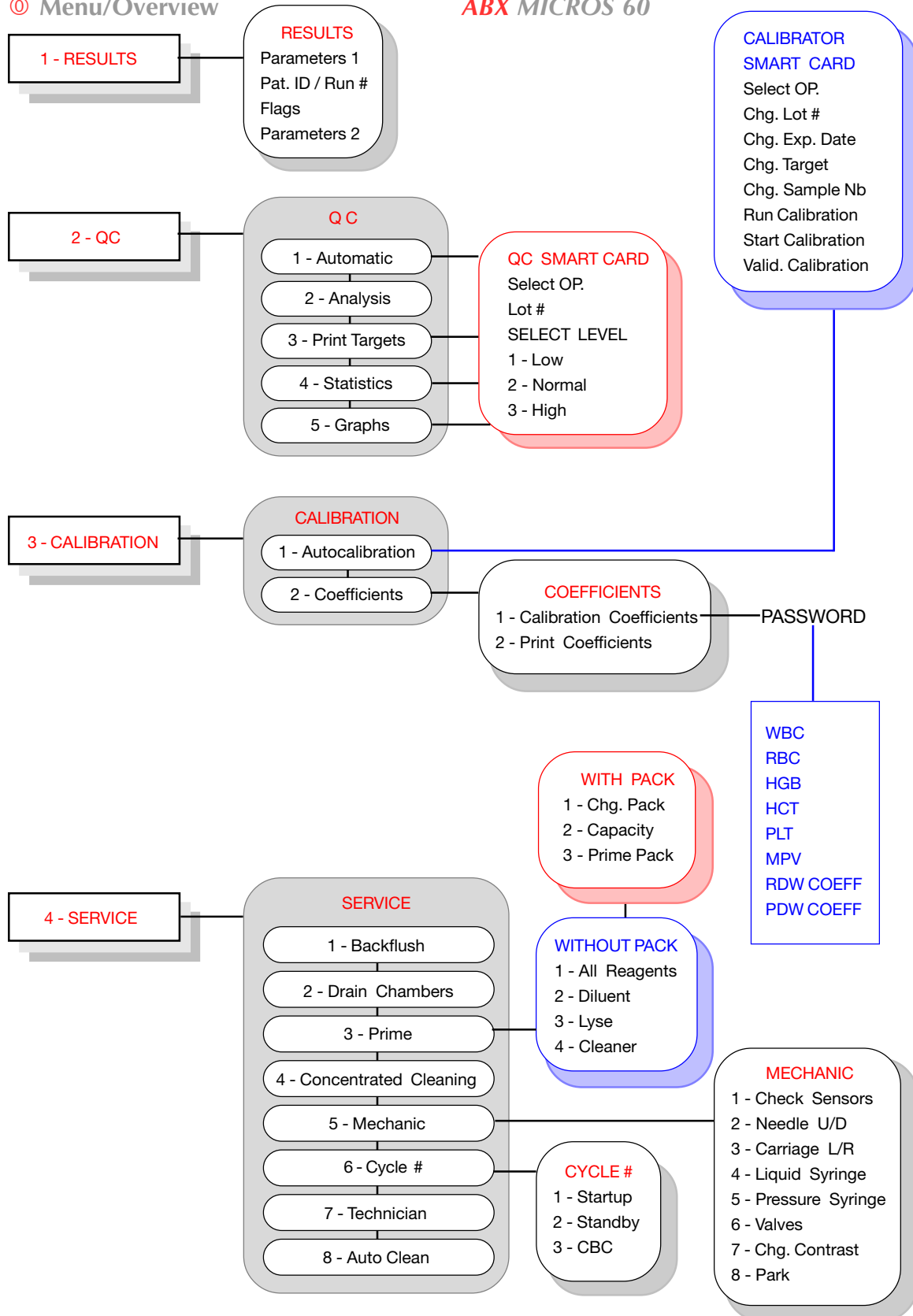

Maintenance & Troubleshooting

① Menu/Overview continued:

ABX MICROS 60

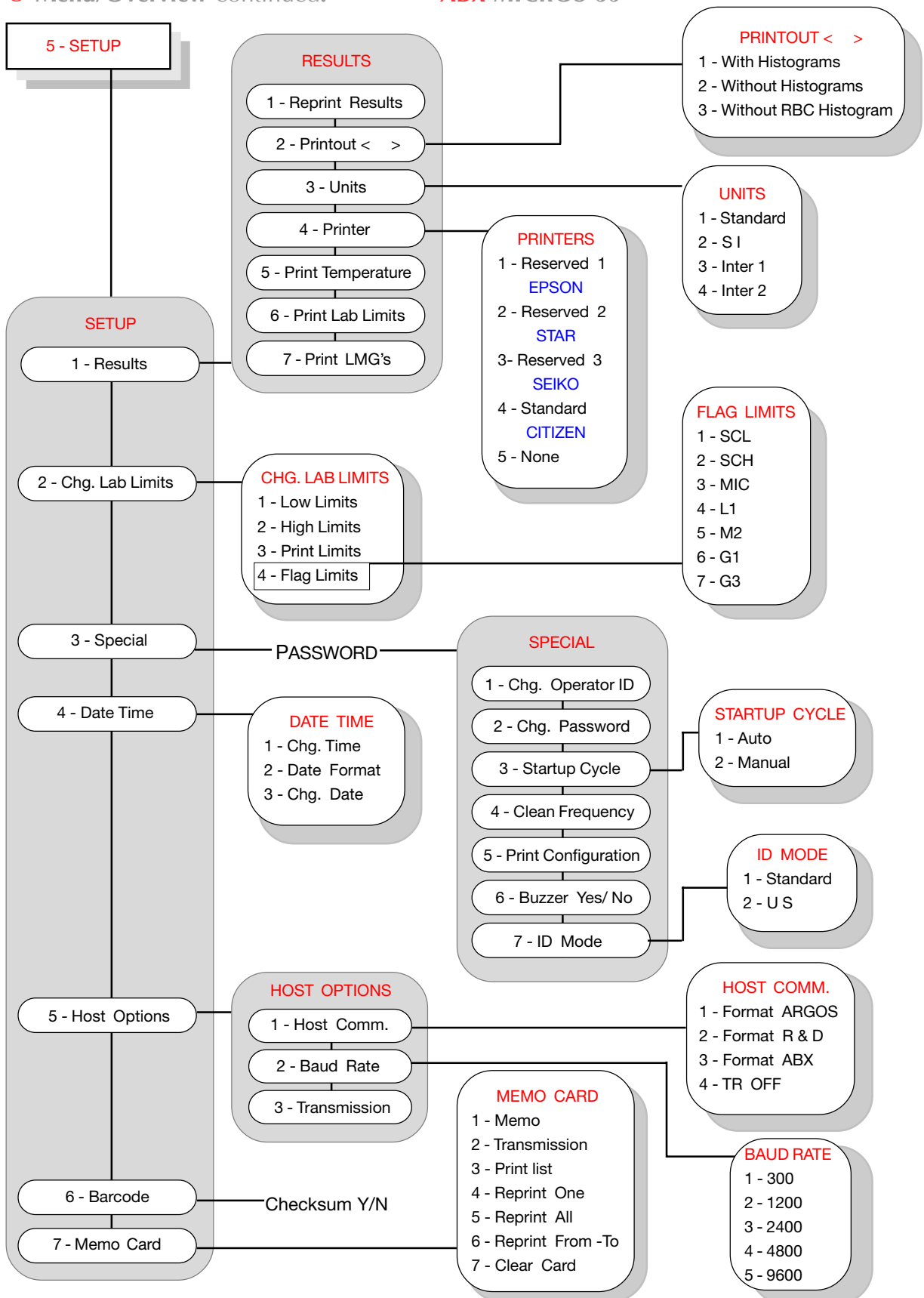

4. Quick Operations Reference

4.1. Power “ON” Instrument

1. Verify that the unit is connect to a power source, Turn the power switch, located on the back panel at the bottom center, to the “ON” position. The **ABX MICROS 60** will indicate: “PLEASE WAIT FOR 3min”. Verify that the Printer is filled with paper and power “ON” the printer.

4.2. Startup

2. The **ABX MICROS 60** will automatically run a “Startup” after the unit has been powered “On” for 3 minutes if and only if “Auto-Startup” was select in the instrument configuration.

3. If the **ABX MICROS 60** does not automatically run a Startup after the unit has been powered “On” for more that 3 minutes, press the < STARTUP > key located on the front panel.

4. After “Startup”, verify that the Background counts are within their limits as indicated:

Ⓞ Background Limits

Check and verify that the Background counts do not exceed the following parameter Limits:

WBC	0.3	10³/ mm³
RBC	0.02	10⁶/ mm³
HGB	0.0	g/dl
HCT	0	%
PLT	10	10³/ mm³

5. If Backgrounds are unacceptable, the **ABX MICROS 60** automatically performs a Second and Third count.

6. If counts are still unacceptable, perform a Concentrated Cleaning. From the Main Menu, Select <4> SERVICE then <4> CONCENTRATED CLEANING.

7. Follow the instructions on the LCD screen.

8. Run another < STARTUP >.

9. If the second Startup fails, call your local **ABX Technical Support Representative!**

4.3. Standby

At the end of the working day, press the < STANDBY > key. This will place cleaner into the chambers for an overnight cleaning.

Maintenance & Troubleshooting

4.4. Sample Analysis

1. Press the < ID > key and enter either the “Sample Identification” using the < Number > keys or the < UP > and < DOWN > arrow keys for alphabetical characters or “Run Number” using the number keys only.
2. Press the < ENTER > key to accept the entry.
3. Mix the sample gently and thoroughly before pressing the manual sample bar.
4. Place the sample beneath the sample probe, raise the sample so that the sample probe enters into the blood, and press the Manual Sample Bar. The analysis cycle will start automatically. If not, press the < START > key to start the analysis cycle.
5. The LED on the front panel will turn “Green” when the cycle is complete.
6. Results will automatically print out.
7. If any sample has Flags, (*, \$, !, ---D) Refer to **Section 3 - Startup and Sample Run**, 5. Flags.
8. If the sample has flags, repeat the sample.
9. If the repeated sample still has flags, perform a Concentrated Cleaning and re-run the sample again.
10. If the repeated sample still has (*) flags, call your local **ABX Technical Support Representative!**

4.5. Calibration

1. For **MINOCAL™**, (*Follow the Calibrator Package insert for mixing and Handling instructions*).
2. Refer to **Section 4 - Calibration and Quality Control**, 1.1. Calibration.
3. From the Main Menu, select <3> CALIBRATION then <1> AUTOCALIBRATION.
4. Confirm the OP., Lot #, Exp. date, and Number of replicates as instructed.
5. The display will indicate “Run Cal ?”, press the < ENTER > key.
6. The display will indicate “Start Calibration run” X/X, press the < ENTER > key.
7. Mix the Calibrator, **REMOVE CAP**, place it beneath the sample probe, raise the vial so that the sample probe enters into the blood, and press the Manual Sample Bar.
8. The calibration cycle will automatically begin. If not, press the < START > key.

Micros 60

Ⓞ Calibration continued:

9. Run the calibrator to the number of replicates select in Step # 4. Results automatically print when last sample has been completed.
10. Check for “New” or “Rejected” coefficients. If “New” and PASSED, continue with Quality Control. If “Rejected” and FAILED, perform a Concentrated Cleaning and re-run Calibration.
11. If Calibration is rejected a second time, call your local **ABX Technical Support Representative**.

4.6. Quality Control (With QC Smart Card)

1. For **MINOTROL™**, (*Follow the Control Package insert for mixing and Handling instructions*).
2. Place the “Quality Control Smart Card” in the reader (*if applicable*). If not, Refer to **Section 4 - Calibration and Quality Control**, 2.4. Q.C. Analysis.
3. From the Main Menu, select <2> QC then <1> AUTOMATIC if reader is present.
4. Confirm the OP., Lot #, Exp. date, and Level of Control.
5. Mix the Control level selected, **REMOVE CAP**, place it beneath the sample probe, raise the vial so that the sample probe enters into the blood, and press the Manual Sample Bar.
6. The Quality control cycle will automatically begin. If not, press the < START > key.
7. The results are compared to the ranges on the Smart Card. If the results are acceptable (NO Flags), press the < ENTER > key twice to accept the level result. If the results are unacceptable with Flags (*, \$, !, H, L), repeat the analysis of that level.
8. Continue with the next level of **MINOTROL** until all 3 levels have been run.
9. When all 3 levels of Controls have been ran, the display will indicate “Valid QC?”. Press the < ENTER > key to store the accepted QC data onto the card.
10. If any level of control fails twice, when repeated, perform a Concentrated Cleaning and re-run the control.
11. If controls fail again after the concentrated cleaning, call your local **ABX Technical Support Representative**.

Manual Probe Cleaning

① Concerns

- Unblocking Sample probe
- Replacing Sample probe

① Instrument Response/Problem type

- Low results on all parameters in any analysis mode
- No results on all parameters in any analysis mode
- Possible high backgrounds on startup

① Required Tools

- 5ml or 10ml syringe
- Absorbant paper
- 5 inch small diameter tubing
- Small paper cup

① Required Products

- **ABX MINOCLAIR 0.5L**, Part number (0401005)
- Or, 75% Regular Clorox Bleach solution.
(Mix 3 parts Bleach to 1 part Deionized Water)

① Intervention time

- Approximately 15 minutes

① Frequency

- As needed. In case of partially blocked probe
- Bent probe

① Specific Kits or Consumable products

- Sample Probe: P/N GBC 069 AS

Micros 60

1. Unblocking the Sample Probe

🕒 Procedure

1 - From the *MAIN MENU*, select 4 - *SERVICE*.

2 - Open the main door of the **ABX MICROS 60**.

3 - Hold the Sample probe mounting bracket on the upper right edge and move the sample probe “Downwards” until you can see the top of the probe and sample tubing.

4 - Remove the tubing from the top of the sample probe.

5 - Place the “Small paper cup” just below the end of the sample probe,

6 - Connect the tubing to the tip of the syringe and aspirate the the solution suggested from the required products on page 1.

7 - Place the free end of the syringe tubing on the top end of the sample probe and flush the probe. Verify that the solution is flowing directly into the paper cup.

10 - Hold the Sample probe mounting bracket on the upper right edge and move the sample probe “Upwards” until the tip of the sample probe is about 1 inch below the rinsing block.

11 - Press the “STARTUP” key to run a Startup and verify that the background results are within their limits.

12 - Re-run the Quality Controls to verify correct results.

MICROS 60 OS/OT



Note: If the Sample probe is free from blockage, the solution stream will appear to be straight and “pole like”. If a blockage is present, the solution stream will appear to be flared and/or at an angle. Flush the probe until the stream is straight.

8 - Once the sample probe is free from blockage, carefully remove the paper cup.

9 - Re-connect the Sample tubing to the top of the probe so that it is air tight.

2. Replacing the Sample Probe

Ⓞ Procedure

1 - From the *MAIN MENU*, select *4 - SERVICE*.

2 - Open the main door of the *ABX MICROS 60*.

3 - Hold the Sample probe mounting bracket on the upper right edge and move the sample probe “Downwards” until you can see the top of the probe and sample tubing.

4 - Remove the tubing from the top of the sample probe.

5 - Remove the sample probe “Retaining Clip”. (*Pull the clip out horizontally towards the front of the analyzer*).

6 - Hold the Sample probe mounting bracket on the upper right edge and move the sample “Upwards” until the top of the probe is just below the front panel.

7 - Very carefully pull the sample probe slightly out of its retaining slot.

8 - Now hold the sample probe around the retaining collar very carefully lift “Up” the probe so that it is free from the White needle guide.

10 - Place the retaining collar of the probe into its slot.

11 - Place the “Retaining clip” back onto the mounting bracket. (*Leave a **3mm** gap between the probe and clip. This will ensure that the sample probe will move freely, when moving up and down through the needle guide*).

12 - Re-connect the Sample tubing to the top of the probe so that it is air tight.

13 - Hold the Sample probe mounting bracket on the upper right edge and move the sample probe “Upwards” until the tip of the sample probe is about 1 inch below the rinsing block.

14 - Press the “STARTUP” key to run a Startup and verify that the background results are within their limits.

15 - Re-run the Quality Controls to verify correct results.

MICROS 60 OS/OT



Caution: The sample probe is fragile and may bend if not inserted into the needle guide correctly. Be careful when placing the probe. Try to maintain a vertical position of the probe when inserting it into the white needle guide!

9 - Place the New Sample probe in the white needle guide.

Extended Concentrated Cleaning

① Concerns

- RBC/PLT Chamber and Aperture cleaning
- WBC/HGB Chamber and Aperture cleaning

MICROS 60 OS/OT



Abnormalities or mishape may occur on blood counts due to a pollution e.g.(*clotted samples, pathological anomalies, fibrin layer, etc....*) which may not be removed by normal cleaning cycles (Standby, Auto clean). If the Cleaning cycles are non-affective in resolving the error, perform the following concentrated cleaning procedure!

① Required Tools

- 5ml or 10ml syringe

① Required Products

- **ABX MINOCLAIR 0.5L**, Part number (0401005)
- Or, 75% Regular Clorox Bleach solution.
(*Mix 3 parts Bleach to 1 part Deionized Water*)

① Intervention Time

- Approximately 30 minutes

① Specific Kits or Consumable products

- None

Micros 60

① Procedure

1 - From the Main Menu, use the “Down” arrow key to *select 4 - SERVICE*, then press the “ENTER” key to access the service functions.

2 - Use the “Down” arrow key to *select 1 - BACKFLUSH*, then press the “ENTER” key to backflush the WBC and RBC counting apertures.

3 - Perform a Backflush cycle (2) more times.

4 - Use the “Down” arrow key to *select 2 - DRAIN CHAMBERS*, then press the “ENTER” key to start the draining.

4 - Open the main door of the **ABX MICROS 60** and locate the WBC and RBC chambers. Some unit chamber shields are different. Either one chamber has a Black shield around it. This would be the WBC chamber, or both chambers have a Black shield around them.

5 - Locate the opening on the top of the chamber shield(s)

6 - Fill both chambers with **5ml** of the MINOCLAIR or the 75% bleach solution, which ever is available.

7 - Let the solution set for 10 minutes in the chambers.

8 - After 10 minutes, run a Concentrated cleaning. From SERVICE Menu, *select 4 - CONCENTRATED CLEANING*. Press the “ENTER” key and follow the steps indicated on the LCD screen.

When the system asks you to fill the chambers with cleaner, use the MINOCLAIR or 75% Bleach solution. (*the cleaning cycle time may vary due to the version of software*).

9 - Once the cleaning cycle is complete, perform a Backflush cycle. From the SERVICE Menu, *select 1 - BACKFLUSH*, then press the “ENTER” key to start the cycle.

10 - Perform the Backflush (2) more times.

11 - Once the backflush cycles are complete, press the Escape “ESC” key until you return to the Main Menu.

12 - Press the “STARTUP” key to run a startup. Verify that Background results are within their limits.

13 - Re-run Quality Control and verify that the results are within the Assay limits listed on the control Assay sheet that comes with the controls.

14 - If the problem still persists, repeat **steps 1 through 11 again**.

MICROS 60 OS/OT



Note: If the problem still persists after the second cleaning, call your local **ABX Technical Support Representative!**