

Microstrip, Stripline, CPW, and SIW Design

Iulian Rosu, YO3DAC / VA3IUJ, <http://www.qsl.net/va3iul>

In the first years of microwave development the **Rectangular Waveguide** became the dominant waveguide structure largely because high-quality components could be designed using it. One of the main issues was its narrow bandwidth due to the cut-off frequency characteristic.

Later, researchers try to find components that could provide greater bandwidth and possible miniaturization, and therefore they examined other waveguide types.

Ridge Waveguide offered a step in that direction, having one or more longitudinal internal ridges that serve primarily to increase transmission bandwidth by lowering the cut-off frequency.

Coaxial Line was very suitable, since it possessed a dominant mode with zero cut-off frequency, providing two important characteristics: very wide bandwidth, and the capability of miniaturization. The lack of a longitudinal component of field, made it more difficult to create components using it, although various novel suggestions were put forth. In addition, those components would be expensive to fabricate.

In an attempt to overcome these fabrication difficulties, the center conductor of the coaxial line was flattened into a strip and the outer conductor was changed into a rectangular box, and then fitted with connectors for use with regular coaxial line.

At about the same time, **Robert M. Barrett** when working for the Air Force Cambridge Research Center in 1950s took a much bolder step. He removed the side walls altogether, and extended the top and bottom walls sideways.

The result was called strip transmission line, or **Stripline**.

Like coaxial cable, Stripline it is non-dispersive, and has no cut-off frequency. Different methods were used to support the center strip, but in all cases the region between the two outer plates was filled with only one single medium, either dielectric material or air.

A modification that emerged almost in the same time involved removing the top plate leaving only the strip and the bottom plate with a dielectric layer between them to support the strip. That structure was named **Microstrip**.

The first Microstrip developments were done shortly after the appearance of Barrett's article, in 1952 by **D.D. Grieg** and **H.F. Engelmann** from the Federal Telecommunications Laboratories of ITT, presented as a competing printed circuit line.

Because of the symmetry unbalance in Microstrip, all discontinuity elements possess some resistive content and therefore make the line to radiate to some extent. At that time, regarding this radiation issue, additional remark was attempted to undermine the value of Microstrip line as the basis for microwave components. So, the Microstrip line was compared to an antenna, and it wasn't until about 15 years later, when the **Microstrip Patch Antenna** was proposed, which was based on precisely the same concept.

Types of Transverse Modes of Electromagnetic Waves

- **TE**, Transverse Electric waves, also referred as H-waves, are characterized by $E_z = 0$ and $H_z \neq 0$ (no Electric field in the direction of the propagation). TE waves can be supported inside closed conductors, as well as between two or more conductors.
- **TM**, Transverse Magnetic waves, also referred as E-waves, are characterized by $E_z \neq 0$ and $H_z = 0$ (no Magnetic field in the direction of the propagation). Same as TE the TM waves can be supported inside closed conductors, as well as between two or more conductors.
- **TEM** means Transverse Electromagnetic mode since both Electric and Magnetic fields are transverse (perpendicular) to the direction of propagation. $E_z = H_z = 0$. TEM mode is also termed a differential mode, because the signal current flowing on the inner conductor is directed opposite to the ground current flowing on the outer conductor. The TEM mode has several unique characteristics:
 - At least two unconnected conductors and a single insulating material are required for it to exist.
 - Its cut-off frequency is 0 Hz.
 - It has only two field components (E and H) aligned with the transverse coordinates, no longitudinal (z-directed) Electric or Magnetic field component.
 - Its propagation constant is the wavenumber in vacuum multiplied with the square root of the relative dielectric constant D_k (or ϵ_r) of the insulator.
 - In TEM mode, because of the symmetry of the structure, all discontinuity elements in the plane of the center strip are purely reactive.
- **Quasi-TEM** (Hybrid mode) has non-zero Electric and Magnetic fields in the direction of propagation. Hybrid modes are higher order modes with cut-off frequencies different from DC (0 Hz) and are undesirable. These modes are a combination of both, the transverse electric (TE) and transverse magnetic (TM) modes and thus have the longitudinal components of both, the electric and the magnetic fields. The wave propagates in two different medias (air and dielectric) in a hybrid mode.

Planar Transmission Lines

One of the most commonly used transmission lines are the planar types which can be constructed precisely using low-cost printed circuit board materials and processes. A number of these open, multiconductor transmission lines comprise a solid dielectric substrate having one or two layers of metallization, with the signal and ground currents flowing on separate conductors.

Planar transmission lines used in microwave frequencies can be broadly divided into two categories: those that can support a TEM (or Quasi-TEM) mode of propagation, and those that cannot. For TEM (or Quasi-TEM) modes the determination of characteristic impedance and phase velocity of single and coupled lines reduces to finding the capacitances associated with the structure, and also the conductor loss can be determined in terms of variation of the characteristic impedance.

An equivalent circuit for a section of a **planar transmission line** is shown below:

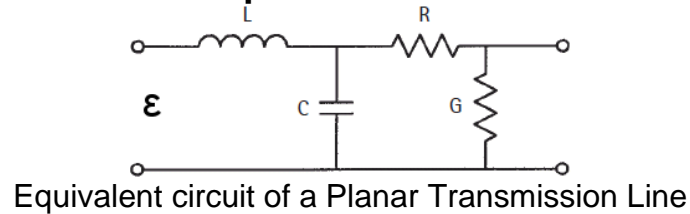

There are four parameters to look at this equivalent circuit: inductance (L), resistance (R), capacitance (C), and conductance (G).

Also there is the dielectric constant ϵ of the material in the planar transmission line.

- The **inductance L** (henries/unit length) in a planar transmission line, comes about because a current is flowing in a metallic conductor. With an alternative current AC (which is what RF and microwave signals are) flowing through a conductor, a magnetic field is set up by that current. The field reaches its maximum at the maximum amplitude of the current flowing. When the cycle reverses and begins to go in opposite direction, the magnetic field collapses and generates a current in the opposite direction. The expansion and collapse of fields produce an inductance in the conductor that is carrying the current. The arrangement of fields sets up an inductance on the transmission line that can be characterized as an inductance per unit length. The value of this inductance should be relatively low for proper operation of any RF or microwave transmission line, because the inductive reactance, which is the ohmic result of inductance, increases with frequency and can cause problems for high-frequency circuits.
- The **resistance R** (ohms/unit length) also is associated with the metallic conductor and current flow. Any time you have a current flowing through a metallic conductor, there will be a loss because there is a certain resistance in that conductor. This concept follows Ohm's law, which says that there is a voltage drop across a resistance when a current flow through that resistance.
- To build a capacitor, you have to have two plates of a certain area separated by a certain distance with a dielectric between them. One plate is the center conductor of the planar transmission line and the other plate is the ground, or shield. That is the **capacitance C** (farads/unit length) of the planar transmission line. This capacitance should be kept to a minimum (just like the inductance) because the capacitive reactance, which is a result of the line capacitance, decreases with an increase in frequency and causes the signals that are trying to propagate to be shorted to ground at certain frequencies.
- **Conductance G** (siemens/unit length) is the amount of leakage through the dielectric. There is always a certain amount of conductance, because there is no such thing as a perfect dielectric. That means a certain amount of energy going down the transmission line appears at the other conductor. Usually it is a very small quantity, because many dielectrics are very good insulators in such applications.
- The term **dielectric constant ϵ** , which it is the property of the material that is between the conductors, indicates basically how much the electromagnetic energy is obstructed as it moves through that material.

Material Properties

- **Relative Permittivity ϵ_r (or Dielectric Constant D_k) and Dissipation Factor (D_f).**
 - **D_k** is the property of a material which alters the **Electric field** in the wave.
 - **$D_k = \epsilon - j\epsilon'$** , where: **$\epsilon$ = energy stored**, and **ϵ' = energy lost**.
 - Materials used in PCB technology generally have **D_k** from 2 to 10 (D_k is dimensionless).
 - Generally, dielectric constant **D_k** , decreases as frequency increases.
 - The imaginary component of complex permittivity is the **dissipation factor D_f** .
 - **D_f** is the amount of dielectric loss the material imparts on the wave.
 - The **loss tangent $\tan\delta$** (or dissipation factor **D_f**) is the tangent of the phase angle between the resistive and reactive currents in the dielectric.
 - Low values of loss tangent **$\tan\delta$** result in a "fast" substrate while large value results in a "slow" substrate.
 - Values of the dissipation factor **D_f** (loss tangent) range from 0.001 to 0.030.
 - **Dissipation Factor D_f** increases slightly with frequency; for high frequency materials with very low values of **D_f** , it has very low variation with frequency.
 - **Dissipation factor D_f (or loss tangent $\tan\delta$)** is given by: **$D_f = \epsilon'/\epsilon$**
 - The permittivity may be quoted either as a static property or as a frequency-dependent variant.
 - Dielectrics are used in RF transmission lines as: coaxial cables, or in printed circuit boards (PCBs). The layers beneath etched conductors in PCBs act as dielectrics.
 - By definition, the linear relative permittivity of vacuum is equal to 1.
 - The relative permittivity of air changes with temperature, humidity, and barometric pressure.
 - The relative permittivity of a material for a frequency of zero is known as its **static relative permittivity**.
 - A parameter named **Design D_k** is not a material property, it is a circuit property. **Design D_k** is dependent on: the **intrinsic D_k** of the substrate, **thickness** of the substrate, copper **surface roughness**, and **frequency**.
- **Relative Permeability (μ_r)**
 - This is the property of a material which alters the **Magnetic field** in the wave.
 - This property is rarely used in microwave PCB applications.
 - Most PCB materials have **$\mu_r = 1$** .
 - Some plated finishes used on PCB's have ferromagnetic properties ($\mu_r \gg 1$).
 - Ferromagnetic issues can cause more conductor loss.
- **Conductivity (σ)**
 - Copper is typically the conductor for PCB's and printed transmission lines.
 - All plating finishes in PCB technology have lower conductivity than copper.
 - Lower conductivity causes more conductor loss and deeper skin depth in the conductor.
 - A copper surface which is rough will cause more conductor losses than smooth.

Skin Depth of Planar Conductors

When the source voltage is not DC, but high frequency AC, the current flowing in a conductor tends to be concentrated near the outer surface of the conductor. The higher the frequency, the greater the tendency for this skin effect to occur.

- The **skin depth** of a conductor is defined as the distance in the conductor (along the direction of the normal to the surface) in which the current density drops to 37% of its value at the surface (the current decays to a negligible value in a distance of about 4 to 5 skin depths).
- The skin depth of perfect conductor (with Conductivity $\sigma = \infty$) is zero.
- The conductivity of normal metals (which are used in conductors) is high, although finite, so the skin depth is therefore very small at microwave frequencies.
- The frequency where the skin effect just starts to limit the effective cross-sectional area of the conductor (equal to half the thickness of the trace) is called the crossover frequency.
- Skin depth is inversely proportional to the square root of the frequency.
- Skin depth does not depend on the shape of the conductor. Skin depth is a distance measured in from the surface of the conductor toward the center of the conductor.
- If skin depth is deeper than the center of the conductor, the current is not limited by the skin effect and the current is flowing uniformly throughout the entire cross-sectional area of the conductor. Therefore, a thicker conductor is limited by the skin effect at a lower frequency than is a thinner conductor.
- The skin effect, by changing the effective cross-sectional area of a conductor, causes the effective resistance of the conductor to change with frequency.
- The skin effect is one of the two primary causes of losses in lossy planar transmission lines (the other is dielectric losses)
- Copper skin depth at various frequencies:

Frequency	Copper Skin Depth
50 Hz	9.3mm
10 MHz	21um
100 MHz	6.6um
1 GHz	2.1um
10 GHz	0.66um

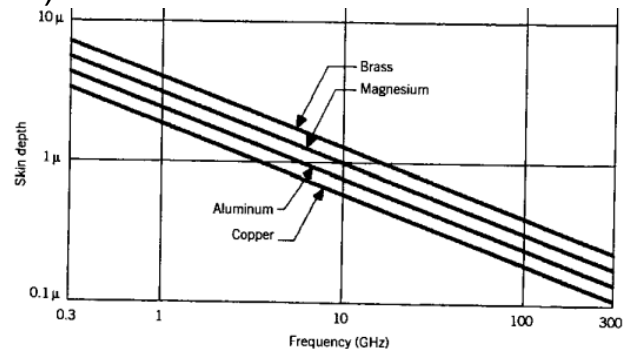

- As the frequency is increased, the current over the wire cross section will tend to crowd closer to the outer periphery of the conductor and eventually, the current will be concentrated on the wire's surface equal to the thickness of the skin depth, when the skin depth is less than the wire radius.

$$\delta = \frac{1}{\sqrt{\pi f \mu_0 \sigma}}$$

where δ is the skin depth, μ_0 is permeability of copper ($4\pi \cdot 10^{-7}$ H/m), σ is the conductivity of copper ($5.8 \cdot 10^7$ S/m), and f is frequency in Hz.

Stripline Design

Stripline transmission line requires three layers of conductors where the internal conductor is commonly called the “hot conductor,” while the other two, always connected at signal ground, are called “cold” or “ground” conductors. The hot conductor is embedded in a homogeneous and isotropic dielectric, of dielectric constant “ ϵ_r ”. So, unlike the case of **Microstrip**, the word “substrate” is not appropriate since the dielectric completely surrounds the hot conductor.

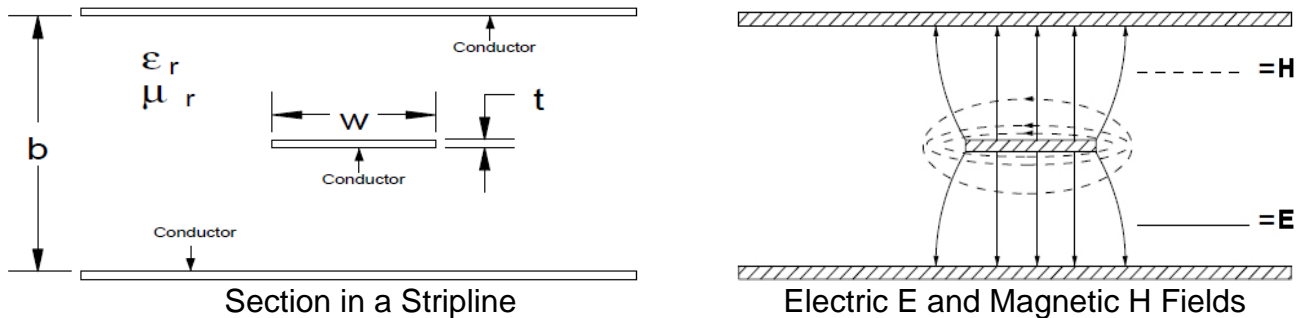

The Electric- E and Magnetic- H field lines for the fundamental TEM mode in Stripline are indicated above in a defined cross-section and a defined time.

- Because the region between the two outer plates of Stripline contains only a single medium, the phase velocity and the characteristic impedance of the dominant mode TEM do not vary with frequency.
- In the fundamental mode the hot conductor is equipotential (every point in it is at the same potential).

Stripline is often required for multilayer circuit boards because it can be routed between the layers, but grounding the Stripline requires some care. If the top and bottom ground planes are not at the same potential, a parallel-plate mode can propagate between them.

If excited, this mode will not remain confined to the region near the strip, but will be able to propagate wherever the two ground planes exist.

- Stripline is more insensitive than Microstrip to lateral ground planes of a metallic enclosure, since the electromagnetic field is strongly contained near the center conductor and the top–bottom ground planes.
- As can be seen from the figure, in a Stripline the return current path for a high frequency signal trace is located directly above and below the signal trace on the ground planes. The high frequency signal is thus contained entirely inside the PCB, minimizing emissions, and providing natural shielding against incoming spurious signals.

In the figure below, the parallel-plate mode is suppressed with metalized via holes connecting the two ground planes. The vias should be placed closely; a spacing “ s ” of one-eighth of a wavelength in the dielectric is recommended to prevent a potential difference from forming between the ground planes. In addition, such vias form a cage around the strip, in essence making it a basic coaxial line.

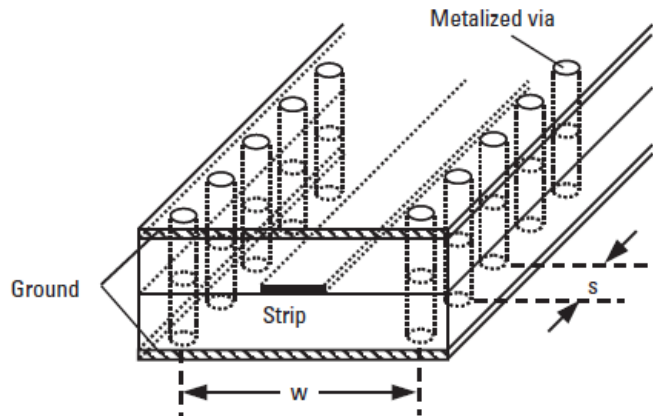

- When the vias are placed too close to the edge of the strip, they can perturb its characteristic impedance.
 - The vias separation “w” should be a minimum of 3 strip widths, and 5 is preferable.
 - If the via separation is too great, a pseudo rectangular waveguide mode can be excited. This mode has a cut-off frequency given by $c/(2*w)$, where c is the speed of light in the dielectric. Thus, at the highest frequency of operation, f_{max} , the via separation w should be less than $c/(2*f_{max})$.
 - Any practical Stripline has three **Sources of Attenuation**, due to:
 - Finite conductivity of its conductors.
 - Finite resistivity and dumping phenomena of the dielectric.
 - Magnetic resonances.
 - Total power losses per unit axial length are the sum of dielectric loss and the conductor ohmic skin loss.
 - The dielectric loss is proportional to frequency, and it is the dominant loss factor at higher frequencies.
 - The ohmic skin losses in the strip conductor and the ground plane, depend on the conductivity of the metal conductors and on any surface roughness may be caused in fabrication of the transmission line.
- Conductor losses dominate over dielectric losses for loss tangent ($\tan\delta$) less than 0.001 (for $f = 10$ GHz) and less than 0.003 (for $f = 1$ GHz).

The **Characteristic Impedance Z_0** of the Stripline depends on the dielectric constant and on the cross-sectional geometry of the strip center-conductor and ground planes.

- Characteristic impedance is very sensitive to the ratio of center-conductor width to dielectric thickness and relatively insensitive to the ratio of center-conductor thickness to dielectric thickness.
- Mechanical tolerances would be most critical for relatively thin dielectrics or relatively narrow center conductors. Any vertical asymmetry in the Stripline structure could couple to waveguide-type modes bounded by the ground planes and the side walls.

The following simple equation approximates Stripline impedance with 1% accuracy:

$$Z_0 = \frac{30\pi}{\sqrt{\epsilon_r}} \frac{b}{W_e + 0.441b} (\Omega)$$

where W_e is the effective width of the center strip conductor given by:

$$\frac{W_e}{b} = \frac{W}{b} - \begin{cases} 0 & \text{for } \frac{W}{b} > 0.35 \\ (0.35 - W/b)^2 & \text{for } \frac{W}{b} < 0.35 \end{cases}$$

- It is seen that the characteristic impedance of the Stripline decreases as the strip width W increases.
- The **Propagation Delay** (t_{pd}) for a given length in a Stripline is only function of the dielectric ϵ_r :

$$t_{pd} \text{ (nsec/ft)} = 1.017 \sqrt{\epsilon_r}$$

Microstrip Design

The Microstrip line it has become the best known and most widely used planar transmission line for RF and Microwave circuits. This popularity and widespread use are due to its planar nature, ease of fabrication using various processes, easy integration with solid-state devices, good heat sinking, and good mechanical support.

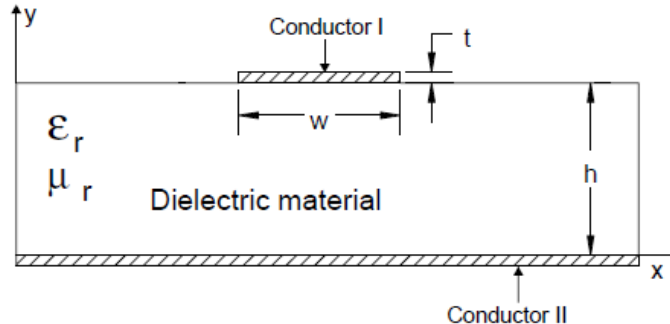

- In simple terms, Microstrip is the printed circuit version of a wire over a ground plane, and thus it tends to radiate as the spacing between the ground plane and the strip increases. A substrate thickness of a few percent of a wavelength (or less) minimizes radiation without forcing the strip width to be too narrow.
- In contrast to Stripline, the two-media nature (substrate discontinuity) of Microstrip causes its dominant mode to be hybrid (Quasi-TEM) not TEM, with the result that the phase velocity, characteristic impedance, and field variation in the guide cross section all become mildly frequency dependent.
- The Microstrip line is dispersive. With increasing frequency, the effective dielectric constant gradually climbs towards that of the substrate, so that the phase velocity gradually decreases. This is true even with a non-dispersive substrate material (the substrate dielectric constant will usually fall with increasing frequency).
- In Microstrip development a new concept of **Effective Dielectric Constant** ϵ_{eff} (or Dk_{eff}) was introduced, which takes into account that most of the electric fields are constrained within the substrate, but a fraction of the total energy exists within the air above the board.
- The Effective Dielectric Constant ϵ_{eff} varies with the free-space wavelength λ_0 . The dispersion becomes more pronounced with the decreasing ratio of strip width to substrate thickness, W/h . Dispersion is less pronounced as the strip width

becomes relatively wider, and the Microstrip line physically starts to approach an ideal parallel-plate capacitor. In this case we get: $\epsilon_r \sim \epsilon_{eff}$

- The Effective Dielectric Constant ϵ_{eff} is expected to be greater than the dielectric constant of air ($\epsilon = 1$) and less than that of the dielectric substrate.

$$\epsilon_{eff} = \frac{\epsilon + 1}{2} + \frac{\epsilon - 1}{2} \frac{1}{\sqrt{1 + 12h/W}}$$

In this expression shielding is assumed to be far enough from the Microstrip line.

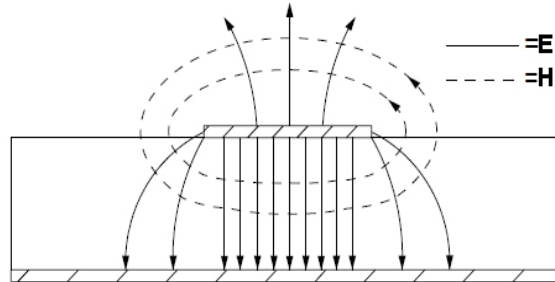

Electric-E and Magnetic-H field lines for fundamental Quasi-TEM in Microstrip

- Effective Dielectric ϵ_{eff} can be obtained by static capacitance measurements.
 - If the static capacitance per unit length is C with partial dielectric filling, and C_0 with dielectric removed, we get $\epsilon_{eff} = C/C_0$.

- Guided Wavelength in Microstrips is given by:

$$\lambda_0 / \sqrt{\epsilon_{eff}} \quad \text{where } \lambda_0 \text{ is the wavelength in free space}$$

- The same as in Stripline case, in Microstrip fundamental mode the hot conductor is equipotential (every point in it is at the same potential).
- A simple but accurate equation for Microstrip **Characteristic Impedance** is:

$$Z_0 = \frac{60}{\sqrt{\epsilon}} \ln \left(\frac{8h}{W} + \frac{W}{4h} \right) (\Omega) \quad \text{for } \frac{W}{h} \leq 1$$

$$Z_0 = \frac{120\pi}{\sqrt{\epsilon} \left[\frac{W}{h} + 1.393 + 0.667 \ln \left(\frac{W}{h} + 1.444 \right) \right]} (\Omega) \quad \text{for } \frac{W}{h} \geq 1$$

- The characteristic impedance of the Microstrip line changes slightly with frequency (even with a non-dispersive substrate material).
The characteristic impedance of non-TEM modes is not uniquely defined, and depending on the precise definition used, the impedance of Microstrip either rises, falls, or falls then rises with increasing frequency.
The low-frequency limit of the characteristic impedance is referred to as the **Quasi-static Characteristic Impedance**, and is the same for all definitions of characteristic impedance.
- Microstrip frequency limitation is given mainly by the lowest order transverse resonance, which occurs when width of the line (plus fringing field component) approaches a half-wavelength in the dielectric. Have to avoid using wide lines.
- For very wide lines, the fields are almost all in the substrate, while narrower lines will have proportionally more field energy in air.

- **Propagation Delay** for a given length in a Microstrip line is only function of ϵ_r :

$$t_{pd}(\text{ns/ft}) = 1.017\sqrt{0.475\epsilon_r + 0.67}$$

- Any practical Microstrip line has the following **Sources of Attenuation**, due to:
 - Finite **conductivity** of the line conductors.
 - Finite **resistivity** of the substrate and its **damping** phenomena.
 - **Radiation** effects.
 - **Magnetic** loss plays a role only for magnetic substrates, such as ferrites.
- Waveguides and Striplines have no **radiation losses**, while in Microstrip case (since the Microstrip is an open transmission line) radiation effects are present at any discontinuity section.
- For Microstrip using high dielectric materials ϵ_r (**Dk**) and accurate conductor shape and matching, conductor and dielectric losses are predominant in relation to the radiation losses.
- In practice, it has been found that the Microstrip impedance with finite ground plane width (**Zo**) is practically equal to the impedance value with infinite width ground plane (**Zi**), if the ground width **Wg** is at least 3 times greater than width (**Wg > 3*W**).

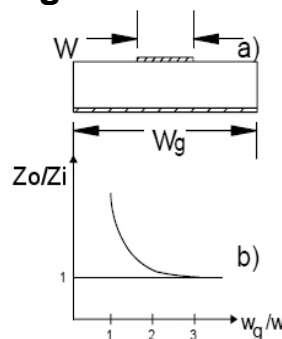

Microstrip's primary advantages of low cost and compact size are offset by its tendency to be more lossy than Coaxial Line, Waveguide, CPW, and Stripline.

- Microstrip transmission lines suffer from three types of losses: conductor, dielectric, and radiation losses. The first two are fairly well understood, with **Conductor Loss** dependent on the type of metal used for the transmission lines and the dimensions of those lines (with loss increasing with length) and **Dielectric Loss** a function of the type of printed-circuit-board (PCB) substrate material.
- **Radiation Losses** depend on the dielectric constant, substrate thickness, the circuit geometry and also depends by frequency, increasing with increasing frequency.
- Radiation loss can vary its magnitude due to the circuit configuration (microstrip, stripline, or coplanar CPW).
- Radiation loss is not exclusive to microstrip lines, although its effects are more noticeable in microstrip than in stripline or coplanar-waveguide circuits CPW.
- Stripline transmission lines, because they are enclosed by dielectric material, exhibit almost no radiation loss.

- Coplanar-waveguide CPW circuits suffer minimal radiation losses, except at transmission-line discontinuities, such as a junction or step.
- In certain microstrip circuits, such as filters and couplers, radiation loss can significantly impact performance, resulting in increased insertion loss, changes in signal phase, and shifts in resonant frequency.
- The lower the dielectric constant, the less the concentration of energy in the substrate region, and, hence, the greater the radiation losses.
- Higher the thickness of the material, higher the radiation losses.
- Higher the frequency, higher the radiation losses.
- Circuit geometry could generate impedance transitions and discontinuities, which increase the radiation losses.
- The real benefit in having a higher dielectric constant is not only reducing radiation losses but also that the package size decreases by approximately the square root of the dielectric constant.
- Dielectric substrates with low dielectric constants D_k (such as less than 5.0), have often been used in microwave microstrip circuits because of their low cost and versatility: they yield larger circuit geometries for a given frequency compared to circuit materials with higher dielectric constants D_k , helping to simplify fabrication at higher frequencies.
- With the lower dielectric constant, less of the conducted electromagnetic (EM) energy is concentrated in the substrate and the microstrip metal conductor, leading to losses as a result of radiation effects.
- Using a higher dielectric constant D_k will reduce radiation losses because a greater part of the EM field is concentrated in the dielectric material between the ground plane and the microstrip metal conductor.
- The increase in substrate dielectric constant will also miniaturize the dimensions of the microstrip circuitry, roughly decreasing in size by a factor equal to the square root of the dielectric constant. If making such choice of higher dielectric material, attention should be paid to other material parameters, so as to not trade lower radiation loss for higher dielectric loss.
- The thickness of a PCB material also impacts the amount of radiation loss exhibited by a microstrip circuit at higher frequencies.
For lower dielectric constant circuits, radiation losses can be reduced by using a thinner dielectric substrate.
Radiation losses can also be reduced with a thicker substrate material having a higher dielectric constant, although a further reduction in radiation losses can also be achieved by using a thinner material at that higher dielectric constant.
The shrinking of circuit dimensions that comes from using a substrate with higher dielectric constant can be a concern at millimeter-wave circuits, where the circuit dimensions and tolerances may become critical for some fabrication processes.

- One way to lower the loss of Microstrip line is to suspend the substrate over the air:

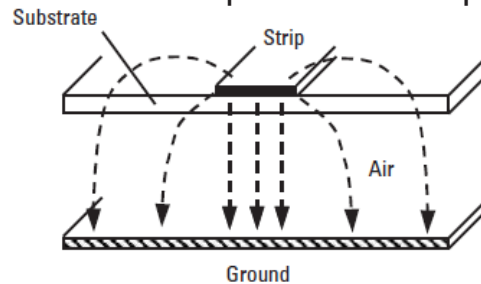

The air between the bottom of the substrate and the ground plane contains the bulk of the electromagnetic field. The insertion loss of the Microstrip is reduced because, air essentially has no dielectric loss compared to standard circuit board substrates, and in addition, the width of the Microstrip line increases because of the lower effective dielectric constant. Wider lines have lower current density, and thus, lower ohmic loss.

- Suspending Microstrip means that the separation between the signal and ground paths increases, and so does the Microstrip's tendency to radiate, particularly at discontinuities such as corners. From this reason, suspended Microstrip mostly is used only up to a few GHz.
- In a Microstrip line, conductor losses increase with increasing characteristic impedance due to the greater resistance of narrow strips. Conductor losses follow a trend that is opposite to radiation loss with respect to W/h .
- Important to remember, a smaller strip width leads to higher losses.
- Very simple method for measuring the **Dielectric Attenuation** constant is based on the Comparison Technique.
 - Two Microstrip lines with identical electrical characteristics but different lengths are used.
 - Their insertion losses are measured.
 - The difference between two values of insertion loss is used to evaluate the dielectric attenuation constant.
 - This procedure avoids the systematic errors caused by radiation and coaxial-to-microstrip transitions.
- Dielectric loss can be reduced by using substrates with a low dielectric loss. To minimize radiation loss, the number of discontinuities, such as bends and T-junctions, should be made as small as possible.
- Radiation from a curved microstrip line is much smaller compared to radiation from a right-angled bend.
- At very high frequencies, to reduce radiation loss in a feed network, the width of the microstrip line should be less than $\lambda/8$.
- Conductor loss may be minimized by designing the feed network length per wavelength as short as possible. By using a multilayer feed network design, the feed network length per wavelength is minimized considerably.
- Thickness of the metal microstrip lines (using the same substrate) affect the insertion loss.
 - Thinner circuits are dominated by conductor loss.
 - Thick circuits are dominated by dielectric loss.

Final plated finishes and copper roughness have an impact on conductor loss

- Microstrip, final plated finish impacts the conductor loss due to high current density at the edge of the conductor.
- With the exception of silver, most metal finishes used in the PCB industry are less conductive than copper (gold, nickel, aluminum, brass, solder, tin).
A lower conductivity will cause higher conductor losses, which increases insertion loss. Silver is the exception and does not increase copper conductor loss.
- Gold plating is very thin (about 0.05um) but skin depth will not approach this thickness until about 1 THz.
- Electroless Nickel Immersion Gold (ENIG) is a common type of surface plating used for PCBs. It consists of an electroless nickel plating covered with a thin layer of immersion gold, which protects the nickel from oxidation.
- When skin depth is near the same dimension as copper surface roughness or less, the surface roughness will significantly increase conductor loss and it will slow the wave propagation.
- Some degree of copper roughness is always applied to promote adhesion to the dielectric material, and improves peel strength of laminate.
- Electrical impact of conductor roughness increases with frequency, increase the capacitance, increase the group delay, decrease the characteristic impedance over a wide bandwidth, and apparently increase **Dk** to match the group delay vs frequency characteristic.

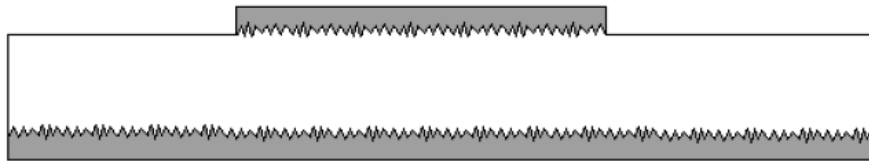

Microstrip cross-sectional view, with exaggerated copper roughness

- The **Power Handling** capacity of a Microstrip is limited by heating caused because of ohmic and dielectric losses and by dielectric breakdown.
An increase in temperature due to conductor and dielectric losses limits the Average Power of the Microstrip line, while the breakdown between the strip conductor and ground plane limits the Peak Power.

A metallic enclosure is normally required for most Microstrip circuit applications, such as Microstrip Filters. The presence of conducting top and side walls will affect both, the characteristic impedance Z_c and the effective dielectric constant ϵ_{eff} (or **Dk_{eff}**).

- In practice, a rule of thumb may be applied in the Microstrip Filter design to reduce the effect of metallic enclosure: the height up to the cover should be more than eight times the substrate thickness, and the distance to walls more than five times the substrate thickness.

Coplanar Waveguide (CPW) Design

Coplanar Waveguide (CPW) is an alternative to Microstrip and Stripline that place both, the signal and ground currents on the same layer.

- **Cheng P. Wen** is the inventor of Coplanar Waveguide in 1969, when working at RCA's Sarnoff Laboratories. The initial paper he published was: "Coplanar Waveguide: a surface strip transmission line suitable for nonreciprocal gyromagnetic device applications".
- The conductors formed a center strip separated by a narrow gap from two ground planes on either side. The dimensions of the center strip, the gap, the thickness and permittivity of the dielectric substrate determined the effective dielectric constant, characteristic impedance and the attenuation of the line.
- The gap in the coplanar waveguide is usually very small and supports electric fields primarily concentrated in the dielectric. With little fringing field in the air space, the coplanar waveguide exhibits low dispersion. In order to concentrate the fields in the substrate area and to minimize radiation, the dielectric substrate thickness is usually set equal to about twice the gap width.
- CPW has a zero-cut-off frequency (suitable for wideband), but its low order propagation mode is indicated with Quasi-TEM because it is not a real TEM mode. At higher frequencies, the field becomes less-TEM, and more TE in nature. The CPW magnetic field is elliptically polarized.
- CPW it is a printed circuit analog of the three-wire transmission lines.

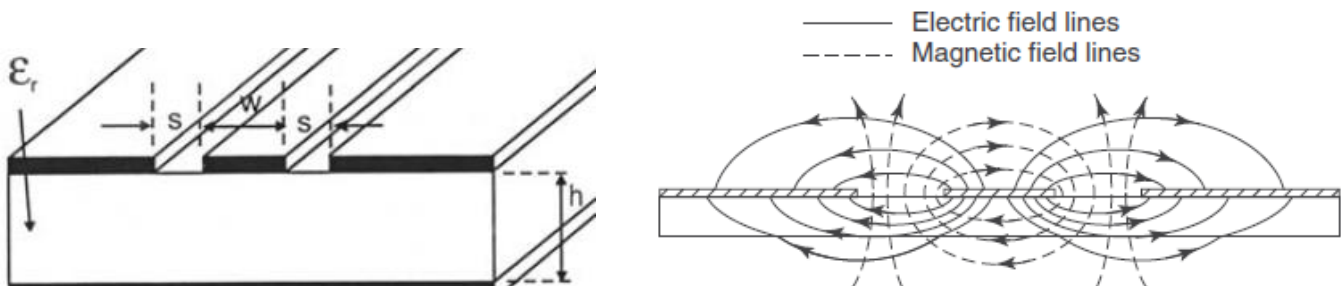

CPW Electric-E and Magnetic-H field distribution

- Like Stripline, CPW has two ground planes, which must be maintained at the same potential to prevent unwanted modes from propagating.
- If the grounds are at different potentials, the CPW mode will become uneven, with a higher field in one gap than the other.
- In the CPW two fundamental modes are supported: the coplanar mode, and the parasitic slotline mode. Air bridges between ground planes have to be applied to suppress the undesired slotline mode.
- If bond wires are used to connect the ground planes the wires should be spaced one quarter wavelength apart or less.

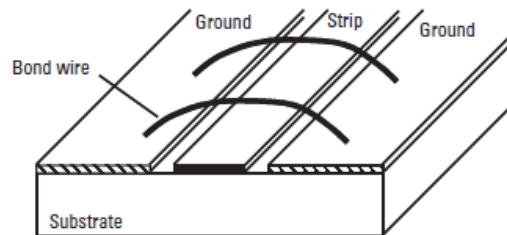

- In the CPW, the effective dielectric constant is approximately independent of geometry, and simply equal to the average of dielectric constants of air and the dielectric substrate.
- Frequency dispersion for CPW is generally small, but there is a mild dependence on line dimensions, and narrow lines are less frequency dispersive than wide lines.
- **Grounded Coplanar Waveguide (GCPW)** is used on printed circuit boards as an alternative to Microstrip line. The gap s between the strip and ground is usually more than the thickness h of the substrate, so the GCPW field is concentrated between the strip and the substrate ground plane, and GCPW behaves like Microstrip. With vias connecting the ground planes, GCPW is less prone to radiate and has higher isolation than Microstrip.

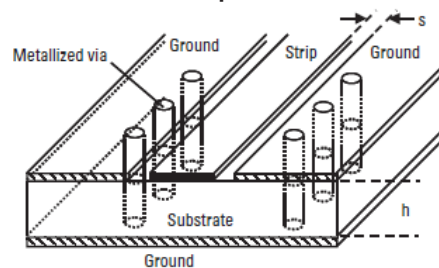

- Since the number of the electric and magnetic field lines in the air is higher than the number of the same lines in the Microstrip case, the effective dielectric constant ϵ_{eff} of CPW is typically 15% lower than the ϵ_{eff} for Microstrip, so the maximum reachable characteristic impedance values are higher than the Microstrip values.
- The effect of finite dielectric substrate is almost ignorable if h exceeds $2b = W + 2s$.
- In addition, to avoid field radiation in the air, it is very important to use substrates with a high dielectric constant, with recommended values greater than 10, so that the electromagnetic field is mainly concentrated inside the dielectric.
- In CPW a ground plane exists between any two adjacent lines, hence cross talk effects between adjacent lines are very weak. As a result, CPW circuits can be made denser than conventional Microstrip circuits.

As other planar transmission lines, the **CPW losses** are due to multiple causes:

- Non-perfect conductivity of the conductors, or “conductor loss”.
- Dielectric nonzero conductivity and dumping phenomena.
- Substrate magnetic loss, if the substrate is a ferromagnetic material.
- Radiation loss.
- CPW is not very sensitive to substrate thickness and allows a wide range of impedance values (20Ω - 250Ω) on relatively thick substrates.
- Upper metal cover has no effect upon characteristic impedance if space $H > 2h$.

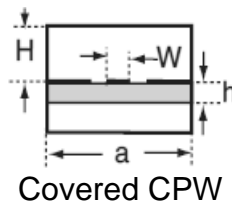

When this limit is exceeded, the effect of the cover will be to lower characteristic impedance.

- Spurious modes (notably the Microstrip mode) can easily be generated if the separation between the CPW structure and the backing metallization is too close (resulting in field lines between the CPW and the backing metallization).
- In CPW the characteristic impedance is determined by the ratio of the center strip width W to the gap width s , so size reduction is possible without limit, the only penalty being higher losses. This makes the design of a CPW line with particular impedance unique because an infinite range of W and s values will result in a specific impedance requirement.
- For given characteristic impedance Z_0 and substrate thickness, the strip width W will always be significantly less than for the corresponding Microstrip, in order to maintain the same capacitance to ground. Therefore, the resistive loss for the CPW line can exceed that of the corresponding Microstrip.
- Copper surface roughness has an impact on Grounded Coplanar Waveguide (GCPW), but the effect can be slightly different than Microstrip.
- A tightly coupled GCPW circuit will be slightly less impacted by the copper surface roughness of the laminate as compared to a loosely coupled GCPW circuit.
- Trapezoidal effect can also lightly alter the impact of the effects of copper roughness.

The trapezoidal effect or "edge profile", where the PCB conductors are ideally rectangular in cross-sectional view but in the actual circuits are trapezoidal shape. This can cause current density in the coplanar GSC area to vary; an ideal rectangular conductor structure will have more current density up to the sidewalls of the adjacent conductors in this region, whereas the trapezoidal structure will have more current density at the base (copper-substrate interface). When is more current density at the base, due to trapezoidal effect, the copper surface roughness will have more influence on losses and the propagation constant.

Substrate Integrated Waveguide (SIW) Design

A standard **rectangular waveguide** with air dielectric has been around for very long time and have extremely good performances.

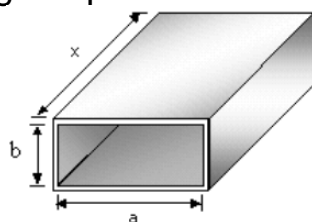

Rectangular waveguide

- The standard rectangular waveguide has no dispersion and no radiation. Dispersion is a change in wave propagation with a change in frequency, and radiation is how much energy is radiated off by an RF structure.
- Since air is its medium of propagation, the waveguide it will have very low insertion loss and consistent phase response, within the range of frequencies where the waveguide operates.
- Energy from frequencies below cut-off will not propagate within the waveguide and the waveguide acts as a high-pass filter.

The dominate wave propagation mode above cut-off frequency is TE₁₀.

In a standard rectangular waveguide (with air dielectric and 2:1 a/b width/height ratio) the cut-off frequency f_c is given by:

$$f_c = \frac{c}{2a}$$

where f_c is the cut-off frequency in Hz, c is the speed of light in m/sec, and a is the width in meters. Dimension a is equal to 1/2 wavelength of the lower cut-off frequency.

For a DFW (Dielectric Filled Waveguide) the a_d (waveguide width with dielectric) is:

$$a_d = \frac{a}{\sqrt{\epsilon_r}}$$

where ϵ_r is the dielectric constant (**Dk**) of the material.

Substrate Integrated Waveguide (SIW) is a new topology of transmission lines, which intend to emulate a standard rectangular waveguide structure using PCB technology.

A SIW structure is created within a PCB substrate (usually by adding a top metal over the ground plane and caging the structure with rows of through hole plated vias on either side. To an EM wave, this structure looks like a dielectrically filled rectangular waveguide (DFW), with reduced height compared to the standard waveguide 2:1 width/height ratio.

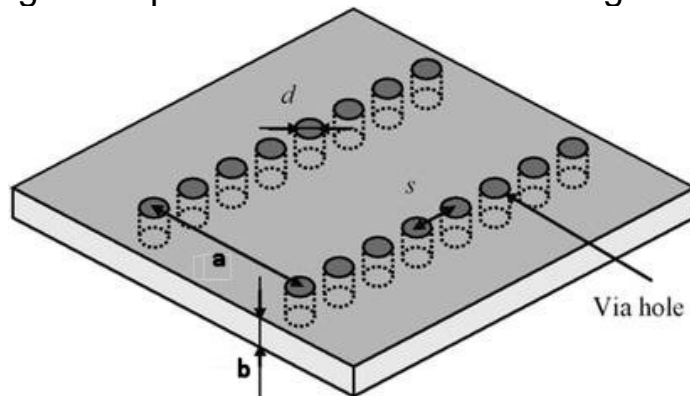

Substrate Integrated Waveguide (SIW)

- A medium in the waveguide with dielectric constant (**Dk** or ϵ_r) greater than 1 (air) will cause the dimension a "width" to decrease while maintaining the same frequency. This phenomenon will give a higher useable frequency range to the SIW structure.

- Dimension **b "height"** has no effect on the cut-off frequency, but reduces the impedance the wave sees (due to increases of capacitance/length ratio).
- However, the height **b** can be influential for insertion loss, phase response, isolation and suppressing other propagation modes.
- The relationships between SIW parameters and the **effective width w_{eff}** of rectangular waveguide with same propagation characteristics are:

$$w_{\text{eff}} = a - d^2 / 0.95 s$$

$$w_{\text{eff}} = c / [2f_c (\sqrt{\epsilon_r})]$$

$$w_{\text{eff}} = a - 1.08(d^2/s) + 0.1(d^2/a)$$

where **a** is the physical SIW width, **d** is the diameter of the via hole, **s** is the center-to-center distance between adjacent vias (pitch), **w_{eff}** is the **effective width** of SIW, **c** is the velocity of light, **f_c** is the cut-off frequency of the dominant TE₁₀ mode and **ε_r** is the substrate permittivity (dielectric constant).

- The **SIW impedance Z_0** , can be computed from:

$$Z_0 = (b / w_{\text{eff}}) [\eta / (\sqrt{1 - (\lambda / \lambda_c)^2})]$$

$$\eta = 120\pi / \sqrt{\epsilon_r}$$

where **λ** is the free space wavelength, **λ_c** is the cut-off wavelength, and **b** is the height.

- Impedance of SIW is inversely proportional to the dielectric constant **ε_r** for constant effective width **w_{eff}**.
- Impedance of SIW is inversely proportional to effective width **w_{eff}** for a constant **ε_r**.
- The top and the bottom of the PCB based rectangular waveguide will be the copper planes of the laminate. The sidewalls of the PCB based rectangular waveguide are done using **Plated Through Hole (PTH) vias**. They will not be perfect sidewalls, but will be approximate.
- Vias diameters and spacing shall be carefully modeled using EM simulators. As a rule, the via diameter **d** shall be: **d < (λ_g/5)**
- The distance between center of the vias (pitch **p**) shall be: **p < 2d**
- If the distance (pitch) between PTH vias is less than 1/10th of the wavelength, then they will behave as approximate sidewalls.
- The pitch must be as small as possible to minimize radiation leakage. To eliminate band gap effect and ensure mechanical rigidity the SIW should satisfy:

$$0.05 < s/\lambda_c < 0.25$$

where **λ_c** is the cut-off wavelength

- Because the plated vias always have an amount of distance between them, the leakage loss in SIW can be substantial.
- In SIW the conductor loss is lower than in any other printed structure due to the greater amount of metal that carries the signal.

- However, compared to standard rectangular waveguides (using air dielectric and having no dispersion and no radiation) SIW should deal with dielectric losses as any other printed structures does. Dielectric losses are proportional with frequency.
- Compared to Stripline, Microstrip, or CPW, which all have zero-cut-off frequency, the SIW structure exhibits a cut-off frequency.
- Because there are vias at the sidewalls of the SIW structure, transverse magnetic (TM) modes don't exist and TE_{10} is the dominant mode of propagation.
- The absence of TM modes and its inherent structural flexibility makes SIW promising for filter design.
- Planar transmission lines such as **microstrip** or **stripline** achieve quality factors from 50 to 100, whereas Q of metallic waveguide is in the range of 1000 to 12000. SIW structures aims to achieve the intermediate Q-factor values.

In the plots below can be seen the high-pass response of the SIW structure and the corresponding return loss.

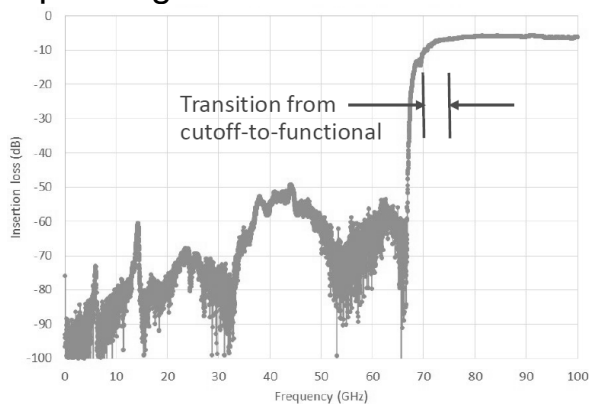

SIW Insertion Loss

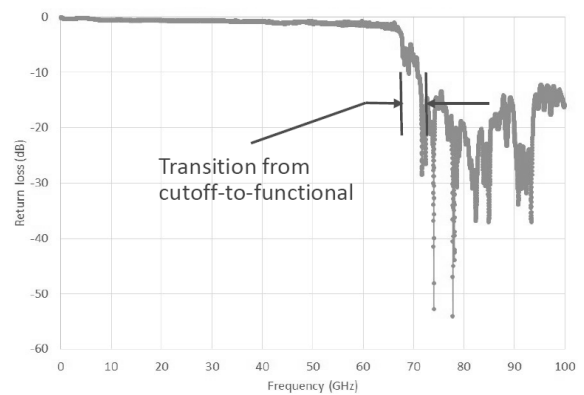

SIW Return Loss

Transitions from the feedline to SIW

The SIW transition has a major influence on the cut-off frequency and also on the return loss within the passband of the SIW structure.

The transition is the input source for the SIW and if doesn't work well the entire SIW structure will not perform as desired.

- There are few types of transitions to a SIW structure, and most common are:
 - Microstrip-to-SIW
 - GCPW (grounded coplanar waveguide)-to-SIW
 - Stripline-to-SIW
 - Waveguide-to-SIW

Each transition has pros and cons for how it impacts the RF performances of the SIW.

- The transition acts basically as an impedance matching network; the feedline is usually 50 ohms and SIW is very low impedance (typically < 1 ohm).
- For a wideband SIW response, the cut-off-to-functional transition requires a wider frequency range.
- For a narrowband SIW response, the cut-off-to-functional transition is more abrupt.

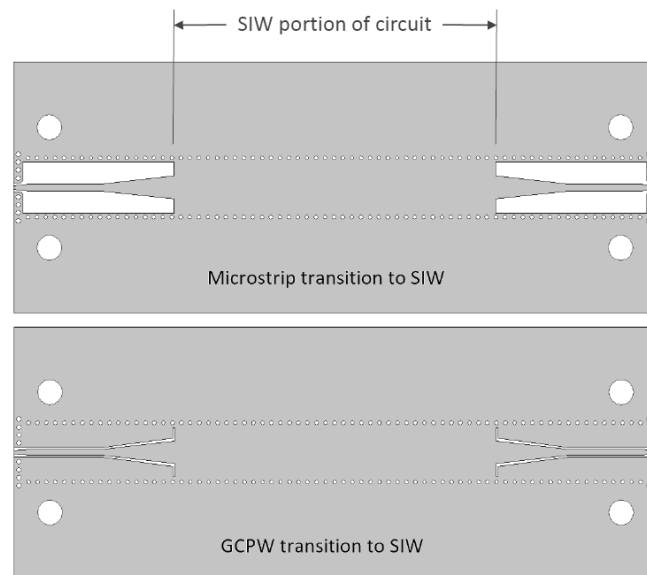

Microstrip and CPW transitions to SIW

- Properties of the SIW pitch (distance between center of vias) and vias diameter:
 - when vias diameters increases, the bandwidth of the SIW structure narrows from the higher frequency side.
 - when the distance between vias increases, the bandwidth of the SIW narrows from the higher frequency side and for higher distance values the characteristic response is distorted.

It is a general consideration that GCPW has better benefits than a Microstrip structure.

- When is designed properly the GCPW can have less radiation loss, less dispersion, and good mode suppression, but the RF performances of GCPW are more impacted by normal PCB fabrication variables than Microstrip structures.
- Also, final finish plating has bigger impact in GCPW than in Microstrip.

The considerations of choice for the SIW transition structure, it is very important to consider how the SIW transition structure can vary due to PCB fabrication, because as was previously shown, GCPW has many benefits in theory, however, its RF performance is more impacted by PCB fabrication.

- For SIW operating at mmWave frequencies it is highly recommended to use a field solving software, and vary the tolerances of the geometry, of the substrate, and of the grounding vias.
Build the circuits with (some of) these variations and verify the results.
- Via hole location tolerance is a very significant issue. An experiment using a dual row of vias improve the cut-off variation by less than 3dB.
- Was experimental found that for the same SIW structure dimensions but using different substrate thickness, shows that:
 - thicker substrate results in a lower insertion loss.
 - thinner substrates result in better isolation in the stop band.

- A SIW structure at mmWave frequencies, due to the circuit geometry differences, it is possible to get a consistent bandpass filter characteristic response. This property would be hard to be implemented using Stripline, Microstrip or CPW structures.
- Copper surface roughness does impact the SIW transition and the SIW itself. A rougher copper surface slows the wave, and a slower wave is perceived as a higher dielectric constant (Dk or ϵ_r).
- Substrate Integrated Waveguide (SIW) with rougher copper surface (higher RMS) have higher effective Dk_{eff} .
- If the material is unchanged, it is only the copper roughness differences that are impacting the effective dielectric constant (Dk_{eff} or ϵ_{eff}) of the SIW circuits, and also the phase response of the circuits.

Parameters that affect the performances of various planar RF structures

The following are the parameters of whose **normal variations in PCB fabrication** can influence performances of various structures at microwave frequencies:

- **Stripline**
 - Conductor width.
 - Substrate thickness (distance between the two ground planes).
 - Distance from the stripline to the upper and to the lower ground plane.
 - Copper surface roughness.
 - Substrate dielectric constant Dk .
- **Microstrip**
 - Conductor width.
 - Substrate thickness.
 - Copper surface roughness.
 - Substrate dielectric constant Dk .
- **Grounded Coplanar Waveguide (GCPW)**
 - Conductor width.
 - Coplanar spacing.
 - Copper thickness.
 - Conductor trapezoidal effect.
 - Copper surface roughness.
 - PTH (Plated Through Hole) via location.
 - Substrate thickness.
 - Substrate dielectric constant Dk .
- **Substrate Integrated Waveguide (SIW)**
 - PTH (Plated Through Hole) via location.
 - Copper surface roughness.
 - Substrate dielectric constant Dk .

A topology with a smaller number of manufacturing influencers is better, but Substrate Integrated Waveguide (SIW), which according to the list above has minimum number of things that affect its performances, is much affected by the via locations.

Usually the minimum tolerance for via location in PCB manufacturing is about 1mil, which at microwave frequencies needs careful attention in SIW design.

The Microstrip structure is the planar topology least affected by the PCB manufacturing process tolerances.

Transmission lines transitions (Signal Launch)

High-frequency signals must survive many transitions in an RF/microwave system, with one of the more challenging being the point at which signals are “launched” from a coaxial connector to a printed transmission line.

For example, the transition from coaxial to microstrip may be affected with mismatch issues as the following:

- The Effective-Dk of the PCB is typically different than the Dk of the coax cable.
- Signal launch for high frequency RF printed boards is the transition from one electric field orientation to another.
 - Electric fields in the coaxial domain of the connector are cylindrical, when the electric fields in the printed transmission lines are planar.
 - The signals change orientation to adapt to the new propagation medium, and anomalies can occur in the form of signal loss or reflections.
- Signal launch transition is also a wave propagation mode transition.
 - The coaxial connector is a pure TEM propagation mode.
 - A microstrip or a CPW printed line will have a quasi-TEM propagation mode.
 - Additionally, there is a change in field distribution and field line length in the signal launch area. Managing that transition without interruptions to the signals requires not only proper mechanical alignment but careful electrical optimization.
- The ground path on a printed board is a very important part of any successful signal launch from a connector to a printed transmission line, since a continuous ground return path is essential to the uninterrupted, low-loss propagation of high-frequency signals from a connector through the printed line.
- The length of the ground path can also affect the quality of a signal launch from a coaxial connector to a printed transmission line.
- Even such things as minimizing differences in conductivity between the solder used to join a coaxial connector’s metal parts (e.g. SMA) to a printed conductor metal can make an impact in improving the transition and the performance, especially at higher frequencies. These small losses and impedance mismatches are increasingly noticeable at higher frequencies.
- Modifying the inductive or capacitive nature of the transition from the coaxial connector to the PCB will result in frequency-dependent changes to the nature of the signal launch.
- The PCB’s ground-plane spacing can also play a role in these frequency-dependent changes depending on how it changes the inductive/capacitive characteristics of the PCB and the transition.

- The length of the taper used to narrow the PCB's transmission lines closer to the dimensions of the coaxial connector's conductor can also impact the frequency response of the circuit.

Microstrip Discontinuities

Real microstrip circuits have transmission lines with their share of discontinuities, such as steps or changes in width, bends, open ends, gaps, and junctions.

These discontinuities are typically an integral part of a high-frequency circuit design. For example, microstrip meander lines are slow-wave structures that are typically used to realize a shift in phase. Unfortunately, every deviation from a straight, continuous microstrip transmission line invites radiation of energy away from the metal conductor and dielectric material, effectively dissipating energy from the microstrip circuit into free space. In addition, the close proximity of conductive lines in a meander line configuration can result in the coupling of energy from adjacent lines, also causing losses.

- Surface waves are electromagnetic waves that propagate on the dielectric interface layer of the Microstrip. The propagation modes of surface waves are practically TE and TM. Due to the practical homogeneity of the Stripline dielectric, this phenomenon can be neglected in Stripline devices and so, this section is pertinent to Microstrip lines only.
- Surface waves are generated at any discontinuity of the Microstrip. Once generated, they travel and radiate, coupling with other Microstrip of the circuit, decreasing isolation between different networks and signal attenuation. Surface waves are a cause of crosstalk, coupling, and attenuation in a multi-microstrip circuit. For these reasons the surface waves are always an undesired phenomenon.
- Surface wave propagation may be reduced by cutting slots into the substrate surface just in front of an open-circuit.
- Similar to the case of radiation, surface waves are not guided by the Microstrip.
- Various techniques may be adopted to reduce radiation:
 - Metallic shielding or 'screening.
 - The introduction of a small specimen of lossy (i.e. absorbent) material near any radiative discontinuity.
 - The utilization of compact, planar inherently enclosed circuits (spurline filter).
 - Reduce the current densities flowing in the outer edges of any metal sections and concentrate currents towards the center and in the middle of the Microstrip.
 - Possibly shape the discontinuity in some way to reduce the radiative efficiency.
- The shape of a transmission-line discontinuity can influence the amount of radiation loss, with sharper edges on junctions causing higher radiation losses than rounded edges or more gradual transitions in step junctions, as the ones used for example on impedance matching in low-noise amplifiers.
- Microstrip transmission lines with excessive radiation loss can be thought of as antennas, albeit unintended ones. Even in a microstrip antenna or antenna array, unwanted radiation losses can occur at junctions and coupling points, resulting in degraded antenna efficiency, especially at higher frequencies. Microstrip radiation

losses can be controlled, but it requires careful choices in dielectric substrate, the thickness of that substrate, and the geometry of the microstrip circuitry.

- A discontinuity in a Microstrip is caused by an abrupt change in geometry of the strip conductor, and electric and magnetic field distributions are modified near the discontinuity. The altered electric field distribution gives rise to a change in capacitance, and the changed magnetic field distribution to a change in inductance.
- Discontinuities commonly encountered in the layout of practical Microstrip circuits are: Steps, Open-Ends, Bends, Gaps, and Junctions.

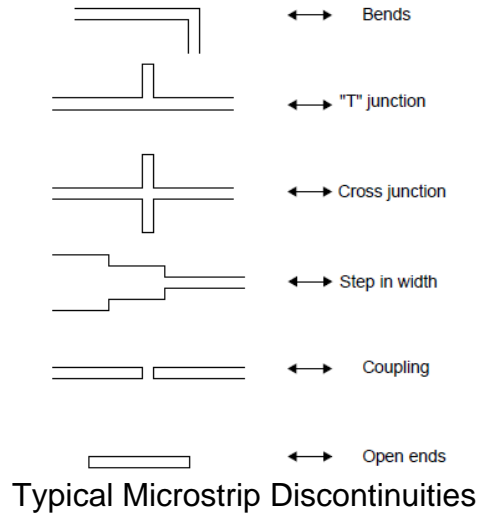

- It is possible to reduce the parasitic effects associated with Open-Ends, Steps, Bends, and Junctions by using constant impedance tapers.

a) Bends are the most frequently encountered discontinuities.

The simplest bend is the 90° bend. This bend doesn't work well above few GHz, due to a high VSWR. The same holds true for bends with angles α greater than 90°.

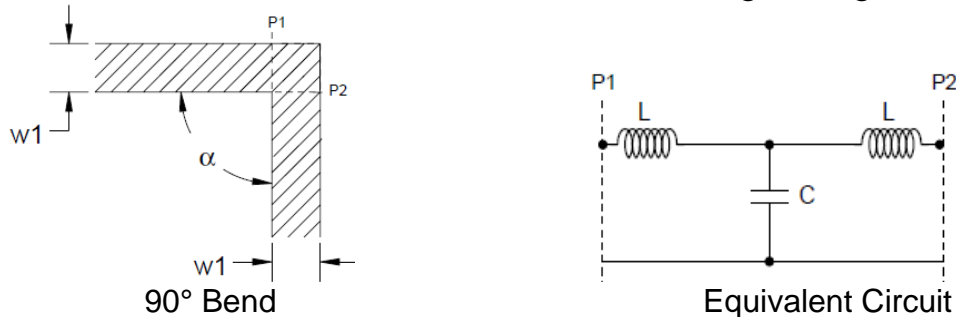

A T-network is the equivalent circuit for a short line length. However, because of the excess capacitance at a square corner the characteristic impedance value will be lower than that of the uniform connecting lines.

- The Bend Discontinuity Effect it will increase with frequency, with the number of bends used in cascade, and with the line width.

Compensation for Microstrip corner bend can use either, increased inductance or decrease capacitance techniques.



- Experiments on various bends have proven that a decrease in the input reflection coefficients can be achieved if the corner is chamfered (mitered).

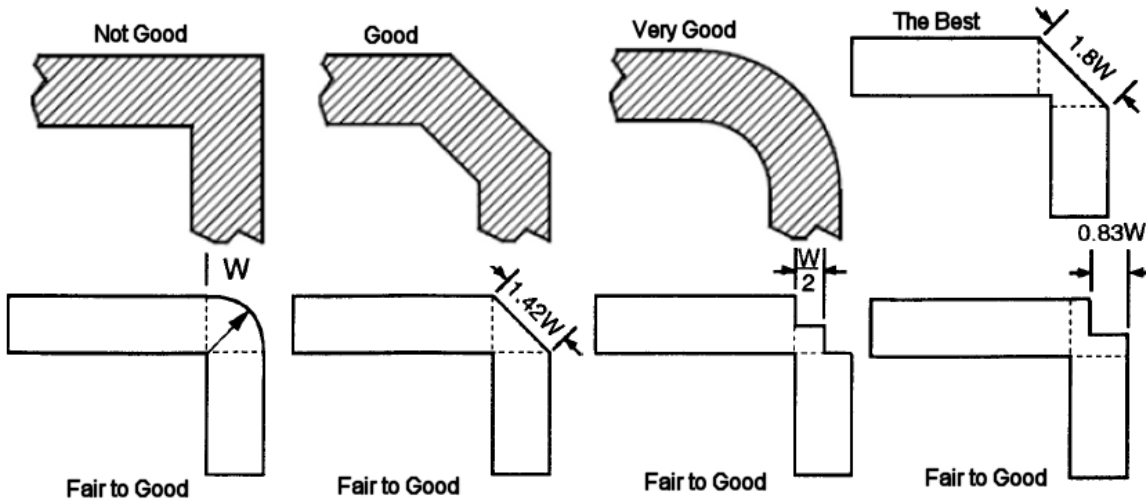

Different configurations for compensated right-angled bends – W is the width of the line

The above configurations are applicable for: $2.5 \leq \epsilon_r \leq 25$, and $W/h \geq 0.25$

- In some cases, curving a line is a better option than mitering it.

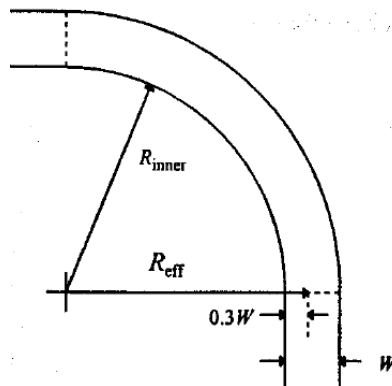

When the curving radius is larger than twice the width of the line, the main parasitic effect is a change in the effective line length. The effective length of the curve ($3 < R/W < 7$) can be estimated by assuming the effective radius to be:

$$R_{\text{eff}} = R_{\text{inner}} + 0.3W$$

Curving a line also has the advantage that the direction of the line can be changed with any arbitrary angle.

- For both, the curved and mitered bends, the electrical length is somewhat shorter than the physical path-length of the Microstrip line.

b) Open-Ends are encountered any time a Microstrip is open terminated.

Typical devices where open ends are encountered are Microstrip Filters and Matching Stubs.

- At the Open-End of a Microstrip line with a width of w , the fields do not stop abruptly, but extend slightly further because of the effect of fringing field. This effect can be modeled either with an equivalent shunt capacitance C , or with an equivalent length of transmission line Δl .

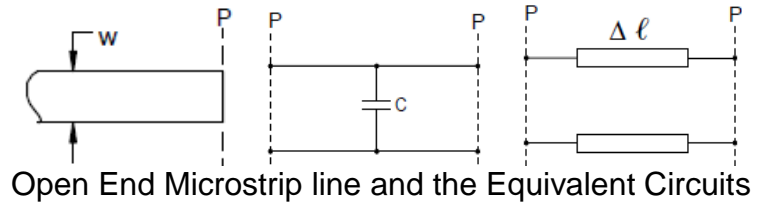
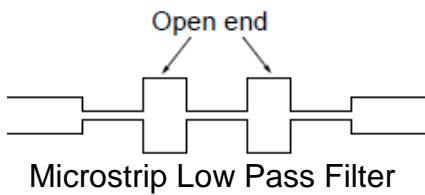

- The simplest way to compensate for the increase in line length is to reduce the length of the designed line by the correct amount.
- A distance of at least the equivalent line length should be allowed between the end of an open-ended stub and the substrate edge.
- For thicker substrates and for wider Microstrip lines, radiation from an Open-End discontinuity becomes significant.

c) Gap Coupling is a type of discontinuity is can be found in Microstrip Filters and in DC blocks.

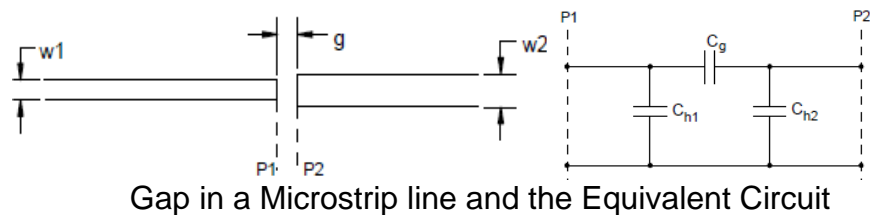
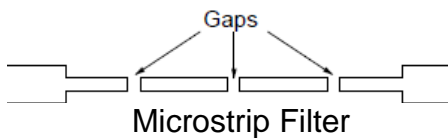

- A Gap in a Microstrip line can be equivalently represented as a π capacitor circuit. This circuit between the two reference planes **P1** and **P2** at each end of the gap consists of a series coupling capacitance C_g , and two parallel fringing capacitances C_{h1} and C_{h2} between the conductor open ends and the ground.
- For narrow gaps, C_{h1} and C_{h2} approaches zero and C_g increases. Practical series capacitance values are approximately 0.01pF to 0.5pF.
- For a very large gap, the capacitance values C_g approach zero and this discontinuity becomes equivalent to an open-end circuit.

d) Step Width Junction discontinuity can be found in many devices: Matching Networks, $\lambda/4$ Transformers, multistep $\lambda/4$ Directional Couplers, Dividers/Combiners, and Microstrip Filters.

- The parasitic effect of a Step Junction is similar to that of an Open-End.
- The effect of the fringing capacitance associated with the wider line of the step discontinuity is similar to an increase in the length of that line.

- The phase shift associated with a step discontinuity will always be less than that caused by an Open-End in a line with the lower characteristic impedance

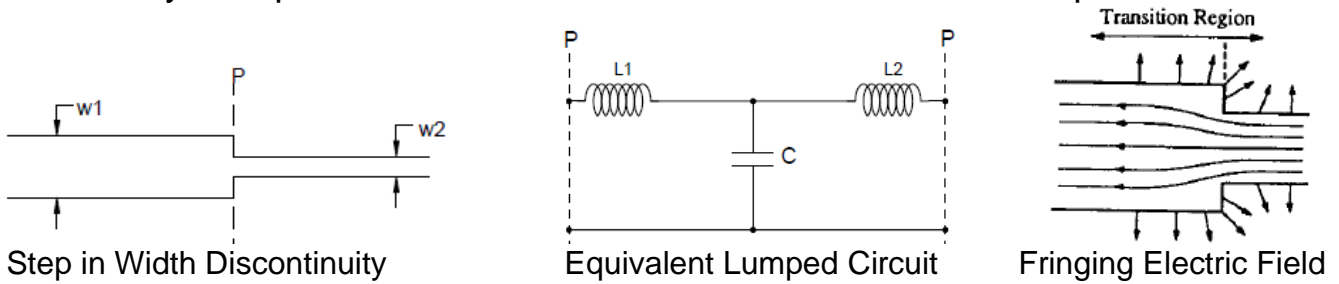

- In terms of distributed elements, the discontinuity capacitance **C** has the effect of an increase in length of the wide line **w1**, and an equal decrease in length of the narrow line **w2**.
- To compensate for the excess capacitance, can make the wider line **w1** to be electrically longer by a length Δl .
- Also, there is a tapering technique (figure below) applied to reduce the discontinuity effects associated with a step width junction.

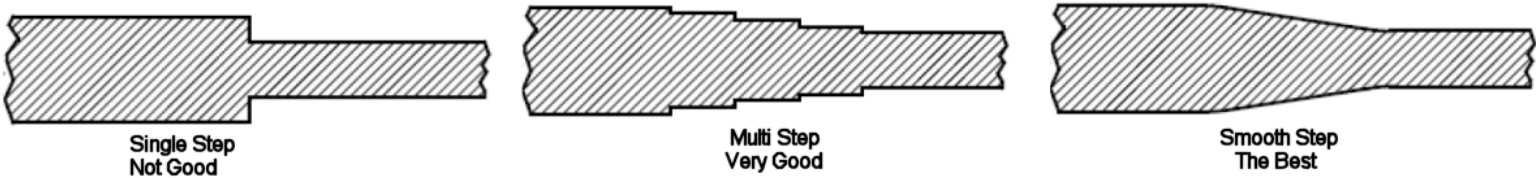

Configurations for step width Tapering from lower to higher impedance lines

- e) **T-Junction** discontinuity is perhaps the most important discontinuity as it is found in circuits as Impedance Matching Networks, Stub Filters, and Directional Couplers as “Branch-Line” and “Rat-Race”.

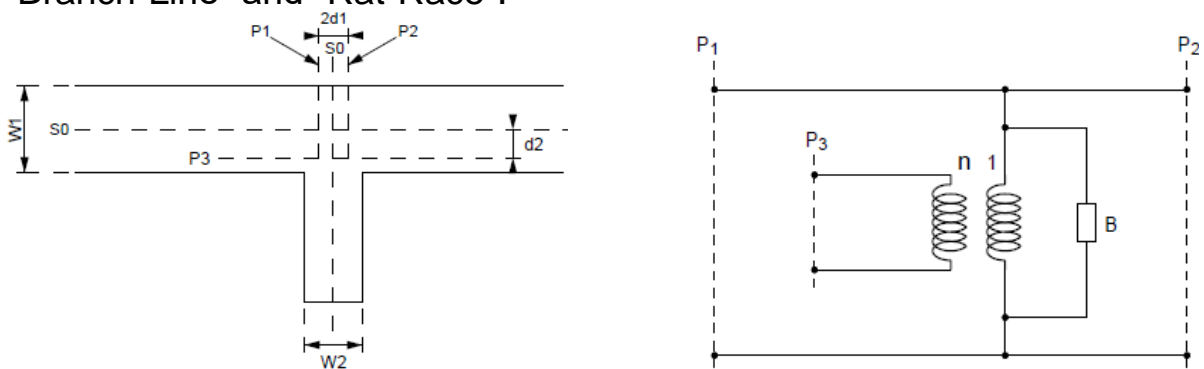

T-Junction discontinuity and the Equivalent Circuit

- T-Junctions can be compensated easily for the reference plane offsets by simply adjusting the lengths of the different lines. The offset in the main line is usually very small, and the main effect is on the length of the stub.

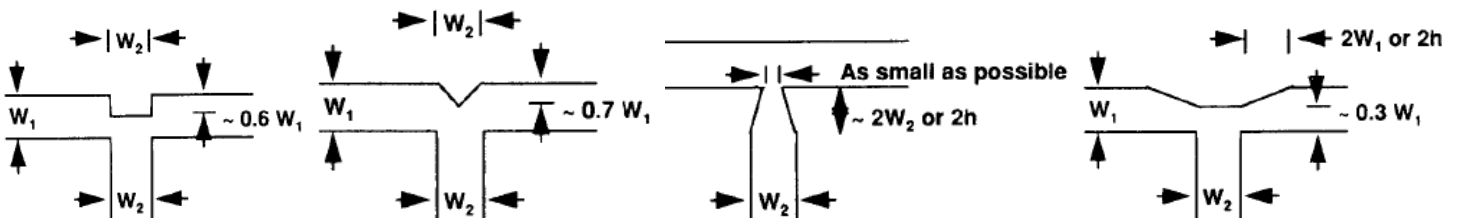

Types of T-Junction discontinuity compensation and minimization of the effect

- The best solution to the transformer effect is to keep the width of the stub (W_2) narrow enough for the transforming effect to be negligible.
- f) **Cross-Junction** discontinuity is mainly found in Matching Networks and Microstrip Notch Filters.
- As a first order approximation a cross can be considered to be two T-Junctions in parallel.

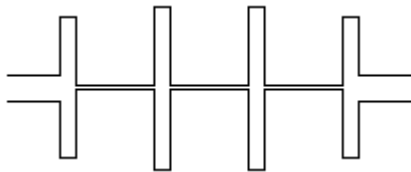

Microstrip Notch Filter using Cross-Junctions

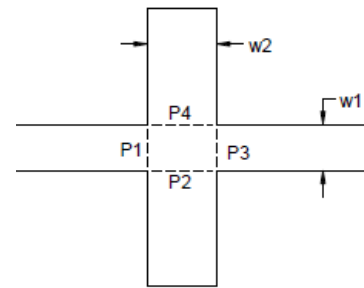

Cross-Junction discontinuity

- One of the most common of Cross-Junction is for the realization of low impedance stubs. When impedance stub has a strip width large enough to sustain transverse resonance modes, one of the possible solutions is to employ two stubs in parallel, connected on either side of the main line. The impedance of each of the equivalent stubs is equal to twice the impedance of the simulated stub.

Lumped Microstrip Components

Lumped components have the advantage of small size, low cost, and wide-band characteristics, but have lower Q and lower power handling than distributed elements.

- To function well as a lumped element at microwave frequencies, the length of the equivalent inductor and capacitor elements should not be longer than 12% (30°) of a wavelength λ , or they will begin to lose their lumped equivalency effect. Some authors recommend the length should be less than $\lambda/20$.
- Lumped inductors and capacitors circuits will only function for that particular dielectric constant, board thickness, and frequency used in the original equivalency calculations.
- Due to Microstrip's electromagnetic field leakage, when shielding Microstrip lumped equivalent capacitors and inductors (as well any Microstrip's transmission lines), the RF shield should be kept at least five substrate thicknesses above the copper, or a disruption within the field, with resulting impedance variations, can occur.

a) Microstrip Inductors

- The inductance value of a Microstrip inductor is determined from the total length, the number of turns, spacing, and line width.
- Narrow tracks are more inductive but carry less current, so there is a trade-off between them.
- Spiral track inductors have more inductance because the magnetic fields from each turn of the spiral add up, creating a larger field through the middle of the spiral and mutual inductance between all the turns.

Types of Microstrip Inductors

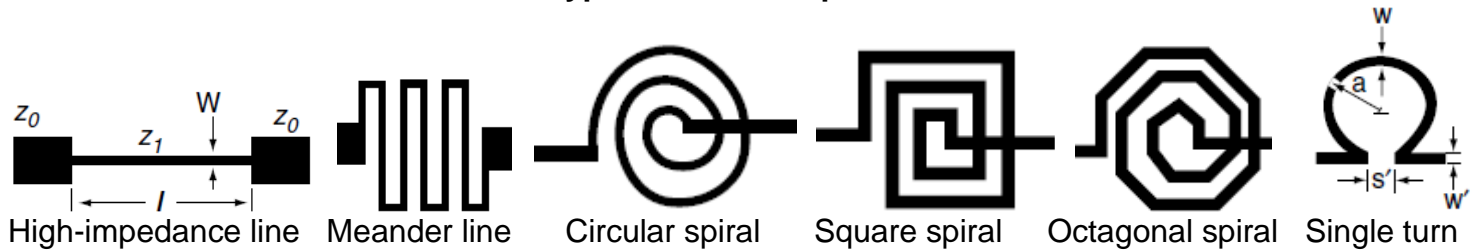

- The high-impedance, **Straight-line** section is the simplest form of an inductor, used for low inductance values (typically up to 3 nH), while the spiral inductor (circular or rectangular) can provide higher inductance values, typically up to 10 nH.
- The inductance of an isolated (no ground plane), flat, ribbon inductor (or Strip Inductor) is given approximately by:

$$L \text{ (nH / mm)} = 0.2 \{ \ln[l / (w + t)] + 1.193 + 0.2235(w + t) / l \}$$

where w is the width of the ribbon, t is the metal thickness, and l is length.

- The inductance of a strip inductor is decreased by the presence of a ground plane. The effective inductance of a strip inductor using a ground plane is:

$$L_{\text{eff}} = [0.570 - 0.145 \ln(W / h)] \cdot L$$

where h is the substrate height.

- The **Meander-line Inductor** is used to reduce the area occupied by the element.
- In the meander inductor, adjacent conductors have equal and opposite current flows, which reduce the total inductance.
- Mutual coupling effects are usually small if the spacing is greater than three strip widths. The strip width is much smaller than the substrate thickness.
- Meander-line inductors have the advantage of lower eddy current resistance, but they have lower inductance and lower SRF (self-resonant frequency) than spiral inductors.

Many different types of **Spiral Inductors** are used in Microstrip development, such as circular (or square) air bridge cross inductor, octagonal spirals, single-turn spiral, etc.

- These are some of the **Characteristics and Requirements for Microstrip Spiral Inductors**:
 - The resistance of spiral inductors depends on frequency because of the skin effect.
 - The Q-factor of an inductor depends directly on the inductance.
 - The two most important geometric parameters affecting Q are the conductor width-to-spacing ratio and the inductor outside diameter.
 - The Q-factor increases with an increase in the outside diameter.
 - For minimum losses, the outer diameter of a spiral inductor should be approximately five times the inner diameter. This ratio of diameters optimizes the Q value, but not the maximum inductance value.
 - The Q-factor increases as the square root of the frequency due to the skin effect
 - The effect of Eddy Currents can be minimized by making the line widths of the inner turns of the inductor narrower than the outer turns. In this structure the improvement in Q-value is more pronounced at higher than lower frequencies, because the effect of Eddy Currents is more severe at high frequencies.
 - The Q-enhancement of planar spiral inductors can also be achieved by using the differential excitation technique. The Q-factor of such inductors is enhanced because of smaller substrate loss and is maintained over a broader bandwidth compared to the single-ended configuration.
 - The Q of an inductor can be further enhanced by reducing the conductor resistance using thick copper metal.
 - Circular spiral inductors have higher Q than rectangular inductors; however, they also have lower inductance for an equivalent area.
 - Parasitic capacitances will cause a spiral inductor to get a self-resonance SRF.
 - The most basic parasitic capacitance is that which is created by the coupling between the turns of the inductor. When a ground plane is under the spiral inductor, we have additional parasitic capacitance between spiral and ground.
 - Introducing a large air gap between the substrate and spiral coils reduce the effect of the substrate on SRF and Q-factor, and also will reduce the winding capacitance by spatially separating the spiral coils from the central return lead. This separation is obtained by the air (not by the dielectric material) and the parasitic capacitance can be minimized.
 - The self-resonant frequency SRF must be at least twice the maximum operating frequency for the inductance to have a constant value.
 - To realize high-quality inductors, thicker metal with higher conductivity (e.g., copper and gold) can be used to overcome the series resistive loss.
 - The spiral inductor should have the widest possible line, while keeping the overall diameter small. This implies that the separation between the turns should be as small as possible.

- The ideal case of the inductor is in free space with no ground plane. Have to take into account the effect of the ground plane, which tends to decrease the inductance value as the ground plane is brought nearer.
- The inductance of one single-turn of spiral inductor is less (because of the proximity effect) than the inductance of a straight line with the same length and width.

b) Microstrip Capacitors

- Capacitors are lumped circuit elements that store energy by virtue of electric fields.

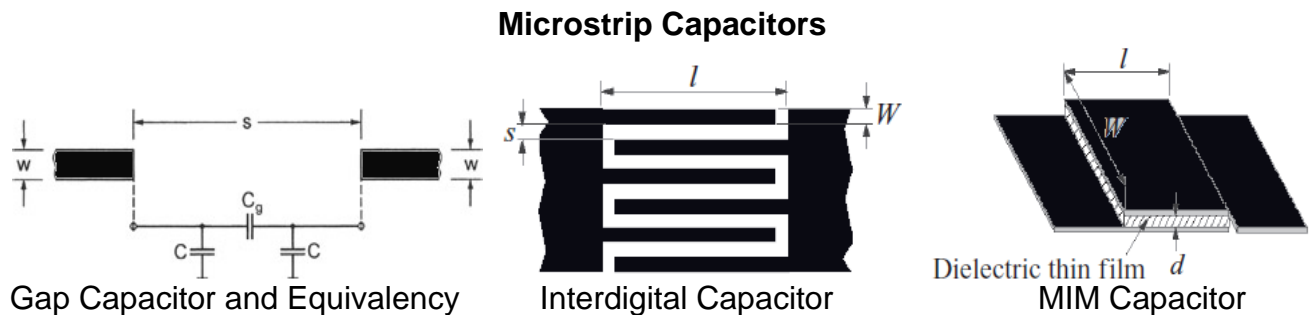

- The **Gap Capacitor** can be described as two coupled open-ended Microstrip lines. The capacitance **C** refers to the open-end capacitance and the series gap capacitance **C_g** describes the electrical coupling. Up to approximately 20 GHz, the frequency dependence of the equivalent capacitances is negligible. The series gap interrupts the conductive strip of the Microstrip line, and the DC power cannot be transmitted. RF power transfer is accomplished by electrical field coupling. A Gap Capacitor can provide a series capacitance of 0.05pF to 0.5pF.
- The **Interdigital Capacitor** relies on the strip-to-strip capacitance of parallel conducting fingers on a substrate and it's suitable for applications where low values of capacitance (less than 1pF) are required.
- The finger width **W** must equal the space **s** to achieve maximum capacitance density, and the substrate thickness **h** should be much larger than the finger width.
- The Interdigital Capacitor relies on the fringing capacitance between the long common edge areas of the metal fingers which are separated by very small spacing depending on the minimum gap allowed by the foundry. The fringing capacitance is fairly low, and as was stated, the capacitors are able to reach small capacitance values, up to 1pF.
- The Interdigital Capacitor size can be reduced by reducing the dimensions of the structure or by using a high dielectric constant value substrate. Increasing the dielectric constant of the medium a hundred-fold will reduce the component dimensions by a factor of 10.
- The Q-factor of Interdigital Capacitors can be enhanced by using high-conductivity conductors and low-loss tangent dielectric materials. Other Q enhancement techniques include suspended substrate, multilayer structure, and micromachining.

- By selecting the proper substrate thickness and air spacing between the substrate and ground plane, one can reduce the capacitor loss by a factor of 25% to 50%.
- The micromachining approach reduces the parasitic capacitance by a factor of ϵ_r and results in better millimeter-wave circuits.
- The parasitics associated with Interdigital Capacitors can be ignored as long as the Capacitance x Frequency product is smaller than 2×10^{-3} .
- Fundamental **Parallel-Plate Capacitors** consisting of a pair of parallel planar metallic surfaces separated by a dielectric are available in chip forms as discrete components.
- The **Metal-Insulator-Metal (MIM) Capacitor**, constructed by using a thin layer of a low-loss dielectric (typically 0.5- μm thick) between two metal plates, is used to achieve higher values, for example, as tens of pF in small areas.

The metal plates should be thicker than three skin depths to minimize conductor losses.
The top plate is generally connected to other circuitry by using an air bridge that provides higher breakdown voltages.

The MIM capacitance is given by the classical expression from electrostatics:

$$C = \frac{0.0885 \epsilon W l}{h} \text{ (pF)}$$

where ϵ is the dielectric constant, W , l , and h are dimensions in centimeters.

- When the MIM capacitor value is small, on the order of, say, 0.2 pF, the measured value of capacitance is always larger than the design value based on capacitance per unit area. This is due to the fact that the dielectric thickness along the periphery is thinner than at other places and this effect is more pronounced for smaller capacitor areas.

c) Quasi-Lumped Microstrip Elements

- Microstrip line short sections and stubs, whose physical lengths are smaller than $\lambda_g/4$ (quarter of guided wavelength) at which they operate, are the most common components for approximate microwave realization of lumped elements in Microstrip filter structures, and are termed Quasi-Lumped elements. They may also be regarded as lumped elements if their dimensions are even smaller, say smaller than $\lambda_g/8$.
- A stub is a length of a straight transmission line that is short or open-circuited at one end and connected to the circuit at the opposite end.
- High- and Low-Impedance Short-Line Sections

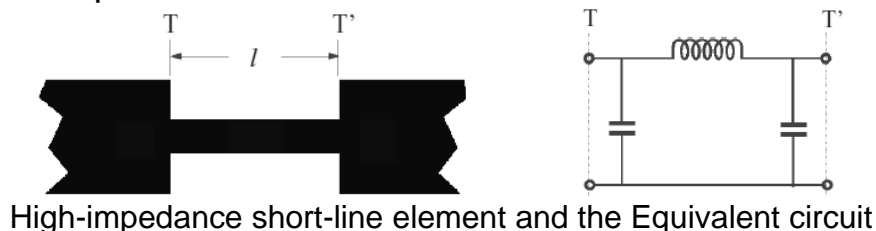

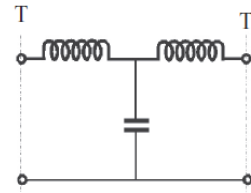
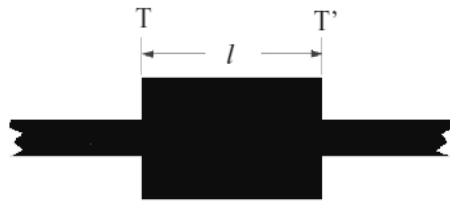

Low-impedance short-line element and the Equivalent circuit

- Open and Short-Circuited Stubs

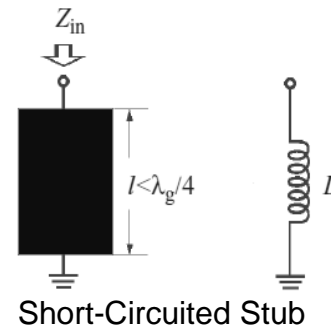
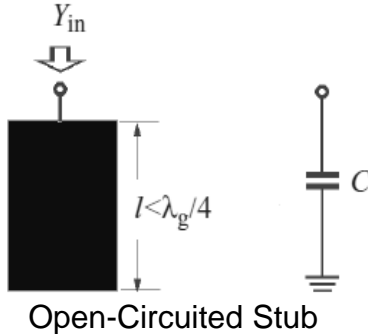

The $\lambda_g/4$ stub can be used for many purposes, bypassing or notching certain frequencies.

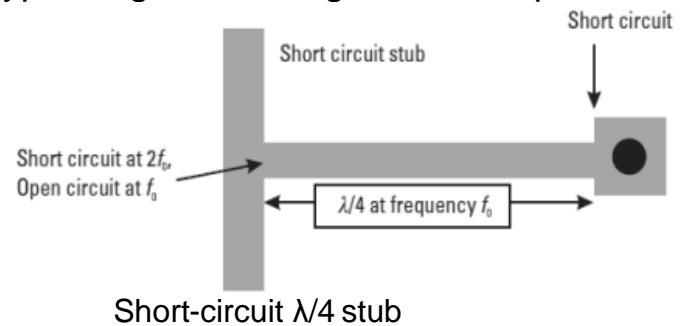
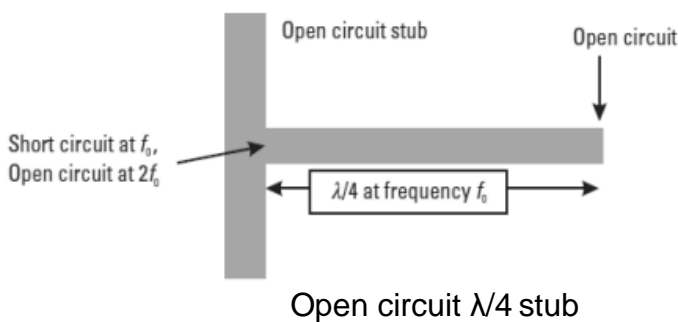

- A $\lambda_g/4$ stub if it is left with an **open-end** it can be used as a Notch Filter to attenuate certain frequencies. The bandwidth of a $\lambda_g/4$ Microstrip notch filter is about 20 %. The $\lambda_g/4$ notch filter will not only attenuate the design frequency but it will also attenuate the frequency band around the odd harmonics of the design frequency.
- $\lambda_g/4$ Microstrip stubs can be used for designing **Bias Networks** to supply DC to microwave diodes, transistors, or RFICs. A bias injection network is one that is designed to combine both, microwave and low frequency ports. There should be no low frequency path to the microwave input branch, but the DC input port must also appear as a microwave open circuit at the junction to the through transmission line. A $\lambda_g/4$ shunt line stub with a **short-circuit termination** may be either a true short circuit for a DC ground return or in the form of a capacitive feed-through element. Important is the bandwidth performance of the circuit.
- Higher impedance stubs (with high ratio Z_{stub}/Z_0) have broader band response.

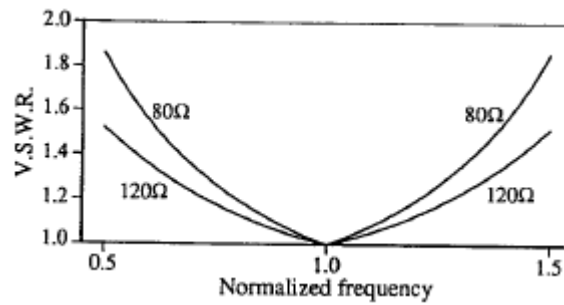

Frequency response of two different impedance stubs

- An improved DC injection network can be made decreasing the impedance Z_0 at the stub junction (lower the impedance, thicker the line).

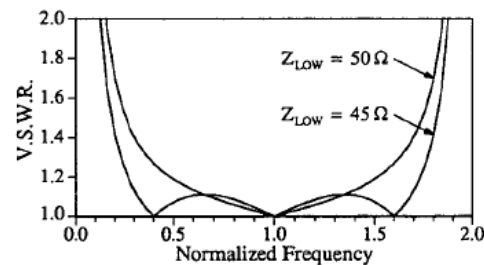
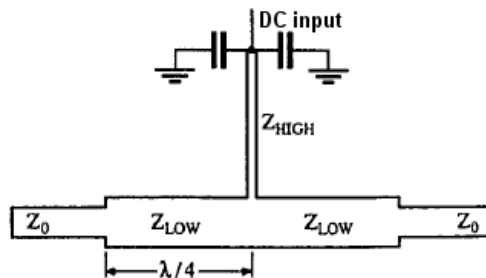

- Radial Stubs

Radial stub is an open-circuit stub realized in radial transmission line instead of straight transmission line.

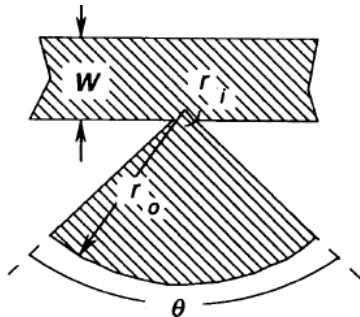

Radial Stub Elements

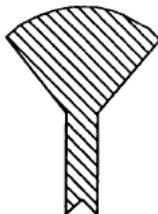

Series Radial Stub



Shunt Radial Stub

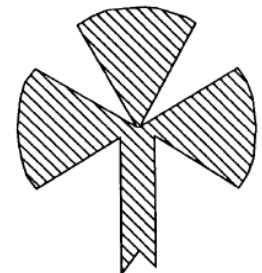

Three 60° Radial Stub

- Radial stub it is a useful element, primarily for providing a clean (no spurious resonances) broadband short circuit, much broader than a simple open-circuit stub. It is special useful on bias lines at high-frequencies.
- Radial stubs are shorter than uniform stubs, they cannot be folded or bent; therefore, they take up a lot of substrate area.
- There is no simple equation to describe the radial stub adequately, and practical experiments work better than any formula.
- In the radial shunt configuration (butterfly radial stub), the added symmetry of multiple stubs may improve the bandwidth, as well in the three 60° radial stubs case presented in the figure above.

Microstrip Resonators

- A **Microstrip Resonator** is any structure that is able to contain at least one oscillating electromagnetic field.

Microstrip Resonators may be classified as lumped-element or quasi-lumped-element resonators, and distributed-line resonators or patch resonators.

- **Lumped-Element or Quasi-Lumped-Element Resonators**, formed by the lumped or quasi-lumped inductors and capacitors will resonate at $\omega_0 = 1/\sqrt{LC}$. They may resonate at some higher frequencies, at which their sizes are no longer much smaller than a wavelength, and by definition, are no longer lumped or quasi-lumped elements.



Lumped-Element Resonator



Quasi-Lumped-Element Resonator

- The **Distributed-Line Resonators** may be termed as the quarter-wavelength resonators, since they are $\lambda_{g0}/4$ long, where λ_{g0} is the guided wavelength at the fundamental resonant frequency f_0 . They can also resonate at other higher frequencies.

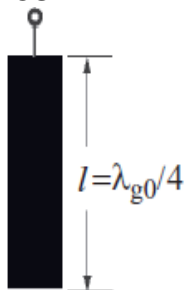

$\lambda_{g0}/4$ Line Resonator (shunt-series resonance)

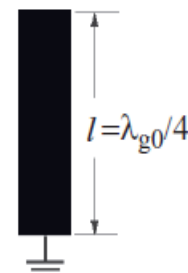

$\lambda_{g0}/4$ Line Resonator (shunt-parallel resonance)

- A $\lambda_{g0}/4$ short-circuited stub operates as a parallel LC, and the open-circuit stub as a series LC resonator.
- Another typical Distributed-Line resonator is the **Half-Wavelength Resonator**, used in Microstrip filters implementation. This resonator is $\lambda_{g0}/2$ long at its fundamental resonant frequency, and can also resonate at: $f \approx nf_0$ for $n = 2, 3, \dots$

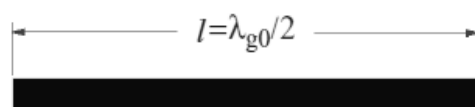

Half-Wavelength Resonator

- The main difficulty with the use of Distributed-Line resonator is caused by the end effects.
- While Microstrip conductor and dielectric dissipation may be expressed as loss per unit length, radiation losses may only be related to specific lengths of line.
- The quality factors Q of $\lambda_{g0} / 2$ resonators, which include radiation losses, provide a guide to the losses that occur in Microstrip.
- Some slight increase in the quality factor is obtained by using lower ϵ_r substrates, $\tan \delta$ being equal, with resultant larger guide wavelengths, which may be advantageous at higher frequencies.

- The **Ring Resonator** is another type of Distributed-Line resonator, where r is the median radius of the ring.

The ring will resonate at its fundamental frequency f_0 when its median circumference is: $2\pi r \approx \lambda_{g0}$.

The higher resonant modes occur at: $f \approx n \cdot f_0$ for $n=2, 3, \dots$

- The Microstrip Ring Resonator is a simple transmission line in which resonator is excited at certain frequencies. Depending on the electrical length of the resonance a standing wave pattern forms around the circular path of the resonator.
- The maximum voltage of the standing wave occurs at the exciting point.
- The resonant frequencies correspond to a condition where the parameter of the ring is an integer multiple of the guided wavelength.



Ring Resonator

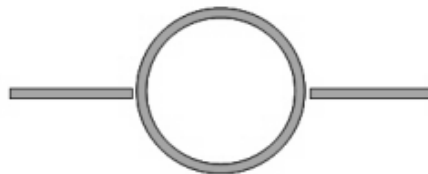

End-Coupling



Edge-Coupling

- The coupling gap is an important part of the ring resonator. It is the separation of the feed lines from the ring that allows the structure to only support selective frequencies.
- The size of the coupling gap also affects the performance of the resonator.
- If a very small gap is used, the losses will be lower but the fields in the resonant structure will also be greatly affected.
- A larger gap results in less field perturbation but greater losses.
- It is intuitive that the larger the percentage of the ring circumference the coupling region occupies, the greater the effect on the ring's performance.



Ring Resonators Enhanced Coupling Techniques

- At resonant frequencies there exists a voltage maximum at $\pi d/2$ away from the excitation point. By placing a transmission line at this voltage maximum point, the field in the resonator can be probed to detect the resonance frequencies.
- The dissipated power in the Ring Resonator includes the dielectric loss, the conductor loss, and the radiation loss.
- The End-Coupling structure provides a band-pass whenever the ring is a multiple of wavelengths, when the Edge-Coupling technique can be seen on the reflection coefficient (S11) of the coupled transmission line whenever the ring is an integer number of wavelengths. The circuit in this case behaves like a band-reject filter, sometimes called a spur line filter.
- The influence of curvature in Ring Resonators becomes large if substrate materials with small relative permittivity and lines with small impedances are used.
- Under these conditions the widths of the lines become large and a mean radius is not well-defined. If small rings are used, then the effects become even more dramatic because of the increased curvature.
- The Microstrip Ring Resonator has found applications in determining optimum substrate thickness, discontinuity parameters, effective dielectric constant and dispersion, and loss and Q-measurements.
- When the idea of a Microstrip Ring Resonator was introduced for the first time, also were described techniques used to measure the phase velocity and dispersive characteristics of a Microstrip line by observing the resonant frequency of the ring resonator.

Material Characterization

Material characterization techniques are mainly classified in two categories:

- **Resonant Methods**
- **Non-Resonant Methods**

• Resonant Methods

- Material characterization is done based on the **change in resonance frequency**.
- Material characterization is done based on the **structure of the fixture**.
 - First step – resonant frequency is measured with the empty fixture/resonator.
 - Second step – material under test MUT is placed in the fixture.
 - Change in the resonant frequency with and without sample inserted in the fixture is measured, and material measurements are made with the help of various well-known algorithms.
 - Based on the size/shape/thickness/physical properties of the MUT, the fixture could be different:
 - Open resonator method

- Strip line
 - Circular disk
 - Open coaxial
 - Cavity resonator
 - Dielectric resonator
 - Fabry Perot
- Non-Resonant Methods
 - Material characterization based on the **reflection** or **reflection and transmission** changes.
 - Also called S-parameter measurement methods.
 - Open Coaxial Probe Method.
 - Based on reflections from open end of the coaxial probe.
 - Some conditions should always meet by the MUT like: isotropy, homogeneity, thickness, etc.
 - Suitable for liquids, solids, thin films, gels, etc.
 - Waveguide Measurements Method
 - Placing the material under test MUT between two waveguides.
 - Corrugated waveguide measurement method.
 - Free Space Material Measurement
 - Based on reflection or **reflection and transmission measurements**.
 - Material is placed in between two Lens Antennas with focused beams.

Determination of the Dielectric Constant (D_k) using Microstrip Ring resonators:

- The Microstrip Ring resonator is designed to the certain main resonance frequency and the design is based on an estimated value of dielectric constant.
- Measured values of the main resonance frequency and the harmonic resonance frequencies will differ from designed ones, if difference between the estimated dielectric constant and the actual dielectric constant is appeared.
- Based on the difference of the estimated and the actual dielectric constant, frequency dependent value for dielectric constant D_k (or ϵ_r) can be calculated at each resonance frequency.

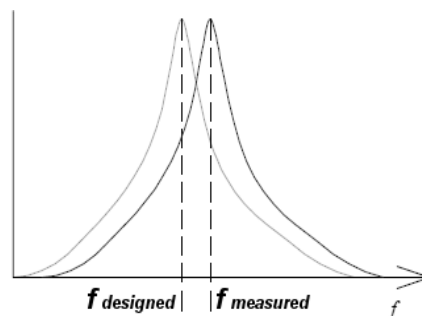

- The main advantage using Microstrip Ring resonators for dielectric and dispersion measurements is that, in contrast to Distributed-Line resonators, no end effects need to be considered.
- The coupling gap capacitance changes with frequency, causing the resonant frequency to shift and resulting in errors when extracting the material Dk.
- The conductor width of the resonator ring should be much smaller than the radius of the ring - as a rule of thumb, one-quarter the dimension of the ring radius or smaller.
- Simple ring resonator equations for finding **Dielectric Constant (Dk)** are:

$$2*\pi*r = n*\lambda_g$$

$$\lambda_g = c/Dk_{eff}$$

$$f_o = (n*c)/[(2*\pi*r*SQRT(Dk_{eff}))]$$

$$Dk_{eff} = [(c*n)/(2*\pi*r*f_o)]^2$$

where: λ_g is the guided wavelength, r is the ring radius, n is the mode number, f_o is the resonant frequency, c is the speed of light, and Dk_{eff} is the static effective relative dielectric constant.

- **Patch Resonators** are of interest for the design of Microstrip Filters, in order to increase the power-handling capability, and also due to their lower conductor losses as compared with narrow Microstrip line resonators.
- Because Patch resonators tend to have a stronger radiation, they are normally enclosed in a metal housing for filter applications so that the radiation loss can be minimized.
- Depending on the applications, patches may take different shapes, such as Circular or Triangular.

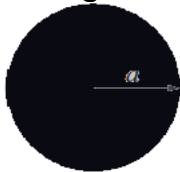

Circular Patch Resonator



Triangular Patch Resonator

Challenges in Making Material Measurements

- Choosing the right method, fixtures, and measurement accuracy for material characterization it is a challenge.
- Every material type is different and hence the material measurement method is also different. Thickness, size, type, isotropy, homogeneity, all play a vital role in determining which method will give the most accurate results.
- Temperature and humidity variations affect the Dielectric constant and represent a challenge for accurate material characterization.
- Estimated Dielectric constant **Dk** and Dissipation factor **Df** values are always a starting point for making measurements.
- Repeatability in measurements is one of the biggest challenges - especially for certain types of materials like thin films (how much pressure, focus area, VNA stability, calibration algorithms).

References:

1. *History of Wireless* – T.Sarkar, R.Mailloux, A.Oliner, M.Salazar-Palma, D.Sengupta
2. *Microstrip Filters for RF-Microwave Applications* – Jia-Sheng Hong
3. *Essentials of RF and Microwave Grounding* – E.Holzman
4. *Networks and Devices using Planar Transmission Lines* – Franco Di Paolo
5. *Passive RF and Microwave Integrated Circuits* – L.G.Maloratsky
6. *Microwave Engineering* – D. Pozar
7. *Practical RF Circuit Design for Modern Wireless Systems, - Passive Circuits and Systems* – L.Besser, R.Gilmore
8. *Analysis Methods for RF, Microwave, and Millimeter - Wave Planar Transmission Line Structures-* C.Nguyen
9. *Complete Wireless Design* - C. Sayre
10. *Coplanar Waveguide Circuits, Components, and Systems* - R.Sim
11. *Design of RF and Microwave Amplifiers and Oscillators* – P.Abrie
12. *Determination of the Dielectric Constant* – J.M.Heinola
13. *Foundations of Interconnect and Microstrip Design* – T.C.Edwards, M.B.Steel
14. *High Frequency and Microwave Engineering* - E. da Silva
15. *Maximum Q-Factor of Microstrip Resonators* – A.Gopinath
16. *Microstrip and Stripline Design – Analog Devices*
17. *Microstrip Lines and Slotlines* – K.Gupta, R.Garg, I.Bahl, P.Bhartia
18. *Microstrip Lines* – I.D.Robertson
19. *Microwave Electronics* – L.F.Chen, C.K.Ong, C.P.Neo
20. *Microwave Engineering using Microstrip Circuits* – E.H.Fooks, R.A.Zakarevicius
21. *Microwave Ring Circuits and Related Structures* – K.Chang, L.H.Hsieh
22. *Microwaves Made Simple - The Workbook* – W.S.Cheung, S.Algeri, L.Stark
23. *Modern Microwave Circuits* – N.Kinayman, M.I.Aksun
24. *Planar Circuit Analysis of Microstrip Radial Stubs* – F.Giannini, R.Sorrento, J.Vrba
25. *Planar Microwave Engineering* – T.Lee
26. *Reviewing the basics of Microstrip Lines* – L.G.Maloratsky
27. *RF and Microwave Circuit and Component Design for Wireless Systems* – K.Chang, I.Bahl, VNair
28. *RF and Microwave Coupled-Line Circuits* – R.Mongia, I.Bahl, P.Bhartia
29. *RF and Microwave Wireless Systems* – K.Chang
30. *RF Circuits Design - Theory and Applications* – R.Ludwig, P.Bretchko
31. *Skin Effect* – D.Brooks
32. *The RF and Microwave Circuit Design Cookbook* – S.Maas
33. *Transmission Line Design Handbook* – B.Wadel
34. *Microstrip Lines for Microwave Integrated Circuits* - M.Schneider
35. *Microwave Engineering using Microstrip Circuits* – E.Fooks, R.Zakarevicius
36. *Lumped Elements for RF and Microwave Circuits* – I.Bahl
37. *Microwaves and Wireless Simplified* - T.S. Laverghetta
38. *Understanding Substrate Integrated Waveguide (SIW) Circuit Structures at Millimeter-Wave Frequencies* - John Coonrod – Rogers Corporation
39. *Effectively Launch Signals onto PCBs* – John Coonrod – Rogers Corporation
40. *Low Loss and High-Power Substrate Integrated Waveguide for High Speed Circuits* - G.Soundarya, N.Gunavathi,
41. *Material Measurements with VNAs* - Anritsu
42. *Microwave Journal Magazine* – 1996 – 2020
43. *Microwaves & RF Magazine* – 2002 – 2020
44. *High Frequency Electronics Magazine* – 2002 – 2020