



OM-227 796C

2011-06

Processes



MIG (GMAW) Welding



Flux Cored (FCAW) Welding

Description



Semi-Automatic, Air-Cooled
MIG (GMAW) Welding Gun

MIGmaticTM M-25

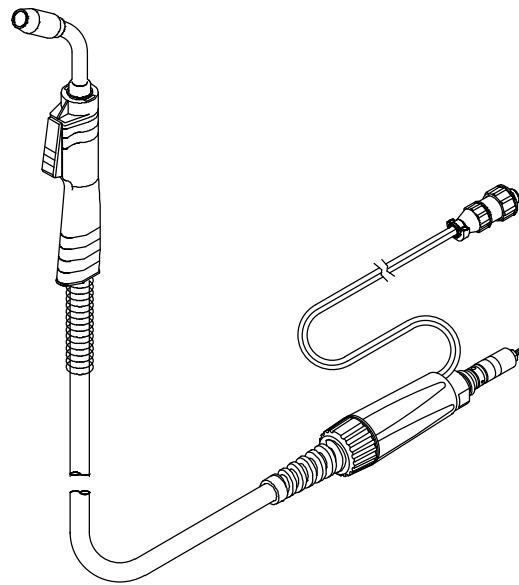

Visit our website at
www.MillerWelds.com

OWNER'S MANUAL

File: MIG (GMAW)



From Miller to You

Thank you and congratulations on choosing Miller. Now you can get the job done and get it done right. We know you don't have time to do it any other way.

That's why when Niels Miller first started building arc welders in 1929, he made sure his products offered long-lasting value and superior quality. Like you, his customers couldn't afford anything less. Miller products had to be more than the best they could be. They had to be the best you could buy.

Today, the people that build and sell Miller products continue the tradition. They're just as committed to providing equipment and service that meets the high standards of quality and value established in 1929.

This Owner's Manual is designed to help you get the most out of your Miller products. Please take time to read the Safety precautions. They will help you protect yourself against potential hazards on the worksite.

We've made installation and operation quick and easy. With Miller you can count on years of reliable service with proper maintenance. And if for some reason the unit needs repair, there's a Troubleshooting section that will help you figure out what the problem is. The parts list will then help you to decide the exact part you may need to fix the problem. Warranty and service information for your particular model are also provided.



Miller is the first welding equipment manufacturer in the U.S.A. to be registered to the ISO 9001 Quality System Standard.

Miller Electric manufactures a full line of welders and welding related equipment. For information on other quality Miller products, contact your local Miller distributor to receive the latest full line catalog or individual specification sheets. **To locate your nearest distributor or service agency call 1-800-4-A-Miller, or visit us at www.MillerWelds.com on the web.**



Working as hard as you do – every power source from Miller is backed by the most hassle-free warranty in the business.



TABLE OF CONTENTS

SECTION 1 – SAFETY PRECAUTIONS FOR GMAW WELDING GUNS – READ BEFORE USING	1
1-1. Symbol Usage	1
1-2. Arc Welding Hazards	1
1-3. Proposition 65 Warnings	2
1-4. EMF Information	2
SECTION 2 – INSTALLATION	3
2-1. Specifications	3
2-2. Duty Cycle And Overheating	3
2-3. Installing Gun	4
SECTION 3 – OPERATION	4
3-1. Operating The Gun	4
SECTION 4 – MAINTENANCE & TROUBLESHOOTING	5
4-1. Removing Nozzle, Contact Tip, And Adapter, Changing Liner, And Cleaning Gun Casing	5
4-2. Replacing Switch And/Or Head Tube	6
4-3. Routine Maintenance	7
4-4. Troubleshooting	7
SECTION 5 – PARTS LIST	8
WARRANTY	

SECTION 1 –SAFETY PRECAUTIONS FOR GMAW WELDING GUNS – READ BEFORE USING

SR7 (MIG) 2010-03

 Protect yourself and others from injury — read and follow these precautions.

1-1. Symbol Usage

 **DANGER!** – Indicates a hazardous situation which, if not avoided, will result in death or serious injury. The possible hazards are shown in the adjoining symbols or explained in the text.

 Indicates a hazardous situation which, if not avoided, could result in death or serious injury. The possible hazards are shown in the adjoining symbols or explained in the text.

NOTICE – Indicates statements not related to personal injury.

1-2. Arc Welding Hazards

 The symbols shown below are used throughout this manual to call attention to and identify possible hazards. When you see the symbol, watch out, and follow the related instructions to avoid the hazard. The safety information given below is only a summary of the more complete safety information found in the welding power source Owner's Manual. Read and follow all Safety Standards.

 Only qualified persons should install, operate, maintain, and repair this unit.

 During operation, keep everybody, especially children, away.



ELECTRIC SHOCK can kill.

- Always wear dry insulating gloves.
- Insulate yourself from work and ground.
- Do not touch live electrode or electrical parts.
- Repair or replace worn, damaged, or cracked gun or cable insulation.
- Turn off welding power source before changing contact tip or gun parts.
- Keep all covers and handle securely in place.

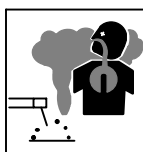

FUMES AND GASES can be hazardous.

- Keep your head out of the fumes.
- Ventilate area, or use breathing device.
- Read Material Safety Data Sheets (MSDSs) and manufacturer's instructions for material used.

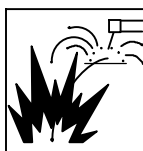

WELDING can cause fire or explosion.

- Do not weld near flammable material.
- Do not weld on closed containers.
- Watch for fire; keep extinguisher nearby.



BUILDUP OF GAS can injure or kill.

- Shut off shielding gas supply when not in use.
- Always ventilate confined spaces or use approved air-supplied respirator.

 Indicates special instructions.



This group of symbols means Warning! Watch Out! ELECTRIC SHOCK, MOVING PARTS, and HOT PARTS hazards. Consult symbols and related instructions below for necessary actions to avoid the hazards.

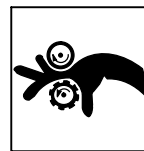

MOVING PARTS can injure.

- Keep away from moving parts.
- Keep away from pinch points such as drive rolls.

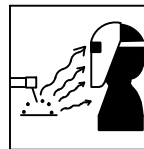

ARC RAYS can burn eyes and skin.

- Wear welding helmet with correct shade of filter.
- Wear correct eye and body protection.
- Cover exposed skin with spatter-resistant clothing.



HOT PARTS can burn.

- Allow gun to cool before touching.
- Do not touch hot metal.
- Protect hot metal from contact by others.

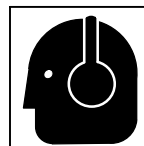

NOISE can damage hearing.

Noise from some processes or equipment can damage hearing.

- Check for noise level limits exceeding those specified by OSHA.
- Use approved ear plugs or ear muffs if noise level is high.
- Warn others nearby about noise hazard.

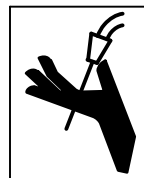

WELDING WIRE can injure.

- Keep hands and body away from gun tip when trigger is pressed.

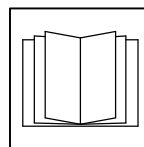

READ INSTRUCTIONS.

- Read and follow all labels and the Owner's Manual carefully before installing, operating, or servicing unit. Read the safety information at the beginning of the manual and in each section.
- Use only genuine replacement parts from the manufacturer.
- Perform maintenance and service according to the Owner's Manuals, industry standards, and national, state, and local codes.

1-3. Proposition 65 Warnings

 **Welding or cutting equipment produces fumes or gases which contain chemicals known to the State of California to cause birth defects and, in some cases, cancer. (California Health & Safety Code Section 25249.5 et seq.)**

 **This product contains chemicals, including lead, known to the state of California to cause cancer, birth defects, or other reproductive harm. *Wash hands after use.***

1-4. EMF Information

Electric current flowing through any conductor causes localized electric and magnetic fields (EMF). Welding current creates an EMF field around the welding circuit and welding equipment. EMF fields may interfere with some medical implants, e.g. pacemakers. Protective measures for persons wearing medical implants have to be taken. For example, access restrictions for passers-by or individual risk assessment for welders. All welders should use the following procedures in order to minimize exposure to EMF fields from the welding circuit:

1. Keep cables close together by twisting or taping them, or using a cable cover.
2. Do not place your body between welding cables. Arrange cables to one side and away from the operator.
3. Do not coil or drape cables around your body.

4. Keep head and trunk as far away from the equipment in the welding circuit as possible.
5. Connect work clamp to workpiece as close to the weld as possible.
6. Do not work next to, sit or lean on the welding power source.
7. Do not weld whilst carrying the welding power source or wire feeder.

About Implanted Medical Devices:



Implanted Medical Device wearers should consult their doctor and the device manufacturer before performing or going near arc welding, spot welding, gouging, plasma arc cutting, or induction heating operations. If cleared by your doctor, then following the above procedures is recommended.

SECTION 2 – INSTALLATION

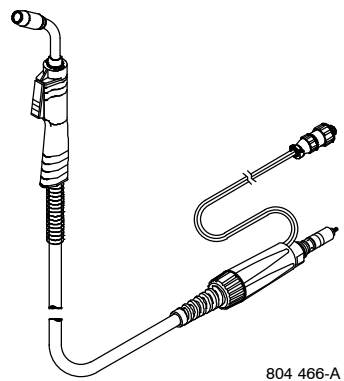
2-1. Specifications

 <p style="text-align: right;">804 466-A</p>	<p>Air-Cooled Welding Gun For GMAW And FCAW Welding</p> <p>Note: Using gasless flux cored wire reduces gun duty cycle.</p>
	<p>M-25 Feeds .023 To .045 in. (0.6 To 1.1 mm) Hard Or Flux Cored Wires</p> <p>Duty Cycle Rating:</p> <p>100%: 250 A With CO₂ Shielding Gas; 150 A With Mixed Gases</p> <p>60%: 300 A With CO₂ Shielding Gas; 250 A With Mixed Gases</p> <p>Weight With 15 ft (4.6 m) Power Cable: 6.0 lb (2.7 kg)</p> <p>Identified With <input checked="" type="checkbox"/> <input checked="" type="checkbox"/> <input type="checkbox"/> On Power Cable</p>

2-2. Duty Cycle And Overheating

☞ See Section 2-1. Specifications for amperage rating and duty cycle.

NOTICE – Exceeding duty cycle can damage unit or gun and void warranty.

<p>Definition</p>  <p>Duty Cycle is percentage of 10 minutes that gun can weld at rated load without overheating.</p>	<p>.023 To .045 in (0.6 To 1.1 mm) Hard Or Flux Cored Wires</p> <p>100% Duty Cycle At 200 Amperes Using CO₂</p> <p>100% Duty Cycle At 150 Amperes Using Mixed Gases</p>  <p style="text-align: center;">Continuous Welding</p>	<p>.023 To .045 in (0.6 To 1.1 mm) Hard Or Flux Cored Wires</p> <p>60% Duty Cycle At 300 Amperes Using CO₂</p> <p>60% Duty Cycle At 200 Amperes Using Mixed Gases</p>  <p style="text-align: center;">6 Minutes Welding 4 Minutes Resting</p>
<p>Overheating</p>  <p style="text-align: center;">OR Reduce Duty Cycle</p>		

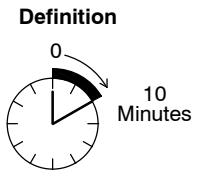
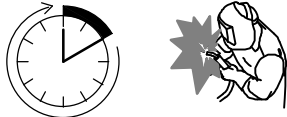
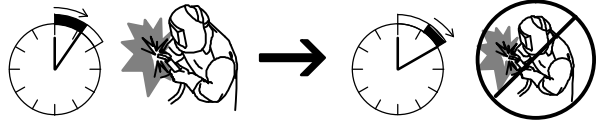
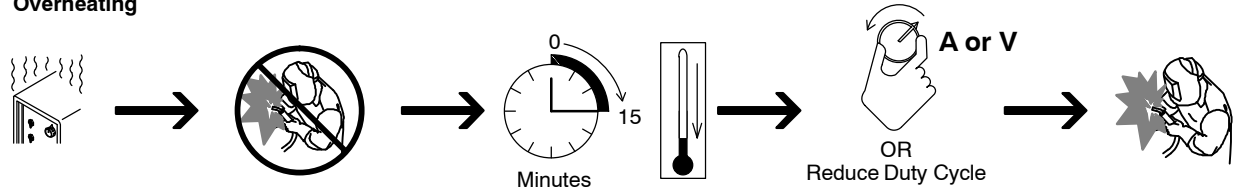
sduty1 5/95

2-3. Installing Gun

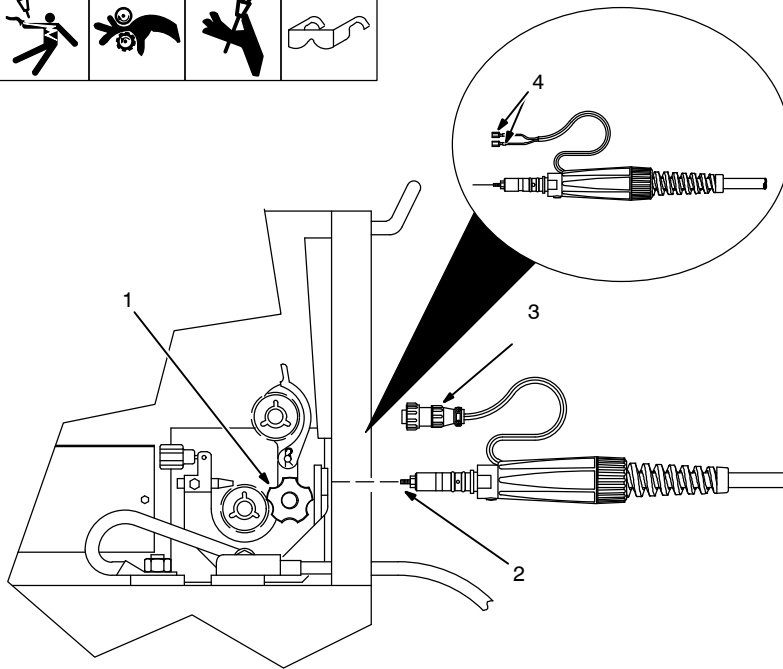

1 Gun Securing Knob

2 Gun End

Loosen knob. Insert gun end until it bottoms against drive assembly. Tighten knob.

3 Gun Trigger Plug

Insert into receptacle, and tighten threaded collar.

4 Friction Terminals

Some applications will require cutting off trigger plug and installing 0.250 female friction terminals onto end of leads.

See wire feeder manual for threading procedure.

804 465-A

SECTION 3 – OPERATION

3-1. Operating The Gun

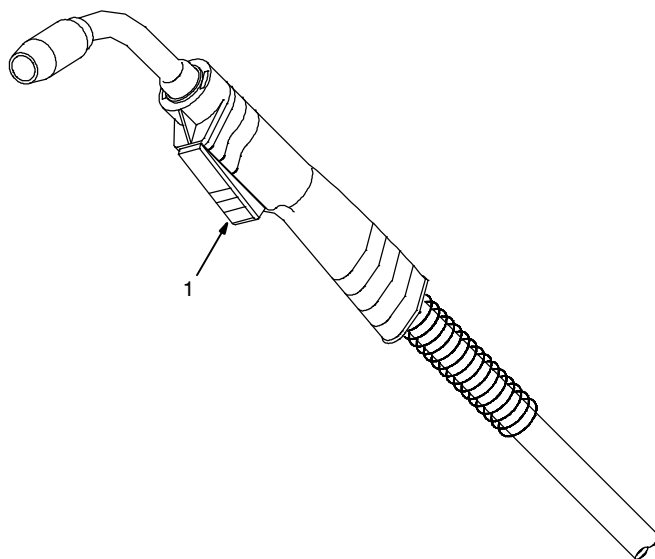
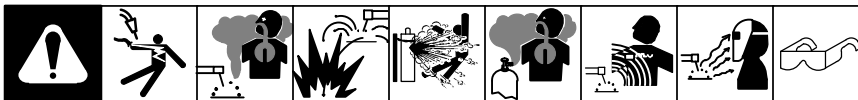

1 Trigger Switch

When pressed, energized wire feeds and shielding gas flows.

Ref. 800 797-C

SECTION 4 – MAINTENANCE & TROUBLESHOOTING

4-1. Removing Nozzle, Contact Tip, And Adapter, Changing Liner, And Cleaning Gun Casing

⚠ Turn off welding power source/wire feeder.

- 1 Nozzle
- 2 Contact Tip
- 3 Tip Adapter
- 4 Nozzle Adapter

☞ Wire size stamped on tip – check and match wire size.

Remove nozzle, contact tip, and adapter.

Cut off wire and disconnect gun from feeder.

Blow out gun casing.

Lay gun cable out straight before installing new liner.

3/4 in. (20 mm)
Liner Stickout

Reassemble gun in reverse order from taking it apart.





Install Liner

☞ Thread wire according to welding power source/wire feeder manual.

Tools Needed:

5/8, 7/16 in.

4-2. Replacing Switch And/Or Head Tube





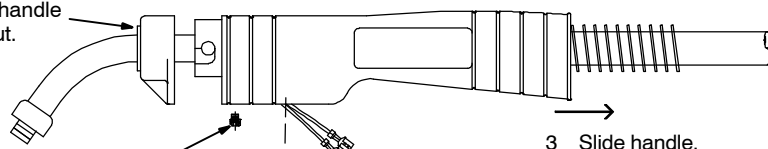

⚠ Turn Off welding power source /wire feeder and disconnect gun.

1 Remove handle locking nut.

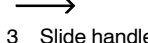

3 Slide handle.



4 Remove screw.

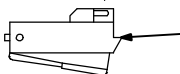

2 Remove switch housing. Install new switch and connect leads (polarity is not important). Reassemble in reverse order. If replacing head tube, continue to end of figure.

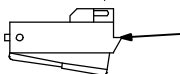

5 Secure head tube in vice.

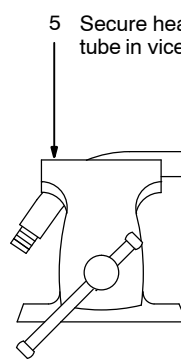

6 Loosen jam nut. Remove from vice and turn head tube out by hand.

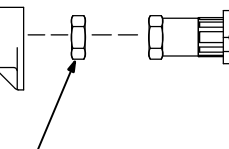

7 Install existing shock washer onto new head tube. Hand-tighten head tube into cable connector.

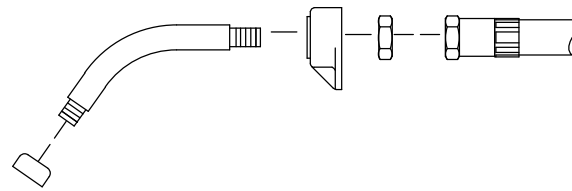

8 Place head tube in vice and tighten until nuts are tight.

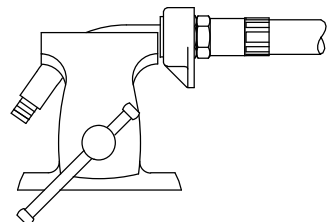

9 Remove from vice. Reposition handle and install switch housing. Secure with handle locking nut.

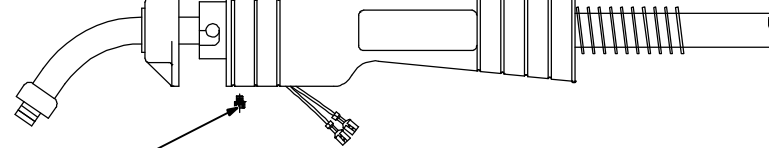

10 Install screw.

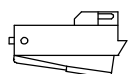



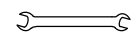



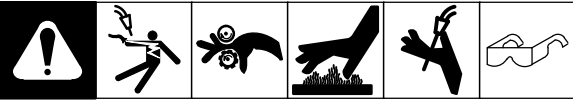

Tools Needed:

3/4 in. 9/64 in.

Ref. 800 795-E

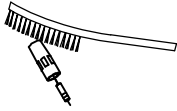
4-3. Routine Maintenance

					 Disconnect power before maintaining.		 <i>Maintain more often during severe conditions.</i>	
	✓ = Check ◇ = Change ● = Clean * To be done by Factory Authorized Service Agent			☆ = Replace		Reference		
Each Spool Of Wire	 ✓● Nozzle and contact tip	 ● Blow out gun casing						
Every 3 Months	 ☆ Unreadable Labels	 ☆ Damaged Gas Hose	 ✓☆ Cords	 ✓☆ Cracked Parts				

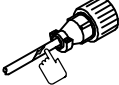
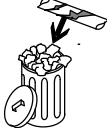
4-4. Troubleshooting

	
Trouble	Remedy
Wire does not feed; wire is not energized; wire feeds unevenly.	Check contact tip. Check for kinks in gun cable.
	Check gun trigger plug connection at welding power source/wire feeder.
	Check, and if necessary, replace gun trigger switch (see Section 4-2).
	Check contact tip. Check for kinks in gun cable. Blow out liner and gun casing (see Section 4-1).
Weld porosity.	Remove weld spatter buildup in nozzle.
	Make sure inner head tube is tight in cable connector.
	Check shielding gas flow/supply.
Wire feeding stops or does not feed properly during welding.	Straighten gun cable and/or replace damaged parts (see Section 4-1).
	Adjust drive roll pressure (see wire feeder manual).
	Change to proper drive roll groove (see wire feeder manual).
	Readjust hub tension (see wire feeder manual).
	Clean or replace liner if dirty or plugged (see Section 4-1).
	Replace drive roll or pressure bearing if worn or slipping (see wire feeder manual).

SECTION 5 – PARTS LIST

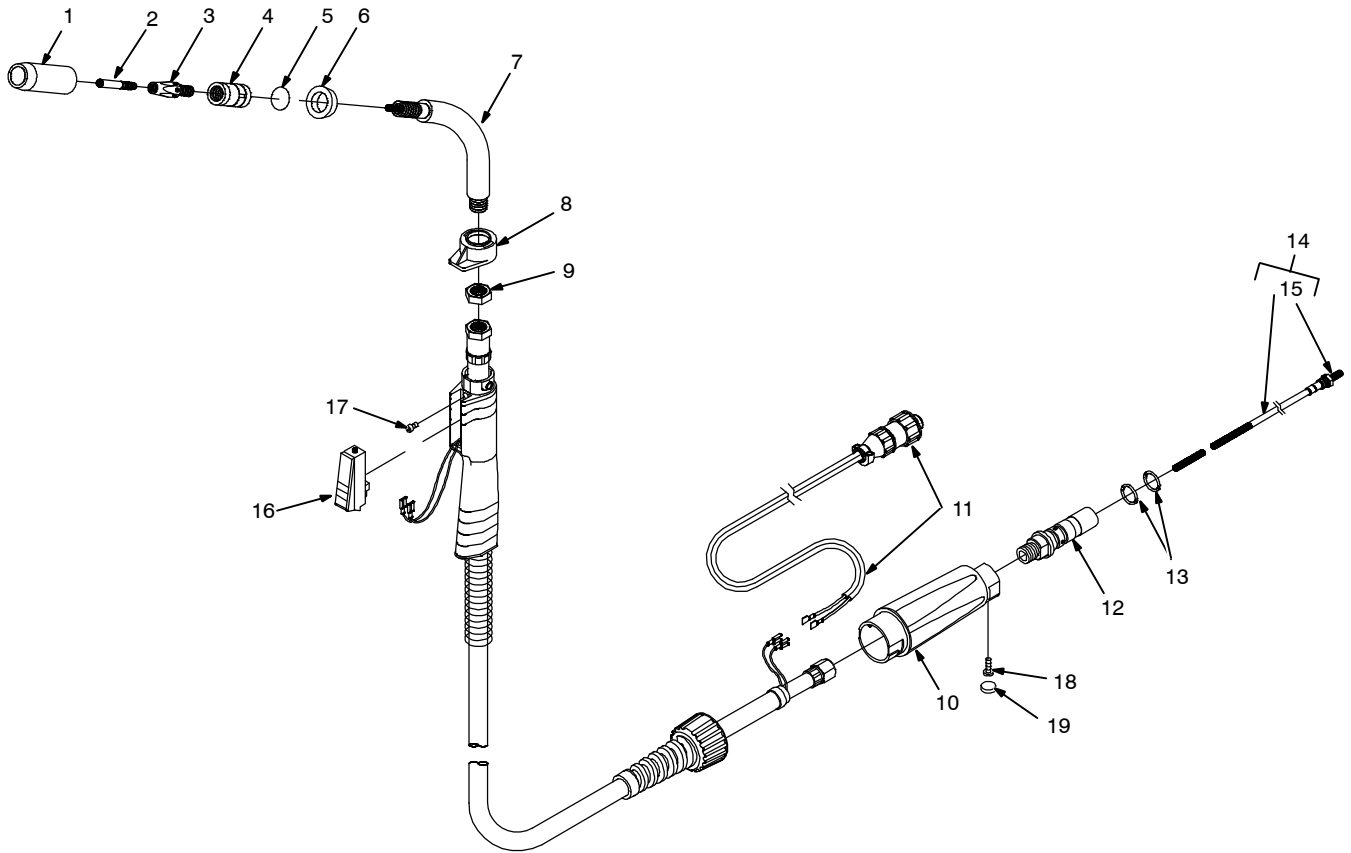

804 467-B

Figure 5-1. M-25 Gun

Item No.	Dia. Mkgs.	Part No.	Description	Quantity
----------	------------	----------	-------------	----------

Figure 5-1. M-25 Gun

... 1	200 258	.. NOZZLE, slip type .500 orf flush	1
... 1	+169 724	.. NOZZLE, slip type .500 orf .125 recess	1
... 1	+169 725	.. NOZZLE, slip type .625 orf .125 recess	1
... 1	+169 726	.. NOZZLE, slip type .625 orf flush	1
... 1	+169 727	.. NOZZLE, slip type .625 orf .125 stickout	1
... 2	+087 299	.. TIP, contact scr .023 wire x 1.125	
... 2	+000 067	.. TIP, contact scr .030 wire x 1.125	
... 2	+000 068	.. TIP, contact scr .035 wire x 1.125	
... 2	+000 069	.. TIP, contact scr .045 wire x 1.125	
... 3	169 728	.. ADAPTER, contact tip	1
... 4	169 729	.. ADAPTER, nozzle w/retaining ring	1
... 5	170 468	.. O-RING	1
... 6	169 730	.. WASHER, shock	1
... 7	169 731	.. TUBE, head	1

Item No.	Dia. Mkgs.	Part No.	Description	Quantity
----------	------------	----------	-------------	----------

Figure 5-1. M-25 Gun (Continued)

... 8	...	169 738	.. NUT, locking handle	1
... 9	...	169 732	.. NUT, jam	1
... 10	...	227 799	.. HANDLE, rear	1
... 11	...	227 800	.. CORD, trigger assembly	1
... 12	...	209 495	.. CONNECTOR, feeder	1
... 13	...	079 974	.. O-RING, .500 ID x .103CS rbr	2
... 14	...	+194 010	.. LINER, monocoil .023/.025 wire x 15ft (consisting of)	1
... 14	...	194 011	.. LINER, monocoil .030/.035 wire x 15ft (consisting of)	1
... 14	...	+194 012	.. LINER, monocoil .035/.045 wire x 15ft (consisting of)	1
... 14	...	+194 014	.. LINER, monocoil 3/64 AL wire x 10ft (consisting of)	1
... 15	...	079 975	.. O-RING, .187 ID x .103CS rbr	1
... 16	...	227 798	.. SWITCH, trigger	1
... 17 SCREW, 8-32 x .125 socket hd cap	1
... 18 SCREW, 8-32 x .312 button hd socket	1
... 19	...	253 383	.. BLANK, snap-in plastic	1

+OPTIONAL

To maintain the factory original performance of your equipment, use only Manufacturer's Suggested Replacement Parts. Model is required when ordering parts from your local distributor.

TRUE BLUE[®]

WARRANTY

Effective January 1, 2011

(Equipment with a serial number preface of MB or newer)

This limited warranty supersedes all previous Miller warranties and is exclusive with no other guarantees or warranties expressed or implied.

Warranty Questions?

Call
1-800-4-A-MILLER
for your local
Miller distributor.

Your distributor also gives
you ...

Service

You always get the fast,
reliable response you
need. Most replacement
parts can be in your
hands in 24 hours.

Support

Need fast answers to the
tough welding questions?
Contact your distributor.
The expertise of the
distributor and Miller is
there to help you, every
step of the way.

LIMITED WARRANTY – Subject to the terms and conditions below, Miller Electric Mfg. Co., Appleton, Wisconsin, warrants to its original retail purchaser that new Miller equipment sold after the effective date of this limited warranty is free of defects in material and workmanship at the time it is shipped by Miller. THIS WARRANTY IS EXPRESSLY IN LIEU OF ALL OTHER WARRANTIES, EXPRESS OR IMPLIED, INCLUDING THE WARRANTIES OF MERCHANTABILITY AND FITNESS.

Within the warranty periods listed below, Miller will repair or replace any warranted parts or components that fail due to such defects in material or workmanship. Miller must be notified in writing within thirty (30) days of such defect or failure, at which time Miller will provide instructions on the warranty claim procedures to be followed.

Miller shall honor warranty claims on warranted equipment listed below in the event of such a failure within the warranty time periods. All warranty time periods start on the delivery date of the equipment to the original end-user purchaser, and not to exceed one year after the equipment is shipped to a North American distributor or eighteen months after the equipment is shipped to an International distributor.

1. 5 Years Parts — 3 Years Labor
 - * Original main power rectifiers only to include SCRs, diodes, and discrete rectifier modules
2. 3 Years — Parts and Labor
 - * Engine Driven Welding Generators
(NOTE: Engines are warranted separately by the engine manufacturer.)
 - * Inverter Power Sources (Unless Otherwise Stated)
 - * Plasma Arc Cutting Power Sources
 - * Process Controllers
 - * Semi-Automatic and Automatic Wire Feeders
 - * Smith 30 Series Flowgauge and Flowmeter Regulators (No Labor)
 - * Transformer/Rectifier Power Sources
 - * Water Coolant Systems (Integrated)
3. 2 Years — Parts
 - * Auto-Darkening Helmet Lenses (No Labor)
4. 1 Year — Parts and Labor Unless Specified
 - * Automatic Motion Devices
 - * CoolBelt and CoolBand Blower Unit (No Labor)
 - * External Monitoring Equipment and Sensors
 - * Field Options
(NOTE: Field options are covered for the remaining warranty period of the product they are installed in, or for a minimum of one year — whichever is greater.)
 - * Flowgauge and Flowmeter Regulators (No Labor)
 - * RFCS Foot Controls (Except RFCS-RJ45)
 - * Fume Extractors
 - * HF Units
 - * ICE Plasma Cutting Torches (No Labor)
 - * Induction Heating Power Sources, Coolers, and Electronic Controls/Recorders
 - * Load Banks
 - * Motor Driven Guns (w/exception of Spoolmate Spoolguns)
 - * PAPR Blower Unit (No Labor)
 - * Positioners and Controllers
 - * Racks
 - * Running Gear/Trailers
 - * Spot Welders
 - * Subarc Wire Drive Assemblies
 - * Water Coolant Systems (Non-Integrated)
 - * Weldcraft-Branded TIG Torches (No Labor)
 - * Wireless Remote Foot/Hand Controls and Receivers
 - * Work Stations/Weld Tables (No Labor)

5. 6 Months — Parts
 - * Batteries
 - * Bernard Guns (No Labor)
 - * Tregaskiss Guns (No Labor)

6. 90 Days — Parts
 - * Accessory (Kits)
 - * Canvas Covers
 - * Induction Heating Coils and Blankets, Cables, and Non-Electronic Controls
 - * M-Guns
 - * MIG Guns and Subarc (SAW) Guns
 - * Remote Controls and RFCS-RJ45
 - * Replacement Parts (No labor)
 - * Roughneck Guns
 - * Spoolmate Spoolguns

Miller's True Blue[®] Limited Warranty shall not apply to:

1. **Consumable components; such as contact tips, cutting nozzles, contactors, brushes, relays, work station table tops and welding curtains, or parts that fail due to normal wear. (Exception: brushes and relays are covered on all engine-driven products.)**
2. Items furnished by Miller, but manufactured by others, such as engines or trade accessories. These items are covered by the manufacturer's warranty, if any.
3. Equipment that has been modified by any party other than Miller, or equipment that has been improperly installed, improperly operated or misused based upon industry standards, or equipment which has not had reasonable and necessary maintenance, or equipment which has been used for operation outside of the specifications for the equipment.

MILLER PRODUCTS ARE INTENDED FOR PURCHASE AND USE BY COMMERCIAL/INDUSTRIAL USERS AND PERSONS TRAINED AND EXPERIENCED IN THE USE AND MAINTENANCE OF WELDING EQUIPMENT.

In the event of a warranty claim covered by this warranty, the exclusive remedies shall be, at Miller's option: (1) repair; or (2) replacement; or, where authorized in writing by Miller in appropriate cases, (3) the reasonable cost of repair or replacement at an authorized Miller service station; or (4) payment of or credit for the purchase price (less reasonable depreciation based upon actual use) upon return of the goods at customer's risk and expense. Miller's option of repair or replacement will be F.O.B., Factory at Appleton, Wisconsin, or F.O.B. at a Miller authorized service facility as determined by Miller. Therefore no compensation or reimbursement for transportation costs of any kind will be allowed.

TO THE EXTENT PERMITTED BY LAW, THE REMEDIES PROVIDED HEREIN ARE THE SOLE AND EXCLUSIVE REMEDIES. IN NO EVENT SHALL MILLER BE LIABLE FOR DIRECT, INDIRECT, SPECIAL, INCIDENTAL OR CONSEQUENTIAL DAMAGES (INCLUDING LOSS OF PROFIT), WHETHER BASED ON CONTRACT, TORT OR ANY OTHER LEGAL THEORY.

ANY EXPRESS WARRANTY NOT PROVIDED HEREIN AND ANY IMPLIED WARRANTY, GUARANTY OR REPRESENTATION AS TO PERFORMANCE, AND ANY REMEDY FOR BREACH OF CONTRACT TORT OR ANY OTHER LEGAL THEORY WHICH, BUT FOR THIS PROVISION, MIGHT ARISE BY IMPLICATION, OPERATION OF LAW, CUSTOM OF TRADE OR COURSE OF DEALING, INCLUDING ANY IMPLIED WARRANTY OF MERCHANTABILITY OR FITNESS FOR PARTICULAR PURPOSE, WITH RESPECT TO ANY AND ALL EQUIPMENT FURNISHED BY MILLER IS EXCLUDED AND DISCLAIMED BY MILLER.

Some states in the U.S.A. do not allow limitations of how long an implied warranty lasts, or the exclusion of incidental, indirect, special or consequential damages, so the above limitation or exclusion may not apply to you. This warranty provides specific legal rights, and other rights may be available, but may vary from state to state.

In Canada, legislation in some provinces provides for certain additional warranties or remedies other than as stated herein, and to the extent that they may not be waived, the limitations and exclusions set out above may not apply. This Limited Warranty provides specific legal rights, and other rights may be available, but may vary from province to province.





Owner's Record

Please complete and retain with your personal records.

Model Name

Serial/Style Number

Purchase Date

(Date which equipment was delivered to original customer.)

Distributor

Address

City

State

Zip



For Service

Contact a DISTRIBUTOR or SERVICE AGENCY near you.

Always provide Model Name and Serial/Style Number.

Contact your Distributor for:

Welding Supplies and Consumables

Options and Accessories

Personal Safety Equipment

Service and Repair

Replacement Parts

Training (Schools, Videos, Books)

Technical Manuals (Servicing Information and Parts)

Circuit Diagrams

Welding Process Handbooks

To locate a Distributor or Service Agency visit www.millerwelds.com or call 1-800-4-A-Miller

Contact the Delivering Carrier to:

File a claim for loss or damage during shipment.

For assistance in filing or settling claims, contact your distributor and/or equipment manufacturer's Transportation Department.

Miller Electric Mfg. Co.

An Illinois Tool Works Company
1635 West Spencer Street
Appleton, WI 54914 USA

International Headquarters—USA

USA Phone: 920-735-4505 Auto-Attended
USA & Canada FAX: 920-735-4134
International FAX: 920-735-4125

For International Locations Visit
www.MillerWelds.com

