

CIVIL AIR PATROL
U.S. Air Force Auxiliary

Mission Aircrew
Reference Text



Volume II
Mission Observer and
SAR/DR Mission Pilot

Revision December 2017

This text is designed to provide: 1) the minimum academic knowledge required by the Civil Air Patrol (CAP) Mission Observer and SAR/DR Mission Pilot task guides and 2) knowledge beyond that required by the aircrew task guides that will serve as a reference and assist those who wish to learn more about the various subjects.

The Mission Observer (MO) is a scanner with expanded duties who usually sits in the right front seat. In addition to the primary duty of scanning while in the search area, the observer assists the pilot with planning, navigation, and communication. The observer may also serve as mission commander, ensuring that all mission objectives are met.

The SAR/DR Mission Pilot (MP) is the aircraft commander and is responsible for the safety of the crew and the aircraft. The MP must fly the aircraft precisely in order to execute mission procedures and search patterns so that the scanners have the best possible chance to achieve mission objectives. Naturally, as Pilot-in-Command the pilot must satisfy all pertinent FAA and CAP regulations pertaining to certification, currency and the operation of the aircraft; this text concentrates on mission-specific duties and responsibilities.

The importance of safety is emphasized throughout the text. Lessons learned in this text will enable aircrew members to operate in a safe and efficient manner, thus reducing accidents and incidents.

Before beginning training in any of the aircrew ratings you should review and understand the current CAP 60-series regulations, which provide current operations and training guidance and requirements. Trainee prerequisites for each rating are provided in CAPR 60-3 Chapter 2 and in the Specialty Qualification Training Record (SQTR) for Mission Observer and Mission Pilot.

NOTE: This text contains links to web sites, and web addresses often change. If selecting the link does not take you to the desired site, either try copying and pasting the url into your browser's address bar or search for the particular site or document with your favorite search engine.



Acknowledgements

Many dedicated persons have contributed to the development of the text, slides, and attachments that make up the CAP mission aircrew reference texts. Material was taken from CAP sources all over the country. There are too many to thank, but we will mention several important contributors.

The core of this text was developed from the *Southwest Region Scanner/Observer Course*. Developed, maintained and taught by several Reserve Officers in the CAP/RAP program that serves Texas Wing and Southwest Region, the course has been in existence for several years. Lt. Col. Robert H. Castle, USAFR led this effort.

The text was then modified and expanded to serve as the classroom material for the National Emergency Services Academy (NESA) *Mission Aircrew School*, which was begun in 2000. One of the school co-founders, Lt. Col. Rich Simerson, developed this text and the associated slides; he now maintains and updates the materials. The other co-founder, Col Mike DuBois, provided invaluable input and was indispensable in shaping the course. Several instructors and students of the first two schools also contributed greatly, particularly Major Arden Heffernan, Major Earl Burrell, Captain Galen Hall, and Major Scott Lanis. The NESA Director, Lt Col John Desmarais, provided unstinting support and assistance.

This text and associated training materials were developed under the auspices of the National Emergency Services Curriculum Project. Valuable input was provided by one of the Middle East Region representatives, Lt Col Robert Ayres. This is a 'living' document that is being tested and improved through its use at the NESA Mission Aircrew School and through field-testing by units throughout the country as part of the Emergency Services Curriculum Project.

Please direct comments (via e-mail) to the text administrator, Lt Col Rich Simerson, at rsim@suddenlink.net. Please be specific and provide justification for your comments. If you refer to specific text or figures, please identify them clearly. If you have better pictures or slides than the ones appearing in the text or slides, or have others that you feel will improve the text and/or slides, please send them electronically and include explanatory notes or annotation.

Organization & Guidance

The knowledge gained in the Mission Scanner course is a prerequisite for both the Mission Observer and Pilot courses. This is consistent with the fact that Mission Scanner qualification is a prerequisite on both the MO and MP Specialty Qualification Training Records (SQTRs). Task Guides and other aircrew training and reference material are available electronically on the SWR ES Education and Training webpage (<http://est.swrcap.com>).

This text is augmented by two sets of Microsoft PowerPoint slides: Observer and Pilot. Using this text and the appropriate slide set(s), either of these two mission specialties can be taught separately or in any combination.

Each chapter has a list of objectives to assist students, school directors, project leaders and instructors. Each objective is tied to one and/or the other of these mission specialties (i.e., O = Observer and P = Pilot). The associated slides also reference applicable objectives.

The table lists the objectives that each mission specialty has in a particular chapter of the text (if any). Some chapters have objectives for more than one specialty; the associated slides recognize this and only contain material that addresses that specialty's objectives (and subsequent depth of knowledge). The shaded cells indicate that all or the great majority of the chapter is not applicable.

Chapter	Observer (Objectives)	Pilot (Objectives)
1	1	
2	1 - 3, 5	1 & 3
3	1 - 9	
4	1 - 4	Optional review
5	ALL	6 & 7
6	ALL	ALL
7	ALL	ALL
8	ALL	ALL
9		ALL
10	ALL	ALL
11	ALL	ALL

To further help both student and instructor, *MP and MO tasks* (from the Task Guides) are *linked to the objectives that support them*. For example, Objective 2 of Chapter 2 (Communications) says to describe how to recognize a stuck mike, and corrective actions. Following the Objective is {MO O-2002}, which means that this is an *Observer task*. If an objective applies to more than one specialty, this will also be identified. For example, Objective 2 is followed by {MO O-2002; MP O-2001}, which means that both observers and pilots need to know how to use the audio

panel and FM radio. The remainders of the objectives are designed to provide supporting and/or more detailed information to aid in your training.

Suppose you want to conduct a Mission Observer course. From the Table, above, you know that you will be instructing from Chapters 1 - 8, 10 and 11. You may also notice that there is considerable overlap between the Observer and Pilot objectives from Chapter 6 onward; you may elect to take advantage of this and combine the two groups at this point (it allows the pilots to help the non-pilots). [Note: because of this overlap, many of the Observer and Pilot slides are identical.]

Example Classroom Schedules

To further aid course directors and instructors, the following two pages contain example course schedules. Each table lists the:

- Subject (chapter number and title)
- Time (hours and minutes format; minimum required for a knowledgeable instructor to cover the subject, based on experience from the National Mission Aircrew School)
- Objectives (chapter)
- Sections (header numbers of the chapter sections that support the associated chapter objectives)
- Slides (that support the associated chapter objectives; from applicable slide set -- Observer or Pilot)

The schedules are constructed as if each course (Observer or Pilot) will be taught separately. If directors or instructors wish to combine Observer and Pilot students when covering those subjects applicable to both, the schedules indicate (with an asterisk) the objectives that are shared by both the Observer and Pilot.

Although not covered in the text, both the Observer and Pilot course schedules add time for tabletop exercises to give students practice planning the various visual search patterns.

[NOTE: Attachment 2, the *Flight Guide*, is provided separately. Attachment 2 of this text provides a Table of Contents for the guide.]

Observer Course Classroom Schedule (example)

Subject	Time	Objectives	Sections	Slides
Sign-in / Welcome / Overview *	0:30			
CAPR 60-series review slides *	0:30			
Chapter 1 Observer Duties & Responsibilities	0:30	1	1.1	4 - 17
Chapter 2 Communications	0:45	1 *, 2, 3 *, 5	2.1.2 - 2.1.3 * 2.1.4 - 2.1.5 2.3	18 - 37
Chapter 3 Weather	2:00	1 - 9	3.1.3 & 3.1.5 3.2.1 - 3.2.3 3.3 - 3.4 3.6 - 3.7	38 - 62
Chapter 4 High Altitude & Terrain Considerations	0:30	1 - 4	4.1 - 4.2 4.4	63 - 78
Chapter 5 Navigation & Position Determination	2:00	1 - 5, 6 *, 7 *	5.3 - 5.5 5.8.1 5.10.1 * 5.10.2, Atch. 1 *	79 - 100
Chapter 6 Search Planning & Coverage	0:30	1 - 3 *	6.2.1 - 6.2.4 *	101 - 120
Chapter 7 Electronic Search Patterns	1:45	1 - 7 *	7.1.1 & 7.2 * 7.3.1 - 7.3.2 * 7.4 - 7.7 * 7.9 - 7.10 *	121 - 251
Chapter 8 Visual Search Patterns	1:35	1 - 5 *	8.2 - 8.7 *	252 - 274
Chapter 10 Step Through a Typical Mission	2:00	1 - 11 *	All *	275 - 329
Chapter 11 Crew Resource Management	0:50	1 - 6 *	11.2 - 11.6 * 11.8 *	330 - 354
Flight Planning for a Route search	0:25	Tabletop exercise *		
Flight Planning for a Grid search	0:25	Tabletop exercise *		
Flight Planning for a Creeping Line search	0:25	Tabletop exercise *		
Flight Planning for a Point-Based search	0:25	Tabletop exercise *		
Observer Course Review	0:30			
Observer Exam	1:00			
Exam Review	0:30			
TOTAL	17:10			

* Objectives are the same for both Observer and Mission Pilot

Mission Pilot Course Classroom Schedule (example)

Subject	Time	Objectives	Sections	Slides
Sign-in / Welcome / Overview *	0:30			
CAPR 60-series review slides *	0:30			
Introduction (Chapter 9) Pilot Duties & Responsibilities	0:15	1	9.1	4 – 12
Chapter 2 Communications	0:30	1	2.1.2 - 2.1.3 * 2.1.5 *	13 – 22
Chapter 3 Weather	0:15	Optional (review)		23 – 24
Chapter 4 High Altitude & Terrain Considerations	0:15	Optional (review)		25 – 43
Chapter 5 Navigation & Position Determination	0:50	6 & 7 *	5.10.1 * 5.10.2, Atch. 1 *	44 - 48
Chapter 6 Search Planning & Coverage	0:30	1 - 3 *	6.2.1 - 6.2.4 *	49 – 69
Chapter 7 Electronic Search Patterns	1:45	1 - 7 *	7.1.1 & 7.2 * 7.3.1 – 7.3.2 * 7.4 – 7.7 * 7.9 – 7.10 *	70 – 200
Chapter 8 Visual Search Patterns	1:35	1 - 5 *	8.2 – 8.7 *	201 – 223
Chapter 9 Mission Pilot	2:30	2 - 21	9.2 – 9.7	224 – 292
Chapter 10 Step Through a Typical Mission	1:00	1 - 11 *	All *	293 – 345
Chapter 11 Crew Resource Management	0:50	1 - 6 *	11.2 - 11.6 * 11.8 *	346 - 368 ***
Flight Planning for a Route search	0:25	Tabletop exercise *		
Flight Planning for a Grid search	0:25	Tabletop exercise *		
Flight Planning for a Creeping Line search	0:25	Tabletop exercise *		
Flight Planning for a Point-Based search	0:25	Tabletop exercise *		
Pilot Course Review	0:30			
Pilot Exam	1:00			
Exam Review	0:30			
TOTAL	15:05			

* Objectives are the same for both Observer and Pilot

** Extra slides (370 - 388) cover Pilot Records and a CAPF 91 Review

Task Guides

Mission Observer (MO) tasks:

- O-2002 Operate the Aircraft Radios
- O-2010 Use In-flight Services
- O-2011 Operate the VOR and DME
- O-2012 Operate the GPS
- O-2013 Plot a Route on a Sectional Chart
- O-2107 Prepare for a Trip to a Remote Mission Base
- O-2108 Assist in ELT Searches
- O-2109 Assist in Planning and Performing a Route Search
- O-2110 Assist in Planning and Performing a Parallel Search
- O-2112 Assist in Planning and Performing Point Based Searches
- O-2115 Assist in Planning and Performing a Creeping Line Search

- P-2007 Discuss Mission Observer Duties and Responsibilities
- P-2008 Discuss the Dangers of Icing
- P-2009 Discuss the Dangers of Reduced Visibility Conditions
- P-2010 Discuss the Dangers of Wind and Thunderstorms
- P-2011 Discuss the Effects of Density Altitude on Aircraft Performance
- P-2012 Identify Controlled and Special Use Airspaces on a Sectional

SAR/DR Mission Pilot (MP) tasks:

- O-2001 Operate the Aircraft Audio Panel
- O-2003 Grid Sectional Charts
- O-2004 Use a POD Table
- O-2005 Operate the Aircraft DF
- O-2006 Perform ELT Searches
- O-2007 Locate and Silence an ELT on the Ground
- O-2008 Complete a Mission Sortie
- O-2009 Demonstrate Air/Ground Team Coordination
- O-2101 Describe how ELTs are Detected
- O-2102 Demonstrate Planning and Flying a Route Search
- O-2103 Demonstrate Planning and Flying a Parallel Track Search
- O-2104 Demonstrate Planning and Flying a Creeping Line Search
- O-2105 Demonstrate Planning and Flying Point Based Searches
- O-2106 Plan and Command a CAP Flight
- O-2107 Prepare for a Trip to a Remote Mission Base

- P-2001 Discuss Mission Pilot Duties and Responsibilities
- P-2002 Discuss General CAP-related Safety Requirements and Issues
- P-2003 Discuss Types of Flights Performed by CAP Aircrews
- P-2004 Discuss Security Concerns and Procedures
- P-2005 Discuss Mission Pilot Responsibilities during a Mission
- P-2028 Discuss Crew Resource Management
- P-2119 Demonstrate How to Complete an Aircraft Inspection

References

1. The following CAP Regulations (CAPR):
 - a. 70-1, *CAP Flight Management*
 - b. 60-3, *CAP Emergency Services Training and Operational Missions*
 - c. 60-5, *Critical Incident Stress Management*
 - d. 62-1, *CAP Safety Responsibilities and Procedures*
 - e. 62-2, *Mishap Reporting and Investigation*
 - f. 66-1, *CAP Aircraft Maintenance Management*
 - g. 100-1, *Communications - Electronics*
 - h. 173-3, *Payment for Civil Air Patrol Support*
 - i. 900-5, *CAP Insurance/Benefits Program*
2. CAPP-2, *ELT/EPRIB Search*
3. *Southwest Region Scanner/Observer Course*, Version 3.0
4. *Mountain Fury*, First Edition
5. *United States National Search and Rescue Supplement to the International Aeronautical and Maritime SAR Manual*, May 2000.
6. AC 00-6A, *Aviation Weather*, 1/1/1975.
7. AC 00-45F, *Aviation Weather Services*, Chg. 2, 3/12/09.
8. FAA-H-8083-3, *Airplane Flying Handbook*
9. FAA-H-8083-25, *Pilot's Handbook of Aeronautical Knowledge*
10. *Federal Aviation Regulations*.
11. FAA NOTAM Search
12. *Aeronautical Information Manual*.
13. *Aeronautical Chart User's Guide*, 12th Edition
14. AOPA/ASA *Safety Advisories*.
15. Cessna *Pilot Operating Handbooks*.
16. Cessna *Pilot Safety and Warning Supplements*.
17. *Pocket Guide to USAF Operational Risk Management*, John D. Phillips, Air Force Safety Center.
18. CAP Operational Mission *In-Flight Guide and Aircrew Aid*, Scott E. Lanis, MAJ, CAP
19. Cessna Nav III G1000® *Search Pattern Procedures*, V2.0
20. Garmin G1000® *Integrated Flight Deck Pilot's Guide*
21. SWR ES Education and Training webpage (<http://est.swrcap.com>).

Intentionally Blank

Table of Contents

List of Acronyms	1
1. Mission Observer Duties	3
<i>OBJECTIVES:</i>	3
1.1 Mission Observer duties and responsibilities	4
1.2 The Observer Log	5
1.3 Forms	5
2. Communications	7
<i>OBJECTIVES:</i>	7
2.1 Electronic Communications	8
2.2 Non-verbal communication	16
2.3 In-flight services	22
3. Weather	27
<i>OBJECTIVES:</i>	27
3.1 Basic weather	28
3.2 Icing	32
3.3 Frontal activity	35
3.4 Reduced Visibility	40
3.5 Turbulence	41
3.6 Wind shear	42
3.7 Thunderstorms	43
4. High Altitude and Terrain Considerations	45
<i>OBJECTIVES:</i>	45
4.1 Atmospheric pressure	46
4.2 Aircraft performance limitations	47
4.3 Effects on crewmember performance	49
4.4 Mountainous terrain	52

5. Navigation and Position Determination	53
<i>OBJECTIVES:</i>	53
5.1 Navigation Terms	54
5.2 Latitude and longitude	55
5.3 Magnetic variation	56
5.4 Airspace	57
5.5 Electronic Aids to Navigation (Nav aids)	61
5.6 Sectional Charts	69
5.7 Chart Interpretation	70
5.8 Chart Preparation	74
5.9 Tracking and Recording Position	78
5.10 Standardized Grid Systems	79
6. Search Planning and Coverage	85
<i>OBJECTIVES:</i>	85
6.1 Search Terms	86
6.2 Search Planning	87
6.3 Probability of Detection example	94
6.4 Disaster Assessment	95
6.5 Missing Person Search	99
7. Electronic Search Patterns	101
<i>OBJECTIVES:</i>	101
7.1 ELTs and SARSAT	103
7.2 Locating the ELT Signal	105
7.3 Aircraft Direction Finder (DF)	106
7.4 Homing Method	110
7.5 Wing shadow method (signal null)	111
7.6 Aural (or hearing) search	114
7.7 Metered search	115
7.8 Night and IFR electronic search	116
7.9 Signal Reflection and Interference	117
7.10 Silencing an ELT	119

8. Visual Search Patterns	124
<i>OBJECTIVES:</i>	124
8.1 Planning Search Patterns	125
8.2 Track line (route) search	126
8.3 Parallel track or parallel sweep	126
8.4 Creeping line search	129
8.5 Expanding Square search (a point-based search)	133
8.6 Sector search (a point-based search)	136
8.7 Contour search	137
8.8 Other SAR-related GPS Features	138
9. Mission Pilot	140
<i>OBJECTIVES:</i>	140
9.1 Mission Pilot duties and responsibilities	141
9.2 Safety	142
9.3 Types of Flights	146
9.4 Security Concerns and Airspace Restrictions	152
9.5 Phases of Flight	156
9.6 The Mission Pilot and POD	165
9.7 Flying the Mission	165
10. Step Through a Typical Mission	170
<i>OBJECTIVES:</i>	170
10.1 Leaving Home Base for Mission Base	172
10.2 Arrival at Mission Base	176
10.3 Operational Risk Management Review	177
10.4 General Briefing	179
10.5 Aircrew Briefing	180
10.6 Mission Flight Planning and Briefing	180
10.7 Preparing to Leave on a Sortie	185
10.8 During the Sortie	185
10.9 Return from the Sortie	186
10.10 Debriefing Information	187
10.11 Aircrew Debriefing	189
10.12 End of the Mission and the Return Home	190
10.13 Conduct Local Drills and Exercises	191

11. Crew Resource Management	194
<i>OBJECTIVES:</i>	194
11.1 Statistics	195
11.2 Failures and the Error Chain	196
11.3 Situational Awareness	197
11.4 Overcoming Loss of SA	198
11.5 Barriers to Communication	199
11.6 Task Saturation	199
11.7 Identification of Resources	200
11.8 Assignment and Coordination of Duties	200
Attachment 1	I
GRIDDING	I
Attachment 2	III
FLIGHT GUIDE	III

Summary of Changes

Following are the significant changes and updates in the December 2017 revision. Some of the more significant changes are highlighted.

1. Updated to latest CAPR 70-1 requirements

Intentionally Blank

List of Acronyms

AFAM	Air Force Assigned Mission
AFRCC	Air Force Rescue Coordination Center
AGL	Above Ground Level
AIF	Aircraft Information File
AIM	Airman's Information Manual
AP	Airborne Photographer
ARTCC	Air Route Traffic Control Center
ASOS	Automated Surface Observing System
ATA	Actual Time of Arrival
ATC	Air Traffic Control
ATD	Actual Time of Departure
ATIS	Automatic Terminal Information Service
AWOS	Automated Weather Observing System
CAPF	CAP Form
CAPR	CAP Regulation
CD	Counterdrug
COM/COMM	Communication
COSPAS	Cosmicheskaya Sistyema Poiska Avariynich Sudov (Space System for the Search of Vessels in Distress)
CTAF	Common Traffic Advisory Frequency
CRM	Crew Resource Management
DF	Direction Finder
DR	Disaster Relief
DUAT	Direct User Access Terminal
ECD	Electronic Chart Display
EFB	Electronic Flight Bag
ELT	Emergency Locator Transmitter
EPIRB	Marine Emergency Position Indicating Radio Beacon
ES	Emergency Services
ETA	Estimated Time of Arrival
ETD	Estimated Time of Departure
ETE	Estimated Time Enroute
FAA	Federal Aviation Administration
FAR	Federal Aviation Regulation
FBO	Fixed Base Operator
FCC	Federal Communications Commission
FEMA	Federal Emergency Management Agency
FRO	Flight Release Officer
FSS	Flight Service Station
GPS	Global Positioning System
HLS	Homeland Security
HIWAS	Hazardous In-Flight Weather Advisory Service
ICUT	Introductory Communications User Training
IMC	Instrument Meteorological Conditions
IFR	Instrument Flight Rules
Lat/Long	Latitude/Longitude
MEF	Maximum Elevation Figure

MHz	Megahertz
MO	Mission Observer
MOA	Military Operations Area
MOU	Memorandum of Understanding
MP	Mission SAR/DR Pilot
MS	Mission Scanner
MSL	Mean Sea Level
MTR	Military Training Route
NESA	National Emergency Services Academy
NOAA	National Oceanic and Atmospheric Administration
NOTAM	Notice to Airmen
NTSB	National Transportation Safety Board
NWS	National Weather Service
OPSEC	Operational Security
ORM	Operational Risk Management
PA	Prohibited Area
PIC	Pilot-in-Command
PIREP	Pilot Weather Report
PLB	Personal Locator Beacon
PTT	Push-to-Talk (radio switch)
RA	Restricted Area
ROA	Radio Operator Authorization
SA	Situational Awareness
SAR	Search and Rescue
SARSAT	Search and Rescue Satellite-Aided Tracking
SQTR	Specialty Qualification Training Record
SO	Safety Officer
SUA	Special Use Airspace
TPA	Traffic Pattern Altitude
TFR	Temporary Flight Restriction
TWEB	Transcribed Weather Broadcast
USAF	United States Air Force
UTC	Coordinated Universal Time
UHF	Ultra High Frequency
VFR	Visual Flight Rules
VHF	Very High Frequency
VMC	Visual Meteorological Conditions
WMIRS	Web Mission Information Reporting System
ZULU	Coordinated Universal Time

1. Mission Observer Duties

OBJECTIVES:

1. State mission observer duties and responsibilities. {MO P-2007}
2. Discuss entering data into forms, including via WMIRS.

** Throughout this text, each objective is followed by:*

- a. The mission specialty rating to which the objective applies (MO = Observer; MP = SAR/DR Pilot)
- b. The associated task (from the MO or MP Task Guides)

1.1 Mission Observer duties and responsibilities

The mission observer has a key role in CAP missions, and has expanded duties that mainly pertain to assisting the mission pilot. This assistance may be in the planning phase, handling radio communications, assisting in navigation, and crew management (i.e., mission commander). The proficient observer makes it possible for the pilot to perform his duties with a greater degree of accuracy and safety by assuming these aspects of the workload.

In addition to the scanner duties, observers must also:

- Depending on conditions, you may report with the mission pilot for briefing
- Assist in planning the mission, and assist in completing the Planning and Briefing sections of a sortie in WMIRS. The observer may act as mission commander for the sortie.
- Ensure that the aircrew obtains sufficient rest during crew rest periods, including approval of extensions to the maximum air crew duty period
- Assist in avoiding collisions and obstacles during taxiing
- Assist in setting up and operating aircraft and CAP radios
- Assist in setting up and operating aircraft navigational equipment (e.g., VORs and GPS)
- Assist enforcing the sterile cockpit rules
- Maintain situational awareness at all times
- Assist in monitoring fuel status
- Monitor the electronic search devices aboard the aircraft and advise the pilot when making course corrections in response to ELT signals
- Keep mission base and/or high bird apprised of status
- Coordinate scanner assignments and ensure proper breaks for the scanners (including you). Monitor crew for fatigue and dehydration (ensure the crew drinks plenty of fluids).
- Maintain a chronological flight log of all observations of note, including precise locations, sketches and any other noteworthy information
- Assist in completing the Debriefing section of a sortie in WMIRS
- Depending on conditions, attend the debriefing with the mission pilot
- Keep track of assigned supplies and equipment

Once team members have been briefed on the mission and accomplished the necessary planning, observers determine that all necessary equipment is aboard the airplane. Checklists help ensure that all essential equipment is included, and vary according to geographic location, climate, and terrain of the search area. Items on the observer's checklist should include CAP membership and specialty qualification cards, current charts and maps of the search area, flashlights, notebook and pencils, binoculars, and survival gear (prohibited items, such as firearms, should be listed too, to ensure none is included). A camera may be included to assist in describing the location and condition of the search objective or survivors. Unnecessary items or personal belongings should be left behind. The mission observer also assists the pilot in ensuring that all equipment aboard the search aircraft is properly stowed. An unsecured item can injure the crew or damage the aircraft in turbulence.

Once airborne, the observer provides navigation and communication assistance, allowing the pilot to precisely fly the aircraft with a greater degree of safety. The observer also assists in enforcing "sterile cockpit" rules when necessary. In flight, particularly the transit phase, the observer maintains situational awareness in order to help ensure crew safety.

The mission observer divides and assigns scanning responsibilities during her mission observer briefing, and ensures each scanner performs their assigned duty during flight. She monitors the duration of scanner activity, and enables the scanners to rest in order to minimize fatigue.

NOTE: Mission Observers are required to complete the CAP Aircraft Ground Handling Training as part of their Advanced Training. The link is located in the CAP Utilities column in eServices. Observers also must complete the **Introductory Communications User Training (ICUT)**; in the Learning Management System).

NOTE: Mission Observers should have completed the *Basic Risk Management* course during Mission Scanner qualification; in eServices, select the Safety Management System page, then select the "Online Safety Education" link and look for the Risk Management Courses.

1.2 The Observer Log

The observer must become proficient in using an in-flight navigational log. A complete chronological log should be maintained from take-off until landing, and should include all events and sightings. Skill in maintaining the log requires training and experience. Remember, *proficiency and confidence is gained through practice and application*.

It is important to log the geographical location of the search aircraft at the time of all events and sightings (as a habit, always log the Hobbs time each time you make a report or record an event or sighting). This information is used in the sortie debriefing, the results of which are passed back to the incident commander and general staff after the debriefing and becomes a part of the total information that is the basis for his subsequent actions and reports. Good logs give the staff a better picture of how the mission is progressing.

If sketches or maps are made to compliment a sighting, note this and attach them to the log. Maps and sketches may be uploaded into WMIRS.

A sample Observer Log (and instructions) and Search Area Work Sheets are included in Attachment 2, *Flight Guide*.

1.3 Forms

Some of the forms used by mission aircrew:

CAPF 101 (E), the Specialty Qualification Card, is used to identify mission-qualified personnel. This form is obtained through eServices. Each member is required to have a valid 101 card to participate in missions.

SQTR, *Specialty Qualification Training Records*, are available in eServices or can be issued by the unit commander to define and document training toward qualification in an ES specialty. Observers use the MS SQTR and SAR/DR Mission Pilots the MP SQTR.

CAPF 104 is the *Mission Flight Plan/Briefing Form*; which is filled out by section in WMIRS (*Web Mission Information Reporting System*). Mission staff or the Mission Pilot (MP) begin by adding the sortie in WMIRS (Air Sortie Add/Update); this provides basic information about the sortie. In preparation for the sortie briefing, mission staff and the MP enter more detailed information about the sortie (Air Sortie Brief) which is used during the sortie briefing. Finally, results of the sortie are entered (Air Sortie Debrief) by the MP or Observer, and discussed with mission staff during the sortie debriefing. Accurate mission logs, kept by the observer during the flight, provide vital information for the debriefing.

An FAA Flight Plan may be filed by the MP, and a CAP Aviation Operational Risk Management (ORM) Worksheet (in WMIRS) is always filled out by the aircrew to assist in determining the level of risk for a particular sortie. These forms, along with a Weight & Balance (uploaded into WMIRS), are completed during the Planning/Briefing sections of the sortie. [These forms, including the CAPF 104 in WMIRS, are covered in Chapters 9 & 10.]

The CAPF 108 is used to claim reimbursement for CAP missions IAW CAPR 173-3. Generally, fuel, oil, limited maintenance, and mission-essential communications expenses are covered by the tasking agency. This form is automatically generated in WMIRS for mission sorties.

1.3.1 Entering Data into Forms

The most basic rule for filling out forms is to enter data *accurately* (and *legibly* if using paper forms: if your handwriting is poor, print, and if your printing is poor, have another crewmember fill out the form).

CAP forms (.doc or .pdf) are available in electronic format (link from the CAP national website, eServices or WMIRS), and many are capable of performing necessary calculations and the like as you enter data. Most forms are filled out electronically, or transferred from paper copies used in the field. [If feasible, make templates of the forms you use the most: filling in data that doesn't change (e.g., local and aircraft information) and then using the SAVE AS feature each time you use the form will save you lots of time.]

Some general rules to follow are:

- Avoid the use of "Liquid Paper" when making corrections to any forms
- To correct mistakes draw a single line through the error and initial
- Do not use signature labels or stamped signatures
- Attach copies of all receipts that support expenses claimed on the CAPF 108 (most receipts are scanned and uploaded into WMIRS)
- Attachments (e.g., expense receipts or maps) should have your name, the date, aircraft 'N' number, mission and sortie numbers, and Hobbs time on them so they can be tied to the CAP form if they become separated
- Always have another crewmember review the form before submittal. If there are any blanks or 'N/A' entries, make sure that is what you intended.

2. Communications

Airmen use several means to communicate, whether they are flying, taxiing, or stranded after an accident. Aerial communication has grown from simple techniques of dropping messages from airplanes to the use of highly sophisticated transceivers. In order to fulfill communication responsibilities involving the aircraft radio, mission aircrew must study basic communication techniques that are applicable to general aviation. This chapter will discuss radio communication techniques, and examine other non-verbal communication methods that may be used when circumstances don't permit two-way radio use.

Some of the topics included in this chapter were covered in the Mission Scanner course. They are not included in the objectives but are reproduced here for review.

OBJECTIVES:

1. Describe how to use the Audio Panel and FM radio. {MO O-2002; MP O-2001}
2. Describe how to recognize a stuck mike, and corrective actions. {MO O-2002}
3. Discuss CAP FM radio reports, and list the minimum required reports. {MO O-2002; MP O-2001}
4. Review light gun signals and air-to-ground coordination. {MP O-2009}
5. Discuss in-flight services: {MO O-2010}
 - a. Flight Service Station purpose and how to contact
 - b. ATIS information and how to obtain it
 - c. AWOS/ASOS information and how to obtain it
 - d. The importance of PIREPs

2.1 Electronic Communications

The aircraft radio is the primary means of communication in aviation. To effectively use the radio, mission pilots and observers must be knowledgeable not only of *how* to communicate, but *when* communication is required during CAP missions. Observers may operate the aircraft communications radios in order to reduce pilot workload, and they use the FM radio to communicate with ground units. The techniques covered in this section were developed to improve clarity, to help keep communications transmissions brief, and as a means of giving words standardized meanings. Necessary communication should never be delayed while mentally searching for the appropriate terminology or phrase. If in doubt, always use plain language. Keep your radio transmissions clear, simple, and accurate, and practice using the radio so that you will be ready to go into action when the situation arises.

CAP FM radio frequencies are assigned to us by the Air Force and should be used properly. Other frequencies programmed into the CAP FM radio include police, fire, and other emergency departments or agencies. Follow the communications plan; if you hear others using the frequencies improperly, inform your communications officer.

Some aviation frequencies are designed for air-to-air communications and may be used by CAP aircraft (or any other general aviation aircraft). 123.1 is the official SAR frequency. 122.75 & 122.85 MHz are air-to-air communications frequencies (and for use by private airports not open to the general public). 122.90 MHz is the Multicom frequency; it *can* be used for search and rescue, *but* is also used for other activities of a temporary, seasonal or emergency nature (note, however, that it is also used by airports without a tower, FSS or UNICOM). Follow your communications plan, if applicable, and don't abuse these frequencies. Look at the sectional to see if 122.90 MHz is used by nearby airports, and always listen before you transmit.

2.1.1 Using the aircraft communications radio

To establish radio communications (a KX-155 is shown in Figure 2-1), first tune the communications radio to the frequency used by the clearance or ground station. Almost all general-aviation aircraft transmitters and receivers operate in the VHF frequency range 118.0 MHz to 136.975 MHz. Civil Air Patrol aircraft normally have 720-channel radios, and the desired frequency is selected by rotating the frequency select knobs until that frequency appears in the light-emitting diode display, liquid crystal display, or other digital frequency readout or window.



Figure 2-1

The 720-channel radios are normally tuned in increments of 50 kilocycles (e.g., 119.75 or 120.00). They can be tuned in increments of 25 kilocycles (e.g., 119.775)

pulling out on the tuning knob, but the last digit of the frequency will not be shown in the display (e.g., 119.775 will be displayed as 119.77). [Sometimes, for brevity, air traffic controllers assign such frequencies as "one-one nine point seven seven," meaning 119.775, not 119.770. The operator cannot physically tune the radio to 119.770, and this may be confusing.]

Before transmitting, first *listen* to the selected frequency. An untimely transmission can "step on" another transmission from either another airplane or ground facility, so that *all* the transmissions are garbled. Many pilots have been violated for not complying with instructions that, it was later determined, had been blocked or "stepped on" by another transmission. Next, mentally prepare your message so that the transmission flows naturally without unnecessary pauses and breaks (remember "Who, Where and What"). You may even find it helpful to jot down what you want to say before beginning the transmission. When you first begin using the radio, you may find abbreviated notes to be a convenient means of collecting thoughts with the proper terminology. As your experience level grows, you may find it no longer necessary to prepare using written notes.

Some radios have a design limitation that causes a slight delay from the instant the microphone is "keyed" until the radio actually starts transmitting. If you begin to speak before the radio has actually started to transmit, the first few syllables of the transmission will be lost. Until you become familiar with the characteristics of the individual radio, you may find it desirable to make a slight pause between keying the microphone and beginning to speak. When you are prepared to transmit, place the microphone close to your mouth and speak in a normal voice.

Call Signs

CAP aircraft have been authorized to use FAA call signs, just like the major airlines and commuter air carriers. This helps differentiate us from civil aircraft, air taxis, and many other commercial aircraft. Our FAA authorized call sign is "CAP XX XX," where the numbers are those assigned to each Wing's aircraft. *The numbers are stated in 'group' form.* For example, the C172 assigned to Amarillo, Texas is numbered 4239, where 42 is the prefix identifying it as a Texas Wing aircraft. The call sign is thus pronounced "CAP Forty-Two Thirty-Nine." It is important to use the group form of pronunciation because FAA air traffic controllers expect it of us. [NOTE: Wing or region commanders may approve the aircraft tail number as a call sign when an external "customer" has specifically requested it.]

The initial transmission to a station starts with the name of the station you're calling (e.g., Amarillo Ground), followed by your aircraft call sign. You almost always identify yourself using your aircraft's CAP call sign designation. Once you've identified the facility and yourself, state your position (e.g., "at the ramp") and then make your request.

CAP aircraft should use the word "Rescue" in their call sign when priority handling is *critical*. From the example above, this would be "Rescue CAP Forty-Two Thirty-Nine." DO NOT abuse the use of this code; it should only be used when you are on a critical mission *and* you need priority handling. NEVER use the word "rescue" during training, exercises or drills.

2.1.2 Using the aircraft audio panel

The audio panel serves as the "hub" for the aircraft's communication and navaid equipment. Whatever type of audio panel is installed in the aircraft, it serves two basic functions:

- Selecting the 'active' radio (COM 1, COM 2, etc.). This is the radio over which you will transmit when you use the push-to-talk switch or the hand mike.
- Allows communication and navigational instruments to be directed to the aircraft's overhead speaker or to the headphones

The position of the switch and the pushbuttons on the audio panel should be checked as part of each preflight. There is no set rules on how they should be set, and settings may vary according to the mission and the airspace you will be flying in. *The important thing is to realize how the panel is set up so that your equipment will function as you need and expect them to function.*

There are several types of audio panels installed in CAP aircraft: the older type is the King KMA-24 (Figure 2-2) and the newest type is the PMA7000MS (Figure 2-3). [Note: Both have controls and indicators on the left-hand side (MKR or Marker) that are associated with instrument approaches, and will not be covered here.]

KMA-24

One of the most common older audio panels, the KMA-24 is still found in many CAP aircraft. The switch on the right-hand portion of the panel determines which radio you will transmit on; also, if none of the pushbuttons are depressed, the switch setting (e.g., COM 1) determines which radio you are listening to. The pushbuttons are arranged in two rows: the upper row is associated with the aircraft's overhead speaker, and depressing these pushbuttons will direct their associated equipment to the speaker (e.g., press the ADF pushbutton and the ADF will be heard on the speaker); the bottom row is associated with the headphones and serves the same function.

Depressing a pushbutton on the panel routes the signal from the associated instrument (e.g., a com radio or the ADF) to the speaker or to your headphones, *regardless* of the setting on the COM switch. This comes in handy when you want to monitor two frequencies at the same time. For example, you have Center on the #1 radio and the COM switch in the COM 1 position. You will be flying near a local airport and want to listen to its CTAF. Set the CTAF in the #2 radio and depress the COM 2 PHONE pushbutton. You will now be able to hear both frequencies, but still will only be able to transmit on Center frequency.

The CAP FM radio is usually routed through the TEL pushbuttons, and the DF unit is often routed through the ADF pushbuttons.



Figure 2-2

The two most common mistakes made with this type of audio panel include: transmitting on the wrong frequency because you set the desired frequency in one radio but failed to select the corresponding COM channel; and failing to hear a message over the FM radio because you failed to depress the appropriate pushbutton (usually the TEL pushbutton) to direct the call to the overhead speaker or headphones.

PMA7000MS

The PMA7000MS (Figure 4-3) is CAP's newest audio panel, and is installed in conjunction with the new FM radio (TDFM-136). This audio panel was custom-designed to meet CAP SAR operational requirements. In addition to normal audio panel functions, this unit contains an automatic voice-activated (VOX) stereo intercom system with automatic squelch control.



Figure 2-3

Refer to Figure 2-4. Unit power is turned on and off by pushing the Volume knob. In the Off (or Fail-Safe) position the pilot is connected directly to Com 1 to allow communication capability regardless of unit condition (any time power is removed or turned off the audio selector will be placed in the fail-safe mode). The power switch also controls the audio selector panel functions, intercom, and marker beacon receiver.

The Volume control knob adjusts the loudness of the intercom for the pilot and copilot only; it has no effect on selected radio levels, music input levels or passengers' volume level. Adjust the radios and intercom volume for a comfortable listening level for the pilot. [Most general aviation headsets today have built-in volume controls; therefore, passenger volume can be adjusted on the headset.] For best performance your headset microphone must be placed within ¼ inch of your lips, preferably against them. It is also a good idea to keep the microphone out of a direct wind path.

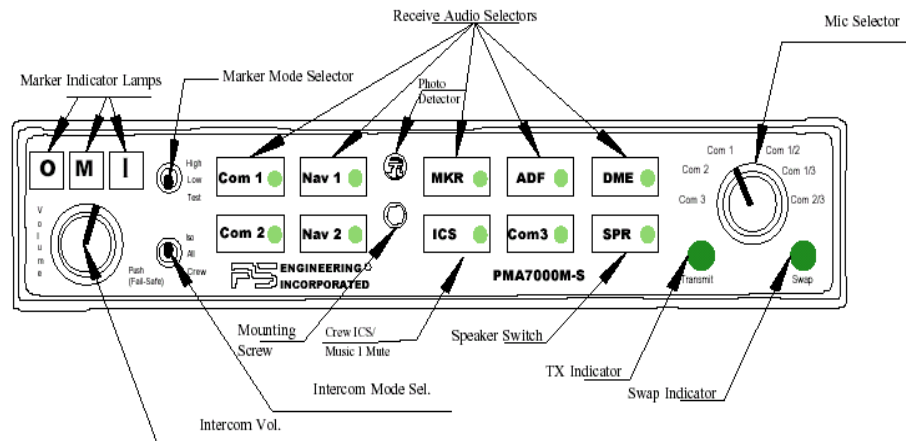

Figure 2-4

Mic Selector switch and receiver switches. Receiver audio is selected through two momentary and six latched, push-button, backlit switches. Because the rotary Mic (microphone) Selector switch controls what transceiver is being heard, the Com 1 and Com 2 push-buttons are of the momentary type and do not remain in when selected. Because of this, you will always hear the audio from the transceiver that is selected for transmit by the rotary Mic Selector switch (in other words, you can't transmit without listening to the receiver). You can identify which receivers are

selected by noting which of the switch LEDs are illuminated. Push buttons labeled Nav 1, Nav 2, COM 3, DME, MKR (Marker), ADF and SPR (Speaker) are "latched" type switches. When one of these buttons is pressed, it will stay in the "in" position; press the switch again and it will be in the "out" position and remove that receiver from the audio. When selected, the SPR button will place all selected audio on the aircraft's overhead speaker (Note: the speaker amplifier is not active in the split mode).

When the Mic Selector switch is in the Com 1 position, both pilot and copilot will be connected to the Com 1 transceiver. Only the person that presses their Push-to-Talk (PTT) will be heard over the aircraft radio. Turning the rotary switch to the Com 2 position will place pilot and copilot on the Com 2 transceiver. The PMA7000MS gives priority to the pilot's PTT; if the copilot is transmitting and the pilot presses her PTT, the pilot's microphone will be heard over the selected transmitter. In Com 3, both pilot and copilot are using the CAP FM radio.

Split Mode. Turning the rotary switch to Com 1/2 places the PMA7000MS into "Split Mode." This places the pilot on Com 1 and the copilot on the Com 2 transceiver. An example of this useful feature is when the pilot may want to talk to Air Traffic Control while the copilot/observer is checking weather with Flight Watch. Switching to Com 1/3, the pilot will be on Com 1 and the copilot will be on Com 3 (the FM radio). In Com 2/3, the pilot is on Com 2 and the copilot on Com 3. [Note: *In split mode the pilot and copilot are usually isolated from each other on the intercom, simultaneously using their respective radios. Depressing the ICS button in split mode will activate VOX intercom between the pilot and copilot positions; this permits intercommunication when desired between the crew. Pressing the ICS button again disables this crew intercom function.*]

Note: The pilot can always listen to the other frequencies by pressing the appropriate push button (e.g., Com 2 or Com 3); this doesn't allow transmitting.

The com antennas are normally mounted on top of the aircraft in close proximity to one another. As a result, if the pilot and copilot are transmitting simultaneously (e.g., Com 1/2) and the frequencies are close together, there may be some "bleed over." This is usually not a problem when one of the persons is using the FM radio (e.g., Com 1/3 or 2/3)

Swap Mode. With an *optional yoke-mounted switch*, the pilot can change from the current Com transceiver to the other. This "Swap Mode" can be used to reverse transceiver selection in the split mode.

The table below summarizes the transmitter combinations:

Mic Selector	Normal		Swap	
	Pilot	Copilot	Pilot	Copilot
Com 1	Com 1	Com 1	Com 2	Com 2
Com 2	Com 2	Com 2	Com 1	Com 1
Com 3	Com 3	Com 3	No Swap	No Swap
Com 1/2	Com 1	Com 2	Com 2	Com 1
Com 1/3	Com 1	Com 3	Com 3	Com 1
Com 2/3	Com 2	Com 3	Com 3	Com 2

Intercom Mode. A 3-position toggle switch ("Intercom Mode Sel." in Figure 4-3) allows the pilot to tailor the intercom function to best meet the current cockpit situation. The following description of the intercom mode function is valid only when the unit is not in the "Split" mode (as mentioned before, the pilot and copilot intercom is controlled with the ICS button when in the split mode).

- **ISO** (up position): The pilot is isolated from the intercom and is connected only to the aircraft radio system. She will hear the aircraft radio reception (and side tone during radio transmissions). The copilot/observer will hear the passengers' intercom and the back seat scanners will hear the copilot's intercom; neither will hear aircraft radio receptions or pilot transmissions.
- **ALL** (middle position): All parties will hear the aircraft radio and intercom
- **CREW** (down position): The pilot and copilot/observer are connected on one intercom channel and have exclusive access to the aircraft radios. Back seat scanners can continue to communicate with themselves without interrupting the pilot or copilot.

The following table summarizes the intercom modes:

Mode	Pilot Hears	Copilot Hears	Passengers Hear	Comments
Isolate	A/C Radios Pilot Sidetone (during radio transmission) Entertainment 1 is Muted	Copilot and passenger intercom Entertainment #1	Passenger and Copilot intercom Entertainment #2	This mode allows the pilot to communicate without the others bothered by the conversations. Copilot and passengers can continue to communicate and listen to music
All	Pilot Copilot A/C Radio Passengers Entertainment #1	Copilot Pilot A/C Radio Passengers Entertainment #1	Passengers Pilot Copilot A/C Radio Entertainment #2	This mode allows all on board to hear radio reception as well as communicate on the intercom. Music and intercom is muted during intercom and radio communications
Crew	Pilot Copilot A/C Radio Entertainment #1	Copilot Pilot A/C Radio Entertainment #1	Passengers Entertainment #2	This mode allows the pilot and copilot to concentrate on flying, while the passengers can communicate amongst themselves.

Because improper setup of the audio panel can lead to confusion and missed radio calls, *do not reposition the switch or any of the pushbuttons without consulting with the Pilot-in-Command!*

2.1.3 Using the VHF FM radio

CAP has authorization to use special frequencies in order to communicate with government agencies and to our own ground forces. For this purpose CAP aircraft have an FM radio that is separate from the aviation com radios.

This radio is dedicated to air-to-ground communications, and is normally operated by the observer or scanner. Several of the frequencies programmed into the radio are frequencies assigned to CAP by the U.S. Air Force, and are used to communicate with CAP bases and ground teams. Others are programmed at the direction of the Wing Communications Officer (e.g., mutual aid, fire, police, park service, forest service, and department of public service); these frequencies almost

always require prior permission from the controlling agency before use. All frequencies are known by the designators only: **do not release the actual frequencies in writing or over the radio (OPSEC)!**

CAP is replacing the Yaesu and NAT NPX138 radios (see Attachment 2 for an NPX138 operations guide or visit <https://ntc.cap.af.mil/comm>). The TDFM-136 will be discussed here; its operating manual can be obtained at various sites (*Google*). The new PMA7000MS audio panel is designed to work with the TDFM-136.



Figure 2-5

The TDFM-136 (Figure 2-5) is a P25-compliant airborne transceiver capable of operating in the 136 MHz to 174 MHz range (digital or analog) in 2.5 KHz increments. It can have up to 200 operator-accessible memory positions, each capable of storing a receive frequency, a transmit frequency, a separate tone for each receive and transmit frequency, an alphanumeric identifier for each channel, and coded squelch information for each channel. The FM Radio is selected using Com 3 on the Audio Panel; it is also directly accessed using the Push-to-Talk toggle switch located in an armrest by the rear seat of the aircraft.

Data can be entered via the 12-button keypad but is normally downloaded from a PC (this function is normally restricted to communications officers). Operating frequencies, alphanumeric identifiers and other related data are presented on a 96-character, four-line LED matrix display. It is capable of feedback encryption.

National and wing communications officers program the radios (Guard 1 and Guard 2 are preset). So, all you will have to know is how to *use* the radio.

The radio also has a scan function that can scan any or all of the main channels stored in the preset scan lists; scan lists, if enabled, are set by the wing communications officer.

As shown in Figure 2-5, the radio simultaneously displays two frequencies. The upper line is the Main (MN) frequency and the lower is the Guard (GD) frequency. Normally, you will be set up to transmit and receive on the Main and be able to receive the Guard frequency. This feature allows mission base to contact you at any time (via Guard), no matter what frequency you are using on Main. [Note: "Guard" is restricted to calling *only*; after making contact on this channel, stations must change to a different channel to conduct their business. Only in an actual emergency directly involving one of the stations may this channel be used for ongoing communications.]

Controls and normal settings:

- The knob above the MN/GD switch is the power switch and controls volume for Main. The knob above the G1/G2 switch is the volume control for Guard.
- The "Squelch" pushbutton is not used (automatic squelch). Don't push it.
- The MN/GD toggle switch selects the frequency on which you will transmit *and* receive. It is normally set to MN.
- The G1/G2 toggle switch selects the Guard frequency you are *monitoring*. It is currently set to G1
- The HI/LO toggle switch selects transmitter power (10 watts or 1 watt). It is normally set to HI.

Keypad operation:

- Pressing and holding "4" (Scroll Memory Down) will let you scroll down through the programmed memories (it wraps around). Upon reaching the desired entry, release the button. "6" (Scroll Memory Up) lets you scroll up. [Note: scroll speed increases the longer you hold the buttons.]
- Pressing "5" (Scan) lets you select a scan list to scan, and to start or stop the scan. Once the scan list you want is displayed press # ENTER to start the scan or press * ESC to stop the scan. [Note: this function must be enabled by the wing communications officer for it to work.]
- Pressing and holding "2" (Display - Brighter) will increase display brightness; "8" (Display - Dimmer) decreases brightness.

When you get in the aircraft and power up the radio, it should be set to MN, G1 and HI. Use pushbutton 4 or 6 to select the assigned Main frequency. The second line should display the Guard frequency.

As another example, let's say you are working with the U.S. Forest Service and have their frequency on Main. Mission base briefed you to guard G1, and now calls you for your "Operations Normal" report. You will hear mission base over Guard 1, regardless of what is coming over the Main frequency. You now simply move the MN/GD switch down to GD and answer "Ops Normal," and then return the switch to MN and carry on with the mission.

2.1.4 Stuck mike

Occasionally, the transmit button on aircraft radio microphones gets stuck in the transmit position, resulting in a condition commonly referred to as a "stuck mike." This allows comments and conversation to be unintentionally broadcast. Worse yet, it also has the effect of blocking all other transmissions on that frequency, effectively making the frequency useless for communication by anyone within range of the offending radio. You may suspect a stuck mike when, for no apparent reason, you do not receive replies to your transmissions, especially when more than one frequency has been involved. You may notice that the 'T' (transmit symbol) is constantly displayed on your communications radio and, in the case of the PMA7000MS audio panel, the transmit (TX) light in the lower right-hand corner is on continuously. You may notice a different sound quality to the background silence of the intercom versus the noise heard when the microphone is keyed but no one is talking. Often the problem can be corrected by momentarily re-keying the microphone. If receiver operation is restored, a sticking microphone button is quite likely the problem.

2.1.5 CAP FM radio reports

As a minimum, the aircrew must report the following to mission base:

- FM Radio check (initial flight of the day)
- Take off time
- Time entering a search area (may be multiple times)
- Time exiting a search area (may be multiple times)
- Landing time
- Operations normal ("Ops Normal"), at intervals briefed by mission staff (usually every 30 minutes)

2.2 Non-verbal communication

While you are on a mission, nonverbal signals may be the only available method of communication with a crash survivor or with ground teams. Mission aircrews may have to interpret these nonverbal messages and must be able to do so accurately regardless of the method used.

2.2.1 Light gun signals

If the radio in your aircraft fails, it is still very important for you to follow instructions from the tower at a controlled airport. In this case, you may have to rely on light gun signals from the control tower in order to receive the necessary landing and taxi clearances previously described. These clearance requirements still apply despite an inoperative radio. Table 2-4 shows each light gun signal, followed by its meaning.

Color and Type of Signal	On the Ground	In Flight
Steady Green	Cleared for takeoff	Cleared to land
Flashing Green	Cleared to taxi	Return for landing
Steady Red	Stop	Give way to other aircraft and continue circling
Flashing Red	Taxi clear of runway area	Airport unsafe—Do not land
Flashing White	Return to starting place on airport	Not applicable
Alternating Red and Green	General warning — exercise extreme caution	

Table 2-4

2.2.2 Air-to-ground signals

Communicating by radio is the basic air-to-ground communication method. If this isn't possible for any reason, the pilot has a limited number of signals that can be given using the aircraft itself, as illustrated in Figure 2-6. These signals serve as a standard means to acknowledge receiving and understanding signals from the ground. An "affirmative, I understand" response to a survivor's signal can often be a morale booster, and renew hope for imminent rescue.

In addition to the four signals shown in Figure 2-6, there are two more that aircrews use to communicate with ground rescue teams. First, if the crew believes a ground team should investigate an area, the pilot may fly over the team, "race"

the engine or engines, and then fly in the direction the team should go. The pilot may repeat this maneuver until the ground team responds or until another means of communication is established.

Second, you may pinpoint an area for investigation by circling above the area, continuing to do so until the ground team reaches the area and begins the search. The better the communication from ground-to-air and air-to-ground, the more coordinated the search will be and the greater the chances for success.

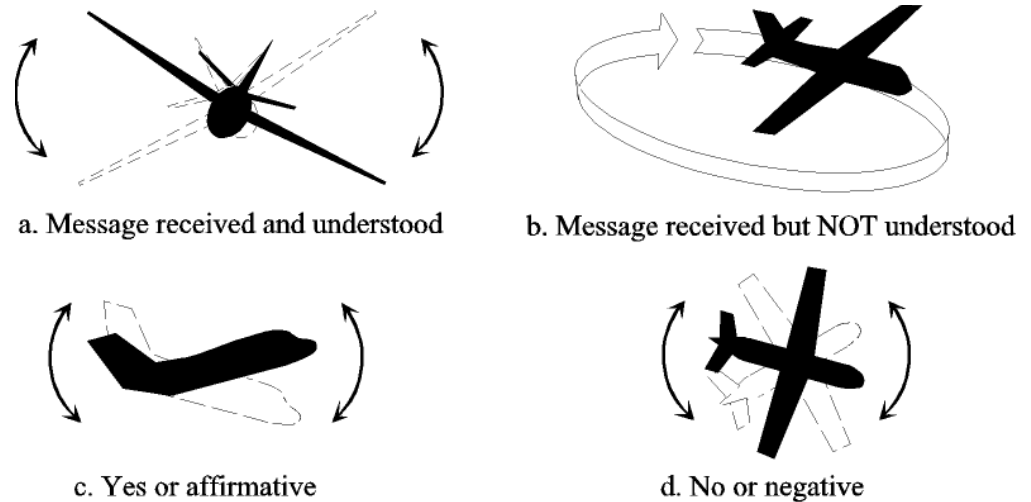

Figure 2-6

2.2.3 Air-to-ground team coordination

The basic plan for a combined air and ground team search is that the aircrew locates the objective and then guides the ground team to the objective. It sounds simple, but there are several factors to consider.

As an aircrew member, it is important to understand that you have the advantage of perspective; the long-range visibility that is inherent to flying is absent from the ground. You can see over the hills, trees, and other obstacles that are blocking the ground team member's sight, so you may have to explain the situation to the ground pounder in painstaking detail.

Another perspective problem is time: time seems to pass very slowly while waiting for a ground team, and it is easy to get impatient and leave station prematurely.

Naturally, the best means of working with a ground team is to use the radio. However, communications difficulties are par for the course. This gives you additional incentive to practice directing and working with ground teams.

Sometimes the ground team member (non-CAP, of course) may not understand radio jargon, so use plain English. For example, if you wanted a ground team to take a left at the next intersection, what would you say? How about "Ground Team 1, CAP 4239, turn left at the next intersection, over." Most often the plain English answer is the correct way to say it in "radioese," anyway.

Someone in the aircrew (often the back seat scanner) should continuously have his or her eyes on the ground team; this frees the pilot to fly the aircraft and allows

the observer to work the radio to execute the coordination. The observer will likely also have to be the one who keeps track of where you “left” your target.

After these tasks are delegated, the observer simply talks the ground team to the target. What could be easier? Well, of course there are additional factors to consider.

First of all, how do we get the aircrew and the ground team together in the first place? You will often find that a poorly conducted rendezvous with the ground team will result in a frustrating “search for the searchers.” It is important to brief the mission with the ground team, if possible, and at least agree on communications frequencies and lost-com procedures, maps/charts to be used by *both* teams, determine what vehicle the ground team is driving (e.g., type, color, and any markings), determine what the ground team members are wearing (highly visible vests are preferred), and a rendezvous point and time window for rendezvous (+/- 15 minutes).

One tried-and-true method is to rendezvous at a landmark that both the aircrew and the ground team can *easily* identify. A common rendezvous point is an intersection of prominent roads; these are easily identifiable by both the aircrew and ground team. The rendezvous location should be set up before you leave mission base.

Also, ground teams that have a hand-held GPS can radio their latitude and longitude coordinates to you and say, “Come and get me!” If you are unable to loiter over the target and bring the ground team to it, you can simply radio the coordinates to the ground team and let them navigate to it on their own. This is not nearly as efficient, however, as when you lead them to it. Note that two pieces of technology have to be working properly to make this work: 1) both air and ground operators need to be proficient with their GPS units and 2) two-way radio communication must be established and maintained.

After visual contact with the ground team, the pilot may use flaps to reduce groundspeed. If you lose radio communication, you can use the signals as listed below. However, these signals may be used as a standard to be followed *in addition to two-way radio communication* for additional clarity and practice. Allow plenty of room for your maneuvers or you may confuse the ground team and do not rush your signals.

Note: It is important to plan for a loss of communications during the briefing. The teams should agree on pre-arranged signals such as: stopping the vehicle means lost com; blinking headlights indicate the message has been received; and operating the flashers means the message hasn't been received.

Keeping contact with the ground team.

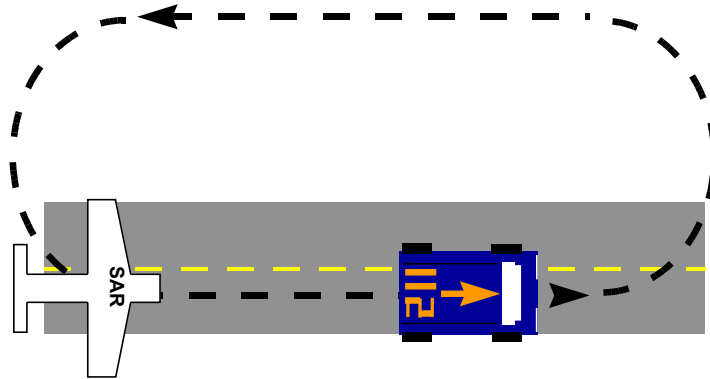

- Aircraft action: Aircraft approaches the vehicle from the rear and turns in a normal manner right (or left) to re-approach the vehicle from the rear. Circle back as necessary using oval patterns and flying over the team from behind, indicating that they should continue. This process may be referred to as a "Daisy Chain." Daisy Chain over the ground team as long as necessary.
- Desired team action: Continue driving in indicated direction along this road

Turning the ground team around.

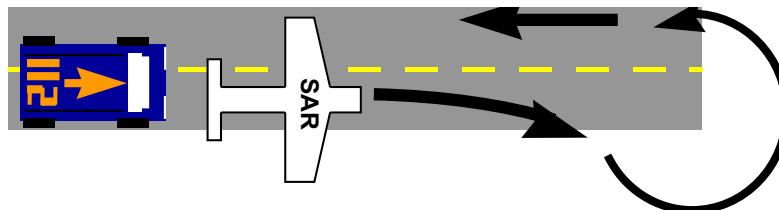

- Aircraft action: Aircraft approaches the vehicle from the rear and then turns sharply right (or left) in front of the vehicle while in motion. Circle back as necessary, flying against the team's direction of travel, and then take up the 'keeping up' procedure outlined above.
- Desired team action: Turn vehicle around

Turn.

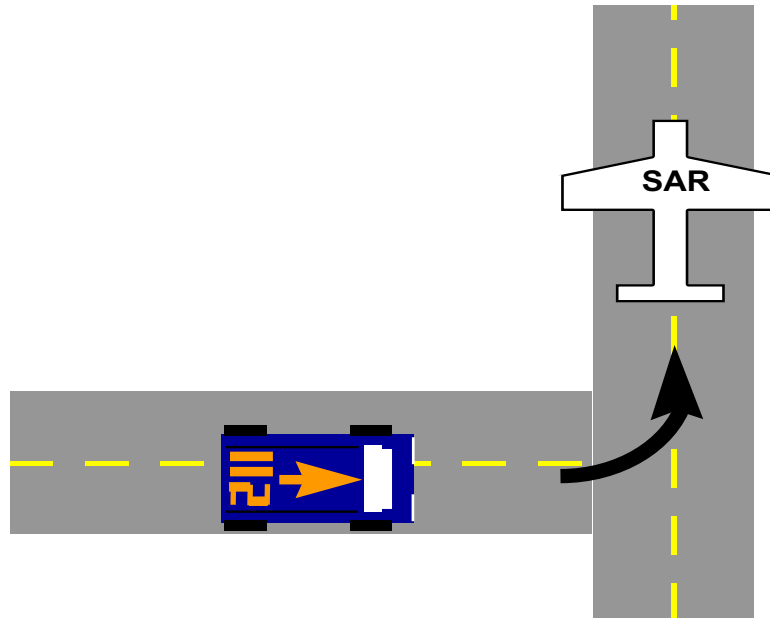

- Aircraft action: Aircraft approaches the vehicle from the rear and then turns sharply right (or left) in front of the vehicle while in motion. Circle back as necessary using oval patterns and flying over the team from behind, indicating that they should continue.
- Desired team action: Turn vehicle to right (or left) at the same spot the aircraft did and then continue in that direction until further signals are received

Stop or Dismount.

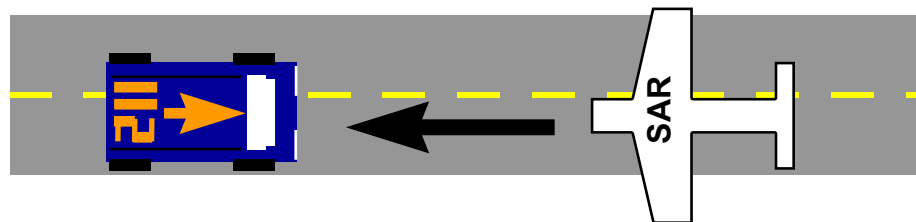

- Aircraft action: Aircraft approaches the vehicle low and head-on while the vehicle is moving
- Desired team action: Stop the vehicle and await further instructions
- Aircraft action: Aircraft makes two (or more) passes in same direction over a stopped ground team
- Desired team action: Get out of the vehicle, then follow the aircraft and obey further signals (proceed on foot)

Objective is here.

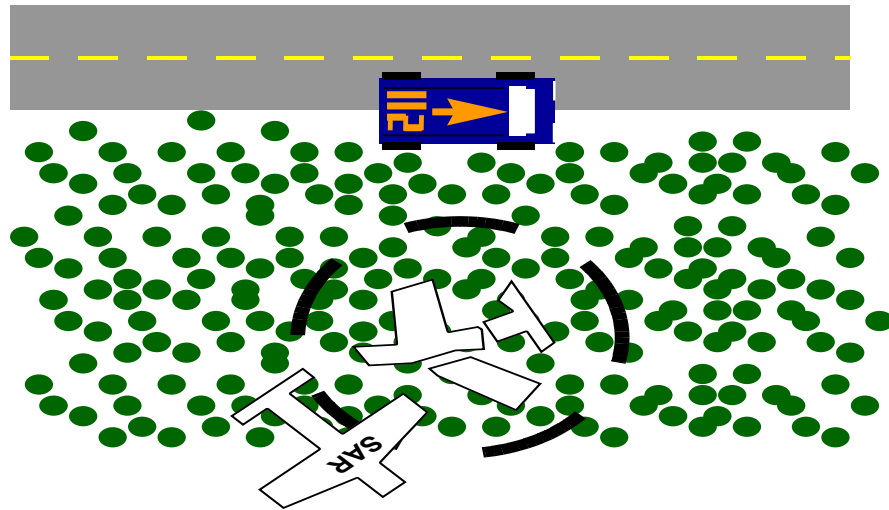

- Aircraft action: Aircraft circles one geographic place
- Desired team action: Proceed to the location where the low wing of the aircraft is pointing; that is the location of the target

Remember: Air-to-ground coordination is an art that should be regularly practiced, both during daylight and at night.

2.2.4 Airdrops

Airdrops are an uncommon event. As such, they should be trained and practiced before attempting. Follow FAA rules when training for airdrops.

Dropping objects from a CAP aircraft is only authorized to prevent loss of life.

The ability to drop a message or emergency equipment such as a radio or medicine is a valuable skill. An airdrop is not inherently dangerous. Being familiar with this procedure will allow an aircrew to conduct an airdrop safely.

An airdrop offers an alternative way of communicating with someone (e.g., a survivor or a trapped fire crew) on the ground. Your message needs to be clear and concise, and you should always spell out what kind of response you expect so that you will know your message was received and understood. For example, "if you need medical assistance, lay flat on the ground," or "help is on the way and will arrive in three hours; wave your arms if you understand."

The message airdrop should be a light object that is safe to drop, and an equipment airdrop should be a small, padded bag. You should attach a roll of brightly colored tape (e.g., a roll of florescent surveyor's tape) to the airdrop; the tape will unroll and provide a trail to the airdrop in case it lands in a tree, brush or snow.

Some safety concerns for the pilot are:

- Fly the aircraft and don't worry about what the observer is doing
- Do not pull back hard on the yoke or go negative 'G' after the release, because this could cause the airdrop to hit the tail

- Don't look back after the drop to see where the airdrop landed. Looking over your shoulder could cause you to pitch up. This could lead to a roll and then to a stall/spin.

Configure the aircraft with 10° flaps and a speed of 80 knots. Fly a right-turn pattern (assuming the airdrop will be through the right window) at 1000 AGL and aligned so that final will be into the wind. Make the base turn so that you will have a two-mile final to the drop point. Descend to approximately 1000 AGL and open the window (preferably, the observer's window).

While on the drop run the observer can assist in directing the pilot, particularly during the turns. If any crewmember sees an unsafe condition, call "No drop, No drop, No drop" and the pilot will level out and begin climbing to a safe altitude.

When the drop point is under the wheel, release the tape. Pause momentarily and then release the airdrop (delay one or two seconds if it's an equipment drop). This ensures that the forward motion will carry the airdrop past the survivor and not hit them.

After the drop, climb to a safe altitude and continue to circle until you confirm receipt of the message or equipment.

2.3 In-flight services

Whether you are participating in a training exercise or an actual mission, the aircraft radio is an invaluable piece of equipment. Therefore, an understanding of the basic types of services that are provided through the radio is essential for mission observers.

2.3.1 Flight Service Stations

The FAA maintains a number of Flight Service Stations (FSS) that can provide assistance both before and after takeoff. Assistance includes preflight and in-flight briefings, scheduled and unscheduled weather broadcasts, and weather advisories. Selected FSS provide transcribed weather briefings.

Enroute weather information can be obtained from the Enroute Flight Advisory Service ("Flight Watch") by tuning 122.0 into the radio and calling "Flight Watch." It mainly provides actual weather and thunderstorms along your route. Additionally, Flight Watch is the focal point for rapid receipt and dissemination of pilot reports (PIREP'S). Other flight service frequencies are indicated on the sectional charts.

Flight service station personnel are also familiar with the general operating areas surrounding their respective facilities, and can be helpful in determining a pilot's position, should he become lost or disoriented. FSS personnel are also trained to help lost pilots establish their positions by VOR triangulation, and direction finding. These "lost pilot" services are to be used by pilots or crews who are genuinely lost, not those who are momentarily uncertain of their positions.

2.3.2 Transcribed Weather Broadcasts (TWEBs)

The TWEB is a continuous broadcast on low/medium frequencies (200-415 kHz) and selected VORs. Broadcasts are made from a series of tape recordings and are updated as changes occur. The information varies from one station to the next, but usually includes at least the following:

- Synopsis
- Flight precautions
- Route forecasts
- Outlook (optional)
- Winds aloft forecast

TWEBs generally are route oriented and give *area* surface weather reports, radar and pilot reports, and Notices to Airmen (NOTAMs). In most cases, you must listen to TWEBs on the VOR or ADF receiver.

2.3.3 Scheduled Weather Broadcasts

All flight service stations having voice facilities on radio ranges (VOR) or radio beacons (NDB) broadcast weather reports and Notice to Airmen information at 15 minutes past each hour from reporting points within approximately 150 miles of the broadcast station.

At each station, the material is scheduled for broadcast as available in this order:

- Alert notice announcement
- Hourly weather reports
- Weather advisory
- Pilot reports
- Radar reports
- Notice to Airmen (NOTAMS)
- Alert notice

Special weather reports and some notices to airmen data are broadcast off-schedule, immediately upon receipt. If you need special forecast service en route, you may obtain it from any flight service station. The time of observation of weather reports included in scheduled broadcasts is understood to be 58 minutes past the hour preceding the broadcast. When the time of observation is otherwise, the observation time is given.

Scheduled weather broadcasts (15 minutes past each hour) begin with the announcement "Aviation broadcast, weather." For example:

"Aviation broadcast, Weather, Oklahoma City. Oklahoma City Wiley Post measured ceiling one thousand broken, visibility two, fog, temperature four three, dew point four one, wind one niner zero degrees at four, altimeter two niner eight seven." The completed broadcast is ended with "The time is one eight and one quarter."

Reports for approximately 10 additional stations may follow. The local report is repeated as the last station report. Temperature is not broadcast, for other than the local report, when it is 40 degrees or less, or 85 degrees or higher.

When the temperature/dew point spread is five degrees or less, both the temperature and dew point are given. Surface wind direction and speed is given when it is ten knots or more (sustained). For this station, wind directions are magnetic, that is, measured from magnetic north rather than true north. The altimeter setting is given for the broadcast stations local report only. Special weather reports and advisories are broadcast when warranted by significant changes in the weather at a particular station or in a given area.

2.3.4 Automatic Terminal Information Service (ATIS)

At many airports, the FAA dedicates one or more transmitters and frequencies to continuous taped broadcasts of weather observations, special instructions, and NOTAMS that relate to the airport or nearby navigational facilities. ATIS tapes are intended to relieve air traffic controllers of repetitively transmitting the same data to every arriving and departing aircraft. Broadcast weather information is about *actual* observations for the smaller, terminal area, not forecasts. ATIS information is also digitized and may be received in a printed format if your aircraft is equipped with a special receiver and printer.

ATIS information is updated *hourly*, but may be updated sooner if the weather, special instructions or NOTAMS change significantly. Usually, you must listen to ATIS recordings on the communication radio. The frequency for the ATIS transmission is found on the sectional chart near the airport's name, or in a table on the reverse side of the sectional title panel. A typical ATIS transmission may sound like this:

"Atlanta Hartsfield Airport arrival information November. 2350 Zulu weather -- measured ceiling 800 overcast 1 1/2 miles in fog and haze. Temperature 61 degrees, dew point 60 degrees, wind calm, altimeter 29.80. ILS approaches in progress to Runways 8 Left and 9 Right. Landing runways 8 Left and 9 Right. Atlanta VOR out of service. Taxiway Mike closed between taxiways Delta and Sierra. Read back all 'hold short' instructions. Advise controller on initial contact you have information 'November'."

Even though you may not intend to stop at Hartsfield, this transmission contains bits of information that may have a significant bearing on your flight. The last weather observation, including the wind, and the fact that the VOR is out of service could be very important to you. If you had any intention of using the Atlanta VOR for navigation assistance on your mission, you now know to make a different plan.

If you are conducting a search under visual flight rules that will take you in the vicinity of Hartsfield, you know to consider a new plan because the reported weather will not allow VFR flight. When cloud bases are more than 5,000 feet above the terrain and visibility is better than five miles, those portions of the weather observation may often be deleted from the broadcast.

2.3.5 In-Flight Weather Broadcasts

When Flight Service receives severe weather forecast alerts from the National Weather Service, specialists transmit the alerts immediately and then again at each hour, half-hour, and quarter-hour for the first hour after the alert was first issued. The air traffic control centers also transmit the alert, but only once. Subsequent broadcasts may advise pilots to contact Flight Service to receive the alert text.

Alerts include SIGMETs (conditions that could be dangerous to all aircraft), Convective SIGMETs (conditions associated with thunderstorms, such as tornadoes or large hail, that could be dangerous to all aircraft; issued at 55 minutes past the hour or as needed), and AIRMETs (hazards primarily dangerous to small aircraft; issued every six hours or as needed).

2.3.6 Hazardous In-Flight Weather Advisory Service (HIWAS)

You can also receive advisories of hazardous weather on many VORs. As the HIWAS name implies, this information relates only to hazardous weather, such as tornadoes, thunderstorms, or high winds. If no hazardous weather is reported, the

crewmember will only hear the facility's identifier. Navaids having HIWAS broadcast capability are annotated on the sectional chart. When receiving a hazardous weather report, ATC or FSS facilities initiate the taped HIWAS transmissions, and ATC then directs all aircraft to monitor HIWAS.

2.3.7 Automated Weather Observation System (AWOS)

At many airports, the FAA has installed Automated Weather Observation Systems. Each system consists of sensors, a computer-generated voice capability, and a transmitter. Information provided by AWOS varies depending upon the complexity of the sensors installed. Airports having AWOS are indicated on sectional charts by the letters AWOS adjacent to the airport name, and the level of information is indicated by a single digit suffix, as shown below.

AWOS-A	Altimeter setting only
AWOS-1	Altimeter, surface wind, temperature, dew point, density altitude
AWOS-2	Altimeter, surface wind, temperature, dew point, density altitude, visibility
AWOS-3	Altimeter, surface wind, temperature, dew point, density altitude, visibility, clouds/ceiling data

2.3.8 Automated Surface Observing System (ASOS)

The primary surface weather observing system in the U.S., the FAA has installed hundreds of ASOS (www.faa.gov/airports_airtraffic/weather/asos). Each system consists of sensors, a computer-generated voice capability, and a transmitter. Information provided by ASOS varies depending upon the complexity of the sensors installed. ASOS can be heard by telephone, and so is very useful in flight planning. Information includes: wind speed, direction and gusts; visibility and cloud height; temperature and dew point; altimeter setting and density altitude.

2.3.9 Pilot Weather Report (PIREP)

Federal Aviation Administration stations are required to solicit and collect pilot reports (PIREPs) whenever ceilings are at or below 5,000 feet above the terrain, visibility is at or less than 5 miles, or thunderstorms, icing, wind shear, or turbulence is either reported or forecast. These are extremely useful reports, and all pilots are encouraged to volunteer reports of cloud tops, upper cloud layers, thunderstorms, ice, turbulence, strong winds, and other significant flight condition information.

PIREPs are normally given to Flight Watch. They are then included at the beginning of scheduled weather broadcasts by FAA stations within 150 nautical miles of the area affected by potentially hazardous weather. Pilots are advised of these reports during preflight briefings by FAA and national weather service stations, and by air/ground contacts with FAA stations. PIREPs can help you avoid bad weather and warn you to be ready for potential hazards. *CAP pilots are strongly encouraged to regularly give PIREPs.*

Intentionally Blank

3. Weather

OBJECTIVES:

1. Discuss how convection currents affect aircraft glide path.
2. Discuss wind patterns around high- and low-pressure areas.
3. Define "freezing level" and "lapse rate."
4. Discuss airframe icing and its effects on aircraft performance. {MO P-2008}
5. Discuss carburetor icing and its effects on aircraft performance. {MO P-2008}
6. Discuss the characteristics of cold, unstable cold air masses and warm, stable air masses. {O; 3.3}
7. Concerning reduced visibility conditions, state the minimums for: {MO P-2009}
 - a. Visibility, under visual flight rules
 - b. Cloud bases when clouds cover over one-half the sky
 - c. How far aircraft must remain below cloud cover
8. Discuss the dangers of wind shear. {MO P-2010}
9. Describe the 'stages' of a typical thunderstorm and discuss the dangers of flying too close. {MO P-2010}

3.1 Basic weather

Since weather plays such an important part on any CAP operation, the mission scanner/observer must become familiar with some basic weather conditions. Weather can have a pronounced effect on how the search is conducted, and is one of the most important variables that influences search effectiveness.

This chapter covers weather effects in order to produce a more informed aircrew. If you know what to expect, you will be better prepared. Also, remember that the decision of whether or not to fly a particular sortie (i.e., "go, no-go") is ultimately the responsibility of the pilot-in-command. However, any crewmember may decline a mission that he or she considers too dangerous.

3.1.1 Sources of weather information

Sources of weather information include the National Weather Service (www.weather.gov), Aviation Weather Center (www.aviationweather.gov), Aviation Digital Data Service (www.aviationweather.gov/adds/), Weather Underground (www.weatherunderground.com), Weather Channel, Flight Service Stations, and pilot reports (PIREP). Also see Appendix E of FAA Advisory Circular 00-45F.

3.1.2 Atmospheric circulation

The factor that upsets the normal equilibrium is the uneven heating of the earth. At the equator, the earth receives more heat than in areas to the north and south. This heat is transferred to the atmosphere, warming the air and causing it to expand and become less dense. Colder air to the north and south, being more dense, moves toward the equator forcing the less dense air upward, thus establishing a constant circulation that might consist of two circular paths; the air rising at the equator, traveling aloft toward the poles, and returning along the earth's surface to the equator. Heating at the equator would cause the air to circulate uniformly, as shown in Figure 3-1, if the earth did not rotate.

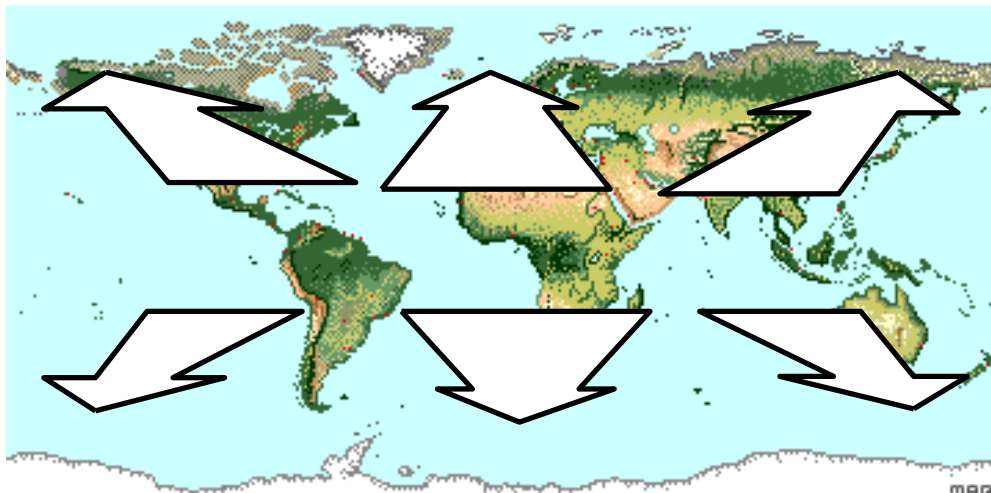

Figure 3-1

This theoretical pattern, however, is greatly modified by many forces, a very important one being the rotation of the earth. In the Northern Hemisphere, this rotation causes air to deflect to the right of its normal path. In the southern

hemisphere, air is deflected to the left of its normal path. For simplicity, this discussion will be confined to the motion of air in the Northern Hemisphere.

As the air rises and moves northward from the equator, it is deflected toward the east, and by the time it has traveled about a third of the distance to the pole, it is no longer moving northward, but eastward. This causes the air to accumulate in a belt at about latitude 30°, creating an area of high pressure. Some of this air is then forced down to the earth's surface, where part flows southwestward, returning to the equator, and part flows northeastward along the surface.

A portion of the air aloft continues its journey northward, being cooled enroute, and finally settles down near the pole, where it begins a return trip toward the equator. Before it has progressed very far southward, it comes into conflict with the warmer surface air flowing northward from latitude 30°. The warmer air moves up over a wedge of colder air, and continues northward, producing an accumulation of air in the upper latitudes.

Further complications in the general circulation of the air are brought about by the irregular distribution of oceans and continents, the relative effectiveness of different surfaces in transferring heat to the atmosphere, the daily variation in temperature, the seasonal changes, and many other factors.

Regions of low pressure, called "lows", develop where air flows over land or water surfaces that are warmer than the surrounding areas. In India, for example, a low forms over the hot land during the summer months, but moves out over the warmer ocean when the land cools in winter. Lows of this type are semi-permanent, however, and are less significant to the pilot than the "migratory cyclones" or "cyclonic depressions" that form when unlike air masses meet. These lows will be discussed later.

3.1.3 Convection currents

Certain kinds of surfaces are more effective than others at heating the air directly above them. Plowed ground, sand, rocks, and barren land give off a great deal of heat, whereas water and vegetation tend to absorb and retain heat. The uneven heating of the air causes small local circulation called "convection currents", which are similar to the general circulation just described.

This is particularly noticeable over land adjacent to a body of water. During the day, air over land becomes heated and less dense; colder air over water moves in to replace it forcing the warm air aloft and causing an on-shore wind. At night the land cools, and the water is relatively warmer. The cool air over the land, being heavier, then moves toward the water as an offshore wind, lifting the warmer air and reversing the circulation.

Convection currents cause the bumpiness experienced by aircrews flying at low altitudes in warmer weather. On a low flight over varying surfaces, the crew will encounter updrafts over pavement or barren places and down drafts over vegetation or water. Ordinarily this can be avoided by flight at higher altitudes, so aircrews may need to climb periodically to take a break from the rough air at search altitudes.

Convection currents also cause difficulty in making landings, since they affect the rate of descent. Figures 3-2 and 3-3 show what happens to an aircraft on a landing approach over two different terrain types. The pilot must constantly correct for these effects during the final approach to the airport.

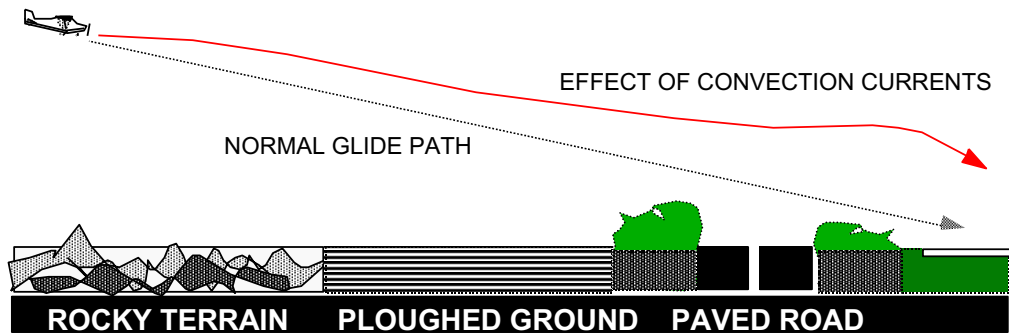

Figure 3-2

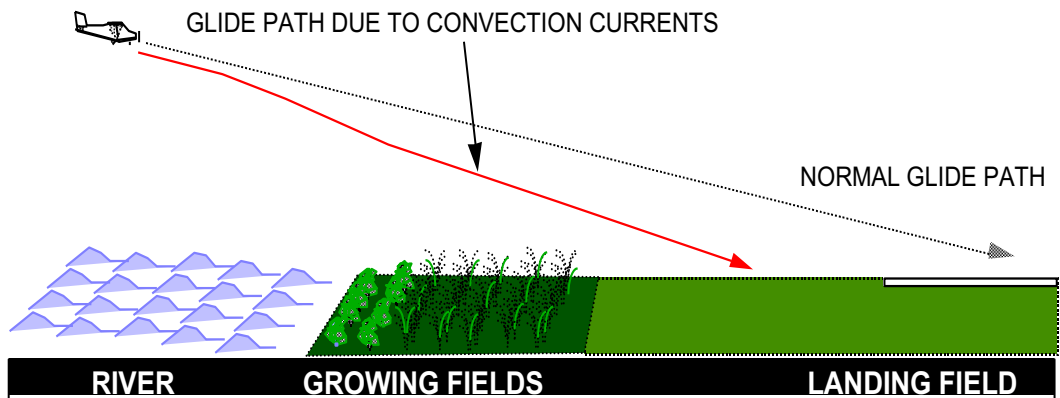

Figure 3-3

The effects of local convection, however, are less dangerous than the turbulence caused when wind is forced to flow around or over obstructions. The only way for the pilot to avoid this invisible hazard is to be forewarned, and to know where to expect unusual conditions.

3.1.4 Effect of Obstructions on Wind

When the wind flows around an obstruction, it breaks into eddies - gusts with sudden changes in speed and direction - which may be carried along some distance from the obstruction. A pilot flying through such turbulence should anticipate the bumpy and unsteady flight that may be encountered. The intensity of this turbulence depends on the size of the obstacle and the wind velocity, and it can present a serious hazard during takeoffs and landings. For example, during landings it can cause a sudden sinking, and during takeoffs it can cause the aircraft to fail to gain enough altitude to clear low objects in its path. Landings attempted under gusty conditions should be made at higher speeds in order to maintain adequate control.

This same condition is more noticeable where larger obstructions such as bluffs or mountains are involved. The wind blowing up the slope on the windward side is relatively smooth and its upward current helps to carry the aircraft over the peak. The wind on the leeward side, following the terrain contour, flows definitely downward with considerable turbulence and would tend to force an aircraft into the mountainside. The stronger the wind gets, the greater the downward pressure and turbulence. Consequently, in approaching a hill or mountain from the leeward side, a pilot should gain enough altitude well in advance. Because of these downdrafts,

it is recommended that mountain ridges and peaks be cleared by at least 2,000 ft. If there is any doubt about having adequate clearance, the pilot should turn away at once and gain more altitude. Between hills or mountains, where there is a canyon or narrow valley, the wind will generally veer from its normal course and flow through the passage with increased velocity and turbulence. A pilot flying over such terrain needs to be alert for wind shifts and particularly cautious if making a landing.

3.1.5 Winds around pressure systems

Certain wind patterns can be associated with areas of high and low pressure. Air flows from an area of high pressure to an area of low pressure. In the Northern Hemisphere during this flow the air is deflected to the right because of the rotation of the earth. Therefore, as the air leaves the high-pressure area, it is deflected to produce a clockwise circulation.

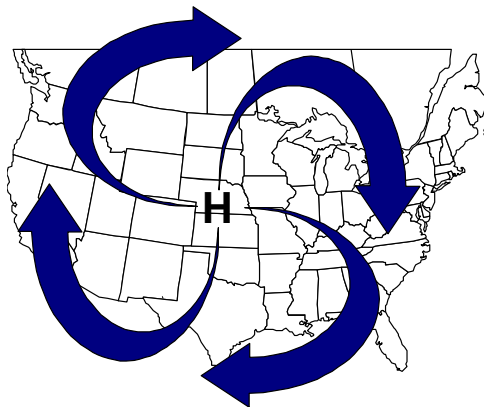

As the air flows toward the low-pressure area, it is deflected to produce a counterclockwise flow around the low-pressure area.

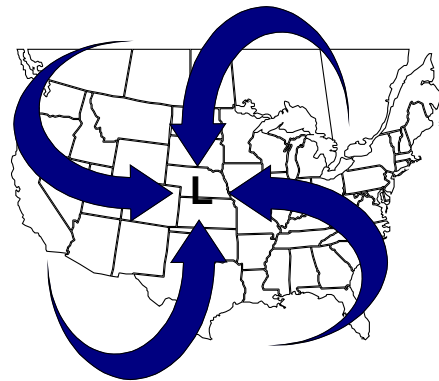

Another important aspect is air moving out of a high-pressure area depletes the quantity of air. Therefore, highs are areas of descending air. Descending air favors dissipation of cloudiness; hence the association that high pressure usually portends good weather.

By similar reasoning, when air converges into a low-pressure area, it cannot go outward against the pressure gradient, nor can it go downward into the ground; it must go upward. Rising air is conducive to cloudiness and precipitation; thus the general association low pressure — bad weather.

Knowledge of these patterns frequently enables a pilot to plan a course to take advantage of favorable winds, particularly during long flights. In flying from east to

west, for example, the pilot will find favorable winds to the south of a high, or to the north of a low. It also gives the pilot a general idea of the type of weather to expect relative to the "highs" and "lows."

The theory of general circulation in the atmosphere and the wind patterns formed within areas of high pressure and low pressure has been discussed. These concepts account for the large-scale movements of the wind, but do not take into consideration the effects of local conditions that frequently cause drastic modifications in wind direction and speed near the earth's surface.

3.2 Icing

3.2.1 Freezing level

As altitude increases, temperature decreases at a fairly uniform rate of 2° Celsius or 3.6° Fahrenheit for each 1000 feet. This rate of temperature change is known as the *lapse rate*. At some altitude, the air temperature reaches the freezing temperature of water, and that altitude is known as the *freezing level*. You can estimate the freezing level prior to flight by using simple mathematics. For example, if the airport elevation is 1,000 feet and the temperature at ground level is 12° Celsius, the freezing level would be at approximately 6,000 feet above ground level (AGL) or 7,000 feet above mean sea level (MSL). Since the lapse rate is 2° per thousand feet, it would take 6,000 feet of altitude to go from 12° Celsius to 0°, the freezing temperature of water. The same technique works for Fahrenheit, but you use 3.6° for the lapse rate. Don't forget to include the airport elevation in your computations: altimeters are normally set to display MSL rather than AGL altitude. This method yields a very approximate value for the freezing level. You are encouraged to leave a wide margin for error above and below this altitude if you must fly through visible moisture during a search.

3.2.2 Airframe icing

When the ground cools at night, the temperature of the air immediately adjacent to the ground is frequently lowered to the saturation point, causing condensation. This condensation takes place directly upon objects on the ground as dew if the temperature is above freezing, or as frost if the temperature is below freezing.

Dew is of no importance to aircraft, but frost can be deadly. Normally we think of frost as unimportant - it forms on cars or other cold surfaces overnight, soon melting after the sun rises. However, frost on an airplane disturbs the airflow enough to reduce the lift and efficiency of aerodynamic surfaces. An airplane *may* be able to fly with frost on its wings, but, even with the airflow over the wings only slightly disrupted, controllability can become unpredictable. *Frost should always be removed before flight*. Some precautions should be taken if frost is expected, such as placing the aircraft in a hangar (even a T-hangar).

Ice increases drag and decreases lift, and ice on the prop reduces thrust. Ice decreases aircraft performance, and stall speed goes up. Ice deposits on a typical C172 significantly increase the weight of the aircraft; a quarter-inch coating of ice can add up to 150 lbs., a half-inch can add ~ 300 lbs., and an inch of clear ice can add ~ 600 lbs.

From an aerodynamic viewpoint, there is no such thing as "a little ice." Many pilots do not recognize that *minute amounts* of ice adhering to a wing can result in

similar penalties. Research results have shown that fine particles of frost or ice, the size of a grain of table salt and distributed as sparsely as one per square centimeter over an airplane wing's upper surface can destroy enough lift (22% in ground effect and 33% in free air) to prevent that airplane from taking off.

Many pilots also believe that if they have sufficient engine power available, they can simply "power through" any performance degradation that might result from almost imperceptible amounts of upper wing surface ice accumulation. However, engine power will not prevent a stall and loss of control at lift-off, where the highest angles of attack are normally achieved. Further, small patches of almost imperceptible ice or frost can result in localized, asymmetrical stalls on the wing, which can result in roll control problems during lift off.

Ice accumulation on the wing upper surface is very difficult to detect; it may not be seen from the cabin because it is clear/white and it is very difficult to see from the front or back of the wing. *The only way to ensure that a wing is free from critical contamination is to touch it!*

Ice can also accumulate on aircraft during flight, and this icing is a major problem in aviation. It is difficult to forecast, because under apparently identical situations the icing intensity on the aircraft can vary considerably. The ice accumulation rate may vary from less than one-half inch per hour to as high as one inch in a minute for brief periods. Experiments have shown that an ice deposit of as little as one-half inch on the leading edge of a wing can reduce lift by about 50%, increase drag by an equal percentage, and thus greatly increase the stall speed. Obviously, the consequences of ice accumulations can be very serious.

There are only two fundamental requisites for ice formation on an aircraft in flight. First the aircraft must be flying through visible water in the form of rain or cloud droplet, and second, when the liquid water droplets strike, their temperature, or the temperature of the airfoil surface, must be 32° F. or below. Water droplets cooled below 32° F. without freezing are called super cooled water droplets. They often exist in clouds when the temperature within the clouds is below 32° F.

Clear ice is a transparent or translucent coating of ice that has a glassy surface appearance. When transparent, it looks like ordinary ice, and is identical with the "glaze" which forms on trees and other objects when freezing rain falls to the earth. It can be smooth or stippled. However, when mixed with snow, sleet, hail, etc., it may be rough, irregular and whitish. It has an appearance different from that of rime ice, due to its different mode of formation and structure. It adheres very firmly to the surfaces upon which it forms, and is very difficult to remove. Glaze usually forms on the leading edges of wings, antennas, etc., more or less in the shape of a blunt nose, and spreads back tapering along the wings. When deposited as a result of freezing of super-cooled raindrops or large cloud droplets unmixed with solid precipitation, it can be quite smooth and approximate a streamline form. When mixed with solid precipitation the deposit can become especially blunt-nosed and rough, with heavy protuberances that build out across the normal streamlines of airflow.

Rime ice is a white or milky, opaque, granular deposit of ice which accumulates on the leading edges of wings, antennas, etc., of an aircraft. Its surface is ordinarily rough. It has a granulated, crystalline or splintery structure. Rime ice usually accumulates on the leading edges of exposed parts and projects forward into the air stream. It usually builds outward from the leading edge into a sharp-nosed shape. Wherever the particles of super cooled water impinge on surface projections of the aircraft, like rivet heads, the deposit acquires the form of a bulge, which may cling rather firmly to the projecting parts.



When ice forms on an aircraft it can affect the flying characteristics in several ways:

- Weight is added. Clear ice can add substantial weight to an aircraft. The added weight increases lift requirements and increases drag. This is what makes the added weight of ice so dangerous.
- Lift is decreased. This is caused by a change in airfoil shape when ice accumulates on the leading edges. (The aircraft will stall at air speeds well above the normal stalling point.)
- The drag is increased. This results when rough ice forms in back of the leading edges and on protuberances.
- Propeller efficiency is decreased. Uneven ice deposits on the blades cause vibration and blade distortion and consequent loss of effective power. Under icing conditions all available power may be needed.

Sorties should never be flown in regions of possible icing. The only reason an aircrew may experience icing is during transits, such as to a mission base (even this should be avoided). However, if the pilot does encounter potential icing conditions, he should plan your flight so as to be in the region for the shortest possible time.

- Caution should be exercised when flying through rain or wet snow with the temperature at flight levels near freezing
- When flying into clouds above the crest of ridges or mountains, maintain a clearance of 4,000 or 5,000 feet above the ridges if the temperature within the cloud is below freezing. Icing is more probable over the crest of ridges than over the adjacent valleys
- Watch for ice when flying through cumulus clouds with the temperature at flight level near freezing
- When ice is formed on the aircraft, avoid maneuvers that will increase the wing loading
- Remember that fuel consumption is greater when flying under icing conditions, due to increased drag and the additional power required
- Consult the latest forecasts for expected icing conditions

3.2.3 Carburetor icing

Although not directly related to weather, another ice problem is carburetor icing. As air is drawn through the carburetor venturi, it expands and cools by as much as

60° F (Venturi effect). Moisture in the air can condense, then freeze, blocking further flow of air and fuel to the engine.

Unlike aircraft structural icing, carburetor ice can form on a warm day in moist air. In the winter when temperatures are below 40° F. the air is usually too cold to contain enough moisture for carburetor ice to form. In the summer when temperatures are above 85° F. there is too much heat for ice to form. So, airplanes are most vulnerable to carburetor icing when operated in high humidity or visible moisture with temperatures between 45° and 85° F. [Note: Fuel-injected engines are not vulnerable to carburetor icing.]

Normally, an airplane engine develops sufficient heat at climb and cruise power settings to keep carburetor ice from forming. It's most likely to become a problem when the aircraft is operated at low power settings, such as in descents and approaches to landings. Many manufacturers have provided a means for selectively ducting warm air to the carburetor to prevent ice build-up when operating at low power settings. This feature is called *carburetor heat*, and the pilot may select it when starting a low-power descent.

3.3 Frontal activity

Large, high-pressure systems frequently stagnate over large areas of land or water with relatively uniform surface conditions. They take on characteristics of these "source regions" (e.g., the coldness of polar regions, the heat of the tropics, the moisture of oceans, or the dryness of continents).

As air masses move away from their source regions and pass over land or sea, they are constantly being modified through heating or cooling from below, lifting or subsiding, absorbing or losing moisture. Actual temperature of the air mass is less important than its temperature in relation to the land or water surface over which it is passing. For example, an air mass moving from a polar region is usually colder than the land and sea surfaces over which it passes. On the other hand, an air mass moving from the Gulf of Mexico in winter usually is warmer than the territory over which it passes.

If the air is colder than the surface, it will be warmed from below and convection currents will be set up, causing turbulence. Dust, smoke, and atmospheric pollution near the ground will be carried upward by these currents and dissipated at higher levels, improving surface visibility. Such air is called "unstable." Conversely, if the air is warmer than the surface, there is no tendency for convection currents to form, and the air is smooth. Smoke, dust, etc., are concentrated in lower levels with resulting poor visibility. Such air is called "stable." From the combination of the source characteristics and the temperature relationship just described, air masses can be associated with certain types of weather.

When two air masses meet, they will not mix readily unless their temperature, pressure, and relative humidity are very similar. Instead, they set up boundaries called frontal zones, or "fronts", the colder air mass projecting under the warmer air mass in the form of a wedge. This condition is termed a "stationary front" if the boundary is not moving.

Usually, the boundary moves along the earth's surface, and as one air mass withdraws from a given area it is replaced by another air mass. This action creates a moving front. If warmer air is replacing colder air, the front is called "warm"; if colder air is replacing warmer air, the front is called "cold."

Certain characteristics of frontal activities will affect search effectiveness (primarily visibility and turbulence). For the both the mission staff and the aircrew, these factors must be considered during mission planning.

Characteristics of a cold, unstable air mass are:

- Cumulus and cumulonimbus clouds
- Unlimited ceilings (except during precipitation)
- Excellent visibility (except during precipitation)
- Unstable air resulting in pronounced turbulence in lower levels (because of convection currents)
- Occasional local thunderstorms or showers - hail sleet, snow flurries

Characteristics of a warm, stable air mass are:

- Stratus and stratocumulus clouds
- Generally low ceilings
- Poor visibility (fog, haze, smoke, and dust held in lower levels)
- Smooth, stable air with little or no turbulence
- Slow steady precipitation or drizzle

3.3.1 Warm Front

As a warm front moves the warm air slides up over the wedge of colder air lying ahead of it. Warm air usually has high humidity. As this warm air is lifted, its temperature is lowered. As the lifting process continues, condensation occurs; low nimbostratus and stratus clouds form and drizzle or rain develops. The rain falls through the colder air below, increasing its moisture content so that it also becomes saturated. Any reduction of temperature in the colder air, which might be caused by up-slope motion or cooling of the ground after sunset, may result in extensive fog.

As the warm air progresses up the slope, with constantly falling temperature, clouds appear at increasing heights in the form of altostratus and cirrostratus, if the warm air is stable. If the warm air is unstable, cumulonimbus clouds and altocumulus clouds will form and frequently produce thunderstorms. Finally, the air is forced up near the stratosphere, and in the freezing temperatures at that level, the condensation appears as thin wisps of cirrus clouds. The up-slope movement is very gradual, rising about 1,000 ft. every 20 miles. Thus, the cirrus clouds, forming at perhaps 25,000 ft. altitude, may appear as far as 500 miles in advance of the point on the ground which marks the position of the front.

3.3.2 Flight toward an approaching warm front

Although no two fronts are exactly alike, a clearer understanding of the general weather pattern may be gained if the atmospheric conditions that might exist when a warm front is moving eastward from St. Louis, Mo., is considered.

- At St. Louis, the weather would be very unpleasant, with drizzle and probably fog
- At Indianapolis, 200 miles in advance of the warm front, the sky would be overcast with nimbostratus clouds, and continuous rain

- At Columbus, 400 miles in advance, the sky would be overcast with predominantly stratus and altostratus clouds. The beginning of a steady rain would be probable.
- At Pittsburgh, 600 miles ahead of the front, there would probably be high cirrus and cirrostratus clouds

If a flight were made from Pittsburgh to St. Louis, ceiling and visibility would decrease steadily. Starting under bright skies, with unlimited ceilings and visibilities, lowering stratus-type clouds would be noted as Columbus was approached, and soon afterward precipitation would be encountered. After arriving at Indianapolis, the ceilings would be too low for further flight. Precipitation would reduce visibilities to practically zero. Thus, it would be wise to remain in Indianapolis until the warm front had passed, which might require a day or two.

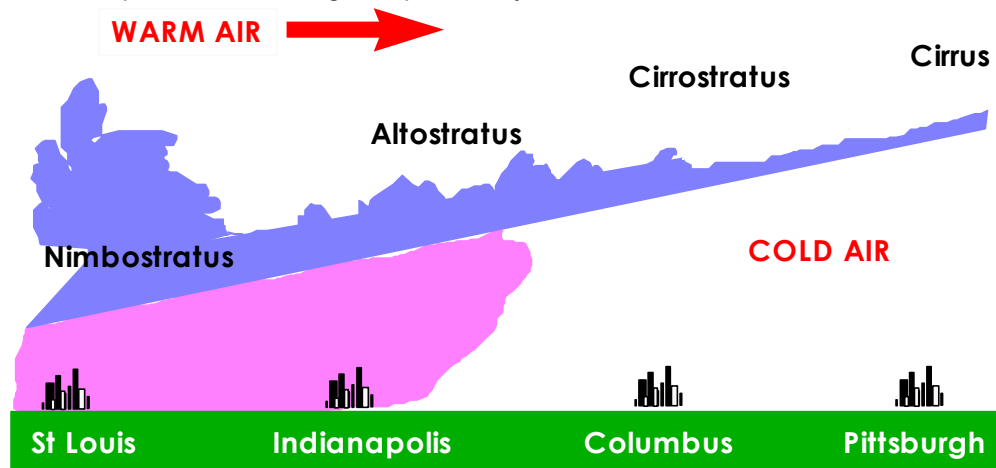

If a return flight to Pittsburgh was made, it would be recommended to wait until the front had passed beyond Pittsburgh, which might require three or four days. Warm fronts generally move at the rate of 10 to 25 miles an hour.

On the trip from Pittsburgh to Indianapolis a gradual increase in temperature would have been noticed, and a much faster increase in dew point until the two coincided. Also the atmospheric pressure would be gradually lessening because the warmer air aloft would have less weight than the colder air it was replacing. This condition illustrates the general principle that a falling barometer indicates the approach of stormy weather.

3.3.3 Cold Front

As a cold front moves it functions like the blade of a snowplow, sliding under the warmer air and forcing it aloft. This causes the warm air to cool suddenly and form cloud types that depend on the stability of the warm air.

In fast-moving cold fronts, friction retards the front near the ground, which brings about a steeper frontal surface. This steep frontal surface results in a narrower band of weather concentrated along the forward edge of the front. If the warm air is stable, an overcast sky may occur for some distance ahead of the front, accompanied by general rain. If the warm air is conditionally unstable, scattered thunderstorms and showers may form in the warm air. At times an almost continuous line of thunderstorms may form along the front or ahead of it. These lines of thunderstorms (squall lines) contain some of the most turbulent weather

experienced by pilots. Behind the fast-moving cold front there is usually rapid clearing, with gusty and turbulent surface winds, and colder temperatures.

The slope of a cold front is much steeper than that of a warm front and the progress is generally more rapid -usually from 20 to 35 miles per hour, although in extreme cases, cold fronts have been known to move at 60 miles per hour. Weather activity is more violent and usually takes place directly at the front instead of in advance of the front. In late afternoon during the warm season, however, squall lines frequently develop as much as 50 to 200 miles in advance of the actual cold front. Whereas warm front dangers are low ceilings and visibilities, cold front dangers are chiefly sudden storms, high and gusty winds, and turbulence.

Unlike the warm front, the cold front rushes in almost unannounced, makes a complete change in the weather within a period of a few hours, and moves on. Altostratus clouds sometimes form slightly ahead of the front but these are seldom more than 100 miles in advance. After the front has passed, the weather often clears rapidly and cooler, drier air with usually unlimited ceilings and visibilities prevail.

3.3.4 Flight toward an Approaching Cold Front

If a flight was made from Pittsburgh toward St. Louis when a cold front was approaching from St. Louis, weather conditions quite different from those associated with a warm front will be experienced. The sky in Pittsburgh would probably be somewhat overcast with stratocumulus clouds typical of a warm air mass, the air smooth, and the ceilings and visibilities relatively low although suitable for flight.

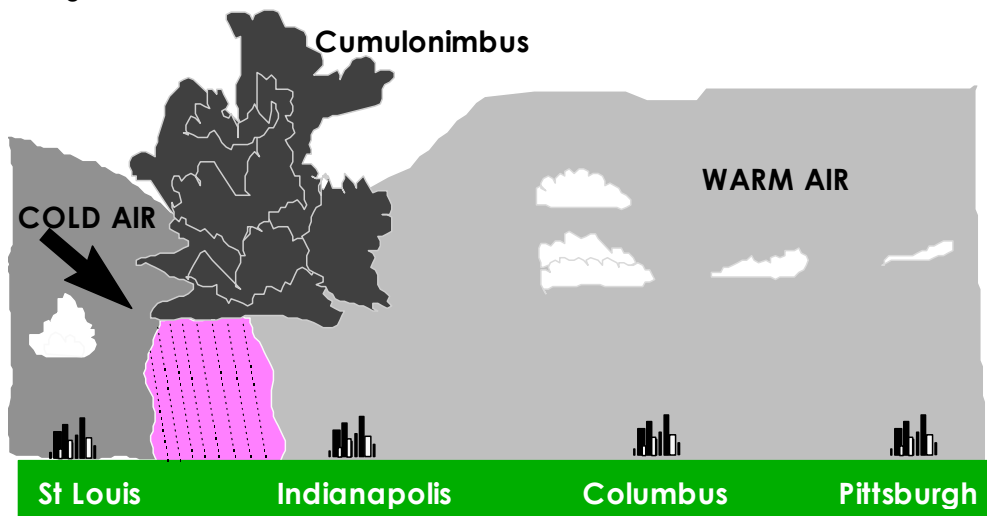

As the flight proceeded, these conditions would prevail until reaching Indianapolis. At this point, it would be wise to check the position of the cold front; it would probably be found that the front was now about 75 miles west of Indianapolis. A pilot with sound judgment based on knowledge of frontal conditions would remain in Indianapolis until the front had passed - a matter of a few hours - and then continue on under near perfect flying conditions.

If, however, through the lack of better judgment the flight were continued toward the approaching cold front, a few altostratus clouds and a dark layer of nimbostratus lying low on the horizon, with perhaps cumulonimbus in the background would be noted. Two courses would now be open:

- Either to turn around and outdistance the storm, or
- Make an immediate landing that might be extremely dangerous because of gusts and sudden wind shifts

The wind in a “high” blows in a clockwise spiral. When two highs are adjacent, the winds are in almost direct opposition at the point of contact. Since fronts normally lie between two areas of higher pressure, wind shifts occur in all types of fronts, but they usually are more pronounced in cold fronts.

If flight was continued, entrapment in a line of squalls and cumulonimbus clouds could occur. It may be disastrous to fly beneath these clouds; impossible, in a small plane, to fly above them. At low altitudes, there are not safe passages through them. Usually there is no possibility of flying around them because they often extend in a line for 300 to 500 miles.

3.3.5 Occluded Front

One other form of front with which the pilot should become familiar is the “exclusion” or “occluded front.” This is a condition in which an air mass is trapped between two colder air masses and forced aloft to higher and higher levels until it finally spreads out and loses its identity. An occluded front appears on weather maps as shown in Figure 3-4.

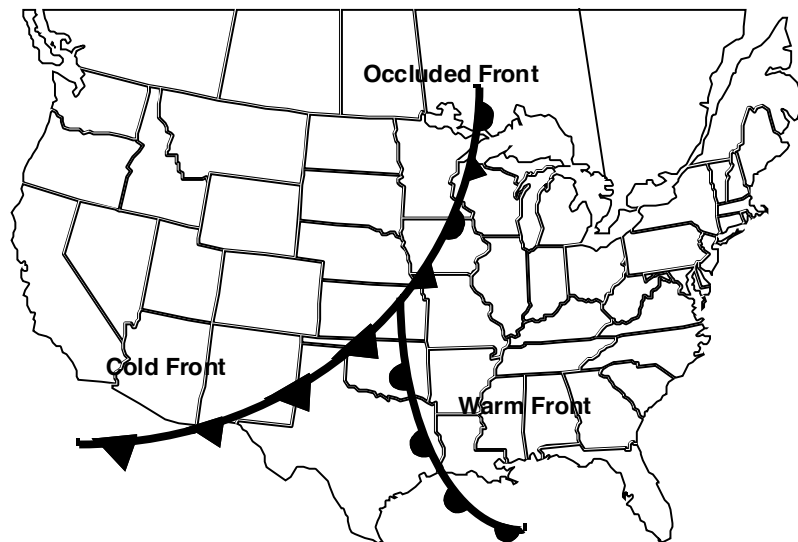

Figure 3-4

Meteorologists subdivide occlusions into two types, but so far as the pilot is concerned, the weather in any occlusion is a combination of warm front and cold front conditions. As the occlusion approaches, the usual warm front indications prevail - lowering ceilings, lowering visibility, and precipitation. Generally the cold front type, with squalls, turbulence, and thunderstorms, then follows the warm front weather almost immediately.

The first stage represents a boundary between two air masses, the cold and warm air moving in opposite directions along a front. Soon, however, the cooler air, being more aggressive, thrusts a wedge under the warm air, breaking the continuity of the boundary. Once begun, the process continues rapidly to the complete occlusion. As the warmer air is forced aloft, it cools quickly and its moisture condenses, often causing heavy precipitation. The air becomes extremely turbulent, with sudden changes in pressure and temperature.

3.4 Reduced Visibility

According to FAA regulations, under almost all circumstances flight using visual flight rules can only be conducted with at least three miles of visibility (CAPR 70-1 states the minimum flight visibility of three statute miles is required for all VFR flights unless the PIC is a current and qualified instrument pilot). If clouds cover more than one-half the sky, the cloud bases must be no lower than 1,000 feet above the terrain. In addition, search aircraft must usually remain at least 500 feet below the cloud deck.

One of the most common hazardous-weather problems is loss of visibility. This can happen either suddenly or very insidiously, depriving the pilot of his ability to see and avoid other aircraft, and reducing or depriving him altogether of his ability to control the aircraft, unless he has had training and is proficient in instrument flying. In reduced visibility, the crew's ability to see rising terrain and to avoid towers, power transmission lines, and other man-made obstacles is diminished.

Visibility may be reduced by many conditions including clouds, rain, snow, fog, haze, smoke, blowing dust, sand, and snow. A similar condition called "white out" can occur where there has been snowfall.

In most regions of the country, fog and haze are the most common weather conditions that cause reduced visibility. Fog, especially dense fog, can pose a hazard to even the most sophisticated military or civilian aircraft. In thick fog, reduced visibility may make it extremely difficult, if not impossible, to see landing runways or areas. The crew should be alert for a potential problem with fog whenever the air is relatively still, the temperature and dew point are within several degrees, and the temperature is expected to drop further, as around sunset and shortly after sunrise. This is often a factor in delaying the first sorties of the day.

Haze, a fine, smoke-like dust causes lack of transparency in the air. Its most often caused when still air prevents normal atmospheric mixing, allowing the particles to persist, instead of the wind's dispersing them. Like fog, it is most likely to occur when the air is still. The air doesn't mix to scatter the particles of dust, smoke, or pollen. If the wind remains calm for several days, visibility will become progressively worse. This atmospheric condition is most common in heavily populated, industrialized areas of the country; it can also be present anywhere there is still air and a source of particles, like near burning farm fields or thick forests that produce large quantities of pollen. It is especially noticeable in the early morning. Haze can cause your eyes to focus on a point 10-30 feet ahead.

Frequently, as the sun warms the cool, hazy air and causes it to expand and rise, visibility at the surface will improve and appear acceptable. What initially appeared to be ample visibility can, after takeoff, become almost a complete obstruction to lateral or forward visibility several hundred feet above the surface. Downward visibility is satisfactory, but pilots may feel apprehensive about the loss of a visible horizon to help judge aircraft control, and about what might come out of the murk ahead. Visibility at this altitude may actually be more than the minimum three miles, yet the pilot may interpret this visual range as a wall just beyond the airplane's nose.

In summer, haze and smoke may extend upward more than 10,000 feet during the heat of the day, hiding rain showers or thunderstorms within the haze and presenting a special hazard. When haze and smoke are present, the best measure a flight crew can take to minimize risk of such an encounter is to get a thorough weather briefing before flying, and update the briefing by radio with *Flight Watch* (122.0 MHz) as required.

Blowing dust is normally found in the relatively dry areas of the country, like the desert southwest. The condition develops when strong wind picks up small soil particles, and strong air currents carry it upward into the atmosphere. These conditions can spread dust hundreds of miles and up to 15,000 feet. Depending upon wind speed and particle volume, visibility in dust storms may be reduced to very low levels. Blowing sand is much more localized than dust, occurring only when the wind is strong enough to lift loose sand. Since sand particles are much heavier than dust they are rarely lifted more than 50 feet above the surface. Still, the condition eliminates the effectiveness of visual searches, and in many cases can prohibit an aircraft from taking off or landing.

Strong surface winds can also cause blowing snow. Blowing snow is more frequent in areas where dry, powdery snow is found. For the aviator, blowing snow can cause the same problems of reduced visibility. Like dust, it can reach thousands of feet above the surface.

Snow can cause another visibility problem, known as "white out." This condition can occur anywhere there is snow-covered ground, but is most common in arctic regions. It's not a physical obstruction to visibility like earlier examples, but an optical phenomenon. White out requires a snow-covered surface and low-level clouds of uniform thickness. At low sun angles, light rays are diffused as they penetrate the cloud layer causing them to strike the snow-covered surface at many angles and eliminating all shadows. The net effects are loss of a visible horizon and loss of depth perception, each of which can make low-level flight and landings difficult and hazardous.

From this discussion, it becomes obvious that each member of the aircrew must be vigilant during all phases of the flight when visibility is less than perfect. Crew resource management requires that each member of the crew be assigned an area to search during the takeoff, transit and approach-to-landing phases of the flight in order to help the pilot "see and avoid" obstacles and other aircraft.

The aircrew must also characterize visibility in the search area so as to establish the proper scanning range. Search visibility may be different than expected, and your search pattern may have to be adjusted accordingly. Be sure to cover this during your debriefing.

3.5 Turbulence

Turbulence is irregular atmospheric motion or disturbed wind flow that can be attributed to a number of causes. Under almost all circumstances, small amounts of normal atmospheric turbulence can be expected and it usually poses few problems. Previous sections covered wake turbulence and convective activity as causes of turbulence. Convective activity was covered in the context of thunderstorm development, but any phenomenon that causes air to be lifted up, even a hot asphalt parking lot, can cause convective turbulence. Other causes include obstructions to wind flow and wind shear.

Just as a tree branch dangling into a stream creates continuous ripples or waves of turbulence in the water's surface, obstructions to the wind can create turbulence in the air. This type of turbulence occurs mostly close to the ground, although depending upon wind velocity and the nature of the obstruction, it may reach upward several thousand feet. In an extreme case, when winds blow against a mountainside, the mountain deflects the wind upward creating a relatively smooth updraft. Once the wind passes the summit, it tumbles down the leeward or

downwind side, forming a churning, turbulent down draft of potentially violent intensity. The churning turbulence can then develop into *mountain waves* that may continue many miles from the mountain ridge. Mountain waves may be a factor when surface winds are as little as 15 knots.

Turbulence can be inconsequential, mildly distracting, nauseating, or destructive depending on its intensity. Turbulence can often be avoided by changing altitudes. Aircraft manufacturers publish *maneuvering speeds* in the operating handbooks. If the maneuvering airspeed of an aircraft is exceeded in turbulent air, structural damage could occur.

Turbulence can become a major factor in search effectiveness. Any scanner or observer who is uncomfortable or nauseous cannot perform their duties at a very high level of effectiveness. If you experience these sensations, inform the pilot immediately. If turbulence detracted from your concentration during the search, be sure to mention this during debriefing.

3.6 Wind shear

Wind shear is best described as a change in wind direction and/or speed within a very short distance in the atmosphere. Under certain conditions, the atmosphere is capable of producing some dramatic shears very close to the ground; for example, wind direction changes of 180° and speed changes of 50 knots or more within 200 ft. of the ground have been observed. This, however, is not something encountered every day. In fact, it is unusual, which makes it more of a problem. It has been thought that wind cannot affect an aircraft once it is flying except for drift and groundspeed. This is true with steady winds or winds that change gradually. It isn't true, however, if the wind changes faster than the aircraft mass can be accelerated or decelerated.

The most prominent meteorological phenomena that cause significant low-level wind shear problems are thunderstorms and certain frontal systems at or near an airport.

Basically, there are two potentially hazardous shear situations. First, a tailwind may shear to either a calm or headwind component. In this instance airspeed initially increases, the aircraft pitches up and the altitude increases. Second, a headwind may shear to a calm or tailwind component. In this situation the airspeed initially decreases, the aircraft pitches down and the altitude decreases. Aircraft speed, aerodynamic characteristics, power/weight ratio, power plant response time, and pilot reactions along with other factors have a bearing on wind shear effects. It is important, however, to remember that shear can cause problems for any aircraft and any pilot.

There are two atmospheric conditions that cause these types of low-level wind shear: thunderstorms and fronts.

The winds around a thunderstorm are complex (discussed in the following section). Wind shear can be found on all sides of a cell. The wind shift line or gust front associated with thunderstorms can precede the actual storm by up to 15 nautical miles. Consequently, if a thunderstorm is near an airport of intended landing or takeoff, low-level wind shear hazards may exist.

While the direction of the winds above and below a front can be accurately determined, existing procedures do not provide precise and current measurements of the height of the front above an airport. The following is a method of determining

the approximate height of the front, considering that wind shear is most critical when it occurs close to the ground.

- A cold front wind shear occurs just after the front passes the airport and for a short period thereafter. If the front is moving 30 knots or more, the frontal surface will usually be 5,000 ft. above the airport about 3 hours after the passage.
- With a warm front, the most critical period is before the front passes the airport. Warm front shear may exist below 5,000 ft. for approximately 6 hours; the problem ceases to exist after the front passes the airport. Data compiled on wind shear indicate that the amount of shear in warm fronts is much greater than that found in cold fronts.
- Turbulence may or may not exist in wind shear conditions. If the surface wind under the front is strong and gusty there will be some turbulence associated with wind shear.

The pilot should be alert to the possibilities of low-level wind shear at any time the conditions stated are present.

3.7 Thunderstorms

A thunderstorm is any storm accompanied by thunder and lightning. It usually includes some form of precipitation, and can cause trouble for aircraft in many forms: turbulence, icing, poor visibility, hail, wind shear, micro bursts, lightning, and, in severe cases, tornadoes.

Individual thunderstorms may often be very local in nature, although they often form along weather fronts and appear to march across the land in long lines. This is the situation when weather forecasters announce that a line of thunderstorms is approaching, and thunderstorm warnings go into effect. Individual thunderstorms are rarely larger than 10 miles in diameter, and typically develop, mature, and dissipate within an hour and a half at the most. Each is produced by the growth of a puffy cumulus cloud into a cumulonimbus cloud. The severe elements of a thunderstorm result from the vertical air movement, or convective activity, within the storm.

Thunderstorms may be studied by dividing them into three separate growth stages: the cumulus, or building stage, the mature stage, and the dissipating stage. Figure 3-5 demonstrates the physical appearances of each stage of the developing storm.

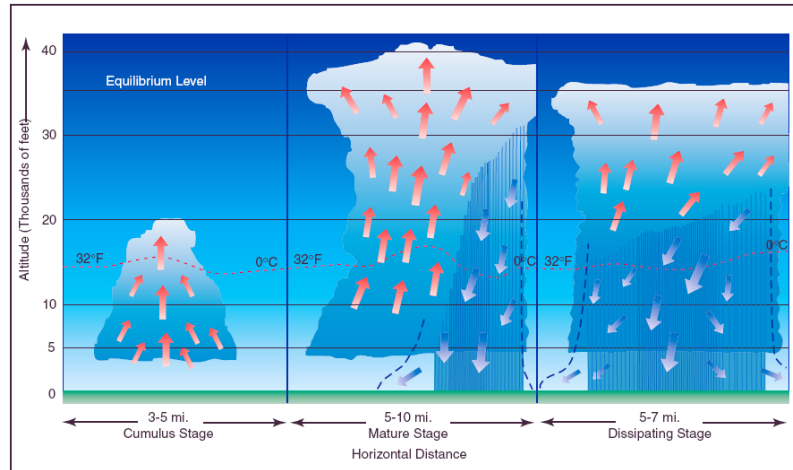

Figure 3-5

Most cumulus clouds do not become thunderstorms, but all thunderstorms are born as cumulus clouds. The main feature of this first stage of thunderstorm development is its updraft, a large air current flowing upward from the ground through the chimney-like cloud. The draft can reach speeds of several thousand feet per minute, and continue to an altitude of 40,000 feet or more. During this period, small water droplets grow into raindrops as the cloud builds upward to become a cumulonimbus cloud.

Precipitation at the earth's surface marks the mature stage of a thunderstorm. The raindrops (or ice particles) have now become so large and heavy that the updraft can no longer support them, and they begin to fall. As they fall, the raindrops drag air with them, causing the characteristic strong down draft of mature thunderstorms. These down drafts spread out horizontally when they reach the surface, producing strong, gusty winds, wind shear, sharp drops in temperature (because the air was chilled at high altitudes) and a sharp rise in pressure.

The mature stage of the thunderstorm is when associated hazards are most likely to reach maximum intensity. Micro bursts, extremely intense down drafts, can occur during this mature phase of development. Downward wind velocities in micro bursts may reach 6,000 feet per minute, and even powerful jet aircraft may have insufficient power to recover prior to ground impact.

As down drafts continue to spread, updrafts weaken, and the entire thunderstorm eventually becomes an area of down drafts, which characterizes the dissipating stage of the thunderstorm. During this stage, the cloud develops the characteristic anvil shape at the top and may take on a stratiform or layered appearance at the bottom. Usually this stage is the longest of the three stages of a thunderstorm's life.

No thunderstorm should ever be taken lightly. During the cumulus stage, vertical growth occurs so quickly that climbing over the developing thunderstorm is not possible. Flight beneath a thunderstorm, especially in the mature stage, is considered very foolish, due to the violent down drafts and turbulence beneath them. Flight around them may be a possibility, but can still be dangerous. Even though the aircraft may be in clear air, it may encounter hail, lightning, or turbulence a significant distance from the storm's core. Thunderstorms should be avoided by at least 20 miles laterally. The safest alternative, when confronted by thunderstorms, is to land, hanger or tie the aircraft down, and wait for the storms to dissipate or move on.

4. High Altitude and Terrain Considerations

OBJECTIVES:

1. Concerning atmospheric pressure: {MO P-2011}
 - a. State the pressure at sea level, and describe how to compensate for 'other-than-sea level pressures' when setting the altimeter
 - b. Discuss the three factors that affect the density of an air mass
 - c. Define density altitude
2. State the phases of flight affected by a decrease in atmospheric pressure, and how aircraft performance is affected. {MO P-2011}
3. Discuss strategies to compensate for high DA during searches. {MO P-2011}
4. Discuss mountainous terrain precautions and strategies. {MO P-2011}

4.1 Atmospheric pressure

Pressure at a given point is a measure of the weight of the column of air above that point. As altitude increases, pressure diminishes as the weight of the air column decreases. This decrease in pressure has a pronounced effect on flight. The aircraft's altimeter is sensitive to these changes in pressure, and displays this pressure as altitude. When the aircraft's altimeter is set to the current reported altimeter setting (ATIS/AWOS/ASOS/FSS) it indicates the aircraft's height above mean sea level (MSL). [If a local altimeter setting is unavailable, pilots usually set the altimeter to indicate the airport's MSL elevation.]

Changes in pressure are registered in inches of mercury: the *standard* sea-level pressure is 29.92 inches at a *standard* temperature of 15° C (59° F). If CAP aircraft always operated at standard conditions, the altimeter would always be accurate. An aircraft with an indicated (on the altimeter) altitude of 5,000' MSL will really be 5000' above the ground (AGL). However, these standard conditions rarely exist because the density of the atmosphere is always changing as altitude and temperature changes. [The third factor - humidity - also effects density, but the effect is smaller and it's very hard to determine.]

Pressure altitude is an altitude measured from the point at which an atmospheric pressure of 29.92 inches of mercury is found. A good rule of thumb is that a 1,000' change of altitude results in a 1-inch (mercury) change on a barometer. Another way to determine pressure altitude is to enter 29.92 into the altimeter's window and read the resulting altitude indication.

When pressure altitude is corrected for non-standard temperature, *density altitude* can be determined. There are two ways to calculate this (besides ASOS).

Chart method

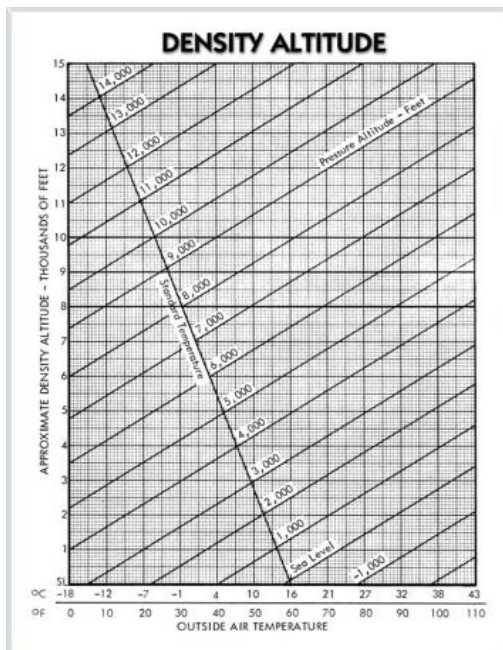

Assume an aircraft is taking off from an airport with a pressure altitude of 3,000' and the temperature is 80° F. Draw a line straight up from 80° F to the intersection

of the 3,000' pressure altitude line. Then proceed horizontally to the left to read the density altitude (5,000').

Flight Computer method

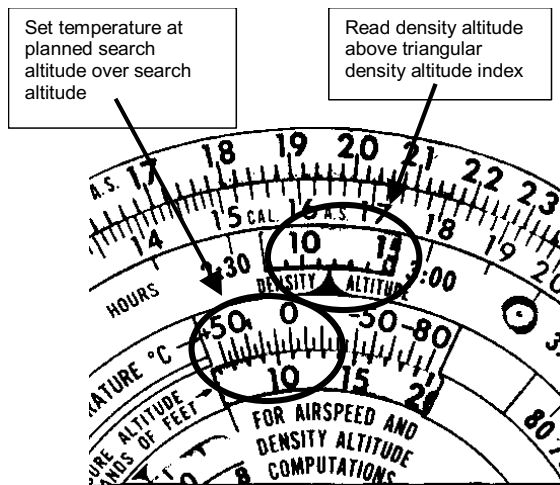

Convert the 80° F to Celsius (27°). Position +27 on the "Air Temperature °C" scale over the pressure altitude of '3' (the pressure altitude scale is in thousands of feet). Read the number ('5') in the "Density Altitude" window (5 x 1,000' = 5,000'). [Note: A rule of thumb is to add 500 feet to the airport's elevation for every 10° F above standard temperature at the airport's elevation.]

4.2 Aircraft performance limitations

The combined effects of high altitude and temperature (high density altitude) can have a significant effect on performance of aircraft engines, wings, propellers, and the pilot and crew. If all missions were conducted on cool, low humidity days along the Gulf coast there would be no concern with air density and its implications on flight safety. Obviously, this isn't the case. In fact, these conditions have often been primary factors in aircraft accidents, and may result in loss of the search aircraft, unless you pay careful attention.

The most noticeable effect of a decrease in pressure (increase in density altitude) due to an altitude increase becomes evident during *takeoff, climb, and landing*. The purpose of the takeoff run is to gain enough speed to generate lift from the passage of air over the wings. If the air is thin, more speed is required to obtain enough lift for takeoff: hence longer ground runs. An airplane that requires a 1,000' run for takeoff at a sea-level airport will require a run almost twice as long at an airport that is approximately 7,000' above sea level.

Elevation	Temperature	Engine Horsepower	Rate of Climb (ROC)	Take Off Distance
Sea Level	59°F	160	700 feet/minute	1,627 feet
	85°F	-	-	1,810 feet
7,000'	59°F	140	338 feet/ minute	3,627 feet
	85°F	-	-	4,200 feet

Compiled from aircraft flight manual. Presented here for training purposes only.

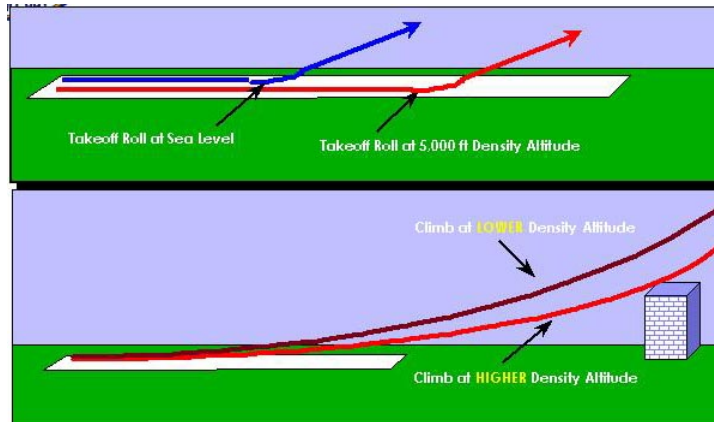

It is also true that the engine is less efficient in thin air, and the thrust of the propeller is less effective. The rate of climb is also slower at the higher elevation, requiring a greater distance to gain the altitude to clear any obstructions. In landing, the difference is not so noticeable except that the plane has greater groundspeed when it touches the ground.

Most CAP airplanes can operate at speeds of approximately 120 knots, or 2 miles per minute. A rate-of-climb of 100 feet per minute at 120 knots gives a no-wind climb angle or gradient of approximately 50 feet per mile, *substantially less* than that required to climb over rapidly rising, mountainous terrain. See the table below for examples at various weights (C172, 160 hp; gross weight is 2,400 lbs.).

PRESSURE ALTITUDE 4,000 FEET			
Temperature	Density Altitude, Feet	ROC @ 2,100 Pounds	ROC @ 2,400 Pounds
10°F	1,600	820	630
60°F	5,000	650	470
100°F	7,500	540	370
PRESSURE ALTITUDE 6,000 FEET			
Temperature	Density Altitude, Feet	ROC @ 2,100 Pounds	ROC @ 2,400 Pounds
10°F	4,000	700	520
60°F	7,500	540	370
100°F	10,000	410	260
PRESSURE ALTITUDE 10,000 FEET			
Temperature	Density Altitude, Feet	ROC @ 2,100 Pounds	ROC @ 2,400 Pounds
10°F	9,000	460	300
60°F	12,400	315	160
100°F	15,000	200	50

Compared to turns at low altitude, turns in high density altitudes have larger turn radii and slower turn rates. The airplane cannot reverse course so quickly and a 180° turn requires more room. Steep-banked, tight turns should also be avoided because the aircraft may have insufficient power or speed (or both) to complete the turn without losing altitude.

Density altitude's effect on twin-engine aircraft can be catastrophic in the event of a power loss by one engine. Most CAP-operated "twins" would not be able to climb at all and may not be able to maintain level flight under such circumstances. The pilot then flies an airspeed that allows a minimum rate of descent and starts looking for a suitable place to land. Hopefully, a runway will be nearby.

4.2.1 Strategies

The mission staff can make a number of decisions to help minimize the effects of high density altitude operations and thus maximize flight safety. If aircraft having turbo-charged or super-charged engines are available, the incident commander may assign their crews that part of the search over the high terrain. Supercharging or turbo charging regains some of the engine performance lost with the decrease in air density, but cannot improve upon that lost from the wings or propeller.

Incident commanders may schedule flights to avoid searching areas of high elevation during the hottest times of the day. This is a tradeoff though, in that the best sun angles for good visibility often coincide with the hot times of the day. The incident commander may also elect to limit crew size to minimize airplane total weight. Instead of dispatching a four-seat aircraft with a pilot, observer, and two scanners aboard, he may elect to send a pilot, observer and single scanner only. Again, this represents a tradeoff, where some search capability is sacrificed for a higher margin of safety.

The pilot may decide to takeoff on a mission with only the fuel required for that mission and the required reserve, rather than departing with full fuel tanks. Each crewmember can help by leaving all *nonessential* equipment or personal possessions behind. In high density altitudes, airplane performance can be improved significantly by simply leaving nonessential, excess weight behind.

To help remember these conditions and their effects, an observer should remember the four "H's." *Higher Humidity, Heat, or Height all result in reduced aircraft performance.* Available engine power is reduced, climb capability is reduced, and takeoff and landing distances are increased.

4.3 Effects on crewmember performance

The factors previously discussed can have similarly degrading effects on the ability of each crewmember to perform his or her job tasks. As air temperature increases, so does each crewmember's susceptibility to nausea, airsickness, and dehydration. As humidity increases with temperature, the body's ability to regulate its own temperature by perspiration can be negatively affected also, beginning the initial symptoms of heat exhaustion.

When operating in high temperatures, crewmembers should make every effort to drink plenty of water, juice, or caffeine-free soft drinks prior to, during, and after each mission to help prevent dehydration. Even though an individual may not be physically active, body water is continuously expired from the lungs and through the skin. This physiological phenomenon is called insensible perspiration or insensible loss of water.

The loss of water through the skin, lungs, and kidneys never ceases. Water loss is increased in flight because of the relatively lowered humidity at altitude, particularly on extended flights. Combating the loss of water during flights requires frequent water intake; experts recommend drinking 13-20 ounces (3-5 mouthfuls)

of fluid thirty minutes before you leave, and 4-6 ounces (a couple of mouthfuls) every 15 minutes thereafter.

Typical dehydration conditions are: dryness of the tissues and resulting irritation of the eyes, nose, and throat, and fatigue relating to the state of acidosis (reduced alkalinity of the blood and body tissues). A person reporting for a flight in a dehydrated state will more readily notice these symptoms until fluids are adequately replaced.

Consumption of coffee, tea, cola, and cocoa should be minimized since these drinks contain caffeine. In addition, tea contains a related drug (theophylline), while cocoa (and chocolate) contain theobromine, of the same drug group. These drugs, besides having a diuretic effect, have a marked stimulating effect and can cause an increase in pulse rate, elevation of blood pressure, stimulation of digestive fluid formation, and irritability of the gastrointestinal tract.

Increasing the flow of outside air through the aircraft interior by the use of vents, or opening windows or hatches can usually remedy heat-related problems. If sufficient airflow cannot be gained, cooler air can usually be located by climbing the aircraft to a higher altitude. This may be inconsistent with search altitudes assigned by the incident commander or may be beyond the performance capability of the aircraft.

Altitude has several effects on human performance including ear block, sinus block and hypoxia. Observers should be aware of these factors in their own performance and also watch for them to occur in other crewmembers.

4.3.1 Ear block

As the aircraft cabin pressure decreases during ascent, the expanding air in the middle ear pushes the Eustachian tube open and, by escaping down it to the nasal passages, equalizes in pressure with the cabin pressure. But during descent, the pilot must periodically open the Eustachian tube to equalize pressure. This can be accomplished by swallowing, yawning, tensing muscles in the throat or, if these do not work, by the combination of closing the mouth, pinching the nose closed and attempting to blow through the nostrils (Valsalva maneuver).

Either an upper respiratory infection, such as a cold or sore throat, or a nasal allergic condition can produce enough congestion around the Eustachian tube to make equalization difficult. Consequently, the difference in pressure between the middle ear and aircraft cabin can build up to a level that will hold the Eustachian tube closed, making equalization difficult if not impossible. This problem is commonly referred to as an "ear block."

An ear block produces severe ear pain and loss of hearing that can last for several hours to several days. Rupture of the eardrum can occur in flight or after landing. Fluid can accumulate in the middle ear and become infected. An ear block is prevented by not flying with an upper respiratory infection or nasal allergic condition. Adequate protection is usually not provided by decongestant sprays or drops to reduce congestion around the Eustachian tube. Oral decongestants have side effects that can significantly impair pilot performance. If an ear block does not clear shortly after landing, a physician should be consulted.

4.3.2 Sinus block

During ascent and descent, air pressure in the sinuses equalizes with the aircraft cabin pressure through small openings that connect the sinuses to the nasal

passages. Either an upper respiratory infection, such as a cold or sinusitis, or a nasal allergic condition can produce enough congestion around the opening to slow equalization and, as the difference in pressure between the sinus and cabin mounts, eventually plug the opening. This "sinus block" occurs most frequently during descent.

A sinus block can occur in the frontal sinuses, located above each eyebrow, or in the maxillary sinuses, located in each upper cheek. It will usually produce excruciating pain over the sinus area. A maxillary sinus block can also make the upper teeth ache. Bloody mucus may discharge from the nasal passages.

A sinus block is prevented by not flying with an upper respiratory infection or nasal allergic condition. Adequate protection is usually not provided by decongestant sprays or drops to reduce congestion around the sinus openings. Oral decongestants have side effects that can impair pilot performance. If a sinus block does not clear shortly after landing, a physician should be consulted.

4.3.3 Hypoxia

Hypoxia is a state of oxygen deficiency in the body sufficient to impair functions of the brain and other organs. Hypoxia from exposure to altitude is due only to the reduced barometric pressures encountered at altitude, for the concentration of oxygen in the atmosphere remains about 21 percent from the ground out to space. The body has no built-in warning system against hypoxia.

Although deterioration in night vision occurs at a cabin pressure altitude as low as 5,000 feet, other significant effects of altitude hypoxia usually do not occur in the normal healthy pilot below 12,000 feet. From 12,000 to 15,000 feet of altitude, judgment, memory, alertness, coordination and ability to make calculations are impaired. Headache, drowsiness, dizziness and either a sense of euphoria or belligerence may also occur. In fact, pilot performance can seriously deteriorate within 15 minutes at 15,000 feet.

At cabin-pressure altitudes above 15,000 feet, the periphery of the visual field grays out to a point where only central vision remains (tunnel vision). A blue coloration (cyanosis) of the fingernails and lips develops. The ability to take corrective and protective action is lost in 20 to 30 minutes at 18,000 feet and 5 to 12 minutes at 20,000 feet, followed soon thereafter by unconsciousness.

The altitude at which significant effects of hypoxia occur can be lowered by a number of factors. Carbon monoxide inhaled in smoking or from exhaust fumes lowers hemoglobin (anemia), and certain medications can reduce the oxygen-carrying capacity of the blood to the degree that the amount of oxygen provided to body tissues will already be equivalent to the oxygen provided to the tissues when exposed to a cabin pressure altitude of several thousand feet. Small amounts of alcohol and low doses of certain drugs, such as antihistamines, tranquilizers, sedatives and analgesics can, through their depressant actions, render the brain much more susceptible to hypoxia. Extreme heat or cold, fever, and anxiety can increase the body's demand for oxygen, and hence its susceptibility to hypoxia.

Hypoxia can be prevented by: heeding factors that reduce tolerance to altitude, by enriching the inspired air with oxygen from an appropriate oxygen system and by maintaining a comfortable, safe cabin pressure altitude. For optimum protection, pilots are encouraged to use supplemental oxygen above 10,000 feet during the day and above 5,000 feet at night. The Federal Aviation Regulations require that the minimum flight crew be provided with and use supplemental oxygen after 30 minutes of exposure to cabin pressure altitudes between 12,500 and 14,000 feet,

and immediately on exposure to cabin pressure altitudes above 14,000 feet. Every occupant of the aircraft must be provided with supplement oxygen at cabin pressure altitudes above 15,000 feet.

4.4 Mountainous terrain

Flying in mountainous terrain requires special training that is beyond the scope of this course. Aircrews flying the mountains must complete a course such as *Mountain Fury*.

Briefly, when flying in mountainous areas it is recommended that flights be planned for early morning or late afternoon because heavy turbulence is often encountered in the afternoon, especially during summer. In addition, flying at the coolest part of the day reduces density altitude. Attempt to fly with as little weight as possible, but don't sacrifice fuel; in the event of adverse weather, the additional reserve could be a lifesaver.

Study sectionals for altitudes required over the route and for obvious checkpoints. Prominent peaks, rivers and passes make excellent checkpoints. Be aware that mountain ranges have many peaks that may look the same to the untrained eye, so continually crosscheck your position with other landmarks and radio aids if possible. Also, the minimum altitude at which many nav aids are usable will be higher in the mountains. For that reason, low-frequency navigation such as ADF, LORAN, or GPS tends to work best in the mountains.

Crews must be constantly careful that the search never takes them over terrain that rises faster than the airplane can climb. Narrow valleys or canyons that have rising floors must be avoided, unless the aircraft can be flown from the end of higher elevation to the lower end, or the pilot is *certain* that the aircraft can climb faster than the terrain rises. Careful chart study by the crew prior to flight will help identify this dangerous terrain.

A weather check is essential for mountain flying. Ask specifically about winds aloft even when the weather is good. Expect winds above 10,000 feet to be prevailing Westerlies in the mountain states. If winds aloft at your proposed altitude are above 30 knots, do not fly. Winds will be of much greater velocity in passes, and it will be more turbulent as well. Do not fly closer than necessary to terrain such as cliffs or rugged areas. Dangerous turbulence may be expected, especially when there are high winds.

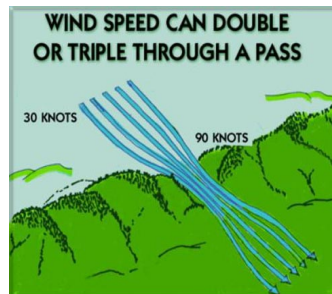
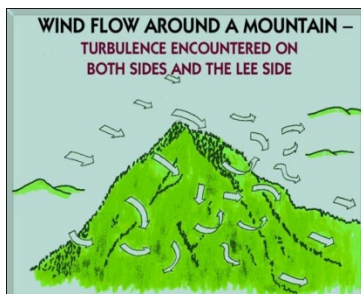

5. Navigation and Position Determination

Navigation is the process of continuously determining your position so you can get from one place to a desired location. By correctly using various navigational techniques, you can efficiently proceed from one point to the next while keeping off-course maneuvering, elapsed time, and fuel consumption to a minimum. Position determination (situational awareness) enables the crew to accurately determine and report position, respond quickly to changes and emergencies, locate targets, and record and report sightings. This chapter will cover the basic tools of navigation, navigational techniques, and the use of radio aids and instruments for navigation and position determination.

Some of the topics included in this chapter were covered in the Mission Scanner course. They are not included in the objectives but are reproduced here for review.

OBJECTIVES:

1. Discuss magnetic variation.
2. Discuss considerations for operating near controlled airports, and identify them on a sectional.
3. Discuss the following special use airspaces, and identify them on a sectional: {MO P-2012}
 - a. Prohibited and restricted areas
 - b. Military operating areas and training routes
4. Discuss the uses and limitations of the following Nav aids: {MO O-2011 & O-2012}
 - a. ADF
 - b. VOR
 - c. DME
 - d. GPS
5. Given a sectional chart, a plotter, and two airports: {MO O-2013}
 - a. Plot the course
 - b. Identify check points along the route
 - c. Calculate how long it should take to get from one airport to the other, flying at 100 knots and no wind
6. Given coordinates and a sectional, use the *Standardized Latitude and Longitude Grid System* to draw a 7.5° x 7.5° search grid. {MP O-2003}
7. Given a grid and Attachment E of the *U.S. National SAR Supplement to the International Aeronautical and Maritime SAR Manual*, use the CAP Grid System to draw a 7.5° x 7.5° search grid. {MP O-2003}

5.1 Navigation Terms

In order to effectively communicate with the pilot and ground teams, the scanner and observer must have a clear understanding of various terms that are used frequently when flying aboard CAP aircraft. These are not peculiar to search and rescue, but are used by all civilian and military aviators.

Course - The planned or actual path of the aircraft over the ground. The course can be either *true course* or *magnetic course* depending upon whether it is measured by referencing true north or magnetic north. The magnetic north pole is *not* located at the true North Pole on the actual axis of rotation, so there is usually a difference between true course and magnetic course.

Pilots measure true course against a meridian of longitude at the midpoint of each leg, and all of these meridians point to the true North Pole. However, since the aircraft compass can only point at the magnetic north pole you must apply *magnetic variation* to the true course to determine the magnetic direction you must fly in order to follow the true course. East magnetic variation is subtracted from measured true courses and west variation is added.

You can find magnetic variation factors in several places, and you will learn more about this in the section concerning charts. Magnetic variation factors also take into account abnormalities in the earth's magnetic field due to the uneven distribution of iron ore and other minerals.

Heading - The direction the aircraft is *physically* pointed. An airplane's track over the ground doesn't always correspond with the direction they're pointed. This is due to the effect of wind. True heading is based on the true North Pole, and magnetic heading is based on the magnetic north pole. Most airplane compasses can only reference magnetic north without resorting to advanced techniques or equipment, so headings are almost always magnetic.

Drift, or Drift Effect - The effect the wind has on an aircraft. The air mass an aircraft flies through rarely stands still. If you try to cross a river in a boat by pointing the bow straight across the river and maintaining that heading all the way across, you will impact the river bank downstream of your initial aim point due to the effect of the river current. In an aircraft, any wind that is not from directly in the front or rear of the aircraft has a similar affect. The motion of the airplane relative to the surface of the earth depends upon the fact that the airplane is moving relative to the air mass and the air mass is moving relative to the surface of the earth; adding these two gives the resultant vector of the airplane moving relative to the surface of the earth. The angle between the heading and the actual ground track is called the drift angle.

Drift Correction - A number of degrees added to or subtracted from the aircraft heading intended to negate drift or drift effect. In the rowboat example, if you had aimed at a point upstream of the intended destination, you would have crossed in a straighter line. The angle between the intended impact point and the upstream aim point is analogous to drift correction.

Ground Track - The actual path of an airplane over the surface of the earth.

Nautical mile (nm) - Distances in air navigation are usually measured in *nautical miles*, not statute miles. A nautical mile is about 6076 feet (sometimes rounded to 6080 feet), compared to 5280 feet for the statute mile. Most experienced aviators simply refer to a nautical mile as a mile. *Aircrews should remain aware of this difference when communicating with ground search teams because most ground or surface distances are measured using statute miles or kilometers.* To convert nautical miles into statute miles, multiply nautical miles by 1.15. To find kilometers,

multiply nautical miles by 1.85. Also, one nautical mile is equal to one minute of latitude: this provides a convenient scale for measuring distances on any chart. Nautical miles are abbreviated "nm".

Knots - The number of nautical miles flown in one hour. Almost all airspeed indicators measure speed in terms of knots (kts), not miles per hour. One hundred knots indicates that the aircraft would fly one hundred nautical miles in one hour in a no wind condition. Some aircraft have airspeed indicators that measure speed in statute miles per hour, and the observer should be alert to this when planning. Knots can be used to measure both *airspeed* and *ground speed*. The air mass rarely stands still, and any headwind or tailwind will result in a difference between the aircraft's airspeed and ground speed. If you fly eastward at 100 knots airspeed, with the wind blowing from the west at 15 knots, your speed over the ground would be 115 knots. If you fly westbound into the wind, your speed over the ground drops to 85 knots.

5.2 Latitude and longitude

In order to successfully navigate any vessel, the navigator must first have an understanding of the basic tools of navigation. Navigation begins with is a common reference system or imaginary grid "drawn" on the earth's surface by *parallels of latitude* and *meridians of longitude*. This system is based on an assumption that the earth is spherical. In reality, it's slightly irregular, but the irregularities are small, and errors caused by the irregularities can be easily corrected. The numbers representing a position in terms of latitude and longitude are known as the coordinates of that position. Each is measured in degrees, and each degree is divided into 60 smaller increments called minutes. Each minute may be further divided into 60 seconds, or tenths and hundredths of minutes.

5.2.1 Latitude

Latitude is the angular distance of a place north or south from the equator. The equator is a great circle midway between the poles. Parallel with the equator are lines of latitude. Each of these parallel lines is a small circle, and each has a definitive location. The location of the latitude is determined by figuring the angle at the center of the earth between the latitude and the equator.

The equator is latitude 0°, and the poles are located at 90° latitude. Since there are two latitudes with the same number (two 45° latitudes, two 30°, etc.) the letter designators N and S are used to show which latitude is meant. The North Pole is 90° north of the equator and the South Pole is 90° south of the equator. Thus the areas between the poles and the equator are known as the northern and southern hemispheres.

5.2.2 Longitude

We have seen how the north-south measurement of positions is figured. With only latitude, it is still impossible to locate a point. This difficulty is resolved by use of longitude, which indicates east-west location.

There is no natural starting point for numbering longitude, so the solution is to select an arbitrary starting point. When the sailors of England began to make charts, they chose the meridian through their principal observatory in Greenwich, England,

as the zero line. Most countries of the world have now adopted this line. The Greenwich meridian is sometimes called the first or prime meridian (actually, the zero meridian).

Longitude is counted east and west from this meridian through 180°. Thus the Greenwich Meridian is zero degrees longitude on one side of the earth, and after crossing the poles it becomes the 180th meridian (180° east or west of the 0-degree meridian). Therefore we have all longitudes designated either west or east, for example, E 140° or W 90°. The E and W designations define the eastern and western hemispheres.

5.2.3 Position location

Refer to Figure 5-1. *By convention, latitude is always stated first.*

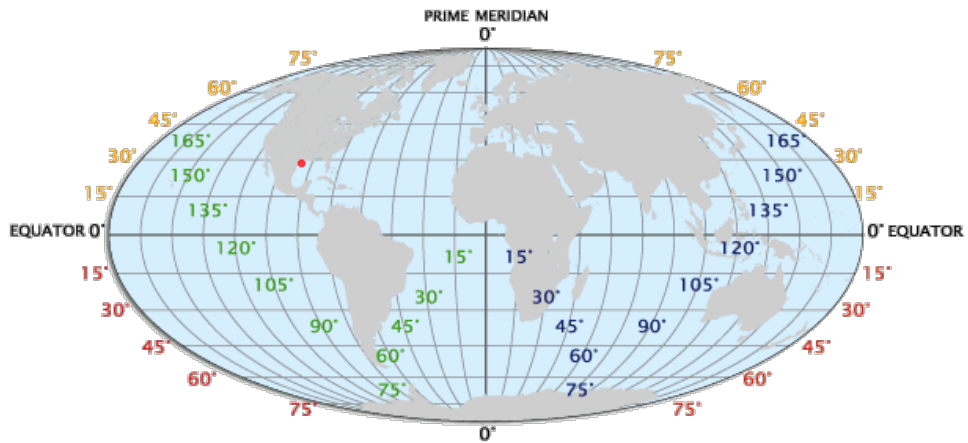

Figure 5-1

This system is used to precisely locate any point on the earth's surface. When identifying a location by its position within this latitude-longitude matrix, you identify the position's *coordinates*, always indicating latitude first and then longitude. For example, the coordinates N 35° 13.2', W 101° 32.4' are read as "North thirty-five degrees, thirteen point two minutes; West one hundred-one degrees, thirty-two point four minutes." If you locate these coordinates on *any* appropriate aeronautical chart of North America, you will *always* find Rick Husband Amarillo International Airport in Amarillo, Texas.

It is important to remember that in the northern hemisphere, latitude numbers increase as you proceed from south to north (more north), and decrease as you move north to south (less north). In the western hemisphere, longitude numbers increase when proceeding east to west (more west), and decrease when moving west to east (less west). Since the GPS receiver displays latitude and longitude with a great degree of accurately, pilots can use this tool to navigate and to fly very precise search patterns.

Note: Geocoded map viewers often express, for North America, latitude as a positive number (e.g., 39.04) and longitude as a negative number (e.g., -95.37).

5.3 Magnetic variation

Variation is the angle between true north and magnetic north. It is expressed as east variation or west variation depending upon whether magnetic north (MN) is

to the east or west of true north (TN), respectively. The north magnetic pole is located close to latitude N 71°, longitude W 96° - about 1,300 miles from the geographic or true north pole. If the earth were uniformly magnetized, the compass needle would point toward the magnetic pole, in which case the variation between true north and magnetic north could be measured at any intersection of the meridians.

Actually, the earth is not uniformly magnetized. In the United States the needle usually points in the general direction of the magnetic pole but it may vary in certain geographical localities by many degrees. Consequently, the National Ocean Survey has carefully determined the exact amount of variation at thousands of selected locations in the United States. The amount and the direction of variation, which change slightly from time to time, are shown on most aeronautical charts as broken red lines, called isogonic lines, which connect points of equal magnetic variation. The line connecting points at which there is no variation between true north and magnetic north is the agonic line.

5.4 Airspace

For traffic management purposes, the FAA has designated that all airspace within the United States falls into one of six different class designations (A, B, C, D, E, and G). Flight within each class requires certain communication, equipment, pilot experience, and, under some circumstances, weather requirements. Specific requirements for each class are complex, but they can be simplified somewhat with several broad generalizations.

Regardless of flight rules, the most stringent requirements normally are associated with flight in airspace immediately surrounding a major airport, due to the high density of operations conducted there. Observers must be alert for required communication when it appears a search will be conducted within 40 miles of a major airport or within 5 miles of any airport having an operating control tower. These are color coded *blue* on sectional charts. Major airports in this context are generally near major metropolitan areas and appear at or near the center of concentric blue-, magenta-, or gray-colored circles. Also, crew resource management and the "sterile cockpit" environment are essential in or near these busy airports in order to "see and avoid" obstacles and other aircraft.

When operating the aircraft under VFR, in most classes of airspace the pilot can change the direction of flight or aircraft altitude without any prior coordination with air traffic control. This will almost always be the case when weather allows visual search patterns below the bases of the clouds.

5.4.1 Special Use Airspace

Although not a class of airspace, the FAA has designated some airspace as "special use" airspace. The FAA has specifically created special use airspace for use by the military, although the FAA retains control. Active special use airspace can become a navigational obstacle to search aircraft and uncontrolled objects (e.g., missiles) within the airspace can present a serious threat to the safety of CAP aircraft and personnel. Special use airspace normally appears on sectional charts as irregularly shaped areas outlined by *either blue or magenta hatched lines*. It is also identified by either a name, such as Tyndall E MOA, or an alphanumeric identifier like R-4404A.

Prohibited Areas contain airspace within which the flight of aircraft is prohibited for national security or other reasons. An example is the airspace around the White House.

In the first example, the letters MOA (Military Operations Area) indicate that the Tyndall E airspace is a military operating area. Within its boundaries, the military may be conducting high-speed jet combat training or practicing air-to-ground weapons attack, without objects actually being released from the aircraft. Figure 8-2 illustrates how the MOA is portrayed on the sectional chart. MOA boundaries and their names are always printed in *magenta* on the sectional chart.

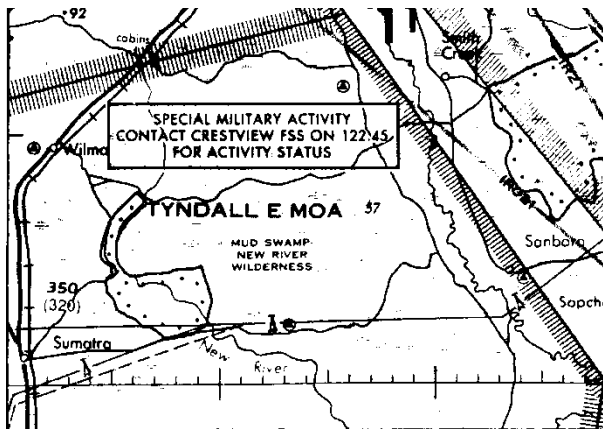

Figure 8-2

Civilian aircraft operating under VFR are *not* prohibited from entering an active MOA, and may do so at any time without any coordination whatsoever (although this is considered foolish by many pilots). As stated earlier, since the FAA retains control of the airspace, it is prudent to contact the controlling air traffic facility before continuing a search into any MOA.

Military aircraft, often flying at very low altitudes and at high speeds, are usually not in radar or radio contact with the air traffic controller (nor can they see or hear you). A controller can only provide positive separation to civilian IFR aircraft from the MOA boundary, *not* from the military aircraft itself. This may force significant maneuvering off your intended course.

In the second example, the “R” prefix to the five-letter identifier indicates this is a *Restricted Area*. The Army may be conducting artillery firing within this airspace, or military aircraft may be practicing actual air-to-surface bombing, gunnery, or munitions testing. Shells, bombs, and bullets, as well as the dirt and fragments they throw into the air on ground impact, present a severe hazard to any aircraft that might come in their path. Figure 8-3 illustrates how a typical restricted area is portrayed on the sectional chart. The restricted area’s boundaries are always printed in *blue*.

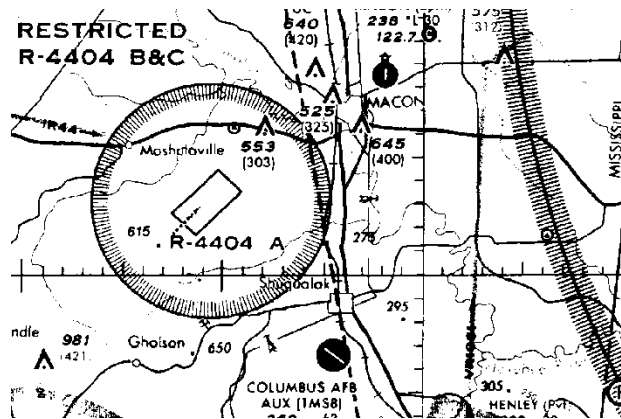

Figure 8-3

Warning Areas are similar to restricted areas, except that they are beyond the three-mile limit from the U.S. coastline and are therefore in international airspace. Alert Areas show airspace within which there may be a lot of pilot training or unusual aerial activity.

Hours of use and vertical limits of special use airspace areas, as well as the FAA facility controlling each area, are printed in one of the margins of the sectional chart. If the CAP crew has any doubt about entering special use airspace, it should contact the appropriate air traffic control facility first to check the status of the area in question.

5.4.2 Military Training Routes

Although not classified by the FAA as special use airspace, military training routes (MTRs) are for military low-altitude high-speed training. An understanding of each type of training route, and the manner in which an active route can affect other traffic, will help the CAP aircrew accomplish their intended mission.

Military training routes that may be used by high-speed jet aircraft are identified by one of two designations, depending upon the flight rules under which the military operates when working within that airspace. *Instrument Routes (IR)* and *Visual Routes (VR)* are identified on sectional aeronautical charts by medium-weight solid gray lines with an alphanumeric designation. 4-digit numbers identify MTRs flown at or below 1500 feet AGL; 3-digit numbers identify those flown above 1500 feet AGL. In Figure 8-4 there are two such examples east of the Clarksville Airport symbol -- IR-120, and VR-1102.

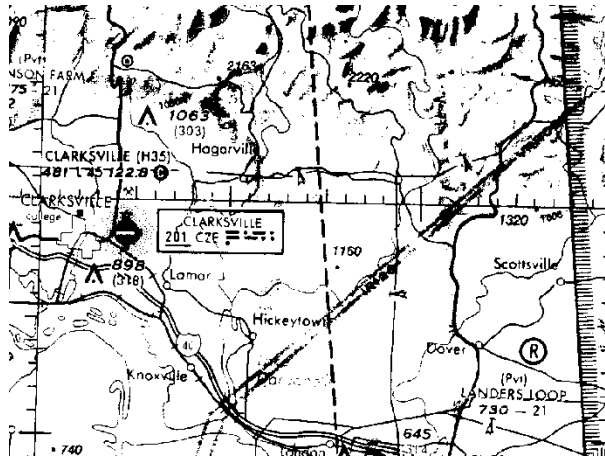

Figure 8-4

Only route centerlines are printed on sectional charts, but each route includes a specified lateral distance to either side of the printed centerline and a specific altitude “block”. Route widths vary, but can be determined for any individual route by requesting Department of Defense *Flight Information Publication AP-1B* at the Flight Service Station.

The letters *IR* in IR-120 indicate that military aircraft operate in that route according to IFR clearances issued by air traffic control. Other non-military VFR aircraft may enter the lateral or vertical boundaries of an active IR route without prior coordination, while aircraft operating IFR are kept out by air traffic control. Just as in the case of a MOA, air traffic control may not have radar and radio contact with the military aircraft using the route. Therefore, it is necessary to provide separation between other IFR aircraft and the route airspace regardless of where the military aircraft may be located along the route. This may force either a route or altitude change. Civil Air Patrol members can request the status of IR routes from the controlling air traffic facility.

The letters *VR* in VR-1102 indicate that the military operates under VFR when operating within the lateral and vertical limits of that airspace. The see-and-avoid concept applies to *all* civilian and military aircraft operating there, and all crew members must be vigilant in visual lookout when within or near a VR training route. Many military missions go to and from visual training routes' start and exit points on IFR clearances, and the prudent crew can inquire about the status of the route with air traffic control when operating through or near a VR training route.

You can determine *scheduled* military activity for restricted areas, MOAs, and military training routes by checking *Notices to Airmen* (NOTAMS) at the Flight Service Station. However, checking with the air traffic control facilities is preferable since it will reveal *actual*, “real time” activity versus *scheduled* activity. When flying through any special use airspace or training route, crewmembers should be alert and cautious at all times, because incorrect or incomplete coordination between the military and the FAA is the rule rather than the exception. NOTAMS can be viewed (e.g., by location, route, lat/long, etc.) at <http://notams.aim.faa.gov/notamSearch/nsapp.html#/>.

The FAA now has a website that graphically depicts the real-time status of almost every SUA in the country at <http://sua.faa.gov/sua/siteFrame.app>. SUA can also be found on the Air National Guard’s site (<http://www.seeandavoid.org>), or on AOPA’s website under “Airport Directory.”

5.5 Electronic Aids to Navigation (Nav aids)

From the standpoint of a mission aircrew, navigational instruments are the means to an end. Navigational equipment allows the aircraft to be flown to a desired location, such as a search pattern entry point, with precision and economy. Once in the search or assessment area, this equipment allows the pilot to fly the assigned area precisely and thoroughly. Nav aids also enable the crew to track their position and record sightings. From the mission staff's viewpoint, proper use of this equipment assures them that the assigned area was actually flown -- the only variables left to accommodate are search effectiveness and the inherent limitations of scanning.

This section will cover some of the electronic means available that can help in navigating. These systems not only can help you determine your position in reduced visibility or over desolate terrain, but can help you more accurately fly search and assessment patterns and report your observations to ground personnel or to mission base.

One drawback to all of this sophisticated equipment is that they may distract the pilot (and observer) from looking outside of the aircraft. The great majority of CAP missions are performed in VFR conditions, and the CAP aircrew must not forget the importance of looking where you're going. The best way to avoid this trap is to become and continue to be very familiar with the operation of this equipment. Training and practice (along with checklists or aids) allows each crewmember to set or adjust instruments with minimum fuss and bother, thus allowing them to return their gaze outside the aircraft where it belongs. All members of the aircrew should be continuously aware of this trap.

Additionally, it is important that observers use this equipment to help the pilot maintain situational awareness. The aircrew should always know the aircraft's position on the sectional chart, and these instruments enable them to do so with great accuracy.

5.5.1 Automatic Direction Finder (ADF)

The automatic radio compass, generally known as the Automatic Direction Finder (ADF), is used to receive radio guidance from stations such as four-course ranges, radio beacons, and commercial broadcast facilities. The automatic direction finder indicates the direction of the station being received. This direction is shown in relation to the heading of the aircraft. The ADF is the least accurate of all the navigational instruments.

Probably the most common use of the automatic direction finder is in "homing". The pilot tunes in a desired station, and then flies directly to that station by keeping the ADF indicating needle on the zero mark. When the needle points to the zero mark, the aircraft is headed toward the station. When the station is passed, the needle will swing around to the 180-degree position, indicating that the station is behind.

The ADF has three primary components -- a transmitter on the ground, a receiver and an indicator, both in the aircraft. Transmitters include non-directional radio beacons (NDBs) and commercial AM radio stations. Each transmitter emits a single signal on a specific frequency in all directions. ADF equipment aboard the aircraft indicates the *relative* bearing of the station, or its relative direction from the aircraft. In Figure 5-5, the airplane is shown flying north, or flying a heading and a course of 000°. The ADF "indicator" illustrated shows the direction to the

transmitter is 30° to the right of the plane's nose. In the illustration only 0, 090, 180, and 270 are shown on the indicator, and that is true of many ADF indicators. You may have to interpret index marks between these major bearings to determine the exact bearing to the station.

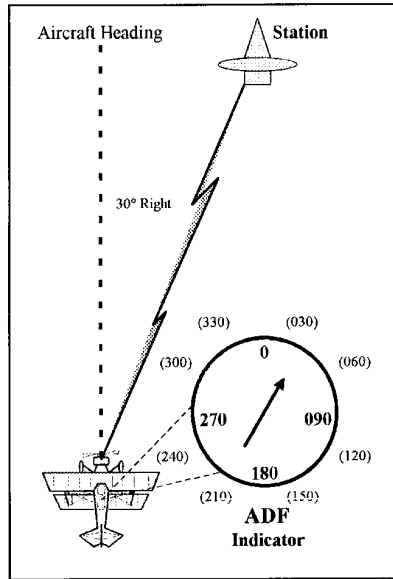

Figure 5-5

If you turn the aircraft 30° to the right (heading 030), the plane will point directly at the station, and the pointer will now point at 0° relative bearing. In a no-wind condition, if you maintained that 030 heading and the pointer at 0° relative bearing, you would fly directly to that transmitter (Figure 5-6).

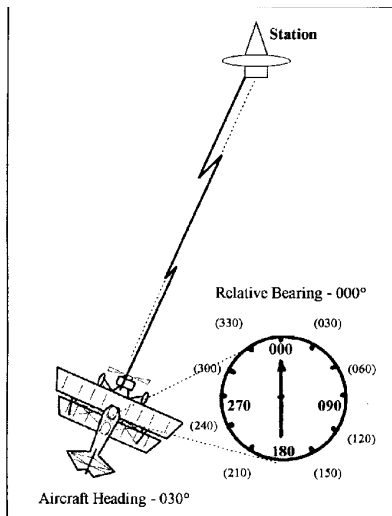

Figure 5-6

In a crosswind, the pilot estimates the airplane's drift, and computes a drift correction factor to be added to or subtracted from the aircraft heading. If he estimates 5° of drift to the right, his drift correction will be to subtract 5° from the airplane's heading, and turn the aircraft 5° to the left. The aircraft would thus have a heading of 025, its course over the ground would remain 030, and the ADF would show a relative bearing of 005, or 5° to the right. In the rowboat-crossing-the-river analogy, the boat's bow points upstream, but due to the current, it travels in a straight line across the river. The aim point is slightly to the right of the bow as the boat proceeds across.

All ADF stations transmit an audible identifier that you must identify before using the signal for navigation. All ADFs are highly susceptible to interference when thunderstorms are in the general vicinity, and their transmissions are restricted to line-of-sight only. Signals can also be blocked by terrain or other obstructions, especially when the aircraft is operating at low altitudes.

5.5.2 Very High Frequency Omnidirectional Range (VOR)

The very high frequency omnidirectional range (VOR) radio navigation system operates on a specific frequency in the VHF range of 109.0 to 117.9 megahertz and transmits 360 directional radio beams or *radials* that, if visible, would resemble the spokes radiating from the hub of a bicycle wheel. Each station is aligned to magnetic north so that the 000 radial points from the station to magnetic north. Every other radial is identified by the magnetic direction to which it points *from* the station, allowing the pilot to navigate directly to or from the station by tracking along the proper radial. The VOR is an accurate and reliable navigational system, and is the current basis for all instrument flight in the U.S.

Like the ADF, the main components are in three pieces: the ground transmitter, the receiver, and the indicator. Controls on the receiver are covered in the Nav/Comm section of Aircraft Instruments.

To help light plane pilots plan and chose routes, the FAA has developed the Victor airway system, a "highway" system in the sky that uses specific courses to and from selected VORs. When tracing the route of a missing aircraft, search airplanes may initially fly the same route as the missing plane, so it is very important you know the proper procedures for tracking VOR radials.

Figure 5-7 shows a VOR indicator and the components that give the information needed to navigate, including a vertical pointer, OFF/TO-FROM flag or window, and a course-select knob. The vertical pointer, also called a course deviation indicator (CDI) is a vertically mounted needle that swings left or right showing the airplane's location in relation to the course selected beneath the course pointer. The OFF/TO-FROM indicator shows whether the course selected will take the airplane to or from the station. When it shows "OFF", the receiver is either not turned on or it's not receiving signals on the selected frequency. The course selector knob is used to select the desired course to fly either toward or away from the station.

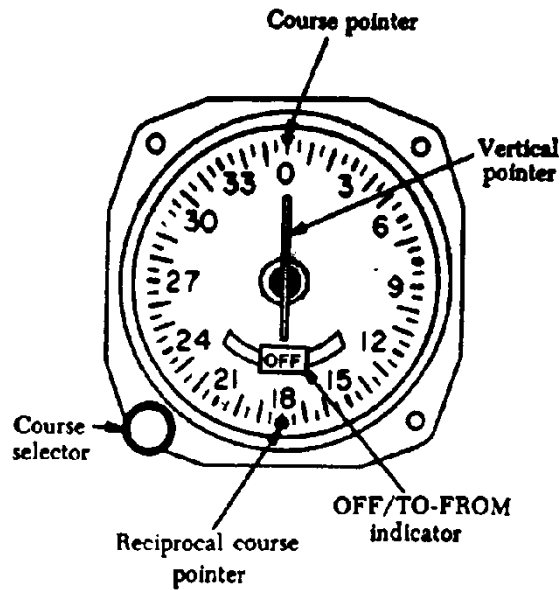

Figure 5-7

Flying to the VOR station is simple. Find the station's frequency and its Morse code audio identifier using the sectional chart. Next, tune the receiver to the correct frequency and identify the station by listening to its Morse code. If you can't positively identify the station, you should not use it for navigation.

After identifying the station, slowly turn the course selector knob until the TO-FROM indicator shows TO and the CDI needle is centered. If you look at the course that's selected beneath the course pointer at the top of the indicator, you'll see the course that will take you directly to the station. The pilot turns the aircraft to match the airplane's heading with that course and corrects for any known winds by adding or subtracting a drift correction factor. The pilot keeps the CDI centered by using very small heading corrections and flies the aircraft directly to the station. The 'TO/FROM' indicator will switch from 'TO' to 'FROM' when the aircraft passes over the station.

To fly away from a station: Tune and identify the VOR and then slowly rotate the course select knob until the CDI is centered with a FROM indication in the window. Look at the selected course, again normally at the top of the indicator, to determine the outbound course. The pilot turns the aircraft to that heading, corrects for wind drift, and keeps the CDI needle in the center to fly directly away from the station.

Figure 5-8 shows a hypothetical VOR with the 0° inbound and outbound courses simulating a Victor airway. In order to fly that airway, set 0° beneath the course pointer and determine the aircraft's position relative to the selected course. Each airplane has the 0° course selected under its course pointer, but the top airplane has a "FROM" indication. This indicates that the plane is north of the station. The vertical pointer's right deflection indicates that the desired 0° course from the station is off to the right. Since the plane is flying about a 330° heading, the pilot would turn back to the right to join the 0° course outbound from the station.

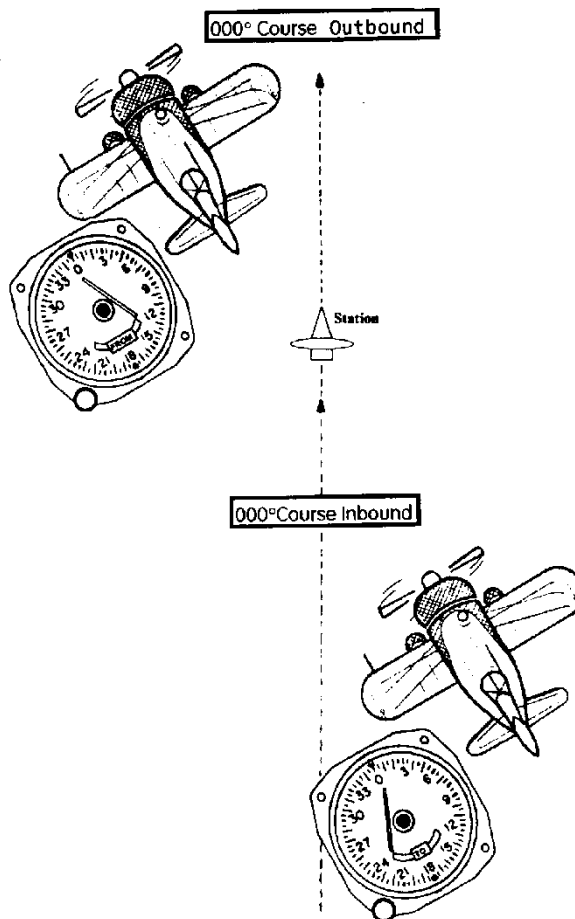

Figure 5-8

The indicator in the airplane southeast of the station has a "TO" indication, which, with the 0° course selected indicates its south of the station. The pointer's left deflection indicates the 0° course to the station is to the plane's left. Since this plane also is heading 330°, it does not need to turn farther to *intercept* the 0° course to the station.

The display in the north plane would show the same indication if it were heading 360° or 030°, since in any case the 0° course from the station is still to the right. Likewise, the south plane would have the same indications regardless of the direction it's pointed. At any given point in space, the VOR display always gives the same indication *regardless* of the direction the airplane is pointing.

VOR can be used like ADF to determine a position in relation to a selected station, and the process is considerably simpler due to the directional nature of the VOR signals. Rotate the course select knob slowly until the CDI is centered with a FROM indication, and look beneath the reciprocal course pointer for the radial. You can draw that radial as a line of position from the station's symbol on the sectional chart. Even better, if you can receive two stations you can establish position with very good accuracy by drawing the two radials: where they cross is where you are (this is often referred to as a "cross-radial").

Each VOR station on the chart has a surrounding compass ring already oriented towards magnetic north. Therefore, it isn't necessary to correct for

magnetic variation. The use of the printed compass circle surrounding the station on the chart eliminates the need for using the plotter's protractor as well. Use any straight edge to draw the radial by connecting the station symbol with a pencil line through the appropriate radial along the circle. The radial drawn on the chart shows direction, but does not indicate distance from the station. But, you can get an accurate position "fix" by repeating the procedure with another VOR.

Using VOR has several advantages over using ADF. The directional nature of the VOR transmissions makes them easier to use for navigation than the non-directional signal from a NDB. Signals from VORs are also much less susceptible to interference from thunderstorms and static electricity produced by weather phenomena. The directional signals from VORs also make it much easier to correct for crosswinds. Like ADF, VOR is limited by signal blockage from high terrain and obstructions or during flight at very low altitudes. Finally, if the VOR equipment has failed you will know it.

In order to use a VOR for instrument flight, the receiver must be functionally checked every thirty days (or prior to any instrument flight). This check must be performed by an instrument rated pilot and logged in the aircraft's AIF.

5.5.3 Distance Measuring Equipment (DME)

Finding bearing or direction to a station solves only one piece of the navigation puzzle. Knowing the distance to the station is the final piece to the puzzle that allows fliers to navigate more precisely. You can use the cross-radial method discussed previously to obtain your distance from the stations, but an even easier method is provided by distance measuring equipment (DME).

DME continuously measures the distance of the aircraft from a DME ground unit that is usually co-located with the VOR transmitter (then called a VORTAC). The system consists of a ground-based receiver/transmitter combination called a transponder, and an airborne component called an interrogator. The interrogator emits a pulse or signal, which is received by the ground-based transponder. The transponder then transmits a reply signal to the interrogator. The aircraft's DME equipment measures the elapsed time between the transmission of the interrogator's signal and the reception of the transponder's reply and converts that time measurement into a distance.

This measurement is the actual, straight-line distance from the ground unit to the aircraft, and is called *slant range* (Figure 5-9). This distance is continuously displayed, typically in miles and tenths of miles, on a dial or digital indicator on the instrument panel. When DME is used in combination with VOR, a pilot can tell at a glance the direction and distance to a tuned station.

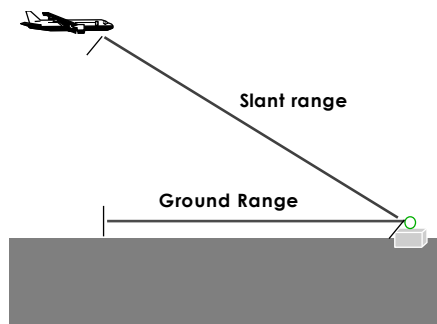

Figure 5-9

DME measures straight-line distance, or slant range, so *there is always an altitude component within the displayed distance*. If you fly toward a station at an altitude of 6,000 feet over the station elevation, the DME will never read zero. It will continuously decrease until it stops at one mile. That mile represents the aircraft's altitude above the station. The distance readout will then begin to increase on the other side of the station. Under most circumstances the altitude component of slant range can be ignored, but when reporting position using DME, especially to air traffic controllers, it is customary to report distances in "DME", not nautical miles, e.g., "Holly Springs 099° radial at 76 DME."

Some DME equipment can also compute and display the actual ground speed of the aircraft, provided that the aircraft is tracking *directly* to or from the ground station (and usually only after the aircraft has been stabilized on this track for one or two minutes). In all other circumstances, the ground speed information is not accurate and should be ignored.

5.5.4 Global Positioning System (GPS)

Initially developed by the Department of Defense for military users, the Global Positioning System has become the most accurate navigational system available to civilian aircraft operators. Certified systems will eventually replace many of the navigational systems already discussed, as they already have replaced the ADF.

The system relies on a chain of 24 satellite transmitters in polar orbits about the earth. The speed and direction of each satellite, as well as each satellite's altitude is precisely maintained so that each satellite remains in a highly accurate and predictable path over the earth's surface at all times.

GPS receivers process signals transmitted by these satellites and triangulate the receiver's position, which the user again can read directly in latitude and longitude coordinates from a digital display. Similar additional features as those discussed in LORAN are available and vary depending upon the design and manufacturer. The system is substantially more accurate than LORAN, VOR, DME, or ADF and has several advantages.

Because the transmitters are satellite based, not ground based, and the signals are essentially transmitted *downward*, system accuracy is not significantly degraded in mountainous terrain. Additionally, the system is not normally vulnerable to interference from weather or electrical storms. Receivers can typically process as many as twelve received signals simultaneously, and can automatically deselect any satellite whose signal doesn't meet specific reception parameters. The system can function with reasonable accuracy using as few as three received signals.

To a new operator, the GPS is complex and can initially increase the user's workload. Pilots and observers *must read the operating manual or instructions* and become thoroughly familiar with GPS operation before flight, so that operating the GPS *will not become a distraction* from more important tasks. Also, many manufacturers have CD simulators that allow individuals to practice use of the GPS on a computer.

CAP is standardizing the fleet with the Garmin Apollo GX-50/55 (Figure 5-10), the G1000® and GNS 430w. Even if your aircraft has a different GPS, the basic functions are the same.



Figure 5-10

All GPS units typically display bearing and distance to a waypoint, altitude, ground speed, estimated time to the waypoint (ETE), and ground track. GPS databases also contain extensive information about a selected waypoint (e.g., an airport) such as runway length and alignment, lighting, approaches, frequencies, and even FBO details such as the availability of 100LL fuel and hours of operation.

The GPS receiver allows the pilot to:

Fly directly to any position

The ability to fly directly to any position (e.g., an airport, navaid, intersection, or user waypoint) saves time and fuel. This reduces transit time, thus allowing more of the crew's allowed duty day to be spent in the search area.

Any of these positions can be entered as the destination through a simple procedure. Additionally, all GPS have a "Nearest Airport" and "Nearest VOR" function, where you can easily display a list of the nearest airports or VORs and then select it as your destination. Positions can also be grouped into flight plans.

Once the destination is entered into the GPS, the heading and the ground track can be monitored. *By matching the heading and ground track (or keeping the CDI centered), you are automatically compensating for wind and thus flying the shortest possible route to your destination.* The GX-50/55 and G1000® have a Moving Map feature that simplifies this task.

Fly between any two points

The ability to fly directly between any two points greatly improves search effectiveness. These points, usually defined by latitude and longitude (Lat/Long), can be flown in either of two ways:

- The points can be entered into the GPS as user-defined waypoints. The waypoints can then be recalled in the same manner as you would display an airport or navaid, or they can be entered into a flight plan.
- The pilot can fly between the points by observing the current Lat/Long display (i.e., a real-time readout of latitude and longitude)

Two factors have reduced search effectiveness in the past: drifting off course due to shifts in wind direction, and drifting off course because of the lack of adequate boundaries (e.g., cross-radials or visible landmarks). Now any search pattern can be flown precisely without relying on cross-radials or ground references. The crew and the mission staff know that a route or area has been covered thoroughly. Also, GPS allows the crew to remain within assigned boundaries, which greatly improves safety when more than one aircraft is in the search area at the same time.

Obviously, the GPS also allows the aircrew to easily and accurately determine their current position and to determine the position of ground sightings. The GPS will display your current position as Lat/Long coordinates (most accurate), or you can determine distance and heading to airports, VORs or user waypoints and plot your position accordingly.

The Apollo GX-50/55 has a "moving map," which greatly enhances situational awareness. It shows aeronautical and ground features in (scalable) detail, and also displays special use airspace. Another feature, added to the unit for CAP use, is the SAR MAP mode. This feature allows you to select, define and fly directly to a CAP grid, and to superimpose a search pattern on the grid (e.g., parallel, creeping line or expanding square). See Chapter 8 and Attachment 2.

5.6 Sectional Charts

The most important tool you will use in both mission flight planning and execution is the chart. Although the earth is spherical, not flat, cartographers can portray small portions of the earth's surface as though it is a flat surface, without affecting accurate navigation. Visual air navigation charts must have certain basic features including:

- Navigational reference system superimposed over the terrain depiction
- Identifiable, measurable scale to measure distances
- Detailed graphic depiction of terrain and culture, or man-made features

Highway road maps are usually not acceptable for air navigation, since most don't have detailed terrain depiction and also lack the superimposed reference system. Many aeronautical charts have such small scales that the makers are unable to show required levels of detail when trying to put a large area into a small chart space. The most useful chart that has been widely accepted for visual, low-altitude navigation is the *sectional aeronautical chart*, sometimes simply referred to as the "sectional". [Download the *Aeronautical Chart User's Guide* at https://www.faa.gov/air_traffic/flight_info/aeronav/digital_products/aero_guide/media/Chart_Users_Guide_12thEd.pdf]

NOTE: Use of Electronic Flight Bags / Electronic Chart Displays (EFBs/ECDs) will be conducted in accordance with CAP Guidance located in the "CAPR 70-1 & Aircraft Ops Info" section of the Aircraft Ops and Stan/Eval web page. Due to the large number of flight aids for smartphones and tablets, they are not discussed.

Sectionals use a scale of one to five hundred thousand, or 1:500,000, where all features are shown 1/500,000 of their actual size (1 inch = 6.86 nm). This allows accurate depiction of both natural and cultural features without significant clutter.

Sectionals portray the following:

- Physical, natural features of the land, including terrain contours or lines of equal elevation and obstructions to flight
- Man-made or cultural development, like cities, towns, towers, and racetracks
- Visual and radio aids to navigation, airways, and special-use airspace
- Airports and airport data, lines of magnetic variation, controlled airspace, obstructions and other important information
- VFR waypoints

An often overlooked but vital part of the sectional (or any other chart) is the 'Legend.' This is a written explanation of symbols, projections, and other features used on the chart. Figure 5-11 illustrates a portion of the St. Louis sectional chart legend. Other important areas of the sectional chart are its title page or "panel", and the margins around the chart edges. The margins contain supplemental radio frequency information, details about military or *special use airspace*, and other applicable regulations. The title panel identifies the region of the country shown by the chart, indicates the scale used in drawing the chart, explains elevations and contour shading, and shows the expiration date of the chart and effective date of the next issue of that chart. Expired charts should not be used on missions because information on the charts may no longer be correct.

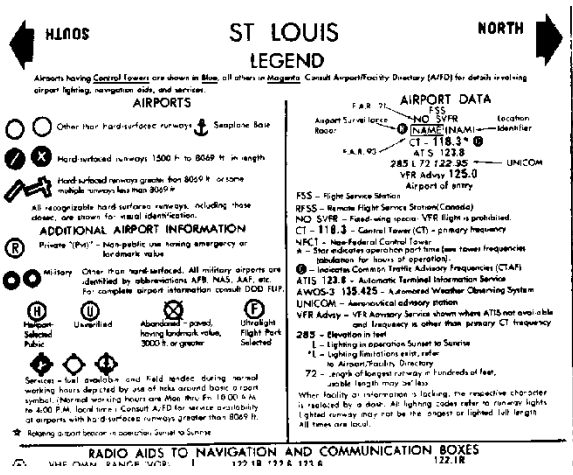

Figure 5-11

Another chart commonly used by VFR pilots is the VFR Terminal Area Charts. The scale of a VFR Terminal Area Chart is 1:250,000 (1 inch = 3.43 nm). The information found on these charts is similar to that found on sectional charts, but the larger scale provides more detail and allows more precise navigation in busy airspace (e.g., Dallas/Ft. Worth Class B airspace).

Both the Sectional and VFR Terminal Area Charts are revised semi-annually. *It is vitally important that you keep current charts in the aircraft at all times.* Obsolete charts should be discarded and replaced by new editions. To make certain that your sectionals are up-to-date, you can refer to the National Oceanic and Atmospheric Administration (NOAA) Aeronautical Chart Bulletin in the Airport/Facility Directory. This bulletin provides the VFR pilot with the essential information necessary to update and maintain current charts. It lists the major changes in aeronautical information that have occurred since the last publication date of each chart, such as:

- Changes to airports, controlled airspace and radio frequencies
- Temporary or permanent closing of runways or navigational aids
- Changes special use airspace that present hazardous conditions or impose restrictions on the pilot

5.7 Chart Interpretation

A significant part of air navigation involves interpreting what one sees on the chart, then making comparisons outside the aircraft. It is most important that

observers be thoroughly acquainted with the chart symbols explained in the chart legend, and the relief information discussed on the chart's title panel. [You may download an *FAA Aeronautical Chart User's Guide* from the FAA Air Traffic website to use as a learning aid and quick reference guide.]

Basic chart symbols can be grouped into cultural features, drainage features, and relief features. Understanding cultural features is straightforward, and they usually require little explanation. Villages, towns, cities, railroads, highways, airports or landing strips, power transmission lines, towers, mines, and wells are all examples of cultural features. The chart legend explains the symbols used for most cultural features, but if no standard symbol exists for a feature of navigational significance, the cartographer frequently resorts to printing the name of the feature itself, such as *factory* or *prison*, on the chart.

Drainage features on charts include lakes, streams, canals, swamps, and other bodies of water. On sectional charts these features are represented by lightweight solid blue lines for rivers and streams; large areas of water, such as lakes and reservoirs, are shaded light blue with the edges defined by lightweight solid blue lines. Under most conditions, the drainage features on a map closely resemble the actual bodies of water. However, certain bodies of water may change shape with the season, or after heavy rains or drought. Where this shape change occurs with predictability, cartographers frequently illustrate the maximum size expected for a body of water with light-weight, blue, dashed lines. If you intend to use drainage features for navigation, you should consider recent rains or dry spells while planning and remember the body of water may not appear exactly as depicted on the chart.

5.7.1 Relief

Relief features indicate vertical topography of the land including mountains, valleys, hills, plains, and plateaus. Common methods of depicting relief features are contour lines, shading, color gradient tints, and spot elevations. Contour lines are the most common method of depicting vertical relief on charts. The lines do not represent topographical features themselves, but through careful study and interpretation, you can predict a feature's physical appearance without actually seeing it. Each contour line represents a continuous imaginary line on the ground on which all points have the same elevation above or below sea level, or the zero contours. Actual elevations above sea level of many contour lines are designated by a small break in the line, while others are not labeled. Contour interval, or vertical height between each line, is indicated on the title panel of sectionals.

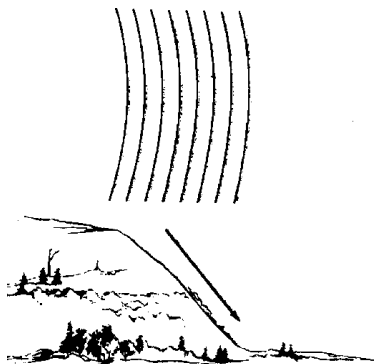

Figure 5-12

Contour lines are most useful in helping us to visualize vertical development of land features. Contour lines that are grouped very closely together, as in Figure 5-

12, indicate rapidly changing terrain, such as a cliff or mountain. More widely spaced lines indicate more gentle slopes. Absence of lines indicates flat terrain. Contour lines can also show changes in the slope of terrain. Figures 5-13 and 5-14 show how to predict the appearances of two hillsides based upon their depictions on a chart.

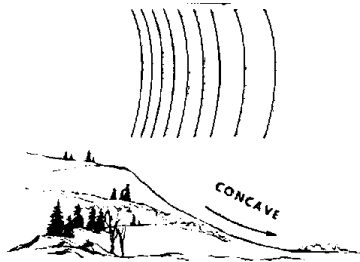

Figure 5-13

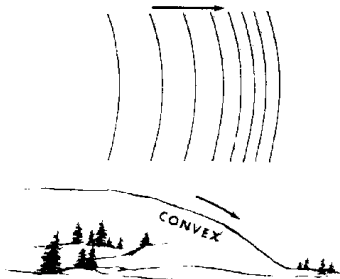

Figure 5-14

Precise portrayal and interpretation of contour lines allows accurate prediction of the appearance of terrain you expect to fly over or near. Figure 5-15 shows the depiction of a saddle in a short ridgeline, and Figure 5-16 shows how it might appear from the aircraft. Many other types of terrain features can be predicted by careful study of contour lines. An outdated chart can be a useful tool for helping to develop your skills, but don't use it in flight.

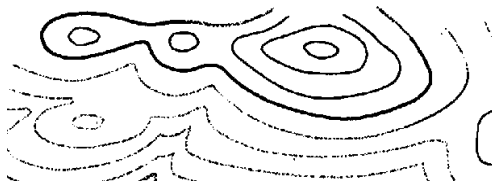

Figure 5-15



Figure 5-16

Shading is added to sectional charts to help highlight and give contrast to the contour lines. These tiny gray dots are applied adjacent to selected contour lines

and give the contours a three-dimensional appearance. This makes it easier to imagine the physical appearance of the shaded topographical feature.

Gradient tints, the "background" colors on charts, indicate general areas of elevation. The height range assigned to each gradient color is indicated on the title panel of each sectional chart. Areas that are near sea level are pale green, while *high terrain is color-coded a deep red/brown*. Intermediate elevations are indicated by brighter shades of green, tan, or lighter shades of red/brown.

A spot elevation is the height of a specific charted point. On sectional charts, this height is indicated by a number next to a black dot, the number indicating the height of the terrain above sea level.

5.7.2 Aeronautical Data

The aeronautical information on the sectional charts is for the most part self-explanatory. An explanation for most symbols appears in the margin or at the bottom of the chart. Information concerning very high frequency (VHF) radio facilities such as tower frequencies, omnidirectional radio ranges (VOR), and other VHF communications frequencies is shown in blue. A narrow band of blue tint is also used to indicate the centerlines of Victor Airways (VOR civil airways between Omni range stations). Low frequency-medium frequency (LF/MF) radio facilities are shown in magenta (purplish shade of red).

In most instances, FAA navigational aids can be identified by call signs broadcast in International Morse Code. VOR stations and Non-directional Radio Beacons (NDB) use three-letter identifiers that are printed on the chart near the symbol representing the radio facility.

Runway patterns are shown for all airports having permanent hard surfaced runways. These patterns provide for positive identification as landmarks. All recognizable runways, including those that may be closed, are shown to aid in visual identification. Airports and information pertaining to airports having an airport traffic area (operating control tower) are shown in blue. All other airports and information pertaining to these airports are shown in magenta adjacent to the airport symbol that is also in magenta.

The symbol for obstructions is another important feature. The elevation of the top of obstructions above sea level is given in blue figures (without parentheses) adjacent to the obstruction symbol.

Immediately below this set of figures is another set of lighter blue figures (enclosed in parentheses) that represent the height of the top of the obstruction above ground-level. Obstructions which extend less than 1,000 feet above the terrain are shown by one type of symbol and those obstructions that extend 1,000 feet or higher above ground level are indicated by a different symbol (see sectional chart). Specific elevations of certain high points in terrain are shown on charts by dots accompanied by small black figures indicating the number of feet above sea level.

The chart also contains larger bold face blue numbers that denote Maximum Elevation Figures (MEF). These figures are shown in quadrangles bounded by ticked lines of latitude and longitude, and are represented in thousands and hundreds of feet above mean sea level. The MEF is based on information available concerning the highest known feature in each quadrangle, including terrain and obstructions (e.g., trees, towers, and antennas). When looking at MEFs, remember that the data on which they are based are not verified by field surveys.

If a man-made obstacle is more than 200 feet above the highest terrain in the quadrangle, the cartographer determines the elevation of the top of the obstacle above mean sea level. Then he (or she) adds the possible vertical error of the source information, such as 100 feet. Finally, the resulting figure is rounded up to next higher hundred-foot level. For example, a quadrangle showing the highest mountain peak (known as the critical elevation figure) at 5,357 feet above mean sea level would gain 100 feet (5,457) and that would be rounded to the next hundred (5,500); add on 200 more feet for a possible uncharted obstacle on the mountaintop, and the MEF for that quadrangle will be charted at 5,700 feet MSL. If terrain or a "natural vertical obstacle" (such as a tree) is the highest feature in the quadrangle, the cartographer determines the feature's elevation. Next, the possible vertical error (100 feet) is added and then another 200 feet is added to that to allow for natural or man-made obstacles that are not portrayed on the chart (because they are below the chart's minimum height specifications for their portrayal). Finally, the resulting figure is rounded up to the next higher hundred feet.

Since CAP aircraft regularly fly at (and occasionally, below) 1000' AGL, aircrews should exercise extreme caution because of the numerous structures extending up as high as 1000' – 2000' AGL. Additionally, guy wires that are difficult to see even in clear weather support most truss-type structures; these wires can extend approximately 1500 feet horizontally from a structure. Therefore, all truss-type structures should be avoided by at least 2000 feet (horizontally and vertically).

Overhead transmission and utility lines often span approaches to runways and scenic flyways such as lakes, rivers and canyons. The supporting structures of these lines may not always be readily visible and the wires may be virtually invisible under certain conditions. Most of these installations do not meet criteria that determine them to be obstructions to air navigation and therefore, do not require marking and/or lighting. The supporting structures of some overhead transmission lines are equipped with flashing strobe lights, which indicate that wires exist between the strobe-equipped structures. Also, some lines have large orange "balls" spaced along their length.

5.8 Chart Preparation

Careful chart preparation and route study before the flight can increase your efficiency and decrease your workload during the flight. You should try to develop a systematic approach to chart preparation.

The first step in planning any leg is to locate the departure point and destination on the chart, and lay the edge of a special protractor, or plotter, along a line connecting the two points, as shown in Figure 5-17. Read the true course for this leg by sliding the plotter left or right until the center point, or grommet, sits on top of a line of longitude. When the course is more to the north or south, you can measure it by centering the grommet on a parallel of latitude, then reading the course from the inner scale that's closer to the grommet.

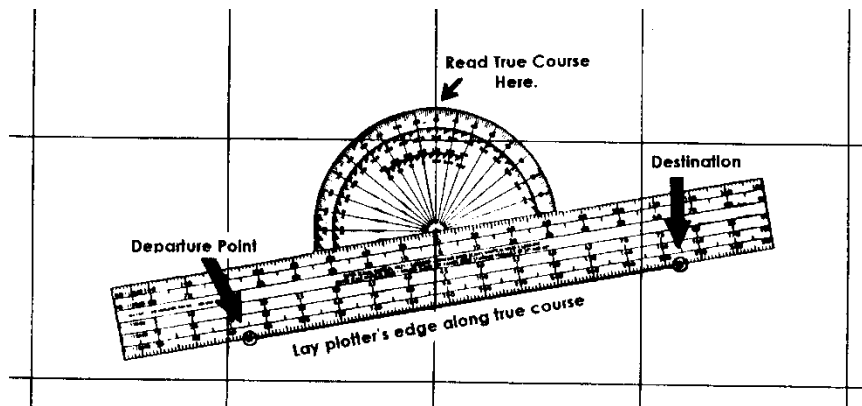

Figure 5-17

The discussion that follows concerns one leg of a flight from University-Oxford airport, near Oxford, Mississippi, to the Ripley airport, near Ripley, Mississippi. The same basic principles used in planning this single leg are used in all air navigation and apply to more complex search patterns.

In Figure 8-18, the chart for this "flight", the two points are connected with a solid line. This line represents the *true* course from Oxford to Ripley and is 051° . If you were interested in going the opposite direction, the course would be the *reciprocal* course, 231° , which also appears on the arc of the plotter. Remain aware of the relationship among general directions -- north, east, south, and west -- and their directions indicated by degrees on the compass -- 000, 090, 180, and 270, respectively. Since almost all charts are printed with north to the top of the chart, you can look at the intended direction of flight, which runs right and up, or to the northeast, and know immediately that 051 is correct and 231 is not.

Notice the broken line that nearly passes through the Oxford airport symbol, and follow it toward the bottom of the page. Near the bottom, you'll see the numbers $1^\circ 30'$ E. This is the magnetic variation correction factor for that area.

If you subtract east variation or add west variation to the true course, you can determine the magnetic course. Most fliers advocate writing the "mag" course right on the chart. Round $1^\circ 30'$ down to 1° and subtract that from the true course to obtain 050 for the magnetic course. Also notice that Oxford is within the boundaries of the Columbus 3 Military Operating Area (MOA). To avoid an unpleasant encounter with a high-speed jet, you can look at the table in the chart's margin, partially shown in Figure 5-18, and determine that jets using this area do not operate below 8,000 feet. You can note this on the chart with a line over 8,000, which means to remain below 8,000 feet.

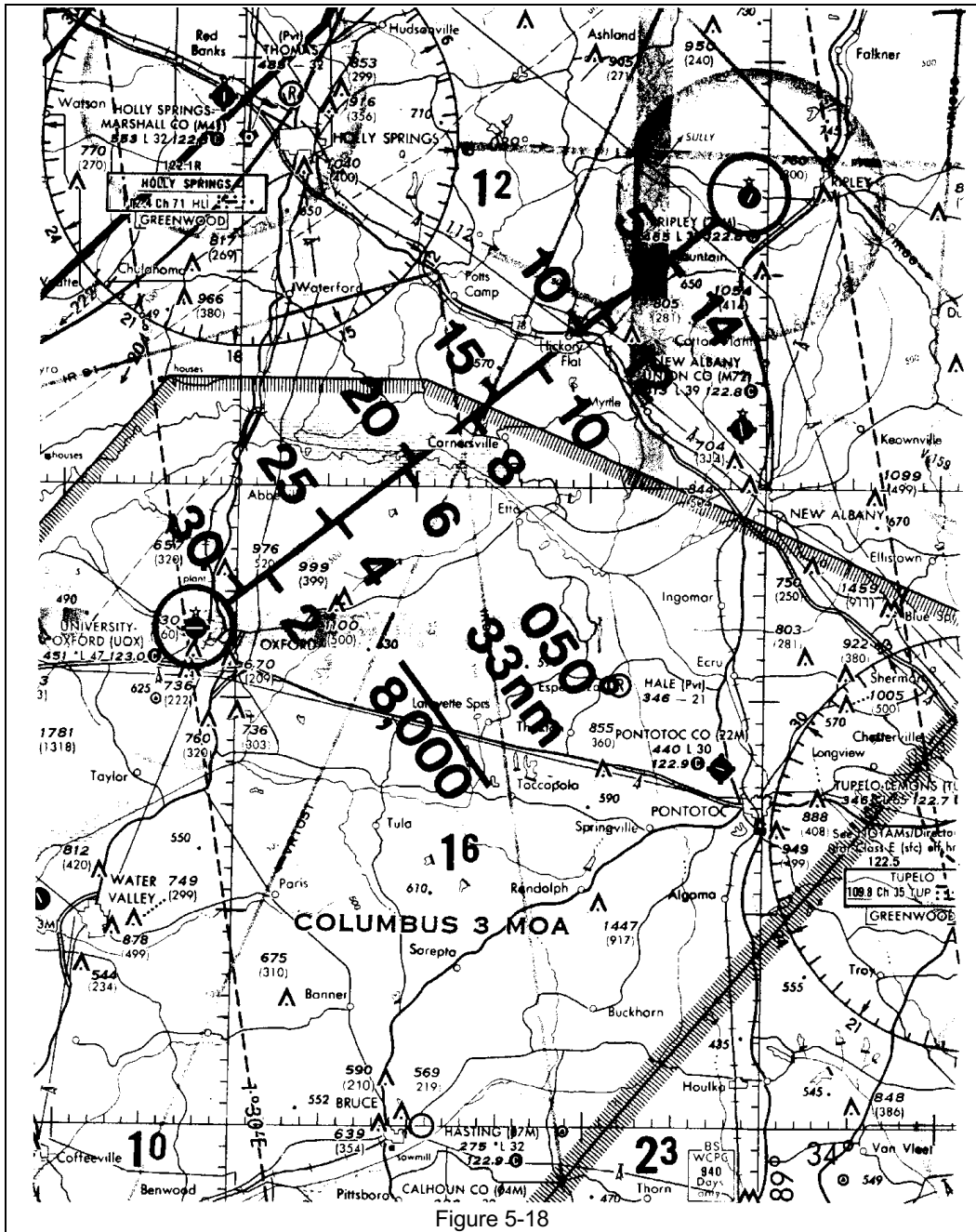

Figure 5-18

Next you must determine the total distance you're going to fly. Measure this using the scale that's printed on the plotter's straight edge, making sure you use a scale appropriate to the scale of the chart. Use the 1:500,000 scale for sectionals. As an alternative, lay a paper's edge along the course line, make pencil marks on the paper's edge at the two airports, and then lay that same edge along the line of longitude. By simply counting the minute marks on the chart's longitude line that fall between those two pencil marks, you can determine the distance between the two airports in nautical miles. In the example, Oxford and Ripley are 33 nm, or 33 nautical miles, apart.

There are a number of ways you can add information to your chart that will help during the flight. Each flier has his own techniques or variations of the techniques presented here, and over time, you will develop a preference for methods that work best for you.

Tick marks along the course line at specific intervals will help you keep track of your position during flight. Some individuals prefer 5 or 10 nm intervals for tick marks, while others prefer 2 or 4 nm intervals. Four-nautical mile spacing works well for aircraft that operate at approximately 120 knots. Since the 120-knot airplane travels 2 nm every minute, each 4 nm tick mark represents approximately two minutes of flight time. This will become more significant when you study navigational methods in later paragraphs. On the example chart, you have tick marks on the right side of the course line at 4 nm intervals. If the search airplane has an airspeed indicator marked in miles per hour instead of knots, it may be advantageous to space the tick marks in statute mile intervals.

On the left side of the course line you have more tick marks, at 5 nm intervals, but measured backward from the destination. In flight, these continuously indicate distance remaining to the destination. Later in this chapter you will learn about radio aids to navigation that you can use to continuously confirm remaining distance.

The next step in preparing the chart is to identify "*check points*" along the course; you can use these to check your position on or off course, and the timing along the leg. Prominent features that will be easily seen from the air make the best checkpoints, and many fliers like to circle them or highlight them with a marker in advance. On the example, you might expect to see the large towers east of Oxford about 3 nm to your right shortly after takeoff, and expect later to see the town of Cornersville. Shortly thereafter, you expect to see the road and railroad bend east of Hickory Flat, followed by the Ripley Airport itself. In the example, the checkpoints are widely spaced, but on actual missions checkpoint spacing will be controlled by the search altitude and weather conditions and visibility at the time of the flight.

MOA NAME	ALTITUDE OF USE	TIME OF USE	CONTROLLING AGENCY
ANNE HIGH	7,000	SR - SS MON - FRI	ZFW CNTR
BIRMINGHAM	10,000	0700-2200	ZTL CNTR
COLUMBUS 1, 2, & 3	8,000	SR - SS MON - FRI	ZME CNTR
MERIDIAN 1 EAST	8,000	SR - SS MON - FRI	ZME CNTR

Altitudes indicate floor of MOA. All MOAs extend to but do not include FL180 unless otherwise indicated in tabulation or on chart.

Other information that may be written on the chart includes estimated times of arrival (ETA) at each checkpoint and reminders like "check gas", "switch tanks", or "contact mission base". Crewmembers are likely to spend less time "fishing" about the cockpit trying to find information in flight if it is already written on the chart.

5.8.1 Plotting the Course

Lay the chart on a table or other flat surface, and draw a straight line from your point of departure to the destination (airport to airport). This can be done with a plain ruler or, better, with a navigation plotter. Mark off the distance in 10 or 20-mile intervals. Use a sharp pencil, making sure the line is straight and that it intersects the center of the airport symbol. Make a careful study of the intervening country and

decide whether to fly direct or whether a detour may be desirable in order to avoid flying over large bodies of water, mountains, or other hazardous terrain. Note whether landing fields are available enroute for refueling or use in case of an emergency. Using an appropriate groundspeed and the actual distance to destination, estimate your time enroute. You should know the range (in fuel hours) of the aircraft you intend to fly. From this you can determine whether or not you can make the flight without fueling stops. Be sure to allow at least a one-hour reserve fuel supply.

5.8.2 Checkpoints

Now that you have established a definite course from departure to destination, study the terrain on the chart and choose suitable checkpoints. These can be distinctive patterns: railroad tracks or highways, sharp bends in rivers, racetracks, quarries, and small lakes. As your flight progresses, the checkpoints will be used to maintain the correct course and to estimate the groundspeed. Your checkpoints need not be on your direct line of flight, but should be near enough to be easily seen. For this part of the preflight planning it is essential that you know the chart symbols (explained on the back of the chart) in order to recognize the many landmarks available as checkpoints.

5.8.3 Enclosing the Course

This consists of using an easily recognizable feature on the terrain that lies parallel to your course. It may serve as a guideline or bracket, and may be a river, railroad track, or a prominent highway. The ideal arrangement would be to have a continuous guideline on each side of the route five to 10 miles from the line of flight. It is seldom that two can be found, but one will usually serve satisfactorily. If you should temporarily lose your checkpoints, you can fly to this chosen guideline and reset course. Another landmark should be used as an end-of- course check to prevent flying beyond your destination should you miss it or actually fly directly over it.

5.8.4 True Course

Having plotted your course and made an accurate listing of checkpoints and the distances between them, measure the true course counting clockwise from true north. Use the meridian (north-south) line approximately midway between departure and destination. Your true course can be measured with a common protractor, or better still with a navigation plotter.

When using the GPS, the pilot will be able to easily follow the precise true course between departure point and destination. Without the GPS, magnetic variation, wind and compass deviation would affect the aircraft's ground track.

5.9 Tracking and Recording Position

We have discussed how to use navigational aids and a sectional chart to plot and navigate a course; the same principles are used during flight to keep track of the aircraft's current position and to record sightings. VORs, DME and the GPS are

excellent tools that allow you to fix your current position. This information, in turn, allows a crewmember to plot that position on a sectional chart.

Being able to record and report the position of a ground feature is a critical skill in all CAP ES missions (e.g., search and rescue, disaster relief and assessment, CD, and homeland security). Once an aircrew locates a downed aircraft or determines the location of a breach in a levy, they must be able to pinpoint the location on the sectional and report that position to others. Since the details on the sectional chart are often not detailed enough to be useful to ground units, the scanner or observer usually has to transfer that information to a map (e.g., road or topographical).

The state of knowing where you (the aircraft) are at all times is a large part of "maintaining situational awareness" (see Chapter 11 for further discussion on situational awareness). Nav aids allow you to fix your position with great accuracy, and ground features that you can relate to the sectional chart provide confirmation of what your Nav aids are telling you about your position. In some situations you may not be able to receive signals from VORs or NDBs, and the GPS may be your only useful nav aid; if the GPS fails, then recording your position on the sectional chart is your only means of position determination.

Knowing the aircraft's position at all times is essential if an in-flight emergency should occur. Equipment malfunctions, an electrical fire, or a medical emergency can necessitate landing at the nearest airport: if you don't know where you are, how can you find the nearest airfield?

5.10 Standardized Grid Systems

A grid is a network of regularly spaced horizontal and vertical lines used to help quickly locate points on a map. Most city street maps have grid systems that help motorists locate streets or other points of interest. A commonly used grid system on city street maps involves numerical and alphabetical references. Regularly spaced letters may be printed across the top of such a map designating imaginary vertical columns, while regularly spaced numbers are printed down the sides of the map designating imaginary horizontal rows. If you want to find Maple Street and the map directory indicates Maple Street is located in section K-5, you then look at or near the intersection of column K with row 5. Within that area, you should find Maple Street.

You can construct a grid system on any type of chart or map. You may use numbers and letters like street maps, or you could use only numbers. In either case, the system should give *every* user a common, standardized method for identifying a location according to its position within the grid. It is very easy to exchange location information over the radio using the grid system. With the known grid positions, other team members can quickly determine on their own charts the location of a sighting or point of interest.

Grid systems are especially helpful when locating a position that has no nearby distinguishable landmarks or features, such as buildings, roads, or lakes. Grid systems will work anywhere, even in the middle of large lakes, in deep woods, or in swamps. Anyone can develop a workable system provided that all members of the search team use the same grid system.

The Civil Air Patrol has found it useful to construct similar grid systems on aeronautical sectional charts for search and rescue operations. Sectional charts cover a land area approximately seven degrees of longitude in width and four

degrees of latitude in height. Some maps, like city maps, already have grid systems constructed on them, but sectional charts do not. Below we discuss the ways to grid sectional charts for SAR purposes.

5.10.1 Standardized Latitude and Longitude Grid System

The Standardized Latitude and Longitude Grid System is used by some CAP Wings and by many federal and state agencies. It can be used on any kind of chart that has lines of latitude and longitude already marked. In this system, 1-degree blocks are identified by the intersection of whole numbers of latitude and longitude, such as 36-00N and 102-00W. These points are always designated with the latitude first, such as 36/102, and they identify the area north and west of the intersection of these two lines. In Figure 5-19, the gray shading identifies section 36/102.

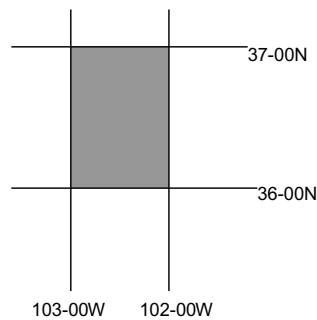

Figure 5-19

Next, the 1° grid is divided into four quadrants using the 30' lines of latitude and longitude. Label each quadrant A through D; the northwest quadrant being 36/102A, the northeast 36/102B, the southwest 36/102C, and the southeast 36/102D, as shown in Figure 5-20.

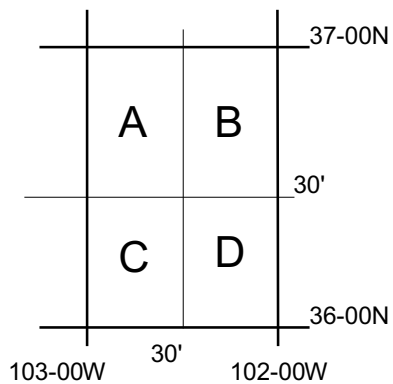

Figure 5-20

Each quadrant can also be divided into four 15' x 15' sub-quadrants, labeled 36/102AA, AB, AC, and AD, again starting with the most northwest and proceeding clockwise, as shown in Figure 5-21. [Note: The GX-50/55 can be set to use basic grids, refer to Attachment 2.]

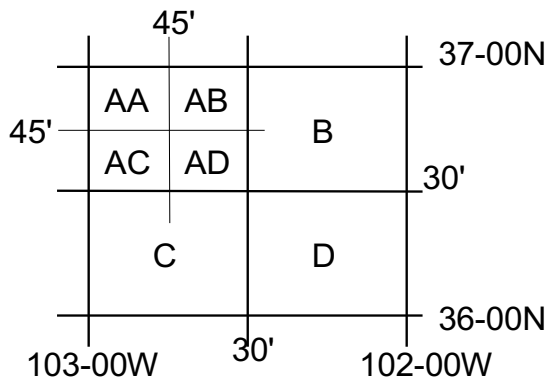

Figure 5-21

Finally, each quadrant can be further subdivided into four 7.5' x 7.5' sub-quadrants, such as dividing 36/102AA into 36/102AAA, AAB, AAC, and AAD.

5.10.2 CAP Grid System

The CAP Grid System uses a special grid system built upon the matrix of parallels of latitude and meridians of longitude and the sectional aeronautical chart. Information pertaining to this grid system can be found in Attachment E of the *U.S. National SAR Supplement to the International Aeronautical and Maritime SAR Manual*.

Table 5-1 shows the latitude and longitude boundaries of each sectional chart. The St. Louis chart, for example, covers an area that is bounded by the following latitudes and longitudes: North 40° 00' (north boundary), North 36° 00' (south boundary), West 91°-00' (west boundary), and West 84°-00' (east boundary).

Chart	Identifier	North Grid Limit	South Grid Limit	West Grid Limit	East Grid Limit	Total Grids
Seattle	SEA	49-00N	44-30N	125-00W	117-00W	576
Great Falls	GTF	49-00N	44-30N	117-00W	109-00W	576
Billings	BIL	49-00N	44-30N	109-00W	101-00W	576
Twin Cities	MSP	49-00N	44-30N	101-00W	93-00W	576
Green Bay	GRB	48-15N	44-00N	93-00W	85-00W	544
Lake Huron	LHN	48-00N	44-00N	85-00W	77-00W	512
Montreal	MON	48-00N	44-00N	77-00W	69-00W	512
Halifax	HFX	48-00N	44-00N	69-00W	61-00W	512
Klamath Falls	LMT	44-30N	40-00N	125-00W	117-00W	576
Salt Lake City	SLC	44-30N	40-00N	117-00W	109-00W	576
Cheyenne	CYS	44-30N	40-00N	109-00W	101-00W	576
Omaha	OMA	44-30N	40-00N	101-00W	93-00W	576
Chicago	ORD	44-00N	40-00N	93-00W	85-00W	512
Detroit	DET	44-00N	40-00N	85-00W	77-00W	512
New York	NYC	44-00N	40-00N	77-00W	69-00W	512
San Francisco	SFO	40-00N	36-00N	125-00W	118-00W	448
Las Vegas	LAS	40-00N	35-45N	118-00W	111-00W	476
Denver	DEN	40-00N	35-45N	111-00W	104-00W	476
Wichita	ICT	40-00N	36-00N	104-00W	97-00W	448
Kansas City	MKC	40-00N	36-00N	97-00W	90-00W	448
St. Louis	STL	40-00N	36-00N	91-00W	84-00W	448
Cincinnati	CVG	40-00N	36-00N	85-00W	78-00W	448
Washington	DCA	40-00N	36-00N	79-00W	72-00W	448

Los Angeles	LAX	36-00N	32-00N	121-30W	115-00W	416
Phoenix	PHX	35-45N	31-15N	116-00W	109-00W	504
Albuquerque	ABQ	36-00N	32-00N	109-00W	102-00W	448
Dallas-Fort Worth	DFW	36-00N	32-00N	102-00W	95-00W	448
Memphis	MEM	36-00N	32-00N	95-00W	88-00W	448
Atlanta	ATL	36-00N	32-00N	88-00W	81-00W	448
Charlotte	CLT	36-00N	32-00N	81-00W	75-00W	384
El Paso	ELP	32-00N	28-00N	109-00W	103-00W	384
San Antonio	SAT	32-00N	28-00N	103-00W	97-00W	384
Houston	HOU	32-00N	28-00N	97-00W	91-00W	384
New Orleans	MSY	32-00N	28-00N	91-00W	85-00W	384
Jacksonville	JAX	32-00N	28-00N	85-00W	79-00W	384
Brownsville	BRO	28-00N	24-00N	103-00W	97-00W	384
Miami	MIA	28-00N	24-00N	83-00W	77-00W	384

Table 5-1

The sectional grid system used by Civil Air Patrol divides each sectional's area into 448 smaller squares. The grid squares usually begin with the most northwest square on the entire sectional, and continuing straight east through number 28. The numbering resumes in the second row, with number 29 placed beneath number 1, 30 beneath 2, and so on through 56. The third row begins with number 57 beneath numbers 1 and 29, and continues through 84. Numbering continues through successive rows until all 448 squares have a number.

The process begins by dividing the whole area into 28 *1-degree* grids, using whole degrees of latitude and longitude as shown in Figure 5-22. Then each 1-degree grid is divided into four *30-minute* grids, using the 30-minute latitude and longitude lines as shown in Figure 5-23. Finally, each of the 30-minute grids is divided into four *15-minute* grids, using the 15- and 45-minute latitude and longitude lines as shown in Figure 5-24. [Note: The information on this chart is contained in the GX-50/55 database.]

In Figure 5-24, each 15-minute grid square has the number it would have received if this demonstration had started with the entire St. Louis sectional chart.

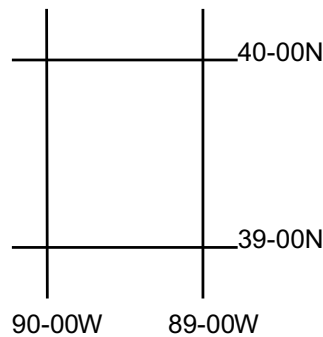

Figure 5-22

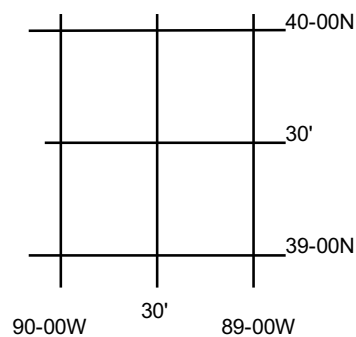

Figure 5-23

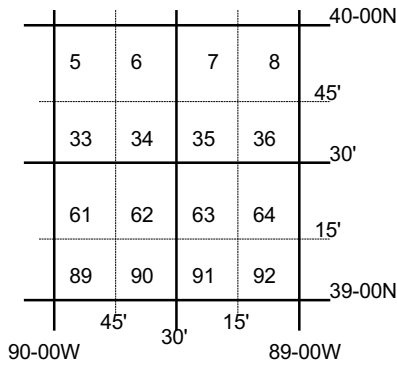

Figure 5-24

Table 5-2 represents the division of the whole St. Louis sectional into 15-minute grids, with respective grid numbers assigned. To conserve space Table 8-2 doesn't include the area between longitudes 85° W and 89°30'W.

40-00N	91-00W					90-00W				85-00W			
	MKC 25	MKC 26	MKC 27	MKC 28	STL 5	STL 6	< >	< >	STL 25	STL 26	STL 27	STL 28	
	MKC 53	MKC 54	MKC 55	MKC 56	STL 33	STL 34	< >	< >	STL 53	STL 54	STL 55	STL 56	
	MKC 81	MKC 82	MKC 83	MKC 84	STL 61	STL 62	< >	< >	STL 81	STL 82	STL 83	STL 84	
39-00N	MKC 109	MKC 110	MKC 111	MKC 112	STL 89	STL 90	< >	< >	STL 109	STL 110	STL 111	STL 112	
	MKC 137	MKC 138	MKC 139	MKC 140	STL 117	STL 118	< >	< >	STL 137	STL 138	STL 139	STL 140	
	MKC 165	MKC 166	MKC 167	MKC 168	STL 145	STL 146	< >	< >	STL 165	STL 166	STL 167	STL 168	
	MKC 193	MKC 194	MKC 195	MKC 196	STL 173	STL 174	< >	< >	STL 193	STL 194	STL 195	STL 196	
38-00N	MKC 221	MKC 222	MKC 223	MKC 224	STL 201	STL 202	< >	< >	STL 221	STL 222	STL 223	STL 224	
	MKC 249	MKC 250	MKC 251	MKC 252	STL 229	STL 230	< >	< >	STL 249	STL 250	STL 251	STL 252	
	MKC 277	MKC 278	MKC 279	MKC 280	STL 257	STL 258	< >	< >	STL 277	STL 278	STL 279	STL 280	
	MKC 305	MKC 306	MKC 307	MKC 308	STL 285	STL 286	< >	< >	STL 305	STL 306	STL 307	STL 308	
37-00N	MKC 333	MKC 334	MKC 335	MKC 336	STL 313	STL 314	< >	< >	STL 333	STL 333	STL 334	STL 336	

Table 5-2

Returning to Table 5-1, notice that the eastern limit of the Kansas City sectional grid, 90° 00'W, is one full degree of longitude east of the western limit of the St. Louis sectional, 91° 00' W. The two sectionals overlap by one full degree of longitude. When drawing a grid over this overlap area, which numbers would you assign to these grid squares, the Kansas City or St. Louis grid numbering?

In cases where two sectionals overlap one another, the Civil Air Patrol always uses the numbering system for the western-most chart of the two in question. You can see this in Table 8-2, where the overlap area between 90° 00' and 91° 00', shown in the first 4 vertical columns, is identified with Kansas City (MKC) grid numbering, not St. Louis. Note that, since the Kansas City grid numbering is used in this overlap area, the first 4 columns of the St. Louis grid numbering system are omitted. Several other such overlaps exist within the grid system.

Attachment 2 tells you how many grids are in each sectional. If the table is not available you can compute it using the grid limits. Take the difference in the northern and southern grid limits and multiply by 4 (1/4 degree x 4 to make 1 degree.) Do the same for the east and west grid limits. Then multiply the two products to get the total number of grids on your sectional. For example, the St. Louis sectional extends

4° from 40°-00' N to 36°-00' N. Each degree will contain 4 grids, so there will be 4 x 4 = 16 rows of grids. The sectional extends east/west for 7° from 91°-00' W - 84°-00' W, so there will be 7 x 4 = 28 columns of grids. Therefore, the total number of grids on the chart is 16 x 28 = 448. Remember some sectionals don't start counting at 1 because of overlap with an adjacent sectional. If your sectional does this you need to memorize the first grid number:

When circumstances require, a 15-minute grid can be divided into 4 more quadrants using 7 1/2 degree increments of latitude and longitude, creating 4 equal size grids that are approximately 7 1/2 miles square. The quadrants are then identified alphabetically - A through D - starting with the northwest quadrant as A, northeast as B, southwest as C and southeast as D, as in Figure 5-25. A search area assignment in the southeast quadrant may be given as "Search STL 5D."

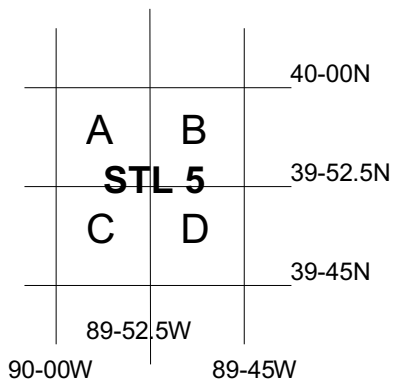

Figure 5-25

Pinpointing an area within the grid system becomes easy once you gain familiarity with the grids' many uses. You soon will be able to quickly plot any area on a map and then fly to it using the basic navigation techniques already discussed. [Note: Use dotted lines when you grid your charts for ease of reading.]

Note: If you know a latitude and longitude and want to know what grid it's in (either CAP or Standard grid), go to <http://www.cap-es.net/gridfinder/gridfind.html>. It will also give you the USGS map index number for that area (7.5' quad), and provide a link to display the grid on a Sectional Chart.

6. Search Planning and Coverage

This chapter will cover factors that are unique to SAR/DR mission planning. Planning considerations and techniques used in both visual and electronic search missions are included. The incident commander and his general staff perform much of the planning. However, all crewmembers are expected to understand the planning concepts. This comprehension allows more precise mission performance, and increases flexibility to effectively deal with changing circumstances. Much of this information is contained in the *U.S. National SAR Supplement to the International Aeronautical and Maritime SAR Manual*.

Some of the topics included in this chapter were covered in the Mission Scanner course. They are not included in the objectives but are reproduced here for review purposes.

OBJECTIVES:

1. In basic terms, discuss how search planners determine the Maximum Area of Possibility and then the Probability Area. {MP O-2004}
2. Given a POD table, discuss the advantages and disadvantages of various search altitudes and speeds over the three major types of terrain. {MP O-2004}
3. Discuss the importance of proper execution of search patterns.
4. Discuss damage assessment:
 - a. Effects on CAP operations
 - b. Intelligence gathering
 - c. Damage assessment sorties
5. Discuss missing person searches

6.1 Search Terms

A number of terms and planning factors must be understood when planning and executing search and rescue missions.

Ground Track - An imaginary line on the ground made by an aircraft's flight path over the ground.

Maximum Area of Possibility - This normally circular area is centered at the missing airplane's (or search objective's) last known position (LKP), corrected for the effect of wind. The circle's radius represents the maximum distance a missing aircraft might have flown based on estimated fuel endurance time and corrected for the effects of the wind over that same amount of time. The radius may also represent the maximum distance survivors might have traveled on foot, corrected for environmental or topographical conditions, such as snow, wind, mountains, and rivers.

Meteorological Visibility - The maximum distance at which large objects, such as a mountain, can be seen.

Probability Area - This is a smaller area, within the maximum possibility area, where, in the judgment of the incident commander or planner, there is an increased likelihood of locating the objective aircraft or survivor. Distress signals, sightings, radar track data, and the flight plan are typical factors that help define the probability area's boundaries.

Probability of Detection - The likelihood, expressed in a percent, that a search airplane might locate the objective. Probability of detection (POD) can be affected by weather, terrain, vegetation, skill of the search crew, and numerous other factors. When planning search missions, it is obviously more economical and most beneficial to survivors if we use a search altitude and track spacing that increases POD to the maximum, consistent with the flight conditions, team member experience levels, and safety. Note: POD will be decreased if only one scanner is on board and the search pattern is not adjusted accordingly.

Scanning Range - The lateral distance from a search aircraft to an imaginary line on the ground that is parallel to the search aircraft's ground track. Within the area formed by the ground track and scanning range, the scanner is expected to have a good chance at spotting the search objective. Scanning range can be less than but never greater than the search visibility.

Search Altitude - This is the altitude that the search aircraft flies above the ground (AGL). [Remember, routine flight planning and execution deals in MSL, while searches and assessments are referenced to AGL.]

Search Track - An imaginary swath across the surface, or ground. The scanning range and the length of the aircraft's ground track forms its dimensions.

Search Visibility - The distance at which an object on the ground (CAP uses an automobile as a familiar example) can be seen and recognized from a given height above the ground. Search visibility is always less than meteorological visibility. [Note: *On the POD chart the maximum search visibility listed is four nautical miles.*]

Track Spacing - The distance (S) between adjacent ground tracks. The idea here is for each search track to either touch or slightly overlap the previous one. It is the pilot's task to navigate so that the aircraft's ground track develops proper track spacing.

6.2 Search Planning

When faced with a lack of vital information concerning the missing aircraft, the planner can either give the entire probability area search priority or select a portion of the probability area for a concentrated search. Some of the factors used in estimating the location of the missing aircraft within a portion of the probability area are:

- Areas of thunderstorm activity, severe turbulence, icing and frontal conditions
- Areas where low clouds or poor visibility may have been encountered
- Deviations in wind velocities from those forecast by the weather bureau
- Areas of high ground
- Any part of the aircraft's track that is not covered by radar

6.2.1 Search Area Determination

The first task in planning a search and rescue mission is to establish the most probable position of the crash site or survivors. If witnesses or other sources provide reliable information concerning an accident, the location may be established without difficulty. If there is little or no information, the planner faces a more difficult task. Regardless of the information available, the planner always prepares a chart to assist in focusing the search and locating the crash site or survivors as quickly as possible.

When defining search area limits, the planner first sketches the maximum possibility area. This can focus the initial search in the most likely area and allows use of the charted area to help screen sightings and other reports. Again, the area is roughly circular, centered on the last known position of the missing aircraft. The radius approximates the distance the objective aircraft might have traveled, given the amount of fuel believed aboard at its last known position, and the wind direction and speed. The area is circular because it's always possible the missing pilot may have changed directions following his last known position and flown until his fuel was exhausted.

To chart the Maximum Area of Possibility, the planner requires the missing aircraft's last known position, wind direction and velocity, and an estimate of the missing aircraft's fuel endurance and airspeed. Figure 6-1 illustrates the use of these factors to chart the maximum area of possibility. The planner plots the missing aircraft's last known position on a sectional or other chart, then displaces the position for 2 hours of wind effect, or 40 nm, from 330°. From the displaced last known position, he draws a circle with a radius equal to the maximum distance flown by the aircraft. In this case, the planner estimated this range by multiplying aircraft speed, in this case 100 kts, by the estimated endurance of two hours.

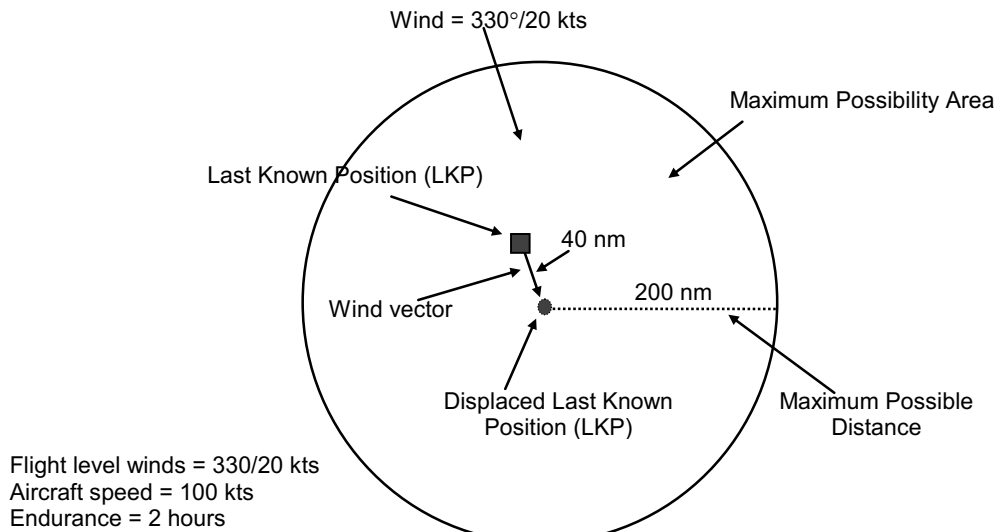

Figure 6-1

Surveillance-Enhanced Search and Rescue (SE-SAR) allows Flight Service personnel to initiate Search and Rescue procedures for VFR flights much earlier than with traditional procedures and with a greatly reduced search area. Using satellite communications and eventually ADS-B-out, periodic position reports are generated on the aircraft and forwarded to Flight Service. The automation system detects if an aircraft stops moving, stops sending position reports, or if the pilot sends an SOS signal. In each of these situations, Flight Service personnel are alerted and can begin procedures immediately. In addition, they have access to the position history for the flight. This allows everyone involved in the search to focus on the right geographic area, greatly reducing the time to reach survivors.

SE-SAR is currently available for use with *SpiderTracks* GPS position reporting devices and DeLorme *inReach* satellite communicators registered on the Pilot Web Portal. The service will expand to other position reporting devices and automatic dependent surveillance-broadcast equipped aircraft in the near future.

AFRCC/CAP provides **cell forensics** support that provide likely areas to search.

Radar nets provide almost complete coverage of the continental U.S., Alaska, Hawaii, and Puerto Rico. The National Track Analysis Program (NTAP) can retrieve computer-sorted radar data up to 15 days old to pinpoint a missing aircraft's last known position (LKP). NTAP information should be requested through AFRCC.

Other FAA recording radar nets include Air Route Traffic Control Centers (ARTCC) facilities and Terminal Radar Approach Control (TRACON) facilities. Both record primary and secondary radar data that is retained for 15 days and may be obtained in hard copy format.

6.2.2 Probability areas

Plotting the probability area, the area in the possibility circle where the searchers are most likely to find the aircraft, is the second major factor in search planning. The probability area is determined by the accuracy of the last known position (LKP) in the possibility circle. Primary factors that contribute to the accuracy of the LKP are:

- The aircraft disappearance point on radar
- The bearing or fix provided by other ground stations
- Dead reckoning position based on the time of LKP
- Reports of sightings-either ground or air
- Emergency locator transmitter (ELT) reports

There are instances where the above information is not available to assist the planner. To establish a probable position in these instances, the planner must rely on less specific secondary sources of information including:

- Flight plan
- Weather information along the intended route or track
- Proximity of airfields along route
- Aircraft performance
- Pilot's previous flying record
- Radar coverage along the intended track
- Nature of terrain along the intended track
- Position and ground reports

Based on experience and simulation provided by these factors, the planner is able to define an area of highest priority to initiate the search. The first search area may be called probability area one. This area begins around the last known position, extends along the intended route and ends around the intended destination. If a search of probability area one produces negative results, the search may be expanded to cover probability area two, an extension of area one.

Organization is an important element in search planning. The time it takes to locate downed aircraft or survivors could depend on the definition and charting of the search area. As a pilot or observer, you should become familiar with each designated search area before the mission is launched. You should use current charts and maps which will enable you to provide additional navigational assistance in accurately positioning the search aircraft over the properly designated area.

Outlining the maximum area of possibility establishes an *initial* likely area where the missing aircraft might be located. In the earlier example, the maximum possibility area included over 120,000 square miles. The extensive size of the maximum possibility area makes systematic search neither efficient nor practical. It is essential that the planner further focus search assets and attempt to further define the possible location area. To do this, the planner charts a *probability area* within the possibility circle.

The probability area is determined by considering other factors that will help to reduce the area of intended search. These additional factors may include:

- Bearing or fix provided by other, non-radar, ground stations
- Point where the aircraft disappeared from air traffic control radar
- Dead reckoning position based on time of last known position
- Reported sightings from either ground or air
- SARSAT or emergency locator transmitter reports
- Missing aircraft's flight plan
- Weather information along the missing aircraft's intended route
- Proximity of airfields along that route

- Aircraft performance
- Missing pilot's previous flying experience and habits
- Radar coverage along the intended track
- Nature of the terrain along the intended route
- Position and ground reports

In instances when little information is available to assist the planner, he or she reconstructs the incident flight with whatever information may be available. With no information, the search plan is based on an assumption that the missing aircraft is probably located along or near its intended course. The search is initially confined to an area 5 miles on either side of the intended course, beginning at the last known position and continuing to the intended destination. This first search area is called *probability area one*. The un-shaded area in Figure 6-2 represents probability area one.

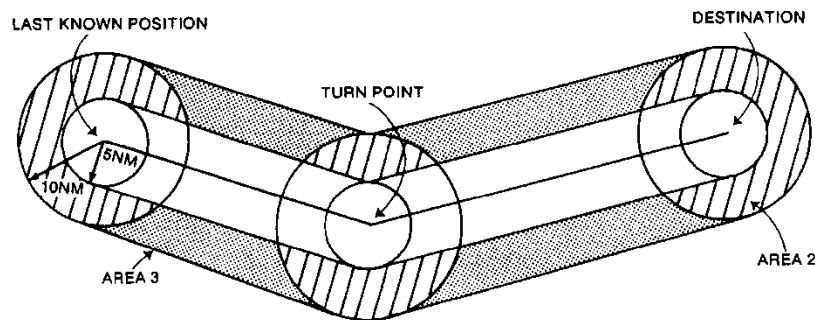

Figure 6-2

If search of probability area one produces no results, the search expands to include the area within a 10-mile radius of the last known position, destination, and intermediate points. This area is known as *probability area two* and is depicted by the hatched areas in Figure 6-2.

If the search still produces no results, a third search area is created. *Probability area three* includes areas 10 miles either side of the missing aircraft's intended course, excluding those areas already searched in areas 1 and 2. Shaded areas in Figure 9-2 illustrate probability area three. If there is still no result, the incident commander may chart a new probability area within the possibility circle.

When other information *is* available that indicates any of the following factors may have been involved, the incident commander may also consider these factors when assigning priority to initial search areas:

- Areas of thunderstorm activity, severe turbulence, icing, frontal conditions, or any other weather condition that may have influenced a pilot to consider alternate routes to the destination
- Areas where low clouds or poor visibility might have been encountered
- High terrain or mountain passes
- Any part of the aircraft's course is not covered by radar
- Reports of ground sightings or of sound from low-flying aircraft
- Point of last reported radio contact or MAYDAY broadcast
- Deviations in wind velocities from that forecast
- Survival factors

In many military incidents, crewmembers of aircraft may eject or "bail out" of an aircraft prior to its collision with the ground. This is rare in civilian accidents, but if applicable the planner will also consider parachute drift factors when determining search areas.

6.2.3 Search Altitudes and Airspeeds

Once probability areas are identified, the planner must make a number of choices as to the size and type of search patterns to be flown, search altitudes, and airspeeds. To make effective choices, the planner first considers factors beyond his or her control, including the size of the search objective, visibility, weather, and sea or terrain conditions. Altitude selection will be based on Operational Risk Management criteria, the search environment, and the mission objective.

Per CAPR 70-1, sustained flight below an altitude or lateral distance from any object of 1,000 ft. during the day or 2,000 ft. at night is prohibited except for takeoff and landing or in compliance with ATC procedures (such as IFR flight). At no time will the pilot allow the aircraft to come within 500 feet of terrain or obstructions unless taking off or landing. So, pilots may descend below the designated search altitude to verify potential crash sites or the presence of survivors, and to prevent loss of life, property, or human suffering, but never below 500' AGL; once the target has been identified the pilot will return to 1000' AGL or higher. [Refer to CAPR 70-1 for special restrictions for over-water missions.]

The size of the search objective, weather, visibility, and ground cover in the search area must be considered when determining the altitude and airspeed for a visual search. Over non-mountainous terrain, a search altitude between 1000 and 2000 feet above the terrain is normally used for a visual search. The search visibility and the terrain conditions may affect this selection. As altitude decreases below 1000 feet search effectiveness may actually decrease, due to the "rush effect" of objects on the ground passing through the scanner's field of view more rapidly.

Over mountainous terrain, the search altitude may be higher if the planner suspects wind and turbulence near the surface. During darkness, an altitude 3,000 feet above the terrain is considered adequate. Also, rugged terrain can easily block emergency radio transmissions, so electronic searches over such terrain are normally conducted at considerably higher altitudes than would be used during visual searches.

Depending upon the number of search aircraft available to the incident commander, he may also consider the desired probability of detection when selecting an altitude for the search pattern. Although a probability of detection chart is normally used to estimate POD *after* a search, its use here allows incident commanders to predetermine a mission's chance of success. Here's an example of using desired POD to help select a search altitude.

A red and white Cessna 172 has been reported missing and presumed down in eastern Arkansas, in open flat terrain. At the time of the search, flight visibility is forecast to be greater than 10 miles. The incident commander determines, based on available aircraft and crews, that the single probability of detection for this first search must be at least 50%.

The POD chart excerpt in Table 6-1 (from CAPF 104a, *SAR Results*) shows data for: open, flat terrain; hilly terrain and/or moderate ground cover; and very hilly and/or heavily covered terrain. To the right in the columns beneath "Search Visibility" you see what are, in this case, the desired probabilities of detection. Looking at the open/flat terrain portion of the table (Table 6-2) and using 1-mile

track spacing with 4 nm search visibility, you can see that all three altitudes give at least 50% POD. A search at 1000 feet above the terrain gives 60%, or 12% *more* POD, than does a search at 500 feet. Over open terrain, where flight and search visibility are not limiting factors (i.e., greater than 4 nm), the chart demonstrates that a higher altitude is more likely to yield positive results on a single sortie. Notice that the highest POD in Table 9-2, 85%, is obtained when flying at 1,000 feet above the ground using a track spacing of 0.5 nm.

SEARCH ALTITUDE	TRACK SPACING	OPEN FLAT TERRAIN				MODERATE TREE COVER AND/OR HILLY				HEAVY TREE COVER AND/OR VERY HILLY			
		SEARCH VISIBILITY				SEARCH VISIBILITY				SEARCH VISIBILITY			
		1 MILE	2 MILES	3 MILES	4 MILES	1 MILE	2 MILES	3 MILES	4 MILES	1 MILE	2 MILES	3 MILES	4 MILES
500 FT AGL	.5 MILE	35%	60%	75%	75%	20%	35%	50%	50%	10%	20%	30%	30%
	1 MILE	20%	35%	50%	50%	10%	20%	30%	30%	5%	10%	15%	15%
	1.5 MILES	15%	25%	35%	40%	10%	15%	20%	20%	5%	5%	10%	10%
	2 MILES	10%	20%	30%	30%	5%	10%	15%	15%	5%	5%	10%	10%
700 FT AGL	.5 MILE	40%	60%	75%	80%	20%	35%	50%	55%	10%	20%	30%	35%
	1 MILE	20%	35%	50%	55%	10%	20%	30%	35%	5%	10%	15%	20%
	1.5 MILES	15%	25%	40%	40%	10%	15%	20%	25%	5%	5%	10%	15%
	2 MILES	10%	20%	30%	35%	5%	10%	15%	20%	5%	5%	10%	10%
1000 FT AGL	.5 MILE	40%	65%	80%	85%	25%	40%	55%	60%	15%	20%	30%	35%
	1 MILE	25%	40%	55%	60%	15%	20%	30%	35%	5%	10%	15%	20%
	1.5 MILES	15%	30%	40%	45%	10%	15%	20%	25%	5%	10%	10%	15%
	2 MILES	15%	20%	30%	35%	5%	10%	15%	20%	5%	5%	10%	10%

Table 6-1

SEARCH ALTITUDE	TRACK SPACING	OPEN FLAT TERRAIN			
		SEARCH VISIBILITY			
		1 MILE	2 MILES	3 MILES	4 MILES
500 FT AGL	.5 MILE	35%	60%	75%	75%
	1 MILE	20%	35%	50%	50%
	1.5 MILES	15%	25%	35%	40%
	2 MILES	10%	20%	30%	30%
700 FT AGL	.5 MILE	40%	60%	75%	80%
	1 MILE	20%	35%	50%	55%
	1.5 MILES	15%	25%	40%	40%
	2 MILES	10%	20%	30%	35%
1000 FT AGL	.5 MILE	40%	65%	80%	85%
	1 MILE	25%	40%	55%	60%
	1.5 MILES	15%	30%	40%	45%
	2 MILES	15%	20%	30%	35%

Table 6-2

If weather or visibility are not limiting factor, why then don't you just always elect to fly *that* track spacing at 1,000 feet, and always try to obtain that highest of probabilities of detection? You should recall, from the earlier maximum probability area, that you start with a very large area and then try to focus your efforts on smaller probability areas within that larger area. If the incident commander has received a number of leads that have reduced the probable area to a small size, he

might task you to fly exactly that track spacing and altitude. If the area is not so small, and you try to fly 1/2 rather than 1 nm track spacing, you will obviously take *twice* as long to cover the whole area.

The incident commander also has another option he may use to increase the POD. Given adequate resources of aircraft and crews, he can significantly increase the POD by directing multiple searches of the same area, and increasing the amount of time that search forces cover the probability area. This can be demonstrated by using a Cumulative POD chart, shown in Table 6-3, and the earlier example of the missing red and white Cessna. The single-search POD for this hypothetical search was 60%. That mission was flown at 1,000 feet and 1-nm track spacing. If you, or another aircraft and crew, fly the same pattern a second time, the POD increases significantly. If the same search is flown again, with the exact same parameters for altitude and track spacing, the overall probability of detection (where the initial 60% intersects the subsequent same single POD, also 60%) is now 80% cumulative. A third search of the same area, again using the same parameters, brings the cumulative POD up to 90%. Since the cumulative POD increases with time in the search area, the incident commander has another option he can select to maximize search coverage.

Previous, or Cumulative POD		CUMULATIVE POD CHART									
5-10%	15										
11-20%	20	25									
21-30%	30	35	45								
31-40%	40	45	50	60							
41-50%	50	55	60	65	70						
51-60%	60	65	65	70	75	80					
61-70%	70	70	75	80	80	85	90				
71-80%	80	80	80	85	85	90	90	95			
80%+	85	85	90	90	90	95	95	95	95	95+	
		5-10%	11-20%	21-30%	31-40%	41-50%	51-60%	61-70%	71-80%	80%+	
		POD THIS SEARCH									

Table 6-3

6.2.4 Executing Search Patterns

The incident commander and his staff take into consideration many variables including weather, visibility, aircraft speed, and availability of aircraft and crew resources, experience, and urgency of the situation when developing the search plan. This section covered a number of factors that can affect the choice for search altitudes and track spacing. Similarly, the planner considers many variables when selecting the search pattern or patterns to be used. Individual search patterns are covered in chapters that follow. All questions about how the search is to be conducted must be resolved at the mission briefing. When airborne, crews must focus on executing the briefed plan instead of second-guessing the general staff and improvising. If, for whatever reason, you deviate from the planned search pattern it is imperative that you inform the staff of this during your debriefing.

6.2.5 Search Coverage Probability of Detection

Before a search mission gets airborne, each aircrew has a good idea of how much effort will be required to locate the search objective if it is in the assigned search area. This effort, expressed as a percentage, is the probability of detection. As a member of a CAP aircrew, you may be required to establish a POD for your aircrew's next sortie.

6.3 Probability of Detection example

You can easily determine a probability of detection (POD) by gathering the data affecting the search and by using a POD chart to calculate the detection probability.

The type of terrain, ground foliage, and altitude of the search aircraft, track spacing, and search visibility are vital factors in determining a POD. Once each of these factors is given a description or numerical value, the POD can be determined by comparing the search data with the POD chart data. The following discussion is based on this example search situation:

A Cessna 182, white with red striping along the fuselage and tail, was reported missing in the northwest area of Georgia. The last known position of the airplane was 40 miles north of the city of Rome. Geological survey maps indicate that the probability area is very hilly and has dense or heavy tree cover. Current visibility in the area is 3 miles. A search for the airplane and its three occupants is launched using 1000 feet AGL for the search altitude and a track spacing of 1.0 nautical mile.

6.3.1 Using the Probability of Detection Table

By referring to a POD chart you will note that there is approximately a 15% chance of locating the missing aircraft during a single search. Locate the numbers in the column describing heavy tree cover and hilly terrain that coincide with the search data mentioned above.

In cases where there are multiple or repeated searches over the same probability area, you should use the cumulative POD chart. This chart is as easy to use as the single search POD chart.

Using the same data that we just mentioned concerning the missing Cessna 182, we can determine the probability of detecting the aircraft during a second search of the probability area. In the first search the POD was fifteen percent. For the second search (assuming that the data remains the same as was specified for the first search), the POD would be fifteen percent. However, because this is a repeat, the overall POD increases to 25 percent.

Probably the greatest advantage of using the cumulative POD chart is to indicate to searchers how many times they may have to search a single area to obtain the desired overall POD. For instance, you may want a POD of 80 percent in an area before continuing to another area. If one search of probability area proves futile with a POD of 35 percent and a second search is conducted in the area with a POD of 40 percent, the cumulative POD can be determined easily. The observer in the aircraft would only have to locate the box that intersects the 35 percent POD with the 40 percent POD.

A look at the cumulative POD shows that these two searches would yield a cumulative POD of 60 percent. Therefore, you should search the area again.

Remember, the cumulative POD chart should be used when multiple searches are conducted over the same search area.

This general explanation of the cumulative POD chart has provided some basic information about its use. As a mission pilot or observer, you should not concern yourself with extensive calculations involving the cumulative POD. Simply knowing the probability of detection for each mission and the factors contributing to that probability is enough involvement on the mission aircrew's part. The incident commander who directs and controls all operations of air and ground units is the primary individual who makes extensive use of the cumulative POD chart.

6.3.2 Sample problems

By referring to a POD chart you will note that there is approximately a 10% chance of locating the missing aircraft during a single search. Locate the numbers in the column describing heavy tree cover and hilly terrain that coincide with the search data mentioned above.

Problem #1

Four aircraft have accumulated 9 hours over a given search area at an average ground speed of 90 knots. If they used a track spacing of 2 nm, what is the total area searched in thousands of square miles?

Problem #2

The area to be searched prior to sunset is 6000 square nautical miles. With an average ground speed of 60 knots, 6 hours of good light left in the day, and a track spacing of 1.5 nm, how many aircraft will be required to complete the search?

Problem #3

The area to be searched is 5000 square nautical miles, and the incident commander has selected 2 nm for track spacing. With 3 aircraft capable of an average ground speed of 100 knots, how many hours will the search take?

6.4 Disaster Assessment

CAP aircrews may be called upon to assess damage from natural and man-made disasters. Natural disasters may result from weather related phenomena such as earthquakes, floods, wildfires, winter storms, tornados and hurricanes. Man-made disasters may result from accidents (e.g., chemical, biological or nuclear industrial accidents) or acts of terrorism or war. Normally, CAP will support FEMA disaster or emergency operations.

Some of the disaster assessment services that CAP may be asked to provide are:

- Air and ground SAR services (e.g., missing persons, aircraft and livestock)
- Air and ground visual and/or photo/video damage survey and assessment
- Flood boundary determination using GPS
- Air and ground transportation of key personnel, medical and other equipment, and critical supplies during actual disaster operations
- Air transportation of SAR dogs

- Radio communications support including a high bird relay and control aircraft to extend communications over a wide area or to coordinate air traffic into a TFR area over the disaster site
- Courier flights

6.4.1 Effects on CAP operations

The conditions that created the emergency or disaster may affect CAP operations. Extreme weather is an obvious concern, and must be considered in mission planning.

The disaster may affect the physical landscape by erasing or obscuring landmarks. This may make navigation more difficult and may render existing maps obsolete.

Disasters may also destroy or render unusable some part of the area's infrastructure (e.g., roads, bridges, airfields, utilities and telecommunications). This can hamper mobility and continued operations. Also, road closures by local authorities or periodic utility outages can reduce the effectiveness and sustainability of CAP operations in the area.

6.4.2 Biological, Chemical or Radiological Terrorism

The events of September 11th brought home the need for increased vigilance against weapons of mass destruction. The following provide general precautions for CAP aircrews for the three major threats.

For Biological Terrorism, be alert to the following:

- Groups or individuals becoming ill around the same time
- Sudden increase in illness in previously healthy individuals
- Sudden increase in the following non-specific illnesses: pneumonia, flu-like illness, or fever with atypical features; bleeding disorders; unexplained rashes, and mucosal or dermal irritation; and neuromuscular illness
- Simultaneous disease outbreaks in human and animal populations

For Chemical Terrorism, be alert to the following:

- Groups or individuals becoming ill around the same time
- Sudden increase in illness in previously healthy individuals
- Sudden increase in the following non-specific syndromes: sudden unexplained weakness in previously healthy individuals; hyper secretion syndromes (e.g., drooling, tearing, and diarrhea); inhalation syndromes (e.g., eye, nose, throat, chest irritation and shortness of breath); shin burn-like skin syndromes (e.g., redness, blistering, itching and sloughing)

For Ionizing Radiation Terrorism, be alert to the following:

- Nausea and vomiting

Pocket guides covering these events may be found on the web

6.4.3 Transportation

In some situations other agencies will wish to conduct the damage assessment, and CAP may be tasked to provide aerial transportation. The rules governing these flights are found in CAPR 70-1 and the FAR Exemptions.

6.4.4 Intelligence gathering

One of the most important commodities during disasters is accurate, timely intelligence. During an emergency or disaster, conditions on the ground and in the air can change rapidly and the emergency managers and responders need this information as quickly as possible.

CAP may be tasked to gather intelligence during emergencies or disasters. Examples of intelligence activities include:

- Signals intelligence. CAP aircrews should report any unusual radio communications overheard during sorties.
- Human intelligence. Aircrews returning from sorties will be debriefed on operating conditions, notable changes to infrastructure and terrain, and the condition of local infrastructure.
- Imagery intelligence. All aircrews should be equipped with digital cameras, camcorders, instant-film cameras or film cameras for use in recording conditions encountered during operations. Slow-Scan or similar real-time video imagery will also be used. Camcorders are best for large-scale disasters because continuous filming allows coverage of multiple targets and allows for audio comments during filming. Digital cameras are of great value because they allow you to immediately see the results of your shot and they allow for the images to be quickly and widely disseminated.

NOTE: If a CAP aircrew observes unidentifiable, suspicious, or hostile traffic (land, aerospace or sea borne) which, because of its nature, course, or actions, could be considered a threat to the security of the United States or Canada, they will *immediately* inform CAP mission base.

6.4.5 Damage assessment sorties

Flying damage assessment sorties is not much different than flying search patterns. The big difference between a search for a downed aircraft and damage assessment is *what you look for* in the disaster area. During planning, if possible, use *Google Earth™* to examine the disaster area (e.g., terrain, ground features, obstacles, roads, and other prominent features). This will also allow staff to perform “before and after” analysis.

When approaching an event scene, don’t just head straight to the scene. *First, obtain situational awareness of the entire area surrounding the scene*; in particular, check for other traffic such as rescue and media helicopters and other aircraft (gawkers). One method is to circle the area letting your scanners assess the situation while you clear from your side. Once you know the score, then you can proceed to the scene and accomplish your mission.

Most often you will be given specific tasking for each sortie. However, you must always be observant and flexible. Just because you have been sent to determine the condition of a levy doesn’t mean you ignore everything else you see on the way to and from the levy.

Different types of emergencies or disasters will prompt different assessment needs, as will the nature of the operations undertaken. Examples of questions you should be asking during planning are (but are certainly not limited to):

- What is the geographical extent of the affected area?
- What is the severity of the damage?

- Is the damage spreading? If so, how far and how fast? It is particularly important to report the direction and speed of plumes (e.g., smoke or chemical).
- How has access to or egress from important areas been affected? For example, you may see that the southern road leading to a hospital has been blocked, but emergency vehicles can get to the hospital using an easterly approach.
- What are the primary active hazards in the area? Are there secondary hazards? For example, in a flood the water is the primary hazard; if the water is flowing through an industrial zone then chemical spills and fumes may be secondary hazards.
- Is the disaster spreading toward emergency or disaster operating bases, or indirectly threatening these areas? For example, is the only road leading to an isolated aid station about to be flooded?
- Have utilities been affected by the emergency or disaster? Look for effects on power transmission lines, power generating stations or substations, and water or sewage treatment facilities.
- Can you see alternatives to problems? Examples are alternate roads, alternate areas to construct aid stations, alternate landing zones, and locations of areas and facilities unaffected by the emergency or disaster.

While it is difficult to assess many types of damage from the air, CAP is well suited for preliminary damage assessment of large areas. Generally, you will be looking to find areas or structures with serious damage in order to direct emergency resources to these locations.

A good tool for assessing tornado damage is "A Guide to F-Scale Damage Assessment" (U.S. Department of Commerce, NOAA, NWS; it can be downloaded from the web as a .pdf file).

It is very important to have local maps on which you can indicate damaged areas, as it is difficult to record the boundaries of large areas using Lat/Long coordinates.

CAP can quickly provide vital information on the status of:

- Transportation routes (road and rail)
- Critical facilities/structures such as power stations, hospitals, fire stations, airports, water supplies, dams and bridges
- Levees and other flood control structures
- The type and location of areas that have been damaged or isolated
- Concentrations of survivors (people and animals)

As discussed above, there are many things to look for during your sortie. Some specific things to look for are:

- Breaks in pavement, railways, bridges, dams, levees, pipelines, runways, and structures
- Roads/streets blocked by water, debris or landslide. Same for helipads and runways
- Downed power lines
- Ruptured water lines (this may have a major impact on firefighting capabilities)
- Motorists in distress or major accidents

- Alternate routes for emergency vehicles or evacuation
- Distress signals from survivors

NOTE: Local units should become proficient in identifying their neighborhoods, major facilities, and roads/streets from the air.

At each site, besides sketching or highlighting the extent of the damage on local maps and identifying access/egress routes, you should record:

- Lat/Long
- Description
- Type and extent of damage
- Photo number or time reference for videotape
- Status (e.g., the fire is out, the fire is spreading to the northeast, or the floodwaters are receding)

A sample Photo/Recon Log is provided in Attachment 2, *Flight Guide*.

After the sortie, remember to replenish your supplies and recharge batteries.

6.5 Missing Person Search

An individual is very difficult to spot from the air, but CAP aircrews can do well in some situations:

- Persons who are simply lost and are able to assist in their rescue. Persons who frequent the outdoors are often trained in survival and have the means to signal searching aircraft.
- Persons who may be wandering along roads or highways, such as Alzheimer's patients
- Persons trapped or isolated by natural disasters such as floods. These persons often can be found on high ground, on top of structures, along a road or riverbank.
- Persons who were driving. Their vehicle may be stopped along a road or highway.

Lost children and people with diminished capacities can be especially difficult to find. By the time CAP is called the police have probably already looked in the obvious places. Often, these individuals will be hiding from their searchers. Route and grid searches must be done with great care and with full, well-rested crews. Knowledge of what they are wearing and how they may respond to over-flying aircraft is especially valuable in these instances.

Lost persons often fight topography and are likely to be found in the most rugged portion of the surrounding country (persons who follow natural routes are seldom lost for long periods). Children under five years old frequently travel uphill; they also may hide from searchers (except at night).

Intentionally blank

7. Electronic Search Patterns

While the mission observer's role seems to be concentrated in visual searches, her contributions in electronic searches are no less important. The observer's understanding of electronic search techniques, and her ability to assist the pilot, can substantially increase both search effectiveness and the timeliness of recovering accident victims.

Electronic searches are most efficient when the equipment, the environment and the terrain are ideal. This includes flat, level terrain, few natural or man-made obstructions and properly functioning equipment. These ideals seldom exist. Therefore, the effectiveness of electronic searches depends heavily on the experience and expertise of the search crews employing them. Through practice, you will understand the difficulties caused by Emergency Locator Transmitter (ELT) signals reflected from obstructions, the adaptability of electronic search methods to overall conditions, and the monitoring of radio equipment to ensure proper operation.

The use of electronic equipment in locating missing aircraft or survivors is an alternative to visual searches. The primary equipment in these type searches is an ELT and an ELT reception device. Once it has been established that an ELT was on board the missing aircraft, a combined track route and ELT search can be launched. The success of this type of search depends on the life of the battery of the ELT, the survivability of the entire ELT unit and whether the unit was activated or not. There is always the possibility ELT equipment may be inoperable due to the effects of the crash. Since an ELT aboard an aircraft does not guarantee that it can be located with an electronic search, both an electronic search and a concentrated general search should be organized at the same time.

OBJECTIVES:

1. Discuss the various types of ELTs.
2. Describe how an ELT can be detected. {MP O-2005}
3. Describe how the aircraft DF works in both the Alarm and DF modes.
{MO O-2108; MP O-2005}
4. Discuss using the DF during a typical ELT search. Include how the DF should respond during the initial phase (including signal fade), when you are getting close, and when you pass over the beacon.
{MO O-2108; MP O-2005}
5. Describe the following ELT search methods: homing, wing null, aural search, and signal search. {MO O-2108; MP O-2006}
6. Discuss signal reflection and interference. {MO O-2108; MP O-2006}
7. Describe how to silence an ELT and the legal issues involved.

{MP O-2007}

7.1 ELTs and SARSAT

Electronic equipment and procedures are used in general searches to focus the search and rescue effort in a specific area, or as an alternative to visual searches when visibility is reduced by weather or other atmospheric conditions. Equipment used in these searches may include a battery-powered emergency locator transmitter (ELT) aboard the incident aircraft, search and rescue satellites, and an ELT receiver aboard the search aircraft.

7.1.1 ELTs

The Federal Aviation Administration (FAA) requires most U.S.-registered aircraft to have operable ELTs installed, which activate automatically when sensing acceleration forces during an accident. An active ELT transmits a continuous radio signal on a specific frequency until it's either deactivated or its battery discharges.

Most general aviation aircraft have ELTs that transmit on 121.5 MHz at 60-100 milliwatts (less power than a small flashlight). They are activated by G-forces or by manual operation of a switch (some aircraft have a remote switch in the cockpit). ***Space-based monitoring of 121.5 MHz ELTs ceased on 1Feb09.***

Advanced ELTs that transmit on 406.025 MHz at 5 watts are specifically designed to operate with the SARSAT/COSPAS satellite system. They also produce standard sweep tones on 121.5, 243.0 and 406 MHz, and may transmit GPS coordinates. The registered transmitter sends a coded signal that can be used to obtain the owner's name, address and type of aircraft, so AFRCC can call the number to see if the aircraft is really missing (~ 70% of the false alerts will be resolved by this call). Since geostationary satellites process the signal it will be heard more quickly and allow a much faster response (~ 6 hours saved). If the unit has a GPS receiver, it can transmit Lat/Long coordinates to further speed the search. The signal can also penetrate dense cover (e.g., trees). [Adoption of the these ELTs will be slow by general aviation as they presently cost about three times as much as a 121.5 MHz ELT.]

Military Beacons (e.g., URT-33/C) operate on 243 MHz. Personnel ejecting/parachuting from a military aircraft have this beacon; some pilots may be able to communicate via two-way radio on 243 MHz using a PRC-90 or later military survival radio (this radio also has a beacon mode).

Marine Emergency Position Indicating Radio Beacons (EPIRBs) are primarily found on boats and ships. Similar to 406 or 121.5 MHz ELTs, some are automatically activated while others can only be activated manually.

Personal Locator Beacons (PLBs) and Personal Emergency Transmitters (PETs) use a 406 MHz transmitter and a 121.5 MHz homing signal (at only 25 mW). Many are also equipped with a built-in GPS receiver that provides Lat/Long coordinates (typically to within 98 feet). Each PLB must be registered.

Practice beacons used by CAP transmit on 121.775 MHz. *Avoid calling the practice beacon an "ELT" while communicating on the radio; this can cause confusion.* The term "practice beacon" is very clear to all concerned and should be used on all drills and exercises.

ELTs can (and are) be inadvertently activated. Typical causes are excessively hard landings (Welcome aboard, Ensign!), inadvertent manual activation (e.g., removal/installation), malfunctions, or Monsieur Murphy. Also, non-ELT sources can transmit on 121.5 or 243 MHz; examples are computers, broadcast stations, and even pizza ovens.

Approximately 97% of all received 121.5 MHz ELT signals turn out to be false alarms. For 121.5 MHz ELTs only 1 in 1000 signals is an actual emergency! False alarms caused problems because SARSAT could only monitor 10 ELT signals at a time and because they blocked the emergency frequencies (thus blocking a real emergency signal). However, you must always treat an ELT signal as an emergency because you can't know whether the signal is real or false. Additionally, ELT missions keep your skills sharp.

7.1.2 SARSAT/COSPAS

In a cooperative effort among several nations, search and rescue-dedicated satellites (SARSAT and COSPAS) orbit the earth and alert to 406 MHz ELT transmissions. In the event the ELT is activated (such as during a crash) it transmits the standard swept tone on 121.5 and 243.0 MHz at ~100 milliwatts. Additionally, the 406.025 MHz 5-watt transmitter turns on at 50 intervals; during that time an encoded digital message is sent to the NOAA-SARSAT satellite (part of the COSPAS-SARSAT satellite system). After activation the 406.025 MHz transmitter will operate for 24 hours and then shuts down automatically; the 121.5/243.0 MHz transmitter will continue to operate until the unit has exhausted the battery power (at least 72 hours).

The information contained in the ELT message is:

- Serial Number of the Transmitter or Aircraft ID
- Country Code
- I.D. Code
- Position Coordinates (Lat/Long), if coupled to the aircraft's GPS unit

406 MHz ELTs must be registered with the United States the National Oceanic and Atmospheric Administration (NOAA). This identification code helps the Air Force Rescue Coordination Center (AFRCC) determine whether an emergency actually has occurred. The code permits accessing a registration database that contains the:

- Owner's Name
- Owner's Address
- Owner's Telephone Number
- Aircraft Type
- Aircraft Registration Number
- Alternate Contact

For 406 MHz ELTs without GPS position data it is necessary for the polar orbiting satellites to pass overhead, using Doppler Shift technology to determine approximate position; this results in position accuracy of 1-3 nm. If the ELT is coupled to the aircraft's GPS unit, the position data is also transmitted and position accuracy improves to within 100 yards. [Note: in a worst-case scenario, there could be a 3-4 hour wait for a polar orbiting satellite to pass overhead.]

AFRCC uses the registration data to inquire about the whereabouts of the aircraft (e.g., contacts know the owner if flying or the FAA has a Flight Plan on file). If AFRCC determines the aircraft is really missing, they will immediately launch a search.

Upon receiving SARSAT coordinates and registration details, the CAP Alert Officer will notify an Incident Commander to launch a search. The success of the search may depend upon several factors. The simple fact that an ELT was aboard

a missing aircraft does not necessarily guarantee that electronic search procedures will locate it because the unit may have become inoperative or the batteries totally discharged. Incident Commanders may attempt to maximize the search effort by conducting an electronic search and a general visual search simultaneously when weather and other circumstances permit.

NOTE: Since SARSAT/COSPAS satellites no longer monitor 121.5 MHz, we must rely on air- and ground-based monitoring (e.g., aircraft and FAA or FBO radios). CAP is still developing procedures on how it will respond to these reports, but we can expect these searches to take longer and be more manpower-intensive for both air and ground teams.

7.2 Locating the ELT Signal

The remainder of this chapter (except for Section 7.10) deals with searching for a 121.5/243 MHz ELT signal. If the signals are coming from a 406 MHz ELT the initial Search Area will be much smaller and thus easier to find, even if your aircraft is not equipped with a Doppler DF unit. *You can easily modify the following procedures for this case.* However, a 406 MHz ELT's 121.5 homing signal is significantly weaker than the old 121.5 MHz-only ELTs; this results in situations where air, ground and maritime SAR assets *may not detect the 121.5 homing signal until within a few hundred yards or less of the beacon.*

Operation of the Doppler DF units is covered in the "Electronic Search Patterns" section of both the CAP Mission Pilot and CAP Mission Observer slides.

Before you can use any technique to locate an ELT, you must first be able to pick it up on your radio. The route (track line) pattern (Figure 7-1) or the parallel track (Figure 7-2) search patterns are the most effective at this stage. The aircraft conducting an electronic search will normally begin the search at or near the last known position (LKP) and fly the search pattern at altitudes from 4,000 to 10,000 feet above the terrain if possible. At this altitude, the aircraft can usually intercept the ELT signal, as well as recognize or distinguish the downed aircraft. At the maximum electronic search altitude, which is much higher than 10,000 feet, chances are slim that one can recognize or distinguish a light plane crash site. Maximum track spacing should be used initially to provide a rapid sweep of the probability area. Successive sweeps should have a track spacing one-half the size of the initial spacing. For example, if the track spacing is 60 nautical miles during the initial sweep of the area, then the track spacing for the second sweep of the area should be 30 nautical miles. A third sweep of the area, if needed, should have track spacing of 15 nautical miles. This method of gauging the track spacing applies to both track line (route) and the parallel track. These procedures may be repeated until the missing aircraft or survivors are located, or until it is presumed that the batteries of the ELT have been exhausted.

In mountainous terrain the initial search pattern should be arranged to cross the ridgelines at right angles, if at all possible. The search coverage of the area should be at right angles to the first coverage tracks to compensate for blockage of the ELT signal due to the shape of the terrain.

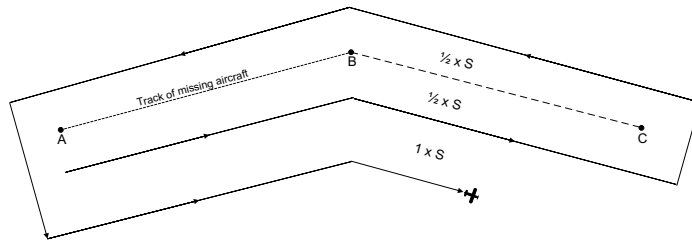

Figure 7-1

Once the searchers are in a position to receive the ELT signal, they may use one of several methods to locate the transmitter and the accident scene. Homing is the simplest and most common method, but it requires special equipment that is not installed in all search airplanes. The metered search also requires special equipment that may not always be available. The signal-null and aural search methods are used less frequently, but they may be used aboard any airplane equipped with a radio receiver. Each requires only the crew's ability to hear the ELT tone through the search aircraft's radio or intercom.

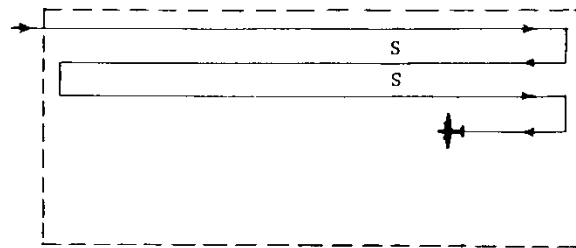

Figure 7-2

7.3 Aircraft Direction Finder (DF)

The L-Tronics LA series Aircraft Direction Finder, the most common DR unit found in CAP aircraft, consists of VHF and UHF receivers, two- or three-element Vagi antennas and circuitry. The controls consist of a frequency selector switch, an alarm toggle switch (works like a light switch), and a dual-knob control switch for volume (inner knob) and sensitivity (outer knob). There are two indications: a DF meter and a signal Strength meter (refer to Figure 7-3).



Figure 7-3

The tone-coded squelch circuit, called the Alarm mode, permits continuous, annoyance-free monitoring for Emergency Locator Transmitters (ELTs) and Emergency Position Indicating Radio Beacons (EPIRBs) on 121.5 MHz.

The DF unit is normally connected to the aircraft audio system. This connection allows an audible as well as a visual alarm when an ELT signal is detected in ALARM mode.



Remote Meter (LRM-2)

The three-whip antenna array provides for dual band operation. The performance of the DF is absolutely dependent on the antenna installation. The whip antennas and the aircraft structure work together to form the directive antenna patterns necessary to the operation of the DF set.

There is considerable interaction between DF and com antennas. The DF switching may put a strong tone on communications receiver signals from some directions. The DF may have to be turned off or the aircraft heading changed for good com intelligibility. In particular, the DF receiver may cause interference to communications on 132.3 MHz when operating on 121.5 MHz (126.85 MHz when using 243.0 MHz). [Note: The new Becker DF is discussed in Attachment 2.]

7.3.1 Normal Operations and Checks

The Alarm mode is the normal mode for routine conditions. It enables the pilot to monitor the emergency frequency (121.5 MHz) without dedicating a communications radio to the task. **DO NOT USE THIS MODE DURING A DF SEARCH** because the DF function is disabled in the Alarm mode.

Place the Alarm toggle switch in the “up” position to select the Alarm mode. Set the Sensitivity so that the needle just comes on-scale and the Volume to a comfortable level (the ear will detect a weak signal far sooner than the alarm). [Note: The Alarm mode is designed to work with weak signals; if an ELT is transmitting nearby and the unit is set to full sensitivity, the receiver may overload.]

If an ELT activates the Alarm, turn the Alarm toggle switch off (down). This activates the DF function and allows you to track the signal.

The alarm unit automatically rejects false signals. The ELT signal must remain at sufficient strength for 5-20 seconds before the alarm light (flashing red LED) is activated.

Functional Check - No transmitter

This is a quick check that can be made part of a preflight routine to assure that a previously checked unit is still working:

1. Select 121.5 MHz on the DF
2. Turn the Alarm toggle switch off (down)
3. Turn the Sensitivity control (outer knob) fully clockwise to maximum
4. Turn on power to the radio system
5. Turn on the DF by advancing the Volume control (inner knob)
6. A hissing sound should be heard through the audio system and the signal strength needle will be between $\frac{1}{4}$ and $\frac{1}{2}$ of the way between the center of the scale and the left-hand end. The DF needle will stay roughly centered.

7. Now turn the Sensitivity control counterclockwise toward minimum. This will cause a decrease in sound volume (some sound may still be heard) and a decrease in the strength meter reading.
8. Next, turn the Sensitivity control to maximum. The DF needle should move randomly back and forth one or two needle-widths about the center in response to receiver background noise. *Movement will be slow and may be difficult or impossible to see.*
9. As a final check, turn the Alarm toggle switch to on (up). The Alarm light should flash for 10 to 20 seconds and then stop. The receiver noise should also cut off at the same time. The Alarm is now set and will respond to a steady ELT signal. *[NOTE: This Alarm setting period occurs each time the Alarm function of the DF is turned on. It tests the Alarm circuits and reminds the pilot that the DF receiver is on.]*

Functional Check - with transmitter and the aircraft on the ground

All features of the DF except the Alarm circuit can be checked using a practice beacon.

1. Park the aircraft in the open, away from metal buildings. The transmitter should be at least 50 feet in front of and 15-30 degrees to one side of the aircraft.

WARNING: Use of high-power transmitters close to the DF antennae can damage the unit. Damage can occur from a 50-watt transmitter if it is within 12 feet of the antennae (3 feet for 5W; 4 1/2 feet for 10W; 15 feet for 80W). The ELT tester should be kept at least 50 feet away from the antennae when using to test for operability of the DF.
2. Select 121.775 MHz on the DF
3. Rotate the Sensitivity control fully counterclockwise to minimum
4. Set the Volume control to about the 12 o'clock position
5. Set the Alarm toggle switch off (down)
6. Turn on the DF and the transmitter. If necessary, rotate the Sensitivity control clockwise until the signal or the DF buzz is heard.
7. The DF needle should point toward the transmitter. Move the transmitter to the other side of the aircraft and observe the DF needle, which should follow the transmitter. NOTE: On the ground it is normal for the needle to be uncertain about centering with the test transmitter directly fore or aft. The DF is OK if the needle points correctly when the transmitter is on either side of the aircraft.
8. Move the Sensitivity control clockwise. The strength needle will move (slowly) further to the right.

Functional Check - with transmitter and the aircraft in flight

Place the practice beacon as high and clear as possible in open terrain. Fly about three to five miles away at 2000 to 3000 feet AGL. Make several full circles, starting with no more than a 10° bank-angle. The DF needle should crossover only twice during the turn at shallow bank. More than two crossings indicate unsatisfactory operation.

Pilots and observers should note how the DF performs at steeper bank angles for future reference. Note where wing shadows occur, as indicated by decreases in the strength meter reading and/or audio volume during steep turns; this is a useful verification of DF indications.

Determine the direction to the practice beacon by turning in the direction of DF needle deflection. With the needle centered, follow the DF course inbound and compare it to the visual heading to the target transmitter. The inbound course and the heading to the transmitter should agree to +/- 5° (up to +/- 15° error is quite usable). If desired, you can note the error on a placard near the DF receiver.

Finally, compare the inbound and the outbound courses using the DG (heading indicator). They should differ by 180°.

Course errors of up to 30° are usually due to unsymmetrical installation of the antennas or, on the ground, to nearby reflecting objects (e.g., cars or buildings). Asymmetry usually causes both front and rear courses to be bent toward the same side of the aircraft and usually toward the source of the problem.

Severe errors or one-sided needle indications are usually due to a damaged antenna-to-switchbox cable or to poor grounding at the antenna or a skin joint nearby. Poor skin-joint contact may well indicate structurally significant corrosion and should be investigated by a mechanic.

7.3.2 DF Operations

Verify or select 121.5 on the frequency switch and place the Alarm toggle switch to off (down). **The Alarm mode must not be used during a DF search because the DF function is not operable in the Alarm mode (toggle switch up).** Set the Sensitivity to maximum and the Volume to a comfortable level.

Climb to an altitude of *at least* 3000 to 4000 feet AGL, if possible. Fly to the area of the reported ELT signal (but remember that the ELT search begins the minute you take off). If the ELT cannot be heard in the expected area, climb to a higher altitude. If this fails to acquire the signal, start a methodical search (e.g., area or expanding square).

Unless the beacon is known to be a 406 MHz EPIRB (which doesn't transmit on 243 MHz) or a military beacon (which uses 243 MHz and may also transmit on 121.5 MHz), switch between 121.5 and 243 MHz at least once each minute until a signal is heard. All civil beacons except 406 MHz EPIRBs and some military beacons transmit on both frequencies. Undamaged ELTs can usually be heard further on 121.5 MHz than they can on 243 MHz; the reverse is often true for damaged ELTs. [Note: The 121.5 homing signal on a 406 MHz ELT is significantly weaker than the old 121.5 MHz ELT; making it harder to detect.]

Initial Heading

When first heard, the ELT signal will probably be faint and will build slowly in strength over a period of several minutes. Continue flying until a reasonable level of signal is acquired. The DF needle should deflect to one side and the Strength needle should swing on-scale. Resist the urge to turn immediately and follow the needle; instead, make a 360° turn at no more than a 30° bank to ensure you get two needle centerings (approximately 180° apart) to verify the heading. When the turn is complete, center the DF needle and fly toward the ELT. Note your heading (write it down) for reference.

If the ELT is heard on both 121.5 and 243.0 MHz, compare the headings. If they differ by more than 45° or if the turn produces multiple crossovers, try a new location or climb to a higher altitude to escape from the reflections.

While flying toward the ELT the DF needle may wander back and forth around center at 10- to 30-second intervals. This is caused by flying through weak reflections and should be ignored. Fly the heading that keeps needle swings about equal in number, left and right.

Signal Fade

Don't become concerned if the signal slowly fades out as you fly towards the ELT. If this happens, continue on your heading for at least six minutes. If you are still headed toward the ELT the signal should slowly build in strength in three or four minutes and be somewhat stronger than before the fade. If the signal does not reappear, return to where the signal was last heard and try a different altitude.

Getting Close

As you get close to the ELT the signal will get stronger, and you will have to periodically adjust the Sensitivity control to keep the signal strength needle centered (*do not* decrease the Volume control as this could overload the receiver). You also need to do this if the DF needle gets too sensitive. Periodically yaw the aircraft and observe the DF needle respond (left and right).

Passing Over

A “station passage” is often seen as a rapid fluctuation in signal strength and confused DF readings. Yaw the aircraft to see if the course has reversed (needle goes in the direction of the aircraft turn). If the course has reversed, continue on your heading for a few minutes. Then turn and make several confirmation passages from different angles while continuing your visual search.

7.4 Homing Method

Homing is an electronic search method that uses a direction finder to track the ELT signal to its source. Tune the direction finder (DF) to the ELT operating frequency; the pilot will fly the aircraft to the transmitter by keeping the left/right needle centered. ELTs may transmit on 121.5 MHz (VHF), 243.0 MHz (UHF), or both frequencies simultaneously. These emergency frequencies are *usually* the ones monitored during a search, but homing procedures can be used on any radio frequency to which *both* a transmitter and DF receiver can be tuned.

In the following scenario, the search objective is an active ELT at a crash site. The first step is to tune the receiver to the ELT frequency and listen for the warbling tone of the ELT signal. Next you have to determine the direction to the ELT. When you fly directly toward a signal, the left/right needle remains centered. However, when you head directly *away* from the signal, the needle also centers. A simple, quick maneuver is used to determine if you are going toward or away from the signal.

Starting with the left/right needle centered, the pilot turns the aircraft in either direction so that the needle moves away from center. If he turns left, and the needle deflects to the right, the ELT is in front. If the pilot turns back to the right to center the needle, and then maintains the needle in the center, you will eventually fly to the ELT.

If, in the verification turn, the pilot turns left and the needle swings to the extreme left, then the ELT is behind you. Continue the left turn until the needle returns to the center. You are now heading toward the ELT, and as long as the pilot maintains the needle in the center, you will fly to the ELT.

Flying toward the ELT, maintaining the needle in the center of the indicator *is* the actual homing process. If the needle starts to drift left of center, steer slightly left to bring the needle back to the center. If it starts to drift right, turn slightly back to the right. Once you have completed the direction-verification turn, you will not need large steering corrections to keep the needle in the center.

When passing over the ELT or transmission source, the left/right needle will indicate a *strong* crossover pattern. The needle will make a distinct left-to-right or right-to-left movement and then return to the center. This crossover movement is *not* a mere fluctuation; the needle swings fully, from one side of the indicator to the other and then returns to the center.

During homing you may encounter situations where the needle *suddenly* drifts to one side then returns to center. If the heading has been steady, and the needle previously centered, such a fluctuation may have been caused by a signal from a second transmitter. Another aircraft nearby can also cause momentary needle fluctuations that you might not hear, but the needle in the DF will react to it. Signal reflections from objects or high terrain can also cause needle fluctuations at low altitudes in mountainous terrain or near metropolitan areas.

7.5 Wing shadow method (signal null)

The signal null or wing shadow method is based on the assumption that the metal skin of the search aircraft's wing and fuselage will block incoming ELT signals from the receiving antenna during steep-banked turns. The observer can make simple estimates of the magnetic bearing to the transmitter by checking the aircraft heading when the signal is blocked.

Once the search aircraft completes several signal-blocking turns in different sectors of the search area, the observer can establish the approximate location of the ELT by drawing magnetic bearings, or "null vectors," on the sectional chart. The ELT and accident scene will be at or near the intersection of the null vectors.

To use the null method, you must know the location of your receiving antenna. On a low-wing airplane, like the Piper *Cherokee*, the com antenna is often mounted on the underside of the fuselage, in line with the wings. On a high-wing airplane, like the Cessna 172, the com antenna is normally mounted on the top of the airplane, again in line with the wings. [Note: You may also use the receiver of your aircraft's DF unit, which is normally mounted on the bottom of the aircraft.]

7.5.1 Procedures

First, verify the receiver is tuned to the proper ELT frequency and that you can hear the warbling tone. Mark your position on the sectional chart, preferably over a small but significant feature. Then the pilot will make a 360° steeply banked (<45°) turn to allow you to determine the signal's direction. As the airplane turns, the ELT tone will break, or null, at the point when the aircraft wing and skin come between the transmitter and the antenna. For a brief instant you will not hear the tone. The absence of the audible tone is referred to as the *null*.

On low-wing aircraft with the antenna installed on the underside, the wing inside the turn, or the "down" wing of the banking airplane, points toward the ELT when the tone nulls. On high-wing aircraft, with the antenna installed on the top surface, the wing on the outside of the turn, the "up" wing, points toward the ELT when the null is heard.

To estimate the magnetic bearing from the search airplane to the ELT, the observer makes simple calculations. In high-wing airplanes, if you're turning left, add 90° to the aircraft heading when you hear the tone null. If you're turning right, subtract 90° from the heading at the instant you hear the tone null. In low-wing airplanes, when you're turning left, subtract 90° from the aircraft heading, and when making right turns, add 90° to aircraft heading.

You may find it simpler to make these bearing estimates using the face of the Heading Indicator. Imagine an aircraft silhouette on the face of the HI: the silhouette's nose points up toward the twelve o'clock position, and the tail points toward the bottom or six o'clock position. The left wing points left to nine o'clock,

and the right wing points to three o'clock. Some heading indicators actually have this silhouette painted on the instrument face, as shown in Figures 7-4 and 7-5. This imaginary plane always mimics whatever the search airplane is really doing.

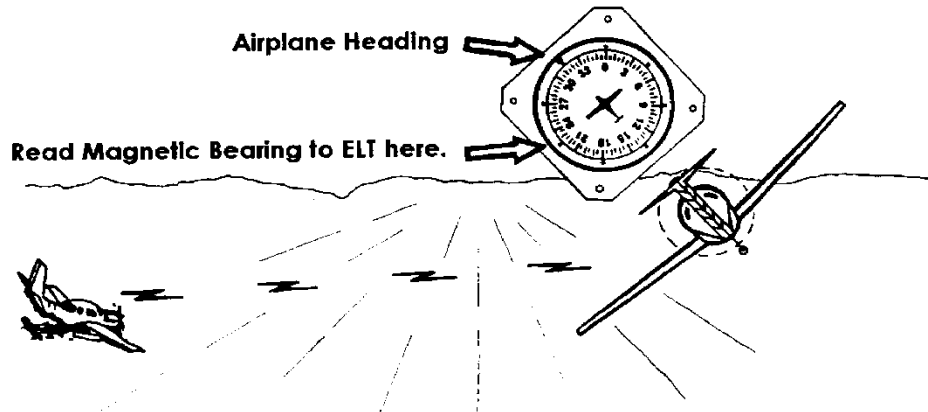

Figure 7-4

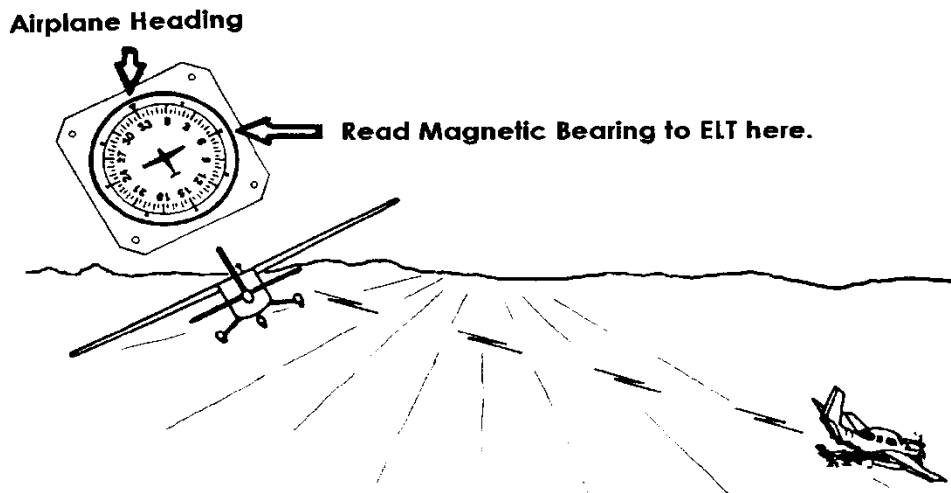

Figure 7-5

Upon hearing the null, the observer should quickly look at the heading indicator. If the search aircraft is a low-wing aircraft, like the *Cherokee*, look for the number adjacent to the imaginary aircraft's low wing, as shown in Figure 7-4. If the search plane is a high-wing, like the *Cessna 172*, look for the number adjacent to the imaginary plane's high wing, as shown in Figure 7-5. That number is the magnetic bearing from the search aircraft's present position to the ELT transmitter.

Regardless of the method used to determine the ELT magnetic bearing, the next step is to convert that magnetic bearing to a true bearing by adding or subtracting the published magnetic variation for that area. Then draw a line on your chart from the search aircraft's known position in the direction of the calculated true bearing. You now have one null vector, or line of position, to the ELT. The ELT is somewhere along that line, but it isn't possible to tell exactly where. To narrow the focus, simply repeat the process starting from another known position over a different geographical point. Don't pick your next geographical point near to or along

the initial null vector. The accuracy of this technique improves if you select geographic points well away from each other. If the points are well separated, the null vector lines will intersect at a larger angle, and the position will be more accurate.

Figure 7-6 shows an entire null signal search. Notice that several fixes may be taken before deciding the limits for the subsequent visual search. Finally, fly to the area indicated by the null-vector intersection and attempt to pinpoint the ELT.

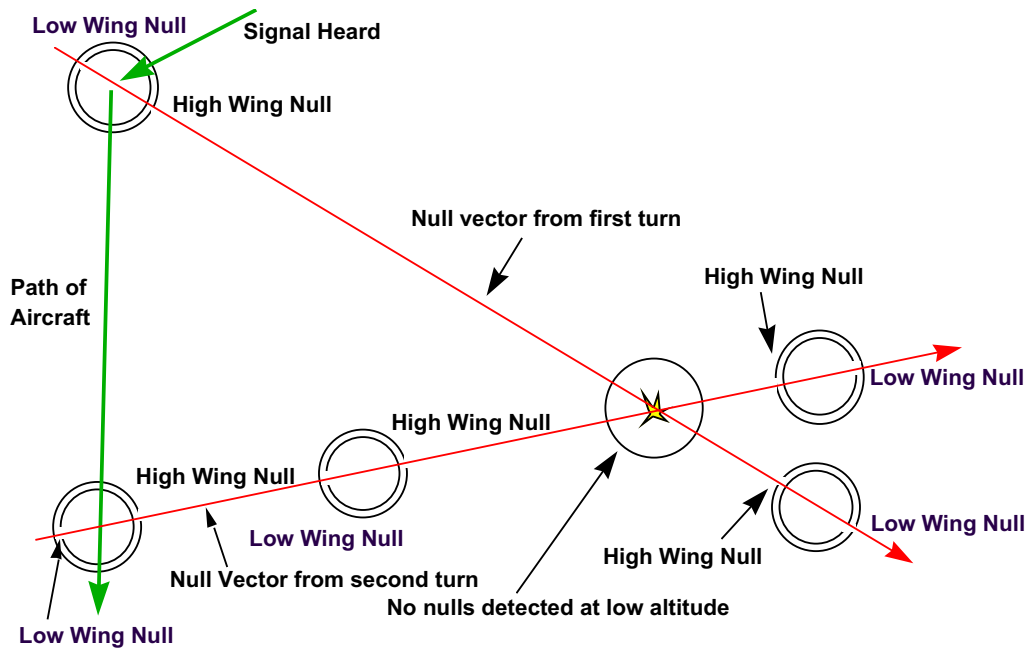

Figure 7-6

Upon reaching the area, the pilot can descend to a lower altitude and execute similar steep turns. If you are very close to the ELT, you can expect to hear no null, due to the higher signal strength near the transmitter and the inability of the wing to block the signal. When an ELT tone is continuous through a full 360° turn, the ELT transmission is very likely in the area beneath the search aircraft. You can then chart the probable location of the missing aircraft or transmitter to within a small area.

If descending to a lower altitude brings the aircraft within 1,000-2,000 feet above the terrain, you should discontinue null procedures. Instead, you should descend to an appropriate lower altitude and begin a visual search.

7.5.2 Special Considerations in Wing Null Searches

Four special considerations must be made prior to and during wing null searches. The most important is crew ability. Maintaining altitude throughout steep turns requires skill and extensive practice. Some aircraft may stall and then spin if over-controlled in poorly executed turns. This can result in a great loss of altitude, structural damage to the airplane during recovery, or collision with the ground. The pilot must be skilled in executing steep-banked turns.

Second is positive knowledge by the search crew of its actual position when the null is heard. By constantly monitoring the search aircraft's position in the turn, you can plot each null vector more precisely.

Third, the search crew must know what to do if the signal is lost during a search. If you lose the signal while trying to pinpoint the ELT location, you can return to the position and altitude of the last contact with the tone. The observer's chart is a useful record of each position where successful procedures were performed.

Finally, as you approach the suspected ELT location, be more alert for other aircraft. Since a search is likely to include more than just your airplane, you should expect the ELT location to become a point of convergence for all aircraft involved in the search. Once you establish the general location of the downed aircraft, you *must* approach the area with caution. A midair collision can easily result if the entire crew's attention is focused on the accident scene while other aircraft approach the same area.

7.6 Aural (or hearing) search

The aural or hearing search technique is based on an assumption that an ELT area of apparent equal signal strength is circular. Throughout this procedure the observer *must not* adjust the receiver volume; constant volume helps assure that "signal heard" and "signal fade" positions will remain consistent. Also, once you begin the procedure, make all turns in the same direction as the first turn if terrain permits. When using this procedure, which does not require a special antenna, the search aircraft is flown in a "boxing in" pattern (Figure 7-7).

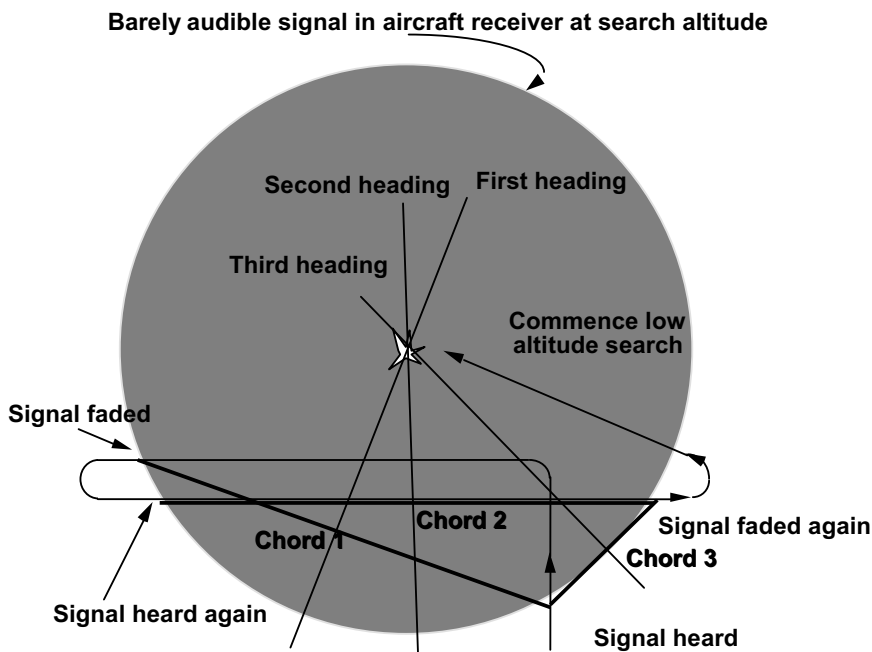

Figure 7-7

The observer begins the aural search by plotting the search plane's position when the ELT tone is first heard. The pilot continues flying in the same direction for a short distance, and then turns 90° left or right and proceeds until the tone volume fades. The observer charts the aircraft position where the tone volume fades. The pilot then reverses aircraft direction, and the observer again marks on the map the positions where the signal is heard again and where it fades. If the radio volume has not been adjusted, the "signal fades" and "signal heard" positions should be

approximately equidistant from the ELT. To determine the approximate location of the ELT, the observer draws lines to connect each set of "signal heard" and "signal fade" positions.

To establish the approximate position of the ELT unit, the observer draws chord lines between each set of "signal heard" and "signal fade" positions. Then the observer draws perpendicular bisectors on each chord. The bisectors are drawn from the mid-point of each chord toward the center of the search area. The point where the perpendicular bisectors meet, or intersect, is the approximate location of the ELT unit (Figure 10-7 illustrates the connection of the signal heard and signal fade positions with the chord lines, the perpendicular bisectors' converging toward the center of the search area, and the intersection over the probable location of the ELT). After the observer establishes the approximate location where the missing aircraft may be found, the pilot flies to that location and begins a low-altitude visual search pattern. [Note: The perpendicular bisectors rarely intersect directly over the objective. However, a low-altitude visual search of the general area can help compensate for lack of precise location.]

7.7 Metered search

To employ the metered search method, the observer uses a signal strength meter to monitor the ELT signal (Figure 7-8). Circled numbers represent the sequence of events: numbers plotted along the track are hypothetical signal meter readings with higher numbers representing weaker signals and lower numbers representing stronger signals.

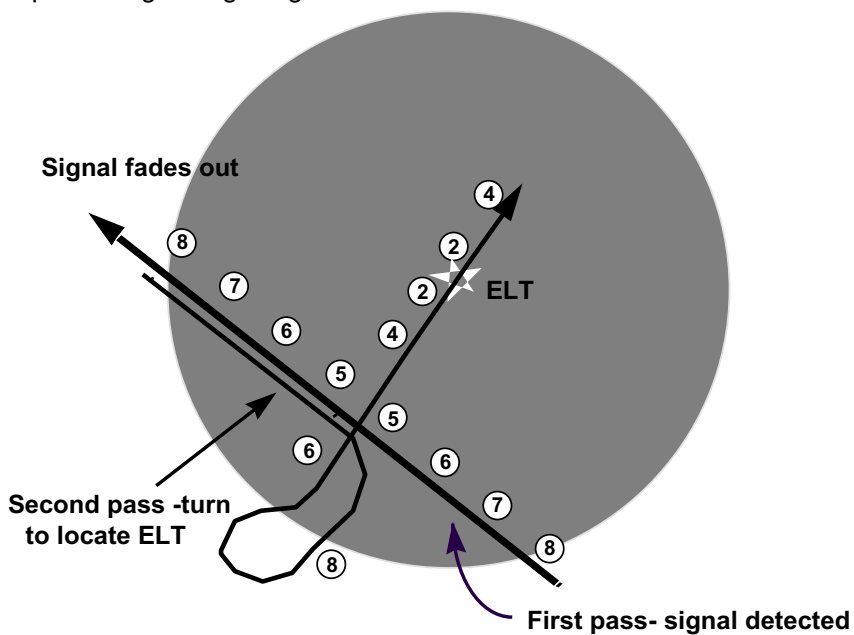

Figure 7-8

Once the aircraft enters the search area, the observer plots two positions of equal meter strength. The observer records the first ELT signal strength (assume the signal strength measures 8.0) and plots the search aircraft's position on the chart. The pilot continues flying the aircraft in the same direction and the signal strength will first increase, then decrease. When the signal strength returns to the

previous value (8.0), the observer plots the aircraft's position. The observer now plots the midpoint between these two points, while the pilot reverses direction and flies back toward that midpoint. Upon reaching the midpoint, the pilot makes a 90° turn to the right or left. If signal strength begins to fade, the search aircraft is heading in the wrong direction and the pilot corrects by reversing direction. This last change now carries the search aircraft toward the ELT. The search crew then begins a visual search at an appropriate altitude.

7.8 Night and IFR electronic search

Each of the preceding electronic search methods has certain limitations that affect its usefulness during darkness or in instrument conditions. In this discussion, "instrument meteorological conditions" (IMC) means weather conditions that compel the pilot and crew to operate and navigate the aircraft by referencing onboard instruments and navigational radios.

7.8.1 Night ELT searches

Darkness eliminates your ability to precisely determine your position in reference to the ground, and that impacts the effectiveness of your search. Once you've successfully homed to an ELT you can usually narrow the target area down to about one square mile. Unless the ELT is located on an airfield or the occupants of the target aircraft are able to signal you, you will have to call in a ground team or land at the nearest airport, arrange for transportation, and find the ELT with hand-held equipment.

If you have a GPS that will plot your flown track, you can pinpoint the ELT position more accurately. After station passage is assured, fly another two minutes. Make a 90° turn (either way) and fly for another five minutes. From this point, DF back to the ELT and repeat the process, making turns in the same direction. When you look at the plotted track on the GPS, the lines will cross at a point over the ELT. You can then read off a Lat/Long position from the GPS, which is usually good to better than 1/2 mile - certainly good enough to get a ground crew headed to the right place. This technique can also be used in IMC.

7.8.2 IMC ELT searches

It is possible to DF in IMC, but this is dangerous and not to be undertaken lightly. Instrument flight imposes a higher workload on the pilot and demands a higher level of training and proficiency. As discussed earlier, the ability to fly steep-banked turns and other maneuvers without losing altitude is demanding for even the most proficient pilot. Trying to conduct these maneuvers while flying solely by referencing the flight instruments is not wise; the pilot can easily get vertigo and lose control of the aircraft.

For these reasons only highly trained and proficient pilots should attempt to DF in IMC, and it is highly recommended that another equally proficient instrument-rated pilot fly in the right seat. CAPR 70-1 also imposes extra restrictions under certain conditions.

7.9 Signal Reflection and Interference

Radio signals reflect off terrain and manmade objects, and this can be a problem for search and rescue teams. In an electronic search, it is vitally important to know if the equipment is reacting to reflected signals and what you can do to overcome the problem. Although tracking a signal is the best means of locating an ELT, actually isolating the signal can occasionally become a problem. The following scenario illustrates one approach to a signal reflection problem.

After receiving a briefing, the pilot and observer check their aircraft and take off. Upon reaching the designated search area, the observer picks up an ELT signal. Using the DF, the search crew follows the signal for 10 minutes in a northerly direction. The observer later notes that keeping the left/right needle centered requires a 60° turn. This sudden turn causes the observer to conclude the signal is being reflected for two reasons. First, it is highly unlikely that the aircraft wreckage moved, causing a change in direction. Second, if sufficient crosswind was present to cause the change, it should have been noticeable earlier. Since the wreck didn't move, and there is no significant crosswind, the observer concluded that the apparent course problem was caused by reflected signals.

The observer can have the pilot climb to a higher altitude to eliminate or minimize the effects of reflected signals. Reflected signals are usually weaker (lower signal strength) than those coming directly from the transmitter, so climbing can help the stronger direct signals come through. Also, depending on the terrain, a higher altitude may result in more time available for the crew to detect the transmitter. Figure 10-8 shows how climbing to a higher altitude can help overcome the problem of signals blocked by terrain.

NOTE: You can take advantage of the fact that reflected signals are generally weaker by tuning your radios further away from the primary frequency (signal-offset). Assume the ELT is transmitting on 121.5; one radio will be tuned to this frequency and the other will be set to 121.55. You toggle back and forth between the two frequencies as you approach the suspected location until you hear a signal on 121.55. As you home in on the target make 121.55 the primary and set 121.6 on the other radio and repeat the process (you may even work up to 121.7). As you get further away from the initial frequency the area where the signal will break through the squelch becomes smaller and smaller (you can even turn up the squelch to get further isolation). This method also works well from the ground.

The specific pattern used during an electronic search over mountainous or hilly terrain can help compensate for blocked signals and reflections. You should alternate flying patterns parallel to valleys or ridges, and flying the patterns at perpendicular angles. The following example (Figure 7-9) demonstrates this technique.

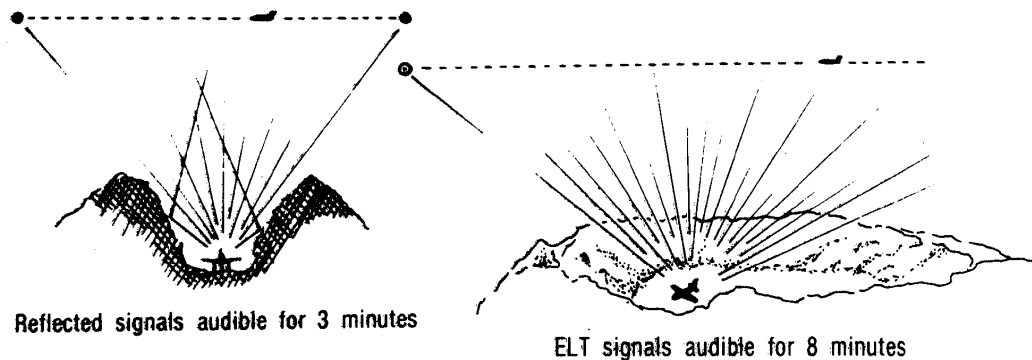

Figure 7-9

The crew receives the briefing and flies to its assigned area. A range of mountains extending north to south divides the rectangular-shaped area. The search crew elects to fly the initial pattern over the area east to west, and then returns west to east. After making 5 uneventful passes over the mountains 10,000 feet above the terrain, the observer hears the ELT on the sixth pass. On subsequent passes the observer hears the signal for three minutes during each pass and plots each area where the signal was audible. To further define the ELT position, the observer requests the pilot fly a course perpendicular to the previous headings. This new course takes the aircraft parallel to the mountain range. On the third pass near the mountains, the observer hears the ELT again, this time for eight minutes. After another pass over the area to verify the eight-minute reception, the observer plots a small area on the map as a likely location of the ELT. The observer concludes that terrain is a major factor in causing the signal to be audible for short periods of time. The missing aircraft has possibly crashed in a ravine or narrow canyon that permits transmission of the ELT signals to a limited area above the crash site.

Descent to a lower altitude helps confirm the observer's speculation. The missing aircraft has crashed in a long, narrow ravine running parallel to the north-south mountain range. The mountain walls around the aircraft significantly limit transmission of the signals in an east-west direction, so the observer is only able to hear the signal for three minutes while searching in an east-to-west or west-to-east direction. When the aircraft track is parallel to the mountain range, the observer hears the signal for eight minutes. When the crew flies along the length of the ravine where the plane crashed, they are able to maintain signal contact for a longer time.

When faced with strange circumstances like the two examples described above, try to visualize the situation and search for a logical explanation. Consider every factor that could cause the problem, including equipment reliability, terrain, other sources of interference like the electrical fields of high-tension power transmission lines, and the direction finding procedures themselves. If one method of electronic search doesn't yield the results you expect, try another method. Don't become so involved with one method that you can't switch to a more suitable method if the situation demands.

NOTE: If a signal is *only* received on 243 MHz, it *may* be a malfunctioning antenna (e.g., an FAA tower). If you DF to the location (particularly on or near an airport) and you keep ending up at an antenna, investigate. Find out who owns the antenna and its purpose. Inform the IC and let the controlling agency troubleshoot the problem.

Electronic searches are normally only as effective as the crews employing them. They work best when the equipment, environment, and terrain are ideal. Unfortunately, such ideal conditions seldom exist. Crews must practice search methods to better understand difficulties caused by various conditions. This will help them be prepared to deal with less than ideal conditions. Whenever you are faced with strange circumstances, you should seek the most logical explanation. In looking at the problem, always consider every factor that could possibly cause the situation. Consider the equipment reliability, the terrain and the DF procedures. If one method of electronic search doesn't yield the type of results you expect, try another method. Don't become so involved in one method that you can't adopt a more suitable method if the situation demands it.

7.10 Silencing an ELT

If you don't have a ground crew and you have determined the ELT signal is coming from (or very near) an airfield, you will have to land and find the offending aircraft. You can use a hand-held DF unit (Little L-Per or Tracker) and/or a hand-held radio to locate the aircraft.

Sometimes you locate the hangar and find it is full of aircraft. Two methods are very useful in narrowing down the search: the signal-offset method was discussed in section 7.9; another way is to use a hand-held radio. Hold the radio by one of the suspect aircraft (its ELT antenna, if mounted on the exterior) and turn the volume down until you can just hear the signal, then move to the next suspect aircraft and repeat. If the signal is stronger you probably have it; if it is weaker or cannot be heard it's probably the other aircraft. If needed, repeat with the radio's antenna removed; *warning*: do not key the radio's transmitter while its antenna is removed! [Note: You may also incorporate portions of the signal-offset method with this method.] Another technique is to slip an aluminum foil "sleeve" over the suspect ELT antenna while holding the radio by the antenna; if the signal fades significantly, you have found the signal.

Note that signal strength of a 406 MHz ELT's 121.5 homing signal is significantly reduced compared to dedicated 121.5 MHz-only beacons; you have to be closer to the beacon to detect it and this makes them more difficult to find (especially if it's coming from inside a hanger).

Don't ignore the obvious: some aircraft have remote indicating lights (usually red; Figure 7-10) that flash when the ELT has activated; also look for obvious signs of disturbance near an ELT.



Figure 7-10

Most 406 MHz ELTs have an aural monitor (siren-type) that can be used to locate an ELT in a confined area such as a hanger. They also have a light (Figure 7-10a) above the Remote rocker switch (usually mounted on the front panel) that can be seen once you have access to the aircraft.



Figure 7-10a

Once you have determined which aircraft the signal is coming from, you have to find the (physical) ELT. Most are located in the rear of the aircraft; also look for remote switches. The following gives some general locations:

- Single-engine Cessna: right side of the upper baggage area immediately aft of the baggage door
- Multi-engine Cessna: left side of the fuselage just forward of the horizontal stabilizer. Accessed through a small push-plate on the side of the fuselage.
- Single- and multi-engine Piper: in the aft fuselage. Accessed through a small access plate on the right side of the fuselage (need a screwdriver)
- Single- and multi-engine Bonanza: in the aft fuselage. Accessed through a small access plate on the right side of the fuselage (need a screwdriver).
- Large piston twins (e.g., King Air) or small jets: if installed it's probably in the rear section. No visible antenna. May have a small round push-plate that gives you access to the switch with your finger.

The preferred method of silencing a transmitting ELT is to have the owner (or a person designated by the owner) turn it off and disconnect the battery; second best is just turning it off. Some owners will take the switch to OFF and then back to ARMED; monitor the emergency frequency for several minutes afterwards to ensure the ELT doesn't resume alarming.

If you cannot find the owner (or designee), you may have to construct an aluminum foil 'tent' to limit the ELT signal range. Refer to Figure 7-11.

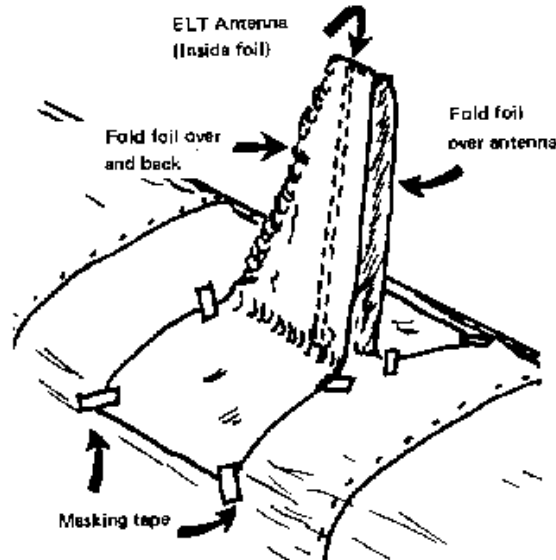

Figure 7-11

Take a piece of foil about one foot wide by about five feet long. Place the tip of the ELT antenna in the center of the foil and fold the foil down on both sides of the antenna. Let the ends lay flat against the fuselage; the flaps *must* extend at least 18" beyond the antenna. Fold the two sides of the 'tent' together to completely enclose the antenna and *securely* tape the foil to the fuselage (use a tape that won't damage the paint, such as masking tape).

Whatever you do, *do not leave an ELT/EPRIB in the alarm state unless ordered to do so by the IC/AFRCC*. You will have to consult your IC, AFRCC, and/or law enforcement to silence the ELT if the above methods are not practical.

Last but not least, ensure the aircraft owner is notified that the ELT was disabled. If you can't obtain a phone number, you can put a note on the aircraft (not a window) stating that the ELT has been disabled. Make your own notes and carry some in the aircraft.

Warning! Some newer aircraft have a rocket-propelled (ballistic) parachute system. The parachute usually is mounted on top of the fuselage just aft of the rear window, hidden by the paint. Warning signs (see below) are stenciled on either side. If the aircraft you have found has really suffered damage, stay clear of the aircraft.



7.10.1 Legal Issues

Per CAPR 60-3 Chapter 1, CAP members will not enter private property and should not do anything that could cause harm or damage to the distress beacon or aircraft/boat. If entry is required the owner/operator or local law enforcement officials will make it.

A transmitting ELT is under the legal authority of the FCC, and federal law requires that it be deactivated ASAP. However, CAP members *do not have the authority to trespass onto private property*, either to gain access to the aircraft or to enter the aircraft to gain access to the ELT. You must gain permission from the owner before you enter a private hangar or an aircraft. In some cases, especially at an airport, FBO personnel have permission to enter aircraft on the premises and can assist you. [NOTE: A *crashed* aircraft is under the authority of the National Transportation Safety Board (NTSB) *and no one else*. Federal law permits the NTSB to request assistance from federal, state and local agencies (including CAP) to secure a crash site.]

While entry upon private property may be justified if such an act is for the purpose of saving life, every effort should be made to obtain the controlling agency's and/or the property owner's consent. If you need entry onto private property in order to search for an ELT, law enforcement authorities such as local police, the county sheriff's office or game wardens may be contacted for assistance.

Normally, local law enforcement officials (don't forget Game Wardens) are happy to assist you. If they are not familiar with CAP and your responsibilities, a simple explanation often suffices. If this doesn't work, try calling your IC or the AFRCC and have them explain the situation.

Each state is the master of its own territory and appoints a chief SAR officer. Under a state-federal MOU, the AFRCC coordinates all inland SAR efforts. Note that 'coordinate' is not the same as 'command.' While AFRCC has legal authority to tell you to search someplace, the state SAR officer has legal authority to tell you NOT to.

The most important aspect in dealing with local law enforcement appears to be the manner in which the CAP personnel approach the matter. The local civil authorities are in charge. In some states, the chief SAR officer may be the governor; in some it may be the state Adjutant General of the National Guard. If the AFRCC tasks you to search, you go search and offer assistance to the civil authorities when the opportunity presents itself. If they tell you go home, leave the scene and phone your IC or AFRCC; let them find out what the problem is and solve it.

The FCC may issue warning letters, violation notices and fines, if appropriate in cases involving non-distress activations. However, if you run across a hoax or activation through gross negligence it should be reported to the nearest FCC field office.

Although not your responsibility, owners may ask you whether or not they can fly with a deactivated or inoperative ELT; the rules are found in FAR 91.207. An aircraft with an inoperable ELT can be ferried from a place where repairs or replacements cannot be made to a place where they can be made [91.207(3)(2)]. An aircraft whose ELT has been temporarily removed for repair can be flown if aircraft records contain an entry concerning the removal, a placard is placed in view of the pilot showing "ELT not installed," and the aircraft is not operated more than 90 days after the ELT was removed [91.207 (f) (10)].

7.10.2 AFRCC information

You need to keep a log of the ELT search in order to provide certain information to AFRCC. This information will be given to the Incident Commander, and is required before AFRCC will close out the mission.

1. Date and time (Zulu) you left on the sortie
2. Date and time the ELT was first heard
3. Time in the search area and time enroute (hours and minutes; Hobbs)
4. Area(s) searched
5. Actual location of the ELT, including latitude and longitude
6. Date and time the ELT was located and silenced
7. ELT model *, manufacturer *, serial number and battery expiration date
8. Position in which you left the ELT switch: On, Off, or Armed
9. Other (not required): 'N' or vessel number, make and model, owner information, and how the ELT was actuated

* ACK E01, Ameri-King AK-450, ACK E-01, ARTEX 110-4 or 200, EBC 502, Dorne and Margolin ELT14, Narco ELT910 and Pointer 3000 are some of the most common 121.5 MHz ELTs (ARTEX's ME-406 and ME-406 ACE and the Martec KANNAD 406 AF are some of the first 406 MHz ELTs)

8. Visual Search Patterns

Almost all search and rescue missions are concluded by visual searches of the most probable areas once good information has been received from electronic searches, SARSATs, or other sources. This chapter will cover visual search patterns, some advantages and disadvantages of each and some of the factors that help determine the type of search pattern you should use. The observer and mission pilot must carefully assess several important factors and their effects that go into the planning phase of a search operation.

Because of the accuracy and reliability of the present Global Positioning System and GPS receivers, CAP aircrews are now able to navigate and fly search patterns with unprecedented effectiveness and ease. The GPS has become the primary instrument for CAP air missions, and it is vital that pilots and observers know how to use the GPS to fly these patterns.

However, observers must also be familiar with the other navigational instruments onboard CAP aircraft. These instruments complement the GPS and serve as backups in case of GPS receiver problems.

Note that this section deals with navigational instruments as a *mission* tool and is not concerned with the FAA rules and restrictions on GPS use under the Federal Aviation Regulations. Under these rules, older CAP GPS receivers are for VFR use only and are not certified for instrument flight (the G1000® is the exception); the FAA certified navigational instruments are the ADF, VOR, and DME. It is the responsibility of the pilot-in-command to adhere to all applicable FAA and CAP rules and regulations pertaining to the use of these instruments.

OBJECTIVES:

1. Plan and describe how to fly a route search. {MO O-2109; MP O-2102}
2. Plan and describe how to fly a parallel search. {MO O-2110; MP O-2102}
3. Plan and describe how to fly a creeping line search. {MO O-2115; MP O-2102}
4. Plan and describe how to fly point-based searches. {MO O-2112; MP O-2102}
5. Discuss how to plan and fly a basic contour search.

NOTE: Scanners need a basic knowledge of the search patterns.

8.1 Planning Search Patterns

Before missions are launched, the briefing officer provides pilots and crewmembers with information designating the routes to and from the search area, and the types of search patterns to be used upon entering the search area. Mission observers, in their role as mission commander, should be able to plan and perform each type of search pattern: besides becoming proficient as a mission commander, this allows the observer to better assist the mission pilot and help ensure the success of the mission.

The following descriptions are directed primarily toward a single aircraft search, and will cover track line, parallel, creeping line, expanding square, sector and contour search patterns.

The majority of CAP aircraft are Cessna 172s that only carry three crewmembers, so *we assume that the crew consists of a pilot, an observer in the right front seat, and a single scanner in the rear seat.* We assume that the observer will be looking out the right side of the aircraft while the scanner covers the left side; therefore the observer's primary duty during the search is to be a scanner. If a larger aircraft is used there may be two scanners in the rear seat.

The observer (as mission commander) must be aware of how many scanners will be on board in order to assign which side of the aircraft they should scan. *Planning and executing a search pattern with only one scanner on board is quite different from one where you have two scanners.* Likewise, having an observer and two scanners on board will allow the observer to spend more time assisting the pilot without seriously decreasing search effectiveness.

When you are planning and flying search patterns, always perform a *stupid check* -- as in "Hey! Wait a minute. This is stupid." Use this to see if your headings, waypoint positions, Lat/Long coordinates and distances look sensible. At a minimum, perform this check after you finish planning, when you start your pattern, and periodically thereafter. For example, you've just entered a set of Lat/Long coordinates into the GPS and turned to the heading shown on the GPS. You know the coordinates represent a lake southwest of your position, so check the heading indicator to see you're actually traveling in a southwesterly direction. Or, you know the lake is approximately 25 nm away; check the distance indicated on the GPS! You'd be surprised how many mistakes this method will catch.

In the following discussions of the parallel line, creeping line and expanding square search patterns, examples (worksheets) are given to aid in pre-planning each pattern. The examples are designed for aircraft using the older (non-moving map) GPS units, but the information you will need to set up the search pattern in the GX-50/55 is included on the worksheets. *Note:* The Garmin G1000® requires specialized training and is not covered here; refer to the NESAS MAS Cessna Nav III G1000® Search Pattern Procedures manual and the Garmin G1000® Integrated Flight Deck Pilot's Guide (provided separately).

In both cases (old versus new GPS), *pre-planning (plotting) your search pattern results in the most effective search.* Pre-planning sets the details of the sortie in your mind and makes entering your data (correctly) into the GPS much easier. This allows the pilot and observer to concentrate on their primary task by minimizing navaid setup time and reducing confusion. The worksheets used in our examples (and included in the *Flight Guide*, Attachment 2) are just one method you can use to pre-plan your search patterns.

8.2 Track line (route) search

The planner will normally use the track line (route) search pattern when an aircraft has disappeared without a trace. This search pattern is based on the assumption that the missing aircraft has crashed or made a forced landing on or near its intended track (route). It is assumed that detection may be aided by survivor signals or by electronic means. The track line pattern is also used for night searches (in suitable weather). A search aircraft using the track line pattern flies a rapid and reasonably thorough coverage on either side of the missing aircraft's intended track.

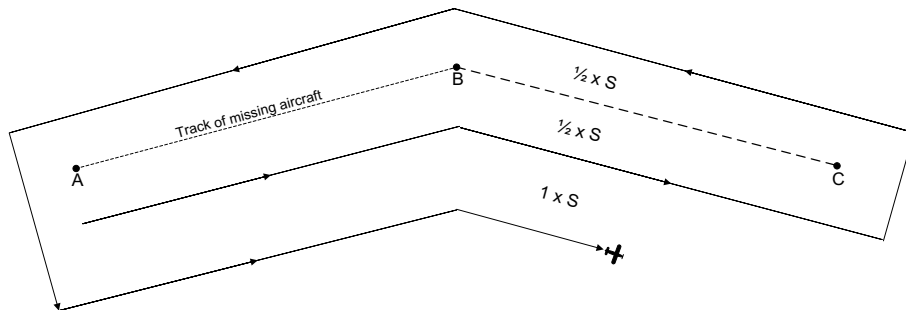

Figure 11-1

Figure 8-1 illustrates the track line search pattern. Search altitude for the track line pattern usually ranges from 1000 feet above ground level (AGL) to 2000 feet AGL for day searches, while night searches range 2000 to 3000 feet AGL (either depending upon light conditions and visibility). Lat/Long coordinates for turns are determined and then entered into the GPS as waypoints, which may then be compiled into a flight plan.

The search crew begins by flying parallel to the missing aircraft's intended course line, using the track spacing (labeled "S" in Figure 8-1) determined by the incident commander or planner. On the first pass, recommended spacing may be one-half that to be flown on successive passes. Flying one-half "S" track spacing in the area where the search objective is most likely to be found can increase search coverage. You may use a worksheet to draw the route and to log coordinates and distinctive features.

The GX-50/55 has a function called "parallel track offset" that is very handy for route searches. This function allows you to create a parallel course that is offset to the left or right (up to 20 nm) of your current flight plan. This function can also be useful on when you wish to search a 'corridor' of airspace.

8.3 Parallel track or parallel sweep

The parallel track (sweep) procedure is normally used when one or more of the following conditions exist:

- The search area is large and fairly level
- Only the approximate location of the target is known
- Uniform coverage is desired

The aircraft proceeds to a corner of the search area and flies at the assigned altitude, sweeping the area maintaining parallel tracks. The first track is at a distance equal to one-half ($\frac{1}{2}$) track spacing (S) from the side of the area (Figure 8-2). [Note: In the example the aircraft makes all turns inside the grid; if the briefer

and circumstances allow (no aircraft in adjacent grids), turns should be made outside the grid in order to give the scanners short breaks.]

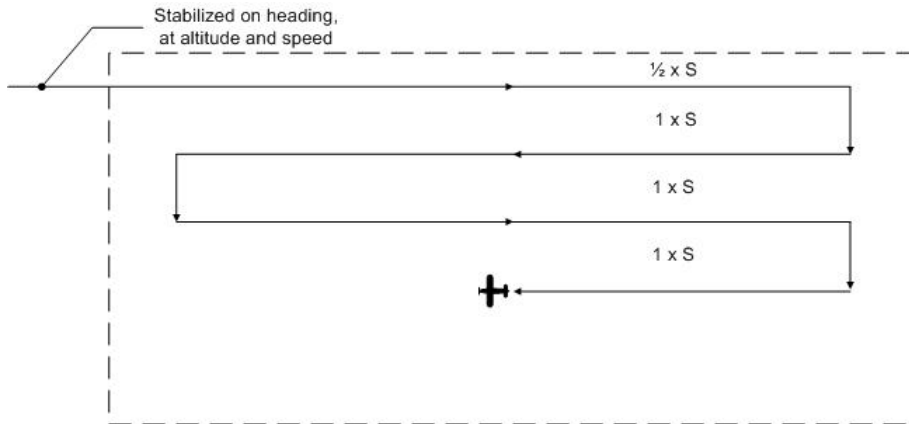
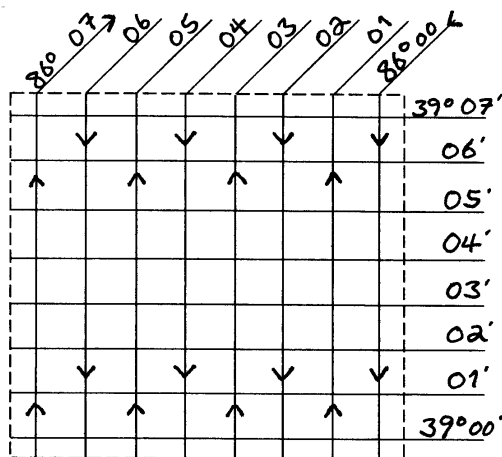

Figure 8-2

This type of search is used to search a grid. A worksheet (Figure 8-3) may be used to plan the search. You can use this to enter the latitudes and longitudes that define the entry point and bound the grid (or generate a flight plan).

Grid Coordinates

SECTIONAL: STL (N)S GRID# 104 A B C D
 ENTRY POINT: N 39°07.5' W 86°00'
 EXIT POINT: N 39°07.5' W 86°07'



	NAVIGATIONAL AIDS		
	IDENTIFIER	FREQUENCY	RADIAL
1.	<u>OOM</u>	<u>110.2</u>	<u>090°</u>
2.	<u>ABB</u>	<u>112.4</u>	<u>330°</u>

Figure 8-3

In the example, you will be searching STL Grid #104-D, which is a quarter-grid measuring 7.5' x 7.5'. Plot the grid's coordinates and draw the pattern starting at the entry point (northeast corner); include track spacing (one nm) and the direction

of the legs (north/south). You will enter the entry point coordinates as a waypoint (N 39° 07' W 86° 00'; northeast corner). As you fly to the entry point, set up at search altitude and speed about 3-5 miles out. Then fly the pattern using the GPS' continuous latitude/longitude display (e.g., present position). Remember, latitude increases as you go north; longitude increases as you go west.

For planning, the following table gives the approximate time it takes to fly a quarter-grid (assuming seven legs, seven turns, no wind and 1-nm track spacing).

Speed over ground	NM per minute	Total Time (minutes)
80 knots	1.33	46.2
90 knots	1.5	42
100 knots	1.67	38.5

Even though you are using the GPS Lat/Long display, it's still helpful to note your headings for the legs (in the example, north and south). Once you have flown a couple of legs you will have two headings that you can shoot for that will correct for any wind; it's easier to use the heading indicator as your primary indicator and check your accuracy with the GPS. [Note: if you're not using your VOR heads, set the top OBS with one heading (e.g., north) and the lower OBS to the other heading -- use all available equipment.]

Also, always enter relevant VOR cross-radials onto your worksheet; use them as a backup and to verify important positions.

Latitude, Longitude, and Distance

For training purposes, we assume that "one minute = one nautical mile."

In the continental U.S., one minute of latitude is equivalent to 1.0018 nm; for our purposes you can assume that if you fly one minute of latitude (north/south) you are covering one nm -- very handy for flying 1-nm east/west track spacing with 'present position' displayed on the GPS.

Longitude isn't so clean: in Washington state one minute of longitude may be equivalent to 0.6572 nm, in the central parts of the country its 0.7695 nm, and in Florida it may be 0.9152 nm. This means that to fly a north/south 1-nm leg means flying anywhere from 1.5 to 1.1 minutes of longitude, depending on where you are in the country. This isn't hard to do, but for training we fly one-minute longitudinal legs even though it means flying less than 1-nm north/south track spacing). [To find the latitude/longitude/distance relationship for your area, go to <http://jan.ucc.nau.edu/~cvm/latlongdist.php>]

In the example above (Figure 8-3) you are flying a quarter-grid with north/south legs and one-mile track spacing. The aircraft enters the grid at the northeast corner and flies a constant longitude (W 86° 00') southbound until the pilot sees the latitude decrease to where she will begin her turn to the east (e.g., N 39° 00'). When she completes the 180° turn she should be flying a constant longitude northbound, offset one mile east of the first leg (W 86° 01'; remember, for training we are using "one minute = one nautical mile"). The pilot will continue up this longitude line, watching the latitude increase until it is time to begin the next turn to the east (e.g., N 39° 07'). This process will be repeated until the search is completed.

Note: The turns in the example above will take the aircraft out of the grid north and south; make sure no other aircraft are assigned to the grids north or south of

yours. If aircraft are assigned to adjacent grids, make sure you complete your turns *inside* your grid.

GX-50/55

All the data you need set up this search pattern in the GX-50/55 is on the worksheet:

- Type of Grid and Sectional (US grid, STL)
- Type of pattern (Parallel Line)
- Grid (104D2, where '2' indicates entering the northeast corner of D quadrant *)
- Spacing (1 nm)
- Direction of Travel (N/S)

* The GX-50/55 identifies the corners of quadrants by numbers: 1 = enter the NW corner; 2 = NE corner; 3 = SE corner; and 4 = SW corner. In our example you would enter "104D2."

Note: If you wish, record this data separately (e.g., a list or table) to make it even easier to enter into the GX-50/55. The example, above, and the other examples that follow are listed in the sequence that you enter them into the GX-50/55.

This pattern is also included in the G1000® SAR package.

8.4 Creeping line search

The creeping line search pattern is similar to the parallel patterns. The parallel pattern search legs are aligned with the major, or longer, axis of the rectangular search areas, whereas the search legs of the creeping line pattern are aligned with the minor or shorter axis of rectangular search areas. Figure 8-4 shows the layout of this search pattern, as used to search along the extended centerline of an airport. The planner uses the creeping line pattern when:

- The search area is narrow, long, and fairly level
- The probable location of the target is thought to be on either side of the search track within two points
- There is a need for immediate coverage of one end of the search area

Note: This pattern is included in the GX-50/55 and G1000® SAR packages.

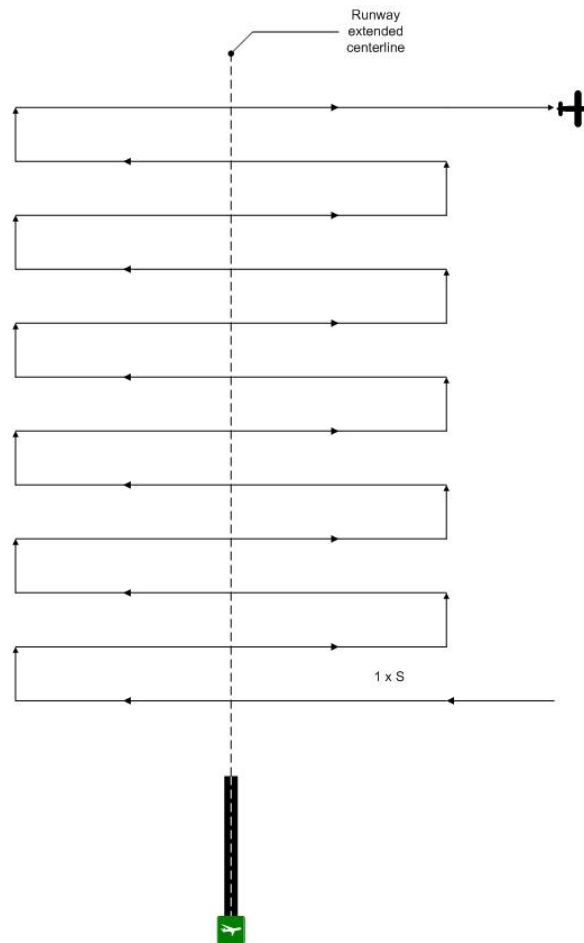

Figure 8-4

This coverage is followed immediately by rapid advancement of successive search legs along the line. Rectangular and elongated are the two forms of the creeping line pattern. For each form, the starting point is located one-half search track spacing inside the corner of the search area.

Successive long search legs use track spacing assigned by the incident commander or planner, while the short legs may be flown to within one-half that spacing of the search area's edge.

A worksheet (Figure 8-4a) may be used to plan the search. Assume you will be searching along Highway 31 between Columbus and Seymour, starting at the intersection with Highway 9 and ending at the intersection with Highway 50 (just east of Seymour). Draw the pattern starting at the entry point (intersection of Hwy 31/9, Columbus); include track spacing (one nm) and make each leg extend three nm east and west of the highway. You will enter the entry point coordinates as a waypoint (N 39° 10' W 85° 53'). As you fly to the entry point, set up search altitude and airspeed three to five miles out, then fly the pattern using the GPS' continuous Lat/Long display. In this example, you will initially fly a constant latitude line of N 39° 10' until you reach W 85° 47' where you will turn right 180° and stabilize on a constant latitude line of N 39° 09'; repeat this process until the search is completed. [Note: You may also create a flight plan for the pattern.]

Creeping Line Coordinates

SECTIONAL: STL \odot S GRID# _____ A B C D

ENTRY POINT: N 39°10' W 85°53'

EXIT POINT: N 38°59' W 85°53'

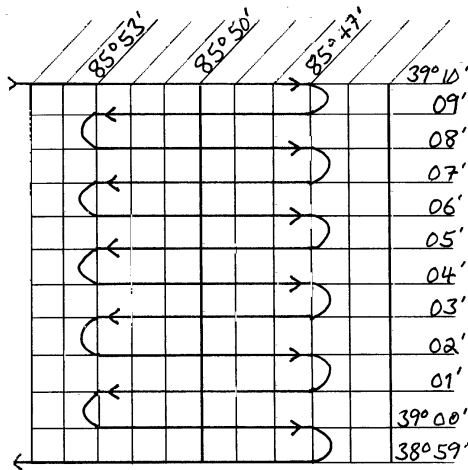

	IDENTIFIER	NAVIGATIONAL AIDS FREQUENCY	RADIAL
	<u>OOM</u>	<u>110.2</u>	<u>090°</u>
2.	<u>SHB</u>	<u>112.0</u>	<u>181°</u>
3.	<u>OOM</u>	<u>110.2</u>	<u>097°</u>

Figure 8-4a

If the route is along a cardinal heading such as the highway in Figure 11-4a, then the pilot will simply fly the creeping line using continuously displayed latitude and longitude. However, when the route is not a straight line aligned with a cardinal heading, another method may be used to fly a creeping line search pattern (Figure 8-4b).

Creeping Line Coordinates

SECTIONAL: STL \odot S GRID# _____ A B C D

ENTRY POINT: N 39°03' W 86°24'

EXIT POINT: N 39°03' W 86°48'

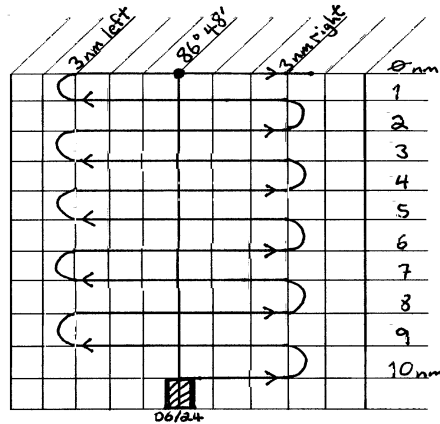

	IDENTIFIER	NAVIGATIONAL AIDS FREQUENCY	RADIAL
1.	<u>OOM</u>	<u>110.2</u>	<u>240°</u>

Figure 8-4b

Assume that the aircraft will be flying a creeping line for ten miles southwest along an (imaginary) extended runway centerline (06/24 at BMG), and it is desired to fly three miles to either side of the extended runway centerline with one-mile track spacing. Draw the pattern starting at the entry point (Runway 06, BMG); include track spacing (one nm) and make each leg extend three miles either side of the extended centerline. In the right column enter the distance from the waypoint for each leg, starting at ten miles and counting down. Enter the exit point's Lat/Long (N 39° 03' W 86° 48'; ten miles southwest of the end of runway 06) in the GPS as a waypoint.

Enter the airport (BMG) as a destination and fly to it. Set the aircraft up at search altitude and airspeed three to five miles from the airport. Select the waypoint you created as your new destination.

When you fly over the end of Runway 06, zero (reset) the CDI display on the GPS. This sets up a *route* in the GPS that represents a direct line between the entry (end of runway 06) and exit points. The GPS should show ten miles to the destination, and the CDI will be centered.

Use the distance to the destination to establish and maintain one-mile track spacing; use the CDI deviation indication to indicate when you have gone three miles to either side of the line.

The pilot begins his first turn, for example to the right. By maintaining the distance from the destination constant (e.g., ten miles) the aircraft will be flying *almost* perpendicular to the extended runway centerline. Watch the CDI, which will begin showing that the aircraft is deviating from the intended route to the right. When the aircraft has deviated by almost three miles (the length of your right leg) the pilot will begin a turn to the left. The turn will be completed so that the aircraft will now be flying in the opposite direction at a distance of nine miles from the destination (the one-mile track spacing).

Now watch as the CDI begins to return to center while maintaining a constant nine-mile distance from the destination. Continue as the CDI begins to deviate to the left, and the next turn (to the right) will begin as you approach a three-mile deviation. Continue this pattern until you have completed your search.

Note: By using this technique you will actually be flying arcs instead of the usual squared (rectangular) legs. This is of little concern since the purpose is to cover the entire search area in a methodical manner.

This method is very handy when you are assigned a creeping line while airborne. It's easy to plan, set up and perform once you have mastered the technique.

You can also fly this pattern along a Victor airway. You can fly a similar pattern using the DME; it will be like flying a series of DME arcs.

This method can also be used along a winding river or a road, but the pilot must plan a line that roughly bisects the winding route and then vary the length of the legs as conditions warrant on the ground below.

GX-50/55

The creeping line is similar to the parallel line pattern, but the starting point is a selected waypoint rather than a grid. The pattern will straddle the center of your flight plan.

All the data you need set up this search pattern in the GX-50/55 is on the worksheet:

- Type of Grid and Sectional (US grid, STL)
- Type of pattern (Creeping Line)
- Starting Waypoint (the airport, BMG)
- Spacing (1 nm)
- Direction of Travel (the runway heading, 060°)
- Leg Length (3 nm *)
- Start Side (Right)

* 9.9 nm is the longest leg length you can select on the GX-50/55

8.5 Expanding Square search (a point-based search)

The planner normally uses the expanding square search pattern when the search area is small (normally, areas less than 20 miles square), and the position of the survivors is known within close limits. This pattern begins at an initially reported position and expands outward in concentric squares. If error is expected in locating the reported position, or if the target were moving, the square pattern may be modified to an expanding rectangle with the longer legs running in the direction of the target's reported, or probable, movement.

If the results of the first square search of an area are negative, the search unit can use the same pattern to cover the area more thoroughly. The second search of the area should begin at the same point as the first search; however, the first leg of the second search is flown diagonally to the first leg of the first search. Consequently, the entire second search diagonally overlays the first one. The bold, unbroken line in Figure 8-5 illustrates the first search, while the dashed line represents the second search. Track spacing indicated in Figure 8-5 is "cumulative," showing the total width of the search pattern at a given point on that leg. Actual distance on a given leg from the preceding leg on the same side of the pattern is still only one "S," the value determined by the incident commander or planner.

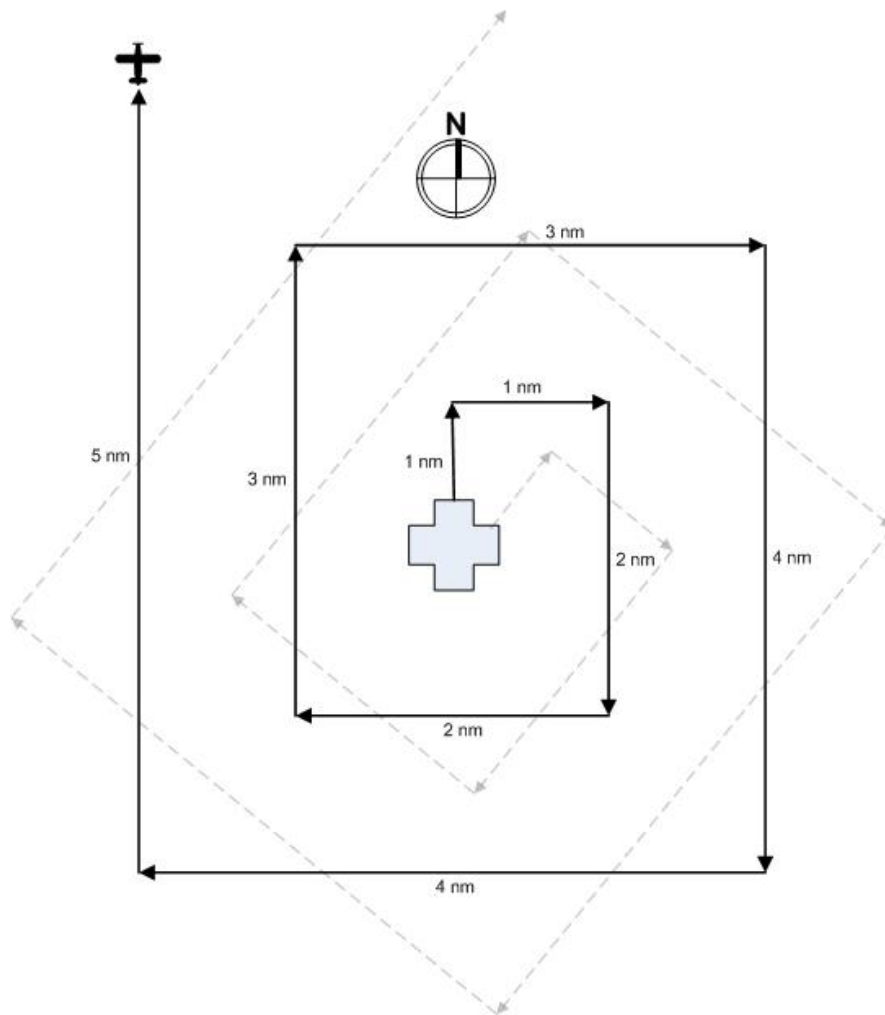

Figure 8-5

The GPS is used because this pattern requires precise navigation and is affected by wind drift. Even using the GPS, it is helpful to orient the expanding square pattern along the cardinal headings to reduce confusion during turns. [Or, you can enter the pattern as a flight plan and it will direct your turns.]

Note: This pattern is included in the GX-50/55 and G1000® SAR packages.

Expanding Square Coordinates

SECTIONAL: STL (N)S GRID# 132 A B C D

ENTRY POINT: N 38°59' W 86°10'

EXIT POINT: N 39°02' W 86°07'

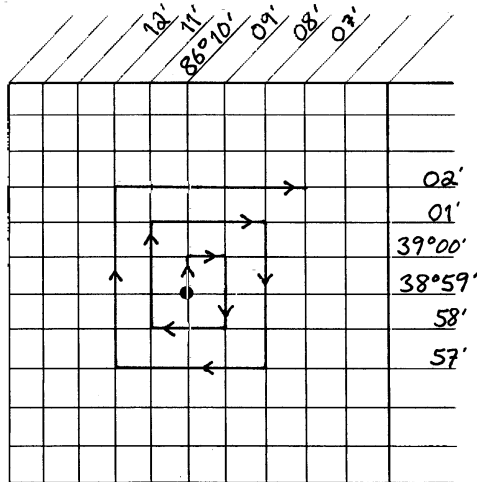

	NAVIGATIONAL AIDS		
IDENTIFIER	FREQUENCY	RADIAL	
1. <u>OOM</u>	<u>110.2</u>	<u>123°</u>	
2. <u>ABB</u>	<u>112.4</u>	<u>313°</u>	

Figure 8-5a

Fill the worksheet (Figure 8-5a) with the Lat/Longs that describe the expanding square. Starting at the entry point (a 483' AGL tower approximately eight nm west of Seymour), draw the square by going one mile north, then one mile east, then two miles south, and so on. You set it up this way because it is best to fly the square by first flying due north and then making all subsequent turns to the right; right turns are used because they allow the observer and scanner(s) to see the ground during the turns. You use cardinal headings because they are easiest for the pilot to fly. Length and width of the pattern may be modified to suit the requirements and conditions of the individual search.

Enter the Lat/Long of the starting point (N 38° 59' W 86° 10') into the GPS and save it as a waypoint. Select the waypoint and fly to it, maneuvering to approach from the south at about three to five miles out. Set altitude and airspeed so the aircraft is stable and the pilot will be ready to concentrate on flying the pattern precisely. Fly the pattern using the heading indicator and continuously displayed latitude and longitude on the GPS.

Note: If the aircraft doesn't have an operable GPS the first leg should be flown directly into or directly with the wind. Every other leg will thus be affected by the wind in a relatively consistent manner.

GX-50/55

The expanding square will radiate from a starting waypoint according to the spacing between lines and at an angle selected by you.

All the data you need set up this search pattern in the GX-50/55 is on the worksheet:

- Type of Grid and Sectional (US grid, STL)
- Type of pattern (Expanding Square)

- Starting Waypoint (483' AGL tower approximately eight nm west of Seymour, N 38° 59' W 86° 10')
- Spacing (1 nm)
- Direction of Travel (due north, 000°)

8.6 Sector search (a point-based search)

The sector search is another visual search pattern that can be used after the approximate location of the target is known. This pattern should be planned on the ground because it involves multiple headings and precise leg lengths. The pilot will fly over the suspected location and out far enough to make a turn, fly a leg that is equal to the maximum track spacing, then turn back to fly over the point again. This pattern continues until the point has been crossed from all the angles as shown in Figure 8-6.

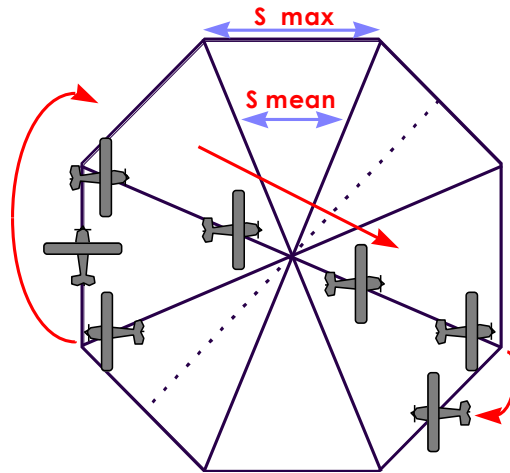
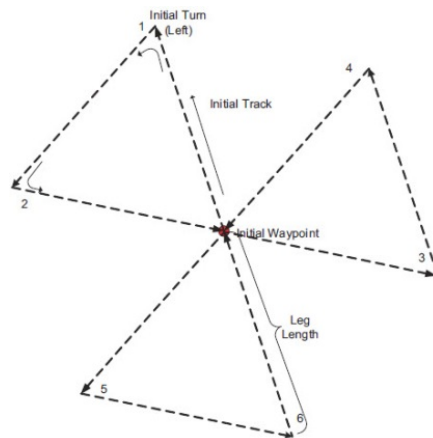

Figure 8-6

For aircraft equipped with the G1000®, the pattern consists of three equilateral triangles (i.e., all leg lengths are equal). The default initial track is 360°, initial turn is to the left, and leg length is five nm.



The sector search has two advantages:

- It provides concentrated coverage near the center of the search area
- It provides the opportunity to view the suspected area from many angles, so terrain and lighting problems can be minimized

8.7 Contour search

As previously discussed, flying in mountainous terrain requires special training (i.e., *Mountain Fury*). This search pattern (Figure 8-7) is presented for information only, but it may be effectively used for hills and other similar terrain that is not considered high altitude terrain.

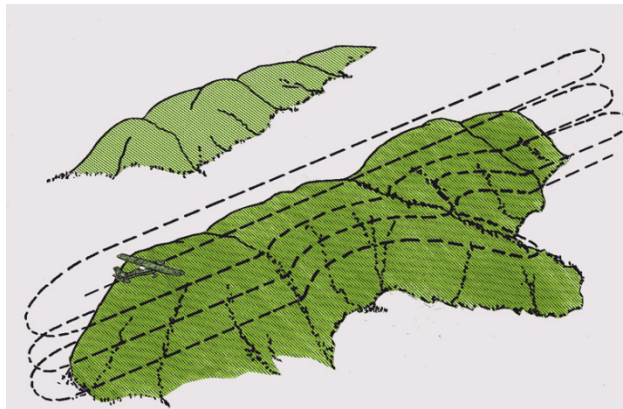

Figure 8-7

The contour search pattern is best adapted to searches over mountainous or hilly terrain. When using this pattern, the pilot initiates the search at the highest peak over the terrain. As in the case of mountains, the pilot flies the aircraft around the highest peak "tucked in" closely to the mountainside. As each contour circuit is completed the pilot lowers the search altitude, usually by 500 feet. While descending to a lower altitude, the pilot turns the aircraft 360° in the direction opposite to the search pattern.

As you may have already gathered, the contour search pattern can be dangerous. The following must be kept in mind before and during a contour search:

- First and foremost, the pilot and crew must be qualified for mountain flying *and proficient*
- The crew should be experienced in flying contour searches, well briefed on the mission procedures, and have accurate, large-scale maps indicating the contour lines of the terrain
- Weather conditions should be good with respect to visibility
- Wind gusts should be minimal to nonexistent
- The search aircraft should be maneuverable with a steep climbing rate and capable of making small turning circles
- The search should be started above the highest peak of the terrain

Valleys and canyons also pose problems during contour searches. The search crew should highlight or mark all valleys on their maps that pose possible hazards

to contour searching. If the crew believes the aircraft will not be able to turn around or climb out of a certain valley or canyon, mark the area on the chart and report the problem to the planner or debriefing officer. During the sortie, if any crew member senses that further flight may put the search airplane in a situation where it can neither turn around nor climb out of a valley or canyon, the aircraft must not proceed any further.

The search crew should also highlight or mark all valleys on their maps that pose possible hazards to a contour search. Crewmembers must stay alert for wires and power lines that may cross a canyon or valley significantly above its floor. The observer will later report the hazards to the mission debriefer, so that he or she may brief other crews of the hazards.

As an observer on a contour search mission you should keep an accurate record of the areas searched. Since some areas will be shrouded in fog or clouds, you will have to search those areas when weather conditions permit. One method of keeping records during contour searches is to shade searched areas on the map. The areas that you leave un-shaded are the areas that you have not searched.

8.8 Other SAR-related GPS Features

There is no substitute for thoroughly studying your GPS user's guide. However, we will highlight some features of the GPS (both the old type and the GX-55) that are important to our missions (GX-50/55 SAR operations are covered in Attachment 2).

User guides can often be found on the manufacturer's web site. Also, several CAP Wings have specially developed guides that are very useful.

8.8.1 Display Current Position

Select the AUX (Auxiliary) page.

GX-50/55

From the NAV (Navigation) screen, turn the large knob until "GPS Position" is displayed. [Note: PDOP (Position Dilution of Precision) is also displayed, and it is based on the geometry of the satellites used in the position solution. A lower number is a better value than a large one; that is, a PDOP of 3 indicates a more reliable position fix than a value of 7.]

8.8.2 Create a User Waypoint

In the WPT (Waypoint) mode turn to "Add User Waypoint" and press ENT. Enter an identifier and press ENT, then enter the latitude and longitude and press ENT.

GX-50/55

From the DB (Database) screen, turn the large knob until "Create User Waypoint by Lat/Long" is displayed and press ENTER. Use the large and small knobs to enter the desired latitude and longitude. [Note: the large knob moves the flashing cursor forwards or backwards; the small knob selects individual characters or numbers at the flashing cursor.] Press ENTER to accept and save the user waypoint (or you can press NAV to abort the procedure).

You can also create a user waypoint set to a US Grid coordinate, which allows you to fly directly to the corner of a grid or quadrant (or use it in a flight plan). From the DB screen, turn the large knob until "Create User Waypoint by US Grid" is displayed and press ENTER. Use the large and small knobs to enter the desired grid identifier. Press ENTER to accept and save the waypoint

8.8.3 Save Current Position as a User Waypoint

Press the HLD pushbutton captures present Lat/Long and stores it in the user waypoint memory under the name "HLDxx," where 'xx' is a number between 00 and 99. You can then rename the waypoint. [Note: Under some settings you must push the HLD pushbutton twice to store the waypoint.]

GX-50/55

From the DB (Database) screen, turn the large knob until "Create User Waypoint by Lat/Long" is displayed, then press ENTER. The position (Lat/Long) of the GPS at the moment you push ENTER is set as a user waypoint.

From the SAR Map page, pressing the "Mark" smart key saves present position and brings up the user waypoint screen; you can change the name and the Lat/Long using the large and small knobs. Pressing ENTER will save the waypoint. [The very first time this feature is used, the position is assigned a default number, "SAR000". Subsequent saves are automatically given sequential numbers (e.g., SAR001 and SAR002); they can be recalled, edited and deleted but not overwritten.]

8.8.4 Recall a User Waypoint

User waypoints can be recalled from the Navigation or Flight Plan modes. They can also be called up to compile a flight plan.

GX-50/55

From the DB (Database) screen, turn the large knob until the "Access Database" screen is displayed and press ENTER. Turn the small knob until USER is displayed, and then use the large and small knobs to enter characters of the user waypoint.

9. Mission Pilot

OBJECTIVES:

1. State mission pilot duties and responsibilities. {MP P-2001}
2. Discuss safety matters related to CAP activities. {MP P-2002}
3. Identify where to find the rules on transportation flights. {MP P-2003}
4. Discuss special precautions for flying CAP missions at night. {MP P-2003}
5. Discuss special precautions for flying CAP missions in IMC. {MP P-2003}
6. Discuss proficiency. {MP P-2003}
7. Discuss security and airspace restrictions. {MP P-2004}
8. Describe the three phases of an aircraft interception, your actions when intercepted, and discuss visual intercepting/intercepted signals.
9. Describe the types of items that should be kept in the aircraft glove box.
10. Discuss aircraft paperwork, documents and minimum equipment, W&B fuel assumptions and reserve, loading and pre-start. {MP O-2008 & O-2106}
11. Discuss startup checks, leaning the engine, and taxi. {MP O-2008 & O-2106}
12. State the crosswind limitation, and discuss takeoff, climb and departure. {MP O-2008 & O-2106}
13. Discuss transit to the search area, in the search area, and departing the search area. {MP O-2008 & O-2106}
14. Discuss approach, descent and landing. {MP O-2008 & O-2106}
15. Discuss after-landing, shutdown and post-flight. {MP O-2008 & O-2106}
16. Discuss those items you can control to improve POD.
17. State the normal, assumed number of aircrew needed for a mission.
18. Discuss how you must alter normal search patterns if you only have one scanner onboard.
19. Discuss special considerations for flying CAP search patterns.
20. Discuss "go/no go" decision-making.

9.1 Mission Pilot duties and responsibilities

The first and foremost duty of a mission pilot is to fly the aircraft in a safe and proficient manner, following all applicable FAA and CAP rules and regulations. All other duties are secondary to those of the aircraft commander.

The second most important duty of a mission pilot is to remember that he or she is the pilot -- not a scanner. You are the Pilot-in-Command (PIC) and you must never forget that.

The mission pilot is responsible for incorporating Operational Risk Management and Crew Resource Management principles and practices into each mission. The aircrew duty period and crew rest limitations of CAPR 70-1 must be followed.

In addition to the normal duties of PIC, CAP mission pilots must also perform all the duties of the Observer if no qualified observer is on board (refer to 1.1).

The mission pilot is responsible for getting proper briefings and for planning the sortie. A good mission pilot always includes the observer during these activities. Remember, you may be the aircraft commander but you are not always the mission commander; an experienced observer should serve as mission commander whenever possible.

In addition to PIC duties, the mission pilot must:

- Adhere to CAPR 70-1, 62-1 and 66-1 requirements and restrictions
- Thoroughly brief the crew before the flight
- Thoroughly brief the crew on their responsibilities during all phases of the flight
- Obtain a CAP flight release per CAPR 70-1
- Enforce sterile cockpit rules
- Fly search patterns as completely and precisely as possible. Report any deviations from the prescribed patterns during debriefing.
- Monitor the observer and ensure all events, sightings and reports are recorded and reported
- Fill out all forms accurately, completely and legibly

NOTE: *Other than on approved training missions, no additional flying maneuvers are to be conducted on Air Force assigned missions that are not required to accomplish the mission.* Additional flying maneuvers include, but are not limited to, pilot training/instruction on missions with a primary purpose other than training, flying proficiency enhancement, currency accomplishment, "time building" or maneuvers that are not required to complete the mission but increase overall flight time. There are two exceptions:

- (1) The PIC may credit one takeoff, instrument approach, landing and any other currency item accomplished coincidental with normal mission execution
- (2) Other crew positions may satisfy "on the job training" when the conduct of this training is coincidental to and does not detract from the mission

9.2 Safety

CAP flying involves several unique aspects and practices that may impact safety. Mission Aircrew members must maintain Safety Currency (tracked in eServices) at all times. If you do not show safety currency in eServices you will not be allowed to participate (sign into) in CAP missions.

9.2.1 Sterile Cockpit Rules

The “Sterile Cockpit” concept recognizes that flight operations other than routine cruise flight are intrinsically more hazardous and require the undivided and vigilant attention of all crewmembers. Non-essential conversations and activities not directly related to the operation of the aircraft and its mission are inappropriate.

The Pilot in Command (PIC) is responsible to ensure that these non-essential conversations, activities, and otherwise distracting actions do not occur during those portions of the flight that are considered critical. Examples of critical portions of flight would be taxi, takeoff, climb and departure, operating in the search area, and arrival, descent and landing. Operations in high-density traffic areas or heavy ATC periods would also be considered critical.

The simplest way to ensure that all crewmembers and passengers are aware of this requirement is to conduct a crew and passenger briefing prior to boarding the aircraft or prior to engine start. The Sterile Cockpit brief can be as simple as a general statement by the PIC indicating that an announcement will be made when the flight is in a critical phase of flight, or possibly, a detailed briefing of the various phases of flight that are considered busiest and critical for the crewmembers to avoid distractions.

It is essential that the PIC include in the Sterile Cockpit brief a statement that safety of flight items are always appropriate to be brought to the immediate attention of the PIC. Safety concerns would be such items as potentially conflicting traffic, or potential mechanical problems with the aircraft (i.e., electrical smoke or smoke of an unknown origin, and leaking fuel).

9.2.2 Flying Into and Taxiing on Unfamiliar Airports

CAP missions often require flying into small, non-towered and unlighted airports. The mission pilot needs to quickly obtain information about these airfields; the AOPA Airport Directory is an excellent source (<http://www.aopa.org/airports/>). Of particular importance:

- Runways. Determine length, width, markings and lighting. Is runway alignment compatible with predicted wind direction and strength? If not, what is your alternative?
- Taxiways. Are there any, or will you have to back taxi? Are the taxiways marked and/or lighted?

If you will be arriving in low visibility conditions or at night, taxi SLOWLY and use a wing walker if necessary. If you can't see the turnoff to the taxiway or the taxiway itself -- STOP.

- Obstacles. Note all near the airport and its approaches
- Services. Fuel and oil, phone, tie downs, and maintenance. Will they be open when you arrive? Is there a phone number to call after normal hours? If in doubt, call ahead -- most FBOs are glad to assist CAP.

- Local NOTAMS (<http://notams.aim.faa.gov/notamSearch/nsapp.html#/>)

CAP missions also require flying into large, busy airports. If available, consult the pertinent VFR Terminal Area Chart. Of particular importance:

- Airspace and obstacles. Review airspace layout, checkpoints and restrictions, and note all relevant frequencies
- Taxiways. Make sure you have a taxiway diagram, and review it before you land. Brief the crew so they can assist you. Don't hesitate to ask for progressive instructions.
- Local NOTAMS

CAP missions also require taxiing around and near a large number of aircraft:

- Follow the taxi plan that is in the Operations Plan, if applicable
- Follow all signals given by flight line personnel. However, use common sense as some of the flight line marshals may have little or no experience. If it looks too close -- STOP.

Pilot aids such as the *Airport/Facility Directory* or commercial products such as the *Flight Guide* (Airguide Publications, Inc.) are valuable tools for the CAP mission pilot. Also, several web sites (e.g., *AOPA*) have very detailed airport layouts available for downloading (including to your cellphone or tablet) and printing.

Another often-overlooked safety measure is reconnoitering the terrain around unfamiliar airports to determine your actions in the event the engine quits on takeoff. Get in the habit of flying a circuit around the airport upon arrival to look for emergency landing areas off the ends of each runway. Ask local pilots for the best actions to take if you lose an engine on takeoff (from each runway). Also, suggest that mission staff include this information in the general briefing, if necessary.

9.2.3 Squawks

CAP aircraft have Discrepancy Logs in WMIRS - use them! While private pilots may delay 'minor' repairs, mission pilots should not. Just as ELT missions always seem to occur between midnight and 0dark30, you can bet that a nighttime mission will come up if a landing, taxi, strobe or navigation light is out. Been having troubles with your com radios? Get ready for an ELT search in Class B airspace.

CAP pilots often fly unfamiliar aircraft during missions. Pay particular attention to each aircraft's squawks, and don't fly unless you are satisfied with the aircraft's condition: question the aircraft's regular crews about the particulars of their aircraft -- probe for "unwritten" squawks.

In a related matter, keeping the aircraft windows clean and having a well-stocked cleaning kit in the aircraft is vital. How many of you have arrived at the airport for a night flight and found that the last pilot had flown through a bug convention and neglected to clean the windscreen? And, as if this isn't enough of a delay in launching the mission, you can't find anything to clean the windscreen!

9.2.4 Fuel management

CAP missions often require flying long distances to mission bases, and the missions themselves involve flying several sorties a day. Mission aircrews often

carry a lot of luggage and equipment. Missions are flown in widely varying weather conditions. Therefore mission pilots must carefully plan, check and manage their fuel.

Per CAPR 70-1, the PIC is responsible to plan and fly such that a minimum of one hour of fuel (at normal cruise speed) remains *upon landing*. If it becomes evident the aircraft will not have that amount of fuel at its intended destination, the PIC will divert the aircraft to an airport that will ensure the requirement is met.

- Weight & Balance computations *must* be accurate. Do you include the weight of the permanent equipment stowed in the aircraft? Do you revise your W&B if you change crewmembers at the last minute? Do you have a scale available at your headquarters to weigh luggage and equipment?
- If you do not fill the aircraft fuel tanks to the top or a tab, do you have a means to accurately determine fuel on board? Each aircraft that is routinely filled to a level less than full should have a calibrated fuel-measuring device on board. Remember that these devices are specific to the particular aircraft model!
- Pilots often fly unfamiliar aircraft during a mission. Take the time to learn the fuel and oil consumption figures for the aircraft.

Each CAP aircraft should have information concerning the aircraft's fuel consumption rate for various power settings, taken from actual flight conditions. If the information is not in the aircraft, ask the aircraft's regular pilot for fuel burn rates. If neither of these options is available, be very conservative in your planning.

- Long cross-country flights, or a series of legs in a flight, or a series of mission sorties require careful planning. Make sure you note your assumptions (e.g., distance, power setting, and predicted wind direction and speed) so that you can compare them against actual conditions in flight.

Brief your crew, especially the observer, on these assumptions so they can assist you in managing the fuel. The pilot or observer should ask about fuel status at least once an hour, or before departing on each leg or sortie. Are the winds as predicted, or are you facing a stronger-than-expected headwind? Is your power set at economy cruise, as you planned, or have you gone to full power because you're running late? Did the last leg take as long as you had planned, or did ATC put you in the north forty for 30 minutes for "traffic separation"?

How do you describe a pilot who stretches his fuel to save the 20-30 minutes it takes to land and refuel, or a pilot who lands and refuels just because she wasn't comfortable with her fuel situation? The first is an incompetent pilot who's willing to risk himself, his passengers and the aircraft for some perceived "macho" image of a daring pilot. The second is a CAP Mission SAR/DR Pilot.

- **If in doubt, *land and refuel!* Just in case, *land and refuel!***

9.2.5 Unfamiliar Aircraft Equipment

CAP aircraft are not equipped uniformly. If you are assigned to another aircraft than the one you usually fly, check the equipment.

- If you don't know how to set up and operate the aircraft's GPS, you won't be able to use it correctly; if you try to learn "on the fly" you will spend too much time with your head inside the aircraft instead of looking outside. The same reasoning applies to the Audio Panel, FM radio, and DF unit.
- Even something as simple as an unfamiliar Navaid can affect safety. In most cases, just spending some time sitting in the aircraft and going over an unfamiliar com radio or transponder will suffice. But if you've never used an HSI before, this isn't the time to learn.
- What does the equipment and gear in the back seats and baggage areas weigh? You need to know this for an accurate weight and balance.
- *Whatever you do, don't try to bluff your way through.* Tell someone and ask for assistance. Another pilot can help you, or mission staff may assign another pilot or experienced observer to your crew who knows how to operate the equipment.

9.2.6 Unfamiliar terrain and weather

CAP missions often require you to fly to a different part of the state, or to a different state altogether. While you will be flying the same type of search patterns and using many of the same techniques, the terrain may differ considerably from your local terrain. Different terrain often is accompanied by different weather patterns and conditions.

Mission staff will brief you on local conditions, and may even give you training specific to their area. But you need to arrive as prepared as possible. In particular, you need to ensure you have the proper clothing, equipment, and survival gear for both the terrain you are crossing and the terrain in which you will be operating. What is required for one area can differ considerably from what you need in another climate.

9.2.7 Trainees and inexperienced crewmembers

CAP aircrew members may be trainees, or simply inexperienced. You must take the time to ascertain the qualifications and experience level of any crewmember assigned to you.

- If a crewmember is a trainee, spend extra time on briefings and be very specific as to duties and responsibilities. If the trainee is a scanner, listen in on the observer's briefing to make sure he does the same. Make sure trainees understand that, while you will teach them as much and as often as possible, you (and the observer) have duties that must not be interfered with.
- Check each trainee's SQTR. This will give you an idea of what you can expect from the trainee, and allow you determine if any of the remaining tasks can be signed off during the sortie.
- If a crewmember is newly qualified or has not flown in some time, make allowances. You may have to assume some of their normal duties (e.g., setting up and operating Nav aids or radios) in certain situations, so be sure to brief them so there is no confusion. For example, you may brief that you will handle all ATC communications while in Class C airspace while the inexperienced observer will handle all other communications.
- Cadets and some seniors often qualify as flight line marshalls as their first mission specialty, and there is no practical way to determine their

experience level. On some missions the flight line is handled by whoever is available, regardless of qualifications. Be alert and brief your aircrew to be alert. Don't hesitate to stop the aircraft if a marshaller's signals don't make sense or seem to be leading you into an unsafe situation.

9.2.8 Low and/or slow

CAP mission search patterns usually require you to fly at 1000' AGL and at speeds at or below 90 knots. Proficiency and planning are critical.

- Ensure that "low and slow" is an integral part of your proficiency program
- Strictly enforce sterile cockpit rules under these conditions, and make sure your crew is briefed on all obstacles in the search area
- Flying at low altitude often means losing radar and communications with ATC and mission base. Don't hesitate to climb back up to an altitude where you can make your "ops normal" reports.
- Maintain situational awareness and continually ask yourself, "If the engine quits now, where will I land?"
- Per CAPR 70-1, pilots shall not maintain sustained flight below an altitude or lateral distance from any object of 1,000 ft. during the day or 2,000 ft. at night except for takeoff and landing or in compliance with ATC procedures (such as IFR flight). At no time will the pilot allow the aircraft to come within 500 feet of terrain or obstructions unless taking off or landing. So, pilots may temporarily descend below the designated search altitude to verify potential crash sites or the presence of survivors, and to prevent loss of life, property, or human suffering, but never below 500' AGL; once the target has been identified the pilot will return to 1000' AGL or higher. [Refer to CAPR 70-1 for special restrictions for over-water missions.]
- Per CAPR 70-1, simulated emergency procedures are prohibited during Instrument Meteorological Conditions or at night. Exception: partial panel instrument training and in-flight discussion of emergency procedures may be conducted during night VMC conditions.

As PIC, the mission pilot must take current flight conditions into consideration (e.g., gross weight, turbulence, and terrain) and perhaps add a margin of safety to the assigned search altitude and airspeed. We don't need another aircraft to look for, so always put safety first. When you get back from your sortie you can debrief what you did and why, and the planner will factor that into the results and modify his or her plans accordingly.

9.3 Types of Flights

CAPR 70-1 covers the types of flights for CAP aircraft. We want to look at a few of these in a little more detail. Note that per CAPR 70-1, the minimum flight visibility for VFR flight is three statute miles (unless the PIC is a current and qualified Instrument Pilot). You must also update altimeter settings hourly from the closest source available.

The CAP pilot must be *thoroughly* familiar with the CAP FAR Exemptions. This is particularly important if the pilot holds a Private Pilot license. The table (FAA Exemptions and non-CAP Passenger Requirements; under "Special Operations"

on the Standardization/Evaluation/Flight Ops webpage) spells out who can be flown and whether or not the pilot may be reimbursed for the flight expenses; pay particular attention to the definitions of “aerial work operations” and “transportation,” and Note 1.

9.3.1 Transportation Flights

Always consult CAPR 70-1 (Passenger Requirements) when you need to know who is authorized to fly as passengers in CAP aircraft, and the conditions under which they (and you) are authorized to fly.

As a general rule, anyone other than CAP or CAP/USAF employees needs advance approval to fly in CAP aircraft. All non-CAP members eligible to fly aboard CAP aircraft must execute a CAPF 9, *Release (for non-CAP Members)*, prior to the flight.

9.3.2 Night Flights

Per CAPR 70-1, night VFR is permitted; however, if the PIC and aircraft are IFR qualified and current then the flight should be conducted under IFR, if practical.

Typical sorties flown at night are transport sorties, route searches, and ELT searches (it seems these are always flown at late at night). CAPR 70-1 requires pilots to maintain a minimum of 2000' AGL at night (unless under ATC control). As a minimum, the PIC should be night-current in the aircraft (category, class and type) you're going to fly and assure the required one-hour fuel reserve. When performing night searches it is preferable to have an experienced crew accompanying the pilot to assist in situational awareness and search procedures. Pay particular attention to organizing the cabin.

Night time route searches will only be successful if the downed aircraft or missing person has the capability to signal the aircraft or if an ELT has been activated. Usually, ground team searches near the last known point (LKP) or intended airport stand a better chance of success.

The most important item when planning night sorties is the PIC. Flying at night requires more attention to preflight planning and preparation. In particular, a careful check of the weather is essential; probably the most significant problem that can occur at night is flying into weather that you cannot see. Also, pay attention to the dew point spread as a predictor of fog. During the flight, maintain situational awareness and always know where you can land in an emergency.

Before you accept the mission, ask yourself a few questions:

- If all the night flying you have had in the last 90 days are your three takeoffs and landings, are you really proficient?
- How long has it been since you've done a night cross-country?
- How long has it been since you've done a night ELT search?
- If you are a CAP Instrument Pilot, how many approaches have you done at night lately?
- How familiar are you with the terrain and obstacles along the route?
- Since landing lights only fail at night, when was the last time you practiced landing without the landing light? Other nighttime emergencies?
- Have you included your watch and flashlights in the W&B?

Remember that confidence is gained by experience, so you should include night flying in your proficiency regimen. You should also include periodic DF training at night (see 9.2.5).

Nighttime or low-visibility Illusions

Many different illusions can be experienced in flight; some can lead to spatial disorientation while others can lead to landing errors. Illusions rank among the most common factors cited as contributing to fatal airplane accidents (e.g., JFK, Jr.). Various complex motions and forces and certain visual scenes encountered in flight can create illusions of motion and position. Even the best pilots will quickly become disoriented if they attempt to fly without instruments when there are no external visual references, because vision provides the predominant and coordinating sense that humans rely upon for stability. Spatial disorientation from these illusions can be prevented only by visual reference to reliable, fixed points on the ground or to flight instruments.

Fluid in the inner ear reacts only to rate-of-change, not a sustained change. For example, if a pilot banks into a left turn the inner ear will detect the roll into the turn, but if the turn is held constant for over 20 seconds the inner ear will compensate and (inaccurately) report to the brain that it has returned to level flight. When the pilot completes the turn and levels the wings, this new change will cause the inner ear to produce signals that give the perception of banking to the right. There are several types of sensory illusions involving the vestibular system:

- *The leans.* When a pilot enters a bank too slowly to stimulate the motion-sensing system of the middle ear and then applies a correction to the bank, this can create the illusion of banking in the opposite direction. The disoriented pilot will roll the airplane back to its original dangerous attitude or, if level flight is maintained, will feel compelled to lean in the perceived vertical plane until this illusion subsides.
- *Coriolis Illusion.* When you are in a prolonged constant-rate turn that has ceased stimulating the motion-sensing system and you make an abrupt head movement, this can create the illusion of rotation or movement on an entirely different axis. The disoriented pilot will maneuver the airplane into a dangerous attitude in an attempt to stop this illusion of rotation. This most overwhelming of all illusions may be prevented by not making sudden, extreme head movements, particularly while making prolonged constant-rate turns under IFR conditions (e.g., dropping you pen and quickly reaching down for it).
- *Graveyard spin.* A proper recovery from a spin that has ceased stimulating the motion-sensing system can create the illusion of spinning in the opposite direction. The disoriented pilot will return the airplane to its original spin.
- *Graveyard spiral.* An observed loss of altitude during a coordinated constant-rate turn that has ceased stimulating the motion-sensing system can create the illusion of being in a descent with the wings level. In this case, the disoriented pilot will pull back on the controls, tightening the spiral and increasing the normal load factor on the airplane.
- *Inversion Illusion.* An abrupt change from climb to straight-and-level flight can create the illusion of tumbling backwards. The disoriented pilot will push the airplane abruptly into a nose low attitude, possibly intensifying this illusion.

- *Head up illusion.* This involves a sudden forward linear acceleration during level flight where the pilot perceives the illusion that the nose of the aircraft is pitching up and responds by pushing the yoke forward to pitch the nose of the aircraft down. A night take-off from a well-lit airport into a totally dark sky (black hole) can lead to this illusion, and could result in a crash.
- *Head down illusion.* This involves a sudden linear deceleration (e.g., lowering flaps or decreasing engine power) during level flight where the pilot perceives that the nose of the aircraft is pitching down and responds by pitching the nose of the aircraft up. The pilot could stall the aircraft if this occurs during a low-speed final approach.

Visual Illusions can occur even under conditions of good visibility:

- *Elevator Illusion.* An abrupt upward vertical acceleration, usually caused by an updraft, can create the illusion of being in a climb. The disoriented pilot will push the airplane into a nose low attitude. [An abrupt downward vertical acceleration (downdraft) has the opposite effect.]
- *False Horizon.* Sloping cloud formations, an obscured horizon, a dark scene spread with ground lights and stars, and certain geometric patterns of ground light can create illusions of not being aligned correctly with the horizon. The disoriented pilot will place the airplane in a dangerous attitude.
- *Autokinesis.* In the dark, a static light will appear to move about when stared at for many seconds. The disoriented pilot will lose control of the airplane in attempting to align it with the light. [At night, a bright light with no other lights around it is particularly disorienting.]

Various surface features and atmospheric conditions encountered during landing can create illusions of incorrect height above and distance away from the runway threshold. Landing errors from these illusions can be prevented by: anticipating them during approaches; aerial visual inspection of unfamiliar airports before landing (e.g., use a 'standard' pattern entry); using an electronic glide slope or visual approach slope indicator (VASI) system when available; and maintaining optimum proficiency in landing procedures. The following illusions apply to this category:

- *Runway Width Illusion.* A narrower than usual runway can create the illusion that the airplane is at a higher altitude than it actually is. The pilot who does not recognize this illusion will tend to fly a lower approach, with the risk of striking objects along the approach path, or land short. [A wider than normal runway can have the opposite effect, with the risk of flaring high and landing hard or overshooting the runway.]
- *Runway and Terrain Slopes Illusion.* An up-sloping runway, up-sloping terrain, or both, can create the illusion that the airplane is at a higher altitude than it actually is. The pilot who does not recognize this illusion will fly a lower approach. A down-slope can cause the opposite effect.
- *Black hole approach illusion.* This can happen during a final approach at night (no stars or moonlight) over water or unlit terrain to a lighted runway beyond which the horizon is not visible. If the pilot has no peripheral visual cues to be oriented relative to the earth, there may be the illusion of being upright and the runway itself to be tilted and sloping. A particularly hazardous black-hole illusion involves approaching a runway under conditions with no lights before the runway and with city lights or rising

terrain beyond the runway; these conditions may produce the visual illusion of being too high on final approach, resulting in pitching the aircraft nose down to decrease the perceived approach angle.

- *Atmospheric Illusion.* Rain on the windshield can create an illusion of greater height, and a greater distance from the runway. The pilot who does not recognize this illusion will tend to fly a lower approach. Penetration of fog can create the illusion of pitching up. The pilot who does not recognize this illusion will steepen the approach, often quite abruptly.
- *Ground Lighting Illusions.* Lights along a straight path, such as a road, and even lights on trains can be mistaken for runway and approach lights. Bright runway and approach lighting systems, especially where few lights illuminate the surrounding terrain, may create the illusion of less distance to the runway. The pilot who does not recognize this illusion will tend to fly a higher approach. Conversely, the pilot flying over terrain which has few lights to provide height cues may make a lower than normal approach.

You can prevent or mitigate many of these illusions by:

- Pre-planning
- Flying a standard approach to landing

9.3.3 IFR Flights

CAP sorties are very seldom flown in IMC. The most common reason for an IFR flight is to transport personnel to a search area or mission base.

However, it is possible to conduct a route search in IMC. If an aircraft was lost while on an IFR flight plan, a sortie may be launched along the same route with the hope of picking up an ELT signal. This approach may also be taken, with careful planning and close coordination with ATC, for aircraft lost outside prescribed IFR routes.

It is also possible to DF in IMC, but this can be dangerous and is not to be undertaken lightly. It is recommended that night flights be conducted by current and qualified instrument pilots, if practical. In any case, a few extra precautions are in order:

- The pilot must be a current CAP Instrument Pilot
- The PIC must meet FAA instrument flight proficiency requirements
- The PIC should be proficient in instrument flight in the CAP aircraft to be used
- For any flight other than a simple IFR transportation flight, it is highly recommended that another current and proficient Instrument-rated pilot be in the right seat. *Never* fly a search alone in IMC.
- Never fly an instrument search when ground teams are appropriate and available for the search

9.3.4 Aerial Photography

CAP places emphasis on aerial reconnaissance and photography missions for national agencies. Emergency response planners expect more timely information about developing situations, and they recognize that aerial video images or video

are an invaluable tool. Therefore the Mission Pilot must learn how to fly these missions.

The key to a successful imaging mission is preparation, planning, patience and practice! Mission Pilots need to practice flying imaging patterns with an Airborne Photographer in order to master the patterns and the communications necessary to get the best images.

Complete details of Aerial Photography missions are covered in the MART Volume III, *Airborne Photographer*. As a minimum, study and practice MP-related knowledge and skills covered in Chapters 6 & 7.

9.3.5 Proficiency Flights

CAPR 70-1 encourages pilots to maintain currency and proficiency by accomplishing self-conducted proficiency flights at least once every 90 days (Self Conducted Pilot Proficiency Flight Guidelines). Additionally, mission pilot training flights are authorized under the Air Force Approved Proficiency Flight Profiles (using mission symbol A12 or B12). Both are located on the *Aircraft Ops and Stan/Eval* webpage (http://www.capmembers.com/emergency_services/aircraft_ops_staneval/).

As the demands on the CAP mission pilot increase, the need to maintain and improve your mission skills becomes more important. Besides the guidance given in the MP Proficiency Profiles series, you should also practice:

- Search patterns using the GPS as your primary tool, but also practice planning and flying the different patterns using VORs and pilotage
- Night proficiency. Practice search patterns at night (particularly the ELT search).

As part of your cross-country proficiency, practice with the GPS:

- Maintain a constant track over ground
- Select/display a destination: Airport, VOR and User Waypoint
- Determine heading, time and distance to a waypoint
- Save Lat/Long coordinates as a User Waypoint
- Save your present position as a user waypoint
- Enter and use flight plans
- Exercise the nearest airport and nearest VOR features
- Practice navigating with present position displayed (constant Lat/Long display)

Proficiency flights are designed to prepare crews to fly Air Force missions and should include a mission observer and scanner as appropriate, and though routine flight procedures can be practiced, the majority of a proficiency flight must be focused on the training outlined in the profiles. *Always try to take a scanner, observer or photographer along with you on your proficiency flights.* This will provide aircrew task training, improve CRM and teamwork, and make the flight more enjoyable. [Remember, if you are going to be practicing instrument approaches you must use a CFII or Safety Pilot. It is also preferred to have one during your night practice, although a qualified non-pilot observer will serve just as well.]

9.4 Security Concerns and Airspace Restrictions

The September 11th terrorist attack brought about heightened security concerns and the potential for airspace restrictions.

9.4.1 Security

CAP resources should be considered National Security assets. In times of emergency you should take special security precautions to protect the aircraft and crew. Some examples are:

- Hangar the aircraft whenever possible. You may place small pieces of clear tape on fuel caps, the cowling and/or doors that will break if someone tampers with vital areas.
- Pay particular attention during preflight inspections. Look for signs of tampering and carefully inspect the fuel for contamination.
- Be as "low key" as possible, and be discrete. Don't discuss CAP business in public places.
- Be aware of your surroundings at all times. If you see something or someone that is suspicious, don't ignore it. Report your suspicions to your supervisor and/or law enforcement.
- All CAP members must complete the *Operations Security Awareness Training* as part of Level I training and sign the *Non-Disclosure Agreement*

9.4.2 Airspace Restrictions

The FAA may issue Temporary Flight Restrictions (TFRs) at any time, so it is vitally important to ask for FDC NOTAMs before each flight (and before each leg of a flight) and to monitor ATC for changes while in flight. A TFR is an area of airspace (defined both laterally and vertically) which has been temporarily or partially closed to non-participatory aircraft for a specified period of time (e.g., to protect airspace around the President when traveling, around nuclear facilities, or around large gatherings of people). [Note: NOTAMS can be checked at <http://notams.aim.faa.gov/notamSearch/nsapp.html#/> and FAA TFRs can be found at <http://tfr.faa.gov/tfr2/about.jsp>]

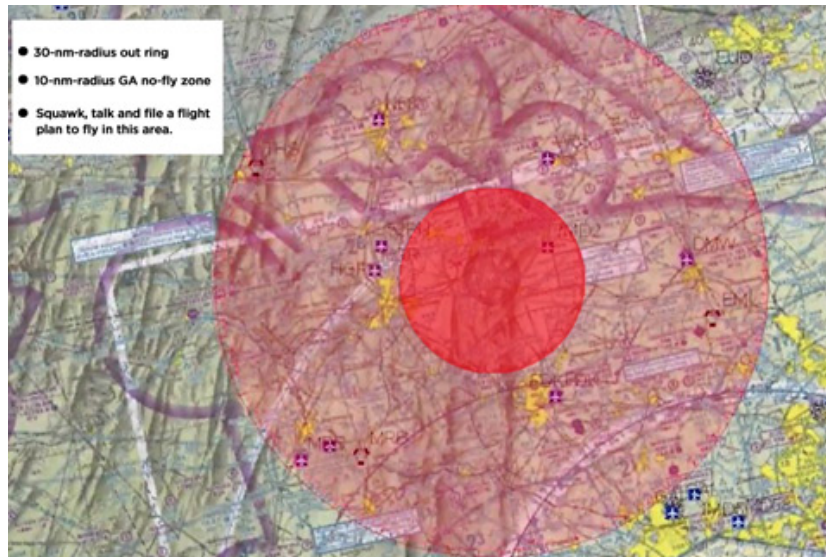

NOTAMS for every TFR list flight operations that are prohibited (e.g., flight training and glider operations); when transient flights will be accepted; and the procedures to fly VFR or IFR to or from an airport within the outer ring (between the 10- and 30-nm boundaries, above).

In order to fly from Point A to Point B, with one or both being in the TFR, you need to:

- Be on an active VFR or IFR flight plan
- Maintain two-way communication with air traffic control, and
- Squawk a discrete transponder code

. You should flight plan to exit the TFR using the most expeditious route, while avoiding the 10-nm GA no-fly zone.

If you are departing from within a TFR boundary, be sure to get a discrete transponder code and a frequency to contact after takeoff. It is imperative that you are squawking your discrete code before you lift off.

If you are landing within the TFR boundary, be sure to remind ATC that your final destination is inside the TFR so they will grant or continue flight following services (which otherwise would only be provided on a workload-permitting basis).

Note: In the event of a radio failure while inside the TFR, alternate squawking 7600 and 7700: this lets everyone monitoring the flight know that you have a problem and satisfies the requirement for maintaining two-way communication with ATC.

Even with TFRs lifted, you should not loiter around or circle critical facilities (e.g., nuclear power plants, large stadiums or gatherings, air shows, and dams or reservoirs). If you have to circle critical facilities (e.g., for planning or actual mission purposes) make sure you coordinate with the facility's manager and ATC.

Another development is the establishment of an Air Defense Identification Zone (ADIZ) over Washington, D.C. and vicinity during times of heightened alert. This tactic may spread, so review Section 6 of the AIM before flying into or near an ADIZ.

9.4.3 In-flight Intercept

If your aircraft accidentally approaches or encroaches restricted airspace military aircraft may intercept you; it is important to know how to respond. The following covers the important points; details can be found in AIM 5-6-2.

An intercept to identify your aircraft has three phases:

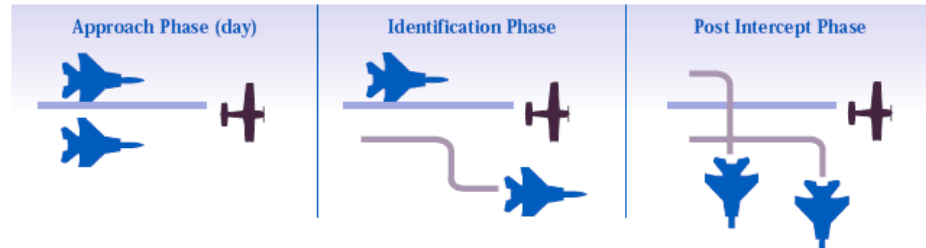

Note: The interceptor may fly in front of you and disperse flares if you don't respond

Note: During night/IMC the intercept will be from below the flight path

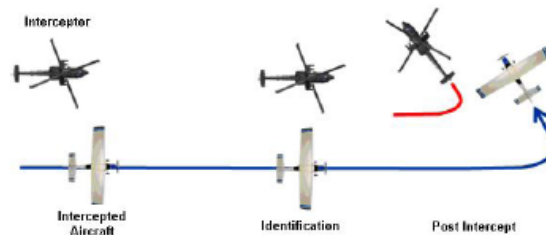

Note: Intercepted aircraft must not follow directly behind the helicopter, thereby allowing the helicopter pilot to maintain visual contact with the intercepted aircraft and thus ensuring safe separation is maintained.

- Approach phase. A flight leader and wingman will coordinate their individual positions in conjunction with the ground-controlling agency.
- Identification phase. The intercepted aircraft should expect to visually acquire the lead interceptor and possibly the wingman during this phase. The wingman will assume a surveillance position while the flight leader approaches your aircraft. The flight leader will then initiate a gentle closure toward your aircraft, stopping at a distance no closer than absolutely necessary to obtain the information needed. The interceptor aircraft will use every possible precaution to avoid startling you.
- Post-intercept phase. After you have been identified, the flight leader will turn away. The wingman will remain well clear and rejoin the leader.

If you are intercepted you should immediately:

- Follow the instructions given by the intercepting aircraft, interpreting and responding to the visual signals (see Table 9-1)
- Notify ATC, if possible
- Attempt to communicate with the intercepting aircraft and/or ATC on the emergency frequency 121.5 MHz, giving the identity and position of your aircraft and the nature of the flight

- If equipped with a transponder, squawk 7700 unless otherwise instructed by ATC. If any instructions received by radio from any sources conflict with those given by the intercepting aircraft by visual or radio signals, request clarification while continuing to comply with the instructions given by the intercepting aircraft.

Table 9-1

Law Enforcement Aircraft	Meaning	Intercepted Aircraft	Meaning
Rocks wings. After acknowledgement initiates a slow level turn, normally to the left, onto the desired heading.	You have been intercepted. Follow me.	Rocks wings and follows. [Also, at night flash navigational lights.]	I understand and will comply.
Performs an abrupt breakaway maneuver consisting of a climbing 90° turn, or more, without crossing the intercepted aircraft's flight path.	You may proceed.	Rocks wings.	I understand and will comply.
Circles airport, lowers landing gear, and overflies runway in the direction of landing.	Land at this airport.	Lowers landing gear, follows the LE aircraft and lands if the runway is considered safe. [Also, at night turn the landing lights on.]	I understand and will comply.
Intercepted Aircraft	Meaning	LE Aircraft	Meaning
Raises landing gear while flying over runway between 1000' and 2000', and continues to circle the airport.	This airport is inadequate.	If the intercepted aircraft is requested to go to an alternate airport, the LE aircraft raises its landing gear and uses the intercept procedures.	Understood. Follow me.
The pilot switches on and off all available lights at <i>regular</i> intervals.	Cannot comply.	Performs the breakaway maneuver.	Understood.
The pilot switches on and off all available lights at <i>irregular</i> intervals.	In distress.	Performs the breakaway maneuver.	Understood.

Detailed intercept procedures can be found at https://www.faa.gov/files/notices/2010/Oct/Intercept_Procedures.pdf.

9.5 Phases of Flight

We will now look at the various phases of flight from a mission pilot's point of view.

A day or so prior to your flight, either you or the mission staff should have loaded your mission sortie(s) into WMIRS so that you can enter most of the air sortie planning and briefing data. **Note:** The air sortie data entries in WMIRS contains the information found on the CAPF 104 (*Mission Flight Plan/Briefing Form*). The data entered in the Air Sortie Information, Briefing and Debriefing sections of WMIRS automatically fills out a CAPF 104 that can be retrieved from WMIRS. You should also complete the ORM worksheet (in WMRIS) and upload your W&B worksheet into WMIRS. *These forms are discussed in detail in Chapter 10.*

NOTE: Per CAPR 70-1, a sortie starts when the aircraft begins to move forward on the takeoff roll and ends with the first engine shut-down after landing. Therefore, a fuel or comfort stop ends the sortie and a new sortie is required to continue the mission. For longer missions, this will require you to enter additional sorties in WMIRS as part of your pre-flight planning. Sorties in WMIRS can be cancelled if not used, and there are also tools available to copy sorties or entire missions so that redundant data entry can be avoided.

Once you enter your planning data, WMIRS will display the aircraft discrepancies for your review. Make sure the discrepancies don't make the aircraft unsafe for flight or reduce mission readiness.

You will need to update your weather information for the sortie immediately before the flight, and you might have to modify the ORM as a result. Additionally, you need to ensure the wind limitations in Section 2-1 of CAPR 70-1 are met:

- Do not takeoff, land, or taxi if the wind velocity exceeds 30 knots. This speed restriction is reduced to 25 knots when operating on a wet runway and 15 knots when operating on ice or snow packed surfaces.
- Do not takeoff or land if the crosswind component exceeds the aircraft manufacturer's maximum demonstrated crosswind velocity or 20 knots, whichever is less. Include maximum reported gust when determining wind velocity.

Now let's look at one of the most overlooked assets you have in the aircraft -- the glove box. This area is ideal for items such as small, laminated sheets for the crew and passenger briefing, crosswind chart, public relations cards (like those from the CD program), FM radio frequencies and call signs, ELT deactivation stickers, and a GPS cheat-sheet. Other items could include a small cleaning rag (like for glasses) to clean the GPS display and a backup flashlight. Check the glove box periodically and purge unnecessary stuff.

Besides the items in the glove box, the aircraft should contain aids for infrequent or important evolutions such as emergency signals, air-to-ground signals, and intercept procedures.

Note: An abbreviated mission checklist is provided in Attachment 2, *Flight Guide*. Other checklists are available, such as the *In-Flight Guide and Aircrew Aid*.

9.5.1 Preflight

Aircraft paperwork

Knowledge of aircraft paperwork directly pertains to airworthiness and safety.

It is important for the mission pilot to understand how to find data in aircraft logbooks. Familiarize yourself with your aircraft's engine, propeller, airframe, and avionics logbooks so that you can identify items such as the time of the last mid-cycle oil change (40-60 hours, not to exceed six months), last 100-hour inspection and/or Annual, and instrument requirements (i.e., ELT battery, pitot-static system, transponder and altimeter current).

Also, check other items such as the expiration dates on the carbon monoxide detector and fire extinguisher, and the date of the last VOR check (the VOR check is not required for VFR flight but it must be successfully completed within 30 days of any IFR flight).

Fill in all required information on the CAP aircraft Flight Log. Ensure proper entries for mission symbol, mission number, and crew names/CAP IDs. [Ensure all crewmembers are "safety current" in eServices.](#)

Verify any outstanding discrepancies during your aircraft preflight. If new discrepancies are discovered, log them and ensure the aircraft is still airworthy and mission ready.

[Note: If you are flying an unfamiliar aircraft take extra time during the preflight to look for any abnormalities or signs of damage. For example, don't just look at the antennas -- touch them to make sure they're secure. Note all significant scratches and dents. Look for tire wear or bald spots. You get the picture.]

Documents and Minimum Equipment

The following are taken from CAP regulations and FAR 91 Subpart C.

Certificates and Documents

- Airworthiness certificate
- Registration certificate
- Operating limitations (placards and instrument markings)
- Check all passengers' credentials before you obtain the flight release.

Minimum operable equipment, VFR Day:

- Airspeed indicator
- Altimeter
- Magnetic direction indicator
- Tachometer
- Oil pressure gauge
- Oil temperature gauge
- Manifold pressure gauge
- Fuel gauge for each fuel tank
- Landing gear position indicator
- Aviation red or white anti-collision light system (aircraft certificated after March 11, 1996)
- Safety belt for each occupant
- Shoulder harness for each front seat (aircraft certificated after July 18, 1978)
- Shoulder harness for each seat (aircraft certificated after December 12, 1986)
- ELT

Minimum operable equipment, VFR Night:

- All required for VFR Day

- Position lights (i.e., red, green and white steady-burning lights)
- Aviation red or white anti-collision light system (e.g., flashing or rotating lights)
- An adequate source of electrical energy for all installed electrical and radio equipment
- One spare set of fuses, or three separate fuses of each kind required, that are accessible to the pilot in flight

Minimum operable equipment, IFR:

- All required for VFR Day and/or Night, as applicable
- 2-way radio com system and navigational equipment appropriate to the ground facilities to be used
- Sensitive altimeter adjustable for barometric pressure
- Clock displaying hours, minutes and seconds with a sweep-second pointer or digital presentation
- Generator or alternator of adequate capacity
- Slip-skid indicator
- Gyroscopic rate-of-turn indicator
- Gyroscopic pitch and bank indicator (artificial horizon)
- Gyroscopic direction indicator (directional gyro or equivalent)

In order to determine whether you can take off with inoperative instruments or equipment, refer to FAR 91.213.

Other documents and equipment required by CAP (from CAPR 66-1 and CAPF 71):

- Review of the logbooks (mid-cycle oil change, 100 hour/Annual, 24-month transponder inspection, 24-month pitot-static system inspection, 24-month altimeter calibration, ELT inspection and battery replacement date, 30-day VOR check, AD compliance list) [This information is also in the Aircraft Information File.]
- Restrictive placards: "This aircraft is the property of the Civil Air Patrol and will not be used for hire or reward," "Maximum Crosswind Component for this aircraft is (POH or 20 knots)," "Seat Slip Warning -- Ensure aircraft seats are positively locked before takeoff and landing," and "Remove Towbar before Engine Start."
- Pulselite
- Avionics/Control lock
- Weight & Balance data
- Fire extinguisher (Halon 1211/1301 recommended)
- Carbon monoxide detector (12-month disposable)
- Cargo tie-down or cargo net (preferred)
- Chocks and tie-downs (both wings and tail)
- Survival kit (contents determined by each Wing)

Loading the Aircraft

During loading, ensure that crew members, supplies and equipment correspond to what you used in your Weight & Balance. If not, revise the W&B. [Note: Once you get your final weather briefing, you may need to revise your ORM.]

Ensure your aeronautical charts and databases are current and cover all assigned areas. Also ensure you have all necessary maps and gridded charts to carry out the mission, and that the crew has markers for their charts/maps and a clipboard to write on.

Ensure that the windshield and windows are clean, and that the chocks, tie-downs, and Pitot tube covers/engine plugs are stowed. If this will be a video imaging mission and you will be shooting from the right window, remove the window holding screw and stow it in a safe location.

Check and test special equipment such as an airborne repeater, a camera/camcorder, computer and portable GPS (including the spare batteries).

Make sure the parking area is clear of obstacles; arrange for a wing-walker if one will be needed to clear obstacles.

Before Engine Start

In all cases, follow the Aircraft Checklists: the observer should read each item to you, and then you will perform the item and repeat back performance of the item (challenge-response method).

Perform the passenger briefing and review the emergency egress procedure.

Brief the crew on your fuel management plan and assumptions, and assign responsibility for inquiring about fuel status once an hour.

Brief the crew on the taxi plan and taxiway diagram, and assign crew responsibilities for taxi. Go over the crew assignments for takeoff and departure and make sure each crewmember knows in which direction they should be looking during each. The PIC should inform the crew that an announcement will be made when the flight is in a critical phase of flight, or give a detailed briefing of the various phases of flight that are considered busiest and critical for the crewmembers to avoid distractions. The PIC should also tell the crew that safety of flight items are always appropriate to be brought to the immediate attention of the PIC. Safety concerns would be such items as potentially conflicting traffic and potential mechanical problems with the aircraft (i.e., electrical smoke or smoke of an unknown origin, or leaking fuel).

Enter settings into GPS (e.g., destination or flight plan, entry and waypoints). Turning off all radios and navigation equipment separately before turning on the Avionics Master switch reduces the load on the battery sufficiently for you to program your settings into the GPS.

Once everyone is settled in, organize the cockpit and review the "Engine Fire on Start" procedure and discuss your actions for loss of engine power on takeoff.

9.5.2 Engine Startup and Taxi

Always use the checklists in CAP aircraft. Whenever possible, have the right-seat crewmember read the checklist items to you while you either perform or repeat back accomplishment of each item (i.e., the challenge-response method).

Make sure you or the right-seat crewmember keeps the checklist close at hand so that it can quickly be opened to confirm and complete emergency items. Brief the right-seat crewmember on how to use the emergency checklists (e.g., read the bold face items first and then continues with the rest of the items when directed).

All crewmembers shall wear seat belts and shoulder harnesses during takeoff and landing; all occupants shall wear safety restraints during all other phases of flight unless such wear interferes with crew member duties (e.g., when taking photos). The pilot operating the aircraft will wear lap belt and shoulder harness at all times.

Place the Rotating Beacon Switch in the 'ON' position and signal the marshaller before starting the engine.

Startup

Be sure and include the DF unit's Alarm light self-test in your scan during startup. The light should blink for several seconds; if it doesn't your unit may be inoperative. Also ensure that the CAP FM radio is set up properly (both on the radio and the audio panel).

For the typical Cessna, lean the engine immediately after starting when density altitude is >3000' DA.

Ensure that the DF and FM Radio are properly set. If this is the first flight of the day, perform an FM radio check with mission base. Select your initial VOR radial(s) and GPS settings (destination or flight plan, entry point or waypoint).

Obtain ATIS and Clearance (read back all clearances and hold-short instructions). Then verify you are within the Crosswind Limitation. For VFR you must have three statute miles visibility (unless you are current IFR; if this is an IFR flight, verify weather is at or above landing minimums and check that a VOR check was performed within the last 30 days).

Signal the marshaller before you begin to taxi (turn on Pulselite or flash taxi/landing light). Remember to check your brakes as you begin your roll.

Taxi

Collision avoidance! An increasing number of taxi mishaps are the number one trend in CAP. Investigations reveal that pilots are: straying from designated taxi routes, not allowing adequate clearance, not considering the tail and wings during turns, taxiing too fast for conditions, taxiing with obscured visibility, distracted by cockpit duties, and not using other crewmembers to ensure clearance. Use the aircraft's exterior lights to make you more conspicuous! Prior to taxiing, turn on the navigation, position, Pulselite, and anti-collision lights (always consider any adverse effects to safety that illuminating forward facing lights and strobe lights will have on the vision of other pilots or ground personnel, especially at night).

Once you begin taxiing *the sterile cockpit rules begin; all unnecessary talk is suspended and collision avoidance becomes the priority of each crewmember.* Sterile cockpit rules focus each crewmember on the duties at hand, namely concentrating on looking outside the aircraft for obstacles and other aircraft. The rules will *always* be used during the taxi, takeoff, departure, approach, pattern, and landing phases of flight; but the pilot or observer may declare these rules in effect whenever they are needed to minimize distractions.

Follow the marshaller's directions, but remember they may be trainees (make sure their directions make sense and conform to the taxi plan).

Follow CAPR 70-1 requirements for taxi operations (taxi no faster than a slow walk when within 10 feet of obstacles; and maintain at least 75' behind light single-engine aircraft, 200' behind light multi-engine or light jet aircraft, and 500' behind helicopters or heavy multi-engine or heavy jet aircraft). Remember to read back all clearances and hold-short instructions.

Remind the crew that midair collisions are most likely to occur in daylight VFR conditions within five miles of an airport at or below 3,000' AGL! This means that

most midair collisions occur in the traffic pattern. Since the pilot has only one set of eyes, this (and aircraft design) leaves several 'blind spots' that the observer and scanner must cover -- particularly between your 4 and 8 o'clock positions.

When taxiing with a quartering headwind, the wing on the upwind side will tend to be lifted unless the upwind wing's aileron control is held in the UP position. The corresponding downward deflection of the downwind aileron produces a small amount of lift that further reduces the tendency of the upwind wing to rise. The elevator should be NEUTRAL.

When taxiing with a quartering tailwind, the wind tends to lift the wing affected by the wind and the tail. The elevator should be held in the DOWN position and the wing affected by the wind held in the DOWN direction (e.g., "dive" away from the wind). These positions reduce the tendency of the wind to get under the tail and the wing and to nose the airplane over.

During high density altitude conditions (e.g., >3000' DA) lean the engine for maximum power before takeoff.

9.5.3 Takeoff, Climb and Departure

Takeoff

Ensure you are within the crosswind limit of the aircraft's POH (or the CAP limit of 15 knots if one is not specified in the POH); include the maximum reported gust when determining wind velocity.

CROSSWIND CHART

WIND SPEED (Kts)	DEGREES OFF RUNWAY HEADING									
	10	20	30	40	50	60	70	80	90	
8	1	3	4	5	6	7	8	8	8	
9	2	3	4	6	7	8	8	9	9	
10	2	3	5	6	8	9	9	10	10	
11	2	4	5	7	8	10	10	11	11	
12	2	4	6	8	9	10	11	12	12	
13	2	4	6	8	10	11	12	13	13	
14	2	5	7	9	11	12	13	14	14	
15	3	5	7	10	11	13	14	15	15	
16	3	5	8	10	12	14	15			
17	3	6	8	11	13	15				
18	3	6	9	12	14					
19	3	6	9	12	15					
20	3	7	10	13	15					
21	4	7	10	13						
22	4	8	11	14						
23	4	8	11	15						
24	4	8	12	15						
25	4	9	12							
26	5	9	13							

Always look for landing traffic before taking the active runway! When you receive takeoff clearance (or begin takeoff roll), turn on your landing light.

Log (time and Hobbs) and report "Takeoff."

The FAA's "operation lights on" encourages pilots to keep aircraft lights on when operating within 10 miles of an airport, or wherever flocks of birds may be expected.

Climb

Make shallow S-turns and lift your wing before turns when climbing to increase your chances of spotting conflicting aircraft.

The most common engine leaning technique, especially for aircraft without an EGT gauge, is to lean until the engine just starts to run roughly, then richen until it is smooth again, then further richen 1 1/2 turns on the large knob. This is a good technique because it can be accomplished by hearing and feel, leaving the eyes free to look outside.

If an EGT gauge is available: Lean to peak EGT then richen 100 degrees rich-of-peak (see your engine operating manual).

But guess what? The common technique (hearing and feel) will give almost the same setting as the EGT gauge. Try it sometime and compare the results.

Remember, in all cases the objective is to burn gas, not valves. Gas is cheaper than engine overhauls. Please take good care of our engines -- they keep us in the air.

Keep your emergency checklist close at hand and open to the Emergency Procedures section.

Departure

Collision avoidance! Maintain sterile cockpit until well clear of traffic and obstacles. Keep your crew apprised of conflicting aircraft and obstacles. Using flight following gives you another pair of 'eyes' to watch for traffic (but remember that ATC traffic advisories during flight following are given on a 'time-permitting' basis, and they can't see aircraft that don't have operating transponders).

9.5.4 The Search Area

Transit

You can remove the sterile cockpit rules once clear of the approach/departure area (unless the airspace is still congested or multiple obstacles are present).

If no cruising altitude is assigned, avoid flying at 1,500', 2,000' and 2,500' AGL as these tend to be more crowded than other altitudes below 3,000' AGL. Also fly to the right or left of VORs, as the airspace over these can be busy (the same goes for approach fixes or holding points). When crossing military training routes, cross at a perpendicular angle to minimize the time you spend in the route. Also, if you spot one fighter aircraft look for the wingman -- they tend to travel in pairs.

Take this time to double-check the navigational settings that will be used in the search area, and review search area terrain and obstacles. Also review methods to reduce crew fatigue during the search or to combat high altitude effects.

Update in-flight weather and file PIREPs. You may also use this time to review in-flight emergency procedures with the crew.

Approaching the Search Area

Review search assignments and double-check radio, audio panel and navigational settings. Check navigational equipment against each other (detect abnormalities or failures).

Stabilize the aircraft at the assigned search heading, altitude and airspeed (usually 90 kts.) at least two miles before you enter the search area. *Sterile cockpit rules are now in effect.*

Turn sufficient aircraft exterior lights on to maximize your visibility, so others can "see and avoid".

In the Search Area

Log (time and Hobbs) and report "In the Search Area."

Note any deviations from the assigned search parameters (e.g., altitude, direction, or areas omitted).

Perform hourly updates of the altimeter (closest source) and fuel assumptions; report "Operations Normal" at assigned intervals.

Periodically check navigational equipment against each other to detect abnormalities or failures.

During actual or training SAR/DR operations, pilots may only descend below the designated search altitude (1000' AGL minimum) to verify potential crash sites or the presence of survivors, to prevent loss of life, property, or human suffering, provided such descent is accomplished IAW FAR 91.119. *At no time will the pilot allow the aircraft to come within 500 feet of terrain or obstructions, except for takeoff or landing.* Prior to descent below the designated search altitude, the PIC will evaluate terrain, winds, turbulence, and obstructions to determine the best flight path to conduct a controlled descent and low altitude reconnaissance. The low altitude reconnaissance will be conducted along a short, planned flight path based on the PIC's evaluation and should provide the observer or scanner the best view of the area of interest. The low altitude reconnaissance will not include sustained maneuvering below the designated search altitude. Once the area of interest has been evaluated, the objective verified, or upon reaching the end of the planned low altitude reconnaissance path, the aircraft will return to the minimum search altitude specified by the IC and will not descend again except to evaluate new potential sightings or areas of interest.

Monitor yourself and your crew for fatigue or the effects of high altitude.

Departing the Search Area

Log (time and Hobbs) and report "Out of the Search Area."

Double-check your heading and altitude with what was assigned for transit to the next search area or return to base. Relax sterile cockpit rules.

Organize the crew and cockpit in preparation for approach and landing.

9.5.5 Approach, Descent, and Landing

Approach

Now is the time to obtain ATIS (or AWOS) and contact approach control. Review the taxi plan and airport taxi diagram with the crew, and make crew assignments for approach, landing and taxi. Make sure each crewmember knows in which direction they should be looking during each. *Remind the crew that midair collisions are most likely to occur in daylight VFR conditions within five miles of an airport (especially non-towered airports) at or below 3,000' AGL!* This means that

most midair collisions occur in the traffic pattern, particularly on final approach. Since the pilot has only one set of eyes, this (and aircraft design) leaves several 'blind spots' that the observer and scanner must cover -- particularly between your 4 and 8 o'clock positions. *Sterile cockpit rules are now in effect.*

The FAA's "operation lights on" encourages pilots to keep aircraft lights on when operating within 10 miles of an airport. Use standard entry patterns when landing at non-towered airports, and broadcast your aircraft type and position frequently over Unicom/CTAF.

Read back all clearances and hold-short instructions.

Descent

Enhance collision avoidance by making shallow S-turns and lifting your wing before turns during descent to check for traffic.

Probably the most common error with leaning is forgetting to richen the fuel mixture during descents. There is a descent checklist, remember? And "Mixture Rich" is on the checklist. One more item during descent: don't shock-cool the engine! A well planned, partial power, mixture rich, cowl flaps closed descent is best. Also, turn on all aircraft lights to make yourself as conspicuous as possible.

Landing

Apply grease and depart the runway with dignity. [Note: It is recommended practice not to use the brakes during normal landings; a well-executed approach and landing allows you to roll out and taxi off the runway without the need for braking. Save the brakes for short-field landings and emergencies.]

Read back all clearances and hold-short instructions.

Defer the after-landing check until the airplane is brought to a complete stop clear of the active runway (minimizes distractions). [Note: An exception to this rule is when the manufacture recommends otherwise, as when retracting flaps during a short-field landing to improve braking.]

Taxi back per the taxi plan and look for marshallers (remember they may be trainees, so make sure their directions make sense and conform to the taxi plan). Upon engine shutdown you may have to show the marshaller the aircraft keys to let them know it's safe to approach the aircraft and install chocks. Once the chocks are installed, release the Parking Brake.

9.5.6 After Landing, Shutdown and Post-flight

Fill in all remaining information on the aircraft Flight Log. Complete the air sortie debriefing section in WMIRS.

Enter any new problems into the Aircraft Discrepancy Log. If an item needs to be entered, make a clear and complete entry. If it is *clearly* a danger to further flight, take action to have the aircraft grounded.

If this was the last flight of the day install all chocks, tie-downs (both wings and tail), Avionics/control lock, and Pitot tube covers/engine plugs (windshield cover if available). [Note: Tie-down chains shall not be used directly from aircraft mooring points to an anchor point because of excessive impact loads on wing spars. If chains are used they shall be attached to wire rope anchors -- refer to Attachment 3 of CAPR 66-1.]

Check that the Master Switch and Parking Brake is OFF (leaving the parking brake on for more than one hour may cause damage to the braking system; it also makes it impossible to tow the aircraft) and that the Fuel Selector Switch is in the 'Right' or 'Left' position for refueling. Remove any trash and personal or special

equipment from the aircraft (be sure to check any borrowed equipment in with logistics). Lock the aircraft windows, doors and baggage compartment.

Check the general condition of the aircraft, check the oil, and refuel. Clean the leading edges and the windshield and windows and replenish cleaning supplies, if necessary.

Sign off any tasks that were completed on the crew's SQTRs.

Ensure that the aircrew obtains sufficient rest during crew rest periods, including approval of extensions to the maximum air crew duty period

9.6 The Mission Pilot and POD

We discussed in Chapter 6 how the mission staff estimates the Probability of Detection (POD). Let's look at some factors affecting POD that you can control:

- Ask questions during briefings to ensure you *really* understand your assignment
- Take the time to plan the flight thoroughly and make sure you are prepared to fly it before leaving mission base. This knowledge enables you to concentrate on the mission and "stay ahead of the aircraft," thus increasing search effectiveness. If possible, use *Google Earth*[™] to examine your search/target area (e.g., terrain, ground features, obstacles, roads, and other prominent features).
- Maintain optimum altitude and airspeed. If you have to decrease power on a southbound leg and increase power when you turn northbound in order to maintain a constant 90 knots, then do it.
- Accuracy of navigation: Use the GPS! However, you should be ready to complete the search using other navigational methods should the GPS fail.
- Avoid turbulence whenever possible, avoid steep or abrupt turns, and ensure the mission commander is scheduling breaks and monitoring the scanners (and yourself) for fatigue or dehydration
- Give a thorough debriefing and be brutally honest about your effectiveness
- Stay proficient in your flying skills. Flying the aircraft and operating its equipment should be second nature, leaving you free to concentrate on accomplishing mission objectives safely.

9.7 Flying the Mission

Before missions are launched, the briefing officer provides you with information designating the routes to and from the search area, and the types of search patterns to be used upon entering the search area. Your planning should involve the observer, as they are familiar with each type of search pattern and can assist you in planning and navigation. While the observer should be scanning while you fly the pattern, they can assist you if things become confused (hey, it can happen). The mechanics of planning and executing search patterns are covered in Chapters 7 and 8.

9.7.1 Number of Scanners on board

Search planning, probability of detection, and search pattern effectiveness depends upon some underlying assumptions; the most important as far as the aircrew is concerned is the *assumption that there is one crewmember dedicated to scanning out the right side of the aircraft and another on the left side.*

Since the majority of CAP aircraft are Cessna 172s that only carry three crewmembers, we will assume that the crew consists of a pilot, an observer in the right front seat, and a single scanner in the rear seat. We assume that the observer will be scanning out the right side of the aircraft while the scanner covers the left side. If a larger aircraft is used there may be two scanners in the rear seat; this will allow the observer to spend more time assisting you without seriously decreasing search effectiveness.

Mission pilots must remember that they are *not* scanners. A mission pilot who tries to fly the aircraft and scan the search area at the same time is doing neither job effectively or safely. The mission pilot is responsible for placing the scanners' eyes over the search area so they can do their job; your job is to fly the pattern precisely and effectively and for ensuring the safety of the aircraft.

Planning and executing a search pattern *with only one scanner on board* is different from one where you have two scanners. You will only be able to scan out one side of the aircraft (usually the right side); this means that you must keep the right side of the aircraft towards the search area at all times, which can have a significant effect on search time and aircraft hours. For example, single-scanner sorties would require careful planning and flying for a grid search since you will have to modify your leg entries/tracks to ensure the scanner scans the entire grid (no inverted flight, please).

Additionally, this cannot help but decrease search effectiveness due to fact that you lose the "double coverage" or overlap you get with two scanners looking out opposite sides of the aircraft. Scanner fatigue also becomes more of a factor, and search times need to be reduced to account for this.

For these reasons, performing parallel track or creeping line searches with a single scanner is not recommended. Likewise, searching any but open/flat terrain with a single scanner significantly reduces your chances of success.

9.7.2 Flying a search pattern

The mission pilot's contribution to a successful search is his ability to fly the search pattern precisely while maintaining altitude and airspeed. This must be done while performing the duties of a Pilot-in-Command; in the search area the most important of these duties is to "see and avoid" obstacles and other aircraft.

Another special consideration in flying search patterns is the possibility of engine trouble or failure at low altitude. The mission pilot must always be aware of where she is, the wind direction, the nature of the terrain, and where she will land if the engine fails *now*. This also underscores the importance of a thorough preflight inspection.

Like the rest of the aircrew, the mission pilot must continuously and honestly critique her performance during the sortie. If you're not set up properly when you enter the search area, exit and start again. If you are off by half a mile on a leg, fly the leg again. If winds and/or turbulence caused you to fly the legs erratically, emphasize this during the debriefing.

9.7.3 To Go or Not to Go

The CAP Incident Commander has authorized your flight, you have obtained a proper briefing and flight release, you have filed your flight plan, you have completed a thorough preflight of the aircraft, and your crew is briefed and ready to go. *A Mission Pilot may accomplish all of this and still not be safe to fly the mission.*

How can this be? All of the regulations and safety precautions have been followed to the letter. You have been extensively trained and have demonstrated proficiency by successfully completing a Form 91 check ride. Your wing commander has appointed you as a CAP Mission Pilot!

It all comes down to the individual pilot and the circumstances. How long has it been since you've taken off in a 14-knot direct crosswind? Have you ever taken off or landed on an icy runway? When is the last time you've flown cross-country at night? You're a current CAP Instrument Pilot, but how long has it been since you've flown in actual IMC?

Pilots, by their nature, are confident in their abilities -- sometimes overconfident. Mix in overconfidence, unusual circumstances, and the need to put all those hours of training to the test. Now add the desire to help others who are in immediate danger and you have all the ingredients for a dangerous situation.

The most effective way to break this potential accident chain is for Mission Pilots to be brutally honest about their abilities under the present conditions. Mission Pilots (as Pilot-in-Command) must have enough courage and integrity to decline a mission that they don't feel *comfortable* doing.

- You're transporting a K-9 team to another airport. You are instrument qualified and current. Weather at the destination airport is above the published minimums. However, the ceiling and visibility at the destination airport are below your *personal* minimums. Do you go or not?
- You've been assigned a nighttime route search for an overdue aircraft. It's been 91 days since you've done three takeoffs and landings to a full stop at night. Do you go or not?
- You've been assigned a C206 for the flight. On paper, you are qualified to fly this aircraft on CAP missions. However, it's been a long time since you've actually flown a C206. There are other C206 qualified MPs at mission base. Do you go or not?
- You've been assigned a nighttime ELT search. Your crew consists of a newly qualified, non-pilot Mission Scanner. The DF is inoperable, so you will be using the wing null procedure to locate the ELT. PIREP'S are reporting moderate turbulence in the search area, and clouds are reported as 3000 overcast. The last time you practiced the wing null procedure was during your Form 91 check ride thirteen months ago. Do you go or not?
- You are the only qualified Mission Pilot available for an ELT search. You have an experienced crew and the aircraft and instruments are in perfect condition. The weather is CAVU. However, you have just started taking a prescription allergy medicine (no one, not even your FAA physician, knows this). Do you go or not?

- A large mission is underway to search for a missing aircraft. The search area is heavily forested with no landmarks. You have been assigned to fly a quarter-grid. There will be aircraft in each of the quarter-grids surrounding yours. It's been over five months since you have practiced flying with the GPS. Do you go or not?
- A mission is underway and you have every reason to believe the victims are alive. You are tracking the ELT signal when you begin to observe the overcast becoming lower and lower. Do you continue? If so, how will you set your "it's time to execute a 180° turn" minimums?

These are just a few examples of the decisions that CAP Mission Pilots may face. In each of these examples there is a high likelihood that nothing (e.g., CAP regulations, mission procedures, or FRO procedures) would stop you from going.

It is up to you to decline a mission that you don't feel comfortable with. Civil Air Patrol depends on your integrity as a qualified Mission Pilot. You are responsible for the safety of yourself, your crew, and a valuable aircraft. It will not help the people in distress if you have an accident while searching for them.

So, just as it is important for SAR/DR crewmembers to be honest about what they see and don't see during a mission, it is vitally important that the Mission Pilot be very honest about their capabilities in a given situation. *No one, especially the crewmembers who depend upon you for their safety, will think less of you if you decline a particular mission for valid reasons.*

Intentionally blank

10. Step Through a Typical Mission

The purpose of this chapter is to walk and aircrew through the steps of a typical mission; starting when you leave home for mission base and ending when you arrive back home after the mission. Consider it a "mission checklist" and discussion. [A summary checklist is provided in Attachment 2, *Flight Guide*.]

This chapter's material is best taught to mission pilots and observers together. This enhances Crew Resource Management capabilities and encourages interaction between the pilots and observers.

Mission pilots will have covered a great part of this material in Chapter 9; if they are covering this material by themselves they may skip those portions already covered or use it as a review from the mission aircrew perspective.

OBJECTIVES:

1. Discuss the items you should check before leaving on a mission:
{MO O-2107; MP P-2107}
 - a. Personal and aircraft items
 - b. CAPF 71. {MP P-2119}
 - c. State the aircrew duty period and crew rest limitations
 - d. State the three unique entries made by a CAP pilot on an FAA Flight Plan and where they go on the plan
 - e. "IMSAFE" (or equivalent) and the flight release
 - f. Preflight and loading
 - g. Departure
2. Discuss the approach and landing, and your actions upon arrival at mission base including the general briefing.
{MO O-2107; MP P-2107}
3. Discuss the six steps of ORM and the four principles involved, and the CAP Aviation ORM Worksheet.
4. Discuss the aircrew briefing. {MO O-2107; MP P-2107}
5. Describe the information contained in and how to fill out the flight planning and briefing sections of the CAPF 104.
{MO O-2107; MP P-2107}
6. Discuss the items checked and actions taken before leaving on a sortie:
{MO O-2107; MP P-2107}
 - a. Release and preparation
 - b. Preflight and departure
 - c. State when the "sterile cockpit" starts and ends

7. Discuss duties during the sortie, including: {MO O-2107; MP P-2107}
 - a. Preparations prior to entering the search area
 - b. Required radio reports
 - c. State when the "sterile cockpit" starts and ends
8. Discuss your actions upon arrival back at mission base. {MO O-2107; MP P-2107}
9. Describe the information contained in and how to fill out the debriefing section of the CAPF 104. {MO O-2107; MP P-2107}
10. Discuss the aircrew debriefing. {MO O-2107; MP P-2107}
11. Discuss your actions upon arrival back home, including: {MO O-2107; MP P-2107}
 - a. What to do with the aircraft
 - b. What to do if you observe signs of post-traumatic stress
 - c. When the mission is officially over for you and your crew

10.1 Leaving Home Base for Mission Base

What's the Rush?

Why do we go to so much trouble to train mission aircrew members and encourage members to spend the time it takes to stay proficient? The primary reason is that *time is such a critical factor* in missing person or aircraft crash searches. You must treat every minute after you been alerted as critical to the survival chances of the victims.

Some statistics concerning aircraft crashes are informative (all percentages are approximate and times are average). Of the 29% who survive a crash, 81% will die if not located within 24 hours after the crash (94% within 48 hours). Of the 40% uninjured, 50% will die if not located within 24 hours after the crash; survival chances diminish rapidly after 72 hours. So, the time factor is a critical element in SAR.

The average time it takes for family, friends or authorities to notify AFRCC of a missing or overdue aircraft varies widely. If the pilot did not file any flight plan it averages 15.6 hours until AFRCC notification; if a VFR flight plan was filed the time goes down to 3.9 hours; its 1.1 hours if an IFR flight plan was filed. Next AFRCC has to notify CAP and CAP has to activate its resources and begin the search.

The average time from the aircraft's being reported missing to actually locating and recovering the victims are 62.6 hours if no flight plan was filed; 18.2 hours with a VFR flight plan; and 11.5 hours with an IFR flight plan. [Remember these are average times, so 50% of the response times are faster while the other half is slower.]

What do all these statistics tell us? They tell us to *take each mission seriously*, and that we should *strive to do everything better, smarter, and faster!* Training, practice and pre-planning help us accomplish these goals. [They also tell pilots to always file a flight plan!]

You should have a mission "ready" bag containing all your essential mission equipment. Inventory and re-stock it after each mission.

The urgency of events, coupled with a hasty call-out, may leave you and other crewmembers feeling rushed as you prepare to leave for a mission. This is where a good pre-mission checklist comes in handy (see Attachment 2, *Flight Guide*). As a minimum, the crew should check for the following:

- Proper uniform per CAPM 39-1 (including rank insignia, patches and headgear), and enough spare clothes for the duration
- Required credentials (the PIC is responsible for certifying the eligibility of any proposed passenger to the FRO prior to obtaining a flight release). This includes an FAA-approved photo ID card (e.g., state driver license) CAP Membership card, ROA card (optional), CAP Driver's License (optional; on CAPF 101), CAPF 101 card, and SQTRs.
- Check crew "safety currency" in eServices
- Personal supplies (e.g., civilian clothing, headset, charts, maps, plotter, log, checklists, drinking fluids and snacks) and survival equipment
- Sufficient money for the trip (e.g., credit cards and some cash; it's a good idea to keep a \$50 or \$100 traveler's check in you kit, as some FBOs don't take credit cards especially late at night). Also, change for drink and food machines is good to have.
- Cell phone (including spare battery and charger) and ECD/EFB

- Current charts for the entire trip. [It is also a good idea to keep gridded sectionals in the aircraft. These sectionals should cover the areas you normally search, and should be labeled if they are not current (e.g., "Obsolete - For Training Purposes Only").]
- Maps for the mission area (e.g., road atlas and topo), markers for the charts/maps and a clipboard to write on

Also check the:

- Data effecting Weight & Balance and ORM Aviation Worksheet (WMIRS).and update as necessary
- Status of the Carbon Monoxide Detector and Fire Extinguisher
- Discrepancy Log (WMIRS) and make sure the aircraft is airworthy and mission ready
- Fuel assumptions (e.g., fuel burn, winds, power setting, and distance)
- Towbar, Tie-downs, chocks, Pitot tube cover and engine plugs
- Other equipment such as flashlights (including spare batteries), fuel tester (with screwdriver heads), binoculars, multi-tool and "sick sacks"
- Cleaning supplies
- Special equipment (e.g., camera, computer, portable GPS)
- Survival kit (gear applicable to trip and mission area terrain)

Obtain a briefing (ask for FDC and Local NOTAMs and TFRs) and file your FAA Flight Plan. An FAA Flight Plan shall be filed for all for every flight of more than 50 nm, (the Incident Commander may be exempt this requirement). [Note: Even for exempted flights its good practice to file an FAA flight plan, and use flight following whenever possible.] Figure 10-1 shows information particular to CAP (look at #2 and #11).

U.S. DEPARTMENT OF TRANSPORTATION FEDERAL AVIATION ADMINISTRATION		(FAA USE ONLY) <input type="checkbox"/> PILOT BRIEFING <input type="checkbox"/> VNR			TIME STARTED		SPECIALIST INITIALS
FLIGHT PLAN				<input type="checkbox"/> STOPOVER			
1. TYPE	2. AIRCRAFT IDENTIFICATION		3. AIRCRAFT TYPE / SPECIAL EQUIPMENT	4. TRUE AIRSPEED	5. DEPARTURE POINT		7. CRUISING ALTITUDE
VFR	CAP 4239			KTS			
IFR							
DVFR							
6. DEPARTURE TIME							
				PROPOSED (Z)		ACTUAL (Z)	
8. ROUTE OF FLIGHT							
9. DESTINATION (Name of airport and city)			10. EST. TIME ENROUTE		11. REMARKS		
			HOURS MINUTES		N239TX		
12. FUEL ON BOARD		13. ALTERNATE AIRPORT(S)		14. PILOT'S NAME, ADDRESS & TELEPHONE NUMBER & AIRCRAFT HOME BASE			15. NUMBER ABOARD
HOURS MINUTES							
				17. DESTINATION CONTACT/TELEPHONE (OPTIONAL)			
16. COLOR OF AIRCRAFT				CIVIL AIRCRAFT PILOTS. FAR Part 91 requires you file an IFR flight plan to operate under instrument flight rules in controlled airspace. Failure to file could result in a civil penalty not to exceed \$1,000 for each violation (Section 901 of the Federal Aviation Act of 1958, as amended). Filing of a VFR flight plan is recommended as a good operating practice. See also Part 99 for requirements concerning DVFR flight plans.			

FAA Form 7233-1 (8-82)
Electronic Version (Adobe)

CLOSE VFR FLIGHT PLAN WITH _____ FSS ON ARRIVAL

Figure 10-1

Note: To file a flight plan for a sortie where you'll be spending considerable time flying search or photography patterns, you can adjust your "Route of Flight" to reflect this. FSS works off of VOR radials so when you determine your pattern entry point pick out a close by VOR and determine the radial (and distance) from that VOR. For example: KDTO ADM 207

radial 11.3 miles / +3.2 FUZ 360 radial 50 miles / KCWC. This reads "Takeoff from Denton, arrive at the entry point (ADM VOR 207 radial 11.3 miles), delayed 3.2 hours in the grid, come out of the grid at the exit point (FUZ VOR 240 radial 50 miles), and land at Kickapoo."

Verify you'll meet aircrew duty and rest requirements of CAPR 70-1:

- The maximum aircrew duty period is 14 hours of official CAP duty
- Aircrew members will not exceed 9 hours of flight time between periods of crew rest
- Aircrew members must have 10 hours of crew rest between the last official CAP duty and the first official CAP duty in the next duty period; this accommodates 8 hours of uninterrupted crew rest/sleep and two hours of personal preparation/travel time

Fill out/update the Planning and Briefing sections of the sortie in WMIRS, get a briefing and flight release, and review any aircraft discrepancies. NOTE: The pilot usually gets a briefing/flight release from the mission base staff (this includes pre-positioning, employment, and de-positioning of aircraft, and travel to/from the mission base).

During the crew briefing, pay particular attention to sterile cockpit rules, fuel management, fuel reserve and refueling stops, Special Use Airspaces, FDC and Local NOTAMS, and refueling and destination airport airspace and runway/taxiway layout. The mission pilot should obtain flight following for the trip.

Pre-flight

In addition to a thorough preflight you may have to perform an inspection per CAPF 71, *CAP Aircraft Inspection Checklist* (see Attachment 2, *Flight Guide*). The Safety Officer at mission base may use this checklist to determine the overall condition of the aircraft and to ensure that it complies with FAA and CAP regulations and directives. *Now* is the time to discover a discrepancy, *not* when you have flown 500 miles to mission base only to find that your aircraft won't be allowed to fly on the mission (or worse, the Safety Officer asks you "How do you intend to get home?").

Part of the Form 71 has you check the date and starting Tach & Hobbs times to ensure you won't exceed the mid-cycle oil change (40-60 hours, not to exceed six months), 100-hour/Annual, 24-month Transponder inspection, 24-month Pitot-Static system inspection, 24-month Altimeter calibration, ELT inspection and Battery replacement date, 30-day VOR check for IFR flight, and AD compliance list.

Fill in all required information on the aircraft CAP Flight Log. Ensure proper entries for mission symbol, mission number, crew names, and FRO.

If there are outstanding aircraft discrepancies, make sure you understand every entry, and make sure none of the discrepancies make the aircraft unsafe for flight or reduces your ability to accomplish the mission. Verify any outstanding discrepancies during your aircraft preflight. If new discrepancies are discovered, log them in WMIRS and ensure the aircraft is still airworthy and mission ready.

During loading, ensure that all supplies and equipment correspond to what was used in the Weight & Balance. Ensure aeronautical charts are current and cover all assigned areas. Also ensure you have all necessary charts and maps.

Ensure that the windshield and windows are clean, and that the towbar, chocks, tie-downs, and Pitot tube covers/engine plugs are stowed.

Check and test special equipment such as an airborne repeater, a camcorder or camera gear (including the spare batteries). You don't want to arrive at mission base with important equipment inoperable.

Make sure the parking area is clear of obstacles; arrange for a wing-walker if one will be needed to clear obstacles.

Enter destination or flight plan settings into the GPS. Turning off all radios and navigation equipment separately before turning on the Avionics Master switch reduces the load on the battery sufficiently for you to program your settings into the GPS.

The mission pilot will perform the passenger briefing and review the emergency egress procedure. The pilot should also brief the crew on the sterile cockpit rules, fuel management plan and assumptions, and assign responsibility for inquiring about fuel status once an hour. Then the pilot will review the taxi plan and taxiway diagram, and assign crew responsibilities for taxi.

Review CAPR 70-1 requirements for ground and taxi operations (taxi no faster than a slow walk when within 10 feet of obstacles; and maintain at least 75' behind light single-engine aircraft, 200' behind light multi-engine or jet aircraft, and 500' behind helicopters and heavies).

Give the crew assignments for takeoff and departure and make sure each crewmember knows in which direction they should be looking during each. *Remind the crew that midair collisions are most likely to occur in daylight VFR conditions within five miles of an airport at or below 3,000' AGL!* This means that most midair collisions occur in or near the traffic pattern. Since the pilot has only one set of eyes, this (and aircraft design) leaves several 'blind spots' that the observer and scanner must cover -- particularly between your 4 and 8 o'clock positions.

All crewmembers must wear their seat belts and shoulder harnesses during takeoff.

Once everyone is settled in, organize the cockpit and review the "Engine Fire on Start" procedure.

Departure

Always use the checklists in CAP aircraft. Whenever possible, the observer reads the checklist items to the pilot; the pilot checks the item and repeats back accomplishment of the item (i.e., the challenge-response method). The checklist should remain close at hand so that it can quickly be opened to confirm and complete emergency items. The pilot should brief the observer on how to use the emergency checklists (e.g., read the bold face items first and then continue with the rest of the items when directed).

The greatest concern during taxiing is collision avoidance! An increasing number of taxi mishaps are the number one trend in CAP. Investigations reveal that pilots are: straying from designated taxi routes, not allowing adequate clearance, not considering the tail and wings during turns, taxiing too fast for conditions, taxiing with obscured visibility, distracted by cockpit duties, and not using other crewmembers to ensure clearance.

Be sure and include the DF unit's self-test in your scan during startup. Also ensure that the DF, Audio Panel and FM radio are set up properly. If this is the first flight of the day, perform an FM radio check, if possible. Select your initial VOR radial(s) and GPS setting (e.g., destination or flight plan).

Obtain ATIS and Clearance (read back all clearances and hold-short instructions), and then verify the crosswind limitation. Set up the navigational instruments (e.g., VOR radials and GPS destination, entry points and waypoints). Obtain Flight Following. Ensure anti-collision lights are turned on as necessary.

Once you begin taxiing *the sterile cockpit rules begin; all unnecessary talk is suspended and collision avoidance becomes the priority of each crewmember.*

Sterile cockpit rules focus each crewmember on the duties at hand, namely concentrating on looking outside the aircraft for obstacles and other aircraft. The rules will always be used during the taxi, takeoff, departure, approach, pattern, and landing phases of flight; but the pilot or observer may declare these rules in effect whenever they are needed to minimize distractions.

Keep the emergency checklist close at hand and open to the emergency procedure section.

At takeoff, start the Observer Log with the time and Hobbs for "Takeoff." The FAA's "operation lights on" encourages pilots to keep all aircraft lights on when operating within 10 miles of an airport, or wherever flocks of birds may be expected.

While departing the airport environs practice collision avoidance and maintain the sterile cockpit until well clear of traffic and obstacles. Use shallow S-turns and lift your wing before turns to check for traffic. The crew must keep each other apprised of conflicting aircraft and obstacles.

Crewmembers shall wear seat belts and shoulder harnesses at all times, unless such wear interferes with crew member duties (e.g., when taking photos); the PIC will wear lap belts and shoulder harness at all times. Once clear of the approach/departure airspace the crew can relax the sterile cockpit rules.

10.2 Arrival at Mission Base

Approach and Landing

Obtain ATIS (or AWOS) as soon as possible before contacting approach control. You may be able to reach mission base on the FM radio; if so, report your ETA.

The pilot should review the taxi plan and airport taxi diagram with the crew, and make crew assignments for approach, landing and taxi. Make sure each crewmember knows in which direction they should be looking during each. *Remind the crew that midair collisions are most likely to occur in daylight VFR conditions within five miles of an airport at or below 3,000' AGL!* This means that most midair collisions occur in the traffic pattern, with over half occurring on final approach. Since the pilot has only one set of eyes, this (and aircraft design) leaves several 'blind spots' that the observer and scanner must cover -- particularly between your 4 and 8 o'clock positions.

Sterile cockpit rules are now in effect. Practice collision avoidance by turning the aircraft exterior lights on when within 10 miles of the airport. The pilot should use shallow S-turns and lift a wing before turns to check for traffic. Read back all clearances and hold-short instructions.

Defer the after-landing check until the airplane is brought to a complete stop clear of the active runway (minimizes distractions). Log and report "Landing."

Arrival

As you taxi to parking, watch for marshallers and follow their directions. Signal the Marshaller when you have shut down the engine and taken the Ignition Switch to OFF, and they should then chock the aircraft. Once parked, secure the aircraft (i.e., tie-downs, chocks, avionics/control lock, Pitot cover and engine plugs installed, windows, doors and baggage door locked, fuel selector switch in 'Right' or 'Left,' and the Parking Brake OFF). Remove personal belongings and special equipment. Check the oil, arrange for refueling, and then clean the aircraft (particularly the windows). A Safety Officer may meet you to perform her inspection (CAPF 71); if so, get a copy for your records.

Next you must close your flight plans with the FAA and FRO. Then you present your credentials and sign into the mission; make sure that you sign in personally, and that the aircraft is signed in as well. Complete the **Debriefing section** of your sortie and upload your fuel receipt (WMIRS).

The mission staff will probably show you around mission base and inform you of transportation, lodging and meal arrangements. They will also tell you when to report for duty, normally by telling you when the general briefing will be held.

10.3 Operational Risk Management Review

Operational Risk Management (ORM) is a practical way to accomplish the mission with the least possible risk. It is more than just common sense (although plain common sense is very important) and more than just a safety program. It can be used to identify and assess anything that might have a negative impact on a mission.

ORM is a method of getting the job done by identifying the areas that present the highest risk, then taking action to eliminate, reduce or control the risks. It can be very flexible and can take from a few seconds to a few hours or days.

ORM cannot be mandated, but it must become a part of the CAP culture. We in CAP are willing to take educated (informed) risks, but we do not like to gamble. Therefore ORM should be embraced both by individual members and mission planners and supervisors.

The Air Force uses a six-step "building block" approach:

1. Identify the hazards
2. Assess the risks
3. Analyze risk control measures
4. Make control decisions
5. Implement risk controls
6. Supervise and review

10.3.1 ORM Principles

Accept no unnecessary risks. Unnecessary risk comes without a commensurate return in terms of real benefits or available opportunities. All CAP missions and our daily routines involve risk. The most logical choices for accomplishing a mission are those that meet all mission requirements with the minimum acceptable risk.

Make risk decisions at the appropriate level. Making risk decisions at the appropriate level establishes clear accountability. Those accountable for the

success or failure of the mission *must* be included in the risk decision process. The appropriate level for risk decisions is the one that can allocate the resources to reduce the risk or eliminate the hazard and implement controls. Levels include the incident commander, aircraft or mission commander, ground team leader, or individual responsible for executing the mission or task.

Accept risk when the benefits outweigh the costs. All identified benefits should be compared to all identified costs. The process of weighing risks against opportunities and benefits helps to maximize unit capability. Even high-risk endeavors may be undertaken when there is clear knowledge that the sum of the benefits exceeds the sum of the costs. Balancing costs and benefits may be a subjective process and open to interpretation. Ultimately, the balance may have to be determined by the appropriate decision authority.

Integrate ORM into planning at all levels. Risks are more easily assessed and managed in the planning stages of an operation (this includes planning for a sortie). Integrating risk management into planning as early as possible provides the decision maker the greatest opportunity to apply ORM principles. Additionally, feedback (lessons learned) must be provided to benefit future missions/activities.

10.3.2 ORM and the Aircrew

There are many aspects of a typical mission or sortie (training or actual) that contain risks, and the aircrew needs to acknowledge those risks in order to eliminate or mitigate them. As you move through the steps of a typical mission, take time to look for the risks involved and think about the regulations, practices and procedures that CAP has in place to eliminate or reduce the risks.

Each CAP member is responsible to look for risks: at the local headquarters, in vehicles and aircraft used for CAP missions and activities, on flight lines, and at mission base. If you see a risk, don't ignore it! Take steps to eliminate or reduce the risks, and bring the risk (and your actions) to the attention of the person responsible.

The Pilot-in-Command has the ultimate authority and responsibility to deal with risks during flight operations. With this comes the responsibility to inform his or her crew of the risks involved in each flight, and to listen to and address crewmember's concerns about risks.

A powerful tool used to eliminate or reduce risks during a sortie is Crew Resource Management, discussed in Chapter 11. Also, the *CAP Aviation ORM Worksheet* you fill out in **WMIRS** is used to determine levels of risks for each air sortie.

CIVIL AIR PATROL AVIATION
 OPERATIONAL RISK MANAGEMENT WORKSHEET
 15-A-3970/A0055

Factor	Low	Moderate	High
Human			
Pilot Experience	> 1,000 hours PIC (0.0 pts.)	> 250 < 1,000 hours PIC (1.0 pts.)	< 250 hours PIC (2.0 pts.)
Mission Experience	> 50 hours mission time (0.0 pts.)	> 25 hours < 50 hours mission time (1.0 pts.)	< 25 hours mission time (2.0 pts.)
Pilot Currency	> 10 hours (0.0 pts.)	> 5 hours < 10 hours (1.0 pts.)	< 5 hours (2.0 pts.)
Pilot Duty Day	< 8 hrs (0.0 pts.)	8-10 hours (1.0 pts.)	> 10 hours (2.0 pts.)
Crew Rest	Good Health and Fully Rested (0.0 pts.)	Fair Health and / or some signs of fatigue (1.0 pts.)	Fatigued (4.0 pts.)
Mission			
Solo or Crewed	Crewed (0.0 pts.)	Solo (1.0 pts.)	N/A (0.0 pts.)
Sorties in a day	One (0.0 pts.)	Two (1.0 pts.)	Three or more (2.0 pts.)
Cumulative Sortie(s) Length	< 2.5 hours (0.0 pts.)	2.5 - 4.0 hours (1.0 pts.)	> 4.0 hours (2.0 pts.)
Mission complexity	Routine (0.0 pts.)	Complex (1.0 pts.)	Training (2.0 pts.)
Overwater Flight	Not overwater (0.0 pts.)	No portion of flight beyond (1.0 pts.)	Some portion beyond gliding distance to land (2.0 pts.)
(if overwater) Immersion suit	N/A (0.0 pts.)	With immersion suit (1.0 pts.)	Without immersion suit (4.0 pts.)
Mountain Flying Winds Aloft -912K	< 15 Knots (0.0 pts.)	15-25 Knots (1.0 pts.)	> 25 Knots (2.0 pts.)
Environment			
Time of Day	Day (0.0 pts.)	Dawn/Dusk (1.0 pts.)	Night (2.0 pts.)
T-Storms Enroute	None (0.0 pts.)	Isolated (1.0 pts.)	Few or Greater (2.0 pts.)
Turbulence	< Light (0.0 pts.)	Forecast or reported moderate (ex. AIRMET Tango) (1.0 pts.)	Forecast Severe (4.0 pts.)
ITS View Chart	Normal (0.0 pts.)	Caution (1.0 pts.)	Danger (4.0 pts.)
Wind Chill * View Chart	Normal (0.0 pts.)	Caution (1.0 pts.)	Danger (4.0 pts.)
Icing / Freezing Level	None reported (0.0 pts.)	Forecast icing within 2000' of highest flight planned altitude (1.0 pts.)	Forecast reported icing at or below highest flight altitude (4.0 pts.)
VFR Flight ceiling/visibility	>3,000 AGL And >5 SM (0.0 pts.)	>1,000 AGL < 3,000 AGL And/or > 3 < 5 SM (1.0 pts.)	<1,000 AGL and/or <3 SM visibility (4.0 pts.)
IFR Flight ceiling/visibility	>500 AGL and/or 1-3 SM visibility (0.0 pts.)	< 500 AGL and/or < 1 SM visibility (1.0 pts.)	Below departure airport approach minimums (4.0 pts.)
Surface crosswind component	< 5 knots (0.0 pts.)	5-10 knots (1.0 pts.)	> 10 knots (2.0 pts.)
Airfield	Familiar and > 3,000 ft runway (0.0 pts.)	Unfamiliar and/or Take Off Distance (TOD) > 1/2 Runway Length (1.0 pts.)	Unfamiliar and/or Take Off Distance (TOD) > 2/3 Runway Length (2.0 pts.)

The MP should complete the *Intermediate Risk Management* course; in eServices, select the Safety Management System page, then select “Online Safety Education” button and look for the Risk Management Courses.

10.4 General Briefing

The urgency of events, especially at the beginning of a SAR mission, may lead to a sense of confusion about the process. There is a lot of person-to-person talk, and two-way radio chatter adds to the din. But instead of confusion, what you hear is everyone trying to “get the picture” - get the information they need to do their jobs in a short amount of time. It is a deliberate process.

Soon after sufficient data have been assembled and the mission base is functioning, there will be an initial general mission briefing that everyone must attend. The Incident Commander (or designee) introduces the staff and covers mission base and safety procedures. The IC then summarizes the situation, including a description of the search objective. A map may be displayed, and the areas to be searched (or the object or area to be assessed) will be outlined on the map.

Other items covered include current and forecast weather conditions (for scanners and observers, the current and predicted visibility is especially important), plans (e.g., safety, communications, flight line, and taxi), the location of status boards (for updates), a time hack, and logistics and supply. The briefer should emphasize safety and the need to incorporate ORM in decision-making. You may be handed a sortie packet at this time, or the Briefing Officer may make assignments individually.

Thereafter, the general briefing is normally given each morning (or at the beginning of each operational period). Updates are given (or posted) regularly or after a significant development.

10.5 Aircrew Briefing

A detailed briefing will be given to each aircrew (and ground team) prior to each sortie. This will include all the information necessary to plan the sortie. Additionally, the briefer should tell you about ground resources, where they will be, how to contact them, and when to contact them.

Depending on the circumstances, the mission pilot may receive the briefing or the entire aircrew may be briefed together. It is important that you pay attention and ask questions. In this briefing, there are no stupid questions.

Aircrew briefing kits (maintained by the mission staff) may contain:

- Airport layout, taxi plan/procedures, emergency-landing areas
- Appropriately gridded aeronautical sectional charts (should be prepared on a permanent basis)
- Current sectional charts must be used for navigation and obstruction clearance. These charts need not be gridded
- Specialized briefing checklists (as applicable)

10.6 Mission Flight Planning and Briefing

A mission flight plan and a crew briefing are required for each sortie flown by your aircrew. The mission pilot fills out the Planning section of a sortie in WMIRS, preferably with the observer's assistance.

The day usually begins with a general briefing, followed by sortie planning and individual crew briefings. The planning/briefing information for the sortie is used to ensure that critical aspects of the upcoming mission are covered.

The day's sorties will usually be entered in WMIRS by the mission staff under the mission number. At this point they are considered "place holders" as they represent the staff's best estimate of the number of sorties needed, crew composition, sortie objective and takeoff time.

Once a crew is assigned a sortie, the mission pilot will be responsible for editing the WMIRS sortie data with information derived from the crew planning session. The mission observer is encouraged to assist in this process and to become very familiar with entering and uploading data into WMIRS.

10.6.1 Mission Flight Plan

The Planning and Briefing sections (Figs. 10-2 & 10-3) of an air sortie includes flight plan information. An FAA Flight Plan must also be filed for cross-country flights greater than 50 nm from point of origin, unless exempted by the mission Incident Commander (note that the PIC must file and activate an FAA flight plan for all counterdrug missions). Both show the intended route of flight, details about aircraft markings and performance, anticipated flight time, available fuel, and souls on board to facilitate rescue efforts in case of an emergency.

Although mission staff may fill in part of the data, the mission pilot is responsible for the sortie's flight Planning and Briefing sections of the air sortie (and filing an FAA Flight Plan, if necessary; there is a check box for this in the Air Sortie Briefing section), and the observer should assist the pilot whenever possible. The scanner

may observe the planning if there is room, but can be briefed separately after the planning is completed.

Several important flight planning factors to consider are:

- Assigned inbound and outbound altitudes
- Assigned search altitude and speed
- Time it takes to fly the assigned pattern(s)
- Weather (current and forecast)
- Emergency or alternate airfields
- Military Low Altitude Training Routes
- Hazards to flight (inbound, search areas, outbound)
- If possible, examine your search area/target on Google *Earth*™
- Once you have planned the route and have a time estimate, add some time to verify sightings (~ 10-15 minutes per sighting)
- If you're taking photos, add ~ 5 minutes to review/verify your photos
- Once you have determined your *ETE* (Estimated Time Enroute), add in your one-hour fuel reserve and determine if you'll need a refueling stop

Since one of the primary purposes of this plan is to let mission staff know where your aircraft is going and when it will return, the *Route of Flight* is one of the most important blocks. The *ETA* (Estimated Time of Arrival) is also very important; if a sortie isn't back within a reasonable time past this estimated time of return, mission base will attempt to contact you and a search may be started.

Double-check your *ETE* against your *Fuel (in hours)* (i.e., fuel onboard). If the total sortie time exceeds your fuel load *minus one-hour reserve* (e.g., a "round robin" sortie or extended sortie where you plan to refuel), ensure your *Route of Flight* thoroughly explains your intentions and lists your fuel stop. You should also identify your intentions for a fuel stop in the *Crew Notes* section.

Note: Your *Call Sign* is your aircraft CAP number.

AIR SORTIE UPDATE

Mission No. / Symbol 15-T-3492 / A5	Sortie No. A0031	Mission Name: DSAREX	Tracking No. <input type="text"/>
*Sortie Type DR Training	Mission Facility -- Select --	*Sortie Date (Z) 15 Nov 2014	
*Dep. Airport KODO	*ETD (Z) 16 : 30	*Dest. Airport KODO	*ETA (Z) 18 : 00
*Tail No. N239TX	*A/C Type C172	Call Sign 4239	
TAS (Knots) 110	Color/Description WRB	*Corp/Member A/C Corp	Fuel (In Hours) 4.3
Home Base KAMA	Equipment on Board		
	Permanent		
	<input type="checkbox"/> Transponder		
	<input type="checkbox"/> VOR		
	<input type="checkbox"/> DME		
	<input type="checkbox"/> Tactical Repeater Connection		
	<input type="checkbox"/> Becker DF		
	<input type="checkbox"/> L-Tronics		
	<input type="checkbox"/> Autopilot		
	<input type="checkbox"/> GPS		
	<input type="checkbox"/> CAP FM Radio		
	<input type="checkbox"/> Satellite Phone Connection		
	Removable		
	<input type="checkbox"/> Tactical Repeater		
	<input type="checkbox"/> Survival Kit		
	<input type="checkbox"/> Life Rafts & Vests		
	<input type="checkbox"/> Digital Camera		
	<input type="checkbox"/> ADIS		
	<input type="checkbox"/> Satellite Phone		
	<input type="checkbox"/> ARCHER Airborne System		
	<input type="checkbox"/> ARCHER Ground Station		
	<input type="checkbox"/> Other		

[View Closeout Info](#)

[Sortie Files](#)

Crew Contact (Phone, E-mail, etc.)

[Request Flight Release Officer\(s\)](#)

[Discrepancy Log](#)

Crew/Pax

-- Select Pilot --	-- Select Position --
-- Select Crew --	-- Select Position --
-- Select Crew --	-- Select Position --
-- Select Crew --	-- Select Position --

Figure 10-2

10.6.2 Mission Briefing

The Air Sortie Briefing section of the sortie (Figure 10-3) includes:

- Area of Operations
- Base telephone number and call sign, and applicable frequencies
- Required radio checks and contacts
- Other aircraft and/or ground teams in the area (location and call signs)
- Sortie Objectives and Deliverables
- Actions to be Taken on Objectives and Deliverables
- Route of Flight, including altitude and airspeed restrictions
- Aircraft Separation (adjoining area)
- Emergency/alternate air fields, MTRs, and hazards to flight

- Weather (many pilots paste Terminal Area Forecast information into the 'Optional Description' boxes)
- ORM -- results of the risk assessment (low, moderate or high), and special instructions (including risk mitigation procedures)

Be thorough and thoughtful as you fill out this form: it is very important. Use the *Crew Notes* section to add any other information that is pertinent to the sortie. When complete, gather your marked-up charts and notes and review them for accuracy and legibility. Put them in your flight case so you won't forget them.

No doubt your aircrew will hold an informal group briefing as you complete this form. Crew resource management demands prior agreement on details of the search.

AIR SORTIE BRIEFING [Request Flight Release Officer\(s\)](#)

Mission No. / Symbol: 15-T-3492 / A5 Sortie No.: A0031 Mission Name: DSAREX Tracking No.:

Area of Operations: Dep. Airport: KODO Dest. Airport: KODO

Base Telephone: Base Callsign: Base Freq.:

Air/Ground Freq.: Air/Air Freq.:

Required Radio Checks & Contacts: Other Aircraft In Area: Ground Teams In Area (Location/Callsign):

Sortie Objectives:

Sortie Deliverables:

Actions To Be Taken On Objectives & Deliverables:

Route Of Flight:

Altitude Assignment & Restrictions: Airspeed Expected & Restrictions:

Aircraft Separation (Adjoining Areas): Emergency/Alternate Fields:

Military Low Altitude Training Routes: Hazards To Flight:

Current Local WX: -- Sel -- Current En Route WX: -- Sel -- Current Area Of Operations WX: -- Sel --
Optional Description: Optional Description: Optional Description:

Forecast Local WX: -- Sel -- Forecast En Route WX: -- Sel -- Forecast Area Of Operations WX: -- Sel --
Optional Description: Optional Description: Optional Description:

Flight Plan Required None Flight Plan Opened

ORM Matrix Complete Risk Assessment: -- Select -- Risk Assessment Approved

Special Instructions (Including Risk Mitigation Procedures):

Crew Notes:

Figure 10-3

10.7 Preparing to Leave on a Sortie

Once you have been briefed and completed the Planning sections of the CAPF 104, the briefer will release you or direct you to the Release Officer. The release officer will inform the crew of any changes and release the flight in WMIRS.

Now is the time for final preparations for the flight. The mission commander (usually the observer) will have you check your equipment and supplies (e.g., headset, charts, maps, plotter, log, checklists, camera, fluids and snacks) and review flight line rules and the taxi plan. The final visit to the restroom is made.

The pilot may check in with the flight line supervisor for final release, and then begin the aircraft preflight. The pilot may receive instructions on the taxi plan at this time. [Preflight, loading and departure were covered in 10.1.] If you are assigned an unfamiliar aircraft (not the one you usually fly), the pilot should perform a very thorough preflight. Look at (and touch) all antennas, check the struts carefully, check the tires and brakes carefully, and note any significant scratches and dents. You don't want to be blamed for someone else's mistakes.

When more than one flight is accomplished by the same crew during the day, subsequent briefings are not required to be so detailed but must, at a minimum, highlight differences and changes from the original briefing.

Remove and stow chocks, tie-downs, covers, and the towbar.

If this is the first sortie of the day the observer will perform an FM radio check with mission base; you may also perform a DF functional check if this is an ELT search. Other special equipment (e.g., camera, video camera, GPS, SDIS or GIIEP) should also be tested before the first sortie.

Enter sortie settings into the GPS (e.g., destination or flight plan, entry points and waypoints). Turning off all radios and navigation equipment separately before turning on the Avionics Master switch reduces the load on the battery sufficiently for you to program your settings into the GPS.

Startup and taxi were covered in 10.1. If there are flight line marshallers, they will expect you to turn on your rotating beacon and signal the impending engine start. You are also expected to signal before beginning to taxi (e.g., turn on your Pulselite or flash your taxi or landing light).

Takeoff, climb and departure were covered in 10.1.

10.8 During the Sortie

Once clear of the airport/controlled airspace environs the crew settles into the transit phase. Depending on circumstances (e.g., the airspace is still congested or multiple obstacles are present) the sterile cockpit rules are normally suspended at this time. *The aircrew maintains situational awareness at all times during the flight.*

Take this time to double-check the navigational settings that will be used in the search area, and review search area terrain and obstacles. Also review methods to reduce crew fatigue during the search or to combat high altitude effects.

Update in-flight weather and file PIREPs. Periodically check navigational equipment against each other to detect abnormalities or failures.

As you approach the search area, review search assignments and double-check radio, audio panel and navigational settings. Check navigational equipment against each other (detect abnormalities or failures).

The pilot should stabilize the aircraft at the assigned search heading, altitude and airspeed at least two miles before you enter the search area, and turn sufficient aircraft exterior lights on to maximize visibility (so others can "see and avoid"). *Sterile cockpit rules are now in effect.*

When the aircraft enters its search area, the observer notes the time and the Hobbs reading and reports, "Entering the Search Area" to mission base. *At this time the observer's primary duty shifts to that of a scanner.*

The observer also provides periodic "Operations Normal" reports to mission base and/or high bird. The observer should also inquire about fuel status at least once an hour, which will prompt the pilot to think about fuel burn assumptions versus actual conditions. Update the altimeter hourly from the closest source.

During the actual search or assessment, the aircrew must be completely honest with each other concerning their own condition and other factors affecting search effectiveness. If you missed something, or think you saw something, say so. If you have a question, ask.

As PIC, the mission pilot must take current flight conditions into consideration (e.g., gross weight, turbulence, and terrain) and perhaps add a margin of safety to the assigned search altitude and airspeed. Log these deviations from the assigned search parameters; when you get back from your sortie you can debrief what you did and why.

Prior to any descent below the designated search altitude, the PIC must evaluate terrain, winds, turbulence, and obstructions to determine the best flight path to conduct a controlled descent and low altitude reconnaissance. The low altitude reconnaissance must be conducted along a short, planned flight path based on the PIC's evaluation and should provide the observer or scanner the best view of the area of interest (this low altitude reconnaissance must not include sustained maneuvering below the designated search altitude). Once the area of interest has been evaluated, the objective verified, or upon reaching the end of the planned low altitude reconnaissance path, return to the minimum search altitude specified by the IC and do not descend again except to evaluate new potential sightings or areas of interest.

If you spot the target, the most important thing to do is *notify mission base immediately*; the recovery must be started as soon as possible. Also remember to log all "negative result" sightings (e.g., a trash pile or abandoned car).

The observer should monitor the crew for fatigue or the effects of high altitude and schedule breaks as necessary. She should also ensure that all crewmembers drink plenty of fluids to prevent dehydration.

10.9 Return from the Sortie

When the aircraft completes its mission and leaves the search area, the observer notes the time and the Hobbs reading and reports "Leaving the search area" to mission base. Double-check your heading and altitude with what was assigned for transit to the next search area or return to base. Reorganize the cockpit in preparation for approach and landing. Perform the applicable steps for approach, landing and arrival (covered in section 10.2).

After a short break the crew will assemble to complete the aircrew debrief section in WMIRS, upload the fuel receipt into WMIRS, and prepare for debriefing.

10.10 Debriefing Information

The Air Sortie Debrief section of the sortie (Figure 10-4) contains your observations and comments regarding your sortie and your assessment of sortie effectiveness.

AIR SORTIE DEBRIEF

Mission No. / Symbol: 15-T-3492 / A5 Sortie No.: A0031 Mission Name: DSAREX Tracking No.:

Flight Plan Closed ATD (Z): : ATA (Z): :

NOTE: Hobbs and Tach are now switched to match the aircraft log.

Hobbs: End Tach: End
 Start Start

Hobbs To/From: Hobbs In Area: Hobbs Total:

Fuel Used (Gal): Oil Used (Qt): Fuel & Oil Cost: Receipt #: Wing Paid

Reimburse To: TX Direct Pay to Member
(Unit or CAPID)

Summary:

Results/Deliverables:

Weather Conditions:

Remarks:

Sortie Effectiveness: Reason (if not successful): Reason (Other):

Attachments & Documentation:

Phone Debriefing Debriefer (Name & CAPID): CAPID:

Time & Date Debriefed (Z): 15 Nov 2014 :

Figure 10-4

The information required for the debrief serves to emphasize the need to take good notes during the sortie (e.g., the observer log). Information includes:

- A check to make sure the PIC closed the FAA Flight Plan, if required
- Sortie information (ATD, ATA, Hobbs and Tach times, fuel)
- Summary
- Results/Deliverables
- Weather conditions
- Remarks
- Sortie effectiveness (including a reason if the sortie was unsuccessful)
- Attachments and documentation

The *Hobbs To/From* section is the transit time to/from the search area(s), and *Hobbs in Area* is the time you spent actually spent in the search area(s); the sum of the two is entered in the *Hobbs Total* section. These times are easily determined if you noted your takeoff, in search area, out of search area, and landing times and Hobbs readings in your log. The total time should correspond to the Hobbs time that is recorded in your aircraft Flight Log.

The *Summary* section describes what you accomplished on the sortie. It may be as simple as "flew sortie as planned." However, you should list any deviations from the plan, particularly if the deviation occurred in the search area.

The *Results/Deliverables* section can be as simple as "no sightings" or "no damage noted." However, you must list results such as sightings (including negative sightings), the number of photos you took, the area you took video of, the fact that you directed a ground team to a crash site, or the fact that you notified a fire department of the location of the fire and that they assumed control of the fire.

The *Weather Conditions* section can be as simple as entering "as forecast." However, if the weather was unexpected it is important to explain how the weather conditions affected sortie effectiveness. Planners take these comments into consideration when determining POD, so *it is vital that you give the mission staff your honest input!*

The *Remarks* section is for entering any information you think is pertinent or helpful that was not entered elsewhere on the CAPF 104. It also gives the crew a chance to comment on the effectiveness of the sortie in detail. Were north/south tracks appropriate, or would east/west be better? Was one-mile track spacing adequate, or was the terrain so broken that half-mile spacing would be better? Were you at the optimal search altitude? Did the terrain you were briefed to expect match what you saw? Was the sortie too long or too short, and should a rest break have been included in the flight planning? These are just a few of the things that aircrews can comment upon. Planners use this feedback to improve POD, so *it is vital that you give the mission staff your honest input.*

The *Sortie Effectiveness* section involves a quantitative assessment (successful, marginal, unsuccessful or not flown) of how well you accomplished your mission. Factors affecting search visibility (e.g., visibility, lighting, and sun position) and the crew (e.g., turbulence, fatigue, and how well the pilot covered the area) must be considered. If you need to explain why you chose a particular result, enter the explanation in the *Remarks* section. Planners take this assessment into consideration when determining POD, so *it is vital that you give the mission staff your honest input!*

The *Attachments & Documentation* section is self-explanatory. Be sure to label any attachments (e.g., mission and sortie number) so they can be related to the mission/sortie if it accidentally becomes separated. Upload documents and photos into WMIRS, as required.

Finally, check your *ATD* (Actual Time of Departure) and *ATA* (Actual Time of Arrival -- landing time) for accuracy; these times may have been entered by mission staff based on your FM radio reports.

10.11 Aircrew Debriefing

During the briefing everything that is known about the mission was passed along to the air and ground teams. In the debriefing, the reverse is true. Each search team (air and ground) tells how it did its job and what it saw. This type of information is given in detail and is in the form of answers to specific questions asked by the Debriefing. The information is then passed on the planning section for analysis, and the information may then be passed on, in turn, to departing search crews.

An aircrew or ground team cannot search and have "negative results". Even if the objective is not located, important information can be obtained, such as weather, turbulence, ground cover, and false clues.

The Debriefing uses the information you entered into WMIRS as a starting point for the debriefing. For example, more information on search area and weather conditions may be needed, and you should be ready to volunteer your observations. Perhaps you noticed an increase in cloud shadows. Perhaps visibility seemed to deteriorate because of the haze that developed after you arrived in the search area. Perhaps turbulence developed during the last one-third of your grid search. Any number of weather or personal factors could have changed during your sortie. To make the best contribution to the debriefing requires that you remember these changes and be prepared to tell the Debriefing about them.

Did you make any changes to the planned search procedure? The Debriefing's primary concern is to determine adequate search coverage. If, for example, you diverted frequently to examine clues, there is a good possibility that search coverage was not adequate and that another sortie is justified. If you become excessively tired and rested your eyes frequently, tell the Debriefing. Everyone understands the degree of fatigue a scanner can experience. But, frequent rest-eye periods will reduce the level of good scanning coverage, and also could be justification for another sortie. Did the pilot decide to change search airspeed and/or altitude? If so, you must provide details to the Debriefing.

What types of clues did you investigate? Perhaps a clue seemed to be insignificant and you decided not to pursue it. Describe any clues that were investigated and found to be false. This information becomes part of the briefing for other aircrews because it can keep them from pursuing the same false clues.

Debriefing results are provided to the operations staff and incident commander, periodically or whenever significant items are evident. At the end of each operational period, the incident commander and staff will review the debriefing forms to develop the complete search picture, compute probabilities of detection and cumulative POD, and then determine priorities and make plans for the next operational period.

When the Debriefing is satisfied that pertinent information has been discussed and explained, she will enter her information and the time and date of the debriefing, and you will be dismissed. Now what should you do? Obviously, you will need rest.

If you are scheduled for another sortie, find someplace to rest. Close your eyes; you may even want to take a nap if there is time and a place to do so. Also, take in some refreshment to give you sufficient energy for the next sortie.

The mission will be closed when the search objective is located or when suspended by higher authority. At this time mission personnel will return home. If the search objective has not been found and the mission is suspended, it may be reopened if additional clues are received.

10.12 End of the Mission and the Return Home

If you will be flying more sorties, the process begins again. However, if the mission is complete (or suspended) you must prepare to depart the mission base and return to your home base.

It is important to realize that SAR personnel can experience post-traumatic stress, so look for signs of stress in yourself and in your team members. No one in emergency services is immune to critical incident stress, regardless of past experiences or years of service. Critical Incident Stress Management (CISM) takes care of CAP members (primarily) and support personnel from other agencies (secondarily) who experience a potentially traumatizing event serving at a mission site or other CAP emergency services activity. Refer to CAPR 60-5.

Turn in any equipment that you may have been issued (make sure the person you give the equipment or supplies to marks the items as turned in). Make sure that you have settled all outstanding fuel, food and lodging bills. Ensure that you have all the records that you may need for local or personal reasons, such as fuel tickets.

NOTE: CAPF 108 for missions are automatically generated at the close of the mission as long as all sortie and other expense information is updated when the mission is complete. Completion of the online WMIRS CAPF 108 meets this requirement as long as the member submits any personal expenses and receipts to the person responsible for finalizing the online WMIRS CAPF 108 immediately after the mission is completed.

The pilot will plan the trip home and file a FAA Flight Plan. You must plan an "Outbound" sortie and obtain a CAP briefing and flight release (may be coordinated with your local FRO).

When you leave mission base, it is important to maintain crew discipline. You may be tempted to let your guard down now that the mission is over, but this is a mistake. Crew duties should still be assigned and understood, and the sterile cockpit rules should still be enforced where appropriate.

When you arrive at home base, secure and fuel the aircraft, close your FAA Flight Plan, call your FRO (if appropriate), and complete the debriefing section in WMIRS (including uploading your fuel receipt). Make sure that you have removed all personal items from the aircraft. You should clean the aircraft (especially the windows) so that it will be ready for the next flight.

Remember that the mission isn't over until all crewmembers have arrived at their own homes safely! Normally, the pilot is responsible for calling mission base once he knows that everyone is home.

Finally, the crew should brief their squadron on the lessons learned from the mission at the next opportunity. This provides valuable information to your fellow aircrew members and is an excellent opportunity to get in some quality "hangar talk."

10.13 Conduct Local Drills and Exercises

As you have learned during this course, your ability to perform at a high level depends upon knowledge, skill and proficiency. Therefore, you must practice and then practice some more.

CAP wings put on several practice exercises each year, but any individual may only get to participate in one or two of these during the time they are qualifying. So what do you do to get your initial task and 'exercise participation' signatures on your SQTR? What can you do to maintain and improve your *mission* skills?

Air Force Approved Pilot Proficiency Flights (A12 or B12) should be used to perform Scanner, Observer and/or Airborne Photography tasks (indeed, *this is encouraged*). A12 is preferable if funding is available, otherwise use B12.

Another answer is to stage unfunded drills and exercises at the squadron (or group) level. These can range in scope from a simple "table-top" exercise to a coordinated exercise involving two or three aircraft, a couple of ground teams, radio operators and a basic mission staff.

"Unfunded? No funding? You mean *I pay?*" Yeah, but let's take a look at this. The cost of local area training for ground teams and mission base personnel is very small (primarily gas, oil, coffee and donuts). As for aircrews, most people think this training is expensive; but a closer look shows that this is not the case. Assume a C172 burning 8 gallons/hour, 100LL costing \$6.50 per gallon and the maintenance rate (what you pay to wing) of \$38.00 per hour: this works out to a 'wet' rate of ~\$90.00 per hour (squadron aircraft costs vary). With three crewmembers splitting the cost, this comes to *\$30 for one hour's training* in the aircraft! Where else can you fly for this little? Also, you won't be spending as much on your training day for coffee and donuts 'cause you'll be flying -- an extra savings.

Another benefit to local drills and exercises is that *the training is concentrated*. By this we mean that you can quickly and easily design a lot of tasks into a single sortie, thus increasing efficiency and holding down costs. With CAP's task-based training syllabi, the tasks you need to train or practice are already developed; all you need to do is combine the tasks into scenarios for local use. This allows you to minimize transit times and perform multiple tasks for several people in an hour's time.

For example, a simple practice beacon search allows an aircrew to DF to the beacon, coordinate with a ground (or urban DF) team to lead them to the beacon, and lets the ground team DF to the beacon. While the ground team is working, the aircrew can then practice other DF methods and and/or work on other tasks such as video imaging. Mission staff members also accomplish tasks, particularly radio operators, flight line personnel, safety officer, and planning and operations staff.

It is important to run these drills and exercises like you would an actual mission. Checks credentials and uniforms and use all required forms; this way, members maintain familiarity with required paperwork, regulations and procedures.

It is also important that trainers and evaluators are certified to sign off students' SQTRs. Qualified evaluators are those that are current and qualified in the same operational specialty area or higher, and have completed emergency services *Skills Evaluator Training* (SET) and the associated exam; refer to CAPR 60-3 Section 2-2 for details. An on-line training course and the examination can be accessed from eServices via the *CAP On-line Courses and Exams* link.

The mission symbol would be either C12, B12 or A12 (or wing requirements), depending on the circumstances of the pilot-in-command and whether or not the

proficiency flight is funded or unfunded. Also, you need to ensure that the person signing off completion of tasks and exercise participation is qualified to do so.

It is important that you go through your chain-of-command; especially the first time you host a local exercise. Group and wing commanders need to know you have plans for their resources and personnel, even if it's just to get it onto the wing calendar. Many wings will require you to develop and submit an operations plan for these exercises, even though they are un-funded (check with your wing chief-of-staff). This is easy since you just need to develop a generic plan once and then change the dates and times as necessary. WMIRS allows for training drills and exercises.

The first drill or exercise you host will be a learning experience, so plan for this and learn from your mistakes. After you have it down, invite others (you don't want to keep all the fun to yourselves)!

NOTE: Don't be afraid to practice filling out mission forms in WMIRS. You can enter a new sortie, fill out the Planning and Briefing sections of WMIRS, including filling out the ORM checklist and uploading a Weight & Balance (don't bother to get a flight release). Fill out the Debriefing section and then go over the whole sortie with an evaluator or other experienced crewmember. Once you're done, simply cancel the sortie.

Intentionally blank

11. Crew Resource Management

Many professional studies have proven that properly trained team members can collectively perform complex tasks better and make more accurate decisions than the single best performer on the team. Conversely, the untrained team's overall performance can be significantly worse than the performance of its weakest single member. This chapter will cover aspects and attitudes of teamwork and communication among team members.

Crew Resource Management (CRM) was developed by the airlines and later adopted by the U.S. Air Force. Over the years it has gone through several different names and stages. The airlines saw drops in incidents and better crew coordination saw better handling of potential emergencies. The Air Force, and CAP, has recognized this safety concept and over the past several years, aggressively started building programs to protect crewmembers and aircraft.

CRM has evolved to a concept in training and action to get all persons and agencies involved in aviation to help thwart possible accidents. Even now, as CRM is engrained in almost every aspect of aviation, it grows and evolves, becoming better as we make advances.

CAP is a unique organization. Unlike the airlines, where everyone in the cockpit is a rated pilot, CAP has members in the plane who are not pilots. The Air Force is in a similar situation with their crews made up of pilots, engineers, navigators, and loadmasters.

Having scanners and observers who are also pilots is a different situation, as the pilots may want to compete over who is flying the aircraft. They *really* need to work together during flights.

It is essential that everyone in the aircraft feel free to speak up and provide input and ideas; even the crewmember that has only flown once may have the critical idea that could save an entire plane. But remember that the pilot is the final authority for safe operation of the aircraft and will make the final decision.

OBJECTIVES:

1. Discuss failures and the error chain. {MP P-2028}
2. Discuss situational awareness. {MP P-2028}
3. Discuss how to regain SA once lost. {MP P-2028}
4. Describe barriers to communication. {MP P-2028}
5. Define and discuss task saturation. {MP P-2028}
6. Discuss assignments and coordination of duties. {MP P-2028}

11.1 Statistics

CAP accident rates compared to General Aviation, per 100,000 hours:

Year	Civil Air Patrol	General Aviation)
1996	7.79	7.65
1997	4.16	7.17
1998	4.76	7.43
1999	2.34	6.50
2000	0.94	6.57
2001	3.57	6.78
2002	7.37	6.69
2003	4.43	6.68
2004	5.23	6.49
2005	2.77	7.20
2006	1.84	6.35
2007	3.70	6.93
2008	2.84	6.86
2003	3.57	7.20
2010	1.78	6.89 *

* NTSB average of past 15 years

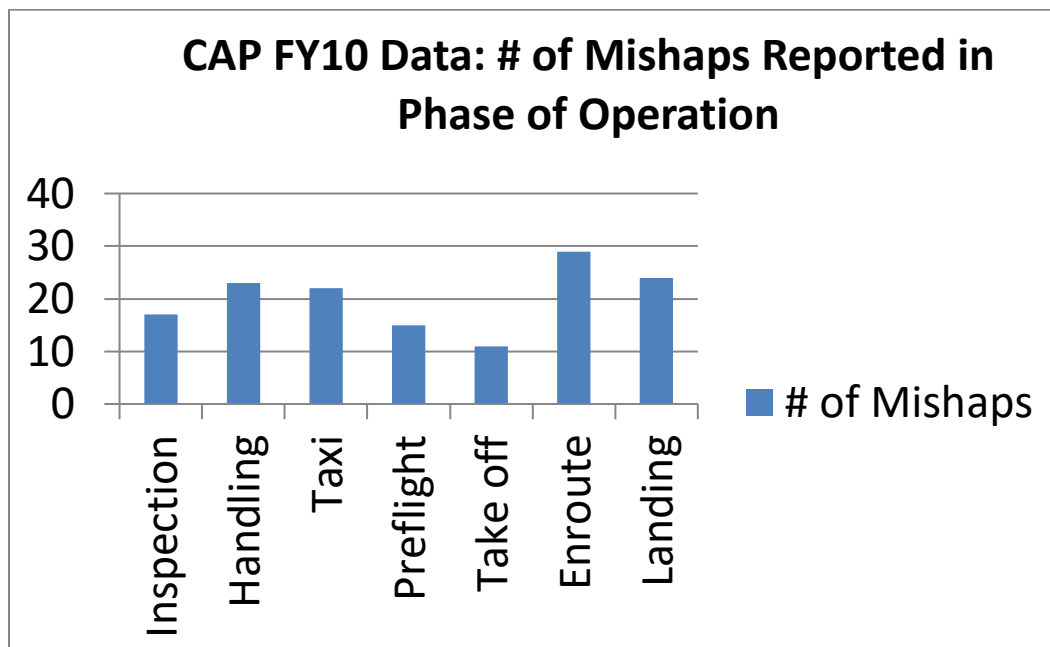

Statistics only mean how they are interpreted. We use statistics to show us where we are having problems, which will hopefully help correct those problems. Some areas where we need to improve are:

Taxi mishaps are mishaps where a crewmember was in the aircraft and moving it under aircraft power. All of these are a result of colliding with something, or going off the paved surface into a ditch. Many occurred when more than one pilot was onboard. Here we need to have everyone looking outside whenever the aircraft is moving.

Handling mishaps were due to moving the aircraft with human power, such as pushing or pulling the aircraft in and out of the hangar. Several of these totals were a result of opening or closing a hangar door and hitting the aircraft. These could be avoided with basic situational awareness and teamwork. While moving aircraft by hand or under aircraft power in close proximity to any objects, use wing walkers.

Landing mishaps (constantly high numbers): Due to the phase of flight, these have a potential for great damages to aircraft and injury to personnel.

A critical concept that needs to be enhanced is that, if any crewmember sees a problem or doesn't like the landing situation, they need to call "GO-AROUND." The pilot should then immediately perform a go-around (unless a higher emergency exists). *Every crewmember, pilot or not, has the right and the responsibility to keep themselves alive.* Maybe the scanner in back notices that the main tire is flat -- tell the pilot! Everyone MUST speak out, and the pilot MUST act on it.

11.2 Failures and the Error Chain

Failures are those of parts and physical objects or how people have failed in their actions or products.

- Mechanical failures involve every possible type of mechanical, part, or environmental failure. Examples are aircraft parts, runway surfaces, lighting, radios, and ATC.
- Human failures occur when people fail to perform the required actions. When an aircraft part fails because the person making the part didn't do it right, that is a human factors failure. Other examples are failures on the part of the pilot, observer, scanner, and ATC.

Error Chain. A series of event links that, when all considered together, cause a mishap. *Should any one of the links be "broken" then the mishap will not occur.* Here is an example of an error chain:

- A mechanic does not properly fix aircraft instrumentation during annual
- The pilot gets alerted to fly and, in a rush, gets a poor weather briefing
- The crew misses indications of broken instrument during the preflight inspection
- The pilot enters unexpected (to him) weather and transitions to instrument flying
- Flight instruments give the pilot bad information and he begins to get disoriented
- The disorientation leads to a stall and subsequent spin
- The pilot is unable to recover from the spin and impacts the ground

All of these are links in the chain. If any one of them could have been stopped or the link broken, the accident would not have happened. *It is up to everyone on a crew to recognize an accident link and break the chain.*

11.3 Situational Awareness

Simply put, situational awareness (SA) is "knowing what is going on around you at all times." SA is not restricted to just pilots -- everyone must exhibit SA at all times. Each crewmember must have their SA at peak levels while flying because it takes everyone's awareness to keep the plane safe in flight. Scanners and observers have their own unique positions and functions that require full attention, so their SA is essential to the safe operation of any CAP flight.

Examples of good SA attitudes are:

- Good mental health, where each crewmember is clear and focused
- Good physical health. This includes fatigue, sickness, hydration, and stress factors.
- Attentiveness. Keep your attention on the task at hand
- Inquisitiveness. Always asking questions, challenging ideas, and asking for input

Examples of SA skills:

- Professional skills developed through training, practice and experience
- Personal skills such as good communication skills. This is necessary to effectively get your point across, or receive valid input. Interpersonal skills such as the basic courtesies factor greatly into how a crew will get along, and this will greatly impact crew effectiveness and performance.

To help prevent a loss of SA, use the IMSAFE guidelines. This checklist was developed for the FAA as a quick memory guide for aviators to run through and make self-determination as to their fitness to fly. If a crewmember says yes to any of these, they really shouldn't fly.

Situational awareness may be lost for many reasons. Five of the more common reasons are:

- Strength of an idea. Someone has an idea so strong and ingrained that they won't listen to anything else. They find it difficult to alter the idea, even with new or conflicting information. The antidote to this is to ask questions or revert to training.
- Hidden agenda. Someone has a personal agenda, but keeps it hidden. Fail to tell others of their intentions. The antidote is to be honest, and to express ideas and intentions.
- Complacency. Someone has done a certain task so often that they forget about the risk. "I've done this a hundred times," or "It won't happen to me." The antidote is to revert to training, and realize that even if you've done it a hundred times before, the one hundred and first can still hurt you.
- Accommodation. Repeated exposure to threats or stress situations will decrease alertness or awareness, which leads to a form of complacency
- Sudden Loss of Judgment. Something quickly distracts a person and gets their full attention. Whatever they were doing or should be doing is now gone.

Symptoms of loss of SA vary, but a few are:

- Fixation
- Ambiguity
- Complacency
- Euphoria
- Confusion
- Distraction
- Overload
- Improper performance of tasks or procedures

Also, look for *hazardous attitudes*:

- Anti-authority (Don't tell me!). The antidote is to follow the rules.
- Impulsiveness (Do something NOW!). The antidote is to slow down and think first.
- Invulnerability (It won't happen to me!). The antidote is to realize that, yes, it can happen to me.
- Macho (I can do it!). The antidote is to realize that this attitude can hurt others beside you. This attitude can really be detrimental when there is an experience pilot in both the left and right seat! In this case, it is very important that the two pilots agree on who's flying the aircraft.
- Resignation (What's the use?). The antidote is to realize that you can make a difference, and to ask for help.
- Get-There-Itus (I've *got* to be home by 5!). It's better to be late than to be dead.

11.4 Overcoming Loss of SA

Pilots and aircrew must realize that you can't have complete SA all the time. The key is to have a plan to recover.

There are a number of standardized tools that can help improve CRM and overcome a loss of situational awareness. *When a crew loses SA it is critical to reduce workload and threats and stabilize the aircraft:*

- Suspend the mission. This relates to the "knock it off" concept, in this case stop doing complicated things. [Remember to "Aviate, Navigate and Communicate"]
- Get away from the ground and other obstacles (e.g., climb to a safe altitude)
- Establish a stable flight profile where you can safely analyze the situation

Once we have lost situational awareness, or recognized the loss in another crewmember, how do we get it back? A few methods are to:

- Listen to your gut feelings. If it acts like an idiot and talks like an idiot, then it's probably an idiot.
- *Use terms like "Knock it Off" or "Time Out" or "Abort" or "This is Stupid."* Once terms like these are called, the pilot should terminate the task or maneuver, climb away from the ground if necessary, establish straight-and-level flight and then discuss the problem. [The term you use should be agreed upon before the flight.]

A good example comes from a CAP training mission departing a controlled airport. As the aircraft was climbing out the scanner spotted traffic and said "Pilot, traffic at three o'clock." The pilot was talking to departure and replied "Quiet, I'm on the radio." The scanner repeated his sighting, and the pilot repeated his reply. The scanner shut up and the pilot finally saw the traffic.

What happened? The pilot ignored a serious safety input from a crewmember. His action alienated the scanner and established a climate not conducive to safety. [Coincidentally, the scanner was a commercial pilot and USAF T-37 instructor with more flying experience than the rest of the crew combined.]

Be aware that lack of individual respect can cause alienation, which is a serious barrier to communication (see next section) and can shatter teamwork. If an individual is insulted or ignored when making comments they will shut down and stop working with the crew. When this happens the aircrew must solicit input in order to pull the alienated crewmember back into the mission.

- *Keep the cockpit sterile* -- keep talk to the minimum necessary for safety, particularly during taxi, takeoff, departure, low-level flying, approach, pattern and landing. This helps remove distractions and keep everyone focused on the important things.

11.5 Barriers to Communication

This section is concerned with the human factors that may act as barriers to effective communication between team members, adversely affecting mission performance. Rank, gender, experience level, age, personality, and general attitudes can all cause barriers to communication. You may occasionally be hesitant to offer an idea for fear of looking foolish or inexperienced. You may also be tempted to disregard ideas that come from individuals that have a lower experience level. If you are committed to teamwork and good crew coordination, you must look through such emotions and try to constructively and sensitively adapt to each personality involved.

You can deal best with personalities by continually showing personal and professional respect and courtesy to your teammates. Criticism will only serve to build yet another barrier to good communication. Nothing breaks down a team effort faster than hostility and resentment. Always offer opinions or ideas respectfully and constructively. Instead of telling the pilot, "You're wrong," tell him what you *think* is wrong, such as "I think that new frequency is 127.5, not 127.9."

Personal factors, including individual proficiency and stress, may also create barriers to good communication. Skills and knowledge retention decrease over time, and that is why regular training is necessary. If you don't practice regularly, you very likely will spend a disproportionate amount of time on normal tasks, at the expense of communication and other tasks. Civil Air Patrol, the FAA, commercial airlines, and the military services all require certain minimum levels of periodic training for the sole purpose of maintaining proficiency.

Stress can have a very significant, negative effect on cockpit communication. An individual's preoccupation with personal, family, or job-related problems distracts him or her from paying complete attention to mission tasks and communication, depending upon the level and source of stress. The flight itself, personalities of the individuals, distractions, flight conditions, and individual performance can all be sources of communication-limiting stress. When stress reaches very high levels, it becomes an effective barrier to communication and job performance. Many fliers and medical specialists advocate refraining from flying or other complex tasks until the stress is removed.

In an emergency, there will likely be much more stress with which each crewmember must cope. Since very few emergencies result in immediate or rapid loss of an airplane, most experienced aviators recommend making a conscious effort to remain calm, taking the amount of time necessary to properly assess the situation, and only then taking the appropriate corrective action.

Part of your job is also to recognize when others are not communicating and not contributing to the collective decision-making process. Occasionally, other crewmembers may need to be actively brought back into the communication process. This can often be done with a simple "What do you think about that?" In a non-threatening way, this invites the teammate back into the communication circle, and, in most cases, he or she will rejoin the information loop.

11.6 Task Saturation

At times, crews or individual members may be confronted with too much information to manage, or too many tasks to accomplish in the available time. This condition is referred to as *task saturation*. This will most likely happen when a crewmember is confronted with a new or different situation such as an emergency, bad weather, or motion sickness. Preoccupation with the different situation may then lead to a condition of "tunnel vision," where the individual can lose track of many other important conditions. In an advanced state, comprehension is so far gone that partial or complete *situational awareness* is lost. When individuals are task saturated to this extent, communication and information flow usually ceases.

Everyone needs some workload to stay mentally active and alert. The amount of work that any member can handle is directly related to experience level. Each crewmember must try to keep his or her workload at an acceptable level. If you begin to feel overwhelmed by information or the sheer number of things to do, it's time to evaluate each task and do only those tasks that are most important. If you ever feel over-tasked, you have an obligation to tell the other crewmembers *before* becoming task-saturated and losing your situational awareness. If others know your performance is suffering, they may assume some of the workload, if they are able. Once the most important tasks are accomplished and as time permits, you can start to take back some of those tasks that were neglected earlier. Allocation of time and establishing priorities is known as *time management*.

Most people can recognize task saturation and understand how it can affect performance. However, you should also watch for these symptoms in other members of your crew and take over some of their responsibilities if you have the qualifications and can do so without placing your own duties at risk.

The pilot's job is to safely fly the aircraft, and you should be very concerned if he or she becomes task saturated, or spends an excessive amount of his time with tasks other than flying the airplane. No crewmember should ever allow the work management situation to deteriorate to such an extent as to adversely affect the pilot's ability to continue to safely operate the aircraft. Many preventable accidents have resulted from crews' entire involvement in other areas or problems, while the airplane literally flew into the ground. If any crewmember suspects pilot task saturation to be the case, nonessential discussion should cease, and the crew as a whole should discontinue low-priority aspects of the job, and even return to the mission base if necessary.

11.7 Identification of Resources

External resources can be people, equipment, or simply information. Internal resources are primarily training and experience. Resources are needed for the successful accomplishment of the mission.

Each crewmember must be able to identify the resources available to him or her; determine where the resources can be located when needed; and effectively incorporate those resources into the mission.

11.8 Assignment and Coordination of Duties

Assignment of aircrew duties is based on CAPR 60-3. All flight-related duties are conducted under the supervision of the aircraft commander. Mission-related duties may also be conducted under the supervision of the aircraft commander, but a properly trained observer can also fill the role of mission commander. The key is that positive delegation of monitoring duties is as important as positive delegation of flying duties.

As previously discussed, it is very important for each crewmember to know what they are supposed to be doing at all times and under all conditions. Aircraft safety duties vary with the startup, taxi, takeoff, departure, transit, approach, pattern and landing phases of flight. Mission duties are related to the mission objective, primarily to fly the aircraft safely and precisely (the pilot) and to scan effectively (scanners and observers).

Until recently, the study of crew coordination principles was limited to studying flight crew performance. However, over the last decade, the number of preventable operator-caused errors leading to accidents has caused both the military and commercial aviation communities to expand the study focus. Airline and military crew resource training now includes special emphasis and encouragement that, when making decisions, the pilot or aircraft commander should include *all* assets and sources of information in the decision-making process. The

general assumption or theory is that as more information becomes available, the likelihood of more accurate decisions will increase and operator errors will be reduced.

The same general principles of crew coordination and resource management apply to all the members of the aircrew team. Incident commanders, planners, operations section chiefs, SAR/DR pilots, mission observers, scanners, air traffic controllers, and flight service station personnel should all be considered sources for appropriate information by the aircrew team.

In order for any information to be used, it must be effectively communicated. The effective communication process that leads to good crew coordination actually starts well before a flight begins. Each member must pay close attention during the incident commander briefing to every detail presented. Clear understanding of the "big picture," search objective, altitudes, area assignments, and search patterns to be used *prior* to departure will preclude questions and debate in flight, when other tasks should take higher priority. Crewmembers having questions are encouraged to ask them at this time. The incident commander or air operations officer will normally establish certain safety-related rules for conducting that particular mission.

Decisions and search assignments are normally clearly stated to the crews, and crewmembers are encouraged to offer their own ideas. Planning and briefing officers should answer each question openly and non-defensively, and you should also make every effort to seek complete understanding of each situation.

In developing the actual mission operational plan workload management and task distribution are very important. An over-tasked crewmember may not develop a complete grasp of mission aspects that later may affect his or her performance. Remain alert for over-tasking in other crewmembers, and offer help if possible. If you find yourself over-tasked, do not hesitate to ask another qualified member for help. Each team member must continually think "teamwork."

Close attention should be paid during the pilot's briefing. The pilot will establish flight-specific safety "bottom lines" at this time, such as emergency duties and division of responsibilities. Each individual must again clearly understand his specific assigned duties and responsibilities before proceeding to the aircraft.

Other phases of the flight also require that distractions be kept to a minimum. Recent air transport industry statistics show that 67% of airline accidents during a particular survey period happened during only 17% of the flight time -- the taxi, takeoff, departure, approach, and landing phases. The FAA has designated these phases of flight as critical, and has ruled that the cockpit environment *must* be free of extraneous activity and distractions during these phases to the maximum extent possible (the sterile cockpit).

In assigning scanning responsibilities to the scanners, mission observers must be receptive to questions and suggestions from the scanners. Carefully consider suggestions and understand that suggestions are almost always offered constructively, and are not intended to be critical. Answer questions thoroughly and openly, and don't become defensive. All doubts or questions that you can't answer should be resolved as soon as possible. It is critical to remember that CRM encourages the flow of ideas, but the Mission Pilot must make the final decision based on the crew's input.

Attachment 1

GRIDDING

Appendix E, *United States National Search and Rescue Supplement to the International Aeronautical and Maritime Search and Rescue Manual*, contains tables that enable you to grid all the United States aeronautical sectional charts.

The instructions and the table listing the sectional charts, and the individual tables are provided separately due to space constraints.

Intentionally blank

Attachment 2

FLIGHT GUIDE

The Flight Guide is provided separately due to its purpose and size. It is designed for printing (full page or knee board size) and may be carried by aircrew members. Members should look through the guide to decide what is applicable to their aircraft and mission, and then print only those pages.

The guide is not required to teach the material in the *Mission Aircrew Reference Text*, but is controlled because it contains material from and related to the MART. The guide contains figures, graphs, tables, operations guides, and forms that will aid the aircrew member in his or her daily tasks.

Not all items in the Flight Guide are needed; crewmembers should identify what items they need and then print only those items. If desired, print them in "knee-board" size.

Flight Guide Table of Contents

1. Mission Checklist
2. Documents and Minimum Equipment
3. CAP Operational Risk Management Aviation Worksheet (WMIRS)
4. Density Altitude
5. Crosswind Data Sheet
6. Weight & Balance Worksheet
7. FAA Flight Plan
8. Basic VFR Traffic Pattern (Uncontrolled Field)
9. VFR Flight Information
 - a. VFR Airspace Classifications
 - b. Basic VFR Weather Minimums
10. Emergency Egress
11. Flight Line Hand Signals
12. Pilot Guide to Airport Signs and Markings
13. Surface Movement Guidance and Control System
14. PMA7000MS Audio Panel Operations Guide
15. NAT NPX-138 VHF FM Radio Operations Guide
16. TDFM-136 Digital/Analog VHF FM Radio Operations Guide
17. CAP FM Radio Information
 - a. National Standard Channelization Plan (frequencies 1-4)
 - b. Other Important Frequencies and Phone numbers
 - c. Required FM Radio Reports

18. Prowords and Aircraft Clock Positions
19. Visual Signals
 - a. Paulin
 - b. Emergency Distress
 - c. Ground-to-Air Body
 - d. In-Flight Intercept Procedures
 - e. Air-to-Ground (no com)
 - f. Air-to-Ground Team Coordination
20. Airdrop Procedures
21. Aircrew Survival Basics and Urgent Care/First Aid
22. POD Charts (Mission and Cumulative)
23. Visual Search Patterns
24. Apollo GX-50/55 GPS - SAR Operations Guide
25. U.S. Grid Chart Table
26. DF Search Patterns
 - a. Metered
 - b. Audible
 - c. Wing Null
27. ELT Reception Distances
28. L-Tronics DF Functional Checks
29. Becker SAR DF-517 Operations Guide
30. Basic Ground ELT Search Procedures
 - a. Hand-held DF Procedures
 - b. Silencing an ELT
 - c. Legal Issues

31. Forms
 - a. ELT Search Information Required by AFRCC
 - b. Observer Log and Instructions
 - c. Observer/Scanner Search Area Work Sheet
 - d. Mission Pilot Search Area Work Sheet
 - e. High Bird Work Sheet
 - f. High Bird Transmission Log
 - g. CAP Photo/Recon Log
 - h. Standardized Latitude/Longitude Grid System
 - i. Standardized 15' x 15' Grid Coordinates
 - j. Standardized 7.5' x 7.5' Grid Coordinates xxA
 - k. Standardized 7.5' x 7.5' Grid Coordinates xxB
 - l. Standardized 7.5' x 7.5' Grid Coordinates xxC
 - m. Standardized 7.5' x 7.5' Grid Coordinates xxD
 - n. CAP Grid Coordinates Work Sheet
 - o. CAP Quarter Grid Coordinates 'A' Work Sheet
 - p. CAP Quarter Grid Coordinates 'B' Work Sheet
 - q. CAP Quarter Grid Coordinates 'C' Work Sheet
 - r. CAP Quarter Grid Coordinates 'D' Work Sheet
 - s. Route Coordinates Work Sheet
 - t. Creeping Line Coordinates Work Sheet
 - u. Expanding Square Coordinates Work Sheet
 - v. Circling Imaging Pattern Work Sheet
 - w. 4-Square Imaging Pattern (using Port Window) Work Sheet
 - x. 4-Square Imaging Pattern (using Starboard Window) Work Sheet
 - y. Bird's Eye Imaging Pattern Work Sheet
 - z. 45° Angle to Target Imaging Pattern Work Sheet

Intentionally blank

Index

A

accident chain · 166
ADF · 23, 61
ADIZ · 152
Aerial Imaging · 149
AFRCC · 103
air masses · 35
Air Route Traffic Control Centers · 88
aircraft flight log · 156, 163
aircraft logbooks · 156
aircraft paperwork · 155
aircraft performance limitations · 47
aircrew briefing · 179
aircrew debriefing · 188
airdrops · 21
AIRMETs · 24
airspace · 57
airspace restrictions · 151
air-to-ground signals · 16
air-to-ground team coordination · 17
Alert Areas · 59
altimeter · 23
analgesics · 51
antihistamines · 51
ASOS · 25
ATIS · 24
audio panel · 9
aural search method · 113
Automated Surface Observing System · 25
Automated Weather Observation System · 25
Automatic Direction Finder · 61
Automatic Terminal Information Service · 24
AWOS · 25

B

barriers to communication · 198

biological, chemical or radiological terrorism · 96
briefings · 6, 164, 171, 179

C

callsign · 9
CAP forms · 6
CAPF 101 · 5
CAPF 101Ts · 5
CAPF 104 · 6, 181, 184, 186, 189
CAPF 108 · 6
carburetor icing · 34
CDI · 63
ceiling · 25
chart preparation · 74
checklist · 4, 158, 173, 174, 179
checkpoints · 77, 78
clearances · 179
cold front · 37, 38, 39
communications radio · 8
contour · 69, 70
contour lines · 71
contour search · 136
convection currents · 29, 35
coordinates · 56
course · 54
Course Deviation Indicator · 63
creeping line search · 128
crew coordination · 199
Crew Resource Management · 193
CRM · 193
crosswind chart · 160
cultural feature · 69
cumulative POD chart · 93
cumulonimbus · 39

D

damage assessment · 97
debrief · 6
decongestant · 50, 51
dehydration · 49

density altitude · 25, 49, 52
dew · 37
DF · 105, 109, 116
Direction Finder · 105
disaster assessment · 95
discrepancy log · 142, 163, 173
Distance Measuring Equipment · 66
DME · 66
drift · 54
drift correction · 54

E

ear block · 50
ELT · 102, 109, 110, 113, 114, 115, 116,
118, 121
ELT legal issues · 121, 122
ELT locations · 119
ELT tent · 120
Enroute Flight Advisory Service · 22
EPIRBs · 102
error chain · 195
expanding square search · 132

F

FAA flight plan · 172, 176, 189
flight plan · 179
Flight Service Stations · 22
Flight Watch · 22
FM radio · 8, 13
FM radio reports · 16
freezing level · 32
frontal activity · 35
frost on an airframe · 32
FSS · 22
fuel management · 142, 173, 185

G

general mission briefing · 178
Global Positioning System · 67
go/no go · 166
GPS · 67
great circle · 55
grid · 79
gridding · 81

ground mishaps · 195
ground track · 54, 86
groundspeed · 78
GX55 · 67

H

hazardous weather · 24, 25
heading · 54
hearing search method · 113
high pressure area · 31
high-wing null · 110
HIWAS · 24
homing · 61
homing method · 109
humidity · 49
hypoxia · 51

I

ice on an airframe · 32
IFR flights · 149
Imaging · 149
IMC · 115
IMC ELT searches · 115
in-flight intercept · 153
instrument meteorological conditions ·
115
Instrument Routes (IR) · 59
intelligence gathering · 97
intercom · 11
intercom function · 13

K

KMA 24 · 10
knots · 55

L

landing mishaps · 195
lapse rate · 32
last known position · 88
latitude · 55
latitude, longitude, and distance · 127
leaning · 161

light gun signals · 16
LKP · 88, 104, 146
longitude · 55
low pressure area · 31
low-wing null · 110

M

magnetic course · 54
magnetic heading · 54
magnetic variation · 54, 56, 75, 111
maximum area of possibility · 86, 87
Maximum Elevation Figures · 73
maximum probability area · 92
MEF · 73
meridians of longitude · 55
meteorological visibility · 86
metered search method · 114
microbursts · 44
Military Beacons · 102
Military Operations Area · 58
Military Training Routes · 59
missing person search · 99
mission pilot duties · 140
MOA · 57, 77
mountain flying · 52
mountainous terrain · 52, 136
MTRs · 59

N

National Track Analysis Program
(NTAP) · 88
National Transportation Safety Board ·
121
nautical mile · 54
navigation terms · 54
navigational instruments · 61
NDB · 23, 61
night ELT searches · 115, 138
night flights · 137, 138, 146
nighttime illusions · 147
Non-Directional Radio Beacon · 61
NOTAM · 151
NOTAMs · 23, 24
Notices to Airmen · 60
NTSB · 121

O

observer duties · 4
observer log · 5
occluded front · 39
omnidirectional · 63
Operational Risk Management · 176
ORM · 176
ORM and the aircrew · 177
ORM principles · 176

P

parallel sweep search · 125
parallel track search · 125
parallels of latitude · 55
PETs · 102
phases of flight · 155
Pilot Weather Report · 25
pilot's briefing · 200
PIREP · 25, 28
planning visual search patterns · 124
PLBs · 102
plotting a course · 77
PMA7000M-S · 11
POD · 86, 164
POD chart · 91
post-traumatic stress · 189
pre-mission checks · 171
probability area · 86, 88
probability of detection · 86
proficiency flights · 150
Prohibited Areas · 58

R

radial · 63
reflected ELT signals · 116
Restricted Area · 58
restrictive placards · 157
route search · 125

S

SA · 196
SARSAT · 103
scanning range · 86

search altitude · 86, 91
search area determination · 87
search terrain · 91
search track · 86
search visibility · 86, 91
seat belts · 159, 174, 175
sectional aeronautical chart · 69
sectional aeronautical information · 73
sectional chart interpretation · 70
sectional chart legend · 70
sector search · 135
securing aircraft · 163, 176
security concerns · 151
SIGMETs · 24
signal fade · 108
signal null search · 110, 112
signal-offset · 116
silencing an ELT · 118
single scanner · 165
sinus block · 50
situational awareness · 184, 196, 197
slant range · 66
Special Use Airspace · 57
squawks · 142, 163, 173
Standardized Latitude and Longitude
 Grid System · 80
station passage · 109
statute mile · 54
sterile cockpit rules · 141, 159, 162, 163,
 174, 175, 185
stress · 198
stuck microphone · 15

T

task saturation · 198
taxi mishaps · 159, 174, 195
taxiing · 141, 159

TDFM 136 · 14
Temporary Flight Restrictions · 151
Terminal Radar Approach Control · 88
thunderstorms · 43
Tie-downs · 163
track crawl · 125
track line search · 125
track spacing · 86, 92, 125, 129, 132
Transcribed Weather Broadcasts · 22
transportation flights · 146
true course · 54, 78
turbulence · 42
TWEB · 22
types of flights · 145

V

Very High Frequency Omnidirectional
 Range · 63
VFR · 57
VFR Terminal Area Chart · 70
VHF · 8, 63
Video Imaging · 149
Visual Routes (VR) · 59
VOR · 23, 24, 63, 66
VORTAC · 66

W

warm front · 36, 39
Warning Areas · 59
weather · 28
weather information sources · 28
weight and balance · 143, 158, 173
wind shear · 41
windshear · 42
wing shadow search · 110