

Mist Elimination

DEMISTER®



FLEXICHEVRON®



FLEXIFIBER®



Mist Elimination

In any process where gas and liquid come into contact, the gas will entrain some liquid droplets. These mists can cause process inefficiencies, product loss, and serious equipment damage.

Entrainment Mechanisms

The way that droplets are formed determines the size of droplets to be removed. Knowledge of the mechanisms that cause droplet formation and the resulting droplet size is essential to proper mist eliminator selection and design.

Entrainment is generated by one or more of three basic mechanisms:

- ▶ Mechanical action
- ▶ Chemical reaction
- ▶ Condensation

Figure 1 illustrates the typical particle size distribution ranges for entrainment caused by various mechanisms. With this knowledge plus experience, the droplet sizes produced can often be estimated with reasonable accuracy.

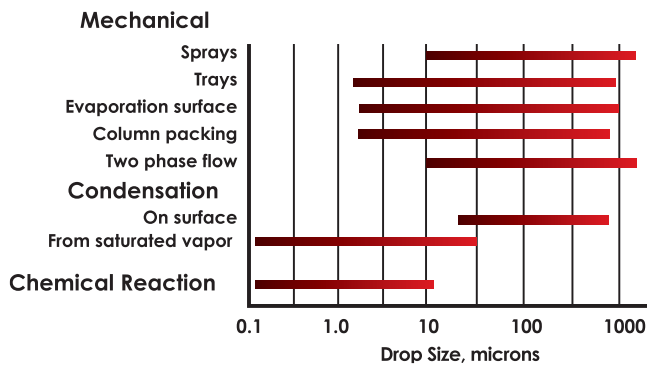

Figure 1. Particle Size Distribution Ranges.

Mechanical Action

Experience shows that droplets generated by mechanical means are over 5-10 μ in diameter. But a boiling or bubbling liquid surface will form droplets down to just a few microns in diameter.

Chemical Reaction

When two gases react to form a liquid product, large quantities of sub-micron droplets are formed, which, in turn, requires high efficiency separation equipment.

Condensation

Entrainment swept off the surface of heat exchanger tubes consists mostly of relatively large (50+ microns), easily removed droplets. However, extremely fine submicron entrainment is often generated when a liquid condenses directly in the vapor phase due to cooling of a saturated vapor. This type of very fine entrainment can be seen when lubricating oil in a compressor is locally heated and vaporized and then quickly condensed causing a "blue smoke."

Uses of Mist Eliminators

The formation of mists in gas streams often results in process inefficiencies and/or product loss in equipment such as knockout drums, distillation columns, evaporators, and environmental scrubbers. Mists can also cause serious damage to downstream equipment.

The following examples are provided to help you evaluate the benefits that a properly designed mist eliminator can provide to your operations.

Reduce loss of valuable chemicals

Mist eliminators markedly cut glycol, amine or solvent consumption in absorption and regeneration towers.

Increase throughput capacity

Mist eliminators allow significant increase in throughput anywhere gases and liquids come into contact in process equipment.

Improve product purity

Mist eliminators prevent contamination of side draws and overheads in refinery atmospheric and vacuum towers and other distillation columns.

Eliminate contamination

Mist eliminators prevent the poisoning of expensive downstream catalysts or provide boiler feed water quality condensate from evaporator overheads.

Provide equipment protection

Mist eliminators protect turbine, blower and compressor blades, which eliminates serious maintenance problems.

Prevent air pollution

Mist eliminators help reduce droplet emissions to environmentally acceptable levels.

Types of Mist Eliminators

Almost all mist elimination equipment falls into one of four general classes:

- ▶ Knitted wire mesh pads (DEMISTER® mist eliminators)
- ▶ Vane assemblies (FLEXICHEVRON® mist eliminators)
- ▶ Fiberbed candles and panels (FLEXIFIBER® mist eliminators)
- ▶ Cyclone assemblies

DEMISTER® Mist Eliminators

When the vessel size is not set by the mist eliminator (such as is normally the case for distillation towers, steam drums, or evaporators), the practical starting point is often the knitted wire mesh pad type. DEMISTER knitted mesh mist eliminators provide high separation efficiency at the lowest installed cost.



KOCH-OTTO YORK® DEMISTER® mist eliminator style 709 in stainless steel.

FLEXICHEVRON® mist eliminator style VIII in FRP.



FLEXIFIBER® mist eliminator type IC-SRF.



Cyclone mist eliminator assembly with mounting deck and liquid drain piping for a vertical vessel.

Picture courtesy of CDS Separation Technology.

FLEXICHEVRON® Mist Eliminators

When the vessel size is set by the mist eliminator, then the benefits of high capacity FLEXICHEVRON mist eliminators could be the most cost effective overall solution.

The fouling resistant FLEXICHEVRON mist eliminator often offers the best solution if the mist contains solid particulates; viscous, sticky liquids; or if large slugs of liquid occur.

FLEXIFIBER® Mist Eliminators

FLEXIFIBER mist eliminators are the only type that can effectively remove submicron size particles.

Cyclone Mist Eliminators

In extreme debottlenecking situations or in new designs at very high operating pressures where it is necessary to minimize vessel size and weight, the high capacity characteristics of cyclone mist eliminators often prove beneficial. In high pressure applications, cyclone mist eliminators provide performance advantages and minimize vessel sizes, when compared to other mist eliminators.

	Knitted Mesh	Vane	Fiberbed	Cyclone
Cost	1	2-3	10	3-5
Gas Capacity	5	6-15	1	15-20
Liquid Capacity	5	10	1	10
Particle Size (micron)	3-10	10-40	< 0.1	7-10
Pressure Drop, WC	< 25 mm (1")	<10-90 mm (0.4" - 3.5")	50-500 mm (2" - 20")	200-240 mm (8" - 14")
Solid Handling	3	10	1	8
Relative scale based on 1 as the lowest. Others are scaled.				

While the suggestions on this page provide a starting point for the selection of a mist eliminator, your final choice should be made only after reviewing your application with an equipment designer of proven expertise. Koch-Glitsch provides expert resources to help you make the best choice for your particular application.

Common Applications

Knockout Drums

Designing knockout drums to include mist eliminators will reduce capital equipment costs and improve efficiency.

Knockout drums relying solely on gravity settling remove only drops larger than 100 microns. Using an efficient mist eliminator will prevent entrainment of all drops larger than 5 to 10 microns. This higher efficiency reduces product loss; downstream corrosion; contamination; and damage to equipment such as compressors, molecular sieve driers, and blowers. Vessel weights can easily be reduced to half, and handling of liquid slugs is improved.

Evaporators

Customized mist eliminators reduce carryover of dissolved and undissolved solids to obtain specified steam condensate purity levels below 1 to 50 ppm. This not only prevents product loss, but it also protects compressor internals in vapor recompression systems, provides boiler feed water quality condensate, and prevents potential pollution problems.

Industrial installations vary from chemical plants (caustic and inorganic chemical concentrators), to pulp and paper (black liquor and pulping chemical recovery) to the food industry (sugar, salt, and corn syrup production).

Steam Drums

Customized mist eliminators reduce carryover of dissolved solids to obtain specified steam condensate purity levels from 1 ppm down to 5 ppb without the need for external separator vessels. Operating pressures can range from 20 to > 2500 psig [1 to 170 bar].

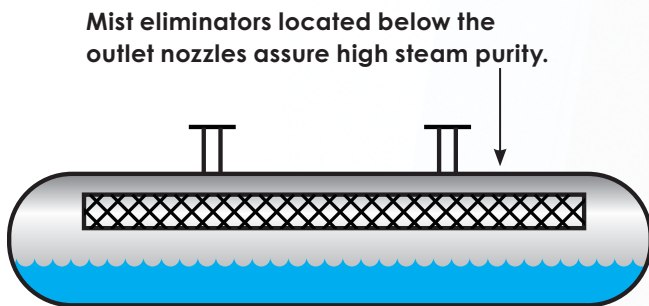

Figure 2. Typical steam drum.

Distillation Towers

Liquid entrainment can cause performance problems and limit capacity in packed and trayed distillation towers in two ways (shown in Figure 3).

- ▶ At intermediate draw-off trays, entrainment from below reduces product purity and can allow non-volatile contaminants into the draw-off liquid.
- ▶ The overhead gas product can also be contaminated with liquid entrainment.

In both cases, the problem is often misinterpreted as a problem with the trays or packing. In reality, it is a problem of entrainment, which can be solved by a properly designed mist eliminator.

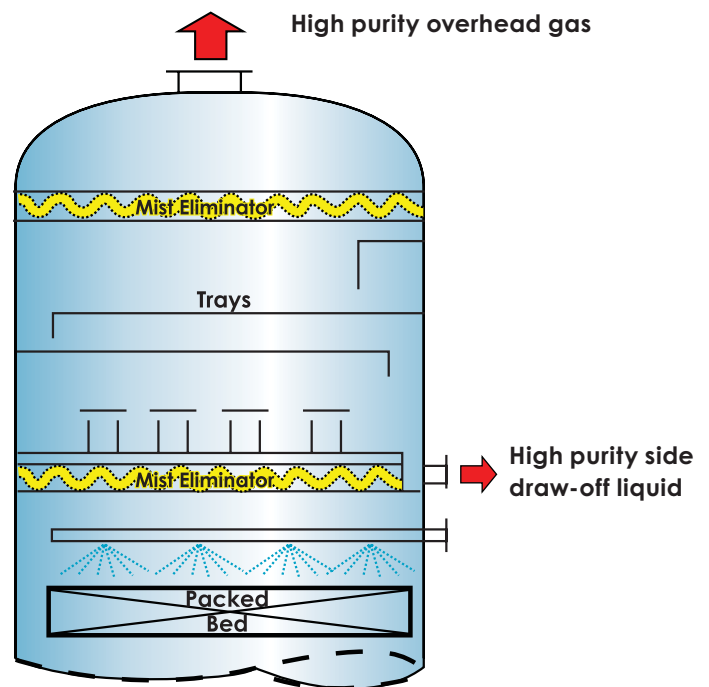

Figure 3. Distillation tower mist eliminators provide high purity overhead gas and liquid draw-off as well as higher tower capacity.

Scrubbers

From clean gas scrubbers and process vents to fouling services, such as flue gas desulfurization (FGD) systems or steel mill blast furnace exhausts, mist eliminators help improve efficiency and capacity. In severe services, high performance wash systems from Koch-Glitsch are specially engineered to meet the process requirements and considerably extend service life with minimum wash liquid usage.

Process Applications

Process industries use KOCH-OTTO YORK® mist eliminators wherever gas and liquid come into contact. Some of the major process applications are described below.

Refineries

Mist eliminators in fractionators increase throughput capacity and allow deeper cuts for greater yields.

- ▶ In atmospheric and vacuum pipestills, reduced entrainment from the wash oil zones allows deeper cuts and greater throughput.
- ▶ In downstream crackers and reformers, mist eliminators prolong catalyst life by reducing carbon and metals in side draws.



Fractionation tower in a major USA refinery.

Petrochemical Plants

Mist eliminators are used in the interstage knock-out drums of the compressor trains to extend compressor run length and service life. They are also used in quench towers to prevent contamination and protect downstream equipment.

Flue Gas Desulfurization

High capacity, low pressure drop FLEXICHEVRON® mist eliminators provide excellent resistance to fouling. Utility and industrial scrubbers throughout the world trust the reliable process and mechanical designs offered by Koch-Glitsch.

Gas Absorption Systems

Designers and operators of systems using glycols, amines and other proprietary solvents to remove water vapor, H₂S, CO₂ or other contaminants from gas streams often follow equipment specifications that have not been optimized to minimize losses of these expensive chemicals. Losses result from several causes, including the following:

- ▶ Carryover losses of absorption chemicals with the treated gas.
- ▶ Entrainment losses in the overhead gas from the regeneration towers.
- ▶ Foaming resulting from liquid hydrocarbon entrainment into the absorber.

Payback in most systems will be less than one month when upgrading from traditional mesh styles to higher efficiency DEMISTER® mist eliminator styles 822 or 82.

Sulfuric Acid Plants

Well-engineered mist eliminators are critical to the cost-effective operation of every sulfuric acid plant. In the drying, intermediate, and final absorption towers, poorly performing mist eliminators contribute to corrosion of ducting, blowers, heat exchangers, and vessels. Stack emissions can result in environmental non-compliance, fines, and potential closure.

Engineers at Koch-Glitsch are very familiar with the special design considerations required for sulfur burning, ore roasting, and sludge burning plants. We offer the latest technology in efficiency, safety, service life, and capacity.



Sulfuric acid plant using KOCH-OTTO YORK® mist elimination technology.

DEMISTER® Mist Eliminators

The DEMISTER® mist eliminator is an assembly of YORKMESH™ knitted mesh that is supported with high open area grids.

DEMISTER mist eliminators are made to any size and shape from a wide range of materials, both metal and non-metal. Stainless steels and exotic alloys are fully annealed to provide maximum corrosion resistance.

Based on years of actual in-plant performance, Koch-Glitsch engineers utilize special families of mesh styles for particular equipment and processes to meet customer efficiency requirements.

Benefits of DEMISTER® Mist Eliminators

- ▶ Easy to install in all process equipment
- ▶ Most cost-effective solution when equipment sizes are set by other requirements
- ▶ High efficiency with low pressure drop
- ▶ Emergency delivery available

Materials of Construction

- ▶ All 300 and 400 series SS
- ▶ Alloys 200, 400, 600, 800, and more
- ▶ Alloy 20
- ▶ Titanium
- ▶ Aluminum
- ▶ Copper
- ▶ Polypropylene
- ▶ Teflon®
- ▶ Halar®
- ▶ Kynar®
- ▶ And more . . .

For example, Alloy 66 is a specially designed material used to extend service life in sulfuric acid plants.

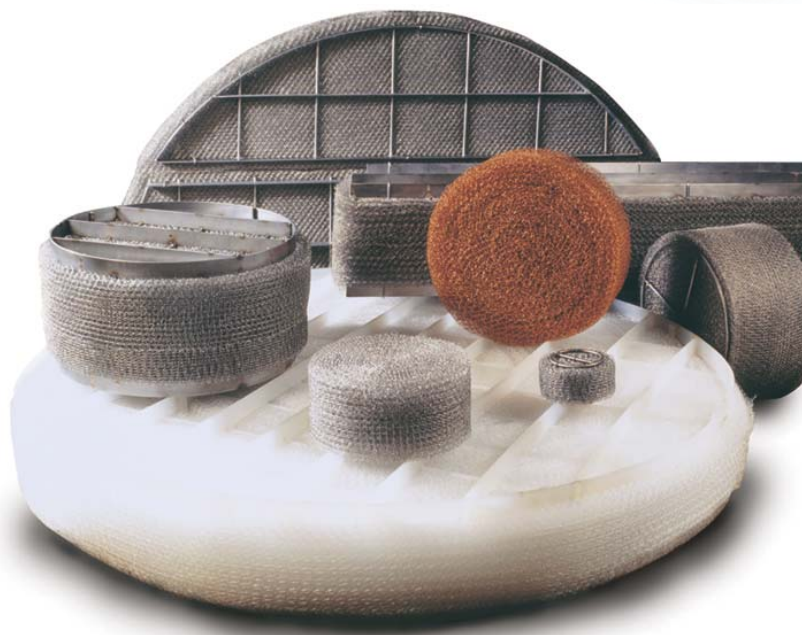

How a DEMISTER® Mist Eliminator Works

1. A vapor stream carrying entrained liquid droplets passes through a DEMISTER pad. The vapor moves freely through the YORKMESH knitted mesh.
2. The inertia of the droplets causes them to contact the wire surfaces and coalesce.
3. The large, coalesced droplets formed in the mesh ultimately drain and drop to the vessel bottom.

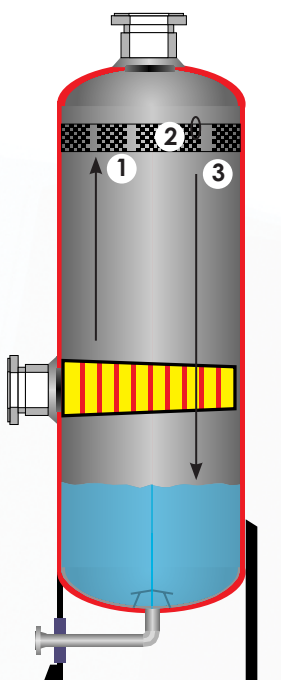

Figure 4. DEMISTER® Mist Eliminator.

Design Parameters

For general design, Equation 1 has been used as a velocity guideline for many years.

Equation 1

$$V = K \left[(\rho_L - \rho_V) / \rho_V \right]^{1/2}$$

	Metric	English
V - design velocity	m/sec	ft/sec
ρ_L - liquid density	Kg/m ³	lb/ft ³
ρ_V - vapor density	kg/m ³	lb/ft ³
K - capacity factor	m/sec	ft/sec

The recommended design value of "K" varies depending on several system factors, which include liquid viscosity, surface tension, entrainment loading, and the content of dissolved and suspended solids. Recommended "K" values are also highly dependent on the mesh structure and vessel geometry.

Over 50 years ago, Koch-Glitsch developed the traditional mist eliminator styles that became the worldwide standards in the chemical process industries. The industry adopted a standard guideline, $K = 0.107$ m/sec (0.35 ft/sec), for calculations based on these traditional KOCH-OTTO YORK styles (see Table 3). Newer, high capacity styles have been developed (also shown in Table 3). This development continues today.

Excellent performance is often obtained from 30-110% of the calculated design value. Operating pressure drop is usually negligible, < 25 mm water (1" WC). For high vacuum applications, high performance is routinely achieved with ΔP on the order of 2-3 mm water (0.1" WC).

State-of-the-Art DEMISTER® Mist Eliminators

In the 1990s, Koch-Glitsch developed and refined a new family of styles, replacing traditional styles that Otto York originally introduced shortly after founding the company in 1947.

These new styles take advantage of improved knowledge about the way internal wire geometry affects capacity and performance in the same way that structured packing surpassed random packing performance in distillation columns.

Compared to the older styles, the new KOCH-OTTO YORK® styles provide:

- ▶ 20% or more design capacity.
- ▶ 10 to 15% lower pressure.
- ▶ Higher efficiency at design velocity.
- ▶ Equal or better corrosion and fouling resistance.

Traditional Style	New Style	Capacity Gain	Efficiency Gain	Description
371	215	>35%	Same	Glass fiber & metal for maximum efficiency
326	194	>25%	Same	Ultra-efficiency design for fine particles
421	709	>20%	Same	Heavy duty, high efficiency design
431	172	>20%	Same	General purpose style
931	708	>22%	Same	High open area for viscous or dirty liquid

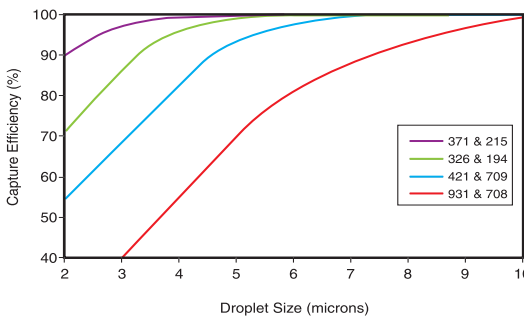

Figure 5. Comparative efficiencies of various DEMISTER® styles in air-water system at atmospheric conditions.

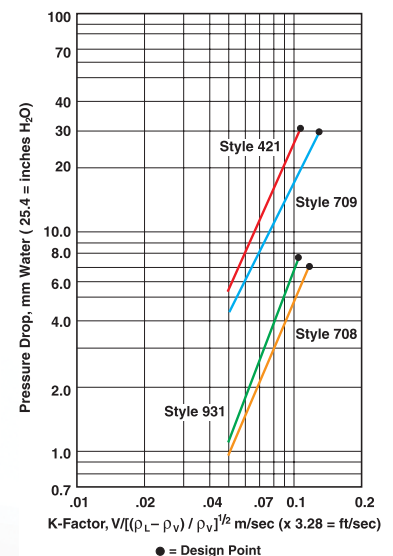

Figure 6. Comparative pressure drop of several DEMISTER® styles in air-water system at atmospheric conditions.

FLEXICHEVRON® Mist Eliminators

FLEXICHEVRON® mist eliminators are baffle or zigzag blade modules tailored for either vertical or horizontal flow installations.

These mist eliminators collect essentially 100% of all particles greater than 8 to 40 microns in diameter, depending on design parameters and operating conditions.

Manufactured in virtually any size from a wide range of metal alloys, thermal-set plastics and fiber-reinforced plastic (FRP), over 20 different styles can be designed and fabricated.

Applications for which FLEXICHEVRON mist eliminators are ideal include:

- ▶ Scrubbers in utility flue gas desulfurization (FGD) systems
- ▶ Phosphoric and sulfuric acid plants
- ▶ Crude oil refinery vacuum towers
- ▶ Pulp mill, sugar refinery, and chemical plant evaporators
- ▶ Upstream gas processing
- ▶ LNG plants

Benefits of FLEXICHEVRON® Mist Eliminators

- ▶ Ideal for applications where solids or viscous, sticky liquids rapidly plug a wire mesh type mist eliminator
- ▶ Usable in either vertical (upward) or horizontal flow designs
- ▶ Provide the lowest pressure drop of any type mist eliminator
- ▶ Handle high liquid loads
- ▶ Have good turndown characteristics

Materials of Construction

- ▶ Stainless steel
- ▶ Carbon steel
- ▶ Titanium
- ▶ Polypropylene
- ▶ FRP
- ▶ PVDF
- ▶ Polysulfone
- ▶ Other special materials available on request



Design Parameters

The reentrainment point is a function of gas velocity, as well as other physical properties, e.g., vapor density, liquid density, and liquid surface tension.

The reentrainment point is also highly sensitive to the geometry of the chevron. A chevron with superior liquid draining capability and optimum chevron blade spacing can be operated at a higher reentrainment point, yielding a higher capacity.

The difference between droplet penetration and reentrainment is often misunderstood. Droplets that penetrate the chevron are too small to be effectively removed by impaction. On the other hand, reentrained droplets are generally quite large and originate from droplets that have coalesced on the chevron blades.

At high gas velocities, a chevron can have a removal efficiency of 100% and, simultaneously, reentrain extensively. Conversely, at low gas velocities, the chevron may not reentrain but has poor removal. Optimal chevron performance is achieved at a gas velocity that is as high as possible but not so high that it yields reentrainment.

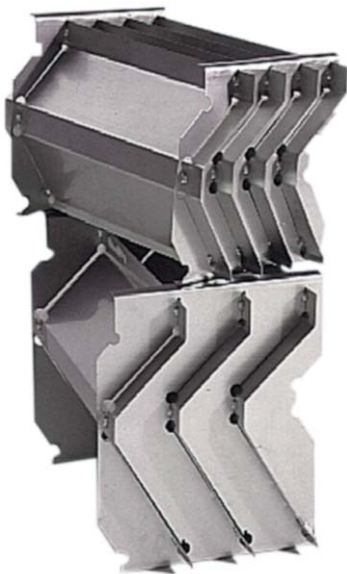

Patented FLEXICHEVRON® style XII/XIV mist eliminators are designed for high capacity FGD applications.

Optimum Design for Conventional FLEXICHEVRON® Mist Eliminators

In arriving at an optimum design, it is often necessary to make a compromise between removal efficiency on the one hand and pressure drop and plugging tendency on the other.

To do so, it is necessary to have some knowledge of the droplet-size distribution entering the FLEXICHEVRON mist eliminator. While exact inlet droplet-size distributions are seldom known, experienced Koch-Glitsch designers are familiar with most mist elimination applications. We will help you to understand the solutions available.

Koch-Glitsch has established proprietary know-how through application of extensive air-water testing, computational fluid dynamic (CFD) simulation, and commercial data confirmations. Let us apply our proprietary knowledge to provide solutions to your specific mist elimination problems.

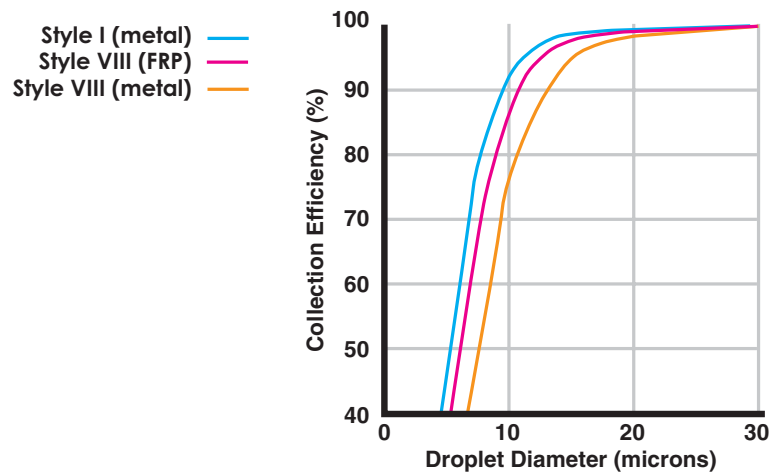

Figure 7. Typical collection efficiency vs. droplet size of a FLEXICHEVRON® mist eliminator in air-water system at atmospheric conditions.

Applications

FLEXICHEVRON mist eliminators should be used any time that plugging of wire mesh mist eliminators is a risk. These applications include:

- ▶ All types of air pollution control scrubbers where dissolved or undissolved solids can be present.
- ▶ Applications where droplets will be sticky or viscous and will plug classic wire mesh mist eliminators. This would especially be true in many petrochemical applications.
- ▶ High vacuum applications, such as evaporators and vacuum crude units, where minimum pressure drop is critical.

High Capacity FLEXICHEVRON® Mist Eliminators

Special designs are needed for higher pressure systems. The FLEXICHEVRON® style 250 and 350 mist eliminators rely primarily on separate liquid drainage channels for their high capacity.

Horizontal and Vertical Flow Designs

Style 250 and 350 designs offer:

- ▶ Higher allowable velocities
- ▶ Different vane geometries

This results in more efficient mist removal, especially at higher pressures where the allowable velocity decreases with the increasing gas density.

The unique characteristic of the style 250 or 350 designs is their “double pocket” construction as illustrated in Figures 8 and 9.

Strategically located slots allow coalesced liquid on the blade surfaces to be collected and directed into internal channels shielded from the gas flow. Once inside these channels, the collected liquid is then directed to drains that lead to the liquid sump in the bottom of the vessel.

Compared to the unshielded single pocket designs, they also provide higher turndown before noticeable efficiency losses are experienced.



FLEXICHEVRON® style 250 high capacity mist eliminator for horizontal gas flow.

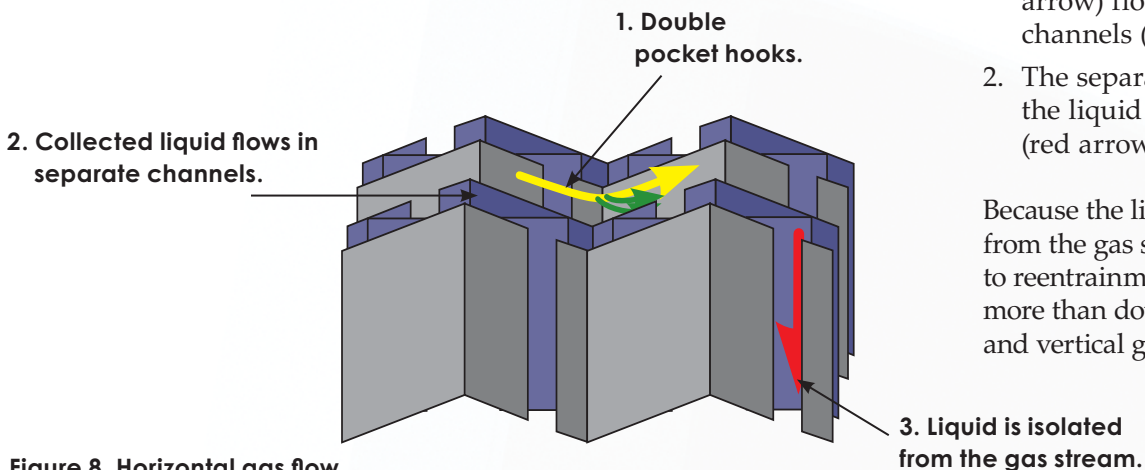

Figure 8. Horizontal gas flow.

Benefits of High Capacity FLEXICHEVRON® Mist Eliminators

- ▶ Custom engineered to fit any vessel shape
- ▶ Allows reduced vessel sizes and weights
- ▶ Sturdy, durable construction
- ▶ Efficiency maintained at higher pressures

Materials of Construction

- ▶ Carbon steel
- ▶ All 300 and 400 series stainless steel
- ▶ Alloy 400
- ▶ Alloy 200
- ▶ Alloy 20
- ▶ Titanium
- ▶ Many other materials available on request

How a High Capacity FLEXICHEVRON® Mist Eliminator Works

Double pocket hooks direct the collected liquid (green arrow) away from the main gas stream (yellow arrow).

1. The collected liquid (green arrow) flows into separate channels (purple).
2. The separate channels move the liquid away from the gas (red arrow).

Because the liquid is now isolated from the gas stream and less subject to reentrainment, gas velocities can be more than doubled in both horizontal and vertical gas flow configurations.

Design Parameters

As with other types of mist eliminators, selection of the proper FLEXICHEVRON mist eliminator is affected by:

- ▶ Gas and liquid properties
- ▶ Pressure
- ▶ Quantity of entrainment and solids
- ▶ Desired performance

To make a preliminary selection:

1. Determine actual velocity by using Equation 1 (as described on page 6).
2. Choose K values based on Table 3 below.

The table shows capacity and turndown ratios achievable with reasonable efficiency for high capacity designs.

Vane Type	Operating K Value (through vane)	
	Minimum	Maximum
Style 250: Horizontal Flow High Capacity	0.04 (0.12)	0.35 (1.15)
Style 350: Vertical Up Flow High Capacity	0.04 (0.12)	0.35 (1.15)
K-value in m/s (ft/s).		

Performance of High Capacity FLEXICHEVRON® Mist Eliminators in Air/Water System

Using double pocket FLEXICHEVRON mist eliminators, it is possible to efficiently remove droplets smaller than 10 microns in diameter in clean service even at higher pressures.

Figures 10 and 11 show the performance of typical designs in an air/water system. Actual droplet size separation efficiency in other systems will be affected by gas velocity, liquid and gas densities, and liquid surface tension.

High pressure testing indicates that the separation efficiency of any vane type mist eliminator decreases as operating pressures increase. At operating pressures above 800 psig (55 bar), the use of cyclonic type mist eliminators is recommended.

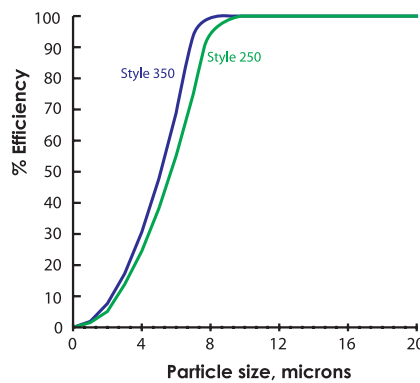

Figure 10. Comparative efficiencies in air-water system at atmospheric conditions.

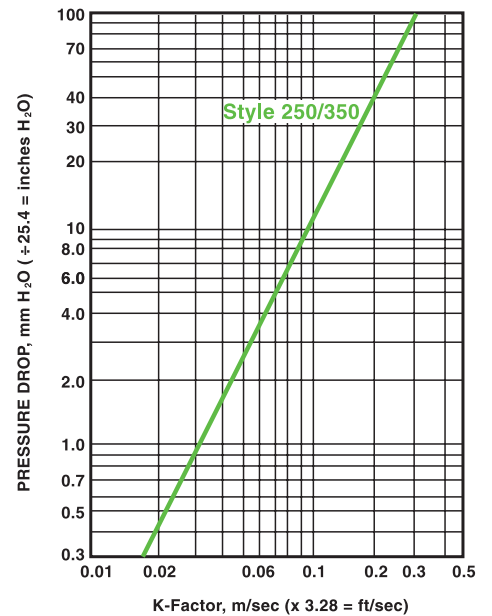

Figure 11. Comparative pressure drop in air-water system at atmospheric conditions.

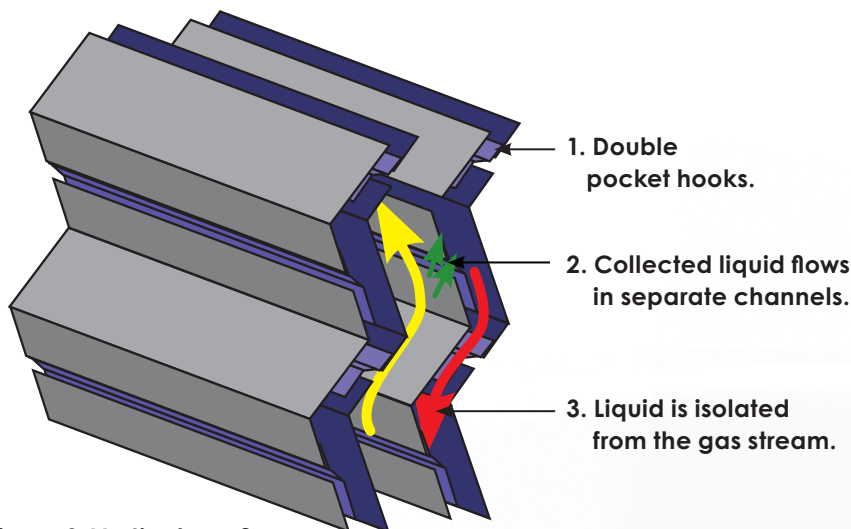

Figure 9. Vertical gas flow.



FLEXICHEVRON® style 350 high capacity mist eliminator for vertical gas flow.

FLEXIFIBER® Mist Eliminators

The custom-designed and fabricated FLEXIFIBER® mist eliminators consist of a packed fiberbed between either two concentric screens or two flat parallel screens.



Depending upon design parameters, FLEXIFIBER mist eliminators collect up to 99.95% or greater of all sub-micron liquid particles.

This style of mist eliminator has proven ideal for use in the following applications.

- ▶ Sulfuric, nitric and thermal phosphoric acid plants
- ▶ Chlorine and other chemical plants
- ▶ Pulp mills
- ▶ Textile mills
- ▶ Asphalt saturators
- ▶ Food processing operations
- ▶ Chrome plating processes
- ▶ Turbine lube oil tank vents
- ▶ Plastic forming operations

Benefits of FLEXIFIBER® Mist Eliminators

- ▶ Capture sub-micron mist particles 0.1 microns or smaller
- ▶ Reduce or eliminate visible stack gas plumes
- ▶ Provide unlimited turndown from design capacity
- ▶ Achieve guaranteed pressure drop less than 40 mm (1.5 in) W.G.
- ▶ Interchange with existing fiberbed equipment

Materials of Construction

Cages

- ▶ Wide variety of metal alloys
- ▶ Thermal-set plastics
- ▶ FRP

Packed Fiberbeds

- ▶ Special glass
- ▶ Ceramic
- ▶ Polypropylene
- ▶ PFTE
- ▶ Polyester fiber
- ▶ Special carbon fiber media is available for those applications that contain fluorides, high pH, or steam.

How a FLEXIFIBER® Mist Eliminator Works

1. Mist-laden gases pass horizontally through the fiberbed.
2. Separated liquids drain downward on the inside surface of the element, through the drain leg, and are collected at the bottom of the vessel.
3. Clean gases exit at the top of the vessel.

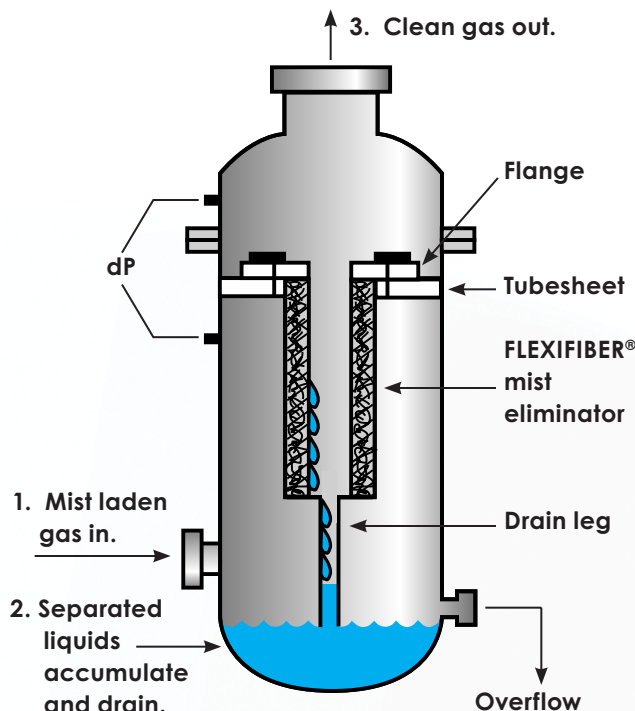

Figure 12. FLEXIFIBER® Mist Eliminator.

Typical FLEXIFIBER® Mist Eliminator Installation

Figure 12 shows a typical FLEXIFIBER mist eliminator installation. Basic components of this system are the FLEXIFIBER element and vessel. The element consists of two concentric cylindrical screens containing packed fibers in the annular space. The screens are connected to a flange at the top of the element and an end plate on the bottom of the element. The flange, in turn, is bolted to the vessel sheet.

Separation Mechanisms

Koch-Glitsch offers three types of FLEXIFIBER mist eliminators that are based on the type of mechanism for separation, as shown in Figure 13 below.

A comparison of the separation mechanisms is shown in Table 4.

Inertial Impaction

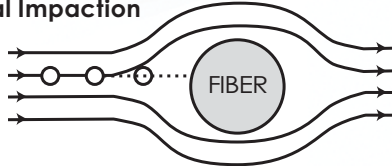

Brownian Diffusion

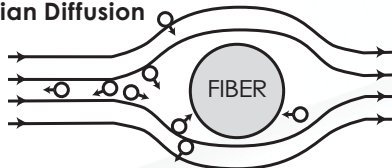

Direct Interception

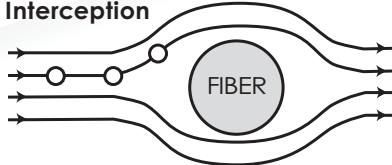

Figure 13. Mechanisms for mist collection on fibers.

FLEXIFIBER® Type BD (Brownian Diffusion) and Type BD-LdP (Low Pressure Drop) Mist Eliminators

Type BD elements are normally cylindrical in shape and are available in a wide variety of materials.

Utilizing the Brownian Diffusion mechanism, the Type BD element is able to achieve collection efficiencies of up to 99.95% or higher on all submicron liquid particles even below 0.1 microns. Operating pressure drops are normally designed in the range of 50 to 500 mm (2-20 in.) W.G.

An interesting feature of the FLEXIFIBER Type BD mist eliminator is that, with submicron particles, the collection efficiencies are actually increased slightly as the gas flow rate through the bed is reduced. At reduced gas flow rates, the mist particles have a longer residence time in the fiberbed. This provides the liquid particles with an increased chance to contact individual fibers and be collected.

FLEXIFIBER Type BD-LdP fiberbed is a new product developed by Koch-Glitsch that increases submicron particle collection efficiency while at the same time reducing pressure drop when compared to conventional fiberbed technology. Where fiberbeds are large consumers of energy, such as is the case in chlorine and sulfuric acid production trains, this results in significant reductions in operating costs. In addition to the specific processes cited above, this technology can bring benefits to any process in the form of decreased investment and operating costs, as well as improved plant performance.

Type	Primary Collection Mechanism	Collection Efficiency		Element Pressure Drop mm W.G. (Inches W.G.)	Bed Velocity m/sec (ft./min.)
		Particle Size (Microns)	Efficiency* (%)		
BD	Brownian Diffusion	>3	Essentially 100	50 - 500 (2-20)	0.03 - 0.2 (5 - 40)
		<3	Up to 99.95+		
IC	Impaction Cylinder	>3	Essentially 100	100 - 250 (4 - 10)	1.3 - 1.8 (250 - 350)
		1 - 3	95 - 99+		
IP	Impaction Panel	1 - 3	85 - 97	125 - 180 (5 - 7)	2.03 - 2.54 (400 - 500)
		0.5 - 1	50 - 85		

FLEXIFIBER Type IC (Impaction Cylinder) Mist Eliminator

Utilizing primarily the impaction mechanism, Type IC fiberbeds are designed to economically capture and collect particles in the 1 to 3 microns range. Collection efficiencies on 1 micron particles will vary from 90% on liquid mists with a specific gravity of 1.0 to 97% on liquid mists with a specific gravity of 1.8. Operating pressure drops are usually in the range of 100-250 mm (4-10 in.) W.G.

FLEXIFIBER Type IC-M, IC-K and IC-KLF Mist Eliminators

FLEXIFIBER Type IC-M and IC-K fiberbeds are specially designed to meet the needs of today's sulfuric acid plants. FLEXIFIBER Type IC-M is an alternative to Type BD in both the drying and absorption towers, offering a combination of both high capacity and efficiency. FLEXIFIBER Type IC-K and our newly introduced Type IC-KLF combine our knitted wire mesh and fiberbed technologies to produce extended life mist eliminators that are less inclined to foul with solids. This results in both energy savings as well as longer run lengths in critical services such as sulfuric acid drying towers.

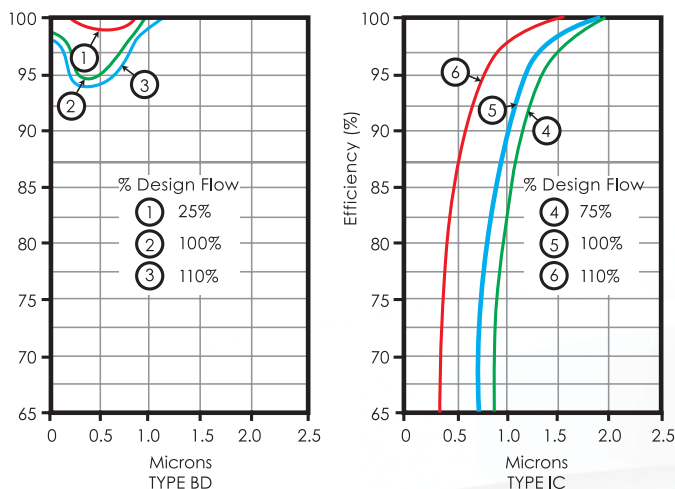

Figure 14. Typical performance curves for FLEXIFIBER® mist eliminator types BD and IC in air-DOP system at atmospheric conditions.

Cyclone Mist Eliminators

Cyclone mist eliminators consist of multiple cyclone tube elements, mounted into a housing. The element diameter is selected based on process considerations. The units are provided in easily handled subassemblies, which are installed through vessel manways.

Extremely High Gas Capacity

The most important benefits of this design are its very high gas handling capacity combined with excellent droplet removal efficiency even at elevated pressures.

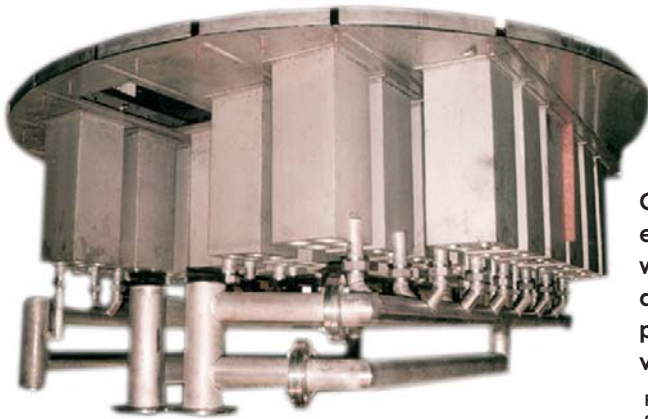

Cyclone mist eliminator assembly with mounting deck and liquid drain piping for a vertical vessel.

Picture courtesy of CDS Separation Technology.

New Construction

In new construction of high pressure separators, cyclone mist eliminators often provide the lowest overall cost solution by minimizing the diameter and height requirements of the vessel.

These very significant vessel size and weight reductions may lead to faster vessel delivery, lower transportation costs, and installation cost savings.

Retrofits

In retrofits, where significant additional capacity is required, cyclone mist eliminators extend the gas capacity well beyond any other mist elimination technology.



Cyclone mist eliminator assembly is designed for retrofitting a horizontal vessel, including housing and liquid collection piping.

Picture courtesy of CDS Separation Technology.

Benefits of High Capacity Cyclone Mist Eliminators

- ▶ Minimizes new vessel diameter and weight, which is particularly important in high pressure applications
- ▶ Ideal for debottlenecking existing separator capacity upgrades
- ▶ High efficiency separation of <10 micron droplets, even at high pressures
- ▶ High gas turndown
- ▶ Easily installed through vessel manways

Materials of Construction

- ▶ All common metal alloys

Design Parameters

The design and selection of cyclone mist eliminators are based on:

- ▶ Gas and liquid properties
- ▶ Liquid and solids loadings
- ▶ Desired efficiency and pressure drop

Computer simulations provide reliable models at other process conditions. Compared to other designs, the capacity per element is much higher with cyclone mist eliminators.

How a Cyclone Mist Eliminator Works

Cyclone mist eliminators are designed for maximum capacity. The recycled gas purge stream prevents reentrainment.

1. The gas and mist enter the cyclone inlet and flow through a swirl element that imparts a very high centrifugal force. The droplets are flung outward and are coalesced into a liquid film on the cyclone inner wall.
2. This liquid film is purged out of the cyclone through slits in the wall (blue arrow), along with a small portion of the gas flow, into an outer chamber where most of the gas and liquid separate.
3. The gas, along with some remaining mist, is educted back into a low pressure zone of the cyclone (yellow arrow) and the remaining entrainment is removed.
4. The gas is discharged from the top (orange arrow).
5. The liquid is drained from the bottom.

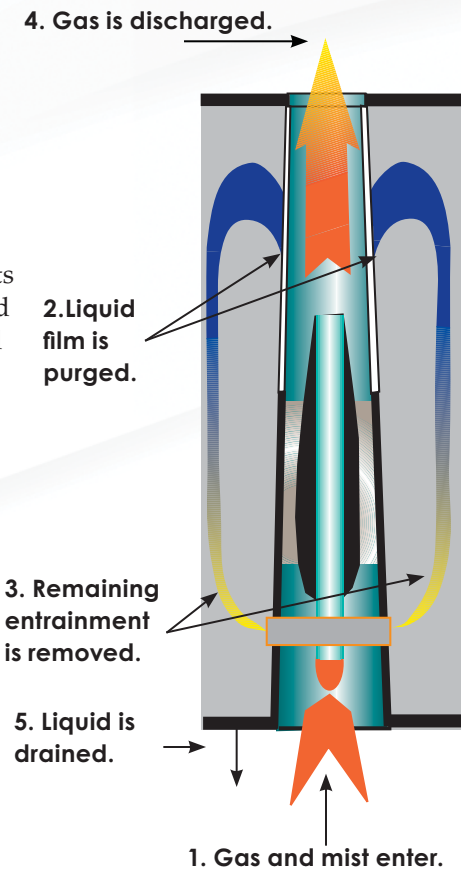

Figure 15. Cylone Mist Eliminator.

Typical horizontal and vertical configurations

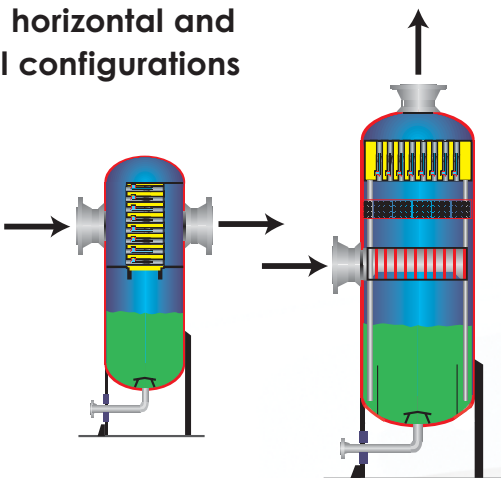

Figure 16. The gas flow through the cyclone mist eliminator can be either horizontal or vertical.

Droplet Removal Efficiency Testing

Extensive testing in high pressure test rigs has proven that the droplet removal efficiency of traditional vane pack mist eliminators drops off as pressures increase. Performance is often unacceptable at pressures above 800 psig (55 bar).

- ▶ In a vane, as the gas density increases due to higher pressures, the inertial force applied to droplets decreases because of the lower allowable design velocity.
- ▶ With cyclones, the centrifugal force applied to remove the droplets remains high, maintaining performance as gas density increases.

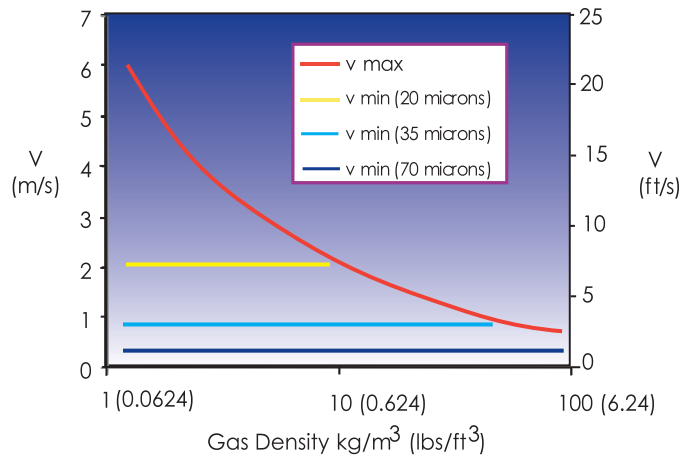

Figure 17. Effect of gas density on the removal efficiency of a traditional vane pack. The minimum velocity required to separate a given droplet size is shown. This velocity is limited by the red vane maximum capacity line.

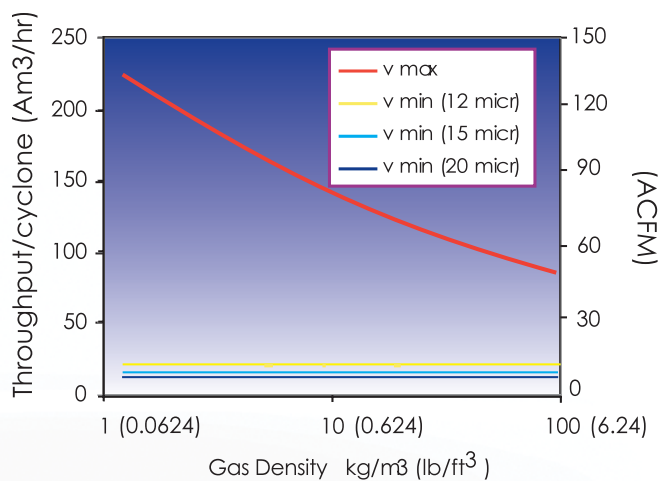

Figure 18. Gas density has no significant effect on the removal efficiency of a cyclone mist eliminator.

DEMISTER-PLUS™ Mist Eliminators

The DEMISTER-PLUS™ mist eliminator is an advanced engineering design that is often used to minimize the size of new vessels or to reuse existing vessels when plants are revamped for additional capacity.

High Capacity, Two-Stage Mist Eliminator

The advanced design DEMISTER-PLUS mist eliminator can achieve even greater increases in capacity over the high capacity DEMISTER® mist eliminator. The well-proven DEMISTER-PLUS design features a two-stage mist eliminator, combining the efficiency of the DEMISTER mist eliminator with the high throughput capacity of the FLEXICHEVRON® vane-type mist eliminator or cyclone mist eliminator.

- ▶ In new plant construction, these designs reduce knockout drum investment substantially while maintaining separation efficiency. Vessel diameter can usually be reduced by 25 to 40% and, because the shell thickness is a function of diameter, vessel weight can be reduced by 50 to 75%.
- ▶ In revamp situations, more than 300% capacity gain can be achieved, depending on the existing vessel geometry.
- ▶ When needed, revamp modifications can be accomplished without welding.

Designing for More Capacity

In most process installations, vessel size is determined by needs other than mist eliminator capacity, such as:

- ▶ Capacity of trays or packing
- ▶ Evaporator volume requirements
- ▶ Liquid holdup requirements

In these cases, traditional mist eliminator designs will readily meet the capacity.

In some equipment, particularly in knockout drums, the vessel size is set by the requirements of the mist eliminator itself.

When plants are revamped for additional capacity, it is almost always more economical to reuse existing vessels rather than replace them with larger equipment.

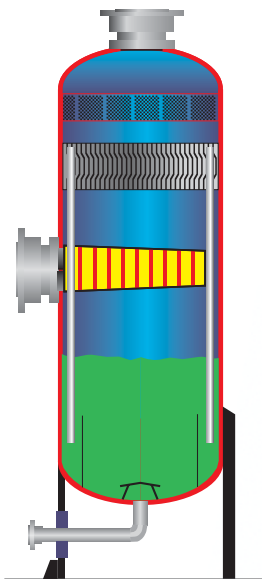

Figure 19. Vertical flow DEMISTER-PLUS™ type VM-V combines the high liquid handling capacity of a FLEXICHEVRON® vane mist eliminator with the high efficiency of a DEMISTER® mesh mist eliminator.

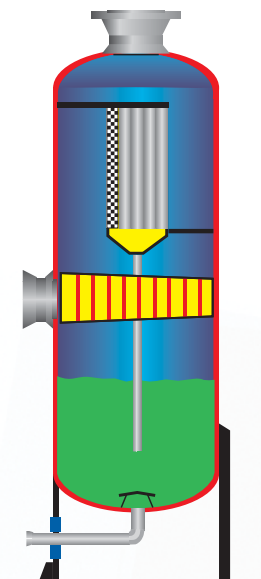

Figure 20. Horizontal flow DEMISTER-PLUS™ type MV-H mist eliminator designs allow substantial increases in throughput capacity in any knockout or flash drum.

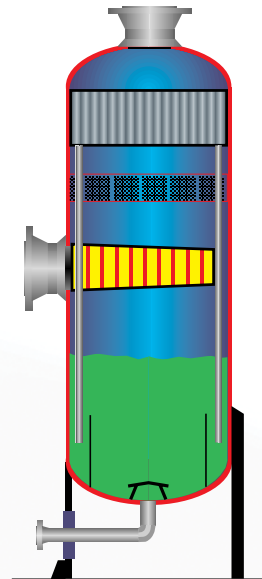

Figure 21. Vertical flow DEMISTER-PLUS™ type MV-V mist eliminators use high capacity FLEXICHEVRON® collectors for higher efficiency at increased capacity.

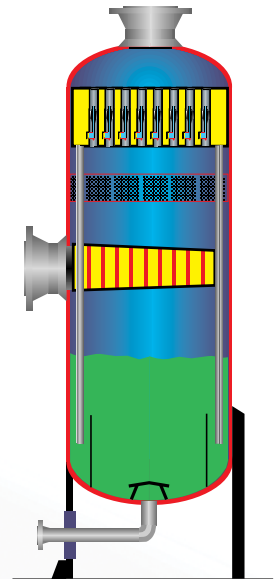

Figure 22. Vertical flow DEMISTER-PLUS™ type MC-V mist eliminators use cyclone mist eliminators for maximum capacity increases particularly in high pressure applications.

YORK-EVENFLOW™ Vane Inlet Device

The YORK-EVENFLOW™ inlet distribution device decreases the momentum of the inlet feed in a controlled manner.

Uniform Feed Distribution

Inlet nozzles are a common problem area in retrofitting situations because under-designed inlet distributors allow localized high velocities, which create severe liquid entrainment. The high gas flow volumes at the inlet nozzle create poor gas distribution in crowded drums or distillation towers.

The YORK-EVENFLOW inlet gas distribution device decreases the momentum of the inlet feed stream in a controlled manner, which allows:

- ▶ Removal of bulk liquid and solids.
- ▶ Even distribution of the gas flow over the downstream mist elimination devices.
- ▶ Minimization of droplet shatter, which prevents creation of additional fine entrainment.
- ▶ Reduction of gas velocities flowing over the liquid surface below the feed point, which prevents reentrainment of previously collected liquid caused by shear on the liquid surface.

The picture shows the view through the inlet nozzle of a vertical scrubber equipped with a YORK-EVENFLOW inlet device. The design and operating performance is superior to traditional baffles or dished splash plates.

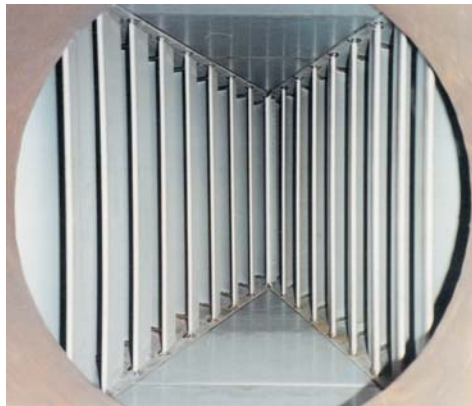

Figures 23 and 24. CFD studies confirm the benefits of uniform feed distribution provided by the YORK-EVENFLOW™ distributor.

Benefits of YORK-EVENFLOW™ Vane Inlet Device

- ▶ Evenly distributes the vapor to reduce channeling
- ▶ Gradually reduces high inlet momentum
- ▶ Diverts high liquid loads away from the mist eliminator
- ▶ Prevents reentrainment of liquid droplets from the surface below the feed point
- ▶ Modular construction allows installation through vessel manways
- ▶ Custom engineered for vertical or horizontal vessels

Materials of Construction

- ▶ All common metal alloys

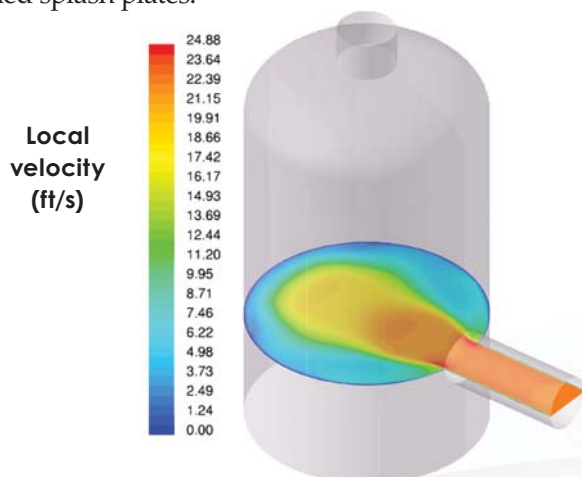

Figure 23. Localized velocity patterns with a plain nozzle inlet.

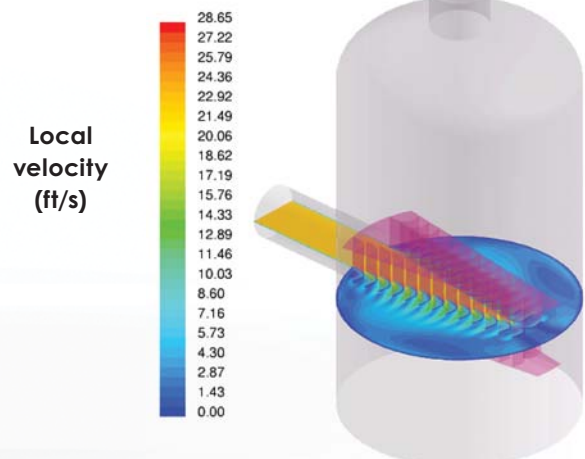

Figure 24. Localized velocity patterns with the YORK-EVENFLOW™ distributor.

Computational Fluid Dynamics Modeling

Computational Fluid Dynamics (CFD) is a reliable tool used for design optimization, troubleshooting, and product development.

Flow distribution is critical in all gas-liquid and liquid-liquid separation vessels. As vessel sizes are reduced, or more capacity is expected from existing equipment, traditional design rules for vessel geometry and flow distribution must be reviewed for all elements that can affect separation performance, such as:

- ▶ Flow velocities through inlet and outlet nozzles
- ▶ Spacing between nozzles
- ▶ Internals
- ▶ Liquid levels

CFD modeling is used by engineers at Koch-Glitsch to simulate flow conditions and vessel geometry. The modeling provides a close approximation of the fluid flow profile inside the vessel.

- ▶ For existing installations, poor flow distribution can be identified as the cause of unexpected high liquid carryover.
- ▶ In retrofit situations where the process conditions may be increasing, design modifications can be evaluated and optimized with high assurance that the desired performance will be achieved.
- ▶ For new equipment, optimized CFD designs result in size and weight reductions that provide savings beyond the lower cost of the separator. In addition to reduced vessel cost, there are usually associated savings in foundations and support structures.

The case illustrated below was a study of the velocity patterns inside a critical separator vessel operating under vacuum. For optimum performance, it was important that the velocity profile through the mist eliminator be uniform. The CFD study confirmed this to be the case.

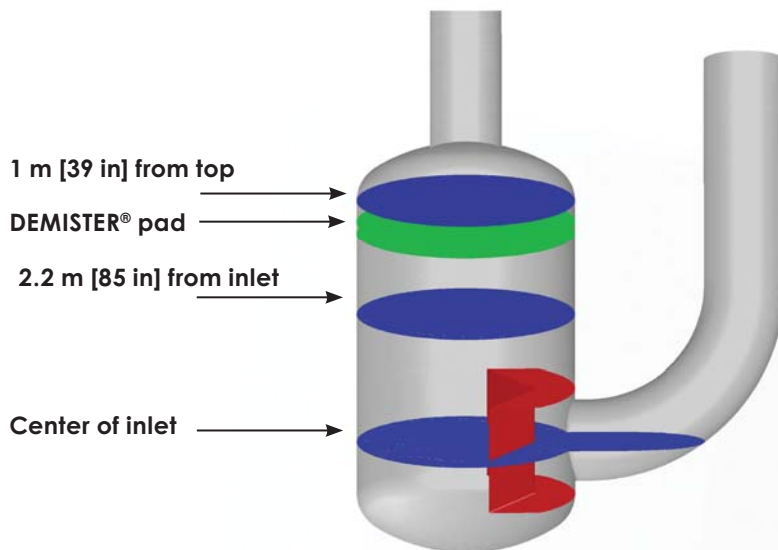

Figure 25. Model geometry including the V-baffle (red), mesh pad (green), and view planes (blue). The view planes are located in the center of the inlet, 2.2 m [85 in] from the center of the inlet, and 1 m [39 in] from the top of the vessel.

Benefits of CFD Modeling

- ▶ Design optimization
- ▶ Troubleshooting
- ▶ Product development
- ▶ Approximation of the fluid flow profile inside a vessel

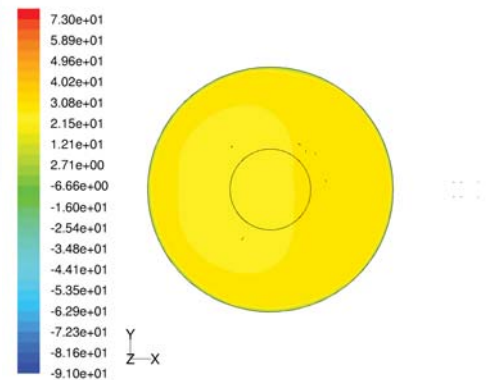

Figure 26. Contours of vertical velocity (ft/sec) located at the bottom of the mist eliminator.

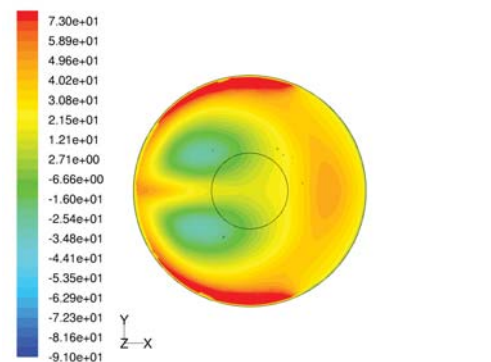

Figure 27. Contours of vertical velocity (ft/sec) located approximately 2.2 meters from the inlet.

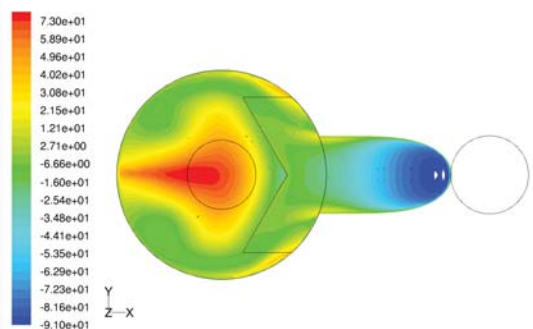
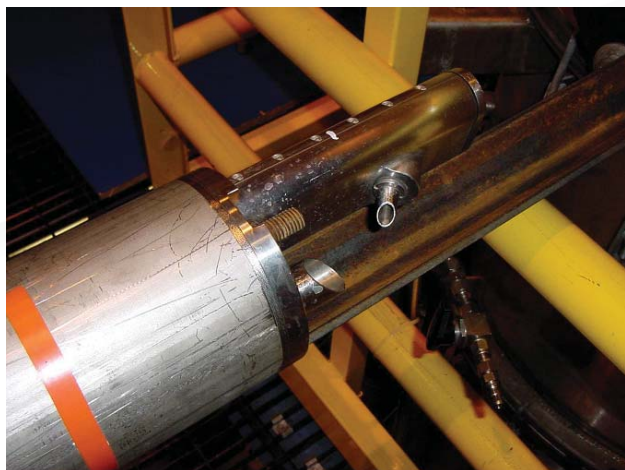

Figure 28. Contours of vertical velocity (ft/sec) on the view plane located at the center of the inlet pipe.

State-of-the-art Separations Technology

The future of an organization is its research and development department. With innovative thinking, practical knowledge, and tremendous depth and breadth of expertise, we are among the industry's leaders in our commitment to research and development to answer the challenges of this century.

While our separations technology is significantly ahead of that available five or ten years ago, we know there is much yet to be learned. At Koch-Glitsch, funding research for product development is critical to meeting our customers' needs.



State-of-the-art Phase Doppler Particle Analyzer (PDPA) is used to measure both size and quantity of droplets during mist eliminator testing. The measuring equipment uses computer linked laser systems to allow rapid and accurate data collection on new concepts.

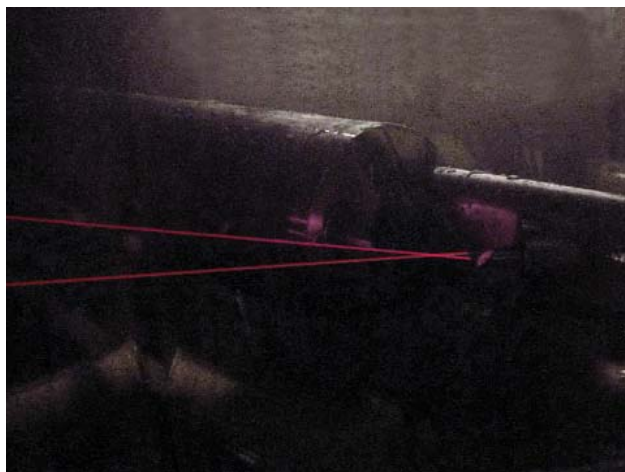

Crossing laser beams of the PDPA to measure droplet size and concentration during a test of FLEXICHEVRON® mist eliminators.

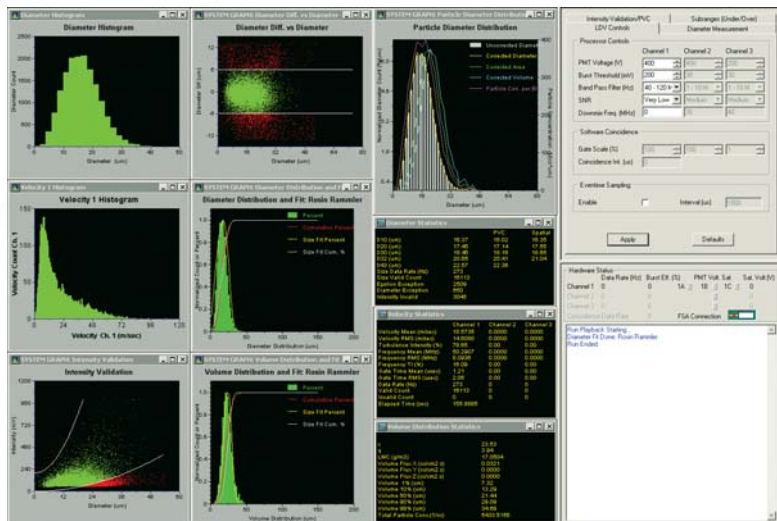

Computer logging of the data collected by the PDPA. During each run, several thousand individual droplets are counted and sized to produce droplet distribution curves as shown here.



These two test towers are devoted to the research and development of new FLEXIFIBER® mist eliminator designs. The latest BD-LdP low pressure drop designs came from test work performed in these towers.

Koch-Glitsch Corporate Offices

Worldwide Headquarters

Koch-Glitsch, LP

4111 East 37th Street North | Wichita, KS 67220 - USA | tel: (316) 828-7181 | fax (316) 828-8018

North American Offices

Koch-Glitsch, LP

Koch-Otto York Separations Technology

6611 Killough Road | Houston, TX 77086 - USA | tel: (800) 736-7036 | fax (281) 445-7032

4111 East 37th Street North | Wichita, KS 67220 - USA | tel: (316) 828-7181 | fax (316) 828-8018

European Offices

Koch-Glitsch B.V.B.A.

Koch-Otto York Separations Technology

Bijkhoevelaan 12 | 2110 Wijnegem - Belgium | tel: + 32 3 647.28.47 | fax + 32 3 647.28.79

Koch-Glitsch Italia, S.r.l.

Koch-Otto York Separations Technology

Viale Giulio Cesare 29 | 24124 Bergamo - Italy | tel: + 39 035 227 35 61 | fax + 39 035 227 34 00

Web Site

www.koch-ottoyork.com

Emergency Numbers

United States: 316-207-7935

Europe: +32 3 641 65 86

Trademarks

DEMISTER, FLEXICHEVRON, FLEXIFIBER, KOCH-OTTO YORK, KOCH-GLITSCH and OTTO YORK and design (Football) are registered trademarks of Koch-Glitsch, LP.

YORKMESH, YORK-EVENFLOW and DEMISTER-PLUS are trademarks of Koch-Glitsch, LP.

Teflon is a registered trademark of E.I. DuPont de Nemours.

Halar is a registered trademark of Ausimont.

Kynar is a registered trademark of Elf Atochem.

All data in this brochure are for general information only and are based on tests carried out under conditions which may or may not apply to your requirements. No warranties or guarantees are expressed or implied. No information contained in this brochure constitutes an invitation to infringe any patent, whether now issued or issued hereafter. All descriptions and specifications are subject to change without notice.