

# mixing of fluids

Levenspiel [2] considered when two fluids are mixed together, the molecular behavior of the dispersed fluid falls between two extremes. If molecules are completely free to move about, the dispersed fluid behaves as a microfluid and exhibits no fluid segregation. At the opposite extreme, the dispersed fluid remains as clumps containing a large number of molecules and is termed a macrofluid. Furthermore, as the macrofluid is transformed to a microfluid by physical mixing processes (e.g., turbulence or molecular diffusion), the degree and scale of segregation (i.e., the average of the segregated clumps) decrease.

An important mixing operation involves bringing different molecular species together to obtain a chemical reaction. The components may be miscible liquids, immiscible liquids, solid particles and a liquid, a gas and a liquid, a gas and solid particles, or two gases. In some cases, temperature differences exist between an equipment surface and the bulk fluid, or between the suspended particles and the continuous phase fluid. The same mechanisms that enhance mass transfer by reducing the film thickness are used to promote heat transfer by increasing the temperature gradient in the film. These mechanisms are bulk flow, eddy diffusion, and molecular diffusion. The performance of equipment in which heat transfer occurs is expressed in terms of forced convective heat transfer coefficients.

This chapter reviews the various types of impellers, the flow patterns generated by these agitators, correlation of the dimensionless parameters (i.e., Reynolds number, Froude number, and Power number), scale-up of mixers, heat transfer coefficients of jacketed agitated vessels, and the time required for heating or cooling these vessels.

---

## MIXING AND AGITATION OF FLUIDS

---

Many operations depend to a great extent on effective mixing of fluids. Mixing refers to any operation used to change a non-uniform system into a uniform one (i.e., the random distribution of two or more initially separated phases); agitation implies forcing a fluid by mechanical means to flow in a circulatory or other pattern inside a vessel. Mixing is an integral part of chemical or physical processes

such as blending, dissolving, dispersion, suspension, emulsification, heat transfer, and chemical reactions.

Dispersion characteristics can be considered as the mixing of two or more immiscible liquids, solids and liquids, or liquids and gases, into a pseudo-homogeneous mass. Small drops are created to provide contact between immiscible liquids. These liquids are mixed for specific purposes, namely solvent extraction, removal or addition of heat, and to affect mass transfer rates in reactors. The terms dispersion and emulsion are often used interchangeably. Dispersion is a general term that implies distribution, whereas emulsion is a special case of dispersion. Dispersion is a two-phase mixture in which drops may coalesce. The material present in a larger quantity is referred to as the continuous phase and the material present in a smaller quantity is called the dispersed phase. An emulsion is a two-phase mixture of very fine drops in which little or no coalescence occurs. The stability of an emulsion depends on surface ion activity, which is a function of particle size. Common dispersions are water and hydrocarbons, and acidic or alkaline solutions combined with organic liquids. Table 8-1 summarizes the principal purposes for agitating fluids.

## AGITATION EQUIPMENT

Various types of vessels and tanks of differing geometrical shapes and sizes are used for mixing fluids. The top of the vessel may be open or sealed, the vessel bottom is normally not flat

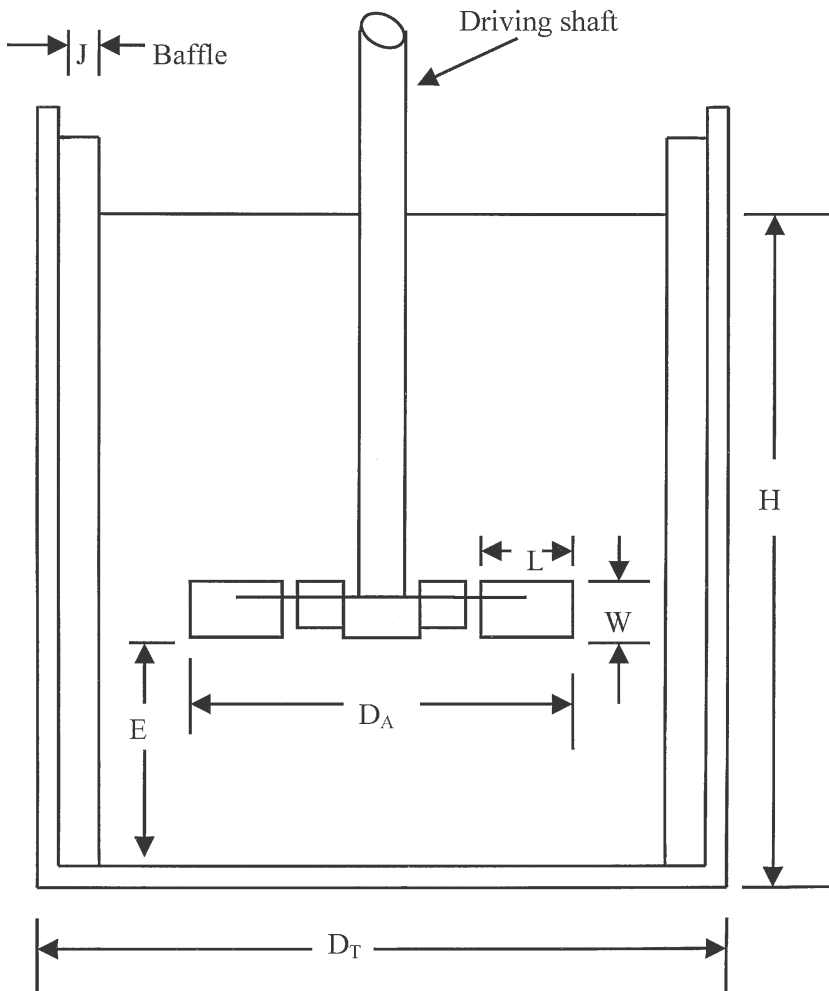
**Table 8-1**

### **Characteristics for agitating fluids**

---

1. Blending of two miscible or immiscible liquids.
  2. Dissolving solids in liquids.
  3. Dispersing a gas in a liquid as fine bubbles (e.g., oxygen from air in a suspension of microorganism for fermentation or for activated sludge treatment).
  4. Agitation of the fluid to increase heat transfer between the fluid and a coil or jacket.
  5. Suspension of fine solid particles in a liquid, such as in the catalytic hydrogenation of a liquid where solid catalyst and hydrogen bubbles are dispersed in the liquid.
  6. Dispersion of droplets of one immiscible liquid in another (e.g., in some heterogeneous reaction process or liquid-liquid extraction).
-

but rounded to eliminate sharp corners or regions into which the fluid currents would not penetrate; dished ends are most common. The liquid depth is approximately equal to the diameter of the tank. An impeller is mounted on an overhung shaft, (i.e., a shaft supported from above). The shaft is motor driven; this is sometimes directly connected to the shaft, but is more often connected through a speed-reducing gearbox. Other attachments include inlet and outlet lines, coils, jackets, and wells for thermometers. Figure 8-1 shows a typical standard tank configuration.



**Figure 8-1.** Standard tank configuration.

configuration. The geometric proportions of the agitation system, which are considered a typical standard design are given in Table 8-2. These relative proportions form the basis of the major correlations of agitation performance from various studies.

There are cases where  $W/D_A = 1/8$  and  $J/D_T = 1/10$  for some agitator correlations. Usually, 4 baffles are used and the clearance between the baffles and the wall is about 0.1–0.15 J. This ensures that the liquid does not form stagnant pockets between the baffle and the wall. The number of impeller blades varies from 4 to 16, but is generally between 6 and 8.

Mixing by agitation of liquids normally involves the transfer of momentum from an impeller to the liquid. In some cases, mixing is achieved by gas injection or circulation via a pump loop. An impeller, which is mounted on a shaft driven by an electric motor, is divided into two operation categories:

- Where momentum is transferred by shearing stresses, in which the transfer is perpendicular to the direction of flow. This category includes the rotating disc and cone agitators.
- The momentum is transferred by normal stresses, in which the transfer is parallel to the direction of flow. This category includes the paddle, propeller, and turbo mixer agitators.

**Table 8-2**  
**Geometric proportions for a standard agitation system**

$\frac{D_A}{D_T} = \frac{1}{3}$	$\frac{H}{D_T} = 1$	$\frac{J}{D_T} = \frac{1}{12}$
$\frac{E}{D_A} = 1$	$\frac{W}{D_A} = \frac{1}{5}$	$\frac{L}{D_A} = \frac{1}{4}$

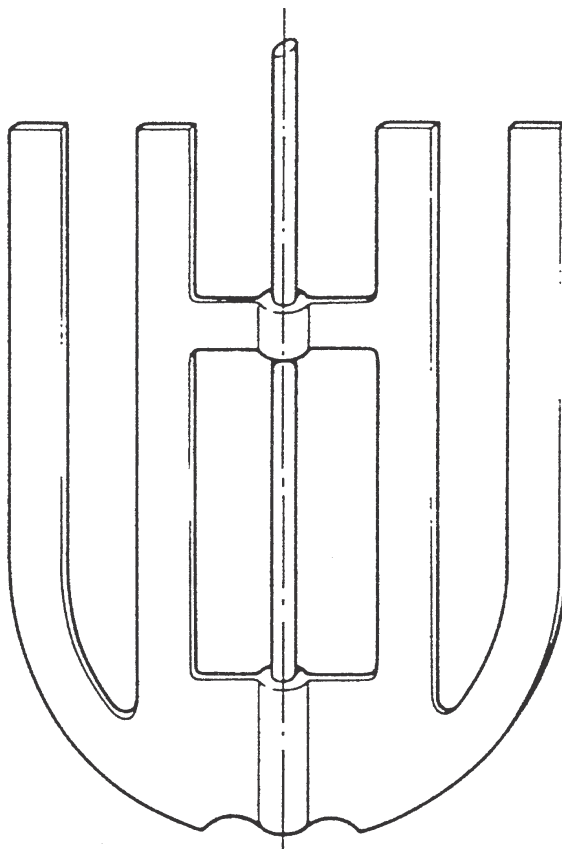
B = number of blades on impeller  
 R = number of baffles  
 D<sub>A</sub> = agitator diameter  
 H = liquid height  
 D<sub>T</sub> = tank diameter  
 E = height of the agitator from the bottom of the tank  
 J = baffle width  
 L = agitator blade length  
 W = agitator blade width

Agitation plays an essential role in the success of many chemical processes, and there is a wide range of commercially available impellers that can provide the optimum degree of agitation for any process. The problem arises in selecting the best impeller for the required process. Equipment manufacturers often provide expert guidance, but it is beneficial for designers and engineers to acquire fundamental knowledge of various types of impellers. The process objective of an impeller is the primary factor that determines its selection. These objectives, summarized in Table 8-1, together with physical properties such as viscosity play an important role in the selection of impellers in laminar, transitional, and turbulent operations. In general, impellers can be classified into two main groups.

- Impellers with a small blade area, which rotate at high speeds. These include turbines and marine propellers.
- Impellers with a large blade area, which rotate at low speeds. These include anchors, paddles, and helical screws.

The latter impellers are very effective for high-viscosity liquids and depend on a large blade area to produce liquid movement throughout the vessel. Since they are low-shear impellers, they are useful for mixing shear-thickening liquids. Figure 8-2 shows a typical gate anchor agitator. Anchor agitators operate very close to the vessel wall with a radial clearance equal to  $0.0275 D_A$ . The shearing action of the anchor blades past the vessel wall produces a continual interchange of liquid between the bulk liquid and the liquid film between the blades and the wall. For heat transfer applications, anchors are fitted with wall scrapers to prevent the buildup of a stagnant film between the anchor and the vessel wall. The anchor impeller is a good blending and heat transfer device when the fluid viscosity is between 5,000 and 50,000 cP (5 and 50 Pas). Below 5,000 cP, there is not enough viscous drag at the tank wall to promote pumping, resulting in a swirling condition. At viscosities greater than 50,000 cP (50 Pas), blending and heat transfer capabilities decrease as pumping capacity declines and the impeller “slips” in the fluid.

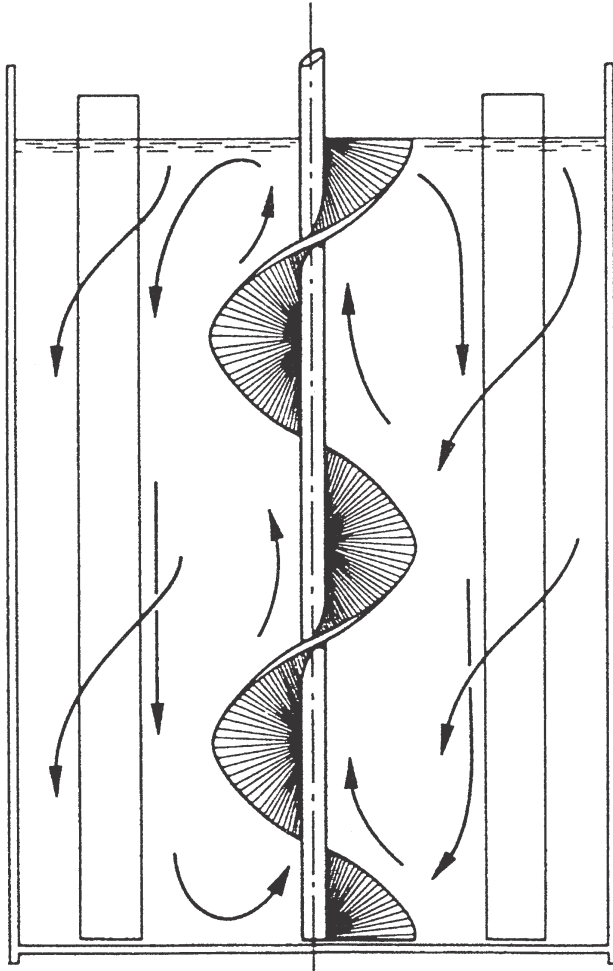
Helical screws operate in the laminar range at normally high impeller to vessel diameter ratio ( $D_A/D_T$ ) with a radial clearance equal to  $0.0375 D_A$ . The impeller usually occupies one-third to one-half of the vessel diameter. They function by pumping liquid from the bottom of a tank to the liquid surface. The liquid returns to the bottom of the



**Figure 8-2.** Gate anchor agitator. (Source: Holland, F. A. and Bragg, R. Fluid Flow for Chemical Engineers, 2nd ed., Edward Arnold, 1995.)

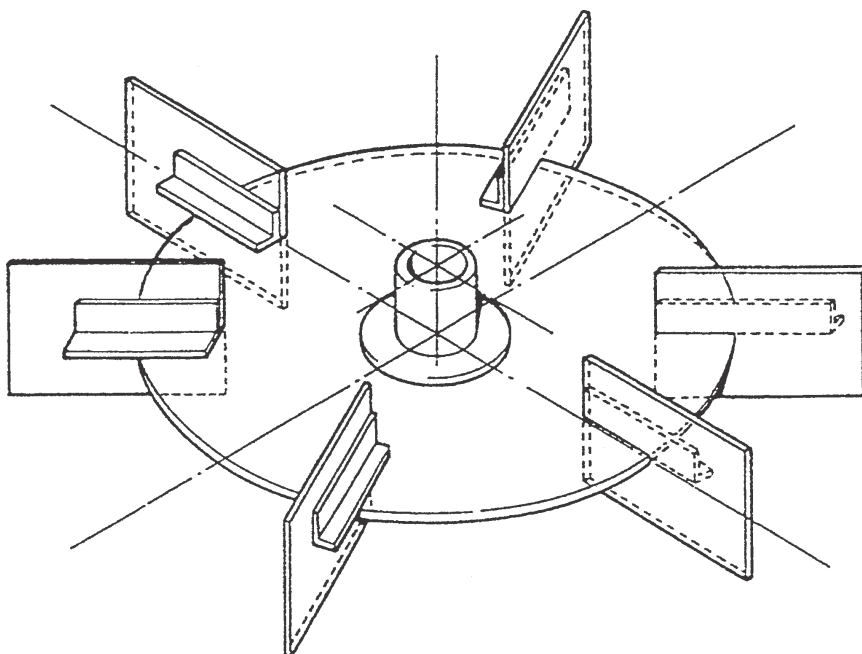
tank to fill the space created when fresh liquid is pumped to the surface. Figure 8-3 shows the flow pattern in a baffled helical screw tank. Baffles set away from the tank wall create turbulence and, thus, enhance the entrainment of liquid in contact with the tank wall. These are not required if the helical screw is placed in an off-centered position because the system becomes self-baffling. These impellers are useful in heat transfer application when it is essential that the fluid closest to the wall moves at high velocities.

Turbulent impellers are classified as axial or radial flow impellers. Axial flow impellers cause the tank fluid to flow parallel to the impeller's rotation axis. Radial flow impellers cause the tank fluid to

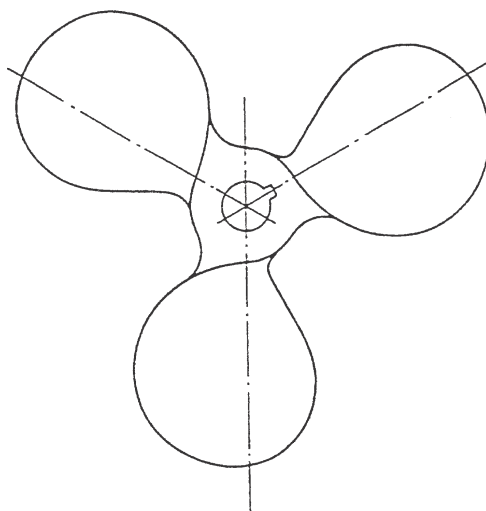


**Figure 8-3.** Flow pattern in a baffled helical screw system. (Source: Holland, F. A. and Bragg, R. Fluid Flow for Chemical Engineers, 2nd ed., Edward Arnold, 1995.)

flow perpendicular to the impeller's rotation axis. Small blade, high-speed impellers are used to mix low to medium viscosity liquids. Figures 8-4 and 8-5, respectively, show the six-flat blade turbine and marine propeller-type agitators. Figure 8-6 shows flat blade turbines used to produce radial flow patterns perpendicular to the vessel wall. In contrast, Figure 8-7 depicts marine-type propellers with axial flow

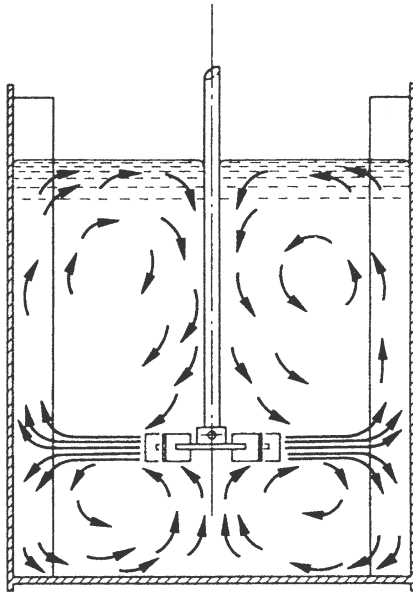


**Figure 8-4.** Six flat blade turbine. (Source: Holland, F. A. and Bragg, R. Fluid Flow for Chemical Engineers, 2nd ed., Edward Arnold, 1995.)

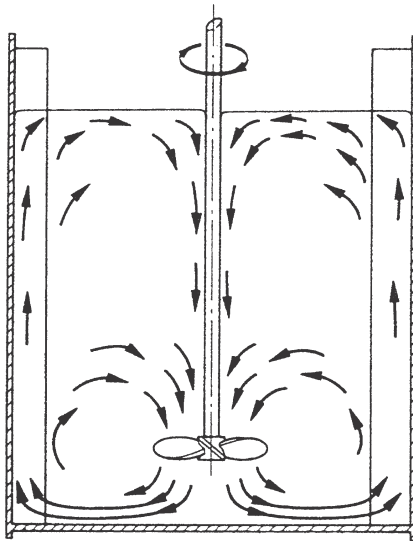


**Figure 8-5.** Marine propeller. (Source: Holland, F. A. and Bragg, R. Fluid Flow for Chemical Engineers, 2nd ed., Edward Arnold, 1995.)





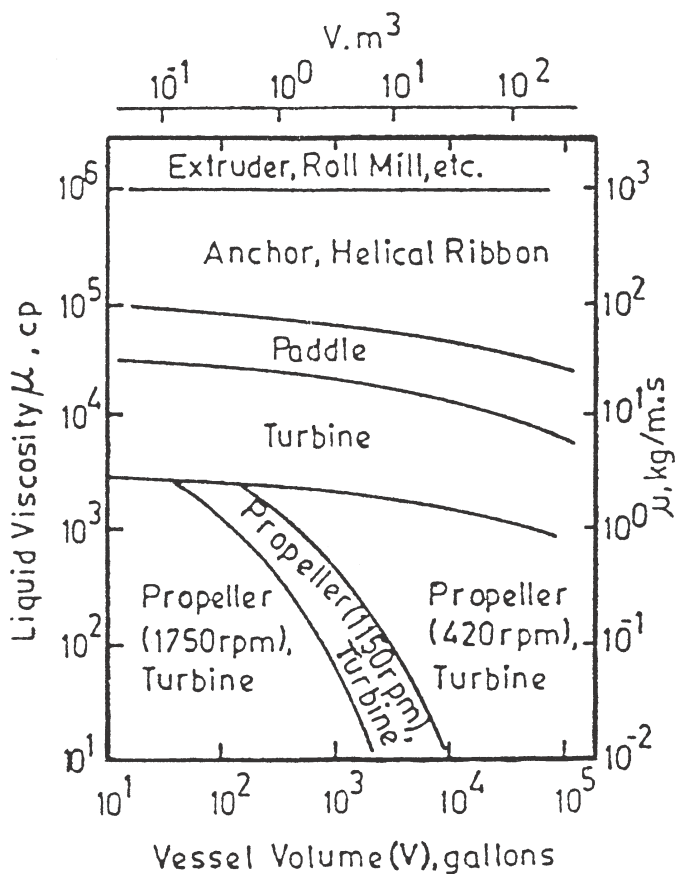
**Figure 8-6.** Radial flow pattern produced by a flat blade turbine. (Source: Holland, F. A. and Bragg, R. Fluid Flow for Chemical Engineers, 2nd ed., Edward Arnold, 1995.)



**Figure 8-7.** Axial flow pattern produced by a marine propeller. (Source: Holland, F. A. and Bragg, R. Fluid Flow for Chemical Engineers, 2nd ed., Edward Arnold, 1995.)

patterns. Both of these types of impellers are suitable to mix liquids with dynamic viscosities between 10 and 50 Pas. Several methods of selecting an impeller are available [3,4]. Figure 8-8 shows one method based on liquid viscosity and tank volume, and Table 8-3 illustrates another based on liquid viscosity alone.

Axial flow devices such as high-efficiency (HE) impellers and pitched blade turbines give better performance than conventional pitched blade turbines. They are best suited to provide the essential flow patterns in a tank that keep the solids suspended. High-efficiency impellers effectively convert mechanical energy to vertical flow



**Figure 8-8.** Impeller selection. (Source: Penny, W. R. "Guide to trouble free mixers," Chem. Eng., 77(12), 171, 1970.)

**Table 8-3**  
**Impeller selection guide**

Type of impeller	Range of liquid, cP	Viscosity, kg/m – sec
Anchor	$10^2 - 2 \times 10^3$	$10^{-1} - 2$
Propeller	$10^0 - 10^4$	$10^{-3} - 10^1$
Flat-blade turbine	$10^0 - 3 \times 10^4$	$10^{-3} - 3 \times 10^1$
Paddle	$10^2 - 3 \times 10^1$	$10^{-1} - 3 \times 10^1$
Gate	$10^3 - 10^5$	$10^0 - 10^2$
Helical screw	$3 \times 10^3 - 3 \times 10^5$	$3 - 3 \times 10^2$
Helical ribbon	$10^4 - 2 \times 10^6$	$10^1 - 2 \times 10^3$
Extruders	$>10^6$	$>10^3$

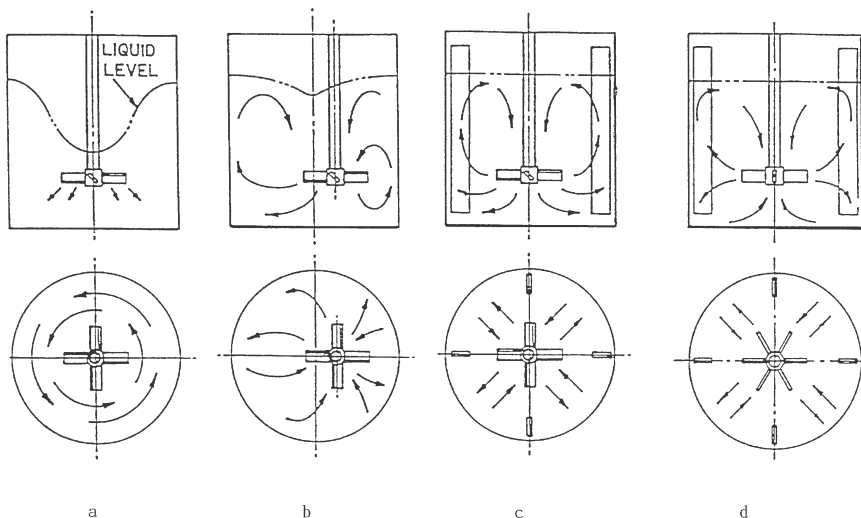
Source: Holland, F. A., and Chapman, F. S. Liquid Mixing and Processing in Stirred Tanks, Reinhold, New York, 1966.

required to overcome the effects of gravity on solids in suspension. They also provide the same levels of solids suspension at reduced capital and operating costs.

### FLOW PATTERN

In fluid agitation, the direction as well as the magnitude of the velocity is critical. The directions of the velocity vectors throughout an agitated vessel are referred to as the flow pattern. Since the velocity distribution is constant in the viscous and turbulent ranges, the flow pattern in an agitated vessel is fixed.

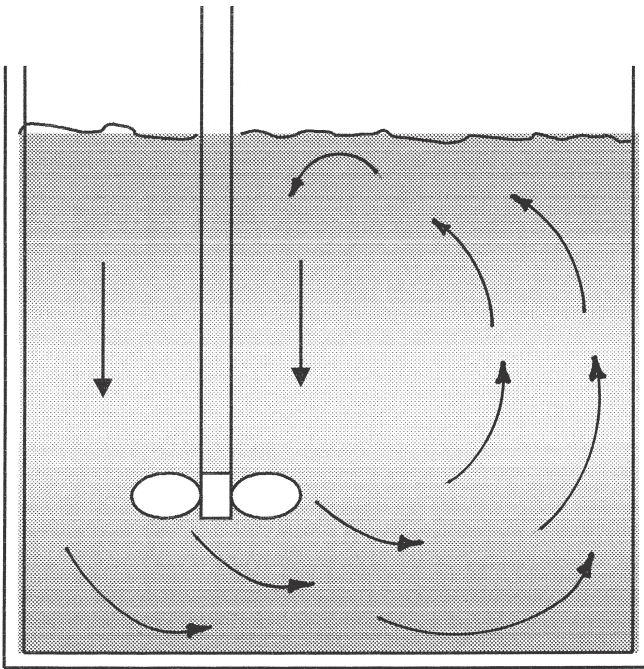
During the mixing of fluids, it is essential to avoid solid body rotation and a large central surface vortex. When solid body rotation occurs, adequate mixing is not achieved because the fluid rotates as if it were a single mass as shown in Figure 8-9a. Centrifugal force of the fluid causes a central surface vortex to be thrown outward by the impeller. Entrainment of air results if the vortex reaches an impeller, resulting in reduced mixing of the fluids. This situation can be averted by installing baffles on the vessel walls, which impede rotational flow without interfering with radial or longitudinal flow. Effective baffling is attained by installing vertical strips perpendicular to the wall of the tank. With the exception of large tanks, four baffles are adequate to prevent swirling and vortex formation. For propellers, the width of the baffle should be less one-eighteenth the diameter of the tank; for



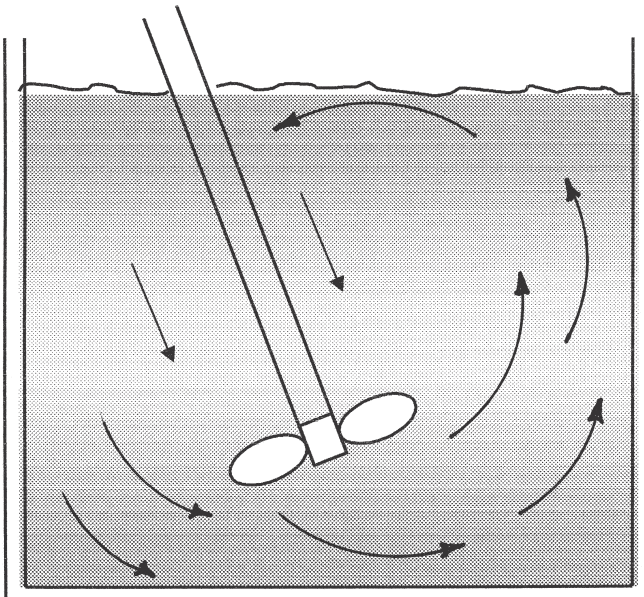
**Figure 8-9.** Agitator flow patterns. (a) Axial or radial impellers without baffles produce vortex. (b) Off-center location reduces the vortex. (c) Axial impeller with baffles. (d) Radial impeller with baffles. (Source: *Walas, S. M., Chemical Process Equipment—Selection and Design, Butterworths Series in Chemical Engineering, 1988.*)

turbines, less one-twelfth the tank diameter. Figure 8-9 shows the various flow patterns of radial and axial impellers.

Reducing vortex formation may also be achieved by placing an impeller in an off-center position. This creates an unbalanced flow pattern, reducing or eliminating the swirl and thereby increasing or maximizing the power consumption. The exact position is critical, since too far or too little off-center in one direction or the other will cause greater swirling, erratic vortexing, and dangerously high shaft stresses. Changes in viscosity and tank size also affect the flow pattern in such vessels. Off-center mounting of radial or axial flow impellers is readily employed as a substitute for baffled tank installations. It is common practice with propellers, but less with turbine agitators. Off-center mounting can also be useful for a turbine operated in the medium viscosity range and with non-Newtonian fluids where baffles cause stagnation with little swirl of the fluid. Off-center mountings have been quite effective in the suspension of paper pulp. Figure 8-10 illustrates an angular off-center position for propellers, which is effective without using baffles.



Off centered mounting of a propeller.



Eccentric angle mounting of a propeller

**Figure 8-10.** Flow pattern of propellers in an eccentric angle and off-centered position.

Once swirling stops, the specific flow pattern in the tank depends on the type of impeller. Paddle agitators and flat-blade turbines promote good radial flow in the plane of the impeller with the flow dividing the wall to form two separate circulation patterns (Figure 8-6). One portion flows down along the wall and back to the center of the impeller from below, and the other flows up toward the surface and back to the impeller from above. Propeller agitators drive the liquid down to the bottom of the tank, where the stream spreads radially in all directions toward the wall, flows upward along the wall, and returns to the suction of the propeller from the top. The earlier Figure 8-7 shows the flow pattern of a propeller agitator. Propellers are employed when heavy solid particles are suspended.

























Table 8-4 shows flow patterns and applications of some commercially available impellers. Generally, the axial flow pattern is most suitable for flow sensitive operation such as blending, heat transfer, and solids suspension, while the radial flow pattern is ideal for dispersion operations that require higher shear levels than are provided by axial flow impellers. Myers et al. [5] have described a selection of impellers with applications. Further details on selection are provided by Uhl and Gray [6], Gates et al. [7], Hicks et al. [8] and Dickey [9].

## **POWER REQUIREMENT FOR AGITATION**

The flow mechanism in a mixing tank is very complex. Various techniques, including computational fluid dynamics (CFD) and computational fluid mixing (CFM) tools, are employed together with experimental data to establish improvements in mixing with increased yield. Estimating the power consumption for any agitator is essential for design. Generally, the desired requirements for the system to be mixed will categorize the type of impeller to be used. Laboratory tests on the system can establish the appropriate speed for the maintenance of isotropic turbulence in the mixing vessel. Therefore, estimating the power consumption for a large-scale mixing operation must include scale-up considerations. These requirements may be determined from the Navier-Stokes equation or analyzed by a dimensional analysis of the mixing operation.

The power consumed by an agitator depends on its dimensions and the physical properties of the fluids being mixed (i.e., density and viscosity). Since there is a possibility of a gas-liquid surface being

**Table 8-4**  
**Impellers and flow patterns**

Impeller	Flow Pattern	Name and description	Applications
		HE-3 Narrow-blade, high-efficiency impeller	Blending, Turbulent heat transfer, Solid suspension,  Upper impeller for gas dispersion, $N_p \approx 0.27$ , $N_q \approx 0.5$ (turbulent)
		P-4 Pitched-blade turbine	Blending, Dispersion, Solid suspension,  Heat transfer, Surface motion, $N_p \approx 1.25$ , $N_q \approx 0.7$ (turbulent)
		S-4 Straight-blade turbine	Local liquid motion for blending, Dispersion, keeping outlets clear from solids,  $N_p = 3.0$
		Maxflo T Wide-blade, high-efficiency impeller	Blending, Transitional flow, Simultaneous gas dispersion and solid suspension (like mining),  $N_p$ and $N_q$ vary with tip angle and number of blades
		ChemShear Narrow-blade turbine	Liquid-liquid dispersion, Solid-liquid dispersion, Local shear
		D-6 Flat-blade disc turbine (Rushton turbine)	Gas dispersion, low and intermediate gas flows, Liquid-liquid dispersion, $N_p \approx 5.5$ , $N_q \approx 0.75$
		CD-6 Concave-blade disc turbine (Smith turbine)	Gas dispersion, intermediate and high gas flows
		Helical ribbon (Double flight shown)	Blending and heat transfer in viscous media ( $\mu > 50$ Pa-s or $N_{Re} < 100$ ) $N_p \approx 350 / N_{Re}$ , $N_{Re} < 100$
		Anchor	Heat transfer in viscous media $N_p \approx 400 / N_{Re}$ , $N_{Re} < 10$
		CD-6 / HE-3 / P-4	Gas dispersion and blending for tall reactors Fermentations (food products, pharmaceuticals)
		CD-6 / HE-3	Combined gas-dispersion, blend- ing, and material drawdown (corn wet milling)
		Side-entering wide blade impeller (HE3-5 or Mark II)	Oil storage, Paper pulp, Wastewater circulation, Flue gas desulphurisation

Source: Myers, K., et al., *Agitation for Success*, The Chemical Engineer, Oct. 10, 1996.  
Reproduced with permission of IChemE.

distorted, as in the formation of a vortex, gravity forces must also be considered.

Consider a stirred tank vessel having a Newtonian liquid of density  $\rho$  and viscosity  $\mu$  is agitated by an impeller of diameter  $D_A$ , rotating at a rotational speed  $N$ . Let the tank diameter be  $D_T$ , the impeller width  $W$ , and the liquid depth  $H$ . The power  $P$  required for agitation of a single-phase liquid can be expressed as:

$$P = f(\rho^a, \mu^b, N^c, g^d, D_A^e, D_T^f, W^g, H^h) \quad (8-1)$$

There are nine variables and three primary dimensions, and therefore by Buckingham's theorem, Equation 8-1 can be expressed by (8-3) dimensionless groups. Employing dimensional analysis, Equation 8-1 in terms of the three basic dimensions (mass  $M$ , length  $L$ , and time  $T$ ) yields: Power =  $ML^2T^{-3}$ .

Substitution of the dimensions into Equation 8-1 gives,

$$ML^2T^{-3} = f\{(ML^{-3})^a, (ML^{-1}T^{-1})^b, T^{-c}, (LT^{-2})^d, L^e, L^f, L^g, L^h\} \quad (8-2)$$

Equating the exponents of  $M$ ,  $L$ , and  $T$  on both sides of Equation 8-2 gives

$$M: \quad 1 = a + b \quad (8-3)$$

$$L: \quad 2 = -3a - b + d + e + f + g + h \quad (8-4)$$

$$T: \quad -3 = -b - c - 2d \quad (8-5)$$

From Equation 7-3

$$a = 1 - b \quad (8-6)$$

Substituting Equation 8-6 into Equation 8-4 gives

$$2 = -3(1 - b) - b + d + e + f + g + h$$

$$5 = 2b + d + e + f + g + h \quad (8-7)$$

From Equation 8-5

$$-3 = -b - c - 2d$$

$$b = 3 - c - 2d, \text{ or}$$



$$c = 3 - b - 2d \quad (8-8)$$

From Equation 9-7

$$e = 5 - 2b - d - f - g - h \quad (8-9)$$

Substituting a, c, and e on the right side of Equation 8-1 yields

$$P = K(\rho^{1-b}, \mu^b, N^{3-b-2d}, g^d, D_A^{5-2b-d-f-g-h}, D_T^f, W^g, H^h) \quad (8-10)$$

Rearranging and grouping the exponents yields,

$$P = K \left\{ \rho N^3 D_A^5 \left( \frac{\mu}{\rho N D_A^2} \right)^b \left( \frac{g}{N^2 D_A} \right)^d \left( \frac{D_T}{D_A} \right)^f \left( \frac{W}{D_A} \right)^g \left( \frac{H}{D_A} \right)^h \right\} \quad (8-11)$$

or

$$\frac{P}{\rho N^3 D_A^5} = K \left\{ \left( \frac{\mu}{\rho N D_A^2} \right)^b \left( \frac{g}{N^2 D_A} \right)^d \left( \frac{D_T}{D_A} \right)^f \left( \frac{W}{D_A} \right)^g \left( \frac{H}{D_A} \right)^h \right\} \quad (8-12)$$

The dimensionless parameters are:

$$\text{The Power number, } N_p = \frac{Pg_C}{\rho N^3 D_A^5} \quad g_C = \text{dimensional gravitational constant}$$

$$32.174 \frac{\text{lbm}}{\text{lbf}} \cdot \frac{\text{ft}}{\text{sec}^2}$$

$$1 \text{ kg} \cdot \text{m/N} \cdot \text{sec}^2$$

$$\text{The Reynolds number, } N_{Re} = \frac{\rho N D_A^2}{\mu}$$

$$\text{The Froude number, } N_{Fr} = \frac{N^2 D_A}{g}$$

Substituting these dimensionless numbers into Equation 8-12 yields,

$$N_p = K \left\{ N_{Re}^{-b} N_{Fr}^{-d} \left( \frac{D_T}{D_A} \right)^f \left( \frac{W}{D_A} \right)^g \left( \frac{H}{D_A} \right)^h \right\} \quad (8-13)$$

## SIMILARITY

---

Equality of all groups in Equation 8-13 assures similarity between systems of different sizes. The types of similarity are geometric, kinematic, and dynamic. The last three terms of Equation 8-13 represent the conditions for *geometric similarity*, which require that all corresponding dimensions in systems of different sizes have the same ratio to each other. For geometric similarity, Equation 8-13 becomes

$$N_p = K N_{Re}^{-b} N_{Fr}^{-d} \quad (8-14)$$

The constant **K** and the exponents **b** and **d** must be determined for the particular type of agitator, its size and location in the tank, the dimensions of the tank, and the depth of the liquid.

*Kinematic similarity* exists between two systems of different sizes when they are geometrically similar and when the ratios of velocities between corresponding points in one system are equal to those in the other.

*Dynamic similarity* exists between two systems when, in addition to being geometrically and kinematically similar, the ratios of forces between corresponding points in one system are equal to those in the other.

The value of  $N_{Re}$  determines whether the flow is laminar or turbulent and is a significant group affecting the power consumption. The Froude number  $N_{Fr}$ , representing the ratio of inertial to gravitational forces, is only significant when the liquid in the tank swirls to such an extent that a deep vortex is formed and the wave or surface effects become important. In an un baffled vessel, a balance between the inertial and gravitational forces determines the shape of any vortex. The Power number  $N_p$  may be considered as a drag coefficient or friction factor.

Experimental data on power consumption are generally plotted as a function of the Power number  $N_p$  versus Reynolds number  $N_{Re}$ , that is by rearranging Equation 8-14.