

RELION® 615 SERIES

Motor Protection and Control

REM615

Modbus Point List Manual





Document ID: 1MRS756877

Issued: 2018-12-20

Revision: H

Product version: 5.0 FP1

© Copyright 2018 ABB. All rights reserved

Copyright

This document and parts thereof must not be reproduced or copied without written permission from ABB, and the contents thereof must not be imparted to a third party, nor used for any unauthorized purpose.

The software or hardware described in this document is furnished under a license and may be used, copied, or disclosed only in accordance with the terms of such license.

Trademarks

ABB and Relion are registered trademarks of the ABB Group. All other brand or product names mentioned in this document may be trademarks or registered trademarks of their respective holders.

Warranty

Please inquire about the terms of warranty from your nearest ABB representative.

www.abb.com/relion

Disclaimer

The data, examples and diagrams in this manual are included solely for the concept or product description and are not to be deemed as a statement of guaranteed properties. All persons responsible for applying the equipment addressed in this manual must satisfy themselves that each intended application is suitable and acceptable, including that any applicable safety or other operational requirements are complied with. In particular, any risks in applications where a system failure and/or product failure would create a risk for harm to property or persons (including but not limited to personal injuries or death) shall be the sole responsibility of the person or entity applying the equipment, and those so responsible are hereby requested to ensure that all measures are taken to exclude or mitigate such risks.

This product has been designed to be connected and communicate data and information via a network interface which should be connected to a secure network. It is the sole responsibility of the person or entity responsible for network administration to ensure a secure connection to the network and to take the necessary measures (such as, but not limited to, installation of firewalls, application of authentication measures, encryption of data, installation of anti virus programs, etc.) to protect the product and the network, its system and interface included, against any kind of security breaches, unauthorized access, interference, intrusion, leakage and/or theft of data or information. ABB is not liable for any such damages and/or losses.

This document has been carefully checked by ABB but deviations cannot be completely ruled out. In case any errors are detected, the reader is kindly requested to notify the manufacturer. Other than under explicit contractual commitments, in no event shall ABB be responsible or liable for any loss or damage resulting from the use of this manual or the application of the equipment.

Conformity

This product complies with the directive of the Council of the European Communities on the approximation of the laws of the Member States relating to electromagnetic compatibility (EMC Directive 2004/108/EC) and concerning electrical equipment for use within specified voltage limits (Low-voltage directive 2006/95/EC). This conformity is the result of tests conducted by ABB in accordance with the product standard EN 60255-26 for the EMC directive, and with the product standards EN 60255-1 and EN 60255-27 for the low voltage directive. The product is designed in accordance with the international standards of the IEC 60255 series.

Table of contents

Section 1	Introduction.....	7
	This manual.....	7
	Intended audience.....	7
	Product documentation.....	8
	Product documentation set.....	8
	Document revision history.....	8
	Related documentation.....	9
	Symbols and conventions.....	9
	Symbols.....	9
	Document conventions.....	9
	Functions, codes and symbols.....	10
Section 2	Modbus data mappings.....	15
	Overview.....	15
	Supported functions.....	15
	Supported functions in REM615.....	15
	Indications.....	17
	Premapped indications.....	17
	Common data 1.....	17
	CTRL.CBCILO1 Circuit breaker enable signals (1).....	17
	CTRL.CBCSWI1 Circuit breaker (1) mom. position.....	18
	CTRL.CBCSWI1 Circuit breaker (1) mom+mcd position.....	18
	CTRL.CBXCBR1 Circuit-breaker control (1).....	18
	CTRL.DCSXSWI1 Disconnecter position indication (1).....	19
	CTRL.DCSXSWI2 Disconnecter position indication (2).....	19
	CTRL.DCSXSWI3 Disconnecter position indication (3).....	19
	CTRL.DCXSWI1 Disconnecter control (1).....	19
	CTRL.DCXSWI2 Disconnecter control (2).....	20
	CTRL.ESSXSWI1 Earthing switch indication (1).....	20
	CTRL.ESSXSWI2 Earthing switch indication (2).....	21
	CTRL.ESXSWI1 Earthing switch control (1).....	21
	LD0.ARCARC1 Arc protection (1).....	21
	LD0.ARCARC2 Arc protection (2).....	22
	LD0.ARCARC3 Arc protection (3).....	22
	LD0.CCBBRF1 Circuit breaker failure protection (1).....	22
	LD0.CCSPVC1 Current circuit supervision (1).....	23
	LD0.CMMXU1 Three-phase current measurement (1).....	23
	LD0.DEFLPDEF1 Directional earth-fault protection, low stage (1).....	23

Table of contents

LD0.EFHPTOC1 Non-directional earth-fault protection, high stage (1).....	24
LD0.EFLPTOC1 Non-directional earth-fault protection low stage (1).....	24
LD0.ESMGAPC1 Emergency start-up (1).....	24
LD0.FRPFRQ1 Frequency protection (1).....	24
LD0.FRPFRQ2 Frequency protection (2).....	25
LD0.JAMPTOC1 Motor load jam protection (1).....	25
LD0.LEDGGIO1 Indication LED states Color1/Color2.....	25
LD0.LEDGGIO1 Indication LED states OFF/ColorX.....	27
LD0.LEDPTRC1 Global conditioning (1).....	28
LD0.LEDPTRC1 Global conditioning - phase information (1).....	28
LD0.LOFLPTUC1 Loss of load supervision (1).....	28
LD0.MAPGAPC1 Multipurpose protection (1).....	29
LD0.MAPGAPC2 Multipurpose protection (2).....	29
LD0.MAPGAPC3 Multipurpose protection (3).....	29
LD0.MAPGAPC4 Multipurpose protection (4).....	29
LD0.MAPGAPC5 Multipurpose protection (5).....	30
LD0.MAPGAPC6 Multipurpose protection (6).....	30
LD0.MDSOPT1 Runtime counter for machines and devices (1).....	30
LD0.MNSPTOC1 Negative-sequence overcurrent protection for machines (1).....	30
LD0.MNSPTOC2 Negative-sequence overcurrent protection for machines (2).....	31
LD0.MPTTR1 Thermal overload protection for motors (1).....	31
LD0.MVGAPC1 Move (8 pcs) (1).....	31
LD0.MVGAPC2 Move (8 pcs) (2).....	32
LD0.NSPTOV1 Negative-sequence overvoltage protection (1).....	32
LD0.PHIPTOC1 Three-phase non-directional overcurrent protection, instantaneous stage (1).....	33
LD0.PHLPTOC1 Three-phase non-directional overcurrent protection, low stage (1).....	33
LD0.PHPTUV1 Three-phase undervoltage protection (1).....	34
LD0.PREVPTOC1 Phase reversal protection (1).....	34
LD0.PSPTUV1 Positive-sequence undervoltage protection (1).....	34
LD0.RESCMMXU1 Residual current measurement (1).....	35
LD0.RESVMMXU1 Residual voltage measurement (1).....	35
LD0.SEQSPVC1 Fuse failure protection (1).....	35
LD0.SPCGAPC2 Generic control point (16 pcs) (2).....	35
LD0.SSCBR1 Circuit-breaker condition monitoring (1).....	36
LD0.STTPMSU1 Motor start-up supervision (1).....	37

LD0.TCSSCBR1 Trip circuit supervision (1).....	37
LD0.TCSSCBR2 Trip circuit supervision (2).....	37
LD0.TRPPTRC1 Master trip (1).....	38
LD0.TRPPTRC2 Master trip (2).....	38
LD0.VMMXU1 Three-phase voltage measurement (1).....	38
LD0.XAGGIO130 Physical I/O states (AIM card XA130).....	39
LD0.XBGGIO110 Physical I/O states (BIO card XB110).....	39
LD0.XGGIO100 Physical I/O states (PSM card X100).....	40
LD0.XGGIO110 Physical I/O states (BIO card X110).....	41
LD0.XGGIO120 Physical I/O states (AIM card X120).....	42
LD0.XGGIO130 Physical I/O states (BIO card X130)	42
LD0.XRGGIO130 Alarm/warning.....	43
Unmapped indications.....	43
All premapped three-phase protection function stages, operate/phase-dependent objects added.....	43
Common data 2.....	44
LD0.DIAGLCCH1 Ethernet supervision (1).....	44
LD0.IL1TCTR1 Three-phase CT supervision (1).....	45
LD0.LDPRLRC1 Load profile record (1).....	45
LD0.MAPGAPC7 Multipurpose protection (7).....	45
LD0.MAPGAPC8 Multipurpose protection (8).....	45
LD0.MAPGAPC9 Multipurpose protection (9).....	46
LD0.MAPGAPC10 Multipurpose protection (10).....	46
LD0.MAPGAPC11 Multipurpose protection (11).....	46
LD0.MAPGAPC12 Multipurpose protection (12).....	46
LD0.MAPGAPC13 Multipurpose protection (13).....	47
LD0.MAPGAPC14 Multipurpose protection (14).....	47
LD0.MAPGAPC15 Multipurpose protection (15).....	47
LD0.MAPGAPC16 Multipurpose protection (16).....	47
LD0.MAPGAPC17 Multipurpose protection (17).....	48
LD0.MAPGAPC18 Multipurpose protection (18).....	48
LD0.PHHPTOC1 Three-phase non-directional overcurrent protection, high stage (1).....	48
LD0.RESTCTR1 Io CT supervision (1).....	49
LD0.RESTVTR1 Uo VT supervision (1).....	49
LD0.SPCGAPC1 Generic control point (16 pcs) (1).....	49
LD0.TRPPTRC3 Master trip (3).....	50
LD0.TRPPTRC4 Master trip (4).....	51
LD0.TRPPTRC5 Master trip (5).....	51
LD0.UL1TVTR1 Three-phase VT supervision (1).....	51
LD0.XRGGIO130 Alarm/warning.....	51
Registers.....	52
Premapped registers.....	52
Active parameter setting group - read and write.....	52

Table of contents

Control structure 1.....	52
Control structure 2.....	53
Control structure 3.....	53
Control structure 4.....	53
Control structure 5.....	53
Control structure 6.....	54
Control structure 7.....	54
Control structure 8.....	54
Device ID string.....	54
Event record structure.....	55
Fault record structure header.....	59
Fault record data.....	59
Protection relay's real-time clock (in local time mode) - read and write (synchronize).....	63
Protection relay's real-time clock (in UTC time mode) - read and write (synchronize).....	63
Indication bits mirrored in registers.....	63
SSR1 System status register (1) device health.....	64
SSR2 System status register (2) protection relay's mode and state.....	64
SSR3 System status register (3) data available 1 (client- dependent).....	65
SSR4 System status register (4) data available 2 (client- dependent, user-definable).....	65
SSR5 System status register (5) device alive register.....	66
SSR6 System status register (6) control command status (client-dependent).....	66
System diagnostic values.....	67
Time and reason for latest protection relay reset.....	67
User-definable bits [Alt.2], visible on 0x,1x,3x and 4x.....	68
User-definable registers [Alt.1], visible on 3x and 4x.....	68
CTRL.CBCSWI1 Circuit breaker operation counter (1)	69
LD0.ARCARCx1 Arc protection (x1).....	69
LD0.CMMXU1 Phase current demand values (1).....	69
LD0.CMMXU1 Three-phase current measurement (1)	70
LD0.CSMSQI1 Sequence current measurement (1).....	71
LD0.FMMXU1 Frequency measurement (1).....	71
LD0.MDSOPT1 Runtime counter for machines and devices (1).....	71
LD0.MPTTR1 Thermal overload protection for motors (1).....	71
LD0.PEMMTR1 Three-phase energy measurements (1).....	72
LD0.PEMMXU1 Power measurement demand values (1)	72
LD0.PEMMXU1 Three-phase power and energy measurement (1).....	73

LD0.RESCMMXU1 Residual current demand value (1).....	73
LD0.RESCMMXU1 Residual current measurement (1).....	74
LD0.RESVMMXU1 Residual voltage demand value (1)	74
LD0.RESVMMXU1 Residual voltage measurement (1).....	74
LD0.SSCBR1 Circuit-breaker condition monitoring (1).....	75
LD0.VMMXU1 Three-phase voltage measurement (1)	75
LD0.VMMXU1 Voltage demand values (1).....	76
LD0.VSMSQ11 Sequence voltage measurement (1)	76
LD0.XRGGIO130 RTD input values.....	76
Unmapped registers.....	77
CTRL.LLN0 Local, Remote, Station, Off and Combinations..	77
LD0.LLN0/LPHD1/LDEV1 System values	77
LD0.MVI4GAPC1 Integer value move (1).....	77
LD0.SCA4GAPC1 Analog value scaling (1).....	78
LD0.SCA4GAPC2 Analog value scaling (2).....	78
LD0.SCA4GAPC3 Analog value scaling (3).....	78
LD0.SCA4GAPC4 Analog value scaling (4).....	78
Controls.....	79
Reset, acknowledge and trigger points.....	79
CTRL.CBCSWI1 Circuit breaker control (1).....	80
CTRL.DCXSWI1 Disconnecter control (1)	80
CTRL.DCXSWI2 Disconnecter control (2).....	80
CTRL.ESXSWI1 Earthing switch control (1)	81
LD0.LDEV1 Protection relay's warm reset (1).....	81
LD0.SPCGAPC1 Generic control point (16 pcs) (1)	81
LD0.SPCGAPC2 Generic control point (16 pcs) (2).....	82
LD0.SRGAPC1 Set-reset (8 pcs) (1).....	82
LD0.SRGAPC2 Set-reset (8 pcs) (2).....	83
Unmapped control points.....	83
Section 3 Glossary.....	85

Section 1 Introduction

1.1 This manual

The point list manual describes the outlook and properties of the data points specific to the protection relay. The manual should be used in conjunction with the corresponding communication protocol manual.

1.2 Intended audience

This manual addresses the communication system engineer or system integrator responsible for pre-engineering and engineering for communication setup in a substation from an protection relay perspective.

The system engineer or system integrator must have a basic knowledge of communication in protection and control systems and thorough knowledge of the specific communication protocol.

1.3 Product documentation

1.3.1 Product documentation set

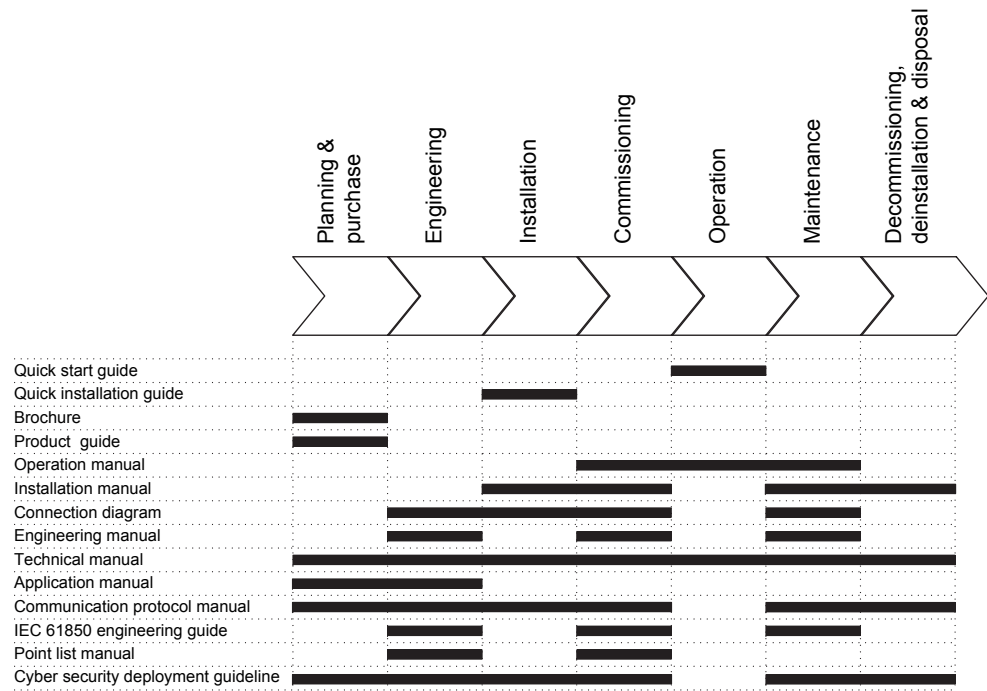

Figure 1: The intended use of documents during the product life cycle



Product series- and product-specific manuals can be downloaded from the ABB Web site <http://www.abb.com/reliion>.

1.3.2 Document revision history

Document revision/date	Product version	History
A/2009-07-03	2.0	First release
B/2010-06-11	3.0	Content updated to correspond to the product version
C/2012-05-11	4.0	Content updated to correspond to the product version
D/2013-02-21	4.0 FP1	Content updated to correspond to the product version
E/2014-01-24	5.0	Content updated to correspond to the product version
Table continues on next page		

Document revision/date	Product version	History
F/2015-10-30	5.0 FP1	Content updated to correspond to the product version
G/2016-05-20	5.0 FP1	Content updated
H/2018-12-20	5.0 FP1	Content updated



Download the latest documents from the ABB Web site
<http://www.abb.com/relion>.

1.3.3 Related documentation

Name of the document	Document ID
Modbus Communication Protocol Manual	1MRS756468

1.4 Symbols and conventions

1.4.1 Symbols



The caution icon indicates important information or warning related to the concept discussed in the text. It might indicate the presence of a hazard which could result in corruption of software or damage to equipment or property.



The information icon alerts the reader of important facts and conditions.





The tip icon indicates advice on, for example, how to design your project or how to use a certain function.

Although warning hazards are related to personal injury, it is necessary to understand that under certain operational conditions, operation of damaged equipment may result in degraded process performance leading to personal injury or death. Therefore, comply fully with all warning and caution notices.

1.4.2 Document conventions

A particular convention may not be used in this manual.

- Abbreviations and acronyms are spelled out in the glossary. The glossary also contains definitions of important terms.
- Push button navigation in the LHMI menu structure is presented by using the push button icons.
To navigate between the options, use  and .
- Menu paths are presented in bold.
Select **Main menu/Settings**.
- LHMI messages are shown in Courier font.
To save the changes in nonvolatile memory, select Yes and press .
- Parameter names are shown in italics.
The function can be enabled and disabled with the *Operation* setting.
- Parameter values are indicated with quotation marks.
The corresponding parameter values are "On" and "Off".
- Input/output messages and monitored data names are shown in Courier font.
When the function starts, the *START* output is set to TRUE.
- This document assumes that the parameter setting visibility is "Advanced".

1.4.3

Functions, codes and symbols

Table 1: Functions included in the relay

Function	IEC 61850	IEC 60617	IEC-ANSI
Protection			
Three-phase non-directional overcurrent protection, low stage	PHLPTOC1	3I> (1)	51P-1 (1)
Three-phase non-directional overcurrent protection, high stage	PHHPTOC1	3I>> (1)	51P-2 (1)
Three-phase non-directional overcurrent protection, instantaneous stage	PHIPTOC1	3I>>> (1)	50P/51P (1)
Non-directional earth-fault protection, low stage	EFLPTOC1	Io> (1)	51N-1 (1)
Non-directional earth-fault protection, high stage	EFHPTOC1	Io>> (1)	51N-2 (1)
Directional earth-fault protection, low stage	DEFLPDEF1	Io> -> (1)	67N-1 (1)
Three-phase undervoltage protection	PHPTUV1	3U< (1)	27 (1)
Positive-sequence undervoltage protection	PSPTUV1	U1< (1)	47U+ (1)
Negative-sequence overvoltage protection	NSPTOV1	U2> (1)	47O- (1)
Frequency protection	FRPFRQ1	f>/f<,df/dt (1)	81 (1)
	FRPFRQ2	f>/f<,df/dt (2)	81 (2)
Negative-sequence overcurrent protection for machines	MNSPTOC1	I2>M (1)	46M (1)
	MNSPTOC2	I2>M (2)	46M (2)
Loss of load supervision	LOFLPTUC1	3I< (1)	37 (1)
Table continues on next page			

Function	IEC 61850	IEC 60617	IEC-ANSI
Motor load jam protection	JAMPTOC1	Ist> (1)	51LR (1)
Motor start-up supervision	STTPMSU1	Is2t n< (1)	49,66,48,51LR (1)
Phase reversal protection	PREVPTOC1	I2>> (1)	46R (1)
Thermal overload protection for motors	MPTR1	3Ith>M (1)	49M (1)
Circuit breaker failure protection	CCBRBRF1	3I>/lo>BF (1)	51BF/51NBF (1)
Master trip	TRPPTRC1	Master Trip (1)	94/86 (1)
	TRPPTRC2	Master Trip (2)	94/86 (2)
	TRPPTRC3	Master Trip (3)	94/86 (3)
	TRPPTRC4	Master Trip (4)	94/86 (4)
	TRPPTRC5	Master Trip (5)	94/86 (5)
Arc protection	ARCSARC1	ARC (1)	50L/50NL (1)
	ARCSARC2	ARC (2)	50L/50NL (2)
	ARCSARC3	ARC (3)	50L/50NL (3)
Multipurpose protection	MAPGAPC1	MAP (1)	MAP (1)
	MAPGAPC2	MAP (2)	MAP (2)
	MAPGAPC3	MAP (3)	MAP (3)
	MAPGAPC4	MAP (4)	MAP (4)
	MAPGAPC5	MAP (5)	MAP (5)
	MAPGAPC6	MAP (6)	MAP (6)
	MAPGAPC7	MAP (7)	MAP (7)
	MAPGAPC8	MAP (8)	MAP (8)
	MAPGAPC9	MAP (9)	MAP (9)
	MAPGAPC10	MAP (10)	MAP (10)
	MAPGAPC11	MAP (11)	MAP (11)
	MAPGAPC12	MAP (12)	MAP (12)
	MAPGAPC13	MAP (13)	MAP (13)
	MAPGAPC14	MAP (14)	MAP (14)
	MAPGAPC15	MAP (15)	MAP (15)
	MAPGAPC16	MAP (16)	MAP (16)
	MAPGAPC17	MAP (17)	MAP (17)
	MAPGAPC18	MAP (18)	MAP (18)
Control			
Circuit-breaker control	CBXCBR1	I <-> O CB (1)	I <-> O CB (1)
Disconnecter control	DCXSWI1	I <-> O DCC (1)	I <-> O DCC (1)
	DCXSWI2	I <-> O DCC (2)	I <-> O DCC (2)
Earthing switch control	ESXSWI1	I <-> O ESC (1)	I <-> O ESC (1)
Disconnecter position indication	DCSXSXI1	I <-> O DC (1)	I <-> O DC (1)
	DCSXSXI2	I <-> O DC (2)	I <-> O DC (2)
	DCSXSXI3	I <-> O DC (3)	I <-> O DC (3)
Table continues on next page			

Function	IEC 61850	IEC 60617	IEC-ANSI
Earthing switch indication	ESSXSWI1	I <-> O ES (1)	I <-> O ES (1)
	ESSXSWI2	I <-> O ES (2)	I <-> O ES (2)
Emergency start-up	ESMGAPC1	ESTART (1)	ESTART (1)
Condition monitoring and supervision			
Circuit-breaker condition monitoring	SSCBR1	CBCM (1)	CBCM (1)
Trip circuit supervision	TCSSCBR1	TCS (1)	TCM (1)
	TCSSCBR2	TCS (2)	TCM (2)
Current circuit supervision	CCSPVC1	MCS 3I (1)	MCS 3I (1)
Fuse failure supervision	SEQSPVC1	FUSEF (1)	60 (1)
Runtime counter for machines and devices	MDSOPT1	OPTS (1)	OPTM (1)
Measurement			
Disturbance recorder	RDRE1	DR (1)	DFR (1)
Load profile record	LDPRLRC1	LOADPROF (1)	LOADPROF (1)
Fault record	FLTRFRC1	FAULTREC (1)	FAULTREC (1)
Three-phase current measurement	CMMXU1	3I (1)	3I (1)
Sequence current measurement	CSMSQI1	I1, I2, I0 (1)	I1, I2, I0 (1)
Residual current measurement	RESCMMXU1	Io (1)	In (1)
Three-phase voltage measurement	VMMXU1	3U (1)	3V (1)
Residual voltage measurement	RESVMMXU1	Uo (1)	Vn (1)
Sequence voltage measurement	VSMSQI1	U1, U2, U0 (1)	V1, V2, V0 (1)
Three-phase power and energy measurement	PEMMXU1	P, E (1)	P, E (1)
RTD/mA measurement	XRGGIO130	X130 (RTD) (1)	X130 (RTD) (1)
Frequency measurement	FMMXU1	f (1)	f (1)
IEC 61850-9-2 LE sampled value sending	SMVSENDER	SMVSENDER	SMVSENDER
IEC 61850-9-2 LE sampled value receiving (voltage sharing)	SMVRCV	SMVRCV	SMVRCV
Other			
Minimum pulse timer (2 pcs)	TPGAPC1	TP (1)	TP (1)
	TPGAPC2	TP (2)	TP (2)
	TPGAPC3	TP (3)	TP (3)
	TPGAPC4	TP (4)	TP (4)
Minimum pulse timer (2 pcs, second resolution)	TPSGAPC1	TPS (1)	TPS (1)
Minimum pulse timer (2 pcs, minute resolution)	TPMGAPC1	TPM (1)	TPM (1)
Pulse timer (8 pcs)	PTGAPC1	PT (1)	PT (1)
	PTGAPC2	PT (2)	PT (2)
Table continues on next page			

Function	IEC 61850	IEC 60617	IEC-ANSI
Time delay off (8 pcs)	TOFGAPC1	TOF (1)	TOF (1)
	TOFGAPC2	TOF (2)	TOF (2)
	TOFGAPC3	TOF (3)	TOF (3)
	TOFGAPC4	TOF (4)	TOF (4)
Time delay on (8 pcs)	TONGAPC1	TON (1)	TON (1)
	TONGAPC2	TON (2)	TON (2)
	TONGAPC3	TON (3)	TON (3)
	TONGAPC4	TON (4)	TON (4)
Set-reset (8 pcs)	SRGAPC1	SR (1)	SR (1)
	SRGAPC2	SR (2)	SR (2)
	SRGAPC3	SR (3)	SR (3)
	SRGAPC4	SR (4)	SR (4)
Move (8 pcs)	MVGAPC1	MV (1)	MV (1)
	MVGAPC2	MV (2)	MV (2)
Generic control point (16 pcs)	SPCGAPC1	SPC (1)	SPC (1)
	SPCGAPC2	SPC (2)	SPC (2)
Analog value scaling	SCA4GAPC1	SCA4 (1)	SCA4 (1)
	SCA4GAPC2	SCA4 (2)	SCA4 (2)
	SCA4GAPC3	SCA4 (3)	SCA4 (3)
	SCA4GAPC4	SCA4 (4)	SCA4 (4)
Integer value move	MVI4GAPC1	MVI4 (1)	MVI4 (1)

Section 2 Modbus data mappings

2.1 Overview

This document describes the Modbus data points and structures available in the protection relay. The point lists describe a superset of all data available through the standard configuration/s including the optional functionalities.

The majority of the Modbus data points are valid for all standard configurations. Some data points are standard configuration-dependent or optional application-dependent and thus not available in each protection relay. The unavailable, that means, unused, data points always return value 0 when they are read. The configuration-dependent and optional data do not overlap.

2.2 Supported functions

2.2.1 Supported functions in REM615

Table 2: *Supported functions*

Function	IEC 61850	A	B	C	D
		ME01	ME02	ME03	ME04
Protection					
Three-phase non-directional overcurrent protection, low stage	PHLPTOC	1	1	1	1
Three-phase non-directional overcurrent protection, high stage	PHHPTOC	1	1	1	1
Three-phase non-directional overcurrent protection, instantaneous stage	PHIPTOC	1	1	1	1
Non-directional earth-fault protection, low stage	EFLPTOC	1			
Non-directional earth-fault protection, high stage	EFHPTOC	1	1	1	1
Directional earth-fault protection, low stage	DEFLPDEF		1 ¹⁾	1	1 ¹⁾
Three-phase undervoltage protection	PHPTUV		1	1	1
Positive-sequence undervoltage protection	PSPTUV		1	1	1
Negative-sequence overvoltage protection	NSPTOV		1	1	1
Frequency protection	FRPFRQ		2	2	2
Negative-sequence overcurrent protection for machines	MNSPTOC	2	2	2	2
Loss of load supervision	LOFLPTUC	1	1	1	1
Motor load jam protection	JAMPTOC	1	1	1	1
Motor start-up supervision	STTPMSU	1	1	1	1
Phase reversal protection	PREVPTOC	1	1	1	1
Thermal overload protection for motors	MPTTR	1	1	1	1
Circuit breaker failure protection	CCBRBRF	1	1	1	1
Master trip	TRPPTRC	2 (3) ²⁾	2 (3) ²⁾	2 (3) ²⁾	2 (3) ²⁾
Table continues on next page					

Section 2 Modbus data mappings

1MRS756877 H

Function	IEC 61850	A	B	C	D
		ME01	ME02	ME03	ME04
Arc protection	ARCSARC	(3)	(3)	(3)	(3)
Multipurpose protection	MAPGAPC	18	18	18	18
Control					
Circuit-breaker control	CBXCBR	1	1	1	1
Disconnecter control	DCXSWI	2	2	2	2
Earthing switch control	ESXSWI	1	1	1	1
Disconnecter position indication	DCSXSXI	3	3	3	3
Earthing switch indication	ESSXSXI	2	2	2	2
Emergency start-up	ESMGAPC	1	1	1	1
Condition monitoring and supervision					
Circuit-breaker condition monitoring	SSCBR	1	1	1	1
Trip circuit supervision	TCSSCBR	2	2	2	2
Current circuit supervision	CCSPVC	1	1	1	1
Fuse failure supervision	SEQSPVC		1	1	1
Runtime counter for machines and devices	MDSOPT	1	1	1	1
Measurement					
Disturbance recorder	RDRE	1	1	1	1
Load profile record	LDPRLRC	1	1	1	1
Fault record	FLTRFRC	1	1	1	1
Three-phase current measurement	CMMXU	1	1	1	1
Sequence current measurement	CSMSQI	1	1	1	1
Residual current measurement	RESCMMXU	1	1	1	1
Three-phase voltage measurement	VMMXU		1	1	1
Residual voltage measurement	RESVMMXU			1	
Sequence voltage measurement	VSMSQI		1	1	1
Three-phase power and energy measurement	PEMMXU		1	1	1
RTD/mA measurement	XRGGIO130	(1)	(1)		
Frequency measurement	FMMXU1		1	1	1
IEC 61850-9-2 LE sampled value sending ³⁾⁴⁾	SMVSENDER		(1)	(1)	(1)
IEC 61850-9-2 LE sampled value receiving (voltage sharing) ³⁾⁴⁾	SMVRCV		(1)	(1)	(1)
Other					
Minimum pulse timer (2 pcs)	TPGAPC	4	4	4	4
Minimum pulse timer (2 pcs, second resolution)	TPSGAPC	1	1	1	1
Minimum pulse timer (2 pcs, minute resolution)	TPMGAPC	1	1	1	1
Pulse timer (8 pcs)	PTGAPC	2	2	2	2
Time delay off (8 pcs)	TOFGAPC	4	4	4	4
Time delay on (8 pcs)	TONGAPC	4	4	4	4
Set-reset (8 pcs)	SRGAPC	4	4	4	4
Move (8 pcs)	MVGAPC	2	2	2	2
Generic control point (16 pcs)	SPCGAPC	2	2	2	2
Analog value scaling (4 pcs)	SCA4GAPC	4	4	4	4
Integer value move (4 pcs)	MVI4GAPC	1	1	1	1
1, 2, ... = Number of included instances. The instances of a protection function represent the number of identical protection function blocks available in the standard configuration. () = optional					

- 1) "Uo calculated" is always used.
- 2) Master trip is included and connected to the corresponding HSO in the configuration only when the BIO0007 module is used. If additionally the ARC option is selected, ARCSARC is connected in the configuration to the corresponding master trip input.
- 3) Available only with IEC 61850-9-2
- 4) Available only with COM0031-0037

2.3 Indications

Table 3: Explanations of the indications table columns

Column name	Description
BitA	Default 0X and 1X bit address for the data.
RegA	Default 3X and 4X register.bit (00-15) address for the data.
IEC 61850 name	Original IED data object identification. Described in the IEC 61850 format as Logical Device.Logical Node and thereafter .Data Object.Data Attribute. Logical Node is the same as the application function block name.
SA name	The signal may have a defined label that is visible, for example, in the Application Configuration tool in PCM600.
Description	Short description of the signal. See the technical manual for more information.
Value	Meaning of the value states.

2.3.1 Premapped indications

2.3.1.1 Common data 1

Table 4: Common data 1

BitA	RegA	IEC 61850 name	SA name	Description	Values
		CTRL.LLN0			
2720	170.00	.Loc.stVal	-	Remote/Local state	0/1=Rem/Loc
2721	170.01	.LocKeyHMI.stVal.Station	-	Station state	1=Station
		DR.RDRE1			
2722	170.02	.RcdMade.stVal	-	DR recording made	1=Made
2723	170.03	.mcd			

2.3.1.2 CTRL.CBCILO1 Circuit breaker enable signals (1)

Table 5: CTRL.CBCILO1 Circuit breaker enable signals (1)

BitA	RegA	IEC 61850 name	SA name	Description	Values
		CTRL.CBCILO1			
2824	176.08	.EnaOpn.stVal	ENA_OPEN	Open enabled	1=Enabled
2825	176.09	.EnaCls.stVal	ENA_CLOSE	Close enabled	1=Enabled

2.3.1.3 CTRL.CBCSWI1 Circuit breaker (1) mom. position

Table 6: CTRL.CBCSWI1 Circuit breaker (1) mom. position

BitA	RegA	IEC 61850 name	SA name	Description	Values
		CTRL.CBCSWI1	POSITION		
2804	175.04	.Pos.stVal.Close	-	Close bit	1=Close
2805	175.05	.Pos.stVal.Open	-	Open bit	1=Open
2806	175.06	.Pos.stVal.Fault	-	Fault bit	1=Pos(00/11)
2834	177.02	.SynIntlBypstVal	ITL_BYPASS	Interlock bypass	1=Bypass
2835	177.03	.mcd			

2.3.1.4 CTRL.CBCSWI1 Circuit breaker (1) mom+mcd position

Table 7: CTRL.CBCSWI1 Circuit breaker (1) mom+mcd position

BitA	RegA	IEC 61850 name	SA name	Description	Values
		CTRL.CBCSWI1	POSITION		
2816	176.00	.Pos.stVal.Close		Close bit	1=Close
2817	176.01	.mcd			
2818	176.02	.Pos.stVal.Open		Open bit	1=Open
2819	176.03	.mcd			
2820	176.04	< reserved >			
2821	176.05	< reserved >			
2822	176.06	.Pos.stSeld	SELECTED	CB selected for control	1=Selected
2823	176.07	.mcd			

2.3.1.5 CTRL.CBXCBR1 Circuit-breaker control (1)

Table 8: CTRL.CBXCBR1 Circuit-breaker control (1)

BitA	RegA	IEC 61850 name	SA name	Description	Values
		CTRL.CBXCBR1			
2836	177.04	.BlkOpn.stVal	BLK_OPEN	Open blocked	1=Blocked
2837	177.05	.mcd			
2838	177.06	.BlkCls.stVal	BLK_CLOSE	Close blocked	1=Blocked
2839	177.07	.mcd			
2840	177.08	.ItlByPss.stVal	ITL_BYPASS	Interlock bypass	1=Bypass
2841	177.09	.mcd			

2.3.1.6 CTRL.DCSXSWI1 Disconnecter position indication (1)**Table 9:** *CTRL.DCSXSWI1 Disconnecter position indication (1)*

BitA	RegA	IEC 61850 name	SA name	Description	Values
		CTRL.DCSXSWI1	POSITION		
2792	174.08	.Pos.stVal.Close	-	Close bit	1=Close
2793	174.09	.Pos.stVal.Open	-	Open bit	1=Open
2794	174.10	.Pos.stVal.Fault	-	Fault bit	1=Pos(00/11)

2.3.1.7 CTRL.DCSXSWI2 Disconnecter position indication (2)**Table 10:** *CTRL.DCSXSWI2 Disconnecter position indication (2)*

BitA	RegA	IEC 61850 name	SA name	Description	Values
		CTRL.DCSXSWI2	POSITION		
2795	174.11	.Pos.stVal.Close	-	Close bit	1=Close
2796	174.12	.Pos.stVal.Open	-	Open bit	1=Open
2797	174.13	.Pos.stVal.Fault	-	Fault bit	1=Pos(00/11)

2.3.1.8 CTRL.DCSXSWI3 Disconnecter position indication (3)**Table 11:** *CTRL.DCSXSWI3 Disconnecter position indication (3)*

BitA	RegA	IEC 61850 name	SA name	Description	Values
		CTRL.DCSXSWI3	POSITION		
2798	174.14	.Pos.stVal.Close	-	Close bit	1=Close
2799	174.15	.Pos.stVal.Open	-	Open bit	1=Open
2800	175.00	.Pos.stVal.Fault	-	Fault bit	1=Pos(00/11)

2.3.1.9 CTRL.DCXSWI1 Disconnecter control (1)**Table 12:** *CTRL.DCXSWI1 Disconnecter control (1)*

BitA	RegA	IEC 61850 name	SA name	Description	Values
		CTRL.DCXSWI1	POSITION		
3472	217.00	.Pos.stVal.Close	-	Close bit	1=Close
3473	217.01	.Pos.stVal.Open	-	Open bit	1=Open
3474	217.02	.Pos.stVal.Fault	-	Fault bit	1=Pos(00/11)
3475	217.03	.Pos.stSeld	-	Control selected	1=Selected
		CTRL.DCCILO1			
3476	217.04	.EnaOpn.stVal	ENA_OPEN	Open enabled	1=Enabled
3477	217.05	.EnaCls.stVal	ENA_CLOSE	Close enabled	1=Enabled
		CTRL.DCXSWI1			

Table continues on next page

BitA	RegA	IEC 61850 name	SA name	Description	Values
3478	217.06	.BlkOpn.stVal	BLK_OPEN	Open blocked	1=Blocked
3479	217.07	.mcd			
3480	217.08	.BlkCls.stVal	BLK_CLOSE	Close blocked	1=Blocked
3481	217.09	.mcd			
		CTRL.DCCIO1			
3482	217.10	.ItlByps.stVal	ITL_BYPASS	Interlock bypass	1=Bypass
3483	217.11	.mcd			

2.3.1.10 CTRL.DCXSWI2 Disconnecter control (2)

Table 13: CTRL.DCXSWI2 Disconnecter control (2)

BitA	RegA	IEC 61850 name	SA name	Description	Values
		CTRL.DCXSWI2	POSITION		
3484	217.12	.Pos.stVal.Close	-	Close bit	1=Close
3485	217.13	.Pos.stVal.Open	-	Open bit	1=Open
3486	217.14	.Pos.stVal.Fault	-	Fault bit	1=Pos(00/11)
3487	217.15	.Pos.stSeld	-	Control selected	1=Selected
		CTRL.DCCIO2			
3488	218.00	.EnaOpn.stVal	ENA_OPEN	Open enabled	1=Enabled
3489	218.01	.EnaCls.stVal	ENA_CLOSE	Close enabled	1=Enabled
		CTRL.DCXSWI2			
3490	218.02	.BlkOpn.stVal	BLK_OPEN	Open blocked	1=Blocked
3491	218.03	.mcd			
3492	218.04	.BlkCls.stVal	BLK_CLOSE	Close blocked	1=Blocked
3493	218.05	.mcd			
		CTRL.DCCIO2			
3494	218.06	.ItlByps.stVal	ITL_BYPASS	Interlock bypass	1=Bypass
3495	218.07	.mcd			

2.3.1.11 CTRL.ESSXSWI1 Earthing switch indication (1)

Table 14: CTRL.ESSXSWI1 Earthing switch indication (1)

BitA	RegA	IEC 61850 name	SA name	Description	Values
		CTRL.ESSXSWI1	POSITION		
2801	175.01	.Pos.stVal.Close	-	Close bit	1=Close
2802	175.02	.Pos.stVal.Open	-	Open bit	1=Open
2803	175.03	.Pos.stVal.Fault	-	Fault bit	1=Pos(00/11)

2.3.1.12 CTRL.ESSXSWI2 Earthing switch indication (2)**Table 15:** CTRL.ESSXSWI2 Earthing switch indication (2)

BitA	RegA	IEC 61850 name	SA name	Description	Values
		CTRL.ESSXSWI2	POSITION		
2807	175.07	.Pos.stVal.Close	-	Close bit	1=Close
2808	175.08	.Pos.stVal.Open	-	Open bit	1=Open
2809	175.09	.Pos.stVal.Fault	-	Fault bit	1=Pos(00/11)

2.3.1.13 CTRL.ESXSWI1 Earthing switch control (1)**Table 16:** CTRL.ESXSWI1 Earthing switch control (1)

BitA	RegA	IEC 61850 name	SA name	Description	Values
		CTRL.ESXSWI1	POSITION		
3496	218.08	.Pos.stVal.Close	-	Close bit	1=Close
3497	218.09	.Pos.stVal.Open	-	Open bit	1=Open
3498	218.10	.Pos.stVal.Fault	-	Fault bit	1=Pos(00/11)
3499	218.11	.Pos.stSeld	-	Control selected	1=Selected
		CTRL.ESCILO1			
3500	218.12	.EnaOpn.stVal	ENA_OPEN	Open enabled	1=Enabled
3501	218.13	.EnaCls.stVal	ENA_CLOSE	Close enabled	1=Enabled
		CTRL.ESXSWI1			
3502	218.14	.BlkOpn.stVal	BLK_OPEN	Open blocked	1=Blocked
3503	218.15	.mcd			
3504	219.00	.BlkCls.stVal	BLK_CLOSE	Close blocked	1=Blocked
3505	219.01	.mcd			
		CTRL.ESCILO1			
3506	219.02	.ItlByps.stVal	ITL_BYPASS	Interlock bypass	1=Bypass
3507	219.03	.mcd			

2.3.1.14 LD0.ARCSARC1 Arc protection (1)**Table 17:** LD0.ARCSARC1 Arc protection (1)

BitA	RegA	IEC 61850 name	SA name	Description	Values
		LD0.ARCSARC11			
2978	186.02	.FADet.stVal	ARC_FLT_DET	Arc detected	1=Detected
2979	186.03	.mcd			
		LD0.ARCPTRC11			
2982	186.06	.Op.general	OPERATE	Stage operate	1=Operate
2983	186.07	.mcd			

2.3.1.15 LD0.ARCSARC2 Arc protection (2)

Table 18: LD0.ARCSARC2 Arc protection (2)

BitA	RegA	IEC 61850 name	SA name	Description	Values
		LD0.ARCSARC21			
2984	186.08	.FADet.stVal	ARC_FLT_DET	Arc detected	1=Detected
2985	186.09	.mcd			
		LD0.ARCPTRC21			
2988	186.12	.Op.general	OPERATE	Stage operate	1=Operate
2989	186.13	.mcd			

2.3.1.16 LD0.ARCSARC3 Arc protection (3)

Table 19: LD0.ARCSARC3 Arc protection (3)

BitA	RegA	IEC 61850 name	SA name	Description	Values
		LD0.ARCSARC31			
2990	186.14	.FADet.stVal	ARC_FLT_DET	Arc detected	1=Detected
2991	186.15	.mcd			
		LD0.ARCPTRC31			
2994	187.02	.Op.general	OPERATE	Stage operate	1=Operate
2995	187.03	.mcd			

2.3.1.17 LD0.CCBBRF1 Circuit breaker failure protection (1)

Table 20: LD0.CCBBRF1 Circuit breaker failure protection (1)

BitA	RegA	IEC 61850 name	SA name	Description	Values
		LD0.CCBBRF1			
2828	176.12	.Str.general	CB_FAULT_AL	Timer running	1=Running
2829	176.13	.mcd			
2830	176.14	.OpEx.general	TRBU	Fail, external trip	1=Ext.trip
2831	176.15	.mcd			
2832	177.00	.OpIn.general	TRRET	Internal re-trip	1=Re-trip
2833	177.01	.mcd			

2.3.1.18 LD0.CCSPVC1 Current circuit supervision (1)**Table 21:** *LD0.CCSPVC1 Current circuit supervision (1)*

BitA	RegA	IEC 61850 name	SA name	Description	Values
		LD0.CCSPVC1			
2936	183.08	.SigFailAlm.stVal	ALARM	Alarm	1=Alarm
2937	183.09	.mcd			
2938	183.10	.FailACirc.general	FAIL	Failure operate	1=Operate
2939	183.11	.mcd			

2.3.1.19 LD0.CMMXU1 Three-phase current measurement (1)**Table 22:** *LD0.CMMXU1 Three-phase current measurement (1)*

BitA	RegA	IEC 61850 name	SA name	Description	Values
		LD0.CMMXU1			
2752	172.00	.HiAlm.stVal	HIGH_ALARM	High alarm	1=Alarm
2753	172.01	.mcd			
2754	172.02	.HiWrn.stVal	HIGH_WARN	High warning	1=Warning
2755	172.03	.mcd			
2756	172.04	.LoWrn.stVal	LOW_WARN	Low warning	1=Warning
2757	172.05	.mcd			
2758	172.06	.LoAlm.stVal	LOW_ALARM	Low alarm	1=Alarm
2759	172.07	.mcd			

2.3.1.20 LD0.DEFLPDEF1 Directional earth-fault protection, low stage (1)**Table 23:** *LD0.DEFLPDEF1 Directional earth-fault protection, low stage (1)*

BitA	RegA	IEC 61850 name	SA name	Description	Values
		LD0.DEFLPTOC1			
2900	181.04	.Str.general	START	Stage start	1=Start
2901	181.05	.mcd			
2902	181.06	.Op.general	OPERATE	Stage operate	1=Operate
2903	181.07	.mcd			

2.3.1.21 LD0.EFHPTOC1 Non-directional earth-fault protection, high stage (1)

Table 24: LD0.EFHPTOC1 Non-directional earth-fault protection, high stage (1)

BitA	RegA	IEC 61850 name	SA name	Description	Values
		LD0.EFHPTOC1			
3012	188.04	.Str.general	START	Stage start	1=Start
3013	188.05	.mcd			
3014	188.06	.Op.general	OPERATE	Stage operate	1=Operate
3015	188.07	.mcd			

2.3.1.22 LD0.EFLPTOC1 Non-directional earth-fault protection low stage (1)

Table 25: LD0.EFLPTOC1 Non-directional earth-fault protection low stage (1)

BitA	RegA	IEC 61850 name	SA name	Description	Values
		LD0.EFLPTOC1			
3008	188.00	.Str.general	START	Stage start	1=Start
3009	188.01	.mcd			
3010	188.02	.Op.general	OPERATE	Stage operate	1=Operate
3011	188.03	.mcd			

2.3.1.23 LD0.ESMGAPC1 Emergency start-up (1)

Table 26: LD0.ESMGAPC1 Emergency start-up (1)

BitA	RegA	IEC 61850 name	SA name	Description	Values
		LD0.ESMGAPC1			
2934	183.06	.Str.general	ST_EMERG_ENA	Emergency start	1=Start
2935	183.07	.mcd			

2.3.1.24 LD0.FRPFRQ1 Frequency protection (1)

Table 27: LD0.FRPFRQ1 Frequency protection (1)

BitA	RegA	IEC 61850 name	SA name	Description	Values
		LD0.FRPTRC1			
3024	189.00	.Str.general	START	Stage 1 start	1=Start
3025	189.01	.mcd			
		LD0.FRPTOF1		Overfrequency	
3026	189.02	.Op.general	OPR_OFRQ	Operate	1=Operate
3027	189.03	.mcd			
		LD0.FRPTUF1		Underfrequency	
3028	189.04	.Op.general	OPR_UFRQ	Operate	1=Operate

Table continues on next page

BitA	RegA	IEC 61850 name	SA name	Description	Values
3029	189.05	.mcd			
		LD0.FRPFRC1		Frequency gradient	
3030	189.06	.Op.general	OPR_FRG	Operate	1=Operate
3031	189.07	.mcd			

2.3.1.25 LD0.FRPFRCQ2 Frequency protection (2)

Table 28: LD0.FRPFRCQ2 Frequency protection (2)

BitA	RegA	IEC 61850 name	SA name	Description	Values
		LD0.FRPTRC2			
3032	189.08	.Str.general	START	Stage 2 start	1=Start
3033	189.09	.mcd			
		LD0.FRPTOF2		Overfrequency	
3034	189.10	.Op.general	OPR_OFRQ	Operate	1=Operate
3035	189.11	.mcd			
		LD0.FRPTUF2		Underfrequency	
3036	189.12	.Op.general	OPR_UFRQ	Operate	1=Operate
3037	189.13	.mcd			
		LD0.FRPFRC2		Frequency gradient	
3038	189.14	.Op.general	OPR_FRG	Operate	1=Operate
3039	189.15	.mcd			

2.3.1.26 LD0.JAMPTOC1 Motor load jam protection (1)

Table 29: LD0.JAMPTOC1 Motor load jam protection (1)

BitA	RegA	IEC 61850 name	SA name	Description	Values
		LD0.JAMPTOC1			
2918	182.06	.Op.general	OPERATE	Stage operate	1=Operate
2919	182.07	.mcd			

2.3.1.27 LD0.LEDGGIO1 Indication LED states Color1/Color2

These LED indication points interpret the case when a signal is wired to both the OK and ALARM inputs, but inverted to the other. This means that the LED toggles between red and green colors. The default color for ALARM is red and green for OK. Colors can, however, be reconfigured with a setting parameter.

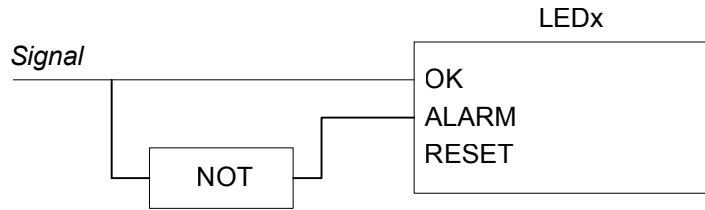

Figure 2: Signal wired to both OK and ALARM inputs – inverted to the other



If the OK and ALARM inputs are wired to separate indication signals, the LED will have three legal states and cannot be expressed with one bit only. In this case, it is possible to combine this LED bit interpretation with the corresponding value from the other LED state interpretation.

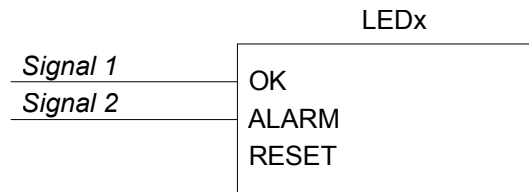

Figure 3: Separate signals wired to OK and ALARM inputs

Table 30: LD0.LEDGGIO1 Indication LED states Color1/Color2

BitA	RegA	IEC 61850 name	SA name	Description	Values
		LD0.LEDGGIO1			
3520	220.00	.LEDSt1.stVal	-	LED 1 state	0/1=Color1/2
3521	220.01	.LEDSt2.stVal	-	LED 2 state	0/1=Color1/2
3522	220.02	.LEDSt3.stVal	-	LED 3 state	0/1=Color1/2
3523	220.03	.LEDSt4.stVal	-	LED 4 state	0/1=Color1/2
3524	220.04	.LEDSt5.stVal	-	LED 5 state	0/1=Color1/2
3525	220.05	.LEDSt6.stVal	-	LED 6 state	0/1=Color1/2
3526	220.06	.LEDSt7.stVal	-	LED 7 state	0/1=Color1/2
3527	220.07	.LEDSt8.stVal	-	LED 8 state	0/1=Color1/2
3528	220.08	.LEDSt9.stVal	-	LED 9 state	0/1=Color1/2
3529	220.09	.LEDSt10.stVal	-	LED 10 state	0/1=Color1/2
3530	220.10	.LEDSt11.stVal	-	LED 11 state	0/1=Color1/2
3531	220.11	<reserved>			0

2.3.1.28 LD0.LEDGGIO1 Indication LED states OFF/ColorX

These LED indication points interpret the case when an indication signal is wired to either the OK or ALARM input of the LED function block. The default color for ALARM is red and green for OK. Colors can, however, be reconfigured with a setting parameter.

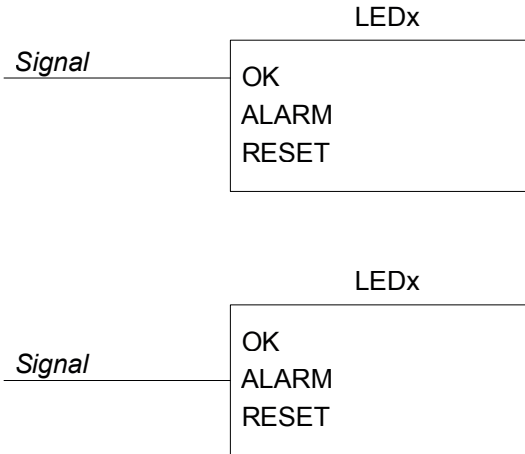

Figure 4: Signal wired to either OK or Alarm input

Table 31: LD0.LEDGGIO1 Indication LED states OFF/ColorX

BitA	RegA	IEC 61850 name	SA name	Description	Values
		LD0.LEDGGIO1			
2768	173.00	.LEDSt1.stVal	-	LED 1 state	0/1=Off/Color
2769	173.01	.LEDSt2.stVal	-	LED 2 state	0/1=Off/Color
2770	173.02	.LEDSt3.stVal	-	LED 3 state	0/1=Off/Color
2771	173.03	.LEDSt4.stVal	-	LED 4 state	0/1=Off/Color
2772	173.04	.LEDSt5.stVal	-	LED 5 state	0/1=Off/Color
2773	173.05	.LEDSt6.stVal	-	LED 6 state	0/1=Off/Color
2774	173.06	.LEDSt7.stVal	-	LED 7 state	0/1=Off/Color
2775	173.07	.LEDSt8.stVal	-	LED 8 state	0/1=Off/Color
2776	173.08	.LEDSt9.stVal	-	LED 9 state	0/1=Off/Color
2777	173.09	.LEDSt10.stVal	-	LED 10 state	0/1=Off/Color
2778	173.10	.LEDSt11.stVal	-	LED 11 state	0/1=Off/Color
2779	173.11	<reserved>			0

2.3.1.29 LD0.LEDPTRC1 Global conditioning (1)

Table 32: LD0.LEDPTRC1 Global conditioning (1)

BitA	RegA	IEC 61850 name	SA name	Description	Values
		LD0.LEDPTRC1			
2736	171.00	.Str.general	-	Global start	1=Start
2737	171.01	.mcd			
2738	171.02	.Op.general	-	Global operate	1=Operate
2739	171.03	.mcd			

2.3.1.30 LD0.LEDPTRC1 Global conditioning - phase information (1)

Table 33: LD0.LEDPTRC1 Global conditioning - phase information (1)

BitA	RegA	IEC 61850 name	SA name	Description	Values
		LD0.LEDPTRC1			
2864	179.00	.Str.phsA		Start phsA	1=Start
2865	179.01	.mcd			
2866	179.02	.Str.phsB		Start phsB	1=Start
2867	179.03	.mcd			
2868	179.04	.Str.phsC		Start phsC	1=Start
2869	179.05	.mcd			
2870	179.06	.Op.phsA		Operate phsA	1=Operate
2871	179.07	.mcd			
2872	179.08	.Op.phsB		Operate phsB	1=Operate
2873	179.09	.mcd			
2874	179.10	.Op.phsC		Operate phsC	1=Operate
2875	179.11	.mcd			

2.3.1.31 LD0.LOFLPTUC1 Loss of load supervision (1)

Table 34: LD0.LOFLPTUC1 Loss of load supervision (1)

BitA	RegA	IEC 61850 name	SA name	Description	Values
		LD0.LOFLPTUC1			
2912	182.00	.Str.general	START	Stage start	1=Start
2913	182.01	.mcd			
2914	182.02	.Op.general	OPERATE	Stage operate	1=Operate
2915	182.03	.mcd			

2.3.1.32 LD0.MAPGAPC1 Multipurpose protection (1)**Table 35:** *LD0.MAPGAPC1 Multipurpose protection (1)*

BitA	RegA	IEC 61850 name	SA name	Description	Values
		LD0.MAPGAPC1			
3056	191.00	.Op.general	OPERATE	Stage operate	1 = Operate
3057	191.01	.mcd			
3058	191.02	.Str.general	START	Stage start	1 = Start
3059	191.03	.mcd			

2.3.1.33 LD0.MAPGAPC2 Multipurpose protection (2)**Table 36:** *LD0.MAPGAPC2 Multipurpose protection (2)*

BitA	RegA	IEC 61850 name	SA name	Description	Values
		LD0.MAPGAPC2			
3060	191.04	.Op.general	OPERATE	Stage operate	1 = Operate
3061	191.05	.mcd			
3062	191.06	.Str.general	START	Stage start	1 = Start
3063	191.07	.mcd			

2.3.1.34 LD0.MAPGAPC3 Multipurpose protection (3)**Table 37:** *LD0.MAPGAPC3 Multipurpose protection (3)*

BitA	RegA	IEC 61850 name	SA name	Description	Values
		LD0.MAPGAPC3			
3064	191.08	.Op.general	OPERATE	Stage operate	1 = Operate
3065	191.09	.mcd			
3066	191.10	.Str.general	START	Stage start	1 = Start
3067	191.11	.mcd			

2.3.1.35 LD0.MAPGAPC4 Multipurpose protection (4)**Table 38:** *LD0.MAPGAPC4 Multipurpose protection (4)*

BitA	RegA	IEC 61850 name	SA name	Description	Values
		LD0.MAPGAPC4			
3068	191.12	.Op.general	OPERATE	Stage operate	1 = Operate
3069	191.13	.mcd			
3070	191.14	.Str.general	START	Stage start	1 = Start
3071	191.15	.mcd			

2.3.1.36 LD0.MAPGAPC5 Multipurpose protection (5)

Table 39: LD0.MAPGAPC5 Multipurpose protection (5)

BitA	RegA	IEC 61850 name	SA name	Description	Values
		LD0.MAPGAPC5			
3040	190.00	.Op.general	OPERATE	Stage operate	1 = Operate
3041	190.01	.mcd			
3042	190.02	.Str.general	START	Stage start	1 = Start
3043	190.03	.mcd			

2.3.1.37 LD0.MAPGAPC6 Multipurpose protection (6)

Table 40: LD0.MAPGAPC6 Multipurpose protection (6)

BitA	RegA	IEC 61850 name	SA name	Description	Values
		LD0.MAPGAPC6			
3044	190.04	.Op.general	OPERATE	Stage operate	1 = Operate
3045	190.05	.mcd			
3046	190.06	.Str.general	START	Stage start	1 = Start
3047	190.07	.mcd			

2.3.1.38 LD0.MDSOPT1 Runtime counter for machines and devices (1)

Table 41: LD0.MDSOPT1 Runtime counter for machines and devices (1)

BitA	RegA	IEC 61850 name	SA name	Description	Values
		LD0.MDSOPT1			
2876	179.12	.OpTmWrn.stVal		Accum.op.time Warn.	1=Warning
2877	179.13	.mcd			
2878	179.14	.OpTmAlm.stVal		Accum.op.time Alarm	1=Alarm
2879	179.15	.mcd			

2.3.1.39 LD0.MNSPTOC1 Negative-sequence overcurrent protection for machines (1)

Table 42: LD0.MNSPTOC1 Negative-sequence overcurrent protection for machines (1)

BitA	RegA	IEC 61850 name	SA name	Description	Values
		LD0.MNSPTOC1			
2904	181.08	.Str.general	START	Stage start	1=Start
2905	181.09	.mcd			
2906	181.10	.Op.general	OPERATE	Stage operate	1=Operate
2907	181.11	.mcd			

2.3.1.40 LD0.MNSPTOC2 Negative-sequence overcurrent protection for machines (2)

Table 43: LD0.MNSPTOC2 Negative-sequence overcurrent protection for machines (2)

BitA	RegA	IEC 61850 name	SA name	Description	Values
		LD0.MNSPTOC2			
2908	181.12	.Str.general	START	Stage start	1=Start
2909	181.13	.mcd			
2910	181.14	.Op.general	OPERATE	Stage operate	1=Operate
2911	181.15	.mcd			

2.3.1.41 LD0.MPTTR1 Thermal overload protection for motors (1)

Table 44: LD0.MPTTR1 Thermal overload protection for motors (1)

BitA	RegA	IEC 61850 name	SA name	Description	Values
		LD0.MPTTR1			
2916	182.04	.StrInh.stVal	BLK_RESTART	Block restart	1=Restart
2917	182.05	.mcd			
2930	183.02	.AlmThm.general	ALARM	Thermal alarm	1=Alarm
2931	183.03	.mcd			
2932	183.04	.Op.general	OPERATE	Thermal operate	1=Operate
2933	183.05	.mcd			

2.3.1.42 LD0.MVGAPC1 Move (8 pcs) (1)

Table 45: LD0.MVGAPC1 Move (8 pcs) (1)

BitA	RegA	IEC 61850 name	SA name	Description	Values
		LD0.MVGAPC1			
3536	221.00	.SPCSO1.stVal		Input 1	0/1=Off/On
3537	221.01	.mcd			
3538	221.02	.SPCSO2.stVal		Input 2	0/1=Off/On
3539	221.03	.mcd			
3540	221.04	.SPCSO3.stVal		Input 3	0/1=Off/On
3541	221.05	.mcd			
3542	221.06	.SPCSO4.stVal		Input 4	0/1=Off/On
3543	221.07	.mcd			
3544	221.08	.SPCSO5.stVal		Input 5	0/1=Off/On
3545	221.09	.mcd			
3546	221.10	.SPCSO6.stVal		Input 6	0/1=Off/On
3547	221.11	.mcd			

Table continues on next page

BitA	RegA	IEC 61850 name	SA name	Description	Values
3548	221.12	.SPCSO7.stVal		Input 7	0/1=Off/On
3549	221.13	.mcd			
3550	221.14	.SPCSO8.stVal		Input 8	0/1=Off/On
3551	221.15	.mcd			

2.3.1.43 LD0.MVGAPC2 Move (8 pcs) (2)

Table 46: LD0.MVGAPC2 Move (8 pcs) (2)

BitA	RegA	IEC 61850 name	SA name	Description	Values
		LD0.MVGAPC2			
3552	222.00	.SPCSO1.stVal		Input 1	0/1=Off/On
3553	222.01	.mcd			
3554	222.02	.SPCSO2.stVal		Input 2	0/1=Off/On
3555	222.03	.mcd			
3556	222.04	.SPCSO3.stVal		Input 3	0/1=Off/On
3557	222.05	.mcd			
3558	222.06	.SPCSO4.stVal		Input 4	0/1=Off/On
3559	222.07	.mcd			
3560	222.08	.SPCSO5.stVal		Input 5	0/1=Off/On
3561	222.09	.mcd			
3562	222.10	.SPCSO6.stVal		Input 6	0/1=Off/On
3563	222.11	.mcd			
3564	222.12	.SPCSO7.stVal		Input 7	0/1=Off/On
3565	222.13	.mcd			
3566	222.14	.SPCSO8.stVal		Input 8	0/1=Off/On
3567	222.15	.mcd			

2.3.1.44 LD0.NSPTOV1 Negative-sequence overvoltage protection (1)

Table 47: LD0.NSPTOV1 Negative-sequence overvoltage protection (1)

BitA	RegA	IEC 61850 name	SA name	Description	Values
		LD0.NSPTOV1			
2968	185.08	.Str.general	START	General start	1=Start
2969	185.09	.mcd			
2970	185.10	.Str.phsA		phsA start	1=Start
2971	185.11	.mcd			
2972	185.12	.Str.phsB		phsB start	1=Start
2973	185.13	.mcd			
2974	185.14	.Str.phsC		phsC start	1=Start

Table continues on next page

BitA	RegA	IEC 61850 name	SA name	Description	Values
2975	185.15	.mcd			
2976	186.00	.Op.general	OPERATE	General operate	1=Operate
2977	186.01	.mcd			

2.3.1.45 LD0.PHIPTOC1 Three-phase non-directional overcurrent protection, instantaneous stage (1)

Table 48: LD0.PHIPTOC1 Three-phase non-directional overcurrent protection, instantaneous stage (1)

BitA	RegA	IEC 61850 name	SA name	Description	Values
		LD0.PHIPTOC1			
2890	180.10	.Str.general	START	General start	1=Start
2891	180.11	.mcd			
2892	180.12	.Str.phsA		phsA start	1=Start
2893	180.13	.mcd			
2894	180.14	.Str.phsB		phsB start	1=Start
2895	180.15	.mcd			
2896	181.00	.Str.phsC		phsC start	1=Start
2897	181.01	.mcd			
2898	181.02	.Op.general	OPERATE	General operate	1=Operate
2899	181.03	.mcd			

2.3.1.46 LD0.PHLPTOC1 Three-phase non-directional overcurrent protection, low stage (1)

Table 49: LD0.PHLPTOC1 Three-phase non-directional overcurrent protection, low stage (1)

BitA	RegA	IEC 61850 name	SA name	Description	Values
		LD0.PHLPTOC1			
2880	180.00	.Str.general	START	General start	1=Start
2881	180.01	.mcd			
2882	180.02	.Str.phsA		Phs A start	1=Start
2883	180.03	.mcd			
2884	180.04	.Str.phsB		Phs B start	1=Start
2885	180.05	.mcd			
2886	180.06	.Str.phsC		Phs C start	1=Start
2887	180.07	.mcd			
2888	180.08	.Op.general	OPERATE	General operate	1=Operate
2889	180.09	.mcd			

2.3.1.47 LD0.PHPTUV1 Three-phase undervoltage protection (1)

Table 50: LD0.PHPTUV1 Three-phase undervoltage protection (1)

BitA	RegA	IEC 61850 name	SA name	Description	Values
		LD0.PHPTUV1			
2958	184.14	.Str.general	START	General start	1=Start
2959	184.15	.mcd			
2960	185.00	.Str.phsA		phsA start	1=Start
2961	185.01	.mcd			
2962	185.02	.Str.phsB		phsB start	1=Start
2963	185.03	.mcd			
2964	185.04	.Str.phsC		phsC start	1=Start
2965	185.05	.mcd			
2966	185.06	.Op.general	OPERATE	General operate	1=Operate
2967	185.07	.mcd			

2.3.1.48 LD0.PREVPTOC1 Phase reversal protection (1)

Table 51: LD0.PREVPTOC1 Phase reversal protection (1)

BitA	RegA	IEC 61850 name	SA name	Description	Values
		LD0.PREVPTOC1			
2926	182.14	.Str.general	START	Stage start	1=Start
2927	182.15	.mcd			
2928	183.00	.Op.general	OPERATE	Stage operate	1=Operate
2929	183.01	.mcd			

2.3.1.49 LD0.PSPTUV1 Positive-sequence undervoltage protection (1)

Table 52: LD0.PSPTUV1 Positive-sequence undervoltage protection (1)

BitA	RegA	IEC 61850 name	SA name	Description	Values
		LD0.PSPTUV1			
2948	184.04	.Str.general	START	General start	1=Start
2949	184.05	.mcd			
2950	184.06	.Str.phsA		phsA start	1=Start
2951	184.07	.mcd			
2952	184.08	.Str.phsB		phsB start	1=Start
2953	184.09	.mcd			
2954	184.10	.Str.phsC		phsC start	1=Start
2955	184.11	.mcd			
2956	184.12	.Op.general	OPERATE	General operate	1=Operate
2957	184.13	.mcd			

2.3.1.50 LD0.RESCMMXU1 Residual current measurement (1)**Table 53:** *LD0.RESCMMXU1 Residual current measurement (1)*

BitA	RegA	IEC 61850 name	SA name	Description	Values
		LD0.RESCMMXU1			
2760	172.08	.HiAlm.stVal	HIGH_ALARM	High alarm	1=Alarm
2761	172.09	.mcd			
2762	172.10	.HiWrn.stVal	HIGH_WARN	High warning	1=Warning
2763	172.11	.mcd			

2.3.1.51 LD0.RESVMMXU1 Residual voltage measurement (1)**Table 54:** *LD0.RESVMMXU1 Residual voltage measurement (1)*

BitA	RegA	IEC 61850 name	SA name	Description	Values
		LD0.RESVMMXU1			
2764	172.12	.HiAlm.stVal	HIGH_ALARM	High alarm	1=Alarm
2765	172.13	.mcd			
2766	172.14	.HiWrn.stVal	HIGH_WARN	High warning	1=Warning
2767	172.15	.mcd			

2.3.1.52 LD0.SEQSPVC1 Fuse failure protection (1)**Table 55:** *LD0.SEQSPVC1 Fuse failure protection (1)*

BitA	RegA	IEC 61850 name	SA name	Description	Values
		LD0.SEQSPVC1			
2940	183.12	.Str.general	FUSEF_U	Start	1=Start
2941	183.13	.mcd			
2942	183.14	.Str3Ph.general	FUSEF_3PH	3-phase start	1=Start
2943	183.15	.mcd			

2.3.1.53 LD0.SPCGAPC2 Generic control point (16 pcs) (2)**Table 56:** *LD0.SPCGAPC2 Generic control point (16 pcs) (2)*

BitA	RegA	IEC 61850 name	SA name	Description	Values
		LD0.SPCGAPC2			
3632	227.00	.SPCS01.stVal		Ouput state 1	0/1=Off/On
3633	227.01	.mcd			
3634	227.02	.SPCS02.stVal		Ouput state 2	0/1=Off/On
3635	227.03	.mcd			
3636	227.04	.SPCS03.stVal		Ouput state 3	0/1=Off/On

Table continues on next page

BitA	RegA	IEC 61850 name	SA name	Description	Values
3637	227.05	.mcd			
3638	227.06	.SPCS04.stVal		Ouput state 4	0/1=Off/On
3639	227.07	.mcd			
3640	227.08	.SPCS05.stVal		Ouput state 5	0/1=Off/On
3641	227.09	.mcd			
3642	227.10	.SPCS06.stVal		Ouput state 6	0/1=Off/On
3643	227.11	.mcd			
3644	227.12	.SPCS07.stVal		Ouput state 7	0/1=Off/On
3645	227.13	.mcd			
3646	227.14	.SPCS08.stVal		Ouput state 8	0/1=Off/On
3647	227.15	.mcd			
3648	228.00	.SPCS09.stVal		Ouput state 9	0/1=Off/On
3649	228.01	.mcd			
3650	228.02	.SPCS10.stVal		Ouput state 10	0/1=Off/On
3651	228.03	.mcd			
3652	228.04	.SPCS11.stVal		Ouput state 11	0/1=Off/On
3653	228.05	.mcd			
3654	228.06	.SPCS12.stVal		Ouput state 12	0/1=Off/On
3655	228.07	.mcd			
3656	228.08	.SPCS13.stVal		Ouput state 13	0/1=Off/On
3657	228.09	.mcd			
3658	228.10	.SPCS14.stVal		Ouput state 14	0/1=Off/On
3659	228.11	.mcd			
3660	228.12	.SPCS15.stVal		Ouput state 15	0/1=Off/On
3661	228.13	.mcd			
3662	228.14	.SPCS16.stVal		Ouput state 16	0/1=Off/On
3663	228.15	.mcd			

2.3.1.54 LD0.SSCBR1 Circuit-breaker condition monitoring (1)

Table 57: LD0.SSCBR1 Circuit-breaker condition monitoring (1)

BitA	RegA	IEC 61850 name	SA name	Description	Values
		LD0.SSCBR1			
2848	178.00	.OpnAlm.stVal	TRV_T_OP_ALM	Opn travel time alarm	1=Alarm
2849	178.01	.ClsAlm.stVal	TRV_T_CL_ALM	Cls travel time alarm	1=Alarm
		LD0.SSOPM1			
2850	178.02	.SprChaAlm.stVal	SPR_CHR_ALM	Spring charge alarm	1=Alarm
		LD0.SSCBR1			
2851	178.03	.OpCntAlm.stVal	OPR_ALM	CB operations alarm	1=Alarm

Table continues on next page

BitA	RegA	IEC 61850 name	SA name	Description	Values
2852	178.04	.OpCntLO.stVal	OPR_LO	CB operations lockout	1=Lockout
2853	178.05	.LonTmAlm.stVal	MON_ALM	CB inactive alarm	1=Alarm
		LD0.SSIGM1			
2854	178.06	.InsAlm.stVal	PRES_ALM	Low pressure alarm	1=Alarm
2855	178.07	.InsBlk.stVal	PRES_LO	Low pressure lockout	1=Lockout
		LD0.SSCBR1			
2856	178.08	.APwrAlm.stVal	IPOW_ALM	Lyt alarm	1=Alarm
2857	178.09	.APwrLO.stVal	IPOW_LO	Lyt lockout	1=Lockout
2858	178.10	.RmnNumOpAlm.stVal	CB_LIFE_ALM	CB lifetime alarm	1=Alarm

2.3.1.55 LD0.STTPMSU1 Motor start-up supervision (1)

Table 58: LD0.STTPMSU1 Motor start-up supervision (1)

BitA	RegA	IEC 61850 name	SA name	Description	Values
		LD0.STTPMSS1			
2920	182.08	.Str.general	MOT_START	Startup in progress	1=In progress
2921	182.09	.mcd			
2922	182.10	.Op.general	OPR_IIT	Thermal stress operate	1=Operate
2923	182.11	.mcd			
		LD0.STTPMRI1			
2924	182.12	.Op.general	OPR_STALL	Stalling operate	1=Operate
2925	182.13	.mcd			

2.3.1.56 LD0.TCSSCBR1 Trip circuit supervision (1)

Table 59: LD0.TCSSCBR1 Trip circuit supervision (1)

BitA	RegA	IEC 61850 name	SA name	Description	Values
		LD0.TCSSCBR1			
2780	173.12	.CircAlm.stVal	ALARM	Supervision alarm	1=Alarm
2781	173.13	.mcd			

2.3.1.57 LD0.TCSSCBR2 Trip circuit supervision (2)

Table 60: LD0.TCSSCBR2 Trip circuit supervision (2)

BitA	RegA	IEC 61850 name	SA name	Description	Values
		LD0.TCSSCBR2			
2782	173.14	.CircAlm.stVal	ALARM	Supervision alarm	1=Alarm
2783	173.15	.mcd			

2.3.1.58 LD0.TRPPTRC1 Master trip (1)

Table 61: LD0.TRPPTRC1 Master trip (1)

BitA	RegA	IEC 61850 name	SA name	Description	Values
		LD0.TRPPTRC1			
2740	171.04	.Op.general	-	Op. input signal	1=Operate
2741	171.05	.mcd			
2742	171.06	.Tr.general	-	Trip output signal	1=Trip
2743	171.07	.mcd			

2.3.1.59 LD0.TRPPTRC2 Master trip (2)

Table 62: LD0.TRPPTRC2 Master trip (2)

BitA	RegA	IEC 61850 name	SA name	Description	Values
		LD0.TRPPTRC2			
2744	171.08	.Op.general	-	Op. input signal	1=Operate
2745	171.09	.mcd			
2746	171.10	.Tr.general	-	Trip output signal	1=Trip
2747	171.11	.mcd			

2.3.1.60 LD0.VMMXU1 Three-phase voltage measurement (1)

Table 63: LD0.VMMXU1 Three-phase voltage measurement (1)

BitA	RegA	IEC 61850 name	SA name	Description	Values
		LD0.VMMXU1			
2784	174.00	.HiAlm.stVal	HIGH_ALARM	High alarm	1=Alarm
2785	174.01	.mcd			
2786	174.02	.HiWrn.stVal	HIGH_WARN	High warning	1=Warning
2787	174.03	.mcd			
2788	174.04	.LoWrn.stVal	LOW_WARN	Low warning	1=Warning
2789	174.05	.mcd			
2790	174.06	.LoAlm.stVal	LOW_ALARM	Low alarm	1=Alarm
2791	174.07	.mcd			

2.3.1.61 LD0.XAGGIO130 Physical I/O states (AIM card XA130)**Table 64:** *LD0.XAGGIO130 Physical I/O states (AIM card XA130)*

BitA	RegA	IEC 61850 name	SA name	Description	Values
		LD0.XAGGIO130			
3280	205.00	.Ind1.stVal		XA130-Input 1 State	0/1=Off/On
3281	205.01	.mcd			
		.mom-only		Mom only alternative	
3282	205.02	.Ind2.stVal		XA130-Input 2 State	0/1=Off/On
3283	205.03	.mcd			
		.mom-only		Mom only alternative	
3284	205.04	.Ind3.stVal		XA130-Input 3 State	0/1=Off/On
3285	205.05	.mcd			
		.mom-only		Mom only alternative	
3286	205.06	.Ind4.stVal		XA130-Input 4 State	0/1=Off/On
3287	205.07	.mcd			
		.mom-only		Mom only alternative	

2.3.1.62 LD0.XBGGIO110 Physical I/O states (BIO card XB110)**Table 65:** *LD0.XBGGIO110 Physical I/O states (BIO card XB110)*

BitA	RegA	IEC 61850 name	SA name	Description	Values
		LD0.XBGGIO110			
3216	201.00	.Ind1.stVal		X110-Input 1 State	0/1=Off/On
3217	201.01	.mcd			
		.mom-only		Mom only alternative	
3218	201.02	.Ind2.stVal		X110-Input 2 State	0/1=Off/On
3219	201.03	.mcd			
		.mom-only		Mom only alternative	
3220	201.04	.Ind3.stVal		X110-Input 3 State	0/1=Off/On
3221	201.05	.mcd			
		.mom-only		Mom only alternative	
3222	201.06	.Ind4.stVal		X110-Input 4 State	0/1=Off/On
3223	201.07	.mcd			
		.mom-only		Mom only alternative	
3224	201.08	.Ind5.stVal		X110-Input 5 State	0/1=Off/On
3225	201.09	.mcd			
		.mom-only		Mom only alternative	
3226	201.10	.Ind6.stVal		X110-Input 6 State	0/1=Off/On
3227	201.11	.mcd			

Table continues on next page

BitA	RegA	IEC 61850 name	SA name	Description	Values
		.mom-only		Mom only alternative	
3228	201.12	.Ind7.stVal		X110-Input 7 State	0/1=Off/On
3229	201.13	.mcd			
		.mom-only		Mom only alternative	
3230	201.14	.Ind8.stVal		X110-Input 8 State	0/1=Off/On
3231	201.15	.mcd			
		.mom-only		Mom only alternative	
3232	202.00	.SPCSO1.stVal		X110-Output 1 State	0/1=Off/On
3233	202.01	.mcd			
		.mom-only		Mom only alternative	
3234	202.02	.SPCSO2.stVal		X110-Output 2 State	0/1=Off/On
3235	202.03	.mcd			
		.mom-only		Mom only alternative	
3236	202.04	.SPCSO3.stVal		X110-Output 3 State	0/1=Off/On
3237	202.05	.mcd			
		.mom-only		Mom only alternative	

2.3.1.63 LD0.XGGIO100 Physical I/O states (PSM card X100)

Table 66: LD0.XGGIO100 Physical I/O states (PSM card X100)

BitA	RegA	IEC 61850 name	SA name	Description	Values
		LD0.XGGIO100			
3248	203.00	.SPCSO1.stVal		X100-Output 1 State	0/1=Off/On
3249	203.01	.mcd			
		.mom-only		Mom only alternative	
3250	203.02	.SPCSO2.stVal		X100-Output 2 State	0/1=Off/On
3251	203.03	.mcd			
		.mom-only		Mom only alternative	
3252	203.04	.SPCSO3.stVal		X100-Output 3 State	0/1=Off/On
3253	203.05	.mcd			
		.mom-only		Mom only alternative	
3254	203.06	.SPCSO4.stVal		X100-Output 4 State	0/1=Off/On
3255	203.07	.mcd			
		.mom-only		Mom only alternative	
3256	203.08	.SPCSO5.stVal		X100-Output 5 State	0/1=Off/On
3257	203.09	.mcd			
		.mom-only		Mom only alternative	
3258	203.10	.SPCSO6.stVal		X100-Output 6 State	0/1=Off/On
3259	203.11	.mcd			
		.mom-only		Mom only alternative	

2.3.1.64 LD0.XGGIO110 Physical I/O states (BIO card X110)**Table 67:** *LD0.XGGIO110 Physical I/O states (BIO card X110)*

BitA	RegA	IEC 61850 name	SA name	Description	Values
		LD0.XGGIO110			
3216	201.00	.Ind1.stVal		X110-Input 1 State	0/1=Off/On
3217	201.01	.mcd			
		.mom-only		Mom only alternative	
3218	201.02	.Ind2.stVal		X110-Input 2 State	0/1=Off/On
3219	201.03	.mcd			
		.mom-only		Mom only alternative	
3220	201.04	.Ind3.stVal		X110-Input 3 State	0/1=Off/On
3221	201.05	.mcd			
		.mom-only		Mom only alternative	
3222	201.06	.Ind4.stVal		X110-Input 4 State	0/1=Off/On
3223	201.07	.mcd			
		.mom-only		Mom only alternative	
3224	201.08	.Ind5.stVal		X110-Input 5 State	0/1=Off/On
3225	201.09	.mcd			
		.mom-only		Mom only alternative	
3226	201.10	.Ind6.stVal		X110-Input 6 State	0/1=Off/On
3227	201.11	.mcd			
		.mom-only		Mom only alternative	
3228	201.12	.Ind7.stVal		X110-Input 7 State	0/1=Off/On
3229	201.13	.mcd			
		.mom-only		Mom only alternative	
3230	201.14	.Ind8.stVal		X110-Input 8 State	0/1=Off/On
3231	201.15	.mcd			
		.mom-only		Mom only alternative	
3232	202.00	.SPCSO1.stVal		X110-Output 1 State	0/1=Off/On
3233	202.01	.mcd			
		.mom-only		Mom only alternative	
3234	202.02	.SPCSO2.stVal		X110-Output 2 State	0/1=Off/On
3235	202.03	.mcd			
		.mom-only		Mom only alternative	
3236	202.04	.SPCSO3.stVal		X110-Output 3 State	0/1=Off/On
3237	202.05	.mcd			
		.mom-only		Mom only alternative	
3238	202.06	.SPCSO4.stVal		X110-Output 4 State	0/1=Off/On
3239	202.07	.mcd			
		.mom-only		Mom only alternative	

2.3.1.65 LD0.XGGIO120 Physical I/O states (AIM card X120)

Table 68: LD0.XGGIO120 Physical I/O states (AIM card X120)

BitA	RegA	IEC 61850 name	SA name	Description	Values
		LD0.XGGIO120			
3200	200.00	.Ind1.stVal		X120-Input 1 State	0/1=Off/On
3201	200.01	.mcd			
		.mom-only		Mom only alternative	
3202	200.02	.Ind2.stVal		X120-Input 2 State	0/1=Off/On
3203	200.03	.mcd			
		.mom-only		Mom only alternative	
3204	200.04	.Ind3.stVal		X120-Input 3 State	0/1=Off/On
3205	200.05	.mcd			
		.mom-only		Mom only alternative	
3206	200.06	.Ind4.stVal		X120-Input 4 State	0/1=Off/On
3207	200.07	.mcd			
		.mom-only		Mom only alternative	

2.3.1.66 LD0.XGGIO130 Physical I/O states (BIO card X130)

Table 69: LD0.XGGIO130 Physical I/O states (BIO card X130)

BitA	RegA	IEC 61850 name	SA name	Description	Values
		LD0.XGGIO130			
3184	199.00	.Ind1.stVal		X130-Input 1 State	0/1=Off/On
3185	199.01	.mcd			
		.mom-only		Mom only alternative	
3186	199.02	.Ind2.stVal		X130-Input 2 State	0/1=Off/On
3187	199.03	.mcd			
		.mom-only		Mom only alternative	
3188	199.04	.Ind3.stVal		X130-Input 3 State	0/1=Off/On
3189	199.05	.mcd			
		.mom-only		Mom only alternative	
3190	199.06	.Ind4.stVal		X130-Input 4 State	0/1=Off/On
3191	199.07	.mcd			
		.mom-only		Mom only alternative	
3192	199.08	.Ind5.stVal		X130-Input 5 State	0/1=Off/On
3193	199.09	.mcd			
		.mom-only		Mom only alternative	
3194	199.10	.Ind6.stVal		X130-Input 6 State	0/1=Off/On
3195	199.11	.mcd			

Table continues on next page

BitA	RegA	IEC 61850 name	SA name	Description	Values
		.mom-only		Mom only alternative	
3264	204.00	.SPCSO1.stVal		X130-Output 1 State	0/1=Off/On
3265	204.01	.mcd			
		.mom-only		Mom only alternative	
3266	204.02	.SPCSO2.stVal		X130-Output 2 State	0/1=Off/On
3267	204.03	.mcd			
		.mom-only		Mom only alternative	
3268	204.04	.SPCSO3.stVal		X130-Output 3 State	0/1=Off/On
3269	204.05	.mcd			
		.mom-only		Mom only alternative	

2.3.1.67 LD0.XRGGIO130 Alarm/warning

Table 70: LD0.XRGGIO130 Alarm/warning

BitA	RegA	IEC 61850 name	SA name	Description	Values
		LD0.XRGGIO130			
3072	192.00	.Alm.stVal	-	XRGGIO130 Alarm	1=Alarm
3073	192.01	.mcd			
3074	192.02	.Wrn.stVal	-	XRGGIO130 Warning	1=Warning
3075	192.03	.mcd			

2.3.2 Unmapped indications

Unmapped indications are indication data that have no initial Modbus mapping locations, but can be added to the user-definable Modbus area using the Communication Management tool in PCM600. If Modbus events are enabled for these indication signals, the event identification is the user-definable area address.

2.3.2.1 All premapped three-phase protection function stages, operate/phase-dependent objects added

Table 71: All premapped three-phase protection function stages, operate/phase-dependent objects added

BitA	RegA	IEC 61850 name	SA name	Description	Values
		LD0.xxxxxxxx (various)			
		.Op.phsA		Phs A operate	1 = Operate
		.mcd			
		.Op.phsB		Phs B operate	1 = Operate
		.mcd			
		.Op.phsC		Phs C operate	1 = Operate
		.mcd			

2.3.2.2 Common data 2

Table 72: Common data 2

BitA	RegA	IEC 61850 name	SA name	Description	Values
		LD0.LDEV1			
		.StLstOv.stVal		Internal ind. overflow	1=Overflow
		.mcd			
		.MeasLstOv.stVal		Internal meas. overflow	1=Overflow
		.mcd			
		.ChgFlg.stVal		Configuration changed	1=Changed
		.mcd			
		.FacSet.stVal		Factory settings in use	1=In use
		.mcd			
		LD0.GNRLTMS1			
		.TmChSt1.stVal		Time synch. status	0/1=Down/Up
		.mcd			
		LD0.SCHLCCH1			
		.ChLiv.stVal	CH1LIV	Ethernet channel 1 live	1=Live
		.mcd			
		LD0.SCHLCCH2			
		.ChLiv.stVal	CH2LIV	Ethernet channel 2 live	1=Live
		.mcd			
		LD0.SCHLCCH3			
		.ChLiv.stVal	CH3LIV	Ethernet channel 3 live	1=Live
		.mcd			

2.3.2.3 LD0.DIAGLCCH1 Ethernet supervision (1)

Table 73: LD0.DIAGLCCH1 Ethernet supervision (1)

BitA	RegA	IEC 61850 name	SA name	Description	Values
		LD0.DIAGLCCH1			
		.ChLiv.stVal	CHLIV	Ethernet channel live	1=Live
		.mcd			
		.RedChLiv.stVal	REDCHLIV	Red. Ethernet channel live	1=Live
		.mcd			

2.3.2.4 LD0.IL1TCTR1 Three-phase CT supervision (1)*Table 74: LD0.IL1TCTR1 Three-phase CT supervision (1)*

BitA	RegA	IEC 61850 name	SA name	Description	Values
		LD0.IL1TCTR1			
		.Alm.stVal	ALARM	Alarm	1=Alarm
		.mcd			
		.Wrn.stVal	WARNING	Warning	1=Warning
		.mcd			

2.3.2.5 LD0.LDPRLRC1 Load profile record (1)*Table 75: LD0.LDPRLRC1 Load profile record (1)*

BitA	RegA	IEC 61850 name	SA name	Description	Value
		LD0.LDPRLRC1			
		.MemWrn.stVal		Recording memory warning	1=Warning
		.mcd			
		.MemAlm.stVal		Recording memory alarm	1=Alarm
		.mcd			

2.3.2.6 LD0.MAPGAPC7 Multipurpose protection (7)*Table 76: LD0.MAPGAPC7 Multipurpose protection (7)*

BitA	RegA	IEC 61850 name	SA name	Description	Values
		LD0.MAPGAPC7			
		.Str.general	START	Stage start	1 = Start
		.mcd			
		.Op.general	OPERATE	Stage operate	1 = Operate
		.mcd			

2.3.2.7 LD0.MAPGAPC8 Multipurpose protection (8)*Table 77: LD0.MAPGAPC8 Multipurpose protection (8)*

BitA	RegA	IEC 61850 name	SA name	Description	Values
		LD0.MAPGAPC8			
		.Str.general	START	Stage start	1 = Start
		.mcd			
		.Op.general	OPERATE	Stage operate	1 = Operate
		.mcd			

2.3.2.8 LD0.MAPGAPC9 Multipurpose protection (9)

Table 78: LD0.MAPGAPC9 Multipurpose protection (9)

BitA	RegA	IEC 61850 name	SA name	Description	Values
		LD0.MAPGAPC9			
		.Str.general	START	Stage start	1 = Start
		.mcd			
		.Op.general	OPERATE	Stage operate	1 = Operate
		.mcd			

2.3.2.9 LD0.MAPGAPC10 Multipurpose protection (10)

Table 79: LD0.MAPGAPC10 Multipurpose protection (10)

BitA	RegA	IEC 61850 name	SA name	Description	Values
		LD0.MAPGAPC10			
		.Str.general	START	Stage start	1 = Start
		.mcd			
		.Op.general	OPERATE	Stage operate	1 = Operate
		.mcd			

2.3.2.10 LD0.MAPGAPC11 Multipurpose protection (11)

Table 80: LD0.MAPGAPC11 Multipurpose protection (11)

BitA	RegA	IEC 61850 name	SA name	Description	Values
		LD0.MAPGAPC11			
		.Str.general	START	Stage start	1 = Start
		.mcd			
		.Op.general	OPERATE	Stage operate	1 = Operate
		.mcd			

2.3.2.11 LD0.MAPGAPC12 Multipurpose protection (12)

Table 81: LD0.MAPGAPC12 Multipurpose protection (12)

BitA	RegA	IEC 61850 name	SA name	Description	Values
		LD0.MAPGAPC12			
		.Str.general	START	Stage start	1 = Start
		.mcd			
		.Op.general	OPERATE	Stage operate	1 = Operate
		.mcd			

2.3.2.12 LD0.MAPGAPC13 Multipurpose protection (13)**Table 82:** *LD0.MAPGAPC13 Multipurpose protection (13)*

BitA	RegA	IEC 61850 name	SA name	Description	Values
		LD0.MAPGAPC13			
		.Str.general	START	Stage start	1 = Start
		.mcd			
		.Op.general	OPERATE	Stage operate	1 = Operate
		.mcd			

2.3.2.13 LD0.MAPGAPC14 Multipurpose protection (14)**Table 83:** *LD0.MAPGAPC14 Multipurpose protection (14)*

BitA	RegA	IEC 61850 name	SA name	Description	Values
		LD0.MAPGAPC14			
		.Str.general	START	Stage start	1 = Start
		.mcd			
		.Op.general	OPERATE	Stage operate	1 = Operate
		.mcd			

2.3.2.14 LD0.MAPGAPC15 Multipurpose protection (15)**Table 84:** *LD0.MAPGAPC15 Multipurpose protection (15)*

BitA	RegA	IEC 61850 name	SA name	Description	Values
		LD0.MAPGAPC15			
		.Str.general	START	Stage start	1 = Start
		.mcd			
		.Op.general	OPERATE	Stage operate	1 = Operate
		.mcd			

2.3.2.15 LD0.MAPGAPC16 Multipurpose protection (16)**Table 85:** *LD0.MAPGAPC16 Multipurpose protection (16)*

BitA	RegA	IEC 61850 name	SA name	Description	Values
		LD0.MAPGAPC1			
		.Str.general	START	Stage start	1 = Start
		.mcd			
		.Op.general	OPERATE	Stage operate	1 = Operate
		.mcd			

2.3.2.16 LD0.MAPGAPC17 Multipurpose protection (17)

Table 86: LD0.MAPGAPC17 Multipurpose protection (17)

BitA	RegA	IEC 61850 name	SA name	Description	Values
		LD0.MAPGAPC17			
		.Str.general	START	Stage start	1 = Start
		.mcd			
		.Op.general	OPERATE	Stage operate	1 = Operate
		.mcd			

2.3.2.17 LD0.MAPGAPC18 Multipurpose protection (18)

Table 87: LD0.MAPGAPC18 Multipurpose protection (18)

BitA	RegA	IEC 61850 name	SA name	Description	Values
		LD0.MAPGAPC18			
		.Str.general	START	Stage start	1 = Start
		.mcd			
		.Op.general	OPERATE	Stage operate	1 = Operate
		.mcd			

2.3.2.18 LD0.PHHPTOC1 Three-phase non-directional overcurrent protection, high stage (1)

Table 88: LD0.PHHPTOC1 Three-phase non-directional overcurrent protection, high stage (1)

RegA	BitA	IEC 61850 name	SA name	Description	Values
		LD0.PHHPTOC1			
		.Str.general	START	General start	1=Start
		.mcd			
		.Str.phsA		Phs A start	1=Start
		.mcd			
		.Str.phsB		Phs B start	1=Start
		.mcd			
		.Str.phsC		Phs C start	1=Start
		.mcd			
		.Op.general	OPERATE	General operate	1=Operate
		.mcd			
		.Op.phsA		Phs A operate	1=Operate
		.mcd			
		.Op.phsB		Phs B operate	1=Operate

Table continues on next page

RegA	BitA	IEC 61850 name	SA name	Description	Values
		.mcd			
		.Op.phsC		Phs C operate	1=Operate
		.mcd			

2.3.2.19 LD0.RESTCTR1 Io CT supervision (1)

Table 89: LD0.RESTCTR1 Io CT supervision (1)

BitA	RegA	IEC 61850 name	SA name	Description	Values
		LD0.RESTCTR1			
		.Alm.stVal	ALARM	Alarm	1=Alarm
		.mcd			
		.Wrn.stVal	WARNING	Warning	1=Warning
		.mcd			

2.3.2.20 LD0.RESTVTR1 Uo VT supervision (1)

Table 90: LD0.RESTVTR1 Uo VT supervision (1)

BitA	RegA	IEC 61850 name	SA name	Description	Values
		LD0.RESTVTR1			
		.Alm.stVal	ALARM	Alarm	1=Alarm
		.mcd			
		.Wrn.stVal	WARNING	Warning	1=Warning
		.mcd			

2.3.2.21 LD0.SPCGAPC1 Generic control point (16 pcs) (1)

Table 91: LD0.SPCGAPC1 Generic control point (16 pcs) (1)

BitA	RegA	IEC 61850 name	SA name	Description	Values
		LD0.SPCGAPC1			
		.SPCSO1.stVal		Ouput state 1	0/1=Off/On
		.mcd			
		.SPCSO2.stVal		Ouput state 2	0/1=Off/On
		.mcd			
		.SPCSO3.stVal		Ouput state 3	0/1=Off/On
		.mcd			
		.SPCSO4.stVal		Ouput state 4	0/1=Off/On
		.mcd			
		.SPCSO5.stVal		Ouput state 5	0/1=Off/On
		.mcd			

Table continues on next page

BitA	RegA	IEC 61850 name	SA name	Description	Values
		.SPCSO6.stVal		Ouput state 6	0/1=Off/On
		.mcd			
		.SPCSO7.stVal		Ouput state 7	0/1=Off/On
		.mcd			
		.SPCSO8.stVal		Ouput state 8	0/1=Off/On
		.mcd			
		.SPCSO9.stVal		Ouput state 9	0/1=Off/On
		.mcd			
		.SPCSO10.stVal		Ouput state 10	0/1=Off/On
		.mcd			
		.SPCSO11.stVal		Ouput state 11	0/1=Off/On
		.mcd			
		.SPCSO12.stVal		Ouput state 12	0/1=Off/On
		.mcd			
		.SPCSO13.stVal		Ouput state 13	0/1=Off/On
		.mcd			
		.SPCSO14.stVal		Ouput state 14	0/1=Off/On
		.mcd			
		.SPCSO15.stVal		Ouput state 15	0/1=Off/On
		.mcd			
		.SPCSO16.stVal		Ouput state 16	0/1=Off/On
		.mcd			

2.3.2.22 LD0.TRPPTRC3 Master trip (3)

Table 92: LD0.TRPPTRC3 Master trip (3)

BitA	RegA	IEC 61850 name	SA name	Description	Values
		LD0.TRPPTRC3			
		.Op.general		Op. input signal	1 = Operate
		.mcd			
		.Tr.general		Trip output signal	1 = Trip
		.mcd			

2.3.2.23 LD0.TRPPTRC4 Master trip (4)**Table 93:** *LD0.TRPPTRC4 Master trip (4)*

BitA	RegA	IEC 61850 name	SA name	Description	Values
		LD0.TRPPTRC4			
		.Op.general		Op. input signal	1 = Operate
		.mcd			
		.Tr.general		Trip output signal	1 = Trip
		.mcd			

2.3.2.24 LD0.TRPPTRC5 Master trip (5)**Table 94:** *LD0.TRPPTRC5 Master trip (5)*

BitA	RegA	IEC 61850 name	SA name	Description	Values
		LD0.TRPPTRC5			
		.Op.general		Op. input signal	1 = Operate
		.mcd			
		.Tr.general		Trip output signal	1 = Trip
		.mcd			

2.3.2.25 LD0.UL1TVTR1 Three-phase VT supervision (1)**Table 95:** *LD0.UL1TVTR1 Three-phase VT supervision (1)*

BitA	RegA	IEC 61850 name	SA name	Description	Values
		LD0.UL1TVTR1			
		.Alm.stVal	ALARM	Alarm	1=Alarm
		.mcd			
		.Wrn.stVal	WARNING	Warning	1=Warning
		.mcd			

2.3.2.26 LD0.XRGGIO130 Alarm/warning**Table 96:** *LD0.XRGGIO130 Alarm/warning*

BitA	RegA	IEC 61850 name	SA name	Description	Values
		LD0.XRGGIO130			
		.Alm.stVal	-	XRGGIO130 alarm	1=Alarm
		.mcd			
		.Wrn.stVal	-	XRGGIO130 warning	1=Warning
		.mcd			

2.4 Registers

Table 97: Explanations of columns in register tables

Column name	Description
RegA	Default 3X and 4X register address for the data.
Type	Type of the register. The alternatives are u16, u32 (unsigned 16 and 32 bits integer) or i16, i32 (signed 16 and 32 bit integer).
Scale	Scale factor as default. Also, an adjustable offset value exists that is set to 0 by default.
IEC 61850 name	Original IED data object identification. Described in the IEC 61850 format as Logical Device.Logical Node and thereafter .Data Object.Data Attribute. Logical Node is the same as the application function block name.
SA name	The signal may have a defined label that is visible, for example, in the Application Configuration tool in PCM600.
Description	Short description of the signal. See the technical manual for more information. Also, if a register is writable, it is stated here.
Values	The value range of the original IEC 61850 value, that is, before scaling.

2.4.1 Premapped registers

2.4.1.1 Active parameter setting group - read and write

Table 98: Active parameter setting group - read and write

RegA	Type	Scale	IEC 61850 name	SA name	Description	Values
2301	u16	1			Active setting group	1..6

2.4.1.2 Control structure 1

Table 99: Control structure 1

RegA	Type	Scale	IEC 61850 name	SA name	Description	Values
8001					Execute register	1
8002					Password reg 1	acc to setting
8003					Password reg 2	acc to setting
8004					Control register	< single bit >
8005					Confirm register	< single bit >

2.4.1.3 Control structure 2*Table 100: Control structure 2*

RegA	Type	Scale	IEC 61850 name	SA name	Description	Values
8006					Execute register	1
8007					Password reg 1	acc to setting
8008					Password reg 2	acc to setting
8009					Control register	< single bit >
8010					Confirm register	< single bit >

2.4.1.4 Control structure 3*Table 101: Control structure 3*

RegA	Type	Scale	IEC 61850 name	SA name	Description	Values
8011					Execute register	1
8012					Password reg 1	acc to setting
8013					Password reg 2	acc to setting
8014					Control register	< single bit >
8015					Confirm register	< single bit >

2.4.1.5 Control structure 4*Table 102: Control structure 4*

RegA	Type	Scale	IEC 61850 name	SA name	Description	Values
8016					Execute register	1
8017					Password reg 1	acc to setting
8018					Password reg 2	acc to setting
8019					Control register	< single bit >
8020					Confirm register	< single bit >

2.4.1.6 Control structure 5*Table 103: Control structure 5*

RegA	Type	Scale	IEC 61850 name	SA name	Description	Values
8021					Execute register	1
8022					Password reg 1	acc to setting
8023					Password reg 2	acc to setting
8024					Control register	< single bit >
8025					Confirm register	< single bit >

2.4.1.7 Control structure 6

Table 104: Control structure 6

RegA	Type	Scale	IEC 61850 name	SA name	Description	Values
8026					Execute register	1
8027					Password reg 1	acc to setting
8028					Password reg 2	acc to setting
8029					Control register	< single bit >
8030					Confirm register	< single bit >

2.4.1.8 Control structure 7

Table 105: Control structure 7

RegA	Type	Scale	IEC 61850 name	SA name	Description	Values
8031					Execute register	1
8032					Password reg 1	acc to setting
8033					Password reg 2	acc to setting
8034					Control register	< single bit >
8035					Confirm register	< single bit >

2.4.1.9 Control structure 8

Table 106: Control structure 8

RegA	Type	Scale	IEC 61850 name	SA name	Description	Values
8036					Execute register	1
8037					Password reg 1	acc to setting
8038					Password reg 2	acc to setting
8039					Control register	< single bit >
8040					Confirm register	< single bit >

2.4.1.10 Device ID string

Table 107: Device ID string

RegA	Type	Scale	IEC 61850 name	SA name	Description	Values
9000	u16				ASCII coded string	1)
...						
9120	u16					

1) See the technical manual.

2.4.1.11 Event record structure

Table 108: Event record structure

RegA	Type	Scale	IEC 61850 name	SA name	Description	Values
					Selection write:	
9250	u16	1			- Num of multiple records	1...10
9251	i16	1			- Read selection	-499...3
					Record 1 data to read:	
9252	u16	1			- Record sequence num	1...9999
9253	u16	1			- Unread records left	0...499
					Timestamp of record	
9254	u16	1			- Year, Month	Year/Month
9255	u16	1			- Day, Hour	Day/Hour
9256	u16	1			- Minute, Second	Min/Sec
9257	u16	1			- Millisecond	Millisecond
9258	u16	1			Event identification	1)
9259	u16	1			Data object ID1	1)
9260	u16	1			Data object ID2	1)
9261	u16	1			Event data value 1	1)
9262	u16	1			Event data value 2	1)
					Record 2 data to read:	If selected
9263	u16	1			- Record sequence num	1..9999
9264	u16	1			- Unread records left	0..499
					Timestamp of record	
9265	u16	1			- Year, Month	Year/Month
9266	u16	1			- Day, Hour	Day/Hour
9267	u16	1			- Minute, Second	Min/Sec
9268	u16	1			- Millisecond	Millisecond
9269	u16	1			Event identification	1)
9270	u16	1			Data object ID1	1)
9271	u16	1			Data object ID2	1)
9272	u16	1			Event data value 1	1)
9273	u16	1			Event data value 2	1)
					Record 3 data to read:	If selected
9274	u16	1			- Record sequence num	1...9999
9275	u16	1			- Unread records left	0...499
					Timestamp of record	

Table continues on next page

Section 2 Modbus data mappings

1MRS756877 H

RegA	Type	Scale	IEC 61850 name	SA name	Description	Values
9276	u16	1			- Year, Month	Year/Month
9277	u16	1			- Day, Hour	Day/Hour
9278	u16	1			- Minute, Second	Min/Sec
9279	u16	1			- Millisecond	Millisecond
9280	u16	1			Event identification	1)
9281	u16	1			Data object ID1	1)
9282	u16	1			Data object ID2	1)
9283	u16	1			Event data value 1	1)
9284	u16	1			Event data value 2	1)
					Record 4 data to read:	If selected
9285	u16	1			- Record sequence num	1...9999
9286	u16	1			- Unread records left	0...499
					Timestamp of record	
9287	u16	1			- Year, Month	Year/Month
9288	u16	1			- Day, Hour	Day/Hour
9289	u16	1			- Minute, Second	Min/Sec
9290	u16	1			- Millisecond	Millisecond
9291	u16	1			Event identification	1)
9292	u16	1			Data object ID1	1)
9293	u16	1			Data object ID2	1)
9294	u16	1			Event data value 1	1)
9295	u16	1			Event data value 2	1)
					Record 5 data to read:	If selected
9296	u16	1			- Record sequence num	1...9999
9297	u16	1			- Unread records left	0...499
					Timestamp of record	
9298	u16	1			- Year, Month	Year/Month
9299	u16	1			- Day, Hour	Day/Hour
9300	u16	1			- Minute, Second	Min/Sec
9301	u16	1			- Millisecond	Millisecond
9302	u16	1			Event identification	1)
9303	u16	1			Data object ID1	1)
9304	u16	1			Data object ID2	1)
9305	u16	1			Event data value 1	1)
9306	u16	1			Event data value 2	1)

Table continues on next page

RegA	Type	Scale	IEC 61850 name	SA name	Description	Values
					Record 6 data to read:	If selected
9307	u16	1			- Record sequence num	1...9999
9308	u16	1			- Unread records left	0...499
					Timestamp of record	
9309	u16	1			- Year, Month	Year/Month
9310	u16	1			- Day, Hour	Day/Hour
9311	u16	1			- Minute, Second	Min/Sec
9312	u16	1			- Millisecond	Millisecond
9313	u16	1			Event identification	1)
9314	u16	1			Data object ID1	1)
9315	u16	1			Data object ID2	1)
9316	u16	1			Event data value 1	1)
9317	u16	1			Event data value 2	1)
					Record 7 data to read:	If selected
9318	u16	1			- Record sequence num	1...9999
9319	u16	1			- Unread records left	0...499
					Timestamp of record	
9320	u16	1			- Year, Month	Year/Month
9321	u16	1			- Day, Hour	Day/Hour
9322	u16	1			- Minute, Second	Min/Sec
9323	u16	1			- Millisecond	Millisecond
9324	u16	1			Event identification	1)
9325	u16	1			Data object ID1	1)
9326	u16	1			Data object ID2	1)
9327	u16	1			Event data value 1	1)
9328	u16	1			Event data value 2	1)
					Record 8 data to read:	If selected
9329	u16	1			- Record sequence num	1...9999
9330	u16	1			- Unread records left	0...499
					Timestamp of record	
9331	u16	1			- Year, Month	Year/Month
9332	u16	1			- Day, Hour	Day/Hour
9333	u16	1			- Minute, Second	Min/Sec
9334	u16	1			- Millisecond	Millisecond
9335	u16	1			Event identification	1)
9336	u16	1			Data object ID1	1)

Table continues on next page

Section 2 Modbus data mappings

1MRS756877 H

RegA	Type	Scale	IEC 61850 name	SA name	Description	Values
9337	u16	1			Data object ID2	1)
9338	u16	1			Event data value 1	1)
9339	u16	1			Event data value 2	1)
					Record 9 data to read:	If selected
9340	u16	1			- Record sequence num	1...9999
9341	u16	1			- Unread records left	0...499
					Timestamp of record	
9342	u16	1			- Year, Month	Year/Month
9343	u16	1			- Day, Hour	Day/Hour
9344	u16	1			- Minute, Second	Min/Sec
9345	u16	1			- Millisecond	Millisecond
9346	u16	1			Event identification	1)
9347	u16	1			Data object ID1	1)
9348	u16	1			Data object ID2	1)
9349	u16	1			Event data value 1	1)
9350	u16	1			Event data value 2	1)
					Record 10 data to read:	If selected
9351	u16	1			- Record sequence num	1...9999
9352	u16	1			- Unread records left	0...499
					Timestamp of record	
9353	u16	1			- Year, Month	Year/Month
9354	u16	1			- Day, Hour	Day/Hour
9355	u16	1			- Minute, Second	Min/Sec
9356	u16	1			- Millisecond	Millisecond
9357	u16	1			Event identification	1)
9358	u16	1			Data object ID1	1)
9359	u16	1			Data object ID2	1)
9360	u16	1			Event data value 1	1)
9361	u16	1			Event data value 2	1)

1) See the technical manual.

2.4.1.12 Fault record structure header

Table 109: Fault record structure header

RegA	Type	Scale	IEC 61850 name	SA name	Description	Values
					Selection write	
9401	i16	1			Read selection	-99...3
					Record data header	
9402	u16	1			Record sequence num	0...65535
9403	u16	1			Unread records left	0...99
					Timestamp of record	
9404	u16	1			Year, month	Year/Month
9405	u16	1			Day, hour	Day/Hour
9406	u16	1			Minute, second	Min/Sec
9407	u16	1			Millisecond	Millisecond
9408	u16	1			Timestamp quality	

2.4.1.13 Fault record data

The table shows all potential data available in the fault record application. Which data is actually recorded depends on the functions available and enabled in the protection relay's configuration.

Table 110: Fault record data

RegA	Type	Scale	IEC 61850 name	SA name	Description	Values
			LD0.FLTRFRC1		Fault record data	
9409	u32	1	.OpCnt.stVal		Fault record number (high)	0..999999
9410					(Low word)	
9411	i16	1	.ProFnc.stVal		Protection function	-32768...32767
9412	u16	100	.Hz.mag		Frequency	30...80.00 [Hz]
9413	u16	100	.StrDur.mag		Start duration	0...100.00 [%]
9414	u32	1000	.StrOpTm.mag		Operate time [ms] (high)	0...999999.999
9415					(Low word)	
9416	u32	100	.FltPtR.mag		Fault resistance	0.00...1000000.00 ohms
9417					(Low word)	
9418	u32	100	.FltDiskm.mag		Fault distance	0.00...9999.99 pu
9419					(Low word)	
9420	u16	1	.ActSetGr.stVal		Active setting group	1...6

Table continues on next page

Section 2 Modbus data mappings

1MRS756877 H

RegA	Type	Scale	IEC 61850 name	SA name	Description	Values
9421	u16	1	.ShotPntr.stVal		AR shot pointer value	0...7
					Captured values during fault	
9422	u16	1000	.Max50DifAA.mag		Max. diff. current phs A	0.000...80.00 0 [pu]
9423	u16	1000	.Max50DifAB.mag		Max. diff. current phs B	0.000...80.00 0 [pu]
9424	u16	1000	.Max50DifAC.mag		Max. diff. current phs C	0.000...80.00 0 [pu]
9425	u16	1000	.Max50RstAA.mag		Max. bias current phs A	0.000... 50.000 [pu]
9426	u16	1000	.Max50RstAB.mag		Max. bias current phs B	0.000... 50.000 [pu]
9427	u16	1000	.Max50RstAC.mag		Max. bias current phs C	0.000... 50.000 [pu]
9428	u16	1000	.DifAPhsA.mag		Diff. current phs A	0.000...80.00 0 [pu]
9429	u16	1000	.DifAPhsB.mag		Diff. current phs B	0.000...80.00 0 [pu]
9430	u16	1000	.DifAPhsC.mag		Diff. current phs C	0.000...80.00 0 [pu]
9431	u16	1000	.RstAPhsA.mag		Bias current phs A	0.000... 50.000 [pu]
9432	u16	1000	.RstAPhsB.mag		Bias current phs B	0.000... 50.000 [pu]
9433	u16	1000	.RstAPhsC.mag		Bias current phs C	0.000... 50.000 [pu]
9434	u16	1000	.DifARes.mag		Diff. current lo	0.000...80.00 0 [pu]
9435	u16	1000	.RstARes.mag		Bias current lo	0.000... 50.000 [pu]
9436	u16	1000	.Max50APhsA1.mag		Max. current phs A(1)	0.000... 50.000 [×In]
9437	u16	1000	.Max50APhsB1.mag		Max. current phs B(1)	0.000... 50.000 [×In]
9438	u16	1000	.Max50APhsC1.mag		Max. current phs C(1)	0.000... 50.000 [×In]
9439	u16	1000	.Max50ARes1.mag		Max. current lo(1)	0.000... 50.000 [×In]
9440	u16	1000	.APhsA1.mag		Current phs A(1)	0.000... 50.000 [×In]
9441	u16	1000	.APhsB1.mag		Current phs B(1)	0.000... 50.000 [×In]
9442	u16	1000	.APhsC1.mag		Current phs C(1)	0.000... 50.000 [×In]
9443	u16	1000	.ARes1.mag		Current lo(1)	0.000... 50.000 [×In]
9444	u16	1000	.AResClc1.mag		Current lo-Calc(1)	0.000... 50.000 [×In]

Table continues on next page

RegA	Type	Scale	IEC 61850 name	SA name	Description	Values
9445	u16	1000	.APsSeq1.mag		Current Ps-Seq(1)	0.000... 50.000 [×In]
9446	u16	1000	.ANgSeq1.mag		Current Ng-Seq(1)	0.000... 50.000 [×In]
9447	u16	1000	.PhVPhsA1.mag		Voltage phs A(1)	0.000...4.000 [×Un]
9448	u16	1000	.PhVPhsB1.mag		Voltage phs B(1)	0.000...4.000 [×Un]
9449	u16	1000	.PhVPhsC1.mag		Voltage phs C(1)	0.000...4.000 [×Un]
9450	u16	1000	.PPVPhsAB1.mag		Voltage phs AB(1)	0.000...4.000 [×Un]
9451	u16	1000	.PPVPhsBC1.mag		Voltage phs BC(1)	0.000...4.000 [×Un]
9452	u16	1000	.PPVPhsCA1.mag		Voltage phs CA(1)	0.000...4.000 [×Un]
9453	u16	1000	.VRes1.mag		Voltage Uo(1)	0.000...4.000 [×Un]
9454	u16	1000	.VZro1.mag		Voltage Zro-Seq(1)	0.000...4.000 [×Un]
9455	u16	1000	.VPsSeq1.mag		Voltage Ps-Seq(1)	0.000...4.000 [×Un]
9456	u16	1000	.VNgSeq1.mag		Voltage Ng-Seq(1)	0.000...4.000 [×Un]
9457	u16	100	.MaxTmpRI.mag		PTTR thermal level	0.00...99.99
9458	u16	100	.AMaxNgPs.mag		PDNSPTOC1 ratio I2/I1	0.00...999.99 [%]
9459	i16	100	.HzRteChg.mag		Frequency gradient	-10.00...10.0 0 [Hz/s]
9460	i16	100	.CondNeut.mag		Conductance Yo	-1000.00...10 00.00 [mS]
9461	i16	100	.SusNeut.mag		Susceptance Yo	-1000.00...10 00.00 [mS]
9462	i32	100	.PPLoopRis.mag		Fault loop resistance	-1000.00...10 00.00 [ohm]
9463	i32				(Low word)	
9464	i32	100	.PPLoopReact.mag		Fault loop reactance	-1000.00...10 00.00 [ohm]
9465	i32				(Low word)	
9466	u16	1000	.CBClrTm.mag		Breaker clear time	0.000...3.000 [s]
9467	u16	1000	.APhsA2.mag		Current phs A(2)	0.000... 50.000 [×In]
9468	u16	1000	.APhsB2.mag		Current phs B(2)	0.000... 50.000 [×In]
9469	u16	1000	.APhsC2.mag		Current phs C(2)	0.000... 50.000 [×In]

Table continues on next page

Section 2 Modbus data mappings

1MRS756877 H

RegA	Type	Scale	IEC 61850 name	SA name	Description	Values
9470	u16	1000	.ARes2.mag		Current Io(2)	0.000... 50.000 [\times In]
9471	u16	1000	.AResClc2.mag		Current Io-Calc(2)	0.000... 50.000 [\times In]
9472	u16	1000	.APsSeq2.mag		Current Ps-Seq(2)	0.000... 50.000 [\times In]
9473	u16	1000	.ANgSeq2.mag		Current Ng-Seq(2)	0.000... 50.000 [\times In]
9474	u16	1000	.PhVPhsA2.mag		Voltage phs A(2)	0.000...4.000 [\times Un]
9475	u16	1000	.PhVPhsB2.mag		Voltage phs B(2)	0.000...4.000 [\times Un]
9476	u16	1000	.PhVPhsC2.mag		Voltage phs C(2)	0.000...4.000 [\times Un]
9477	u16	1000	.PPVPhsAB2.mag		Voltage phs AB(2)	0.000...4.000 [\times Un]
9478	u16	1000	.PPVPhsBC2.mag		Voltage phs BC(2)	0.000...4.000 [\times Un]
9479	u16	1000	.PPVPhsCA2.mag		Voltage phs CA(2)	0.000...4.000 [\times Un]
9480	u16	1000	.VRes2.mag		Voltage Uo(2)	0.000...4.000 [\times Un]
9481	u16	1000	.VZro2.mag		Voltage Zro-Seq(2)	0.000...4.000 [\times Un]
9482	u16	1000	.VPsSeq2.mag		Voltage Ps-Seq(2)	0.000...4.000 [\times Un]
9483	u16	1000	.VNgSeq2.mag		Voltage Ng-Seq(2)	0.000...4.000 [\times Un]
9484	i16	100	.DifANAngVN1.mag.		Angle Uo-Io(1)	-180.00... 180.00 [deg]
9485	i16	100	.DifAAAngVBC1.mag.		Angle UBC-IA(1)	-180.00... 180.00 [deg]
9486	i16	100	.DifABAngVCA1.mag		Angle UCA-IB(1)	-180.00... 180.00 [deg]
9487	i16	100	.DifACAngVAB1.mag		Angle UAB-IC(1)	-180.00... 180.00 [deg]
9488	i16	100	.DifANAngVN2.mag.		Angle Uo-Io(2)	-180.00... 180.00 [deg]
9489	i16	100	.DifAAAngVBC2.mag.		Angle UBC-IA(2)	-180.00... 180.00 [deg]
9490	i16	100	.DifABAngVCA2.mag		Angle UCA-IB(2)	-180.00... 180.00 [deg]
9491	i16	100	.DifACAngVAB2.mag		Angle UAB-IC(2)	-180.00... 180.00 [deg]

2.4.1.14 Protection relay's real-time clock (in local time mode) - read and write (synchronize)

Table 111: *Protection relay's real-time clock (in local time mode) - read and write (synchronize)*

RegA	Type	Scale	IEC 61850 name	SA name	Description	Values
9201					Control register	0...2 ¹⁾
9202					Year	2000...2999
9203					Month	1...12
9204					Day	1...31
9205					Hour	0...23
9206					Minute	0...59
9207					Second	0...59
9208					Millisecond	0...999

1) See the technical manual.

2.4.1.15 Protection relay's real-time clock (in UTC time mode) - read and write (synchronize)

Table 112: *Protection relay's real-time clock (in UTC time mode) - read and write (synchronize)*

RegA	Type	Scale	IEC 61850 name	SA name	Description	Values
9211					Control register	0...2 ¹⁾
9212					Year	2000...2999
9213					Month	1...12
9214					Day	1...31
9215					Hour	0...23
9216					Minute	0...59
9217					Second	0...59
9218					Millisecond	0...999

1) See the technical manual.

2.4.1.16 Indication bits mirrored in registers

The pre-mapped indication bit data has been mapped from indication bit address 2720 onwards. The bit data is mirrored in registers starting from register address 170 onwards.

Table 113: *Indication bits mirrored in registers*

RegA	Type	Scale	IEC 61850 name	SA name	Description	Values
170.00	Bit				Indication bit 2720 (0x1700)	
170.01	Bit				Indication bit 2721 (0x1701)	
:	:				:	

Table continues on next page

RegA	Type	Scale	IEC 61850 name	SA name	Description	Values
170.14	Bit				Indication bit 2734 (0x170E)	
170.15	Bit				Indication bit 2735 (0x170F)	
171.00	Bit				Indication bit 2736 (0x1710)	
:	:				:	

2.4.1.17 SSR1 System status register (1) device health

Table 114: SSR1 System status register (1) device health

RegA	Type	Scale	IEC 61850 name	SA name	Description	Values
128.00	Bit				Device global error	1=Error
128.01	Bit				Device global warning	1=Warning
128.02	Bit				< reserved >	0
128.03	Bit				< reserved >	0
128.04	Bit				< reserved >	0
128.05	Bit				< reserved >	0
128.06	Bit				< reserved >	0
128.07	Bit				< reserved >	0
128.08	Bit				< reserved >	0
128.09	Bit				< reserved >	0
128.10	Bit				< reserved >	0
128.11	Bit				< reserved >	0
128.12	Bit				< reserved >	0
128.13	Bit				< reserved >	0
128.14	Bit				< reserved >	0
128.15	Bit				< reserved >	0

2.4.1.18 SSR2 System status register (2) protection relay's mode and state

Table 115: SSR2 System status register (2) protection relay's mode and state

RegA	Type	Scale	IEC 61850 name	SA name	Description	Values
129.00	Bit				Device test mode	1=Test mode
129.01	Bit				< reserved >	0
129.02	Bit				Remote/Local state	0/1=Rem/Loc
					Active setting group	SG=1...6
129.03	Bit				- bit 0	
129.04	Bit				- bit 1	
129.05	Bit				- bit 2	
129.06	Bit				Protection relay's timesynch failure	1=Failure

Table continues on next page

RegA	Type	Scale	IEC 61850 name	SA name	Description	Values
129.07	Bit				< reserved >	0
129.08	Bit				Last reset cause a	1=Cold start
129.09	Bit				Last reset cause b	1=Watchdog
129.10	Bit				Last reset cause c	1=Warm start
129.11	Bit				< reserved >	0
129.12	Bit				< reserved >	0
129.13	Bit				< reserved >	0
129.14	Bit				< reserved >	0
129.15	Bit				< reserved >	0

2.4.1.19 SSR3 System status register (3) data available 1 (client-dependent)

Table 116: SSR3 System status register (3) data available 1 (client-dependent)

RegA	Type	Scale	IEC 61850 name	SA name	Description	Values
130.00	Bit				Unread event records available	1=Available
130.01	Bit				Unread fault records available	1=Available
130.02	Bit				< reserved >	0
130.03	Bit				< reserved >	0
130.04	Bit				Any momentary bit updated	1=Updated
130.05	Bit				Any mcd bit set	1=Set
130.06	Bit				Device restart bit	1=IED restart
130.07	Bit				< reserved >	0
130.08	Bit				Event record selected	1=Selected
130.09	Bit				Fault record selected	1=Selected
130.10	Bit				< reserved >	0
130.11	Bit				< reserved >	0
130.12	Bit				< reserved >	0
130.13	Bit				< reserved >	0
130.14	Bit				< reserved >	0
130.15	Bit				< reserved >	0

2.4.1.20 SSR4 System status register (4) data available 2 (client-dependent, user-definable)

Table 117: SSR4 System status register (4) data available 2 (client-dependent, user-definable)

RegA	Type	Scale	IEC 61850 name	SA name	Description	Values
131.00	Bit				Data category 1 has changed	1=Changed
131.01	Bit				Data category 2 has changed	1=Changed
131.02	Bit				Data category 3 has changed	1=Changed

Table continues on next page

RegA	Type	Scale	IEC 61850 name	SA name	Description	Values
131.03	Bit				Data category 4 has changed	1=Changed
131.04	Bit				Data category 5 has changed	1=Changed
131.05	Bit				Data category 6 has changed	1=Changed
131.06	Bit				Data category 7 has changed	1=Changed
131.07	Bit				Data category 8 has changed	1=Changed
131.08	Bit				Data category 9 has changed	1=Changed
131.09	Bit				Data category 10 has changed	1=Changed
131.10	Bit				Data category 11 has changed	1=Changed
131.11	Bit				Data category 12 has changed	1=Changed
131.12	Bit				Data category 13 has changed	1=Changed
131.13	Bit				Data category 14 has changed	1=Changed
131.14	Bit				Data category 15 has changed	1=Changed
131.15	Bit				Data category 16 has changed	1=Changed

2.4.1.21 SSR5 System status register (5) device alive register

Table 118: SSR5 System status register (5) device alive register

RegA	Type	Scale	IEC 61850 name	SA name	Description	Values
132	u16	1			Device alive counter	0...65535

2.4.1.22 SSR6 System status register (6) control command status (client-dependent)

Table 119: SSR6 System status register (6) control command status (client-dependent)

RegA	Type	Scale	IEC 61850 name	SA name	Description	Values
					Last cmd result code	1)
133.00	Bit				- bit 0	
133.01	Bit				- bit 1	
133.02	Bit				- bit 2	
133.03	Bit				- bit 3	
133.04	Bit				- bit 4	
133.05	Bit				- bit 5	
133.06	Bit				- bit 6	
133.07	Bit				- bit 7	
					Response Type	1)
133.08	Bit				- bit 0	
133.09	Bit				- bit 1	
					Command state	1)
133.10	Bit				- bit 0	

Table continues on next page

RegA	Type	Scale	IEC 61850 name	SA name	Description	Values
133.11	Bit				- bit 1	
					Cmd sequence number	0...15
133.12	Bit				- bit 0	
133.13	Bit				- bit 1	
133.14	Bit				- bit 2	
133.15	Bit				- bit 3	

1) See the technical manual.

2.4.1.23 System diagnostic values

Table 120: *System diagnostic values*

RegA	Type	Scale	IEC 61850 name	SA name	Description	Values
			LD0.LDEV1			
2050	u16	1	.DevWrn.stVal	Warning	Last warning code	1)
2051	u16	1	.DevFail.stVal	Internal fault	Last internal fault code	1)
			DR.RDRE1			
2052	u16	1	.FitNum.stVal		Num. of DR recordings	0...N
2053	u16	1	.MemUsed.stVal		DR memory used	0...100 [%]
			LD0.LPHD1			
2054	u16	1	.NumPwrUp.stVal		Num. of cold starts	0...65535
2055	u16	1	.WrmStr.stVal		Num. of warm starts	0...65535
2056	u16	1	.WacTrg.stVal		Num. of watchdog resets	0...65535
			LD0.LDEV1			
2057	u16	1	.ChgAckCnt.stVal		Num. of conf. changes	0...65535
			LD0.LLN0			
	u16	1	.ParChgCnt.stVal		Num. of setting changes	0...65535

1) See the technical manual.

2.4.1.24 Time and reason for latest protection relay reset

Table 121: *Time and reason for latest protection relay reset*

RegA	Type	Scale	IEC 61850 name	SA name	Description	Values
9221	u16	1			Year	2000...2999
9222	u16	1			Month	1...12
9223	u16	1			Day	1...31
9224	u16	1			Hour	0...23
9225	u16	1			Minute	0...59
9226	u16	1			Second	0...59
9227	u16	1			Millisecond	0...999

Table continues on next page

RegA	Type	Scale	IEC 61850 name	SA name	Description	Values
9228	u16	1			Reset reason	
9228.0	Bit				- bit 0	1=Cold start
9228.1	Bit				- bit 1	1=Watchdog
9228.2	Bit				- bit 2	1=Warm start

2.4.1.25 User-definable bits [Alt.2], visible on 0x,1x,3x and 4x

Table 122: User-definable bits [Alt.2], visible on 0x,1x,3x and 4x

BitA	Type	Scale	IEC 61850 name	SA name	Description	Values
(0)	Bit				< not mappable - not visible >	
1	Bit				Usr reg 1.Bit 01	
2	Bit				Usr reg 1.Bit 02	
3	Bit				Usr reg 1.Bit 03	
:	:				:	
:	:				:	
15	Bit				Usr reg 1.Bit 15	
16	Bit				Usr reg 2.Bit 00	
17	Bit				Usr reg 2.Bit 01	
:	:				:	
:	:				:	
2046	Bit				Usr reg 127.Bit 14	
2047	Bit				Usr reg 127.Bit 15	

2.4.1.26 User-definable registers [Alt.1], visible on 3x and 4x

Table 123: User-definable registers [Alt.1], visible on 3x and 4x

RegA	Type	Scale	IEC 61850 name	SA name	Description	Values
(0)	Reg				< not mappable - not visible >	
1	Reg				User register 1	
2	Reg				User register 2	
3	:				:	
:	:				:	
:	:				:	
127	Reg				User register 127	

2.4.1.27 CTRL.CBCSWI1 Circuit breaker operation counter (1)**Table 124:** *CTRL.CBCSWI1 Circuit breaker operation counter (1)*

RegA	Type	Scale	IEC 61850 name	SA name	Description	Values
			CTRL.CBCSWI1			
2027	u16	1	.OpCntRs.stVal	Operation counter	Operation counter	0...65535

2.4.1.28 LD0.ARCSARCx1 Arc protection (x1)**Table 125:** *LD0.ARCSARCx1 Arc protection (x1)*

RegA	Type	Scale	IEC 61850 name	SA name	Description	Values
			LD0.ARCSARC11			
2028	u16	1	.FACntRs.stVal		Fault arc 1 counter	0...65535
			LD0.ARCSARC21			
2029	u16	1	.FACntRs.stVal		Fault arc 2 counter	0...65535
			LD0.ARCSARC31			
2030	u16	1	.FACntRs.stVal		Fault arc 3 counter	0...65535

2.4.1.29 LD0.CMMXU1 Phase current demand values (1)**Table 126:** *LD0.CMMXU1 Phase current demand values (1)*

RegA	Type	Scale	IEC 61850 name	SA name	Description	Values
			LD0.CAVMMXU1		Demand value	
2001	u16	1000	.A.phsA.cVal.mag	I_DMD_A	Phs A amplitude	0.00...50.0 [xIn]
2002	u16	1000	.A.phsB.cVal.mag	I_DMD_B	Phs B amplitude	0.00...50.0 [xIn]
2003	u16	1000	.A.phsB.cVal.mag	I_DMD_C	Phs C amplitude	0.00...50.0 [xIn]
2004					Year - month	
2005					Day - hour	
2006					Minute - second	
2007					Milliseconds	
2008					Time quality	
			LD0.CMAMMXU1		Max demand values	
2009	u16	1000	.A.phsA.cVal.mag	Max demand IL1	Phs A amplitude	0.00...50.0 [xIn]
2010					Year - month	
2011					Day - hour	
2012					Minute - second	
2013					Milliseconds	
2014					Time quality	

Table continues on next page

RegA	Type	Scale	IEC 61850 name	SA name	Description	Values
2015	u16	1000	.A.phsB.cVal.mag	Max demand IL2	Phs B amplitude	0.00...50.0 [xIn]
2016					Year - month	
2017					Day - hour	
2018					Minute - second	
2019					Milliseconds	
2020					Time quality	
2021	u16	1000	.A.phsC.cVal.mag	Max demand IL2	Phs C amplitude	0.00...50.0 [xIn]
2022					Year - month	
2023					Day - hour	
2024					Minute - second	
2025					Milliseconds	
2026					Time quality	
			LD0.CMIMMXU1		Min demand values	
	u16	1000	.A.phsA.cVal.mag	Max demand IL1	Phs A amplitude	0.00...50.0 [xIn]
	u16	1000	.A.phsB.cVal.mag	Max demand IL2	Phs B amplitude	0.00...50.0 [xIn]
	u16	1000	.A.phsC.cVal.mag	Max demand IL3	Phs C amplitude	0.00...50.0 [xIn]

2.4.1.30 LD0.CMMXU1 Three-phase current measurement (1)

Table 127: LD0.CMMXU1 Three-phase current measurement (1)

RegA	Type	Scale	IEC 61850 name	SA name	Description	Values
			LD0.CMMXU1		Phase current (1)	
138	u16	1000	.A.phsA.instCVal.mag	I_INST_A	Phs A amplitude	0.00...40.0 [xIn]
139	u16	1000	.A.phsB.instCVal.mag	I_INST_B	Phs B amplitude	0.00...40.0 [xIn]
140	u16	1000	.A.phsC.instCVal.mag	I_INST_C	Phs C amplitude	0.00...40.0 [xIn]

2.4.1.31 LD0.CSMSQI1 Sequence current measurement (1)**Table 128:** *LD0.CSMSQI1 Sequence current measurement (1)*

RegA	Type	Scale	IEC 61850 name	SA name	Description	Values
			LD0.CSMSQI1		Sequence of currents	
143	u16	1000	.SeqA.c1.instCVal.mag	I1_INST	Positive amplitude	0.00...40.0 [xIn]
144	u16	1000	.SeqA.c2.instCVal.mag	I2_INST	Negative amplitude	0.00...40.0 [xIn]
145	u16	1000	.SeqA.c2.instCVal.mag	I3_INST	Zero amplitude	0.00...40.0 [xIn]

2.4.1.32 LD0.FMMXU1 Frequency measurement (1)**Table 129:** *LD0.FMMXU1 Frequency measurement (1)*

RegA	Type	Scale	IEC 61850 name	SA name	Description	Values
			LD0.FMMXU1			
146	u16	100	.Hz.mag	F_DB	Frequency	35.00..75.00 [Hz]

2.4.1.33 LD0.MDSOPT1 Runtime counter for machines and devices (1)

Since the register size is 16 bits, the value saturates at 65535 hours (approximately 7.5 years). Alternatively, a 32-bit user-definable register can be made of this data to cover the whole 300 000 hours (34 years) range. The value can also, for example, be rescaled to show “total operation days” instead by changing the scale factor from 1 to 1/24 = 0.0417.

Table 130: *LD0.MDSOPT1 Runtime counter for machines and devices (1)*

RegA	Type	Scale	IEC 61850 name	SA name	Description	Values
			LD0.MDSOPT1			
2048	u16	1	.OpTmh.stVal	OPR_TIME	Total operation hours	0..299999

2.4.1.34 LD0.MPTTR1 Thermal overload protection for motors (1)**Table 131:** *LD0.MPTTR1 Thermal overload protection for motors (1)*

RegA	Type	Scale	IEC 61850 name	SA name	Description	Values
			LD0.MPTTR1			
147	u16	1	.TmpRI.mag	Therm-lev	Thermal level	0.00...9.99
148	i16	1	.TmpUsed.mag	TEMP_AMB	Ambient temperature	-99...999 [C]
149	u16	10	.ThmLevSt	THERMLEV_ST	Start therm.level	0.00...9.99
150	u16	10	.ThmLevEnd	THERMLEV_END	End therm.level	0.00...9.99
151	u16	1	.StrInhTms.stVal	T_ENARESTART	Est. time to reset block restart	0...99999 [s]

2.4.1.35 LD0.PEMMTR1 Three-phase energy measurements (1)

Table 132: LD0.PEMMTR1 Three-phase energy measurements (1)

RegA	Type	Scale	IEC 61850 name	SA name	Description	Values
			LD0.PEMMTR1			
2040	u32	1	.SupWh.actVal		Reverse active energy (high)	0..1E10 [kWh]
2041			.SupWh.actVal		(low word)	
2042	u32	1	.SupVArh.actVal		Reverse reactive energy (high)	0..1E10 [kVArh]
2043			.SupVArh.actVal		(low word)	
2044	u32	1	.DemWh.actVal		Forward active energy (high)	0..1E10 [kWh]
2045			.DemWh.actVal		(low word)	
2046	u32	1	.DemVArh.actVal		Forward reactive energy (high)	0..1E10 [kVArh]
2047			.DemVArh.actVal		(low word)	

2.4.1.36 LD0.PEMMXU1 Power measurement demand values (1)

Table 133: LD0.PEMMXU1 Power measurement demand values (1)

RegA	Type	Scale	IEC 61850 name	SA name	Description	Values
			LD0.PEAVMMXU1		Demand value	
1939	i32	1	.TotW.mag		Active power P (high)	-/+ 999,999
1940					(Low word)	
1941	i32	1	.TotVAr.mag		Reactive power Q (high)	-/+ 999,999
1942					(Low word)	
1943	i32	1	.TotVA.mag		Apparent power S (high)	-/+ 999,999
1944					(Low word)	
1945	i16	1000	.TotPF.mag		Power factor	-1...1
			LD0.PEMAMMXU1		Max demand value	
	i32	1	.TotW.mag		Active power P	-/+ 999,999
	i32	1	.TotVAr.mag		Reactive power Q	-/+ 999,999
	i32	1	.TotVA.mag		Apparent power S	-/+ 999,999
			LD0.PEMIMMXU1		Min demand value	
	i32	1	.TotW.mag		Active power P	-/+ 999,999
	i32	1	.TotVAr.mag		Reactive power Q	-/+ 999,999
	i32	1	.TotVA.mag		Apparent power S	-/+ 999,999

2.4.1.37 LD0.PEMMXU1 Three-phase power and energy measurement (1)**Table 134:** LD0.PEMMXU1 Three-phase power and energy measurement (1)

RegA	Type	Scale	IEC 61850 name	SA name	Description	Values
			LD0.PEMMXU1			
161	i32	1	.TotW.instMag	P_INST	Total active power P (high)	-/+ 999,999
162			.TotW.instMag		(low word)	
163	i32	1	.TotVAr.instMag	Q_INST	Total reactive power Q (high)	-/+ 999,999
164			.TotVAr.instMag		(low word)	
165	i32	1	.TotVA.instMag	S_INST	Total apparent power S (high)	-/+ 999,999
166			.TotVA.instMag		(low word)	
167	i16	1000	.TotPF.instMag	PF_INST	Average power factor	-1...1

2.4.1.38 LD0.RESCMMXU1 Residual current demand value (1)**Table 135:** LD0.RESCMMXU1 Residual current demand value (1)

RegA	Type	Scale	IEC 61850 name	SA name	Description	Values
			LD0.RCAVMMXU1		Demand value	
1989	u16	1000	.A.res.cVal.mag	I_DMD_RES	Residual amplitude	0.00...50.0 [xIn]
1990					Year - month	
1991					Day - hour	
1992					Minute - second	
1993					Milliseconds	
1994					Time quality	
			LD0.RCMAMMXU1		Max. demand value	
1995	u16	1000	.A.res.cVal.mag	Max demand lo	Residual amplitude	0.00...50.0 [xIn]
1996					Year - month	
1997					Day - hour	
1998					Minute - second	
1999					Milliseconds	
2000					Time quality	
			LD0.RCMIMMXU1		Min. demand value	
	u16	1000	.A.res.cVal.mag	Min demand lo	Residual amplitude	0.00...50.0 [xIn]

2.4.1.39 LD0.RESCMMXU1 Residual current measurement (1)

Table 136: LD0.RESCMMXU1 Residual current measurement (1)

RegA	Type	Scale	IEC 61850 name	SA name	Description	Values
			LD0.RESCMMXU1		Residual current (1)	
141	u16	1000	.A.res.instCVal.mag	IO_INST	- amplitude	0.00...40.0 [xIn]

2.4.1.40 LD0.RESVMMXU1 Residual voltage demand value (1)

Table 137: LD0.RESVMMXU1 Residual voltage demand value (1)

RegA	Type	Scale	IEC 61850 name	SA name	Description	Values
			LD0.RVAVMMXU1		Demand value	
1977	u16	1000	.PhV.res.cVal.mag	U_DMD_RES	Residual amplitude	0.00...4.0 [xUn]
1978					Year - month	
1979					Day - hour	
1980					Minute - second	
1981					Milliseconds	
1982					Time quality	
			LD0.RVMAMMXU1		Max. demand value	
1983	u16	1000	.PhV.res.cVal.mag	Max demand Uo	Residual amplitude	0.00...4.0 [xUn]
1984					Year - month	
1985					Day - hour	
1986					Minute - second	
1987					Milliseconds	
1988					Time quality	
			LD0.RVMIMMXU1		Min. demand value	
	u16	1000	.PhV.res.cVal.mag	Min demand Io	Residual amplitude	0.00...4.0 [xUn]

2.4.1.41 LD0.RESVMMXU1 Residual voltage measurement (1)

Table 138: LD0.RESVMMXU1 Residual voltage measurement (1)

RegA	Type	Scale	IEC 61850 name	SA name	Description	Values
			LD0.RESVMMXU1		Residual voltage (1)	
142	u16	1000	.A.res.instCVal.mag	U0_INST	- amplitude	0.00...4.00 [xUn]

2.4.1.42 LD0.SSCBR1 Circuit-breaker condition monitoring (1)**Table 139:** *LD0.SSCBR1 Circuit-breaker condition monitoring (1)*

RegA	Type	Scale	IEC 61850 name	SA name	Description	Values
			LD0.SSCBR1			
2060	u16	1	.InaTmdCnt.stVal	INA_DAYS	CB inactive days	0...65535
2061	u16	1	.OpTmOpn.mag	T_TRV_OP	Open travel time	0...60000 [ms]
2062	u16	1	.OpTmCls.mag	T_TRV_CL	Close travel time	0...60000 [ms]
			LD0.SSOPM1			
2063	u16	100	.TmsSprCha.mag	T_SPR_CHR	Spring charge time	0.00...99.99 [s]
			LD0.SPH1SCBR1			
2064	i16	1	.RmnNumOp.stVal	CB_LIFE_A	Remain.life phs A	-/+ 9999
			LD0.SPH2SCBR1			
2065	i16	1	.RmnNumOp.stVal	CB_LIFE_B	Remain.life phs B	-/+ 9999
			LD0.SPH3SCBR1			
2066	i16	1	.RmnNumOp.stVal	CB_LIFE_C	Remain.life phs C	-/+ 9999
			LD0.SPH1SCBR1			
2067	u16	1	.AccmAPwr.mag	IPOW_A	lyt phs A	0...1E6
			LD0.SPH2SCBR1			
2068	u16	1	.AccmAPwr.mag	IPOW_B	lyt phs B	0...1E6
			LD0.SPH3SCBR1			
2069	u16	1	.AccmAPwr.mag	IPOW_C	lyt phs C	0...1E6

2.4.1.43 LD0.VMMXU1 Three-phase voltage measurement (1)**Table 140:** *LD0.VMMXU1 Three-phase voltage measurement (1)*

RegA	Type	Scale	IEC 61850 name	SA name	Description	Values
			LD0.VMMXU1		Phase-ground voltage (1)	
152	u16	1000	.phV.phsA.cVal.mag	U_DB_A	- Phs A amplitude	0.00...4.00 [xUn]
153	u16	1000	.phV.phsB.cVal.mag	U_DB_B	- Phs B amplitude	0.00...4.00 [xUn]
154	u16	1000	.phV.phsC.cVal.mag	U_DB_C	- Phs C amplitude	0.00...4.00 [xUn]
			LD0.VMMXU1		Phase-phase voltage (1)	
155	u16	1000	.PPV.phsAB.cVal.mag	U_DB_AB	- Phs AB amplitude	0.00...4.00 [xUn]
156	u16	1000	.PPV.phsBC.cVal.mag	U_DB_BC	- Phs BC amplitude	0.00...4.00 [xUn]
157	u16	1000	.PPV.phsCA.cVal.mag	U_DB_CA	- Phs CA amplitude	0.00...4.00 [xUn]

2.4.1.44 LD0.VMMXU1 Voltage demand values (1)

Table 141: LD0.VMMXU1 Voltage demand values (1)

RegA	Type	Scale	IEC 61850 name	SA name	Description	Values
			LD0.VAVMMXU1		Demand value	
1954	u16	1000	.PhV.phsA.cVal.mag	U_DMD_A	Phs A amplitude	0.00...4.0 [xUn]
1955	u16	1000	.PhV.phsB.cVal.mag	U_DMD_B	Phs B amplitude	0.00...4.0 [xUn]
1956	u16	1000	.PhV.phsC.cVal.mag	U_DMD_C	Phs C amplitude	0.00...4.0 [xUn]
1957	u16	1000	.PPV.phsAB.cVal.mag	U_DMD_AB	Phs AB amplitude	0.00...4.0 [xUn]
1958	u16	1000	.PPV.phsBC.cVal.mag	U_DMD_BC	Phs BC amplitude	0.00...4.0 [xUn]
1959	u16	1000	.PPV.phsCA.cVal.mag	U_DMD_CA	Phs CA amplitude	0.00...4.0 [xUn]

2.4.1.45 LD0.VSMSQI1 Sequence voltage measurement (1)

Table 142: LD0.VSMSQI1 Sequence voltage measurement (1)

RegA	Type	Scale	IEC 61850 name	SA name	Description	Values
			LD0.VSMSQI1		Sequence of voltages	
158	u16	1000	.SeqA.c1.instCVal.mag	U1_INST	- Positive amplitude	0.00...4.00 [xUn]
159	u16	1000	.SeqA.c2.instCVal.mag	U2_INST	- Negative amplitude	0.00...4.00 [xUn]
160	u16	1000	.SeqA.c2.instCVal.mag	U3_INST	- Zero amplitude	0.00...4.00 [xUn]

2.4.1.46 LD0.XRGGIO130 RTD input values

Table 143: LD0.XRGGIO130 RTD input values

RegA	Type	Scale	IEC 61580 name	SA name	Description	Values
			LD0.XRGGIO130			
2031	i16	1	.AnIn1.mag	AI_VAL1	RTD input 1 in ohms	-/+ 10000.00
2032	i16	1	.AnIn2.mag	AI_VAL2	RTD input 2 in ohms	-/+ 10000.00
2033	i16	1	.AnIn3.mag	AI_VAL3	RTD input 3 in ohms	-/+ 10000.00
2034	i16	1	.AnIn4.mag	AI_VAL4	RTD input 4 in ohms	-/+ 10000.00
2035	i16	1	.AnIn5.mag	AI_VAL5	RTD input 5 in ohms	-/+ 10000.00
2036	i16	1	.AnIn6.mag	AI_VAL6	RTD input 6 in ohms	-/+ 10000.00
2037	i16	1	.AnIn7.mag	AI_VAL7	RTD input 7 in ohms	-/+ 10000.00
2038	i16	1	.AnIn8.mag	AI_VAL8	RTD input 8 in ohms	-/+ 10000.00

2.4.2 Unmapped registers

Unmapped registers are register data that have no initial Modbus mapping locations, but can be added to the user-definable Modbus area using the Communication Management tool in PCM600. The initial register type settings of these objects have little meaning, since it is always possible to redefine the settings completely for the user-definable register.

2.4.2.1 CTRL.LLN0 Local, Remote, Station, Off and Combinations

Table 144: CTRL.LLN0 Local, Remote, Station, Off and Combinations

RegA	Type	Scale	IEC 61850 name	SA name	Description	Values
			CTRL.LLN0			
	u16	1	.LockKeyHMI.stVal		0=Off; 1=Loc; 2=Rem; 3=Stat; 4=L+R; 5=L+S; 6=L+S+R; 7=S +R	0...7

2.4.2.2 LD0.LLN0/LPHD1/LDEV1 System values

Table 145: LD0.LLN0/LPHD1/LDEV1 System values

RegA	Type	Scale	IEC 61850 name	SA name	Description	Values
			LD0.LLN0			
	u16	1	.ParChgCnt.stVal		Num. of setting changes	0...65535

2.4.2.3 LD0.MVI4GAPC1 Integer value move (1)

Table 146: LD0.MVI4GAPC1 Integer value move (1)

RegA	Type	Scale	IEC 61850 name	SA name	Description	Values
			LD0.MVI4GAPC1			
	i32	1	.ISCS01.stVal	OUT1	- Integer value 1 (high)	-/ +2147483647
					- Low word	
	i32	1	.ISCS02.stVal	OUT2	- Integer value 2 (high)	-/ +2147483647
					- Low word	
	i32	1	.ISCS03.stVal	OUT3	- Integer value 3 (high)	-/ +2147483647
					- Low word	
	i32	1	.ISCS04.stVal	OUT4	- Integer value 4 (high)	-/ +2147483647
					- Low word	

2.4.2.4 LD0.SCA4GAPC1 Analog value scaling (1)

Table 147: LD0.SCA4GAPC1 Analog value scaling (1)

RegA	Type	Scale	IEC 61850 name	SA name	Description	Values
			LD0.SCA4GAPC1			
	i16	1000	.AnValOut1.mag	AO1_VALUE	Analog value 1 after scaling	0...N
	i16	1000	.AnValOut2.mag	AO2_VALUE	Analog value 2 after scaling	0...N
	i16	1000	.AnValOut3.mag	AO3_VALUE	Analog value 3 after scaling	0...N
	i16	1000	.AnValOut4.mag	AO4_VALUE	Analog value 4 after scaling	0...N

2.4.2.5 LD0.SCA4GAPC2 Analog value scaling (2)

Table 148: LD0.SCA4GAPC2 Analog value scaling (2)

RegA	Type	Scale	IEC 61850 name	SA name	Description	Values
			LD0.SCA4GAPC2			
	i16	1000	.AnValOut1.mag	AO1_VALUE	Analog value 1 after scaling	0...N
	i16	1000	.AnValOut2.mag	AO2_VALUE	Analog value 2 after scaling	0...N
	i16	1000	.AnValOut3.mag	AO3_VALUE	Analog value 3 after scaling	0...N
	i16	1000	.AnValOut4.mag	AO4_VALUE	Analog value 4 after scaling	0...N

2.4.2.6 LD0.SCA4GAPC3 Analog value scaling (3)

Table 149: LD0.SCA4GAPC3 Analog value scaling (3)

RegA	Type	Scale	IEC 61850 name	SA name	Description	Values
			LD0.SCA4GAPC3			
	i16	1000	.AnValOut1.mag	AO1_VALUE	Analog value 1 after scaling	0...N
	i16	1000	.AnValOut2.mag	AO2_VALUE	Analog value 2 after scaling	0...N
	i16	1000	.AnValOut3.mag	AO3_VALUE	Analog value 3 after scaling	0...N
	i16	1000	.AnValOut4.mag	AO4_VALUE	Analog value 4 after scaling	0...N

2.4.2.7 LD0.SCA4GAPC4 Analog value scaling (4)

Table 150: LD0.SCA4GAPC4 Analog value scaling (4)

RegA	Type	Scale	IEC 61850 name	SA name	Description	Values
			LD0.SCA4GAPC4			
	i16	1000	.AnValOut1.mag	AO1_VALUE	Analog value 1 after scaling	0...N
	i16	1000	.AnValOut2.mag	AO2_VALUE	Analog value 2 after scaling	0...N
	i16	1000	.AnValOut3.mag	AO3_VALUE	Analog value 3 after scaling	0...N
	i16	1000	.AnValOut4.mag	AO4_VALUE	Analog value 4 after scaling	0...N

2.5 Controls

Table 151: Explanations of the controls table columns

Column name	Description
0xA	Coil (0X) address for control value.
CS	Control structure and bit within the structure for control value.
IEC 61850 name	Original IED data object identification. Described in the IEC 61850 format as Logical Device.Logical Node and thereafter .Data Object.Data Attribute. Logical Node is the same as the application function block name.
SA name	The signal may have a defined label that is visible, for example, in the Application Configuration tool in PCM600.
Description	Short description of the signal. See the technical manual for more information.
Value	Meaning of the written value.

2.5.1 Reset, acknowledge and trigger points

Table 152: Reset, acknowledge and trigger points

0xA	CS	IEC 61850 name	SA name	Description	Values
		LD0.LLN0			
2060	2.00	.LEDs1.Oper.ctlVal		Reset indications and LEDs	1=Reset
2061	2.01	.LEDs2.Oper.ctlVal		Reset alarm LEDs	1=Reset
		LD0.PEMMXU1			
2062	2.02	.RecRs.Oper.ctlVal		Reset power max demands	1=Reset
2063	2.03	< reserved >			
2064	2.04	< reserved >			
		LD0.SSCBR1			
2065	2.05	.RsAccAPwr.Oper.ctlVal		Reset CB accum. energy	1=Reset
2066	2.06	.RsCBWear.Oper.ctlVal		Reset CB wear data	1=Reset
		DR.RDRE1			
2067	2.07	.RcdTrg.Oper.ctlVal		Trig DR recording	1=Trig
2068	2.08	.MemClr.Oper.ctlVal		Clear DR memory	1=Clear
		LD0.CMMXU1			
2069	2.09	.RecRs.Oper.ctlVal		Reset max current1 demands	1=Reset
		LD0.PEMMXU1			
2070	2.10	.SupDmdRs.Oper.ctlVal		Reset energy values	1=Reset
		LD0.SCCBR1			
2071	2.11	.RsTrvTm.Oper.ctlVal		Reset CB travel time	1=Reset
2072	2.12	.RsSprChaTm.Oper.ctlVal		Reset CB spring charge time	1=Reset
		LD0.RESCMMXU1			

Table continues on next page

0xA	CS	IEC 61850 name	SA name	Description	Values
2073	2.13	.RecRs.Oper.ctlVal		Reset Io (1) max demands	1=Reset
		LD0.RESVMMXU1			
2074	2.14	.RecRs.Oper.ctlVal		Reset Uo (1) max demands	1=Reset

2.5.2 CTRL.CBCSWI1 Circuit breaker control (1)

Table 153: CTRL.CBCSWI1 Circuit breaker control (1)

0xA	CS	IEC 61850 name	SA name	Description	Values
		CTRL.CBCSWI1			
2048	1.00	.Pos.Oper.ctlVal		Select open	1=Select
2049	1.01	.Pos.Oper.ctlVal		Select close	1=Select
2050	1.02	.Pos.Oper.ctlVal		Cancel selection	1=Cancel
2051	1.03	.Pos.Oper.ctlVal		Execute selection	1=Execute
2052	1.04	.Pos.Oper.ctlVal		Direct open	1=Open
2053	1.05	.Pos.Oper.ctlVal		Direct close	1=Close

2.5.3 CTRL.DCXSWI1 Disconnecter control (1)

Table 154: CTRL.DCXSWI1 Disconnecter control (1)

0xA	CS	IEC 61850 name	SA name	Description	Values
		CTRL.DCCSWI1			
2144	7.00	.Pos.Oper.ctlVal		Select open	1=Select
2145	7.01	.Pos.Oper.ctlVal		Select close	1=Select
2146	7.02	.Pos.Oper.ctlVal		Cancel selection	1=Cancel
2147	7.03	.Pos.Oper.ctlVal		Execute selection	1=Execute
2148	7.04	.Pos.Oper.ctlVal		Direct open	1=Open
2149	7.05	.Pos.Oper.ctlVal		Direct close	1=Close

2.5.4 CTRL.DCXSWI2 Disconnecter control (2)

Table 155: CTRL.DCXSWI2 Disconnecter control (2)

0xA	CS	IEC 61850 name	SA name	Description	Values
		CTRL.DCCSWI2			
2150	7.06	.Pos.Oper.ctlVal		Select open	1=Select
2151	7.07	.Pos.Oper.ctlVal		Select close	1=Select
2152	7.08	.Pos.Oper.ctlVal		Cancel selection	1=Cancel
2153	7.09	.Pos.Oper.ctlVal		Execute selection	1=Execute
2154	7.10	.Pos.Oper.ctlVal		Direct open	1=Open
2155	7.11	.Pos.Oper.ctlVal		Direct close	1=Close

2.5.5 CTRL.ESXSWI1 Earthing switch control (1)

Table 156: CTRL.ESXSWI1 Earthing switch control (1)

0xA	CS	IEC 61850 name	SA name	Description	Values
		CTRL.ESXSWI1			
2054	1.06	.Pos.Oper.ctlVal		Select open	1=Select
2055	1.07	.Pos.Oper.ctlVal		Select close	1=Select
2056	1.08	.Pos.Oper.ctlVal		Cancel selection	1=Cancel
2057	1.09	.Pos.Oper.ctlVal		Execute selection	1=Execute
2058	1.10	.Pos.Oper.ctlVal		Direct open	1=Open
2059	1.11	.Pos.Oper.ctlVal		Direct close	1=Close

2.5.6 LD0.LDEV1 Protection relay's warm reset (1)

Table 157: LD0.LDEV1 Protection relay's warm reset (1)

0xA	CS	IEC 61850 name	SA name	Description	Values
		LD0.LDEV1			
2080	3.00	.WrmStrCmd.Oper.ctlVal		Warm reboot of protection relay	1=Reboot

2.5.7 LD0.SPCGAPC1 Generic control point (16 pcs) (1)

The binary outputs can be configured either as pulse- or persistent-type outputs. Pulse-type outputs are triggered with the write value "1". Persistent-type outputs can be written with both values "1" and "0". The setting mode "toggled" for local operation corresponds to "persistent" for remote operation.

Table 158: LD0.SPCGAPC1 Generic control point (16 pcs) (1)

0xA	CS	IEC 61850 name	SA name	Description	Values
		LD0.SPCGAPC1			
2112	5.00	.SPCS01.ctlVal		Output 1 control	0/1=Off/On
2113	5.01	.SPCS02.ctlVal		Output 2 control	0/1=Off/On
2114	5.02	.SPCS03.ctlVal		Output 3 control	0/1=Off/On
2115	5.03	.SPCS04.ctlVal		Output 4 control	0/1=Off/On
2116	5.04	.SPCS05.ctlVal		Output 5 control	0/1=Off/On
2117	5.05	.SPCS06.ctlVal		Output 6 control	0/1=Off/On
2118	5.06	.SPCS07.ctlVal		Output 7 control	0/1=Off/On
2119	5.07	.SPCS08.ctlVal		Output 8 control	0/1=Off/On
2120	5.08	.SPCS09.ctlVal		Output 9 control	0/1=Off/On
2121	5.09	.SPCS10.ctlVal		Output 10 control	0/1=Off/On
2122	5.10	.SPCS11.ctlVal		Output 11 control	0/1=Off/On
2123	5.11	.SPCS12.ctlVal		Output 12 control	0/1=Off/On

Table continues on next page

0xA	CS	IEC 61850 name	SA name	Description	Values
2124	5.12	.SPCS13.ctlVal		Output 13 control	0/1=Off/On
2125	5.13	.SPCS14.ctlVal		Output 14 control	0/1=Off/On
2126	5.14	.SPCS15.ctlVal		Output 15 control	0/1=Off/On
2127	5.15	.SPCS16.ctlVal		Output 16 control	0/1=Off/On

2.5.8 LD0.SPCGAPC2 Generic control point (16 pcs) (2)

The binary outputs can be configured either as pulse- or persistent-type outputs. Pulse-type outputs are triggered with the write value "1". Persistent-type outputs can be written with both values "1" and "0". The setting mode "toggled" for local operation corresponds to "persistent" for remote operation.

Table 159: LD0.SPCGAPC2 Generic control point (16 pcs) (2)

0xA	CS	IEC 61850 name	SA name	Description	Values
		LD0.SPCGAPC2			
2128	6.00	.SPCS01.ctlVal		Output 1 control	0/1=Off/On
2129	6.01	.SPCS02.ctlVal		Output 2 control	0/1=Off/On
2130	6.02	.SPCS03.ctlVal		Output 3 control	0/1=Off/On
2131	6.03	.SPCS04.ctlVal		Output 4 control	0/1=Off/On
2132	6.04	.SPCS05.ctlVal		Output 5 control	0/1=Off/On
2133	6.05	.SPCS06.ctlVal		Output 6 control	0/1=Off/On
2134	6.06	.SPCS07.ctlVal		Output 7 control	0/1=Off/On
2135	6.07	.SPCS08.ctlVal		Output 8 control	0/1=Off/On
2136	6.08	.SPCS09.ctlVal		Output 9 control	0/1=Off/On
2137	6.09	.SPCS10.ctlVal		Output 10 control	0/1=Off/On
2138	6.10	.SPCS11.ctlVal		Output 11 control	0/1=Off/On
2139	6.11	.SPCS12.ctlVal		Output 12 control	0/1=Off/On
2140	6.12	.SPCS13.ctlVal		Output 13 control	0/1=Off/On
2141	6.13	.SPCS14.ctlVal		Output 14 control	0/1=Off/On
2142	6.14	.SPCS15.ctlVal		Output 15 control	0/1=Off/On
2143	6.15	.SPCS16.ctlVal		Output 16 control	0/1=Off/On

2.5.9 LD0.SRGAPC1 Set-reset (8 pcs) (1)

Table 160: LD0.SRGAPC1 Set-reset (8 pcs) (1)

0xA	CS	IEC 61850 name	SA name	Description	Values
		LD0.SRGAPC1			
2096	4.00	.Rs1.Oper.ctlVal		Reset flip-flop 1	1=Reset
2097	4.01	.Rs2.Oper.ctlVal		Reset flip-flop 2	1=Reset
2098	4.02	.Rs3.Oper.ctlVal		Reset flip-flop 3	1=Reset

Table continues on next page

0xA	CS	IEC 61850 name	SA name	Description	Values
2099	4.03	.Rs4.Oper.ctlVal		Reset flip-flop 4	1=Reset
2100	4.04	.Rs5.Oper.ctlVal		Reset flip-flop 5	1=Reset
2101	4.05	.Rs6.Oper.ctlVal		Reset flip-flop 6	1=Reset
2102	4.06	.Rs7.Oper.ctlVal		Reset flip-flop 7	1=Reset
2103	4.07	.Rs8.Oper.ctlVal		Reset flip-flop 8	1=Reset

2.5.10 LD0.SRGAPC2 Set-reset (8 pcs) (2)

Table 161: LD0.SRGAPC2 Set-reset (8 pcs) (2)

0xA	CS	IEC 61850 name	SA name	Description	Values
		LD0.SRGAPC2			
2104	4.08	.Rs1.Oper.ctlVal		Reset flip-flop 1	1=Reset
2105	4.09	.Rs2.Oper.ctlVal		Reset flip-flop 2	1=Reset
2106	4.10	.Rs3.Oper.ctlVal		Reset flip-flop 3	1=Reset
2107	4.11	.Rs4.Oper.ctlVal		Reset flip-flop 4	1=Reset
2108	4.12	.Rs5.Oper.ctlVal		Reset flip-flop 5	1=Reset
2109	4.13	.Rs6.Oper.ctlVal		Reset flip-flop 6	1=Reset
2110	4.14	.Rs7.Oper.ctlVal		Reset flip-flop 7	1=Reset
2111	4.15	.Rs8.Oper.ctlVal		Reset flip-flop 8	1=Reset

2.5.11 Unmapped control points

Table 162: Unmapped control points

IEC 61850 name	Description	Value
LD0.LLN0.MeasStatRs.Oper.ctlVal	Reset all min. and max. demands	1=Reset
LD0.LLN0.PQRs.Oper.ctlVal	Reset all power quality data	1=Reset
LD0.FLTRFRC1.RcdRs.Oper.ctlVal	Reset fault record data	1=Reset

Section 3 Glossary

EMC	Electromagnetic compatibility
IEC	International Electrotechnical Commission
IEC 61850	International standard for substation communication and modeling
IED	Intelligent electronic device
LED	Light-emitting diode
LHMI	Local human-machine interface
Modbus	A serial communication protocol developed by the Modicon company in 1979. Originally used for communication in PLCs and RTU devices.
PCM600	Protection and Control IED Manager



ABB Distribution Solutions
Distribution Automation

P.O. Box 699
FI-65101 VAASA, Finland
Phone +358 10 22 11

ABB Distribution Automation

Maneja Works
Vadodara-390013, India
Phone +91 265 2604386
Fax +91 265 2638922

www.abb.com/mediumvoltage

www.abb.com/reliion

www.abb.com/substationautomation