



# Model 4100 Series

Forma Series 3 Water Jacket CO<sub>2</sub> Incubator

Operating Manual 7004100 Rev. 7

Visit us online to register your warranty  
[www.thermoscientific.com/labwarranty](http://www.thermoscientific.com/labwarranty)

**Thermo**  
SCIENTIFIC

<b>Model</b>	<b>CO2 Sensor*</b>	<b>O2</b>	<b>Voltage**</b>
4110	T/C	No	115
4111	T/C	No	230
4120	IR	No	115
4121	IR	No	230
4130	T/C	Yes	115
4131	T/C	Yes	230
4140	IR	Yes	115
4141	IR	Yes	230

\*T/C is a thermal conductivity sensor.

IR is an infrared sensor.

\*\*All units are 50/60Hz.

#### MANUAL NUMBER 7004100

7	40511	02/08/17	Update cabinet frame assy drawing	slb
6	40539	12/20/16	Revise section 5 , 4100 series alarms	slb
5	40087/IN-4743	7/27/16	Changed the label on the remote alarm artwork to a note - pg 7-4	ccs
4	40507	9/16/15	Updated analog output board artwork (pg 7-6) and elec schematics	ccs
3	31734	1/19/15	Corrected typos - IT, fig 6-21, PM, warranty	ccs
2	31231/IN-4401	10/2/14	Added reversing door swing information, T/C models and options	ccs



**Important** Read this instruction manual. Failure to read, understand and follow the instructions in this manual may result in damage to the unit, injury to operating personnel, and poor equipment performance. ▲

**Caution** All internal adjustments and maintenance must be performed by qualified service personnel. ▲

Material in this manual is for information purposes only. The contents and the product it describes are subject to change without notice. Thermo Fisher Scientific™ makes no representations or warranties with respect to this manual. In no event shall Thermo be held liable for any damages, direct or incidental, arising out of or related to the use of this manual.

### Intended purpose of the device

**Correct use** The CO<sub>2</sub> Water Jacket incubator is a general purpose laboratory device for preparing and cultivating cell and tissue cultures. The device allows the simulation of the special physiological ambient conditions for these cultures due to the exact control of temperature, CO<sub>2</sub> content, O<sub>2</sub> content, and increased relative humidity.

**Fields of application** The CO<sub>2</sub> Water Jacket incubator has been designed for installation and operation in the following fields of application:

- Laboratories for cytobiological and biotechnological experiments of safety levels L1, L2, and L3.
- Medical-microbiological laboratories in accordance with DIN 58 956.
- Laboratories in the central area of clinics and hospitals.

**Gas supply system** The gases required for the incubator (CO<sub>2</sub> and / or O<sub>2</sub>) are supplied to the device from a separate gas supply system, either from gas cylinders or from a central pressurized gas container. The layout of the gas supply system must ensure that the operating pressure of the gas supply lines can be set to a range between 0.8 bar (min.) to 1 bar (max.) and that the pressure cannot be changed. If the device is equipped with the optional gas monitoring system, up to four devices can be interconnected in line, independent of the of the gas supply system capacity.

The CO<sub>2</sub> incubator is suitable for continuous operation.

**Incorrect use** Do not use cell or tissue cultures in the device that are not in accordance with the regulations of safety levels L1, L2, and L3. Do not use tissues, substances or liquids that:

- are easily ignitable or explosive,
- release vapors that form combustible or explosive mixtures when exposed to air,
- release poisons.

The 4100 Series Water Jacket Incubators are for general purposes, not intended for use in any medical application, e.g. not intended for use as a Microbiological Incubator (21 CFR 866.2540) and also are not approved for use in assisted reproductive procedures for the incubation of ova and embryos (21 CFR 884.6120).



Important operating and/or maintenance instructions. Read the accompanying text carefully.



Potential electrical hazards. Only qualified persons should perform procedures associated with this symbol.



Equipment being maintained or serviced must be turned off and locked off to prevent possible injury.



Hot surface(s) present which may cause burns to unprotected skin, or to materials which may be damaged by elevated temperatures.



WEEE Compliance: Thermo Fisher Scientific has contracted with companies for recycling/disposal in each EU Member State to discard/recycle, For further information, email to [weee.recycle@thermofisher.com](mailto:weee.recycle@thermofisher.com).



- ✓ Always use the proper protective equipment (clothing, gloves, goggles, etc.)
- ✓ Always dissipate extreme cold or heat and wear protective clothing.
- ✓ Always follow good hygiene practices.
- ✓ Each individual is responsible for his or her own safety.

© 2014 Thermo Fisher Scientific Inc. All rights reserved. All (other) trademarks are the property of Thermo Fisher Scientific and its subsidiaries.

In case of conflicting translations into foreign languages, the English language version of these instructions shall be binding.

Thermo Scientific is a brand owned by Thermo Fisher Scientific Inc. All other trademarks mentioned in the operating instructions are the exclusive property of the respective manufacturers.

## Do You Need Information or Assistance on Thermo Scientific Products?

If you do, please contact us 8:00 a.m. to 6:00 p.m. (Eastern Time) at:

1-740-373-4763

1-800-438-4851

1-877-213-8051

<http://www.thermofisher.com>

[service.led.marietta@thermofisher.com](mailto:service.led.marietta@thermofisher.com)

[www.unitylabservices.com](http://www.unitylabservices.com)

Direct

Toll Free, U.S. and Canada

FAX

Internet Worldwide Web Home Page

Tech Support Email Address

Certified Service Web Page

Our **Sales Support** staff can provide information on pricing and give you quotations. We can take your order and provide delivery information on major equipment items or make arrangements to have your local sales representative contact you. Our products are listed on the Internet and we can be contacted through our Internet home page.

Our **Service Support** staff can supply technical information about proper setup, operation or troubleshooting of your equipment. We can fill your needs for spare or replacement parts or provide you with on-site service. We can also provide you with a quotation on our Extended Warranty for your Thermo Scientific products.

Whatever Thermo Scientific products you need or use, we will be happy to discuss your applications. If you are experiencing technical problems, working together, we will help you locate the problem and, chances are, correct it yourself...over the telephone without a service call.

When more extensive service is necessary, we will assist you with direct factory trained technicians or a qualified service organization for on-the-spot repair. If your service need is covered by the warranty, we will arrange for the unit to be repaired at our expense and to your satisfaction.

Regardless of your needs, our professional telephone technicians are available to assist you Monday through Friday from 8:00 a.m. to 6:00 p.m. Eastern Time. Please contact us by telephone or fax. If you wish to write, our mailing address is:

Thermo Fisher Scientific (Asheville) LLC  
401 Millcreek Road, Box 649  
Marietta, OH 45750

International customers, please contact your local Thermo Scientific distributor.

## Warranty Notes

### Information You Should Know Before Requesting Warranty Service

- **Locate the model and serial numbers.** A serial tag is located on the unit itself.
- For equipment service or maintenance, or with technical or special application inquiries, contact Technical Services at 1-800-438-4851 or 1-740-373-4763 (USA and Canada). Outside the USA, contact your local distributor.

### Repairs NOT Covered Under Warranty

- **Calibration of control parameters.** Nominal calibrations are performed at the factory; typically  $\pm 1^{\circ}\text{C}$  for temperature,  $\pm 1\%$  for gases, and  $\pm 5\%$  for humidity. Our service personnel can provide precise calibrations as a billable service at your location. Calibration after a warranty repair is covered under the warranty.
- **Damage resulting from use of improper quality water, chemicals or cleaning agents detrimental to equipment materials.**
- **Service calls for improper installation or operating instructions.** Corrections to any of the following are billable services:
  - 1) electrical service connection
  - 2) tubing connections
  - 3) gas regulators
  - 4) gas tanks
  - 5) unit leveling
  - 6) room ventilation
  - 7) adverse ambient temperature fluctuations
  - 8) any repair external to the unit
- **Damage resulting from accident, alteration, misuse, abuse, fire, flood, acts of God, or improper installation.**
- **Repairs to parts or systems resulting from unauthorized unit modifications.**
- **Any labor costs other than that specified during the parts and labor warranty period, which may include additional warranty on CO<sub>2</sub> sensors, blower motors, water jackets, etc.**

# Table of Contents

<b>Section 1</b>	<b>Set-Up</b> .....	<b>1-1</b>
	Stacking Units .....	1-1
	Preliminary Cleaning .....	1-3
	Installing Access Port Filter .....	1-3
	Installing Air Sample Filter .....	1-4
	Installing HEPA Filter .....	1-4
	Installing Shelves .....	1-4
	Connecting Unit to Electrical Power .....	1-5
	Leveling the Unit .....	1-5
	Filling the Humidity Pan .....	1-6
	Filling the Water Jacket .....	1-6
	Connecting CO <sub>2</sub> / O <sub>2</sub> System Gas Supply .....	1-8
<b>Section 2</b>	<b>Installation and Start-Up</b> .....	<b>2-1</b>
	Name and Description of Parts .....	2-1
	Power Switch .....	2-2
	Installing the Unit .....	2-2
	Operating Panel and Operating Structure .....	2-3
	Versions without O <sub>2</sub> Control .....	2-3
	Versions w/ Combined CO <sub>2</sub> /O <sub>2</sub> Control (optional) .....	2-3
	Versions with RH Option .....	2-4
	Versions w/ Combined CO <sub>2</sub> /O <sub>2</sub> Control & RH Option .....	2-4
	Factory Setting of the Touchscreen Controls .....	2-6
	Heat-up Phase of the Control Loop Sensors .....	2-6
	Event Actions for Settings .....	2-7
	Setting the Temperature Set Value .....	2-7
	Setting the CO <sub>2</sub> Set Value .....	2-9
	Setting the O <sub>2</sub> Set Value .....	2-10
	Auto-Start Routine .....	2-11
	Activating Auto-Start .....	2-13
	Interrupting the Auto-Start Routine .....	2-14
	User Configuration .....	2-15

<b>Section 3</b>	<b>Calibration</b> .....	<b>3-1</b>
	Calibrating the Temperature .....	3-1
	Temperature Stabilization Periods .....	3-2
	Calibrating T/C CO <sub>2</sub> System .....	3-2
	T/C CO <sub>2</sub> Sensor Stabilization Times .....	3-3
	Calibrating Infra-red (IR) CO <sub>2</sub> System .....	3-3
	IR CO <sub>2</sub> Sensor Stabilization Times .....	3-4
	Calibrating the O <sub>2</sub> System .....	3-4
	O <sub>2</sub> Calibration at 21% .....	3-5
	O <sub>2</sub> Offset Calibration .....	3-5
	Calibrating Relative Humidity .....	3-6
	Relative Humidity (RH) Stabilization Times .....	3-6
<b>Section 4</b>	<b>Configuration</b> .....	<b>4-1</b>
	Turning Audible Alarm Relay ON/OFF .....	4-1
	New HEPA Filter .....	4-1
	Enabling/Disabling Keypad Lock .....	4-2
	Selecting a Primary Tank (Gas Guard) .....	4-2
<b>Section 5</b>	<b>Alarms</b> .....	<b>5-1</b>
	Inner Door Open Alarm .....	5-5
	Sensor Fault Alarms .....	5-5
	O <sub>2</sub> Sensor Breakage .....	5-5
	CO <sub>2</sub> Error Communication .....	5-5
<b>Section 6</b>	<b>Routine Maintenance</b> .....	<b>6-1</b>
	Cleaning the Interior .....	6-2
	Cleaning Cabinet Exterior .....	6-4
	Cleaning Humidity Pan .....	6-4
	Reversing the Door Swing .....	6-4
	Reversing Hinges for Exterior Door .....	6-4
	Reversing Hinges for Interior Door .....	6-7
	Replacing Fuses .....	6-9
	HEPA Filter Maintenance .....	6-10
	Replacing Air Sample Filter .....	6-10
	Replacing Access Port Filter .....	6-11
	Draining Water Jacket .....	6-11
	O <sub>2</sub> Sensor Fuel Cell .....	6-12
	Replacing O <sub>2</sub> Sensor .....	6-12
	Adding /Replenishing Rust Inhibitor .....	6-13



<b>Section 7</b>	<b>Factory Installed Options</b> .....	<b>7-1</b>
	Humidity Readout .....	7-1
	Cooling Coil .....	7-2
	Installing Cooling Coil Incubator .....	7-3
	Remote Alarm Contacts .....	7-4
	Connecting Analog Output Boards .....	7-5
	Gas Guard for CO <sub>2</sub> /N <sub>2</sub> .....	7-7
	Connecting CO <sub>2</sub> Gas Supplies .....	7-7
	Connecting N <sub>2</sub> Gas Supplies .....	7-7
	Gas Guard Operation .....	7-8
<b>Section 8</b>	<b>Specifications</b> .....	<b>8-1</b>
	Unit Attachment Location .....	8-4
	Unit Center of Gravity Locations .....	8-5
<b>Section 9</b>	<b>Spare Parts</b> .....	<b>9-1</b>
	All Models .....	9-1
	230V Models .....	9-2
	IR or O <sub>2</sub> Option .....	9-2
	Stacking Adapter Kit .....	9-2
	Humidity Readout .....	9-2
	Data Output Options .....	9-2
	Gas Guard .....	9-2
	Exploded Parts Drawings .....	9-3
<b>Section 10</b>	<b>Electrical Schematics</b> .....	<b>10-1</b>
<b>Section 11</b>	<b>Appendix</b> .....	<b>11-1</b>

# Section 1 Set-Up

## Stacking Units

**Warning** If the units have been in service, disconnect the power cord connector and drain the water jacket of the designated top unit before stacking. ▲

**Note** Stacking brackets (shown at right) stacking bolts, washers, and bolts for stacking are included with each unit. ▲

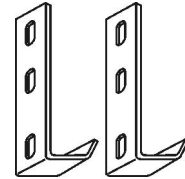

Figure 1-1. Stacking brackets

1. Designate one incubator to be the top unit and the other as the bottom unit. Remove the base cover plate from the top unit using the finger holes in the base or using a slotted screwdriver (Figure 1-2).

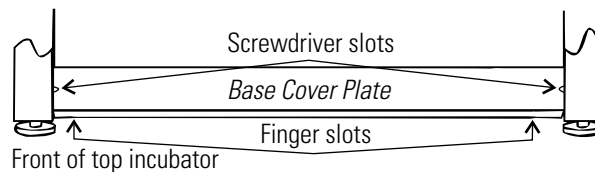

Figure 1-2. Remove Base Cover Plate

2. Note the two slots in the base of the incubator which accommodate the stacking bolts. Refer to Figure 1-3.

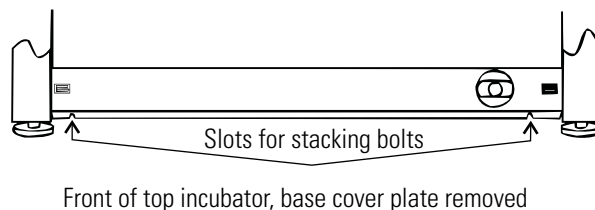

Figure 1-3. Stacking Bolt Slots

3. Remove the two plastic plugs from the bolt holes in the exterior top of the bottom unit. Install the 1/2" long 5/16-18 stacking bolts and washers into bolt holes - do not tighten bolts at this time (Figure 1-4).

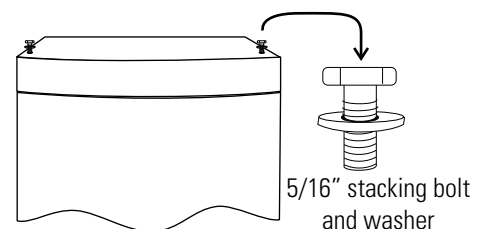

Figure 1-4. Bolt Holes

## Stacking Units (cont.)

4. Unscrew and remove the leveling feet from the top unit and lift it onto the bottom unit, off-setting the base of the top unit approximately 2-3 inches behind the stacking bolts and washers.

**Warning** This incubator weighs 265 lbs (120kg) before filling. Have sufficient personnel to lift it. Lift the unit from the sides only, do not lift by the door/front. ▲

5. Align the sides of the top unit and bottom unit and slide the top unit forward until the slots in the base of the top unit align with the 5/16"-18 stacking bolts in the exterior top of the bottom unit (Figure 1-5).

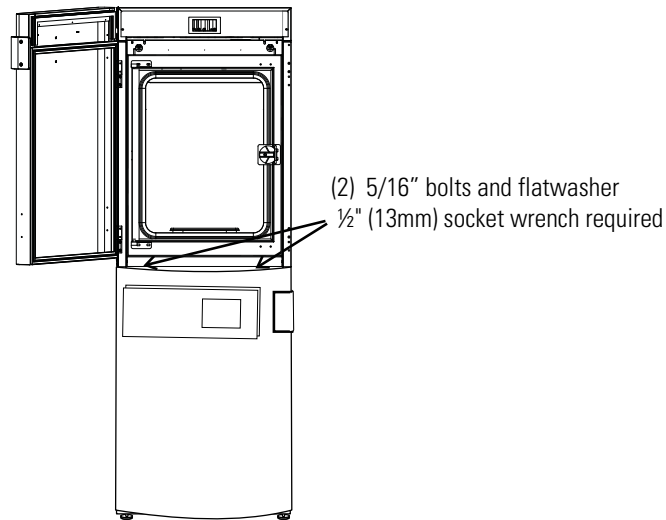

Figure 1-5. Align Slots and Bolts

6. Remove and save the two screws from the back of the control housing on the bottom unit as identified in Figure 1-6.

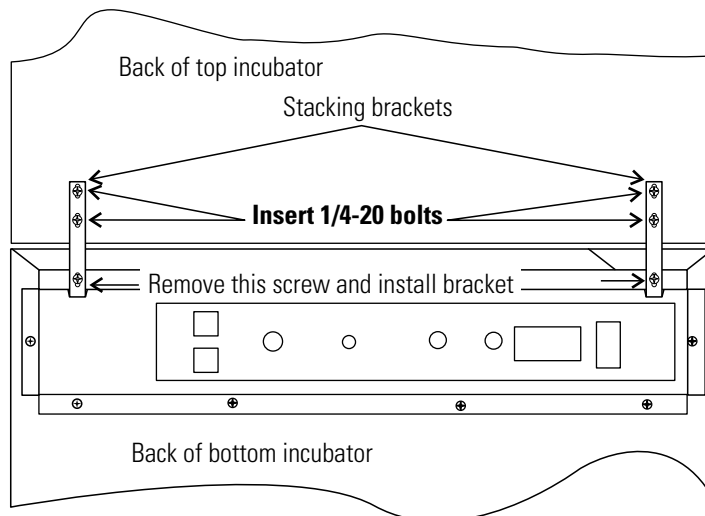

Figure 1-6. Two Screws From Control Housing Back

## Stacking Units (cont.)

7. Insert the stacking brackets into the slots on the back of the control housing of the bottom unit as shown in Figure 1-6. Align the slots in the brackets with the mounting holes on the rear of the incubators. Secure the brackets with the screws saved above and the 1/4-20 bolts provided in the stacking kit. A 7/16" wrench or socket is required for the bolts.
8. Secure the base of the top unit to the exterior top of the bottom unit by tightening the 5/16-18 stacking bolts using a 1/2" (13mm) wrench or suitable tool.
9. Replace the base cover on the top unit.
10. The stacked units are ready to be prepared for service.

**Note** If desired, refer to center-of-gravity and attachment information in Section 8. ▲

## Preliminary Cleaning

1. Remove the protective plastic coating on the shelf supports, duct sheets, and air duct, if present.
2. Using a suitable laboratory disinfectant, thoroughly clean all interior surfaces including shelves and shelf supports, door gaskets, blower wheel and CO<sub>2</sub> sensor. Refer to Section 5.

**Caution** Before using any cleaning or decontamination method except those recommended by the manufacturer, users should check with the manufacturer that the proposed method will not damage the equipment. Accidental spills of hazardous materials on or inside this unit are the responsibility of the user. ▲

## Installing Access Port Filter

Locate the opening in the top left corner of the interior chamber. Remove the tape from the opening on the outside of the unit. Locate the stopper with filter in the hardware bag. Install in the opening inside the chamber. See Figure 1-7a.

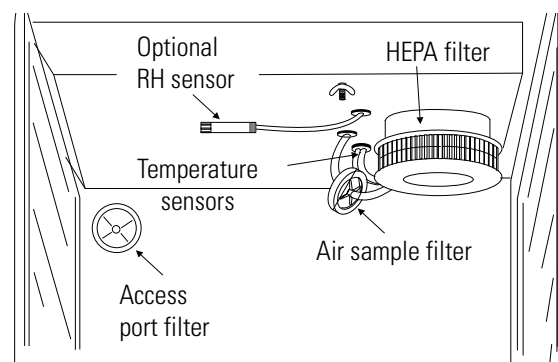

**Figure 1-7a.** Filter and Sensor Locations

## Installing Air Sample Filter

1. Remove the filter from the shipping bag.
2. Separate one section of the tubing from the filter. Install this section to the fitting on the blower plate.
3. After installing the top duct, connect the filter assembly to the tubing coming through the top duct.

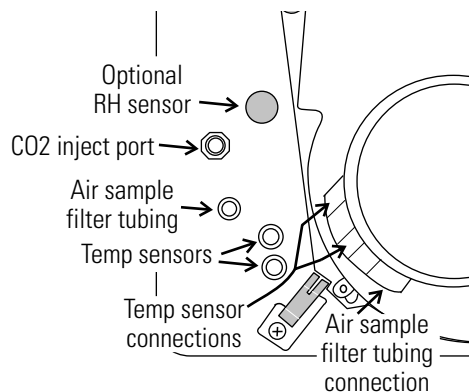

Figure 1-7b. Complete Configuration

4. Insert the free end of the air sample filter tubing into the larger hole in the back of the blower scroll. Refer to Figures 1-7a and 1-7b.

## Installing HEPA Filter

1. Remove the filter from the shipping box.
2. Remove the plastic bag from the filter, using caution not to touch the filter media.
3. Install the filter as shown in Figure 1-7a.
4. To set-up an automatic REPLACE HEPA reminder, see Section 2.

**Caution** The media of the filter can be damaged if mishandled. To avoid damage to the incubator, do not operate the unit without the HEPA filter in place. ▲

## Installing Shelves

1. Install the side ducts with the tabs facing into the center of the chamber with their slots up, and the smaller cutout to the top. There are no right side or left side ducts, simply rotate one of them to fit the opposite side. Tilt the side ducts as they are placed in the chamber so the tops fit into the top air duct, then guide them into the vertical position. Figure 1-8 shows the duct as it would be oriented for the right side of the chamber.

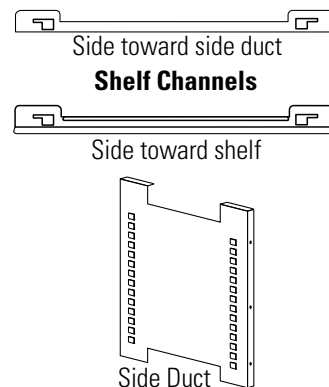

Figure 1-8. Shelf Channels & Side Duct

## Installing Shelves (cont.)

2. Referring to Figure 1-9, note that there is no difference between left and right side shelf channels.

3. Install the shelf channels by placing the channel's rear slot over the appropriate rear tab on the side duct. Pull the shelf channel forward and engage the channel's front slot into the side duct's appropriate forward tab. Refer to Figure 1-9.

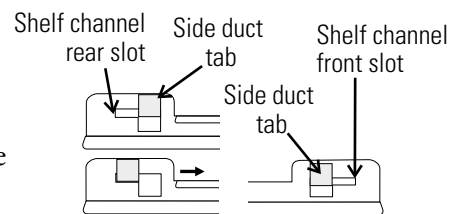

Figure 1-9. Slot and Tab

4. Figure 1-10 shows one of the channels installed on the right side duct.

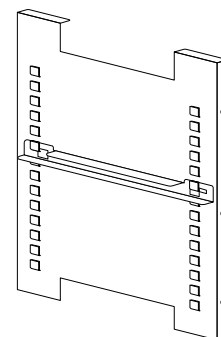

Figure 1-10. Channel Installed

## Leveling the Unit

Check the unit for being level by placing a bubble-style level on one of the shelves. Turn the hex nut on the glide foot counterclockwise to lengthen the leg, or clockwise to shorten it. Level the unit front-to-back and left-to-right.

## Connecting Unit to Electrical Power

See the serial tag on the side of the unit for electrical specifications, or refer to the electrical schematics in Section 9 of this manual.

**Warning** Connect the incubator to a grounded dedicated circuit only. In an emergency, the power cord connector is the mains disconnect device for the incubator. Position the unit so that it can be easily disconnected. ▲

Plug the provided power cord into the power inlet connector (Figure 1-11) and into the grounded dedicated circuit.

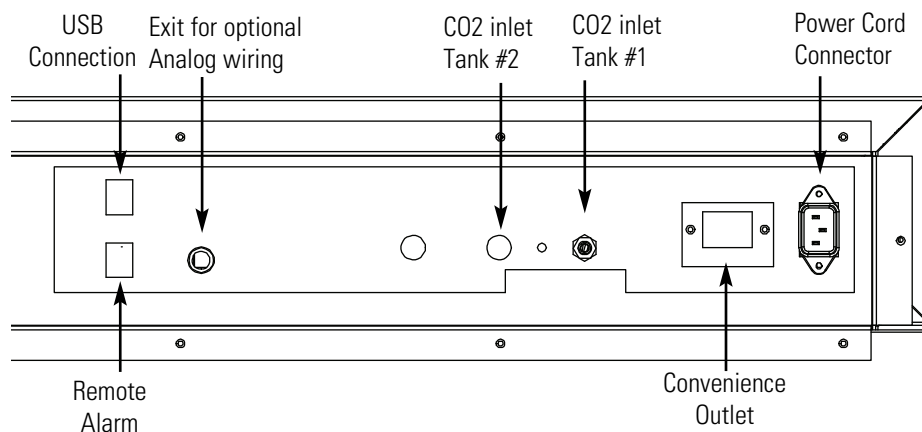

Figure 1-11. Back Panel and All Connections

## Filling the Water Jacket

Turn the power switch on. ERROR LOW WATER alarm message will appear on the display. Touch the display to silence the alarm.

Note that the fill port has a plug that must be removed before filling and replaced after filling is complete.

**Caution** Chlorine is detrimental to stainless steel. Using chlorinated tap water or additives that contain chlorine will void water-jacket warranty! ▲

Fill the water jacket with 11.7 gallons (43.5 liters) of distilled water. Silicone tubing and a funnel are shipped in the accessory bag with the unit.

For ease of connecting/disconnecting, use the silicone tubing provided to connect directly to the fill port. See Figure 2-1 and this detail. Do not install vinyl tubing directly onto the fill port as it may be difficult to remove. A 3/8" to 3/8" hose connector has been provided to attach lengths of vinyl tubing to the silicone fill port tubing, to reach the pure water source.

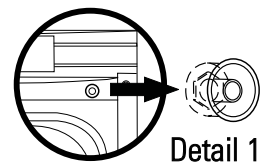

When the jacket is full, the audible alarm changes to a continuous tone for 10 seconds. Add an additional 1 quart (1 liter) of water after the continuous tone begins. Touch the display to clear the LOW WATER alarm message.

**Note** Model 4100 Series Water Jacket Incubator is shipped from the factory with a rust inhibitor added to the water inside the unit. The rust inhibitor must be replenished every 2 years. See Section 6 to drain the water jacket and for the correct proportion of rust inhibitor to the water. ▲

## Filling the Humidity Pan

For best operation of the incubator, sterilized distilled water should be used in the humidity pan. Water purity should be in the resistance range of 50K to 1M Ohm/cm, or a conductivity range of 20.0 to 1.0 uS/cm. Refer to ASTM Standard D5391-93 or D4195-88 for measuring water purity.

## Filling the Humidity Pan (cont.)

Distillation systems, as well as some types of reverse osmosis water purity systems, can produce water in the quality range specified. Tap water is not recommended as it may contain chlorine, which can deteriorate the stainless steel. Tap water may also have a high mineral content, which would produce a build-up of scale in the pan. High purity or ultra pure water is not recommended as it is an extremely aggressive solvent and will deteriorate the stainless steel. High purity water has a resistance of above 1M to 18M Ohm. Even high purity water can contain bacteria and organic contaminants. Water should always be sterilized or treated with a decontaminant, safe for use with stainless steel as well as safe for the product, prior to being introduced into the humidity pan.

**Caution** Use of chlorinated water, or decontamination products containing chlorine, will deteriorate the stainless steel and cause rust, voiding the warranty. ▲

Fill the humidity pan to within 1/2 inch (12mm) of the top with sterile, distilled water. Place the pan directly on the incubator floor to ensure optimum humidity and temperature response. It is recommended that the humidity pan be placed against the left side wall of the chamber to aid humidity recovery after door openings. The ductwork has been modified for this purpose. Also the sample port may be capped to assist in achieving greater RH. In some ambients, this may cause condensation to form in the chamber, if the sample port remains capped.

On O<sub>2</sub> control models, the gas sample port must be capped for proper O<sub>2</sub> control.

Check the level and change the water frequently to avoid contamination. Do not allow the water level to fluctuate significantly. “Dry-outs” will have an adverse effect on the humidity level as well as CO<sub>2</sub> calibration and the thermoconductivity (TC) system.



## Connecting CO<sub>2</sub> / O<sub>2</sub> System Gas Supply

**Warning** High concentrations of CO<sub>2</sub> gas can cause asphyxiation! OSHA standards specify that employee exposure to carbon dioxide in any eight-hour shift of a 40-hour work week shall not exceed the eight-hour time weighted average of 5000 PPM (0.5% CO<sub>2</sub>). The short term exposure limit for 15 minutes or less is 30,000 PPM (3% CO<sub>2</sub>). Carbon dioxide monitors are recommended for confined areas where concentrations of carbon dioxide gas can accumulate. ▲

**Warning** High concentrations of CO<sub>2</sub> gas can cause asphyxiation! CO<sub>2</sub> can displace oxygen levels in a confined atmosphere. The first signs of hypoxia occur when oxygen levels fall below 17%. They include decreased night vision, increased breathing volume and accelerated heartbeat. Oxygen levels below 6% cause death. Oxygen monitors are recommended for confined areas where concentrations of CO<sub>2</sub> may displace oxygen. ▲

The CO<sub>2</sub> gas supply being connected should be industrial grade 99.5% pure and should not contain siphon tubes. Do not use liquid CO<sub>2</sub> or nitrogen.

Install a two-stage pressure regulator at the cylinder outlet. The high pressure gauge at the tank should have 0-2000 psig range and the low pressure gauge, at the incubator inlet, should have a 0-30 psig range. Input pressure to incubator must be maintained at 15 psig (103.4 kPa), ±4 psig.

The incubator has serrated fittings on the back of the cabinet to connect the gas supply. Refer to Figure 1-12. The fitting is labeled #1 CO<sub>2</sub> Inlet. Make sure that the connections are secured with clamps. Check all fittings for leaks.

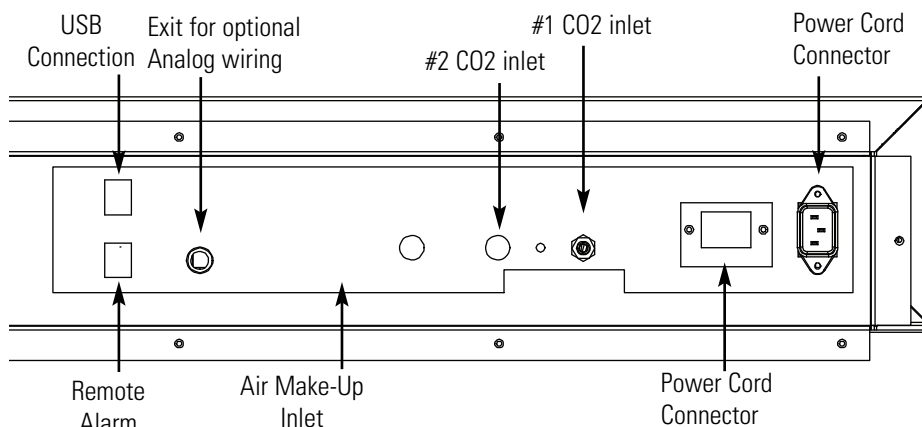

**Figure 1-12.** Back Panel and All Connections

For units having the CO<sub>2</sub> Gas Guard option, see Section 7.

## Connecting Gas Supply (cont.)

**Warning** This incubator is designed to be operated with CO<sub>2</sub> gas system. Connecting a flammable or toxic gas can result in a hazardous condition. Gases other than CO<sub>2</sub> or N<sub>2</sub> should not be connected to this equipment. CO<sub>2</sub> gas cylinders have UN1013 labeled on the cylinder and are equipped with a CGA 320 outlet valve. Check the gas cylinder for the proper identification labels.

The CO<sub>2</sub> gas supply being connected to the incubator should be industrial grade, 99.5% pure. Do not use CO<sub>2</sub> gas cylinders equipped with siphon tubes. A siphon tube is used to extract liquid CO<sub>2</sub> from the cylinder, which can damage the pressure regulator. Consult with your gas supplier to ensure that the CO<sub>2</sub> cylinder does not contain a siphon tube. Do not use liquid CO<sub>2</sub> or nitrogen. Gas cylinders should be secured to a wall or other stationary object to prevent tipping.

A two-stage pressure regulator is required to be installed on the outlet valve of the gas cylinder. Input pressure to the incubator must be maintained at 15 psig (103.4kPa) for proper performance of the CO<sub>2</sub> or O<sub>2</sub> control system. (A single stage pressure regulator will not maintain 15 psig (103.4kPa).)

If higher purity CO<sub>2</sub> is desired inside the incubator (greater than 99.5% pure), the pressure regulator should be constructed with a stainless steel diaphragm along with specifying the purity of the CO<sub>2</sub> from the gas supplier. Follow the manufacturer's instructions to ensure proper and safe installation of the pressure regulator on the gas cylinder. Consult your facility safety officer to ensure that the equipment is installed in accordance with codes and regulations that are applicable in your area. ▲

## Section 2 Installation and Start-Up

### Name and Description of Parts

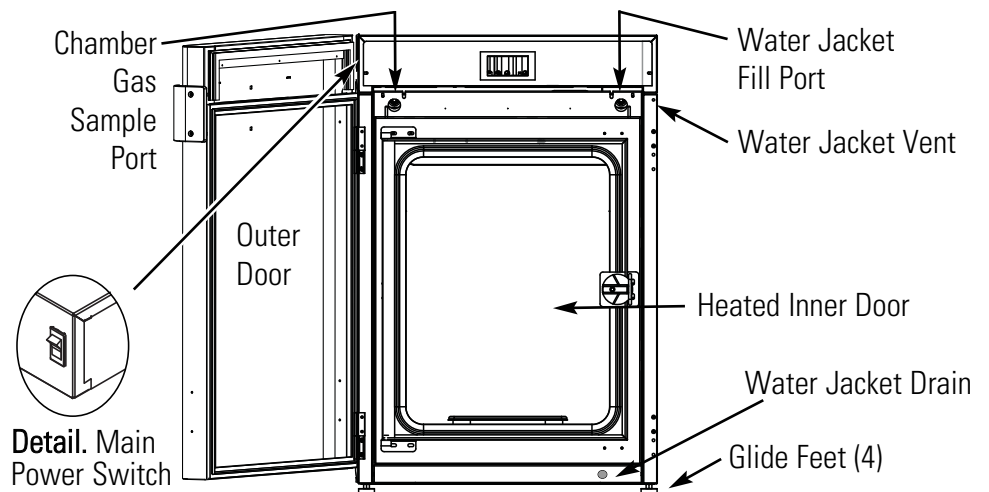

Figure 2-1. Water Jacket Incubator

- Outer Door - Reversible to opposite swing (Section 6).
- Heated Inner Door - Keeps chamber interior dry. Reversible to opposite swing (Section 6).
- Chamber Gas Sample Port - Used for sampling chamber CO<sub>2</sub> content, using a Fyrite® or similar instrument. Only cap when controlling O<sub>2</sub>.
- Main Power Switch - Located on the upper left side of the unit
- Control Panel - Keypad, Displays and Indicators (Figure 2-2).
- Fill Port - Used for filling the water jacket. Cap when fill is complete.
- Water Jacket Vent- Do not cover! Allows air to escape from the water jacket during filling and normal expansion and contraction when the incubator heats or cools.
- Glide Feet (leveling) - Used to level the unit.
- Water Jacket Drain – Use hose barb insert included.

**Note** The incubators are stackable. See Section 1. ▲

## Power Switch

The power switch is located on the top left side of the top outer housing.

1. To turn the device on, press the power switch.
  - The display remains dark for about 10 seconds, then there is an audible beep and the touchscreen display appears.
  - The control loop sensors will pass the heat-up phase.

**Note** The display may show dots (...) instead of values during the heat-up phase. See page 2-6. ▲

2. To turn the device off, press the power switch. The touchscreen turns off.

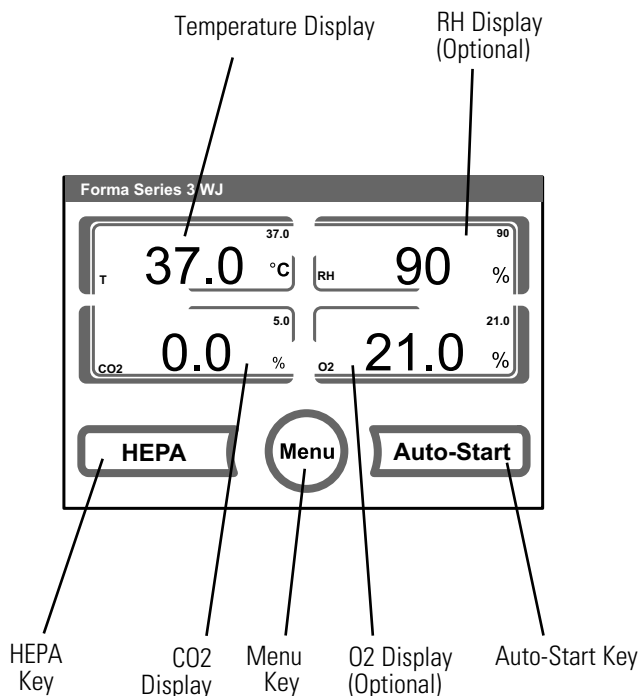

Figure 2-2. Control Panel

## Installing the Unit

1. Locate the unit on a firm, level surface capable of supporting the unit's operational weight of 365 lbs. (166kg).
2. Locate away from doors, windows, and heating and air conditioning ducts.
3. Maintain a 3 inch (8cm) clearance behind the unit for electrical and gas hook-up. In addition, a 3 inch (8cm) ventilation clearance is needed on each side.
4. If desired, refer to attachment and center-of-gravity information in Section 8.

## Operating Panel and Operating Structure

The control panel works as a touchscreen and can be controlled by touching with light pressure on the pressure-sensitive areas of the screen, using a finger or a stylus.

**Note** To acknowledge an error message, the entire touchscreen can be used as a pressure-sensitive area. ▲

Operation is divided into three levels; 1) Direct access to the control loop settings: Temperature, CO2, O2 set value (optional) RH value (optional), 2) Start of the device Auto-Start, and 3) Navigation through the submenus for device configuration.

### Versions without O2 Control

Function keys and value displays of the operating panel for a device version without O2 gas supply or RH option shown in Figure 2-3.

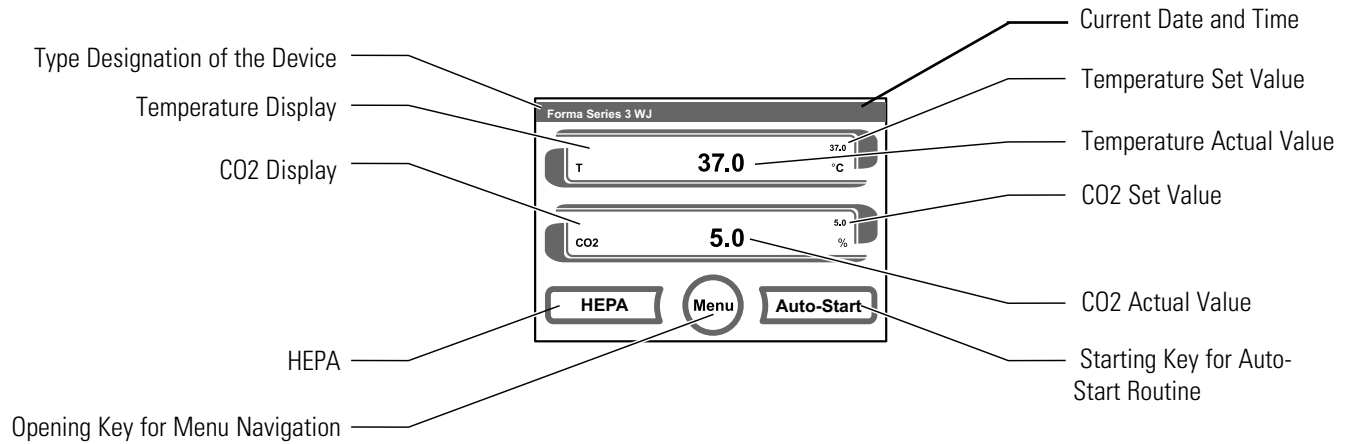

Figure 2-3. Keys and Displays for Version without O2 Supply

### Versions w/ Combined CO2/O2 Control (optional)

Function keys and value displays of the operating panel of a device version with combined CO2/O2 gas supply shown in Figure 2-4.

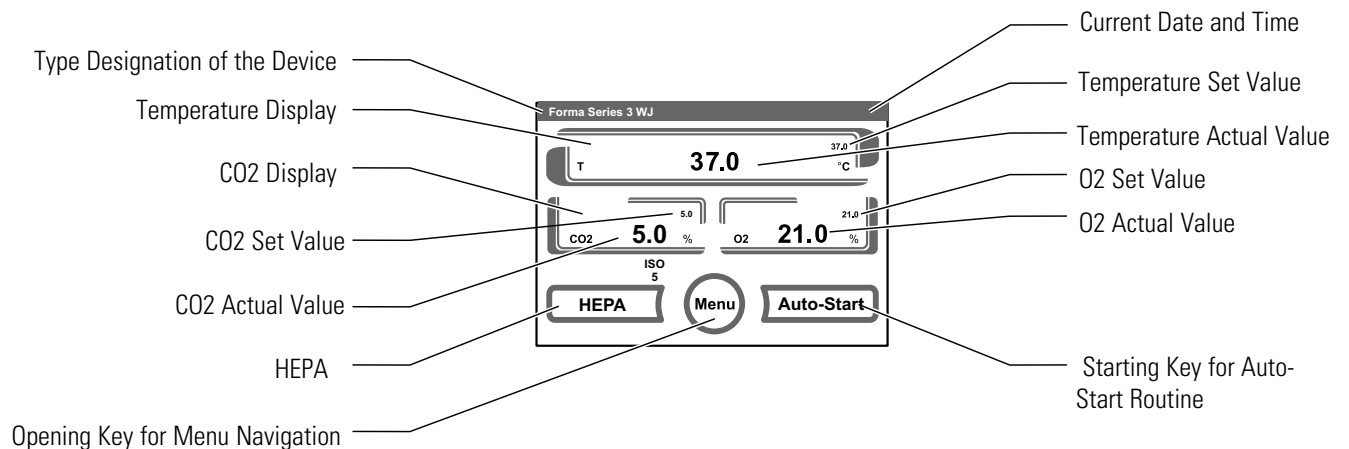

Figure 2-4. Keys and Displays for Version with CO2/O2 Supply

## Versions with RH Option

Function keys and value displays of the operating panel for a device version with RH option shown in Figure 2-5.

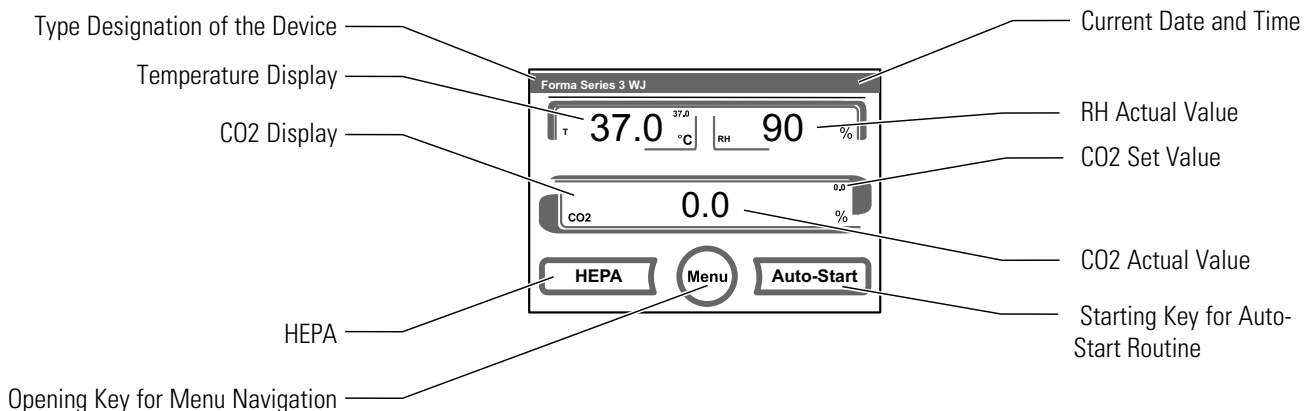

Figure 2-5. Keys and Displays for Version with RH Option

## Versions w/ Combined CO2/O2 Control & RH Option

Function keys and value displays of the operating panel of a device version with combined CO2/O2 gas supply (optional) and RH option shown in Figure 2-6.

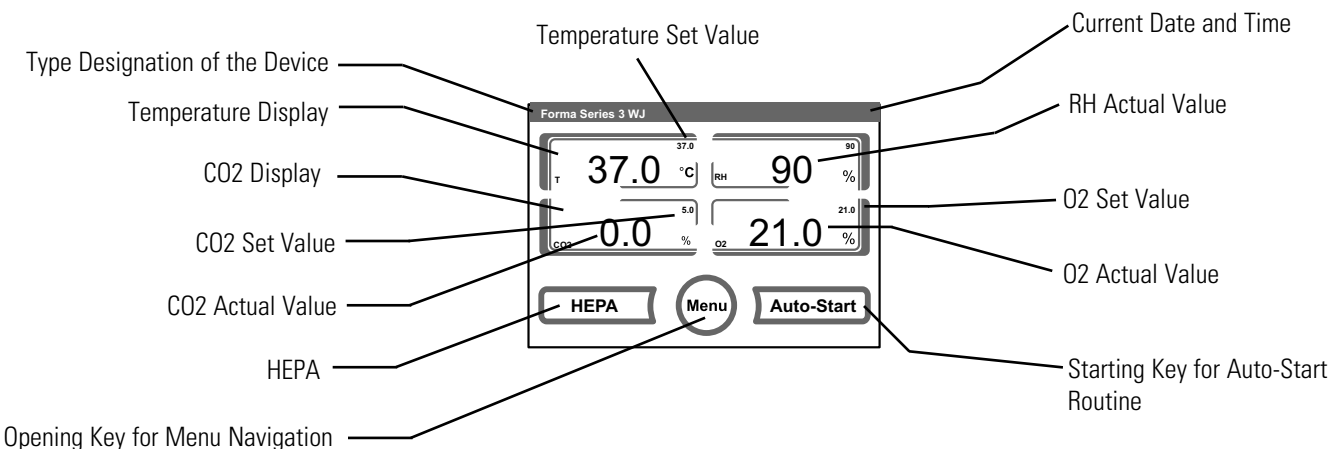

Figure 2-6. Keys and Displays for Version with CO2/O2 Supply and RH Option

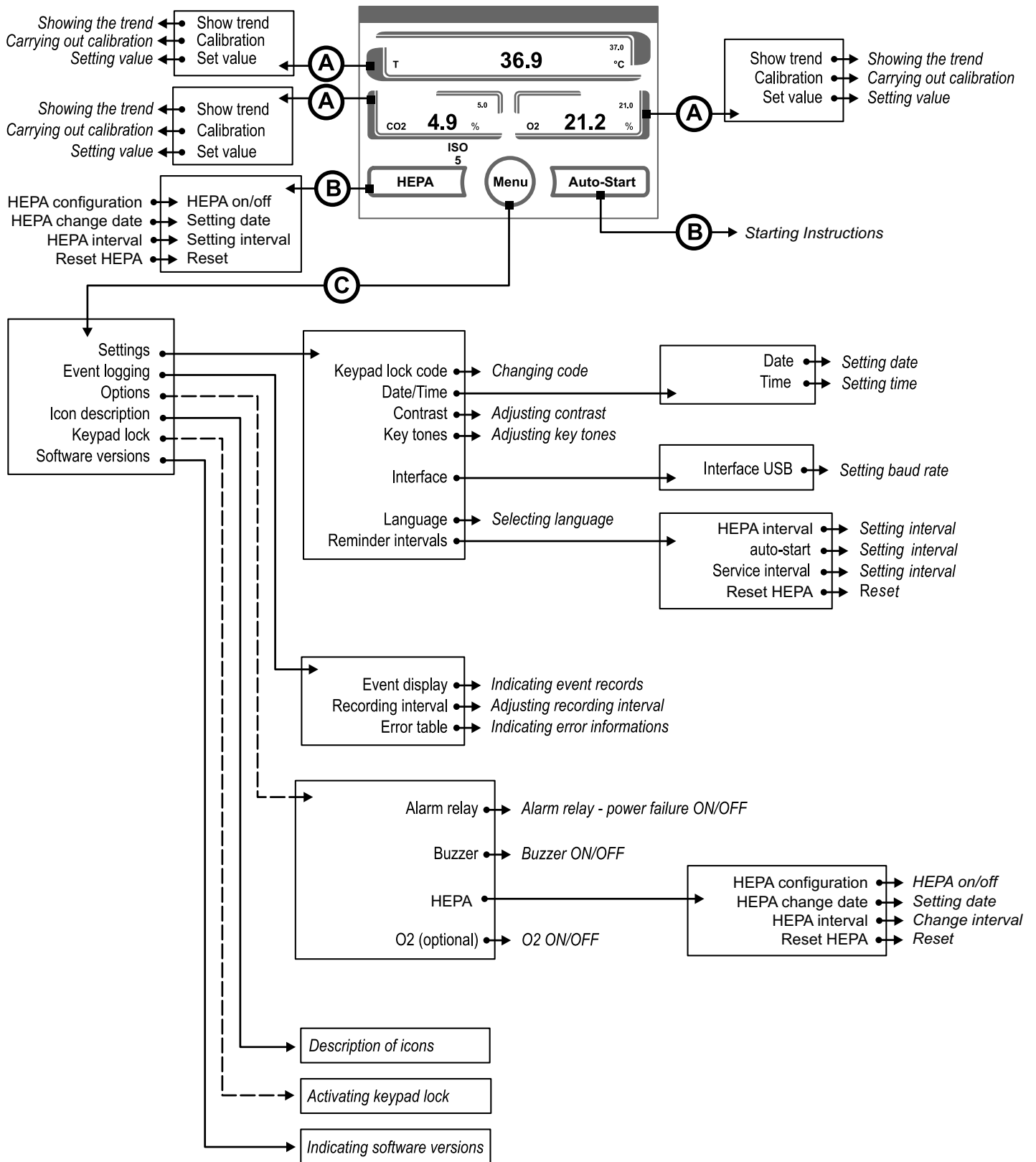

Figure 2-7. Menu Configuration

## Factory Setting of the Touchscreen Controls

Upon delivery of the device, the following set values have been preset:

- Temperature: 37 °C
- CO2 content: 0.0%
- O2 content (optional): 21.0%

**Note** CO2/O2 control: Since the CO2 concentration of the air is nearly 0%, the CO2 control and the control loop error monitoring system are disabled at a set value of 0%. Since the O2 concentration of the air is nearly 21%, the O2 control and the control loop error monitoring system are disabled at a set value of 21%. ▲

## Heat-up Phase of the Control Loop Sensors

When the device has been switched on, the control loop sensors pass through a heat-up phase of varying duration during the start process:

Temperature control loop .....10 seconds  
 rH control loop .....10 seconds  
 CO2 control loop .....10 seconds  
 O2 (optional) control loop .....5 minutes

The start process is indicated by an audible signal.

During the heat-up phase, the displays show dots (...) instead of values:

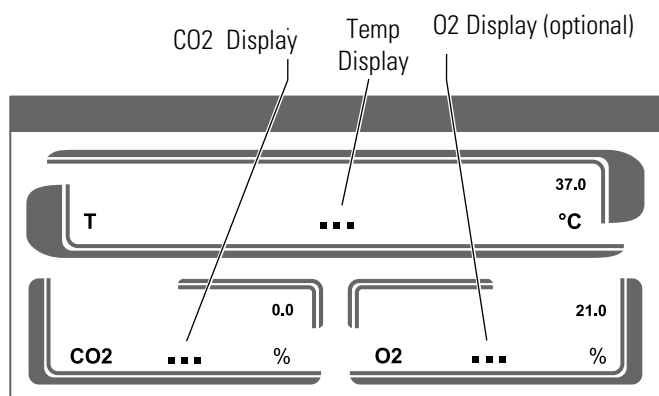

Figure 2-8. Heat-up Phase Display

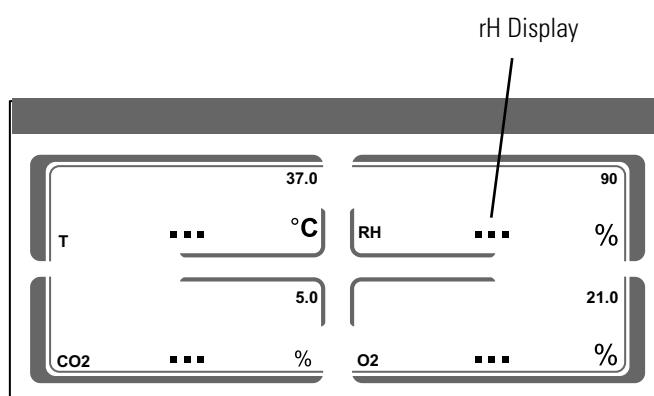

Figure 2-8. Heat-up Phase Display (with rH)

After the heat-up phase has been completed, the control loop actual values are indicated.

**Caution** During the heat-up phase, gas is not injected into the workspace (chamber). ▲



## Event Actions for Settings

Pressing a key can increase or reduce a value gradually. When the – key or the + key is kept depressed for more than 3 seconds, the system switches to quick run.

**Note** To save changed values, press the Enter key. Unless a user action (contact with the pressure-sensitive areas and keys) occurs within 30 seconds, the system automatically exits the menu and the most recently confirmed setting defaults. ▲

## Setting the Temperature Set Value

1. Press the TEMPERATURE DISPLAY key.
  - > The Temperature menu is displayed.
2. To exit the Temperature menu:
  - > Press the END key.
3. To set the temperature set value:
  - > Press the SET VALUE key.
  - 3a. To increase the set value:
    - > Press the + key.

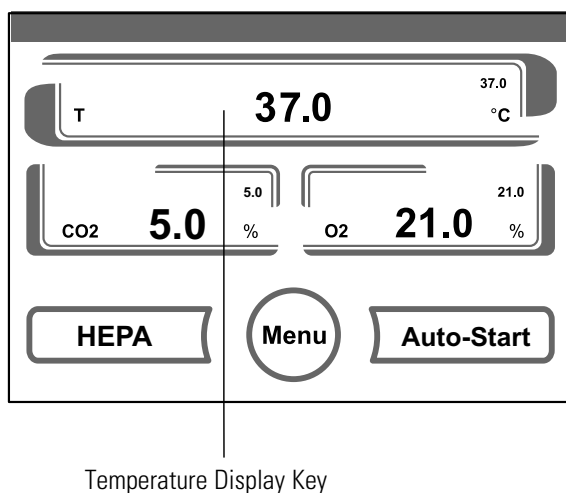

Figure 2-9. Keys for Temp Set Value

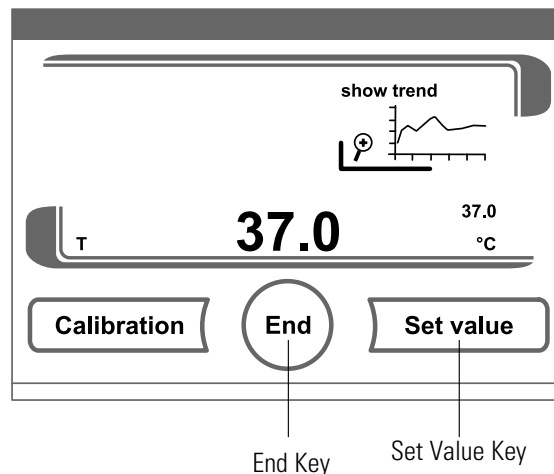

Figure 2-10. Remaining Keys for Temp Set Value

## Setting the Temperature Set Value (continued)

- 3b. To reduce the set value:
- > Press the - key.
4. To accept and save the set value, or to return to the previous menu:
- > Press the ENTER key.
  - > The system returns to the main menu. The temperature displays shows the actual value currently measured in the work space.

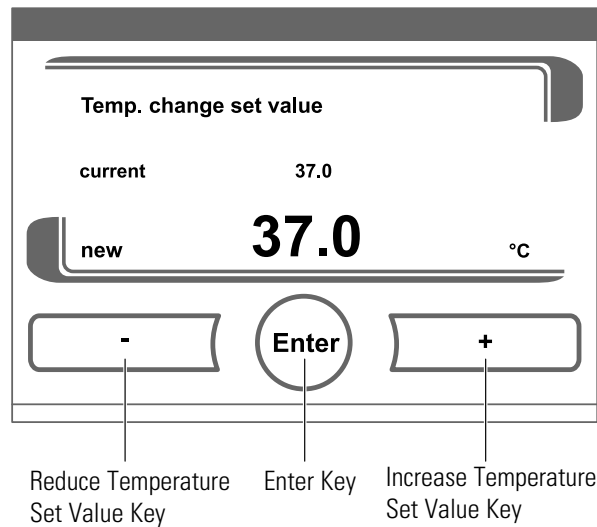
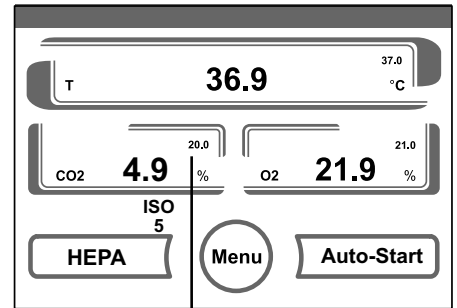

Figure 2-11. Remainder of Temperature Set Value Keys

## Setting the CO2 Set Value

1. Press the CO2 DISPLAY key.
  - > The CO2 menu is displayed.
2. To exit the CO2 menu:
  - > Press the END key.
3. To set the CO2 set value:
  - > Press the SET VALUE key.
- 3a. To increase the set value:
  - > Press the + key.
- 3b. To reduce the set value:
  - > Press the - key.
4. To accept and save the set value:
  - > Press the ENTER key.
  - > The system returns to the main menu. The CO2 display shows the actual value currently measured in the work space.

**Note** To deactivate the CO2 control, set the value to 0%. If the control loop is deactivated, error monitoring is disabled as well.



CO2 DISPLAY Key

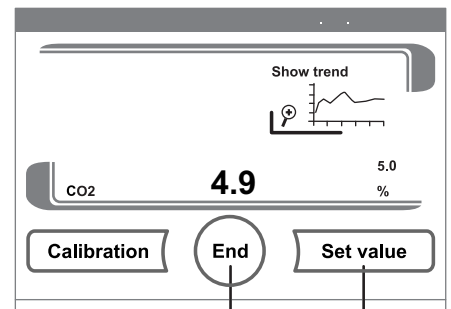

END Key SET VALUE Key

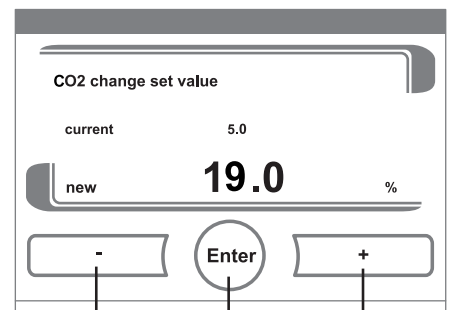

(-) Key ENTER Key (+) Key

Figure 2-12. Set Value for CO2

## Setting the O2 Set Value

This setting is only possible on versions with the optional O2 control.

1. Press the O2 DISPLAY key.
  - > The O2 menu is displayed.
2. To exit the O2 menu:
  - > Press the END key.
3. To set the O2 set value:
  - > Press the SET VALUE key.
- 3a. To increase the set value:
  - > Press the + key.
- 3b. To reduce the set value:
  - > Press the - key.
4. To accept and save the set value:
  - > Press the ENTER key.
  - > The system returns to the main menu. The O2 display shows the actual value currently measured in the work space.

**Note** The control range has been preset at the factory from 1% to 21%.

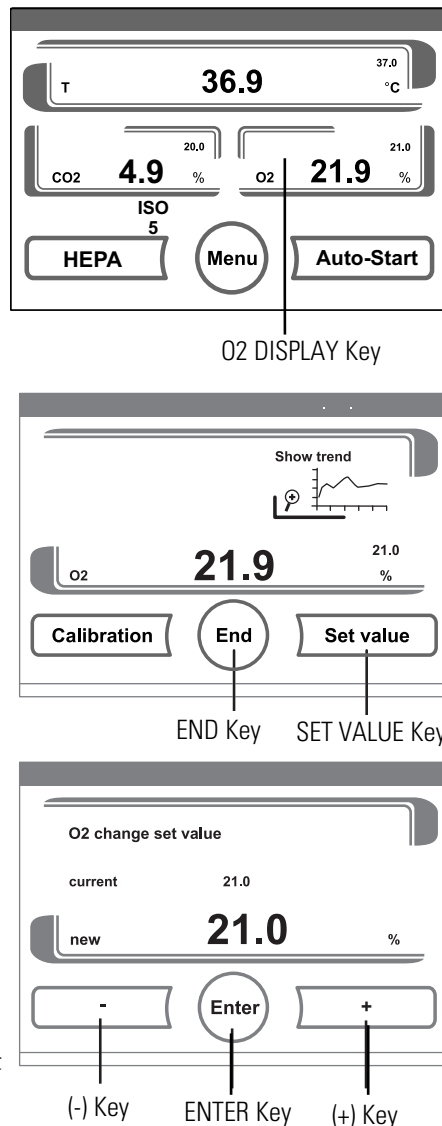

Figure 2-13. Set Value for CO2

### Usage of the Process Gases:

**Note** Never use mixed process gases.

For set values below 21% O2, the device must be connected to a nitrogen supply system.

Since the O2 concentration of the air is nearly 21%, the O2 control and the control loop error monitoring system are disabled at a set value of 21%.

## Auto-Start Routine

The Auto-Start function is an automated routine for the start and the subsequent adjustment of the CO<sub>2</sub> and O<sub>2</sub> measuring system. After the start, the device control adjusts the temperature to the set value while humidity is generated, and CO<sub>2</sub> is not activated. When temperature and relative humidity have reached constant values, the CO<sub>2</sub> measuring system is automatically adjusted to these values, and the work space is supplied with the preset quantity of CO<sub>2</sub>, after the completion of Auto-Start.

**Note** Auto-Start adjusts the CO<sub>2</sub> to zero (TCD only, IR will not zero in the display). Actual CO<sub>2</sub> set point still needs to be calibrated.

### Application of the Auto-Start routine:

To ensure that the specified accuracy of the CO<sub>2</sub> measuring system is maintained, the device should always be started using Auto-Start routine if:

- a difference of more than 1°C is entered when setting temp set value,
- the device is restarted after an extended interruption of operation,
- new sensor, main board installation or adding or removing a water pan.

The Auto-Start routine should be run at least every three months on the occasion of cleaning and maintenance in the unit.

### Duration of the routine:

Running the routine usually takes 5 to 7 hours. At low room temperatures and when the device is cold, it may take up to 10 hours maximum until the Auto-Start routine has been completed. If the glass door is opened or if the power supply of the device is interrupted while the routine is running, the routine is interrupted and will rerun after the glass door has been closed or the power supply has been reestablished.

### Start conditions for the Auto-Start routine:

Prior to running the Auto-Start routine, set the CO<sub>2</sub> and O<sub>2</sub> set values to the desired values, applicable gas tank valves are opened and make sure that the atmosphere in the work space only consists of ambient air. The water pan of the device must be filled with a sufficient quantity (2 liters minimum) of distilled, sterile water. All samples should be removed prior to starting the Auto-Start.

## Auto-Start Routine (continued)

### Conditions that prevent the start of the Auto-Start routine:

The Auto-Start routine cannot be started if one of the following failure conditions exists.

#### Temperature control loop:

- Sensor breakage,
- actual value above set value (excessive deviation),
- actual value below set value (excessive deviation),
- set value not plausible,
- calibration values too high or too low (see Calibration section),
- sensor communication failure.

#### Control loop for CO2 gas supply:

- No communication with sensor.

In this case, the Auto-Start key is dimmed and its function is not available.

#### Faulty cancellation of the Auto-Start routine:

The Auto-Start is cancelled if:

- an error is detected in the temperature control loop,
- an error is detected in the CO2 control loop,
- the water jacket filling level is insufficient.

## Activating Auto-Start

### Before starting:

1. Make sure the CO<sub>2</sub>/O<sub>2</sub> gas supply system valves are open.
2. Fill the water pan of the work space with a sufficient quantity of distilled, sterile water.

**Caution** Correct type of water is required. ▲

3. Set the set values for temperature, CO<sub>2</sub> and O<sub>2</sub> on the touchscreen.

### Auto-Start routine activation:

1. Press the Auto-Start key.
  - > The Auto-Start-instruction menu is displayed.
2. To exit the Auto-Start-instruction menu and cancel Auto-Start:
  - > Press the END key.
3. Activate the Auto-Start routine:
  - > Press the START key.
4. To air the work space, open both device doors.
5. When the audible alarm sounds after 30 seconds, close both device doors.
  - > Status indicator is displayed.

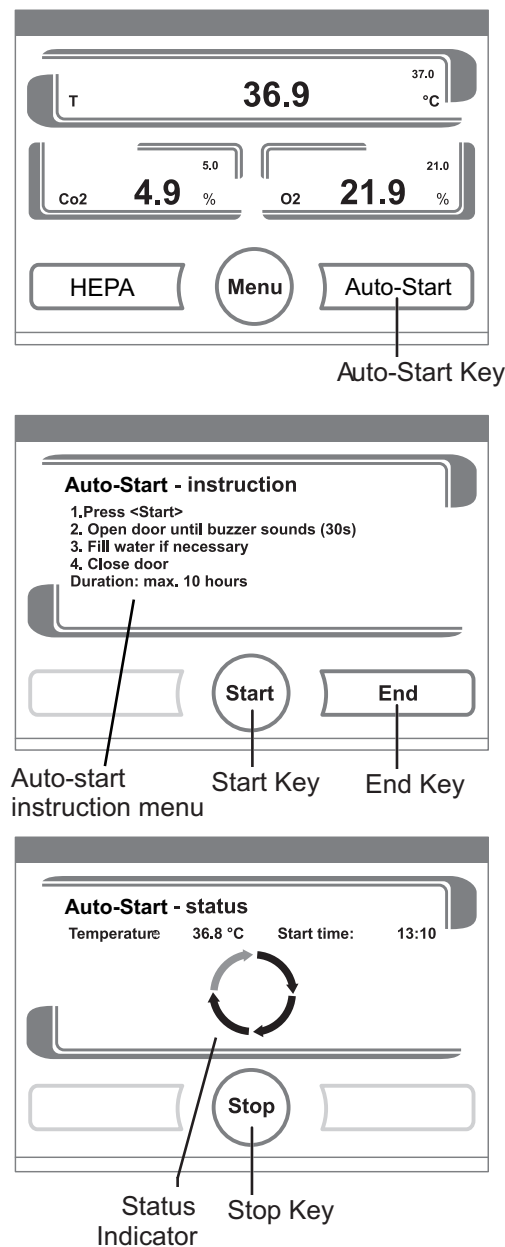

**Figure 2-14.** Activating Auto-Start

6. During the progress, the status indicator displays the Temperature and Start time.

**Note** The Auto-Start routine can be cancelled at any time by pressing the Stop key.

The Auto-Start routine is automatically restarted if:

- the glass door is opened,
- the power supply is interrupted.

## Interrupting the Auto-Start Routine

If the STOP key in the status display is depressed (see above), the Auto-Start routine is interrupted and the Auto-Start stop dialog box is displayed for a safety scan. The routine can now be permanently cancelled or resumed.

1. To resume the Auto-Start routine:
  - > Press the BACK key.
  - > The system returns to the status display, and the Auto-Start routine is resumed.
2. To cancel the Auto-Start routine:
  - > Press the END key.
  - > The warning triangle is displayed as a error message together with the audible signal.
3. To acknowledge the error message:
  - > Press any position on the display.
  - > The ERROR dialog box with the description of the error is displayed.
4. To end the Auto-Start routine:
  - > Press the END key.
  - > The system returns to the main menu.

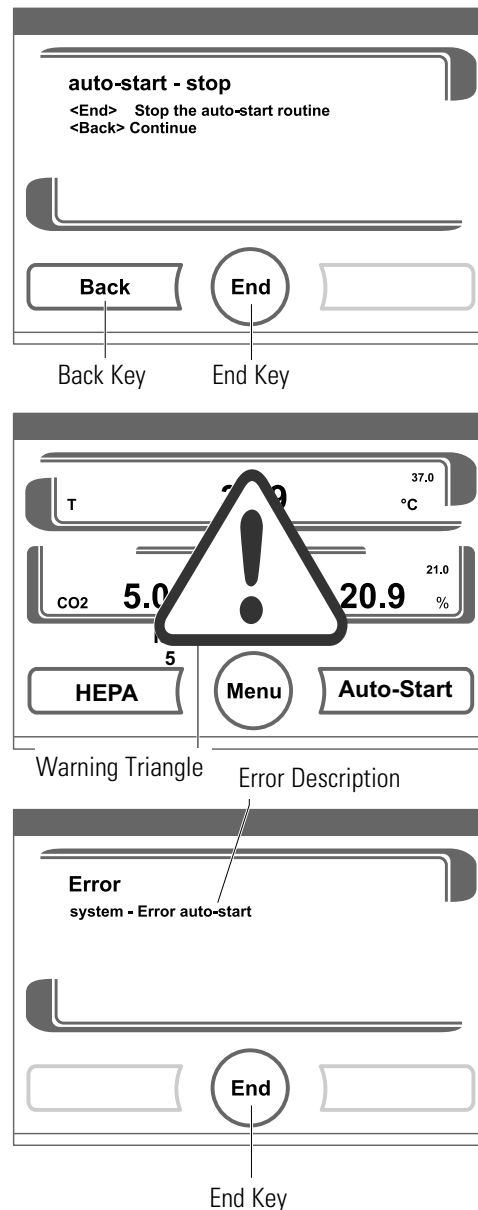

Figure 2-15. Interrupting Auto-Start



## User Configuration

The user configuration settings allow the user interface and the additional device functions to be adjusted to the requirements of everyday operation.

The user configuration menu is split into six categories:

- Settings,
- Event logging,
- Options,
- Icon description,
- Keypad lock,
- Software versions.

To make a user-specific setting in a dialog box, navigate through the submenus listed in the illustrations and open the dialog box.

**Settings** In the SETTINGS category, the following are the displayed sub-menus:

- Keypad lock code,
- Date/Time,
- Contrast,
- Key tones,
- Interface,
- Language,
- Reminder intervals.

### Changing the Keypad lock code:

- Upon delivery, the default code is: 0000.

This default can be changed into a user-defined code that is then enabled using the KEYPAD LOCK dialog box. Refer to Enabling/Disabling the Keypad Lock in Section 4.

## Settings (continued) Changing the keypad lock code (continued):

1. To enter the default 0000:
  - > Press the corresponding numeric keys.
  - > The number combination is displayed hidden in the input box.
2. To delete the input numbers:
  - > Press the DELETE key.
3. To exit the menu:
  - > Press the BACK key.
4. To confirm the input:
  - > Press the ENTER key.
  - > The system changes to the CODE NEW menu.

Menu  
➤ Settings  
➤ Keypad lock code

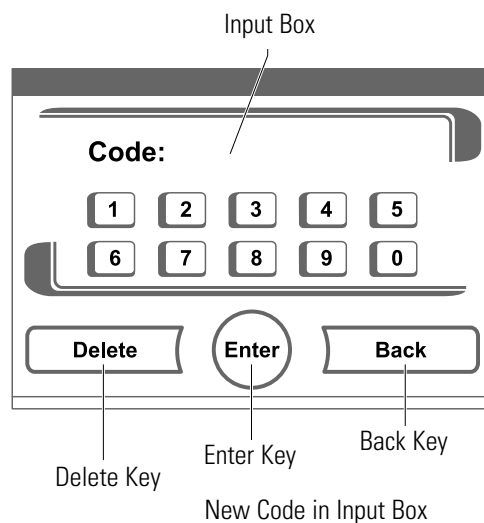

### Entering the new 4-digit code:

- > Press the corresponding numeric keys.
- > The number combination is displayed in the input box.

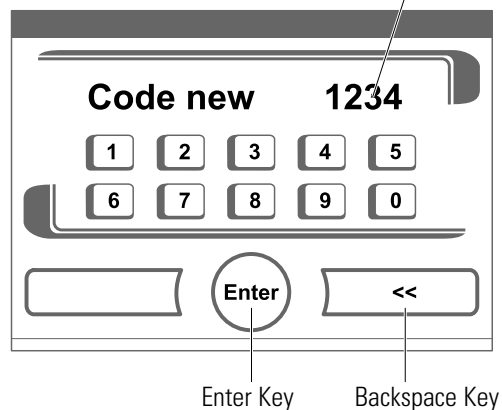

Figure 2-16. Changing the Lock Code

### To set the cursor to the left to overwrite a value:

5. Press the BACKSPACE key (<<).
6. To accept and save the input value:
  - > Press the ENTER key.
  - > The system returns to the Settings menu.

Settings (continued)

**Note** The user-defined code can be changed as often as required using the same procedure:

- Activate the recoding function by entering the valid code,
- Enter the new code and confirm it.

```
Menu
> Settings
  > Date/Time
    > Date
    > Time
```

**Setting Date / Time:**

The input dialog allows date and time to be set to the required time zone.

**Caution** Time is measured in a 24 hour format. ▲

- To enter the date:
  - > Press the numeric key.
  - > The input numbers are displayed in the input box.
- To set the cursor to the left to overwrite a value:
  - > Press the BACKSPACE key (<<).
- To accept and save the input value:
  - > Press the ENTER key.
- The system returns to the Date/Time menu.
- Enter the time accordingly.
- To accept and save the input value:
  - > Press the ENTER key.
  - > The system returns to the Date/Time menu.

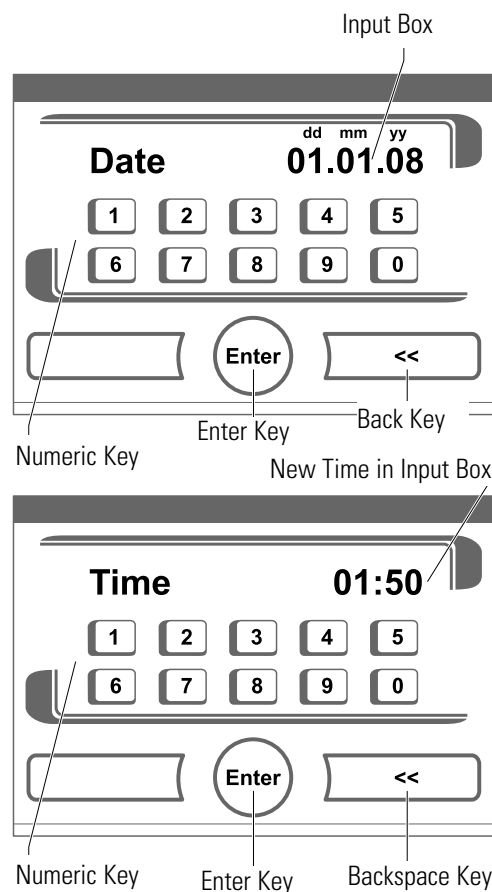

**Figure 2-17.** Date / Time Setting

## Settings (continued) Setting the Contrast:

The input dialog allows the color contrast of the operating panel to be set within the value range of 1% to 100%.

1. To increase the value:
  - > Press the + key.
2. To reduce the value:
  - > Press the - key.
3. The value change appears in the display.
4. To accept and save the change:
  - > Press the ENTER key.
  - > The system returns to the Settings/Setup menu.

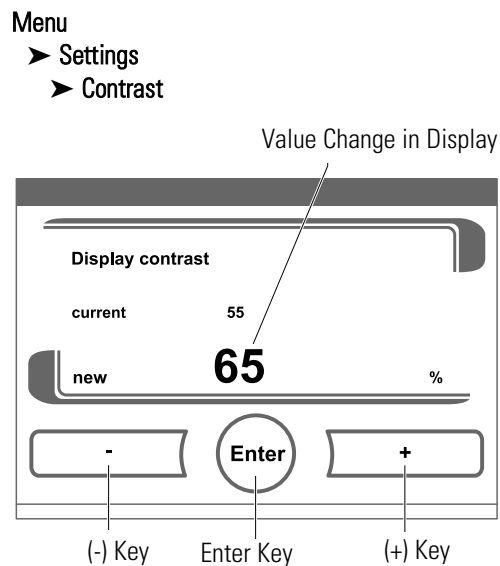

Figure 1-18. Display Contrast Setting

## Setting the Key Tone:

The input dialog allows the loudness of the key tone that sounds whenever a key is depressed to be set.

The value range is 0 to 100. The change occurs in increments of 5%.

1. To increase the value:
  - > Press the + key.
2. To reduce the value:
  - > Press the - key.
3. The value change appears in the display.
4. To accept and save the change:
  - > Press the ENTER key.
  - > The system returns to the Settings/Setup menu.

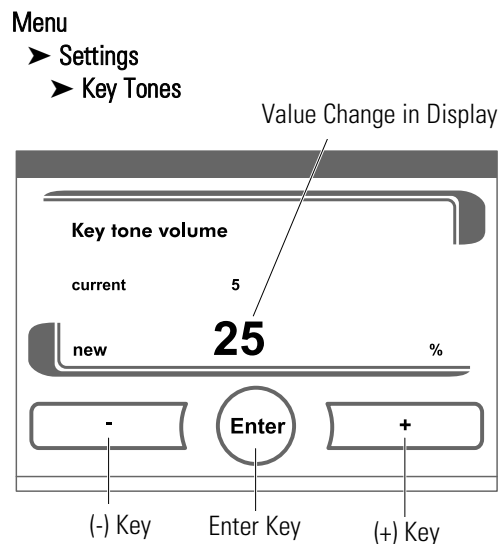

Figure 2-19. Key Tone Setting

**Settings (continued)    Setting the interface baud rate:**

The input dialog allows the setting of the stepping rate for data communication of the USB interface.

The stepping rate of the interface can be changed within the defined baud rates (9,600, 19,200, 38,400, 57,600 baud).

The standard stepping rate is 57,600 baud.

1. To increase the value:
  - > Press the + key.
2. To reduce the value:
  - > Press the - key.
3. The value change appears in the display.
4. To accept and save the change:
  - > Press the ENTER key.
  - > The system returns to the Interface menu.
5. To activate the new settings:
  - > Browse back to the main menu.
  - > Wait for approximately 10 seconds.
  - > Perform a reset by switching the device power off, wait 10 seconds, then turn back on.

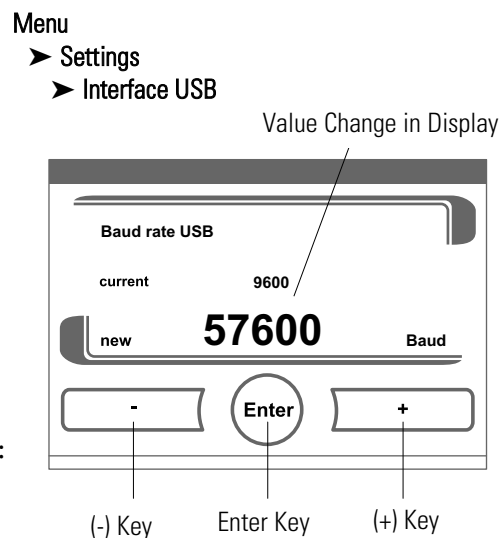

**Figure 2-20.** USB Interface Baud Rate

## Settings (continued)    Setting the user display screen language:

The input dialog allows the language of the display screen to be set. The languages listed below are available:

- German,
- English,
- Spanish,
- French,
- Italian,
- Chinese,
- Japanese.

1. To browse upward in the selection:

> Press the + key.

2. To browse downward in the selection:

> Press the - key.

3. The new language appears in the display.

4. To accept and save the selection:

> Press the ENTER key.

> The system returns to the Settings menu.

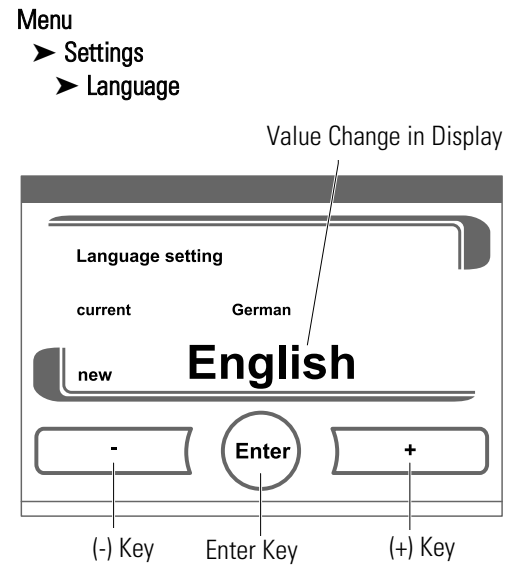

Figure 2-21. Language Setting

Settings (continued)

Factory settings	
Auto-Start Routine	Off
Preventative Maintenance Due Interval	Off
HEPA Interval	365 days
Event Display	
Recording Interval	120 sec
Error Table	

Setting the reminder intervals:

The reminder intervals are integral components of the alarm and monitoring system of the device control. For the two essential functions HEPA and Auto-Start as well as for routine service work, the user can set dates that trigger an alarm whenever they occur. The counting begins at 00:00 hrs of the day on which the previously set reminder interval has elapsed.

On the due date, the display shows a reminder message for the activated reminder interval.

- Auto-Start: Run Auto-Start.
- Preventative Maintenance Due Interval: The reminder message can be confirmed. In this case, the preventative maintenance due icon is displayed.
- HEPA interval: Change HEPA filter

After the routines have been run successfully, the reminder messages are hidden.

To change the interval settings:

1. To increase the value:  
> Press the + key.
2. To reduce the value:  
> Press the - key.
3. The value change appears in the display.
4. To accept and save the change:  
> Press the ENTER key.  
> The system returns to the Settings/Setup menu.

Menu

- Settings
  - Reminder Intervals
    - Auto-Start
    - Preventative Maintenance Due Interval
    - HEPA Interval
    - Reset HEPA

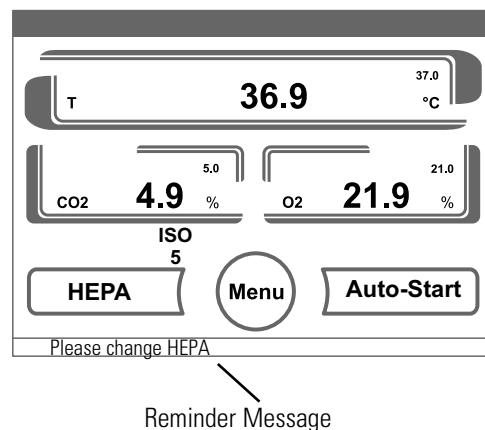
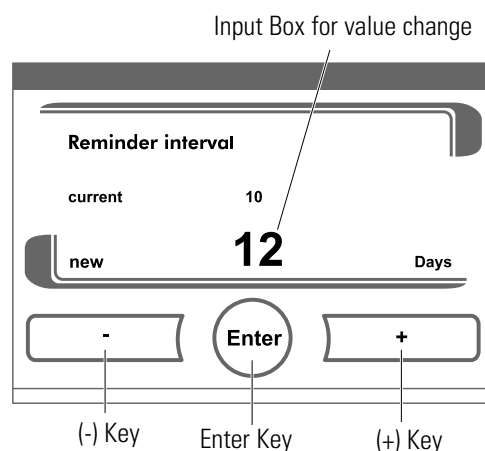

Figure 2-22. Reminder Interval Setting

Settings (continued) Accessing Event Display, Recording Interval or Error Table:

Press Menu, then Event Logging.

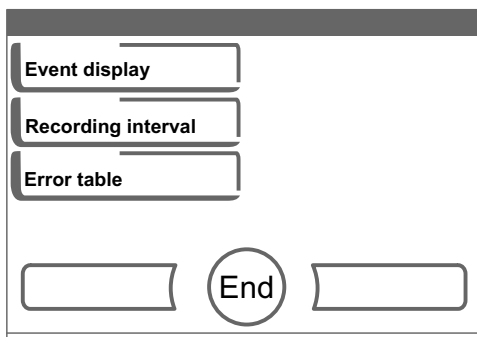

Figure 2-23. Event Logging

Loop	Date	Time	Error	001/002
RH	23.05.14	09:59:15	Sensor breakage	
T	23.05.14	09:58:58	Sensor breakage	
T	23.05.14	09:58:58	Sensor breakage	
CO2	23.05.14	09:58:27	Error communication	
RH	23.05.14	08:31:41	Sensor breakage	
T	23.05.14	08:31:24	Sensor breakage	
T	23.05.14	08:31:24	Sensor breakage	
CO2	23.05.14	08:30:53	Error communication	
SYS	21.05.14	15:20:09	Error display	
RH	21.05.14	15:06:37	Sensor breakage	
T	21.05.14	15:06:20	Sensor breakage	

At the bottom of the table, there is a circular "End" button flanked by two empty rectangular buttons.

Figure 2-24. Event Table

The Interval Time Data Logger can be changed. Factory setting is 120 seconds.

1. Press **Recording interval**.
2. To change the state:
  - Press the + or - key.
3. The value change appears in the display.
4. To accept and save the change:
  - Press the **Enter** key.
  - The system returns to normal.

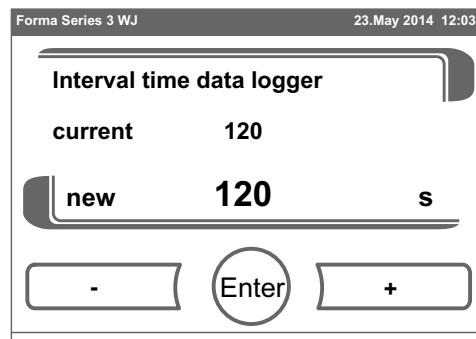

Figure 2-25. Recording Interval

Date	Time	Process	002/223
21.05.14	15.06	New error RH	
21.05.14	15.06	New error T	
21.05.14	15.06	New error T	
21.05.14	15.06	New error CO2	
21.05.14	15.06	Power reset	
21.05.14	15.06	New error RH	
21.05.14	15.06	New error T	
21.05.14	15.06	New error T	
21.05.14	15.06	New error CO2	
21.05.14	15.06	Power reset	
21.05.14	15.06	New error SYSTEM	

At the bottom of the table, there are three buttons: "Previous", a circular "End" button, and "Continue".

Figure 2-26. Error Table



## Section 3 Calibration

After the unit has stabilized, several different systems can be calibrated. The air temperature, CO<sub>2</sub> reading, O<sub>2</sub> reading, and RH reading can all be calibrated to reference instruments. To calibrate, press the corresponding number on the display, then "Calibrate".

Calibration frequency is dependent on use, ambient conditions, and accuracy required. Good laboratory practice would require at least an annual calibration check. On new installations, all parameters should be checked after the stabilization period. When using O<sub>2</sub> controls, all parameters should be checked before each test experiment, or at least every 6 months.

Before making an calibration or adjustments to the unit, it is imperative that all reference instruments be properly calibrated.

### Calibrating the Temperature

Place the calibrated instrument in the center of the chamber. The instrument should be in the airflow, not against the shelf. Before calibration, allow the cabinet temperature to stabilize.

## Temperature Stabilization Periods

Start-Up - Allow 12 hours for the temperature in the cabinet to stabilize before proceeding.

Operating Unit - Allow at least two hours after the display reaches setpoint for the temperature to stabilize before proceeding.

Press Temperature (T) window on the display. Then press "Calibration" button on the display.

1. To increase the offset:

> Press the + key.

2. To reduce the offset:

> Press the - key.

3. The value change appears in the display.

4. Press the ENTER key.

5. To accept and save the change:

> Press the SAVE key.

> The system returns to the main display.

## Calibrating T/C CO<sub>2</sub> System

Models 4110, 4111, 4130 and 4131 have a thermal conductivity (T/C) CO<sub>2</sub> sensor. Thermal conductivity of the incubator atmosphere is not only affected by the quantity of CO<sub>2</sub> present, but also by the air temperature and the water vapor present in the incubator atmosphere. In monitoring the effects of CO<sub>2</sub>, air temperature and absolute humidity must be held constant so any change in thermal conductivity is caused only by a change in CO<sub>2</sub> concentration.

Changing temperature or changing from elevated humidity levels to room ambient humidity levels would necessitate a recalibration of the CO<sub>2</sub> control.

Some T/C CO<sub>2</sub> sensors go through an aging period, especially on new installations. Calibration should be checked on a weekly basis, and adjusted as necessary. When stabilization occurs, checks can become less frequent.

## T/C CO<sub>2</sub> Sensor Stabilization Times

Start-up - The CO<sub>2</sub> sensor has been calibrated at the factory for 37°C.

Allow temperature, humidity, and CO<sub>2</sub> levels in the chamber to stabilize at least 12 hours before checking the CO<sub>2</sub> concentration with an independent instrument.

Presently operating - Make sure the chamber doors are closed. Allow at least 2 hours after the temperature and CO<sub>2</sub> displays reach their setpoints for chamber atmosphere stabilization.

1. Make sure stabilization periods outlined above are followed.
2. Sample the chamber atmosphere through the sample port with an independent instrument. Sample the atmosphere at least 3 times to ensure the accuracy of the instrument.
3. Press CO<sub>2</sub> window on the display.
4. Press "Calibration" button on the display.
5. To increase the offset:
  - > Press the + key.
6. To reduce the offset:
  - > Press the - key.
7. The value change appears in the display.
8. Press the ENTER key.
9. To accept and save the change:
  - > Press the SAVE key.
  - > The system returns to the main display.

**Caution** Do not leave the measurement device attached to the sample port for more than 5 minutes. The humidity levels will be affected. Do not calibrate if cleaning agent vapors may be present. Ensure all vapors have been dissipated prior to calibration. ▲

## Calibrating Infra-red (IR) CO<sub>2</sub> System

Models 4120, 4121, 4140 and 4141 have an infra-red (IR) CO<sub>2</sub> sensor. IR CO<sub>2</sub> sensors are not affected by chamber atmosphere temperature or humidity. However, the light detector in the sensor is affected by wide temperature changes. Therefore, changing temperature setpoints could necessitate a recalibration of the CO<sub>2</sub>. Chamber temperature should be allowed to stabilize before checking CO<sub>2</sub> concentrations with an independent instrument, especially on start-up.

## IR CO<sub>2</sub> Sensor Stabilization Times

Startup - Allow the temperature and the CO<sub>2</sub> of the cabinet to stabilize at least 12 hours before proceeding.

Operating Unit - Allow CO<sub>2</sub> to stabilize at least 2 hours at setpoint before proceeding.

To ensure accurate calibration, do not calibrate below 1%. If the cabinet does not contain at least 3% CO<sub>2</sub>, increase the setpoint and allow the unit to stabilize before completing this procedure.

1. Sample the chamber atmosphere through the sample port with an independent instrument. Sample the atmosphere at least 3 times to ensure the accuracy of the instrument.
2. Press CO<sub>2</sub> window on the display.
3. Press "Calibration" button on the display.
4. To increase the offset:
  - > Press the + key.
5. To reduce the offset:
  - > Press the - key.
6. The value change appears in the display.
7. Press the ENTER key.
8. To accept and save the change:
  - > Press the SAVE key.
  - > The system returns to the main display.

## Calibrating the O<sub>2</sub> System

Some models have an O<sub>2</sub> control sensor (see Page i). The sensor is a fuel cell that puts out a linear millivolt signal based on O<sub>2</sub> content of the chamber. The fuel cell depletes over time depending on required O<sub>2</sub> levels, therefore the system should be calibrated before each test experiment, if a difference of more than 1°C is entered when setting temp set value, when the device is restarted after an extended interruption of operation, when a new sensor, main board is installed, or adding or removing a water pan.

There are two methods available to calibrate the O<sub>2</sub> system.

- Preferred method calibrates the system to the known ambient O<sub>2</sub> value of 21% and checks the life of the sensor by performing the Auto-Start routine. This method should be used whenever a new sensor is installed.
- Second method available (after performing the Auto-Start routine) allows the system to be calibrated to an independent reference instrument by entering an offset.

## O<sub>2</sub> Calibration at 21%

Open the unit's outer and inner doors and wait at least 5 minutes, then close both doors. Then run the Auto-Start routine per Section 2.

**Note** Upon completion of the Auto-Start routine, the displayed O<sub>2</sub> value may decrease as a result of humidity displacing some oxygen. ▲

## O<sub>2</sub> Offset Calibration

Startup - Allow the cabinet to stabilize at least 12 hours before proceeding.

Operating Unit - Allow O<sub>2</sub> to stabilize at least 2 hours at set point before proceeding.

**Caution** If using an O<sub>2</sub> Fyrite, the accuracy of the instrument will be greatly affected by the concentration of CO<sub>2</sub> in the cabinet. Refer to the Fyrite operating manual. ▲

Measure the O<sub>2</sub> concentration in the chamber through the gas sample port with an independent instrument. Take several readings to ensure accuracy.

1. To increase the offset:
  - > Press the + key.
2. To reduce the offset:
  - > Press the - key.
3. The value change appears in the display.
4. Press the ENTER key.
5. To accept and save the change:
  - > Press the SAVE key.
  - > The system returns to the main display.

## Calibrating Relative Humidity

All Model 4100 Series incubators can be equipped with an optional direct readout relative humidity sensor. This is a readout only of the chamber relative humidity. It does not provide any control of the relative humidity in the cabinet. The unit will alarm below 80% to indicate an empty humidity pan.

### Relative Humidity (RH) Stabilization Times

Startup - Allow 12 hours for the relative humidity and temperature in the chamber to stabilize before proceeding.

Operating Unit - Allow at least 2 hours after temperature display reaches setpoint for relative humidity to stabilize before proceeding.

1. Place an accurate independent instrument in the center of the chamber. Allow 2 hours with the door closed for RH to stabilize.
2. To increase the offset:
  - > Press the + key.
3. To reduce the offset:
  - > Press the - key.
4. The value change appears in the display.
5. Press the ENTER key.
6. To accept and save the change:
  - > Press the SAVE key.
  - > The system returns to the main display.

**Note** If room temp water is added to pan, it will take 7-8 hrs to stabilize (calibration purposes). It is recommended to add water at a temperature 1 degree below the unit temperature set point. ▲

If a reliable RH measuring device is not available, the display may be calibrated to a typical level.

1. Follow the RH stabilization periods outlined above.
2. With a full humidity pan and stable temperature, the relative humidity in the chamber will be 95%.
3. Using Steps 3-5 of the relative humidity sensor adjustment above, adjust the display to 95%.
4. This calibration method should be accurate to within 5%.

## Section 4 Configuration

There are many features available that can be configured to allow custom setup of the incubator. These features are listed and described below. All features may not be necessary in all applications, but are available if needed. To configure, press Menu, then Options.

### Turning Audible Alarm Relay ON/OFF

The audible alarm relay can be turned on or off. Factory setting is ON.

1. Press BUZZER
2. To change the state:
  - > Press the + or - key.
3. The value change appears in the display.
4. To accept and save the change:
  - > Press the ENTER key.
  - > The system returns to the OPTIONS display.

### New HEPA Filter

When the REPLACE HEPA reminder is displayed and the visual alarm flashes, the specified time has elapsed and the HEPA filter should be replaced. To clear the display and reset the timer after replacing the HEPA filter with a new one, follow the steps below.

1. Press HEPA
2. Press RESET HEPA
  - > The display beeps. Press END and the system returns to the main display.

## Enabling/Disabling Keypad Lock

The keypad lock prevents the unauthorized changing of the operational settings. Only the keys used to enter values are locked.

The keypad is locked by entering four numbers.

This input dialog box allows the keypad lock to be enabled or disabled. At the factory, the keypad lock is preset to the standard code 0000.

1. Enter the 4-digit code using the keypad. The input appears encrypted in the display [1].

2. To delete complete incorrect input:

> Press the DELETE key [2].

3. To break off the input:

> Press the BACK key [4].

The system returns to the Configuration menu.

4. To confirm the input:

> Press the ENTER key [3].

> The system returns to the Configuration menu.

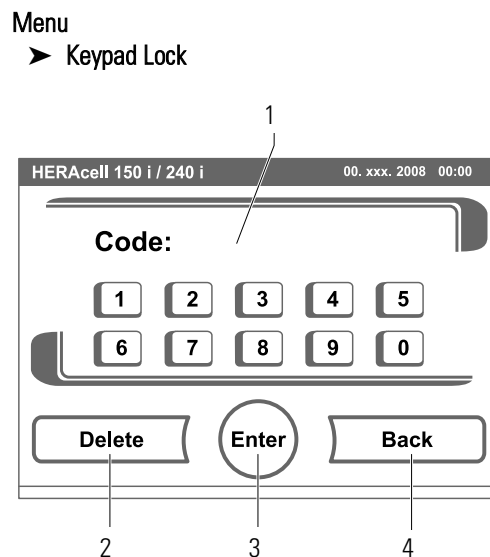

### Changing an existing code:

The currently valid code can be redefined in Changing the Keypad Lock Code in Section 2.

### Resetting the code:

If the keypad lock code is no longer available, the code must be reset to the standard code by Technical Services.

## Selecting a Primary Tank (Gas Guard)

On units equipped with the Gas Guard option, this procedure can be used to manually change tanks if both tanks are full. The primary tank can be either Tank A or Tank B. Factory setting is Tank A.

1. Press the CO<sub>2</sub>/O<sub>2</sub> display.

2. Press to select desired tank.

3. Press END.



## Section 5 Alarms

The Model 4100 Series incubator alarm system is shown in the table below. When an alarm is active, the message appears in the iCAN message center. Touching the screen disables the audible alarm. However, the visual alarm (represented by red outlines) continues until the incubator returns to a normal condition. The alarms are momentary alarms only. When an alarm condition occurs and then returns to normal, the incubator automatically clears the alarm condition.

When multiple alarm conditions occur, active messages are displayed in the message center one at a time, as each one is cleared.

The CO<sub>2</sub> alarms are disabled when the CO<sub>2</sub> setpoint is 0.0%. The O<sub>2</sub> alarms are disabled when the O<sub>2</sub> setpoint is 21.0%.

**Note** When a low water alarm is triggered, the unit's heaters are deactivated to protect them. Water slowly evaporates from the jacket over time. The user is responsible for keeping the water jacket filled to required level. ▲

Section 5  
Alarms

	Description	Message
<b>System</b>	Door open > 10 Min	Device door open too long
	No communication to display	Error display
	Mainboard parameter implausible	Error Eeprom Main Board
	Datalogger Defective (device can still function)	Datalogger defective
	Error during Autostart	Error Autostart- Max Time Exceeded
	Plausibility check failed at reference resistor.	Error ADC
	Low Water	Error Low Water
	<b>Temperature</b>	Sensor/Probe break
Actual value high		Actual value above
Actual value low		Actual value below
Calibrated value too high or low		Calibration Values too high/low
Temperature measuring sensors do not agree		Actual Value Not Plausible

	Description	Message
CO2	Sensor breakage	Sensor defective
	Actual value above	
	Actual value below	
	Calibration values too high, too low (TCD only)	
	Error, communication with sensor (I2C Bus)	
	Actual value not plausible	Use previous value
O2	Sensor Defective	Sensor Breaker
	Actual value above	Actual Value High
	Actual value below	Actual Value Low
	Calibrated value too high/too low	Calibration Value too High /Low
Rh	Sensor defective	Sensor breakage
	Actual value above	Actual Value High
	Actual Value Below	Actual Value Low
	Calibrated value too high/too low	Calibration value Too high/Low

Section 5  
Alarms

	Message	Description
O2	Sensor breakage	Sensor defective
	Actual value above	Actual value high
	Actual value below	Actual value low
	Calibration values too high, too low	Calibrated value too high/too low
		No comm to sensor
rH	Sensor breakage	Sensor defective
	Actual value above	Actual value high
	Actual value below	Actual value low

## Inner Door Open Alarm

When the inner door is opened on a Model 4100 Series incubator, heat and CO<sub>2</sub> injection are disabled. The door must be securely latched for heat and CO<sub>2</sub> injection to resume after a door opening. If the door is latched, yet the display still shows Door Open, the door switch could be faulty. Call Technical Services.

## Sensor Fault Alarms

The microprocessor in the incubator continually scans all available sensors, except the O<sub>2</sub> (see Section 6), to ensure proper operation. Should an error be detected, the incubator sounds an alarm and displays the appropriate message. If such an alarm occurs, contact your local distributor or the Technical Services department.

### O<sub>2</sub> Sensor Breakage

On units equipped with the O<sub>2</sub> system, the microprocessor checks the remaining life of the O<sub>2</sub> sensor whenever O<sub>2</sub> calibration @ 21% is performed. If the O<sub>2</sub> sensor declines to a certain level, O<sub>2</sub> Sensor Breakage appears in the display and the visual alarm flashes. This alarm alerts the user to replace the O<sub>2</sub> sensor at the earliest convenience (Section 6). The unit will continue to function for some length of time.

If the O<sub>2</sub> sensor declines to the point that control cannot be accurately performed, an O<sub>2</sub> Sensor Breakage alarm will sound and control is disabled.

### CO<sub>2</sub> Error Communication

If the cables or connectors between the main microprocessor board and the CO<sub>2</sub> sensor become loose or disconnected, CO<sub>2</sub> Error Communication alarm will occur.

# PREVENTIVE MAINTENANCE

## Incubators

Your equipment has been thoroughly tested and calibrated before shipment. Regular preventive maintenance is important to keep your unit functioning properly. The operator should perform routine cleaning and maintenance on a regular basis. For maximum performance and efficiency, it is recommended the unit be checked and calibrated periodically by a qualified service technician.

The following is a condensed list of preventive maintenance requirements. See the specified section of the operating manual for further details.

We have qualified service technicians, using NIST traceable instruments, available in many areas. For more information on Preventive Maintenance or Extended Warranties, please contact Technical Services.

Cleaning and calibration adjustment intervals are dependent upon use, environmental conditions and accuracy required.

### Tips for all incubators:

- Do NOT use bleach or any disinfectant that has high chlorine content.
- Use water with characteristics as described in Filling Water Jacket.
- Avoid spraying cleaner on the CO<sub>2</sub> sensor.
- Do not use powdered gloves for tissue cultures.

### Preventive Maintenance for Water Jacket Incubators

Action	Daily	Weekly	Monthly	6 Months	Yearly	2 years
Check CO <sub>2</sub> and/or N <sub>2</sub> tank levels (tanks without optional gas guard monitor)	✓					
Inspect the inner and outer door latches and hinges for proper operation and excessive mechanical wear; inspect the line cord insulation and inner door silicone gasket for chips and cracks. Replace as required.					✓	
Check water level in humidity pan, ½" from top. See "Filling the Humidity Pan".		✓				
Check proper blower motor operation (air flow, noise, and vibration)		✓				
Verify and document CO <sub>2</sub> , humidity and temperature calibration, as applicable. See Calibration section.					✓	
Verify O <sub>2</sub> calibration, as applicable. See Calibration section				✓		
Perform a complete decontamination procedure. Wipe down interior, shelves and side ducts with disinfectant. Change or clean blower wheel and scroll. Clean top duct. Clean humidity pan. Rinse everything well with sterile water. See "Cleaning the Interior," "Cleaning the Humidity Pan".	Before first use, after every service call and between experiments to prevent cross contamination <i>More frequent decontamination may be required, depending on use and environmental conditions</i>					
Change HEPA and gas filters, if applicable ( <i>or as needed</i> ). See "Installing Access Port Filter," "Installing Air Sample Filter", "Installing HEPA Filter".				✓		
Replenish rust inhibitor in water jacket. See "Adding/Replenishing Rust Inhibitor".						✓

## Section 6 Routine Maintenance

**Caution** Parts of the instrument are made of plastics. Solvents may attack plastics. Strong acids or alkalis can cause embrittlement of plastics. To clean the plastic parts and surfaces, do not use hydrocarbon solvents, nothing with an alcohol content of more than 10% and no strong acids or bases! ▲

**Caution** The display and the power switch on the side of this unit contain moisture sensitive components! Do not use spray cleaners. When wiping, make sure that no moisture penetrates these components. ▲

**Warning** If the units have been in service, disconnect the power cord connector before disinfecting. ▲

Use an appropriate disinfectant. All articles and surfaces must be thoroughly cleaned, rinsed and rough-dried.

**Warning** Alcohol, even a 70% solution, is volatile and flammable. Use it only in a well ventilated area that is free from open flame. If any component is cleaned with alcohol, do not expose the component to open flame or other possible hazard. Allow the alcohol to fully dry before turning power on. ▲

**Warning** Do not use strong alkaline or caustic agents. Stainless steel is corrosion resistant, not corrosion proof. Do not use solutions of sodium hypochlorite (bleach), as they may also cause pitting and rusting. ▲

**Warning** During periods of non-use, remove the humidity pan to avoid sensor damage. ▲

## Cleaning the Interior

1. Turn the incubator off and disconnect the plug from the power source.
2. Remove the shelves, access port filter and side duct sheets. Remove the temperature sensors and the air sample filter tubing from the back of the blower scroll. If unit is equipped with the optional RH sensor, unfasten it from the clip on the top duct (Figure 6-1).

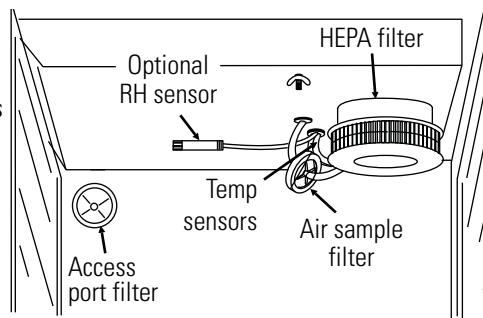

Figure 6-1. Sensor and Filter Locations

3. Remove the filter from the air sample filter tubing. Carefully pull down and remove the HEPA filter.
4. Remove the wingnuts securing the top duct to the interior. Carefully slide the top duct down and off the temperature sensor, air sample filter tubing (and RH sensor, if applicable).
5. Wash the shelves, ducts, wingnuts and stopper with disinfectant and rinse with sterile water. Option: Autoclave shelves, ducts and wingnuts.
6. Remove the blower scroll by first pushing the black lever clip closest to you toward the scroll. Then turn the scroll to the right to disengage it from the blower scroll plate. Some manipulation may be required as the alignment holes are keyhole-shaped.
7. Remove the remaining nut, then pull down on the blower wheel. If a new wheel and scroll are to be used, discard the old ones. If the old ones are to be reused, wash all parts with disinfectant and rinse with sterile water.
8. Remove the blower scroll plate by first pushing the black lever clip toward the chamber ceiling. Then turn the plate to the left to disengage it from the alignment keyholes. Clean as above, or autoclave.
9. Wash the cabinet interior with disinfectant starting at the top and working down. Wash the inner door both inside and out. The cabinet and door must be rinsed with sterile water until the disinfectant has been removed. After the cabinet has been rinsed, spray with 70% alcohol.
10. Reinstall the blower scroll plate by aligning it with the larger end of the keyholes and turning it to the left to lock it on. Pull the black lever clip downward from the ceiling.

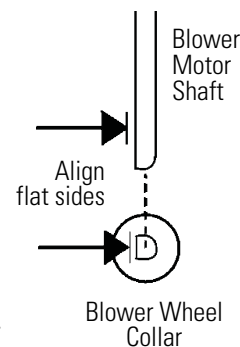

Figure 6-2. Align

11. Install the blower wheel onto the motor shaft, aligning the d-shaped flat sides of each (Figure 6-2). Secure the blower wheel with the nut. Make sure the wheel turns freely.



## Cleaning the Interior (continued)

12. Locate the blower scroll over the blower wheel into the larger end of the keyholes on the scroll plate. Turn the scroll to the right to lock it into the keyholes. Pull the black lever clip closest to you toward the front of the unit.

13. Install the top duct by feeding the temperature sensors, air sample tubing (and RH sensor, if applicable) through the appropriate holes in the duct as it is raised to the top of the chamber. Be careful not to pull the grommets through the duct. See Figure 6-3.

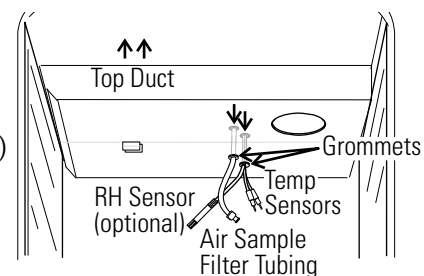

Figure 6-3. Feed Through Holes

14. Locate the mounting studs and blower scroll into the appropriate holes in the top duct and install the wingnuts to secure the duct.
15. Install the air sample filter onto the top duct tubing.
16. Carefully pull the temperature sensors and air sample filter tubing down until they can be inserted approximately 1 inch into the appropriate holes in the back of the blower scroll. If applicable, place the optional RH sensor into the corresponding clip on the top duct. See Figure 6-4.

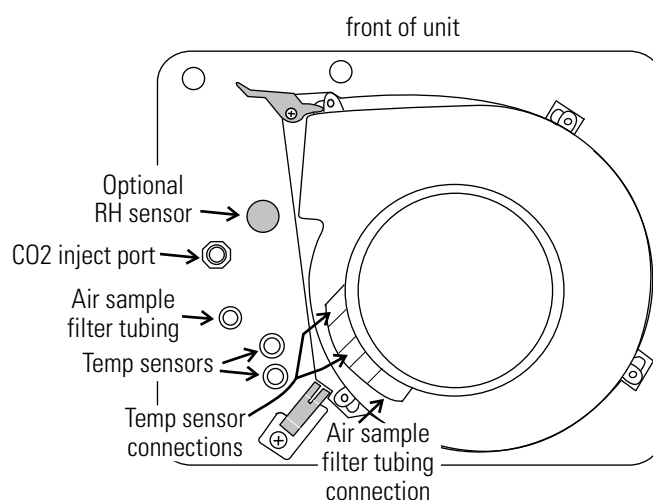

Figure 6-4. Underside View of Chamber Ceiling

17. Install the HEPA Filter.
18. Install the left and right ducts, and the access port stopper with filter, spraying each with 70% alcohol (do not saturate).
19. Install the shelves and spray with 70% alcohol.
20. Plug the incubator in, install a full water pan and turn the power switch on. Allow the unit to run empty for 24 hours before returning to service.

## Cleaning Cabinet Exterior

Clean the incubator exterior with a damp sponge or soft, well-wrung cloth and mild detergent dissolved in water. Dry with a soft cloth.

## Cleaning Humidity Pan

Clean the humidity pan with soap and water and a general use laboratory disinfectant. Rinse with sterile water and spray with 70% alcohol. The humidity pan may be autoclaved.

## Reversing the Door Swing

For side-by-side operation or changing lab layouts, the inner and outer doors are field-reversible. The procedure is written from the prospective of changing the door swing from a left-hand to a right-hand swing. All screw holes are pre-drilled for reversing the door. The tools required are a Phillips and a flatblade screwdriver.

**Warning** If the units have been in service, disconnect the power cord connector before reversing the door swing. ▲

## Reversing Hinges for Exterior Door

1. Open the exterior door.
2. Remove the screws securing the cover plate below the control drawer and remove the plate. One is indicated in Figure 6-5. The other is on the opposite side of the plate.
3. Find the cable to the interior heated glass door. It is secured on the left side to the bracket that holds the vent port.
4. Remove the screw securing the cable to the bracket (Figure 6-6). Remove the clamp from the cable.



Figure 6-5. Screw Location



Figure 6-6. Screw Location

## Reversing Hinges for Exterior Door (continued)

5. Unplug the cable on the top of the inner door by sliding the black sleeve up on the yellow connector on the top of the door. Refer to Figure 6-7.

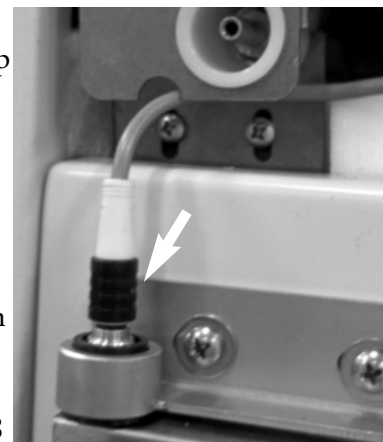

Figure 6-7. Yellow Sleeve

6. Remove the screws securing the top pan on the upper portion of the exterior door. Five of the eight screws are behind the upper gasket. See Figure 6-8 and 6-9.

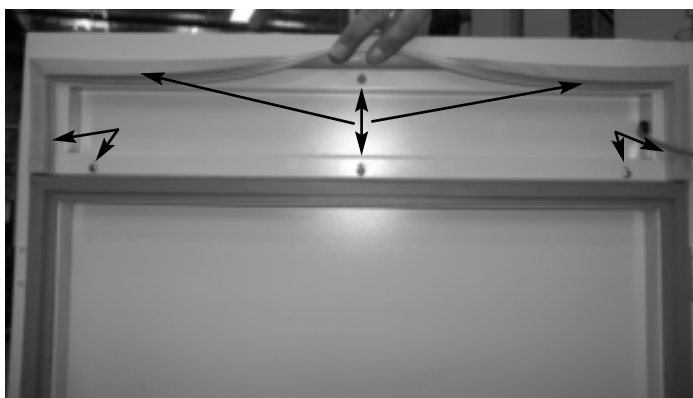

Figure 6-8. Hidden Screws



Figure 6-9. Hidden Screws

7. Hold the pan and release the tie wraps inside the top of the door (Figure 6-10).

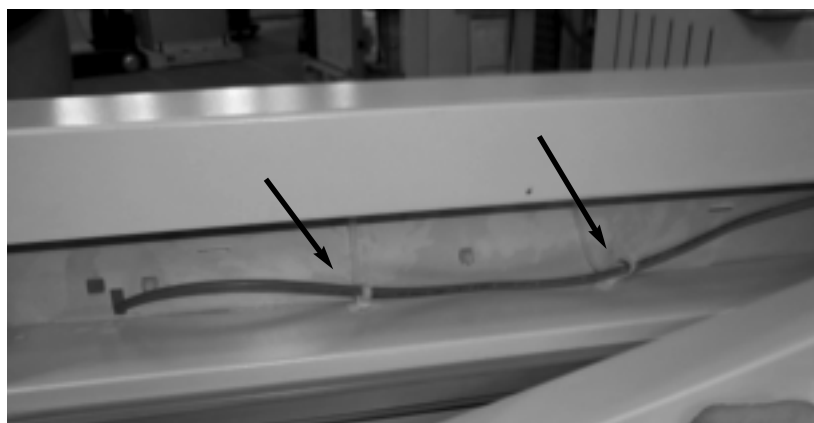

Figure 6-10. Release Tie Wraps

## Reversing Hinges for Exterior Door (continued)

10. Lift the door off the hinges. Set door and pan in front of cabinet (Figure 6-11).
11. Remove the plastic screws from the door and cabinet on the opposite side of the incubator from the hinges. Upper screws are shown in Figure 6-12.



Figure 6-11. Set Door and Pan Aside



Figure 6-12. Plastic Screws

12. Remove the hinges and door handle from door and the side of the cabinet (Figure 6-13) and move to the opposite side where the plastic screws were removed.

13. Install the plastic screws in the previous hinge locations.



Figure 6-13. Remove Hinges, Display Frame

## Reversing Hinges for Exterior Door (continued)

14. Carefully move the wire from left to right side of the cabinet and rotate the top pan at the same time. See Figure 6-14.
15. Install the door on the hinges.
16. Secure the display cable in the tie wrap anchors, inside the top of the door (see arrows in Figure 6-14).



Figure 6-14. Move Wires To Right Side

17. Install the top pan and gasket into the door (Figure 6-15).



Figure 6-15. Install Top Pan & Gasket

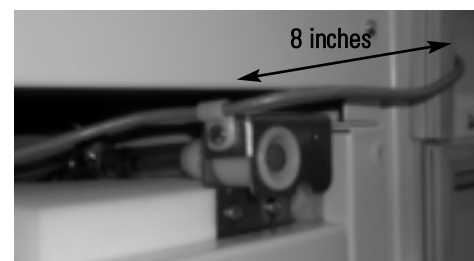

Figure 6-16. Measure 8 inches

18. Measure 8 inches on the door cable from the Heyco connector in the top pan. Scribe. Refer to Figure 6-16 for the next three steps.
19. Fit the clamp over the cable and fasten it loosely to the fill port bracket on the right side.
20. Slide the cable until it aligns with the mark on the cable. Tighten.
21. Open the exterior door wide (180°) and make sure the cable does not bind. Close the door and verify that the cable stays in the opening in the top of the door.

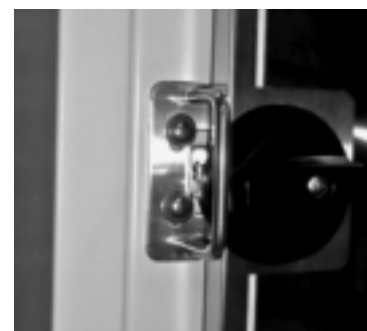

Figure 6-17. Inner Door Latch

## Reversing Hinges for Interior Door

1. Open the inner door and remove inner door latch from cabinet (Figure 6-17).

## Reversing Hinges for Interior Door (continued)

2. Remove the inner door top hinge (Figure 6-18) and lift the inner door off of the bottom hinge and set it aside being very careful not to damage the connectors on the top & bottom of the door.
3. Remove the bottom hinge (Figure 6-19).



Figure 6-19. Bottom Inner Door Hinge

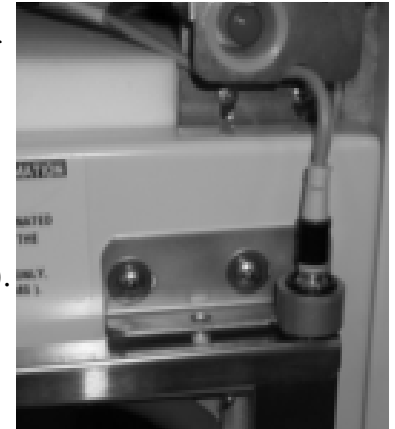

Figure 6-18. Top Inner Door Hinge

4. Remove the plastic screws from the appropriate holes on the right side and reinstall them in the latch and hinge holes where you just removed the latch and hinges.
5. Install the bottom hinge in the correct position on the left side.
6. Orient the inner door properly and position it in the bottom hinge.
7. Install the top hinge.
8. Install the inner door latch on the right side, Adjust to make sure the tab in the latch is making contact.
9. Position the cover plate under the component drawer. Be careful of the cables. Make sure they fit into their slots.
10. Connect the cable on the top of the inner door by sliding the black sleeve up on the yellow connector on the top of the door. Refer to Figure 6-18.
11. Assemble the outer door to the incubator and return the unit to service.

## Replacing Fuses

**Warning** The electronics drawer contains hazardous voltages. Replacing the fuses should be performed by qualified personnel only. ▲

There are three fuses in the incubator that can be replaced. To replace a fuse:

1. Turn off the incubator's power switch.
2. Unplug the power cord from the wall outlet.
3. Open the exterior cabinet door.
4. Remove four screws as shown. See Figure 6-20.

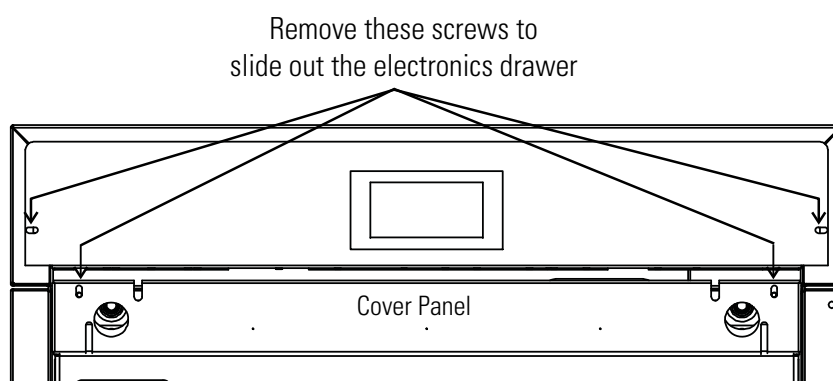

Figure 6-20. Screw Locations

5. Remove the cover panel and carefully slide out electronics drawer.

Refer to Figure 6-21. There are three fuses in the electronics drawer, and two on the main board. Remove the fuse and replace it with a new one of the same specification. Refer to Table 6-1.

Table 6-1. Fuses and Specifications

Fuse #	Manufacturer Part #	Amperage Rating	Rupture Speed	IEC Letter Code
F1	BUSS GMC-3.5A	3.5 Amp	Time-Lag	T
F2	BUSS GMC-2.5A	2.5 Amp	Time-Lag	T
F3, F4	SCHURTER 001.2515	12.5 Amp	Time-Lag	T
115 VAC ACC	BUSS GMC-1.0A	1.0 Amp	Time-Lag	T
230 VAC ACC	BUSS BK-GMC-500mA	0.5 Amp	Time-Lag	T

## Replacing Fuses (continued)

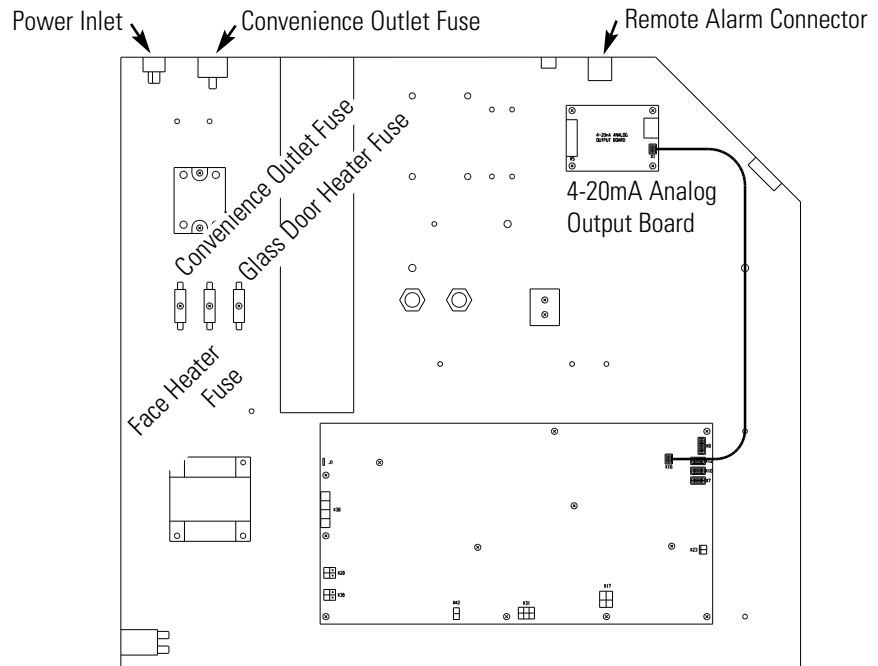

Figure 6-21. Electronics Drawer Component Locations

1. When the fuse has been replaced, slide the electronics drawer back in, being very careful to place the door heater cable and display cable back into the provided slot so that the drawer does not pinch the cables.
2. Re-install the cover panel.
3. Replace the four screws removed earlier.
4. Close the exterior door.
5. Plug the power cord back into the dedicated, grounded circuit.
6. Turn on power switch. If the unit operates properly, it may now be returned to service.

## HEPA Filter Maintenance

Replace the HEPA filter when the REPLACE HEPA reminder is displayed. The REPLACE HEPA reminder can be set to alarm after a specified time from 1 to 365 days. The reminder default is the factory recommended setting of 365 days. For details, see Section 1.

## Replacing Air Sample Filter

The air sample filter should be replaced whenever the HEPA filter is replaced. On the inside of the chamber, inserted into the back of the blower scroll, is the air sample filter and its connecting tubing. Disengage the tubing from the back of the scroll, remove the filter from the tubing and discard. Install the new filter. Connect it securely to the air sample filter tubing, then insert the tubing into the back of the blower scroll.



## Replacing Access Port Filter

The access port filter should be replaced whenever the HEPA filter is changed. The filter is connected to the stopper in the upper left corner of the chamber back wall. Remove the filter from the connecting tube and discard. Install the new filter.

## Draining Water Jacket

1. Turn the unit off. Remove the plug from the power source.
2. Remove the front cover plate below the door. There are small flatblade screwdriver pry slots on each end of the plate to help remove it. See Figure 6-21.

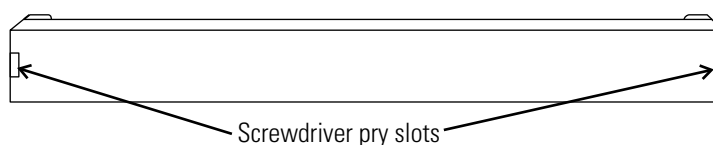

Figure 6-21. Front Cover Plate Below the Door

3. If present, remove the drain plug.
4. Connect the hose barb insert to the drain on lower front of the water jacket and to the drain hose.

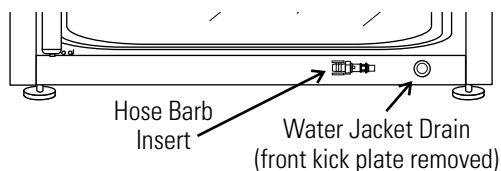

Figure 6-22. Water Jacket Drain and Hose Barb Insert

5. After water jacket has finished draining, remove the hose barb insert and secure on the front of the unit. See Figures 6-22 and 6-23.



Figure 6-23. Hose Barb Insert

6. Install cover plate.
7. To fill the water jacket, see Section 1. Be sure to add the rust inhibitor to the water when filling. For the proportions of rust inhibitor to water and the part number, see the end of this section.

## O<sub>2</sub> Sensor Fuel Cell Models 4140/ 4141

The O<sub>2</sub> sensor output declines over time, even if the unit is not in use. Replace the sensor every 30 months to ensure consistent output and to prevent the possibility of failure in the middle of a test experiment.

## Replacing O<sub>2</sub> Sensor Models 4140/ 4141

The O<sub>2</sub> sensor is located on the blower scroll plate in the chamber of the unit. To replace it, see Figures 6-24 and 6-25, and follow the steps below.

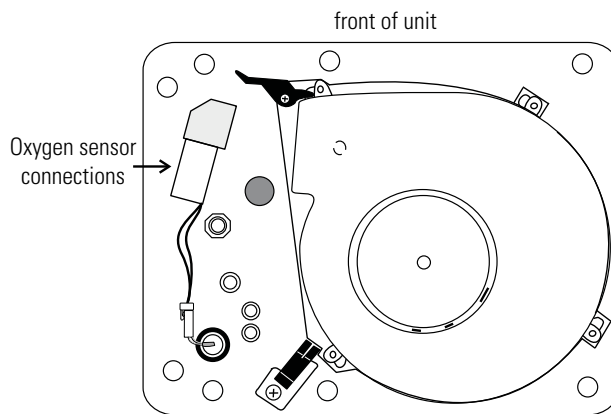

Figure 6-24. Underside View of Top of Chamber

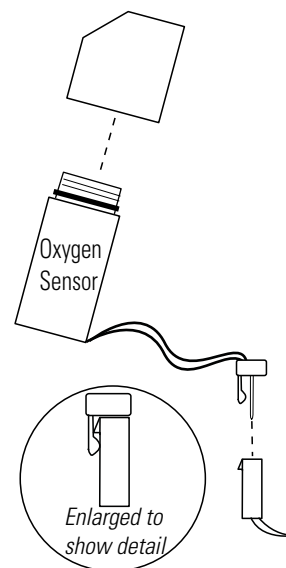

Figure 6-25. Detail

**Caution** Make sure that the sensor is plugged in correctly. If not, incorrect calibrations could occur during the Auto-Start routine. For a functional check, the sensor should be switched On according to Section 2. If no alarm occurs after 10 minutes, the unit can be put into operation by performing the Auto-Start routine. ▲

1. Turn the unit off and disconnect the plug from the power source.
2. Remove the top duct by removing 2 wingnuts.
3. Locate the sensor on the scroll plate.
4. Lift up slightly on the tab securing the sensor wire terminal connection. Be careful not to break the tab off. Refer to enlarged detail of Figure 6-25.
5. Disconnect the terminals from each other. Note the orientation of the terminals.
6. The O<sub>2</sub> sensor is screwed into the brass fitting. Unscrew the old sensor and discard.

## Replacing O<sub>2</sub> Sensor (continued)

7. Screw the new sensor in firmly. Be careful not to cross-thread.
8. Orient the terminals as previously and connect.
9. Install the top duct and tighten the 2 wingnuts.
10. Plug the unit in. Calibrate the O<sub>2</sub> system using the Auto-Start method as described in Section 2.
11. Allow the unit to run until the temperature stabilizes (minimum of 2 hours). Check the O<sub>2</sub> and CO<sub>2</sub> operation and return the unit to service.

## Adding /Replenishing Rust Inhibitor

The Model 4100 Series incubators are shipped from the factory with a rust inhibitor added to the water in the jacket. This inhibitor must be replenished every 2 years. Mix 1 bag/bottle of the rust inhibitor with a gallon of distilled or de-mineralized water. Drain a gallon of water from the jacket and replace it with the rust inhibitor mixture.

Rust Inhibitor (0.5 lb.) bag	1900100
------------------------------	---------

Rust Inhibitor (800ml) bottle (use in units with a cooling coil)	1900101
---	---------

## Section 7 Factory Installed Options

### Humidity Readout

The 4100 Series incubators can be equipped with a humidity sensor to monitor the relative humidity (RH) inside the chamber. The sensor is mounted to the top air duct and provides a signal that is displayed in 1% increments on the display. A low alarm limit is factory set at 80%, to detect when the humidity pan runs dry.

#### Factors Affecting Humidity Level in Chamber:

- Water level in the humidity pan
- Frequency of door openings
- Humidity pan location; floor, shelf, in duct, center or left
- Air leakage through the gaskets
- Gas sample port capped
- Humidity levels in O<sub>2</sub> units (Models 4130/4131, 4140/4141) will be reduced, depending on the amount of N<sub>2</sub> required to control the O<sub>2</sub> level in the chamber.

The following table lists some typical RH levels at different CO<sub>2</sub> percentages.

**Table 7-1.** Typical RH levels

O <sub>2</sub> %	CO <sub>2</sub> %	RH% (±5%)
1%	2.5%	55%
2%	5%	60%
5%	10%	75%
10%	10%	80%
21%	5%	95%

The sensor is capable of measuring relative humidity from 10% to 100% with an accuracy of ±5% above 90%. See Section 3 Calibration for details on calibrating the humidity readout.

## Cooling Coil

**Note** For customer convenience, 12 ft. of 3/8" I.D. vinyl tubing with 4 clamps is included in the shipping materials. ▲

The operating (setpoint) temperature range of the incubator with the cooling coil installed is from +5°C above ambient down to +15°C.

The cooling coil incubator incorporates a finned, U-shaped copper pipe installed within the water jacket. This pipe routes chilled water supplied by a laboratory bath. (Be aware that your bath may not be set to restart after a power failure. Read the manufacturer's operating instructions.)

Verify that the supply line pressure does not exceed 20 psig (138KPa).

When the cooling coil is in use, several factors affect the uniformity inside the incubator chamber: the temperature difference between the operating temperature set point and the bath water temperature; the flow rate of the chilled water, and the on-time percentage of the door heaters.

As determined in carefully controlled laboratory tests, the smaller the difference between the temperature of the bath and the setpoint temperature of the incubator, the better the uniformity. However, decreasing this temperature difference does cause less control of the system because if the bath does not cool the water jacket adequately, the heaters do not cycle and the chamber temperature simply drifts with the ambient temperature of the room.

Tests have shown that as a starting point, operating the bath at 2°C to 3°C below the incubator's operating setpoint temperature, with a cooling water flow rate of 1/2 to 1 GPM (gallons per minute), should result in good control and uniformity.

Because of the efficiency of the cooling coil design, it is possible for condensation to occur on the outside of the incubator's water jacket when operating in certain ambient temperature and relative humidity conditions. The condensation will then saturate the fiberglass insulation between the water jacket and the incubator cabinet.

## Cooling Coil (continued)

Using psychometric data from the Carrier Psychometric Chart, curves of maximum allowable RH versus ambient temperature can be plotted for different incubator/bath conditions (refer to Figure 7-1).

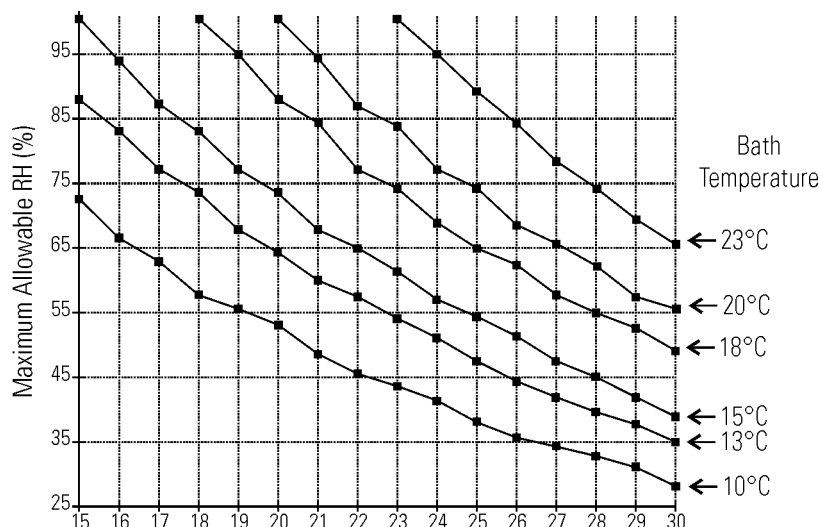

Figure 7-1. RH Limits to Avoid Water Jacket Condensation

For example, if the bath is to be operated at 15°C and the ambient temperature is about 28°C, the RH in the room must be less than 45% to avoid condensation forming between the chamber water jacket and the outside of the cabinet.

## Installing Cooling Coil Incubator

Hose barbs are factory installed into the fittings on the back of the cabinet, as shown below. They can be used as the water inlet or outlet to the bath. Locate the vinyl tubing and hose clamps shipped inside the incubator. Cut the tubing in half. The bath can be located up to six feet from the incubator.

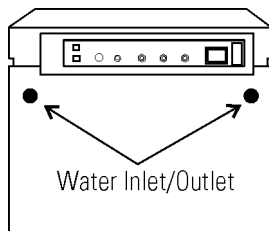

Figure 7-2. Back of Unit

## Remote Alarm Contacts



A set of relay contacts are provided to monitor alarms through an RJ-11/ RJ-12 telephone style connector on the back of the cabinet. Refer to Figure 1-11 for the location of the alarm connector.

The remote alarm provides a NO (normally open) output, a NC (normally closed) output and COM (common). Refer to Figure 7-3.

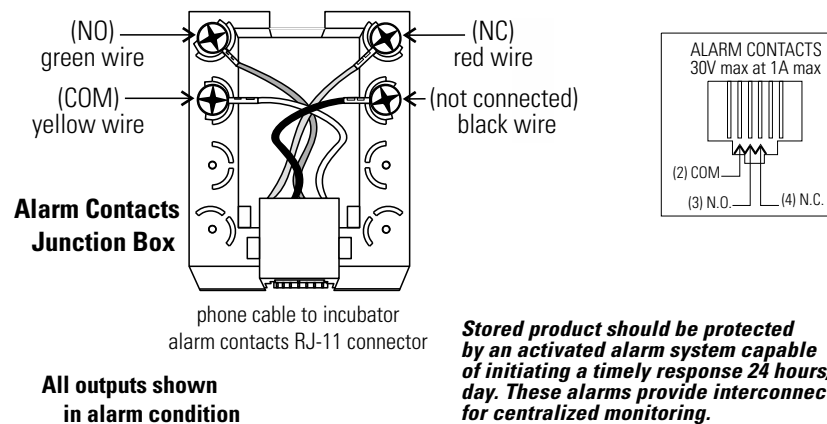

Figure 7-3. Contacts

The contacts will trip on a power outage or an over temperature condition. The contacts may also be programmed to trip or not trip on temperature alarms, CO<sub>2</sub> alarms, O<sub>2</sub> alarms, and RH alarms. See Alarms section.

## Connecting Analog Output Boards

**Warning** The electronics drawer contains hazardous voltages. Opening the drawer and/or wiring in an analog board should be performed by qualified personnel only. ▲

The analog output board option allows the incubator to output analog signals representing the air temperature of the cabinet, the CO<sub>2</sub> content, the O<sub>2</sub> content, and the relative humidity, depending upon which systems are in the incubator. The analog output board outputs 4-20mA signals. The outputs do not have an isolated ground.

**Table 7-2.** Analog Output Board Specifications

4-20mA Output Scaling 4-20mA Equals		
Temp	0.08mA/°C	0 - 200°C
rH	0.16mA/%	0 - 100% RH
CO <sub>2</sub>	0.8mA/%	0 - 20% CO <sub>2</sub>
O <sub>2</sub>	0.16mA/%	0 - 100% O <sub>2</sub>

The interface is confirmed to DIN IEC381 Part 1 (1985). Analog signals for process control systems; direct current signals. For the 4-20mA board, the recorder must supply a load of  $\leq 3$  ohm.

To wire in the analog output board, a 22-gauge, 3-conductor wire with a shield (Part # 73041) is recommended, maximum length 50 ft (15.2m). This is readily available from other vendors including Alpha Part #2403, and Belden Part # 8771.

**Warning** Accuracy of the output at the board terminal strip to the incubator display for the temperature channel is  $\pm 0.5^\circ\text{C}$ , for the CO<sub>2</sub> channel  $\pm 0.1\%$ , for the rH and O<sub>2</sub> channels  $\pm 0.3\%$ . There is no calibration from the incubator. Calibration to the incubator display must be at the instrument connected to the output board. ▲



## Connecting Analog Output Boards (cont.)

1. Turn off the incubator's power switch and unplug the power cord from the wall outlet.
2. Open the exterior cabinet door and remove the four screws shown in Figure 7-4.

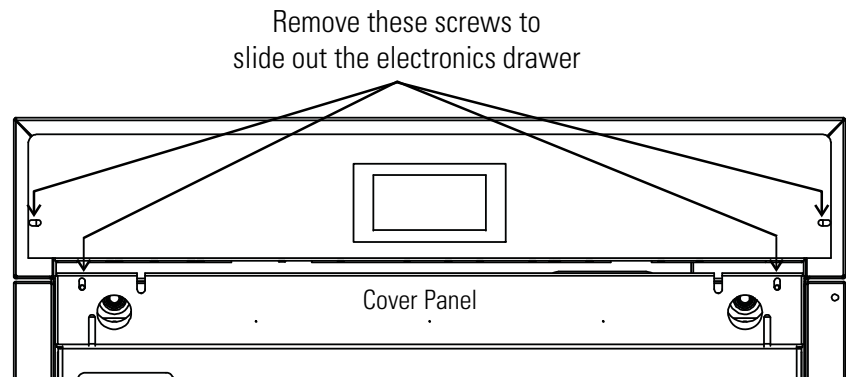

Figure 7-4. Screw Locations

3. Remove the cover panel and carefully slide out electronics drawer and locate the Analog Output board (Figure 7-5).
4. Each system monitored (Temp, CO<sub>2</sub>, O<sub>2</sub>, RH) requires two conductors. Feed the wire through the analog wiring inlet on the back of the drawer.
5. Strip the ends of each conductor and wire to the appropriate terminals of connector X5 on the analog board (Figure 7-5).

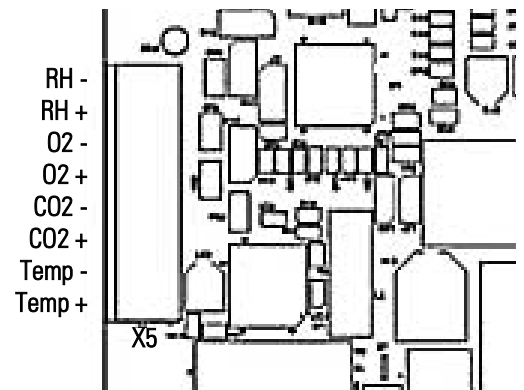

Figure 7-5. Analog Output Board

6. When wiring is completed, slide the electronics drawer back in being very careful to place the door heater cable back into the provided slot so that the drawer does not pinch the cable. See Figure 7-4.
7. Re-install cover panel.
8. Replace the four screws removed earlier and return the unit to service.

## Gas Guard for CO<sub>2</sub>/N<sub>2</sub>

The Model 4100 Series incubators can be equipped with a built-in gas guard system that will operate with either a CO<sub>2</sub> or a N<sub>2</sub> gas supply. Only one gas guard can be installed on each unit. The gas guard uses two pressure switches to continuously monitor the pressures of two independent CO<sub>2</sub> or N<sub>2</sub> supplies and automatically switches from one supply to the other when the supply pressure drops below 10 psig (0.690 bar). The gas guard is not designed to be used with multiple incubators.

Both of the CO<sub>2</sub> or the N<sub>2</sub> gas supplies must be equipped with two-stage pressure regulators. The high pressure gauge at the tank should have a 0-2000 psig range and the low pressure gauge should have a 0-30 psig range. The gas supply to the incubator must be maintained at 15 psig (1.034 bar), ±5 psig. Gas pressures below 15 psig (1.034 bar) will cause nuisance alarms to occur on incubators equipped with the built-in Gas Guard.

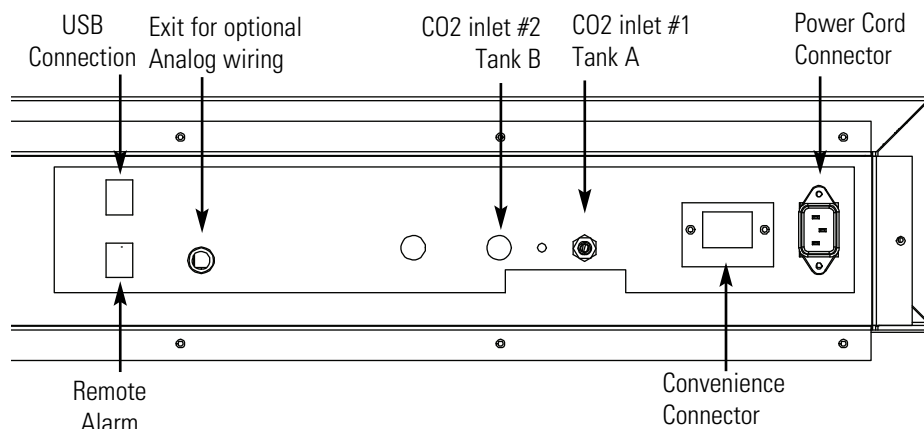

Figure 7-6. Unit Back with All Connections

## Connecting CO<sub>2</sub> Gas Supplies

The CO<sub>2</sub> inlets for a built-in gas guard are located on the rear of the electronics drawer (see Figure 7-6). Using 1/4" ID tubing, connect one of the CO<sub>2</sub> supply tanks to the fitting labeled CO<sub>2</sub> Inlet #1 Tank A. Connect the second CO<sub>2</sub> supply tank to the fitting labeled CO<sub>2</sub> Inlet #2 Tank B. Install 3/8" hose clamps to secure the 1/4" ID tubing to the fittings on the rear of the drawer.

## Connecting N<sub>2</sub> Gas Supplies

The N<sub>2</sub> inlets for a built-in gas guard are located on the rear of the electronics drawer (see Figure 7-6). Using 1/4" ID tubing, connect one of the N<sub>2</sub> supply tanks to the fitting labeled N<sub>2</sub> Inlet #1 Tank A. Connect the second N<sub>2</sub> supply tank to the fitting labeled N<sub>2</sub> Inlet #2 Tank B. Install 3/8" hose clamps to secure the 1/4" ID tubing to the fittings on the rear of the drawer.

## Gas Guard Operation

With the Gas Guard in operation, the incubator will use the gas supplied through CO<sub>2</sub> (or N<sub>2</sub>) Inlet #1 Tank A until the pressure drops below approximately 10 psig. At this time, the Gas Guard automatically switches to the gas supplied through CO<sub>2</sub> (or N<sub>2</sub>) Inlet #2 Tank B.

In addition, the incubator automatically changes the highlighted tank on the display from A to B to indicate that the incubator is now using gas supplied through CO<sub>2</sub> (or N<sub>2</sub>) Inlet # 2 Tank B. If the gas supply to CO<sub>2</sub> (or N<sub>2</sub>) Inlet #1 Tank A is replenished, the incubator will continue to operate using the gas supplied through CO<sub>2</sub> (or N<sub>2</sub>) Inlet #2 Tank B unless the operator changes the Tank Select from 2 to 1 (B to A) through the CO<sub>2</sub> or O<sub>2</sub> display detail window.

Audible and visual alarms occur on the control panel when the gas guard switches from one supply to the other. The audible alarm will sound until the operator touches the display. A visual alarm on the display will read Tank A (or B) Empty while the audible alarm is sounding, but will be removed after the operator touches the display.

If the gas guard does not detect an adequate gas supply at the CO<sub>2</sub> (or N<sub>2</sub>) Inlet #1 Tank A or CO<sub>2</sub> (or N<sub>2</sub>) Inlet #2 Tank B, a visual and audible alarm will again occur on the display. The visual alarm on the display will read Tank A Empty, Tank B Empty. The audible alarm will continue to ring until the operator touches the display.

## Section 8 Specifications

*\*Specifications are based on nominal voltages of 115V or 230V in ambients of 22°C to 25°C.*

### Temperature

Control	±0.1°C
Range	+5°C above ambient to +55°C (131°F)
Uniformity	±0.2°C @ +37°C, truncated
Tracking Alarm	Services programmable high/low

### Temperature Safety

Setability	0.1°C
------------	-------

### CO<sub>2</sub>/O<sub>2</sub>

CO <sub>2</sub> /O <sub>2</sub> Control	±0.1%
CO <sub>2</sub> Range	0-20%
O <sub>2</sub> Overshoot	±0.2%
O <sub>2</sub> Range	1-20%
Inlet Pressure	15 PSIG (1.034 bars), ±5 PSIG
CO <sub>2</sub> Sensor	IR or T/C
O <sub>2</sub> Sensor	Fuel Cell
Readability	0.1%
Setability	0.1%
Tracking Alarm	Service programmable

### Humidity

RH	Ambient to 95% @ +37°C (98.6°F)
Humidity Pan	0.8 gal. (3 liters) standard
Optional	Display in 1% increments

### Fittings

Fill Port	3/8" (0.95 cm) barbed
Drain Port	1/4" (0.64 cm) barbed
Access Port	1-1/4" (3.18cm) removable neoprene plug
CO <sub>2</sub> Inlet	1/4" (0.64 cm) hose barbed

### Unit Heat Load

115V/230V 344 BTUH (100 Watt)

### Shelves

Dimensions 18.5" x 18.5" (47.0cm x 47.0cm)  
Construction Stainless steel, perforated, electropolished  
Surface area 2.4 sq. ft. (0.22 sq. m) per shelf  
Max. per Chamber 38.4 sq.ft. 3.6 sq. m)  
Loading 35 lbs (16kg) slide in and out,  
50 lbs (23kg) stationary  
Standard 4  
Maximum 16

### Construction

Water Jacket Volume 11.7 gal. (43.5 liters)  
Interior Volume 6.5 cu. ft. (184.1 liters)  
Interior Type 304, mirror finish, stainless steel  
Exterior 18 gauge, cold rolled steel, powder coated  
Outer Door Gasket Four-sided, molded magnetic vinyl  
Inner Door Gasket Removable, cleanable, feather-edged, silicone

### Electrical

115V Models 115VAC,  $\pm 10\%$ , 50/60 Hz, 1 PH, 3.6 FLA  
230V Models 230VAC,  $\pm 10\%$ , 50/60 Hz, 1 PH, 2.0 FLA  
Circuit Breaker/Power Switch 6 Amp/2 Pole  
Convenience Receptacle 75 Watts max. (one per chamber)  
Data Outputs USB, 4-20mA (optional)  
Installation Category Overvoltage Category II  
Pollution Degree 2  
Maximum Leakage Current With ground disconnected, 0.65mA  
Maximum permissible leakage, 3.5mA

### Dimensions

Interior 21.3" W x 26.8" H x 20.0" F-B  
(54.1cm x 68.1cm x 50.8cm)  
Exterior 26.3" W x 39.5" H x 25.0" F-B  
(66.8cm x 100.3cm x 63.5cm)

### Weight (per unit)

Net 265 lb. (120.2 kg)  
Net Operational 365 lb. (165.6 kg)  
Shipping 324 lb. (147.0 kg)

### Safety Specifications

Indoor Use Only

Altitude 2000 meters

Temperature 5°C to 40°C

Humidity 80% RH at or below 31°C, decreasing linearly to  
50% RH at 40°C

Mains Supply Fluctuations Operating Voltage Range

Installation Category 2<sup>1</sup>

Pollution Degree 2<sup>2</sup>

Class of Equipment

---

<sup>1</sup> Installation category (overvoltage category) defines the level of transient overvoltage which the instrument is designed to withstand safely. It depends on the nature of the electricity supply and its overvoltage protection means. For example, in CAT II which is the category used for instruments in installations supplied from a supply comparable to public mains such as hospital and research laboratories and most industrial laboratories, the expected transient overvoltage is 2500V for a 230V supply and 1500V for a 120V supply.

---

<sup>2</sup> Pollution Degree describes the amount of conductive pollution present in the operating environment. Pollution Degree 2 assumes that normally only non-conductive pollution such as dust occurs with the exception of occasional conductivity caused by condensation.

# Unit Attachment Location

## Single Units

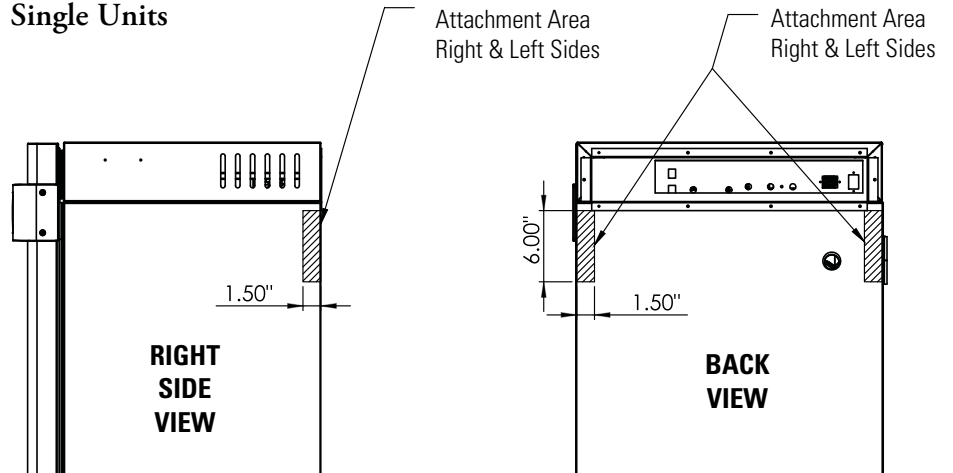

**Caution** Do not drill deeper than 1/2 inch.  
Exterior wrap is 18 ga. cold rolled steel. ▲

## Stacked Units

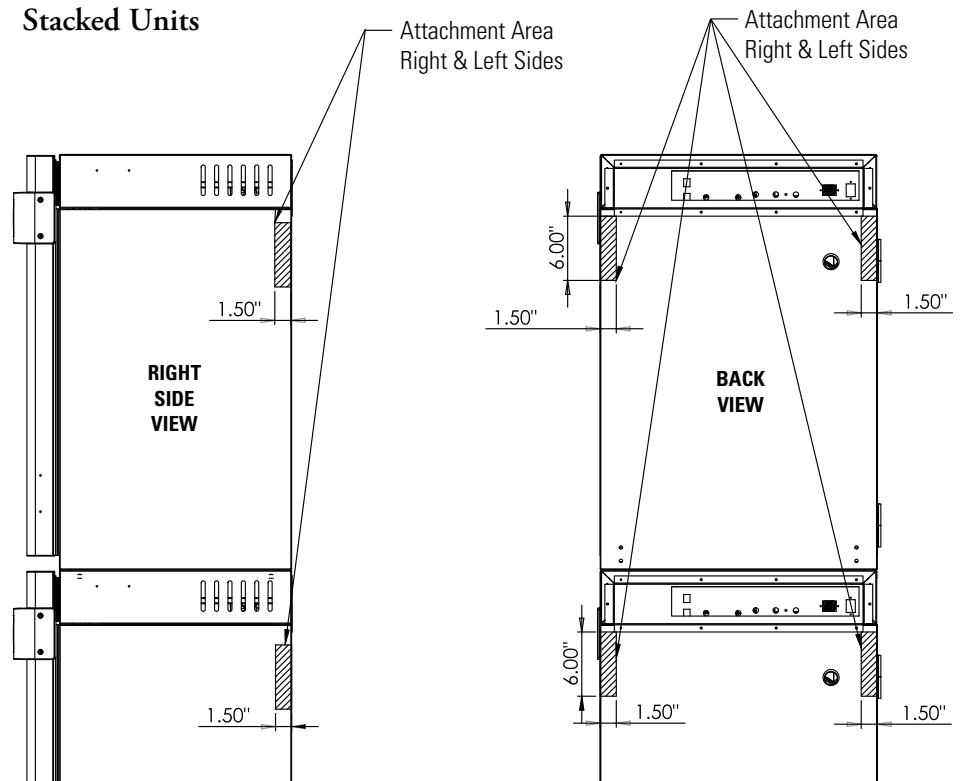

# Unit Center of Gravity Locations

Single Units

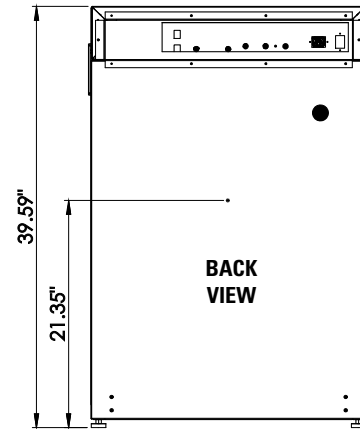
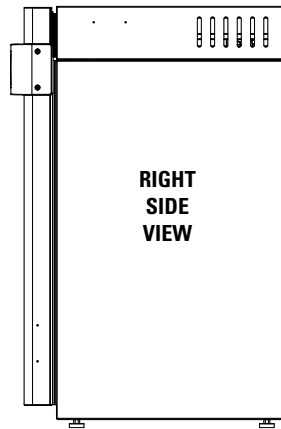
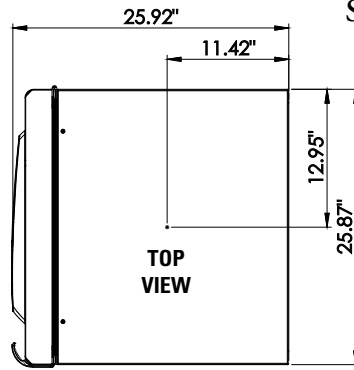



# Unit Center of Gravity Locations (cont.)

## Stacked Units

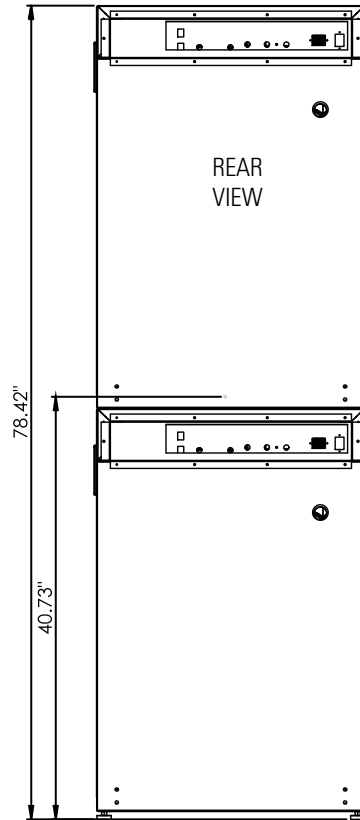
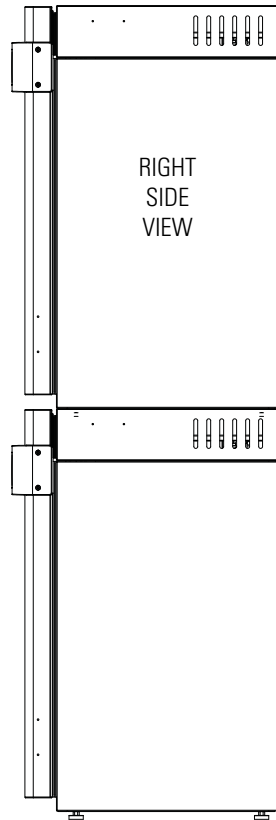
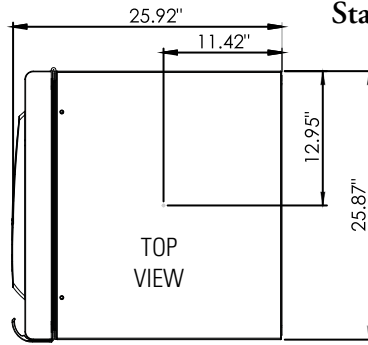

## Section 9 Spare Parts

All Models	Part #	Description
	360171	Liquid Level Switch
	191534	Feather Gasket
	113002	5/16-18 Glide Foot
	132046	115/230V Dual Heater
	132049	Face Heater 40W, 24VAC
	1900203	Heated Inner Door
	190619	Left Inner Door Hinge
	190618	Right Inner Door Hinge
	700013	0.500" Flanged Nylon Bearing
	990026	Door Gasket w/ Magnet
	290214	Temp Probe 100 Ohm
	192070	Micro Board
	192071	Display Board Assembly
	230153	6A Circuit Breaker/Switch
	460212	Line Filter/Power Inlet
	420096	130VA Transformer, Int'l, 14/28V S
	230135	1 AMP Fuse for 115V Outlet
	230159	3.5 Amp Fuse - glass door heater
	230158	2.5 Amp Fuse - face heater
	230241	12.5 Amp Fuse - main board
	250087	Solenoid Valve Kit w/assorted fittings
	1900071	Blower Motor Replacement Kit
	100113	Blower Wheel 3.5x1.5 CCW
	190846	Blower Scroll Assembly
	103072	Blower Plate Gasket
	290215	CO <sub>2</sub> Sensor Assembly
	103074	CO <sub>2</sub> Sensor Plate Gasket
	130097	#6 Silicone Stopper w/ 3/8" Hole
	180001	Polypropylene Funnel
	430108	Line Cord Set
	110084	Drain Plug

<b>All Models (continued)</b>	<b>Part #</b>	<b>Description</b>
	770001	Bacterial Air Filter (CO <sub>2</sub> line, air, sample and access port)
	760175	HEPA Filter
	760199	HEPA2 VOC Filter Accessory Kit (760200 HEPA <sup>2</sup> , 117036 silicone plug, 101018 O-ring)
	1900067	Filter Replacement Kit ([2] 770001 filter and 760175 HEPA)
	1900094	HEPA2 VOC Filter Replacement Kit (760200 HEPA <sup>2</sup> , 190985 access port filter, 770001 filter)
	190566	Inner Door Heater Cable
	1900535	Exterior Door Assembly SRO
<b>230V Models</b>	420097	43VA Transformer, INT. SRS
	460138	Power Outlet, Snap-In Receptacle
	230120	1/2 AMP Fuse for 230 V outlet
<b>IR or O<sub>2</sub> Option</b>	290217	IR Sensor
	770001	Filter
	250118	Valve, Sol, O <sub>2</sub> , 12VDC, 4W
	290083	O <sub>2</sub> Sensor Fuel Cell
<b>Stacking Adapter Kit</b>	190657	Stacking Adapter Kit
<b>Humidity Readout</b>	290154	RH Sensor Assembly, 1 ft.
<b>Data Output Options</b>	73041	24 Ga. 3 Conductor, Analog Output Wire
<b>Gas Guard</b>	250121	Solenoid Valve, 3-way, 12VDC
	360213	Pressure Switch
	192081	Control Board

Section 5  
Section title

ITEM NO.	PART NO.	DESCRIPTION	QTY.
1	19603	EXTERIOR WRAP LAYOUT	1
2	19681	HINGE PIN	2
3	19682	HINGE BLOCK	4
4	55006	8-32 X 3/8 NYLON SCREW	8
5	890535-16-1	NAUTICA W/ EXT. DOOR	1
6	Z053	8-32 X 1/2 SS SCREW	8
7	990028	EXTERIOR DOOR GASKET	1
8	19680	EXTERIOR WRAP BASE	1
9	11302	GLIDE W/OUT 9/16-18 X 2	4
10	24702	PANEL MOUNT COUPLING	1
11	19692	BASE COVER	1
12	186375	NAUTICA EXT. DOOR HANDLE	1
13	186374	NAUTICA CONT. PANEL BEZEL	1
14	990051	GASKET 3.800 X 24.375	1
15	192071	W/ I CAN CONTROL PANEL	1
16	247013	HOSE BARB INSERT	1
17	125044	3/16 HIGH EXPANSION NUT	4
18	121009	LATCH PLASTIC SNAP-IN	2
19	88013	#8X1/2 SS RHP TYPE B SCREW	2

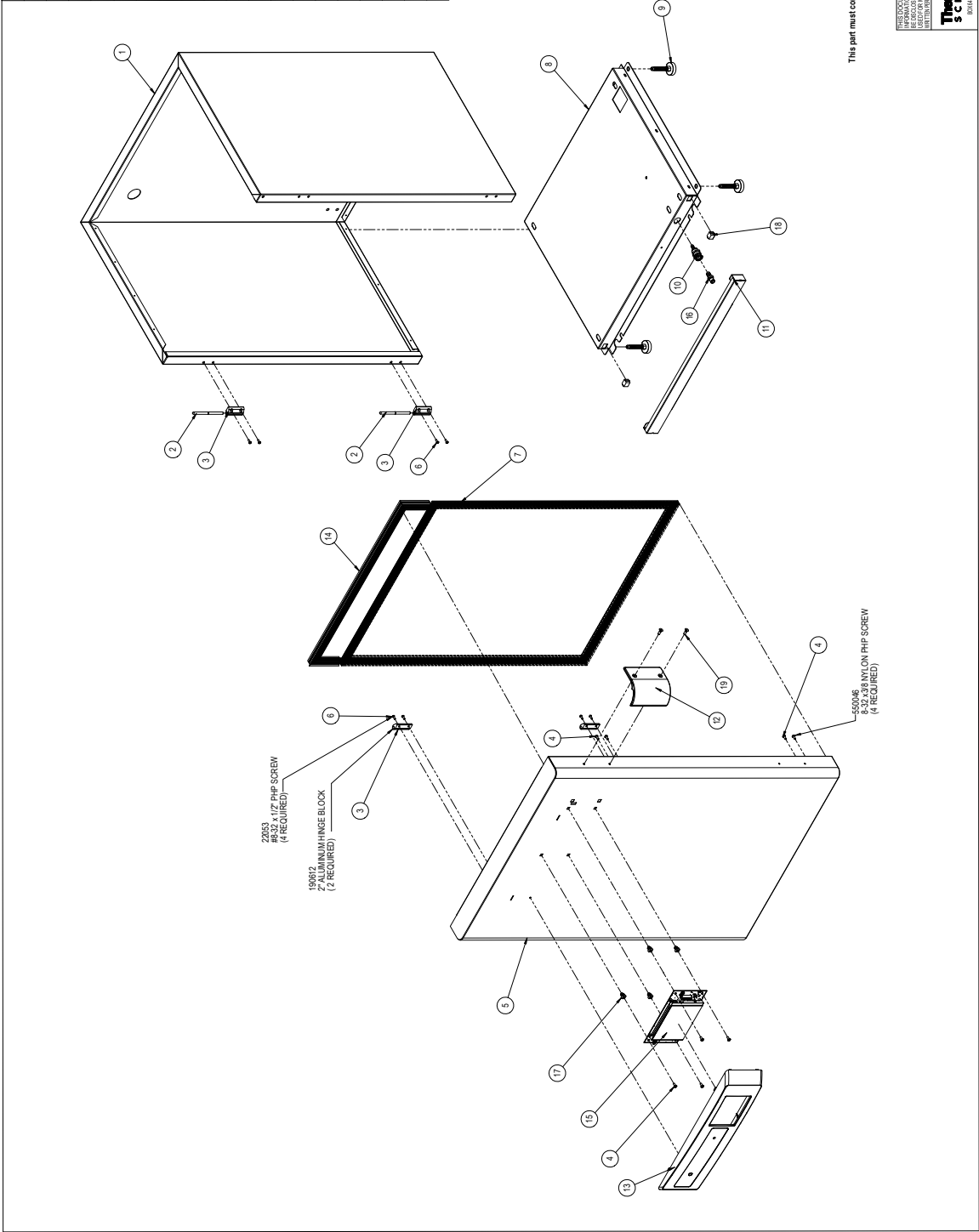

This part must comply with the Environmental Compliance Specification IFS Drawing 260111-00-0A.

REV.	DATE	BY	LOAD	APP'D	DESCRIPTION OF REVISION
THIS DRAWING IS THE PROPERTY OF THERMO SCIENTIFIC. IT IS TO BE USED ONLY FOR THE PURPOSES SPECIFIED HEREIN. IT IS NOT TO BE REPRODUCED OR TRANSMITTED IN ANY FORM OR BY ANY MEANS, ELECTRONIC OR MECHANICAL, INCLUDING PHOTOCOPYING, RECORDING, OR BY ANY INFORMATION STORAGE AND RETRIEVAL SYSTEM, WITHOUT THE WRITTEN PERMISSION OF THERMO SCIENTIFIC.					
<b>Thermo Scientific</b> SCIENTIFIC SCIENTIFIC SCIENTIFIC					
MATERIAL: NA		PART COLOR: NA		FINISH: NA	
TOLERANCES UNLESS SPECIFIED		DIMENSIONS UNLESS SPECIFIED		DRAWING NUMBER: 4110-202-1	
MATERIAL: NA		PART COLOR: NA		FINISH: NA	
TOLERANCES UNLESS SPECIFIED		DIMENSIONS UNLESS SPECIFIED		DRAWING NUMBER: 4110-202-1	

DCS IR SENSOR ASSEMBLY

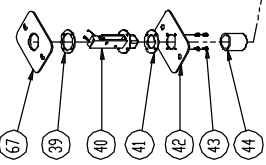

TC O2 SENSOR ASSEMBLY

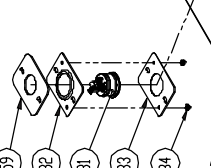

NOTE: SENSOR OPTIONS ARE INSTALLED FROM THE INTERIOR, THROUGH THE TOP OF THE CHAMBER

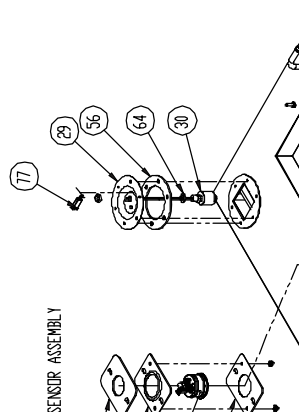
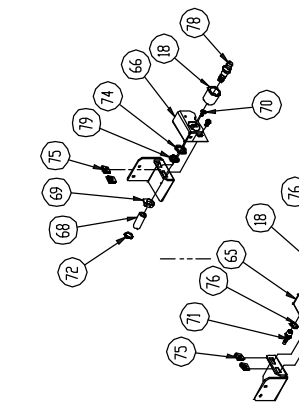
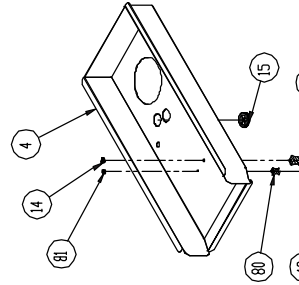
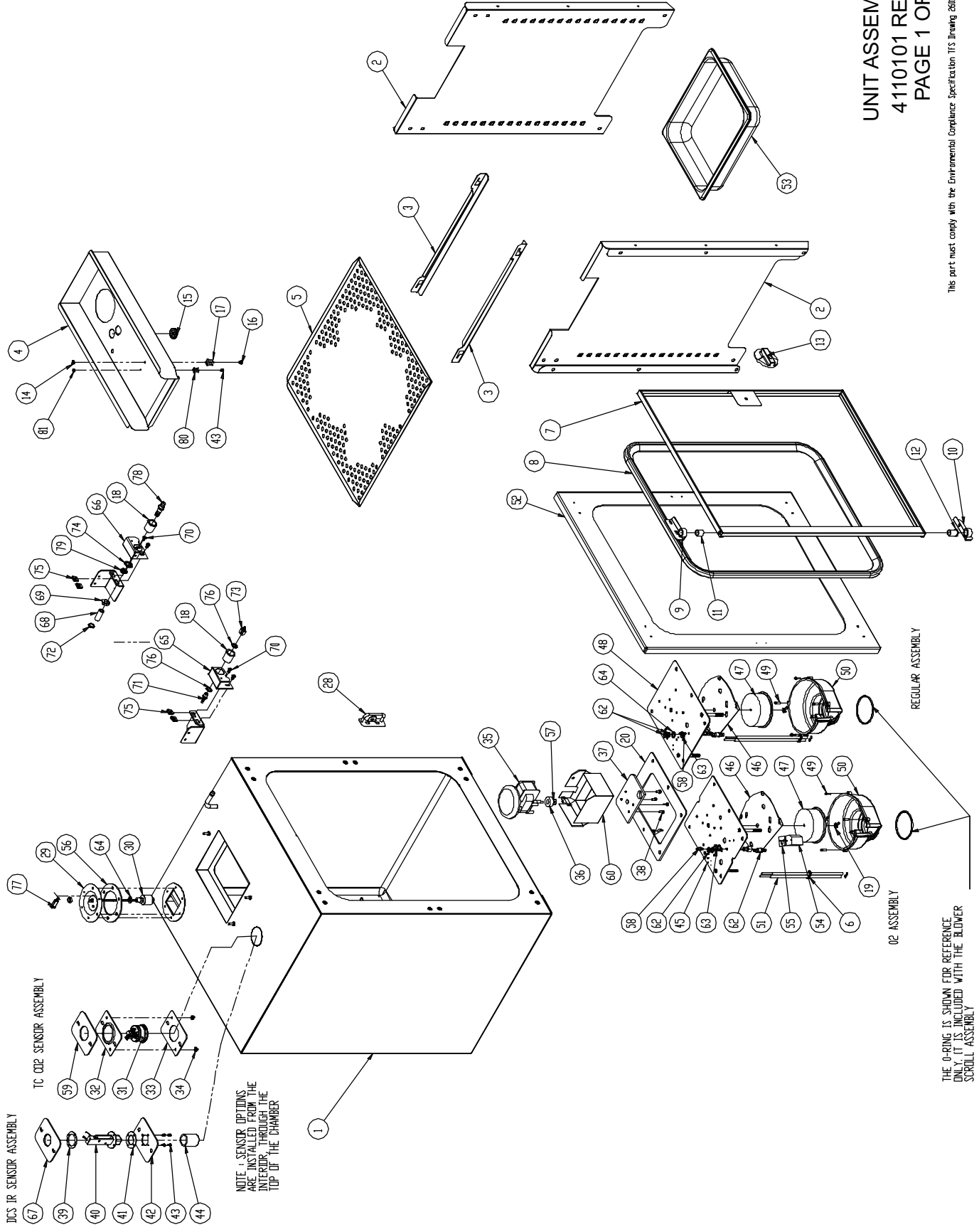

This part must comply with the Environmental Compliance Specification ITS Drawing 2001F-00-P-4.

02 ASSEMBLY  
REGULAR ASSEMBLY

THE O-RING IS SHOWN FOR REFERENCE ONLY. IT IS INCLUDED WITH THE BLOWER SCROLL ASSEMBLY

ITEM NO.	PART NO.	DESCRIPTION	QTY.
1	190600	WATER JACKET CHAMBER	1
2	190723	INTERIOR DUCT SHEETS	2
3	190664	SHELF CHANNELS	2
4	1900056	TOP DUCT (1900057 COPPER)	1
5	224175	SHELF	1
6	114021	.250" ID SILICONE GROMMET	4
7	1900203	INNER GLASS DOOR	1
8	103008	REMOVABLE FEATHER GASKET	1
9	190618	TOP INNER DOOR HINGE	1
10	190619	BOTTOM INNER DOOR HINGE	1
11	700013	.500 FLGD NYLON BEARING	1
12	700046	.500 FLGD X 1 L NYLN BRG	1
13	180210	MOLDED KNOB BLK ACETAL	1
14	23000	8-32 SS NUT	1
15	114022	15/16 BLIND GROMMET	1
16	22051	8-32 x 1/4 SS SCREW	1
17	111007	13/32 RH PROBE CLIP	1
18	190294	FILL PORT ACCESS	2
19	23052	#10-32 SS WING NUT	2
20	103072	SILICONE BLOWER PLATE GASKET	1
21	590051	#4-40 X 3/16 SS PHP SCREW	4
22	840044	#10-32 FEMALE HEX BRASS CONNECTOR	2
23	59007	#4-40 X 3/8 SS PHP SCREW	4
24	115028	NYLON LEVER, BLACK	4
25	350006	#10-32 X 1/8" BRASS BARBED HOSE FITTING	2
26	840009	#10-32 BRASS L-FITTING BRASS	2
27	117029	1/2" DIA. WHITE HOLE PLUG	2
28	190634	INNER DOOR LATCH	1
29	190306	FLOAT SWITCH MOUNT	1
30	360071	FLOAT SWITCH	1
31	290215	TC C02 SENSOR 4010	1
32	190576-31-1	TC SENSOR PLATE	1
33	190577-31-1	TC SENSOR PLATE	1
34	23016	8-32 SS CAP NUT	2
35	15626	MOTOR	1
36	730069	SILICONE WASHER	1
37	190655	MOTOR SPACER	1
38	590023	#8-32 X 3/4 SS PHP SEAL SCREW	4
39	190712-31-1	DCS IR SENSOR MTING. RING	1
40	290217	'DCS' IR SENSOR	1
41	103083-00-0	DCS IR SENSOR GASKET 1/16"	1

ITEM NO.	PART NO.	DESCRIPTION	QTY.
42	190711-31-1	DCS IR SENSOR MNTG. PLATE	1
43	22130	4-40X1/4 SS PHP SCREW	5
44	290217	IR SENSOR FILTER	1
45	1900055	CL 100 BLOWER PLATE 02	1
46	190024	INJECTION MOLDED SCROLL PLATE, CLASS 100	2
47	100113	3.500 X 1.500 BLOWER WHEEL POLY	2
48	1900053	CL 100 BLOWER PLATE AIR STD.	1
49	22134	FILLISTER HD SCREW #6-32 X 1/2"	8
50	190846	BLOWER SCROLL - RESTRICTED, 310/3110	2
51	290184	PROBE ASSEMBLY	4
52	180174	PVC FACE FRAME	1
53	237016	HUMIDITY PAN	1
54	1900058	FUEL CELL BLOCK	1
55	100064	CELL BLOCK GASKET	1
56	103032	FLOAT SWITCH GASKET	1
57	730068	.310 ID TEFLON FLAT WASHER	1
58	840008	5/32 TUBING ADAPTER	2
59	103074	SENSOR PLATE SEAL	1
60	1900249	MOTOR SHIELD & GUARD	1
61	23007	#10-32 SS HEX NUT	2
62	840020	.250 BULKHEAD FITTING	2
63	730017	3/8 BLACK FIBRE WASHER	2
64	730031	NEOPRENE WASHER	3
65	1900542-31-1	SAMPLE PORT W/J TOP COVER MOUNT	1
66	1900543-31-1	FILL PORT W/J TOP COVER MOUNT	1
67	103084-00-0	DCS IR SENSORPLT GKT 3X4	1
68	246011	VINYL TUBING 3/8 ID	1
69	600065	5/8 SNAPPER HOSE CLAMP	1
70	22052	8-32 X 3/8 SS PHP SCREW	4
71	840035	1/8MP TX 3/16HOSE BR5 ADAPT	1
72	950317	#1 SS HOSE CLAMP .22-.625	1
73	840065	1/4HOSEX 1/8FPT BR5 ADAPT	1
74	290128	1/2 SS INT TOOTH LK WASH	1
75	610055	8-32 CLIP NUT	4
76	730060	SS WASH.416 X.628 X.030	2
77	370472	CAP 2 PIS MINI MAT-N-LOK	1
78	840043	3/8 ID HOSE BULKHEAD CONN	1
79	840043	NUT (3/8 ID HOSE BULKHEAD CONN )	1
80	111022	1/4" PROBE CLIP	1
81	23005	4-40 SS NUT	1

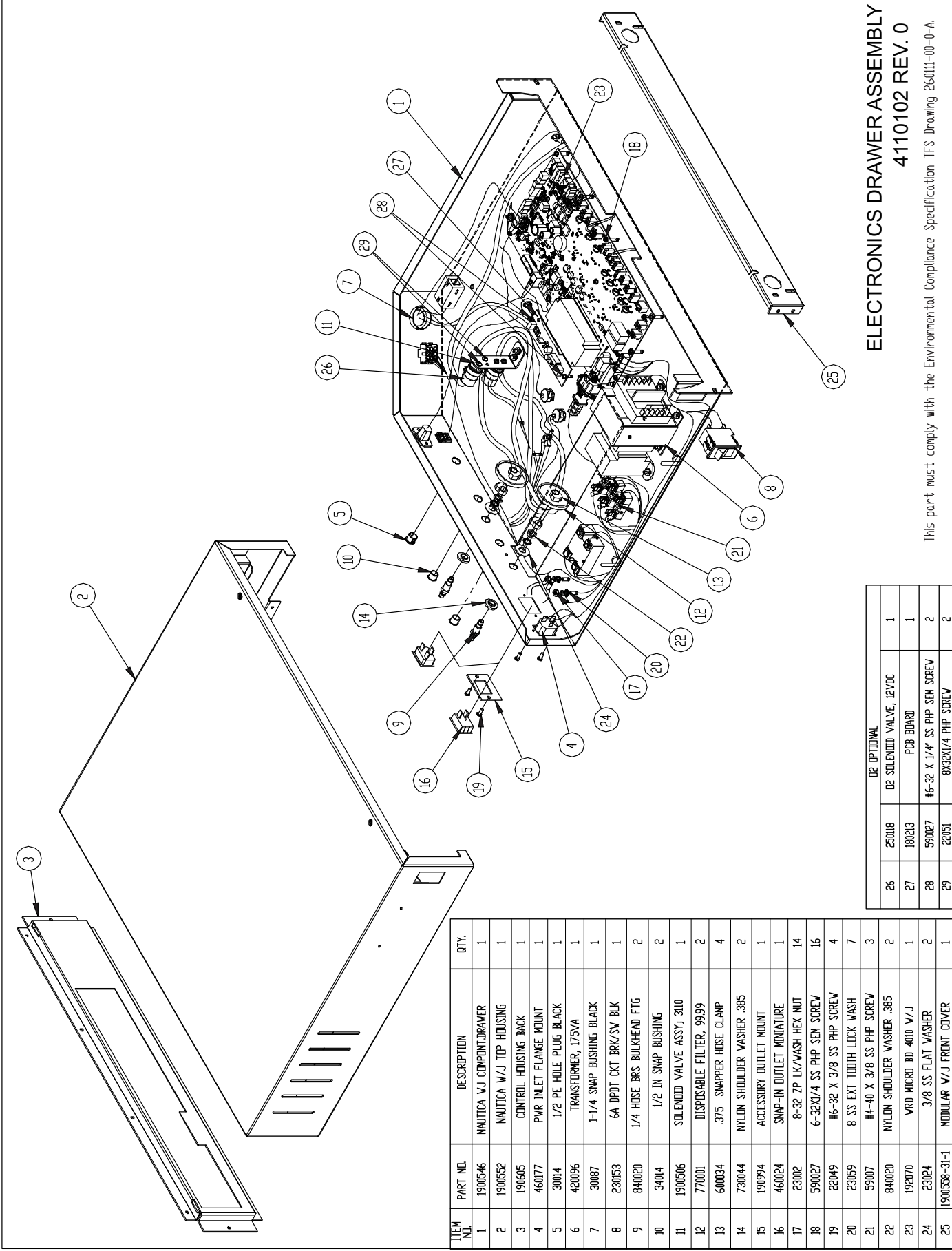

**ELECTRONICS DRAWER ASSEMBLY**  
**4110102 REV. 0**

This part must comply with the Environmental Compliance Specification TFS Drawing 260111-00-0-A.

ITEM NO.	PART NO.	DESCRIPTION	QTY.
1	1900546	NAUTICA V/J COMPONENT DRAWER	1
2	1900552	NAUTICA W/J TOP HOUSING	1
3	190605	CONTROL HOUSING BACK	1
4	46017	PWR INLET FLANGE MOUNT	1
5	30014	1/2 PE HOLE PLUG BLACK	1
6	420096	TRANSFORMER, 175VA	1
7	30087	1-1/4 SNAP BUSHING BLACK	1
8	230053	6A DPDT CKT BRK/SW BLK	1
9	840020	1/4 HOSE BRK BULKHEAD FTG	2
10	34014	1/2 IN SNAP BUSHING	2
11	1900506	SOLENOID VALVE ASSY, 310	1
12	770001	DISPOSABLE FILTER, 99.99	2
13	600034	.375 SWAPPER HOSE CLAMP	4
14	730044	NYLON SHOULDER WASHER .385	2
15	190994	ACCESSORY OUTLET MOUNT	1
16	460024	SNAP-IN OUTLET MINIATURE	1
17	23002	8-32 ZP LK/WASH HEX NUT	14
18	590027	6-32X1/4 SS PHP SEM SCREW	16
19	22049	#6-32 X 3/8 SS PHP SCREW	4
20	23059	8 SS EXT TOOTH LOCK WASH	7
21	59007	#4-40 X 3/8 SS PHP SCREW	3
22	840020	NYLON SHOULDER WASHER .385	2
23	192070	WRD MICRO BD 4010 W/J	1
24	23024	3/8 SS FLAT WASHER	2
25	1900558-31-1	MODULAR V/J FRONT COVER	1

102 OPTIONAL	
26	250018 102 SOLENOID VALVE, 12VDC
27	180213 PCB BOARD
28	590027 #6-32 X 1/4" SS PHP SEM SCREW
29	22051 8X32X1/4 PHP SCREW

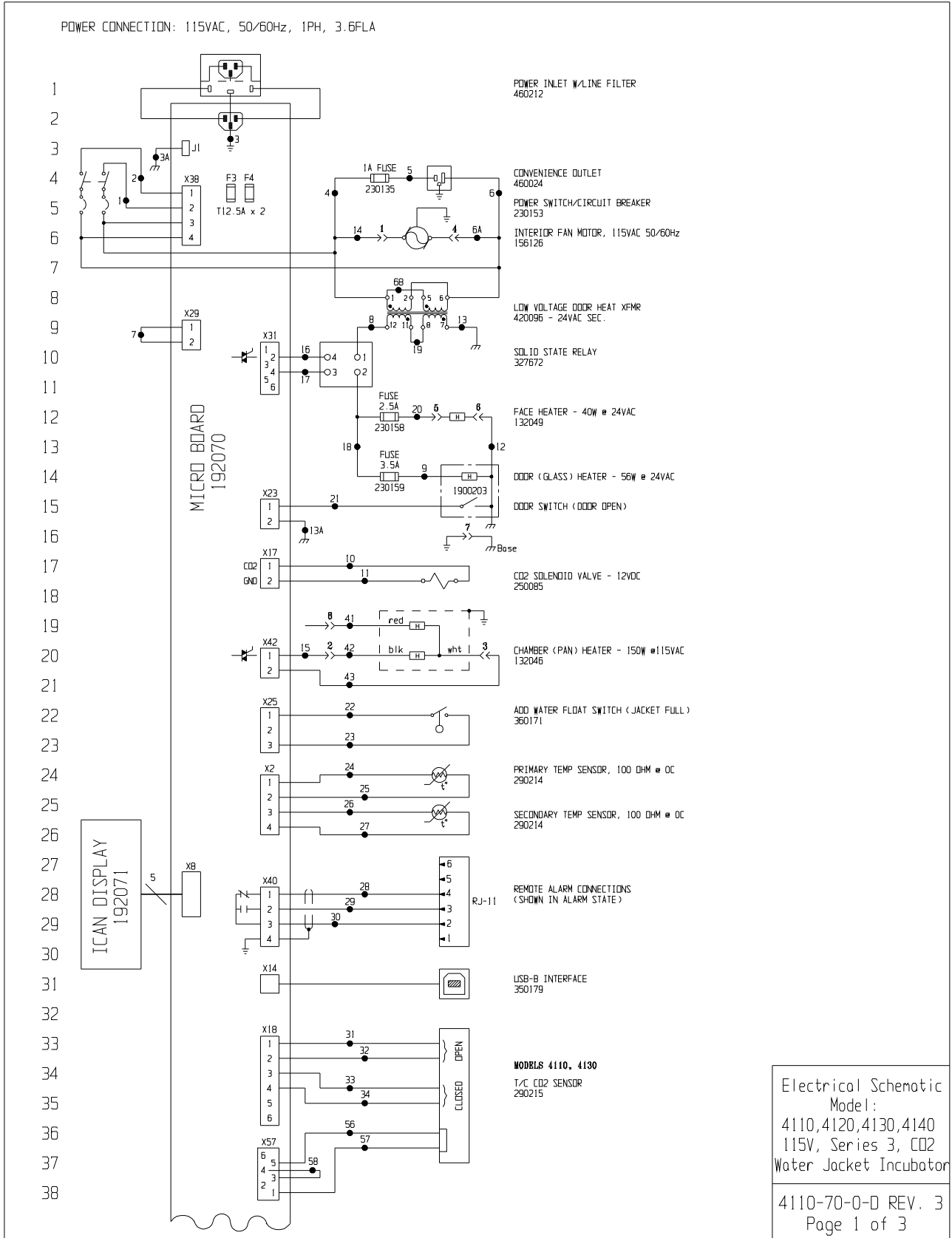



Section 10  
Electrical Schematics

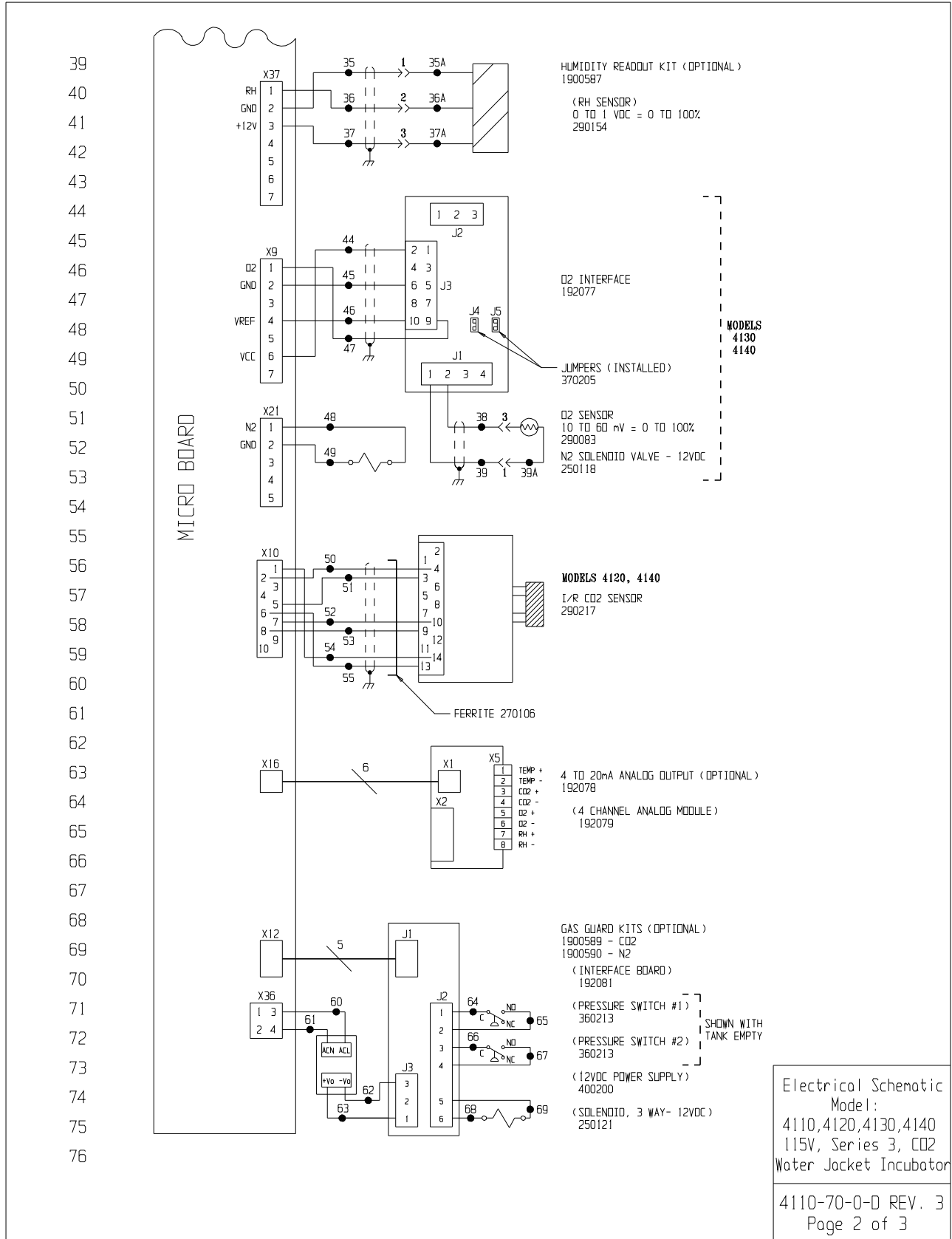

77  
78  
79  
80  
81  
82  
83  
84  
85  
86  
87  
88  
89  
90  
91  
92  
93  
94  
95  
96  
97  
98  
99  
100  
101  
102  
103  
104  
105  
106  
107

WIRE REFERENCE CHART								
NO.	AWG	COLOR	NO.	AWG	COLOR	NO.	AWG	COLOR
1	16	BROWN	26	22	RED	49	22	PURPLE
2	16	BLUE	27	22	RED	50	24/6	WHITE
3	16	GRN/YEL	28	22/3	BLACK	51	24/6	BLACK
4	18	BLACK	29	22/3	RED	52	24/6	GREEN
5	18	BLACK	30	22/3	GREEN	53	24/6	RED
6	18	WHITE	31	24	RED	54	24/6	BLUE
6A	18	GRAY	32	24	RED	55	24/6	BROWN
7	18	BLACK	33	24	WHITE	56	24	RED
8	18	BROWN	34	24	WHITE	57	24	WHITE
9	18	BLUE	35	22/3	WHITE	58	24	WHITE
10	18	YELLOW	35A	22/3	BLUE	59	N/U	---
11	18	YELLOW	36	22/3	RED	60	24	BROWN
12	18	BLACK	36A	22/3	WHITE	61	24	BLUE
13	18	GREEN	37	22/3	BLACK	62	24	BLACK
13A	20	GREEN	37A	22/3	BROWN	63	24	RED
14	18	BLUE	38	24/2	BLACK	64	20	YELLOW
15	18	ORANGE	39	24/2	WHITE	65	20	YELLOW
16	18	PURPLE	39A	24	RED	66	20	PURPLE
17	18	GRAY	40	N/U	---	67	20	PURPLE
18	18	RED	41	18	RED	68	20	ORANGE
19	18	RED	42	18	BLACK	69	20	ORANGE
20	18	ORANGE	43	18	WHITE			
21	22	BROWN	44	24/4	GREEN			
22	22	BLUE	45	24/4	WHITE			
23	22	BLUE	46	24/4	RED			
24	22	YELLOW	47	24/4	BLACK			
25	22	YELLOW	48	22	YELLOW			

N/U= Not Used

MODEL	DESCRIPTION
4110	WATER JACKET INCUBATOR - TC CO2
4120	WATER JACKET INCUBATOR - IR CO2
4130	WATER JACKET INCUBATOR - TC O2
4140	WATER JACKET INCUBATOR - IR O2

3	EN-4676	10-08-15	GLS	JAS	CCS	CHG TERMINAL ORIENTATION ON 192079
2	EN-4401	11-14-14	JAS	JAS	DRP	ADD X57 CONNECTION, REV. ANALOG OUT
1	EN-4401	07-21-14	JAS	JAS	DRP	ELIM. POWER SUPPLY ON 4-20mA OPTION
0	EN-4401	05-23-14	JAS	JAS	DRP	RELEASED FOR PRODUCTION
REV	ECN NO.	DATE	BY	CAD	APPO	DESCRIPTION OF REVISION
MODEL/PART NAME: SERIES 3 WATER JACKET INCUBATOR, 115 VOLT (DDM.)						
DWG TITLE: ELECTRICAL SCHEMATIC						
OWN: JAS		CAD: JAS		APPO:		DATE: 07-11-13
SCALE: NONE						
MATERIAL:						
PAINT COLOR:						
TOLERANCE UNLESS OTHERWISE SPECIFIED			DRAWING NUMBER		SIZE	
ANGLES: DECIMAL: .XX±			4110-70-0		D	
			DECIMAL: .XXX±			

Electrical Schematic  
Model:  
4110,4120,4130,4140  
115V, Series 3, CO2  
Water Jacket Incubator  
4110-70-0-D REV. 3  
Page 3 of 3



ATTENTION  
OBSERVE PRECAUTIONS  
ELECTROSTATIC  
SENSITIVE DEVICES

THIS DOCUMENT CONTAINS PROPRIETARY INFORMATION AND SUCH INFORMATION IS NOT TO BE DISCLOSED TO OTHERS FOR ANY PURPOSE NOR USED FOR MANUFACTURING PURPOSES WITHOUT WRITTEN PERMISSION FROM THERMO FISHER SCIENTIFIC

**ThermoFisher**  
**SCIENTIFIC**  
BOX 649, MARIETTA, OHIO 45750

Section 10  
Electrical Schematics

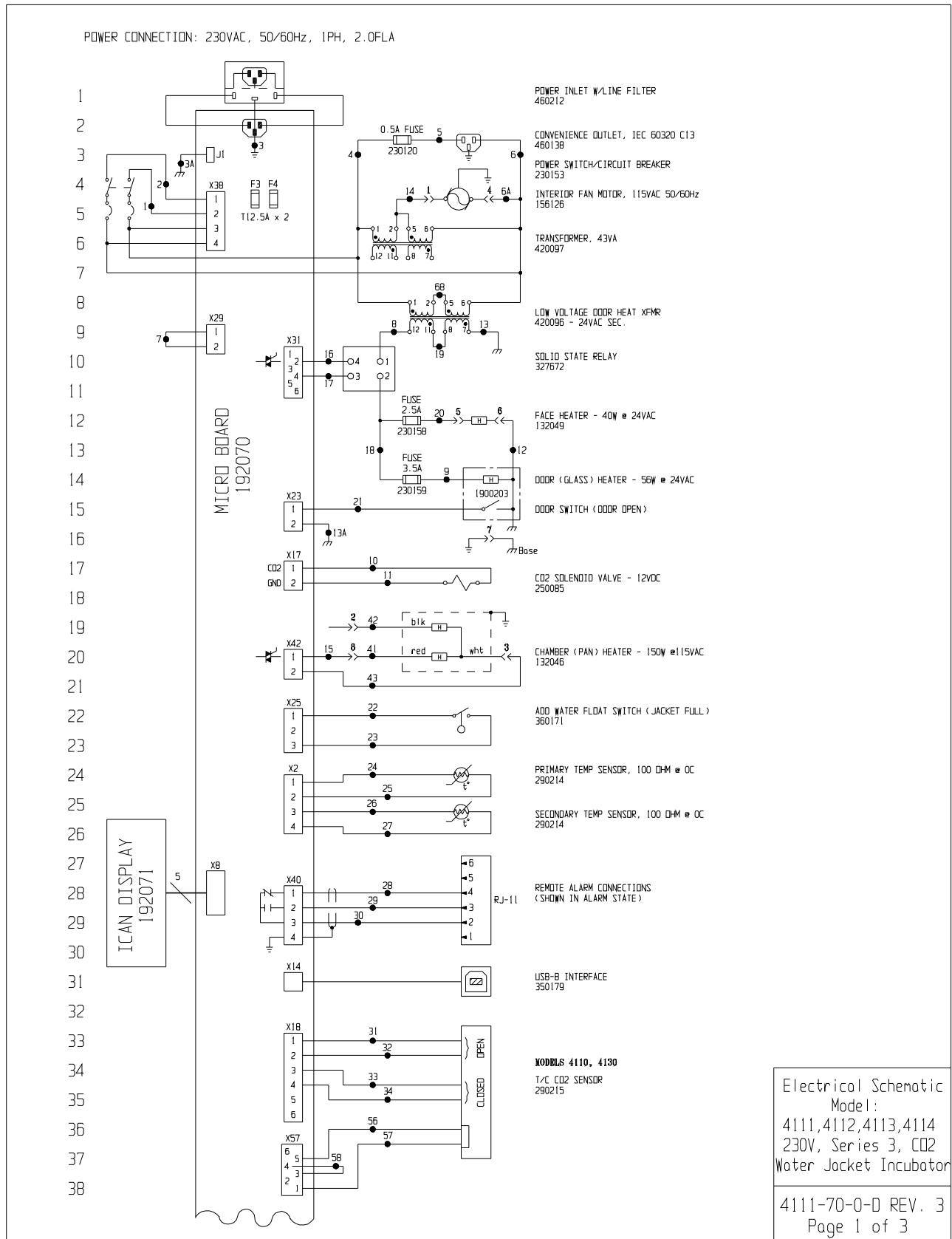

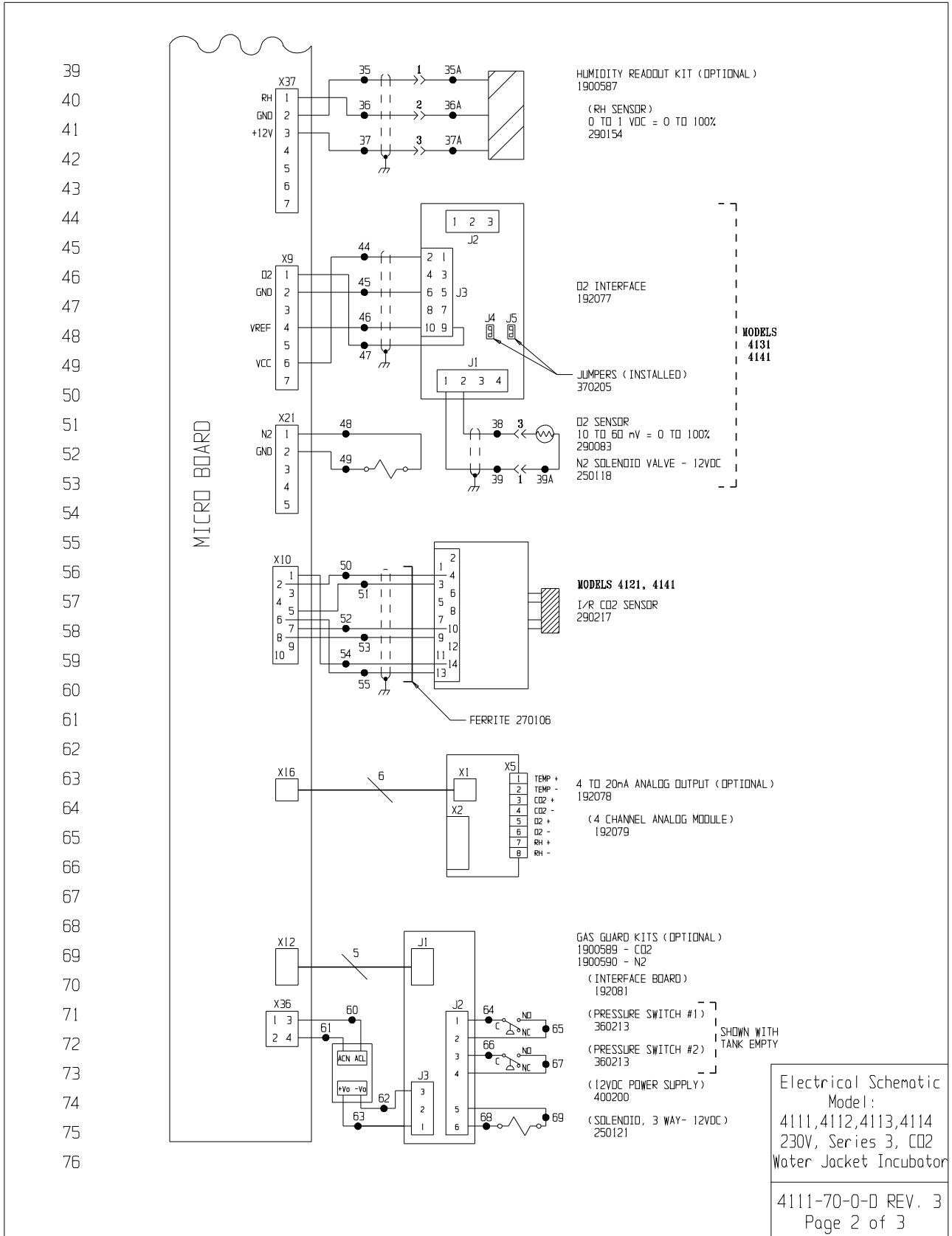

77  
78  
79  
80  
81  
82  
83  
84  
85  
86  
87  
88  
89  
90  
91  
92  
93  
94  
95  
96  
97  
98  
99  
100  
101  
102  
103  
104  
105  
106  
107

WIRE REFERENCE CHART								
NO.	AWG	COLOR	NO.	AWG	COLOR	NO.	AWG	COLOR
1	16	BROWN	26	22	RED	49	22	PURPLE
2	16	BLUE	27	22	RED	50	24/6	WHITE
3	16	GRN/YEL	28	22/3	BLACK	51	24/6	BLACK
4	18	BLACK	29	22/3	RED	52	24/6	GREEN
5	18	BLACK	30	22/3	GREEN	53	24/6	RED
6	18	WHITE	31	24	RED	54	24/6	BLUE
6A	18	GRAY	32	24	RED	55	24/6	BROWN
7	18	BLACK	33	24	WHITE	56	24	RED
8	18	BROWN	34	24	WHITE	57	24	WHITE
9	18	BLUE	35	22/3	WHITE	58	24	WHITE
10	18	YELLOW	35A	22/3	BLUE	59	N/U	---
11	18	YELLOW	36	22/3	RED	60	24	BROWN
12	18	BLACK	36A	22/3	WHITE	61	24	BLUE
13	18	GREEN	37	22/3	BLACK	62	24	BLACK
13A	20	GREEN	37A	22/3	BROWN	63	24	RED
14	18	BLUE	38	24/2	BLACK	64	20	YELLOW
15	18	ORANGE	39	24/2	WHITE	65	20	YELLOW
16	18	PURPLE	39A	24	RED	66	20	PURPLE
17	18	GRAY	40	N/U	---	67	20	PURPLE
18	18	RED	41	18	RED	68	20	ORANGE
19	18	RED	42	18	BLACK	69	20	ORANGE
20	18	ORANGE	43	18	WHITE			
21	22	BROWN	44	24/4	GREEN			
22	22	BLUE	45	24/4	WHITE			
23	22	BLUE	46	24/4	RED			
24	22	YELLOW	47	24/4	BLACK			
25	22	YELLOW	48	22	YELLOW			

N/U= Not Used

MODEL	DESCRIPTION
4111	WATER JACKET INCUBATOR - TC CO2
4121	WATER JACKET INCUBATOR - IR CO2
4131	WATER JACKET INCUBATOR - TC O2
4141	WATER JACKET INCUBATOR - IR O2

3	DN-4676	10-08-15	GLS	JAS	CCS	CHG. TERM. ORIENTATION ON 192079
2	DN-4401	11-14-14	JAS	JAS	DRP	ADD X57 CONNECTION, REV. ANALOG OUT
1	DN-4401	07-21-14	JAS	JAS	DRP	ELIM. POWER SUPPLY ON 4-ZONA OPTION
0	DN-4401	05-23-14	JAS	JAS	DRP	RELEASED FOR PRODUCTION
REV	ECN NO.	DATE	BY	CAD	APPO	DESCRIPTION OF REVISION
MODEL/PART NAME: SERIES 3 WATER JACKET INCUBATOR, 230 VOLT (EXP.)						
DWG TITLE: ELECTRICAL SCHEMATIC						
DWG: JAS			CAD: JAS		APPO: DATE: 07-11-13 SCALE: NONE	
MATERIAL:						
PAINT COLOR:						
TOLERANCE UNLESS OTHERWISE SPECIFIED			DRAWING NUMBER		SIZE	
ANGLES: DECIMAL: .XX±			4111-70-0		0	
			DECIMAL: .XXX±			

Electrical Schematic  
Model:  
4111,4112,4113,4114  
230V, Series 3, CO2  
Water Jacket Incubator  
4111-70-0-D REV. 3  
Page 3 of 3



THIS DOCUMENT CONTAINS PROPRIETARY INFORMATION AND SUCH INFORMATION IS NOT TO BE DISCLOSED TO OTHERS FOR ANY PURPOSE NOR USED FOR MANUFACTURING PURPOSES WITHOUT WRITTEN PERMISSION FROM THERMO FISHER SCIENTIFIC

**ThermoFisher**  
**SCIENTIFIC**  
BOX 649, WAREHETTA, OHIO 45750

## THERMO FISHER SCIENTIFIC STANDARD PRODUCT WARRANTY

The Warranty Period starts two weeks from the date your equipment is shipped from our facility. This allows for shipping time so the warranty will go into effect at approximately the same time your equipment is delivered. The warranty protection extends to any subsequent owner during the first year warranty period.

During the first two (2) years, component parts proven to be non-conforming in materials or workmanship will be repaired or replaced at Thermo's expense, labor included. Installation and calibration are not covered by this warranty agreement. The Technical Services Department must be contacted for warranty determination and direction prior to performance of any repairs. Expendable items, glass, filters and gaskets are excluded from this warranty.

Replacement or repair of components parts or equipment under this warranty shall not extend the warranty to either the equipment or to the component part beyond the original warranty period. The Technical Services Department must give prior approval for return of any components or equipment. At Thermo's option, all non-conforming parts must be returned to Thermo Fisher Scientific postage paid and replacement parts are shipped FOB destination.

**THIS WARRANTY IS EXCLUSIVE AND IN LIEU OF ALL OTHER WARRANTIES, WHETHER WRITTEN, ORAL OR IMPLIED. NO WARRANTIES OF MERCHANTABILITY OR FITNESS FOR A PARTICULAR PURPOSE SHALL APPLY.** Thermo shall not be liable for any indirect or consequential damages including, without limitation, damages relating to lost profits or loss of products.

Your local Thermo Sales Office is ready to help with comprehensive site preparation information before your equipment arrives. Printed instruction manuals carefully detail equipment installation, operation and preventive maintenance.

If equipment service is required, please call your Technical Services Department at 1-800-438-4851 (USA and Canada) or 1-740-373-4763. We're ready to answer your questions on equipment warranty, operation, maintenance, service and special application. Outside the USA, contact your local distributor for warranty information.



Rev. 0 9/13

## Thermo Fisher Scientific International Dealer Warranty

The Warranty Period starts two months from the date your equipment is shipped from our facility. This allows for shipping time so the warranty will go into effect at approximately the same time your equipment is delivered. The warranty protection extends to any subsequent owner during the first year warranty period. Dealers who stock our equipment are allowed an additional six months for delivery and installation, provided the warranty card is completed and returned to the Technical Services Department.

During the first year, component parts proven to be non-conforming in materials or workmanship will be repaired or replaced at Thermo's expense, labor excluded. The Watlow EZ-ZONE PM controller is covered for one additional year for repair or replacement (parts only), provided the unit has not been misapplied. Installation and calibration are not covered by this warranty agreement. The Technical Services Department must be contacted for warranty determination and direction prior to performance of any repairs. Expendable items, glass, filters, reagents, tubing, and gaskets are excluded from this warranty.

Replacement or repair of components parts or equipment under this warranty shall not extend the warranty to either the equipment or to the component part beyond the original warranty period. The Technical Services Department must give prior approval for return of any components or equipment. At Thermo's option, all non-conforming parts must be returned to Thermo postage paid and replacement parts are shipped FOB destination.

**THIS WARRANTY IS EXCLUSIVE AND IN LIEU OF ALL OTHER WARRANTIES, WHETHER WRITTEN, ORAL OR IMPLIED. NO WARRANTIES OF MERCHANTABILITY OR FITNESS FOR A PARTICULAR PURPOSE SHALL APPLY.** Thermo shall not be liable for any indirect or consequential damages including, without limitation, damages relating to lost profits or loss of products.

Your local Thermo Sales Office is ready to help with comprehensive site preparation information before your equipment arrives. Printed instruction manuals carefully detail equipment installation, operation and preventive maintenance.

Contact your local distributor for warranty information. We're ready to answer your questions on equipment warranty, operation, maintenance, service and special application.



Rev. 5 8/13

**picofast® "Snap Lock" Connector Instructions**

**UNLOCK**

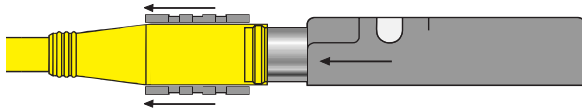

With TURCK's patented Locking Sleeve pulled back, any **picofast** sensor slides on without any difficulty.

After sensor is connected, push Locking Sleeve forward to create a watertight connection. It's a snap!

**LOCK**

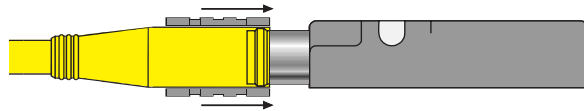

**Installation Instructions**

**To Attach:**

**To Detach:**

1. Be sure black locking sleeve is pulled back.

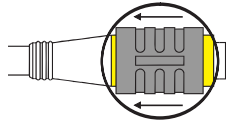

1. Do not twist.

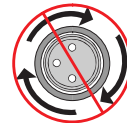

2. Line up pins and push connector onto plug. You will feel a "snap." Do not twist.

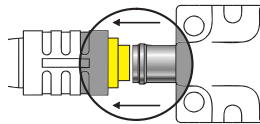

2. Pull locking sleeve back to "unlocked" position.

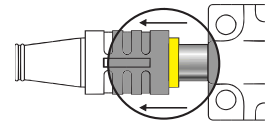

3. Push locking sleeve forward on connector until it is flush with the front of the connector.

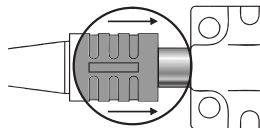

3. Pull connector straight off.

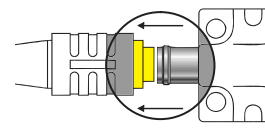

4. If sleeve is difficult to slide on a new connector, "exercise" it a few times. Do not use tools.

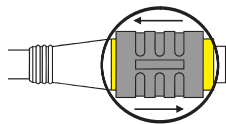

4. Leave locking sleeve in unlocked position.

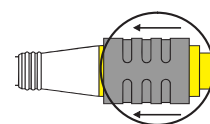

Clearwater Tech - Phone: 800.894.0412 - Fax: 208.368.0415 - Web: [www.clwtr.com](http://www.clwtr.com) - Email: [info@clwtr.com](mailto:info@clwtr.com)



**thermoscientific.com**

© 2014 Thermo Fisher Scientific Inc. All rights reserved. All trademarks are the property of Thermo Fisher Scientific and its subsidiaries. Specifications, terms and pricing are subject to change. Not all products are available in all countries. Please consult your local sales representative for details.

---

**Thermo Fisher Scientific**  
401 Millcreek Road  
Marietta, Ohio 45750  
United States

**Thermo**  
S C I E N T I F I C  
A Thermo Fisher Scientific Brand