

Keithley Instruments
28775 Aurora Road
Cleveland, Ohio 44139
1-800-935-5595
<http://www.tek.com/keithley>

Capacitance Voltage Unit (CVU) Quick Start Guide

Overview

You can quickly begin using your Keithley Instruments Model 4210-CVU Capacitance Voltage Unit by following the steps in this Quick Start Guide (QSG). For detailed information about the 4210-CVU, refer to the Complete Reference CD-ROM that came with your Model 4200-SCS Semiconductor Characterization System.

Follow the steps outlined below and detailed in the following pages to begin using your 4210-CVU:

- Step 1: Unpack your 4200-SCS.
- Step 2: Make basic system connections (power cord, keyboard, and optional printer).
- Step 3: Connect a test fixture to the 4200-SCS (4210-CVU card preinstalled).
- Step 4: Power up and log on.
- Step 5: Start the KITE software and select the cv-cap test in the default project.
- Step 6: Define your test.
- Step 7: Run the cv-cap test.
- Step 8: View the data sheet.
- Step 9: View the graph.
- Step 10: Print and export data.

The example in this QSG uses the default project and runs the cv-cap test. To select a different project or test, you must modify the procedures as appropriate. Figure 1 shows the Keithley Interactive Test Environment (KITE) window after the default project and cv cap test are selected.

Figure 1: KITE interface with the cv-cap test selected in the default project

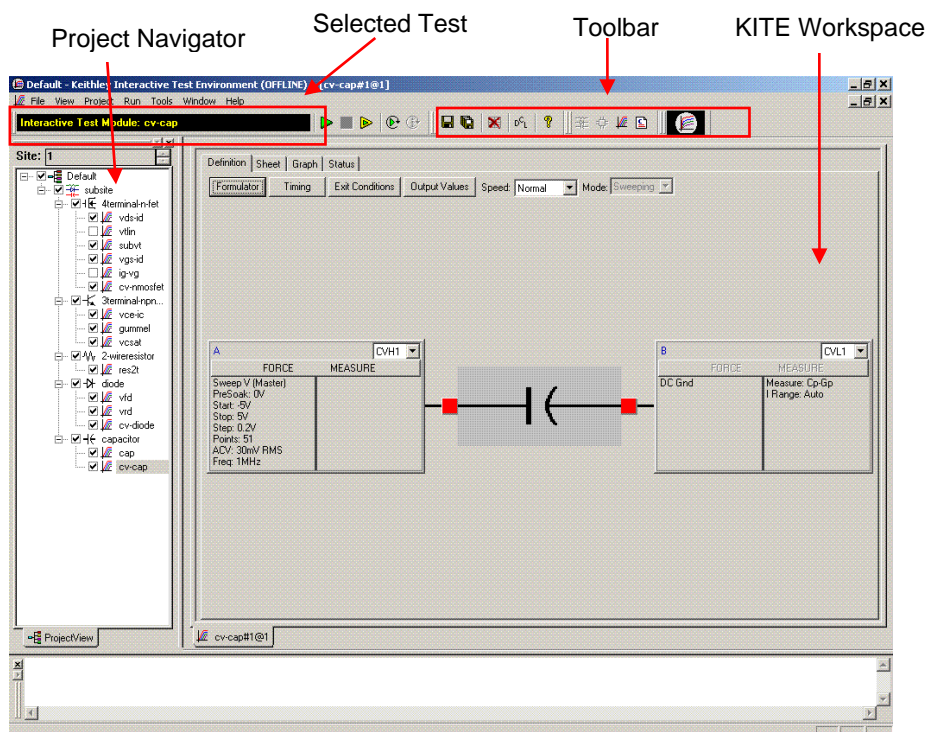

Step 1: Unpack your 4200-SCS

The box contains:

- 4200-SCS Semiconductor Characterization System, with the 4210-CVU card integrated into the mainframe.

NOTE

How to lift the 4200-SCS:

- Lift from the bottom, not from the front bezel.
- Set it on a bench or install it in a rack using the optional slide rack-mounting kit.

- Keyboard with built-in pointing device
- Two triax cables for each source-measure unit (SMU)
- Four red SMA to SMA cables for the 4210-CVU
- Connectors: Four SMA to BNC adapters; 2 BNC tees
- Y-Cable: Use to connect the keyboard to the mainframe
- Power cord
- Model 4200-SCS KTE Interactive CD-ROM
- Model 4200-SCS Complete Reference CD-ROM

Step 2: Make basic system connections (power cord, keyboard, and optional printer)

Basic system connections to the 4200-SCS (shown in Figure 2) include the keyboard (which has a built-in pointing device), the supplied power cord, and an optional printer. If you are using a USB printer, connect it to the USB port.

⚠ WARNING

Plug the female end of the supplied power cord into the 4200-SCS. Do not connect the male end to line power at this time. Steps 2 and 3 in this Quick Start Guide must be performed with the line power disconnected.

Figure 2: System connections

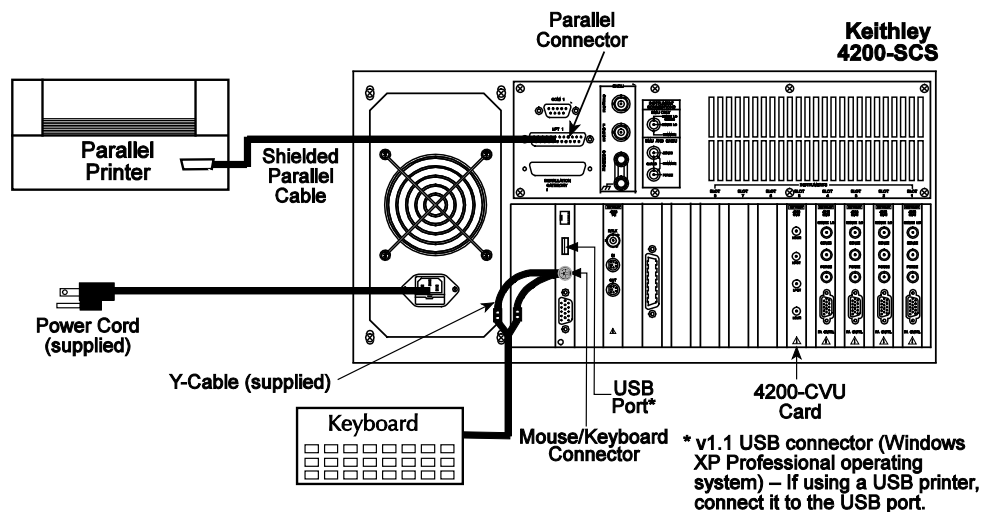

Step 3: Connect a test fixture to the 4200-SCS (4210-CVU card preinstalled)

Figure 3 shows how to connect a BNC test fixture to the 4200-SCS. The red SMA cables and BNC adapters are supplied with the 4210-CVU card.

Figure 3: DUT test fixture connections to the 4210-CVU

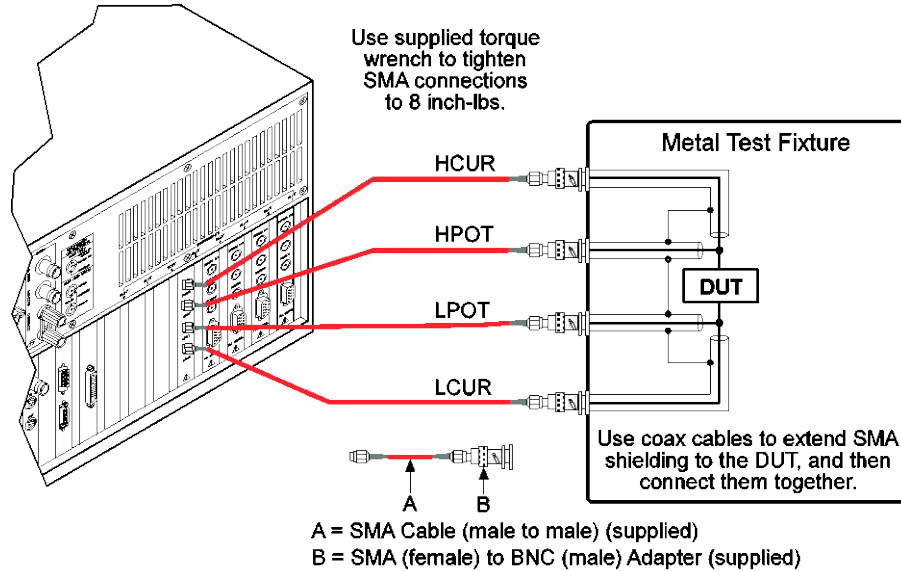

Step 4: Power up and log on

1. Make sure the POWER switch is in the OFF (out) position. The POWER switch is on the front panel in the lower right corner.
2. Plug the male end of the line cord into a properly grounded AC line power receptacle.
3. Turn on the 4200-SCS by pushing in the **POWER** switch to the ON (in) position.
4. At the KIUSER prompt, press **ENTER**. There is no password for this account.

CAUTION

When first starting a KTE Interactive software tool, you must answer "Yes" to an on-screen license agreement. Answering "No" makes your system nonfunctional until you reinstall the software.

Step 5: Start the KITE software and select the cv-cap test in the default project

1. Start the KITE software by double-clicking the KITE icon on the Microsoft® Windows® desktop (see Figure 4).

Figure 4: The KITE icon



When KITE starts, the default project will open automatically. If a different project opens, perform the three steps in Figure 5 to open the default project. The Project Navigator for the default project is shown in Figure 1.

NOTE

If the Project Navigator is not displayed when KITE is started, click the **View** menu and select the **Project Navigator** item. The View menu is located on the upper left side of the menu bar in the KITE window.

Figure 5: Open default project

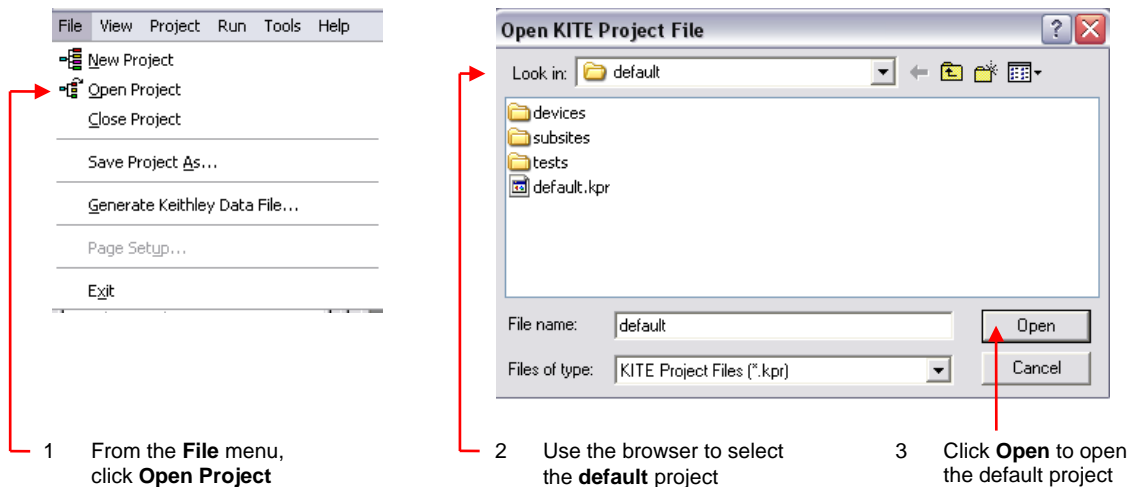

NOTE

When browsing, use the following directory path to locate the `default.kpr` project file:
`C:\S4200\kiuser\Projects\default\default.kpr`

2. Select the **cv-cap** test, as shown in Figure 6.

Figure 6: Default project in Project Navigator: Selecting the cv-cap test

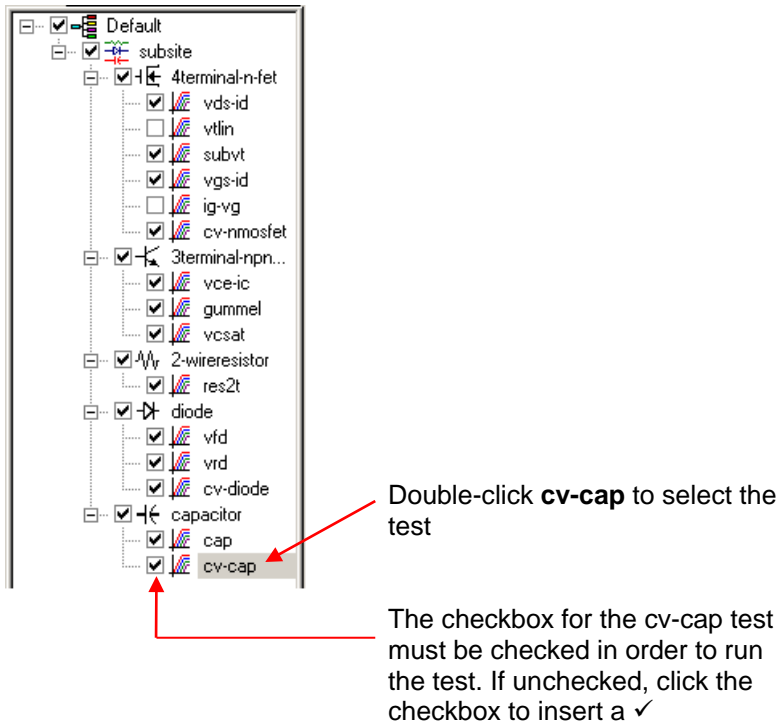

Step 6: Define your test

The test is defined from the test Definition tab shown in Figure 7. As shown in the tab, the device in this example is connected to the CVH1 and the CVL1 terminals of the 4210-CVU. In this test, the DC bias is swept from -5 V to 5 V in 0.2 V steps, with a 1 MHz capacitance measurement made at each step.

1. You can change the setup for the **cv-cap** test. A settings window is displayed by clicking the appropriate **FORCE MEASURE** bar, as shown in Figure 7. Figure 8 shows the Forcing Functions / Measure Options window for **cv-cap** setup.

Figure 7: cv-cap Definition tab: How to display a setup window for the CVU instrument

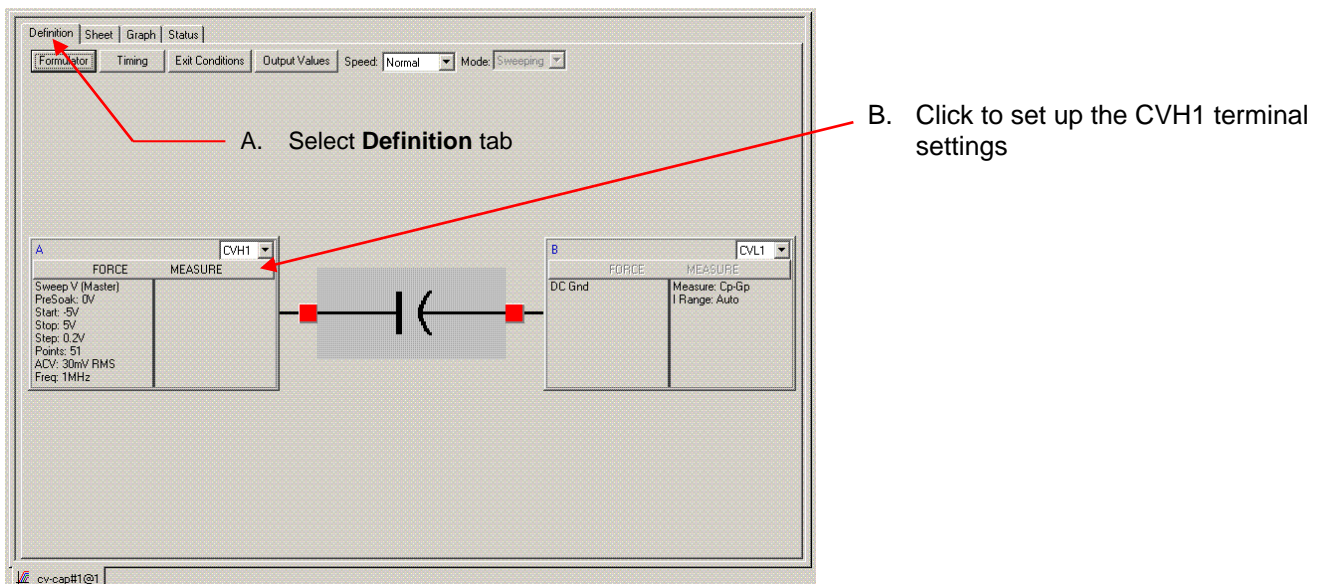
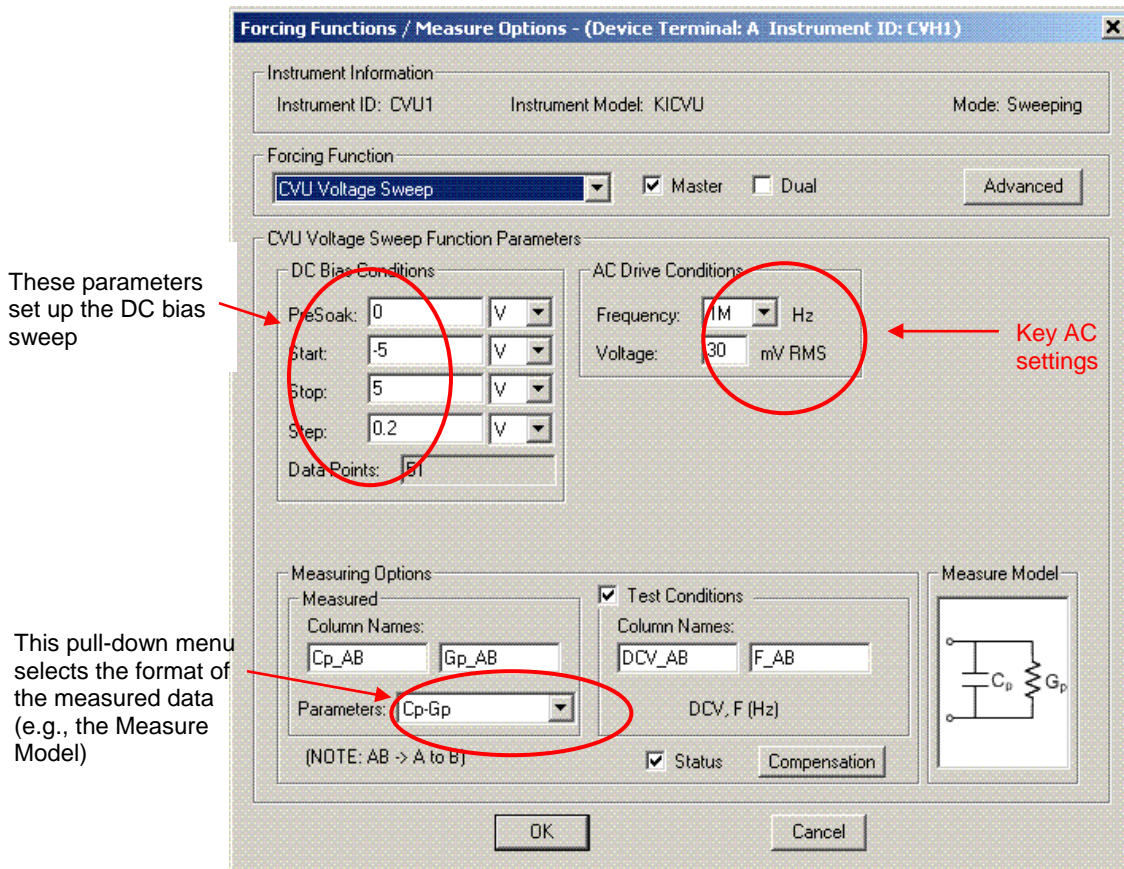
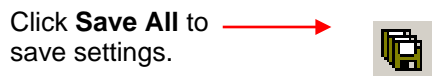

Figure 8: Setup for CVU pin CVH1



2. After making any changes to the test definition, click the **Save All** button on the toolbar to save the settings (see Figure 9).

Figure 9: The Save All button



Step 7: Run the cv-cap test

1. In the Project Navigator (see Figure 6), make sure the cv-cap test is highlighted and the checkbox is checked.
2. On the toolbar, click the green **Run Test** button to run the test one time (see Figure 10).

Figure 10: The Run Test button



While the test is running, the Run Test button turns gray and the Abort Test button turns red. In addition, the MEASURING indicator on the lower right corner of the front panel is on while the test is running. When the test is finished, the Run Test button turns green.

Troubleshooting hints

A selected test will not run if the Run Test button is not green. Here are a few reasons why the Run Test button will not be green:

- A test is still running.
- The checkbox for the test is not checked (see Figure 6).
- Changes to the test setup were not saved (see Step 6B).

If a selected test still will not run, click the Status tab for the test. This tab provides status information for the test.

Step 8: View the data sheet

The data sheet for the cv-cap test is displayed by clicking the **Sheet** tab for the test. Use the tabs at the bottom of the Sheet to display the data type. A sample data sheet for the cv-cap test is shown in Figure 11.

Figure 11: Sample data sheet for the cv-cap test

	A	B	C	D	E	F
1	Cp_AB	Gp_AB	DCV_AB	F_AB	CVU1S	NOISE
2	10.2272E-12	-124.6173E-9	-5.0000E+0	1.0000E+6	00000001	645.7550E-18
3	10.2262E-12	-116.0054E-9	-4.8000E+0	1.0000E+6	00000001	
4	10.2263E-12	-118.2291E-9	-4.6000E+0	1.0000E+6	00000001	
5	10.2271E-12	-117.7869E-9	-4.4000E+0	1.0000E+6	00000001	
6	10.2274E-12	-113.3137E-9	-4.2000E+0	1.0000E+6	00000001	
7	10.2272E-12	-116.2346E-9	-4.0000E+0	1.0000E+6	00000001	
8	10.2266E-12	-115.1082E-9	-3.8000E+0	1.0000E+6	00000001	
9	10.2265E-12	-114.9680E-9	-3.6000E+0	1.0000E+6	00000001	
10	10.2268E-12	-116.0234E-9	-3.4000E+0	1.0000E+6	00000001	
11	10.2267E-12	-129.4277E-9	-3.2000E+0	1.0000E+6	00000001	
12	10.2270E-12	-114.9558E-9	-3.0000E+0	1.0000E+6	00000001	
13	10.2275E-12	-121.9971E-9	-2.8000E+0	1.0000E+6	00000001	
14	10.2273E-12	-113.5520E-9	-2.6000E+0	1.0000E+6	00000001	
15	10.2268E-12	-118.6105E-9	-2.4000E+0	1.0000E+6	00000001	
16	10.2275E-12	-126.4123E-9	-2.2000E+0	1.0000E+6	00000001	
17	10.2281E-12	-117.5246E-9	-2.0000E+0	1.0000E+6	00000001	
18	10.2277E-12	-112.9315E-9	-1.8000E+0	1.0000E+6	00000001	
19	10.2274E-12	-112.6724E-9	-1.6000E+0	1.0000E+6	00000001	
20	10.2276E-12	-116.8824E-9	-1.4000E+0	1.0000E+6	00000001	
21	10.2273E-12	-108.5163E-9	-1.2000E+0	1.0000E+6	00000001	
22	10.2283E-12	-113.6128E-9	-1.0000E+0	1.0000E+6	00000001	
23	10.2266E-12	-117.4871E-9	-800.0003E-3	1.0000E+6	00000001	
24	10.2275E-12	-110.4371E-9	-600.0003E-3	1.0000E+6	00000001	
25	10.2272E-12	-112.2101E-9	-400.0003E-3	1.0000E+6	00000001	
26	10.2271E-12	-114.4295E-9	-200.0003E-3	1.0000E+6	00000001	

Click to export data (see Step 10)

Click to display Data Sheet

Click to display Calc Sheet

Click to display Settings Sheet

NOTE

To select more than one sheet for selective printing, hold down the **Ctrl** key and then click the tab. See Step 10 to print Sheet data.

Step 9: View the graph

The graph for the cv-cap test is displayed by clicking the **Graph** tab for the test. A sample graph for the cv-cap test is shown in Figure 12. Notice that the extracted NOISE parameter is included on the screen.

The Graph Settings menu (shown in Figure 13) was used to select the Legend box and change series colors.

Figure 12: Sample graph for the vds-id test

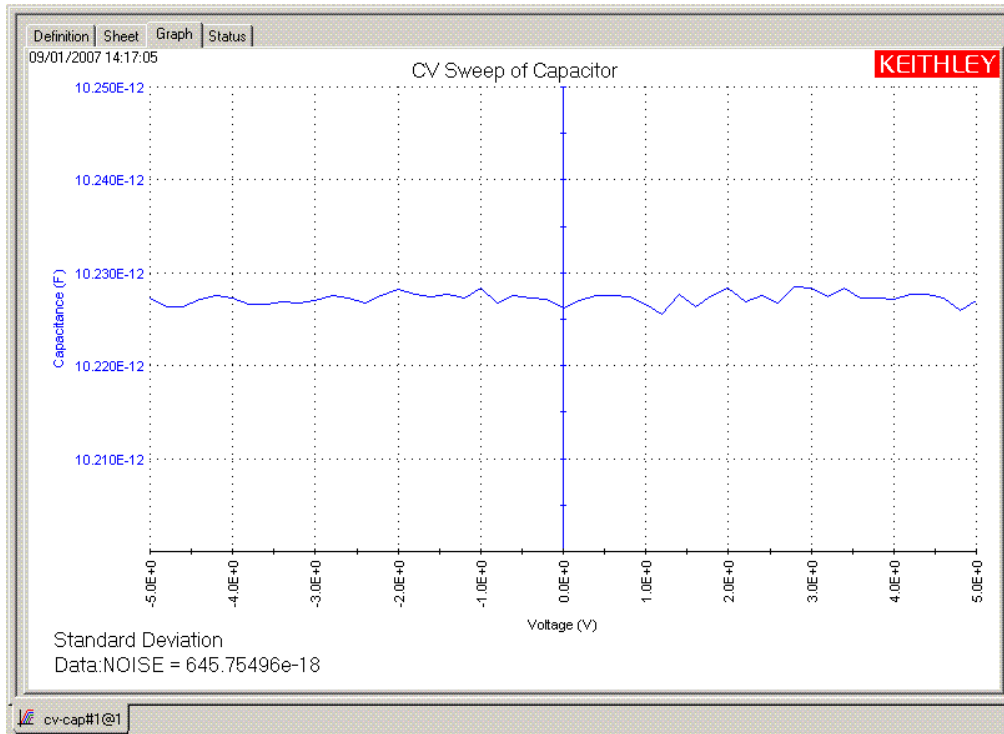
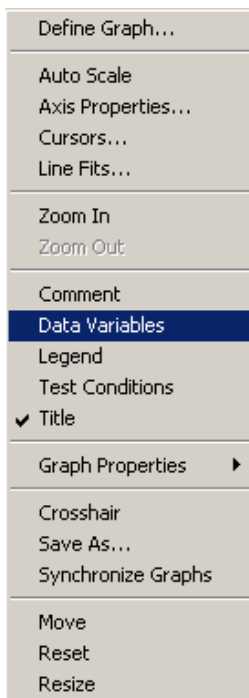

Figure 13: Graph Settings menu



To display the Graph Settings menu: Right-click your mouse anywhere in the graph area.

OR

From the **Tools** menu, select **Graph...Settings**.

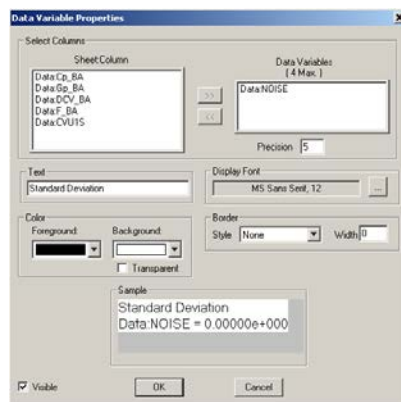

Use the **Data Variables** properties dialog box to display extracted parameters – NOISE in this case

Auto Y-axis

By default, the Y-axis does not automatically scale.

To automatically achieve optimum resolution for the Y-axis, select auto scale as follows:

1. Right-click anywhere on the graph to display the graph settings menu shown in Figure 13.
2. In the menu, click **Auto Properties** to display the Axis Properties window.
3. Click the **Y1 Axis** tab, and then click **Auto Scale** to select the box for Auto.
4. Click **OK** to close the window and enable auto scale for the Y-axis.

Step 10: Print and export data

Printing Sheet data

1. In the KITE workspace, click the **Sheet** tab to display test data. You can selectively print the Data sheet, Calc sheet, and the Settings sheet. Figure 11 and the NOTE that follows it show how to select sheets for printing.
2. From the **FILE** menu (at the upper left side of the KITE window), select the **Print** option.
3. In the **Print** setup window, there are two print options. You can print the **Selected Sheets** (Data, Calc, or Sheet) or the **Entire Workbook** (Data, Calc, and Sheet).
4. In the **Print** setup window, click **OK** to print the data.

Printing the graph

1. In the KITE workspace, click the **Graph** tab to display the graph.
2. From the **FILE** menu (at the upper left side of the KITE window), select the **Print** option.
3. In the **Print** setup window, click **OK** to print the graph.

Exporting data into a Microsoft® Excel-compatible worksheet

1. In the KITE workspace, click the **Sheet** tab to display the test data.
2. In the Sheet tab, click the **Save As** button, as shown in Figure 11.
3. From the **Save As** setup window, specify a file name and path and click **Save**. The default directory path for exporting data is C:\S4200\kiuser\export.

Additional projects for the 4210-CVU

The following additional projects have been created for the 4210-CVU are in the “_CV” folder in the Projects directory:

CVU_BJT	CVU_Capacitor	CVU_InterconnectCap
CVU_ivcvswitch	CVU_lifetime	CVU_Mobilelon
CVU_MOScap	CVU_MOSFET	CVU_nanowire
CVU_PNjunction	CVU_PVcell	

To open one of the above project plans:

4. Click **File** at the top of the Keithley Interactive Test Environment (KITE) window.
5. Select **Open Project** from the list.
6. In the Open KITE Project File window, navigate back (up one level) to the **Projects** folder.
7. Double-click the **_CV** folder.
8. Open the CVU project.



Safety precautions

The following safety precautions should be observed before using this product and any associated instrumentation. Although some instruments and accessories would normally be used with nonhazardous voltages, there are situations where hazardous conditions may be present.

This product is intended for use by qualified personnel who recognize shock hazards and are familiar with the safety precautions required to avoid possible injury. Read and follow all installation, operation, and maintenance information carefully before using the product. Refer to the user documentation for complete product specifications.

If the product is used in a manner not specified, the protection provided by the product warranty may be impaired.

The types of product users are:

Responsible body is the individual or group responsible for the use and maintenance of equipment, for ensuring that the equipment is operated within its specifications and operating limits, and for ensuring that operators are adequately trained.

Operators use the product for its intended function. They must be trained in electrical safety procedures and proper use of the instrument. They must be protected from electric shock and contact with hazardous live circuits.

Maintenance personnel perform routine procedures on the product to keep it operating properly, for example, setting the line voltage or replacing consumable materials. Maintenance procedures are described in the user documentation. The procedures explicitly state if the operator may perform them. Otherwise, they should be performed only by service personnel.

Service personnel are trained to work on live circuits, perform safe installations, and repair products. Only properly trained service personnel may perform installation and service procedures.

Keithley Instruments products are designed for use with electrical signals that are measurement, control, and data I/O connections, with low transient overvoltages, and must not be directly connected to mains voltage or to voltage sources with high transient overvoltages. Measurement Category II (as referenced in IEC 60664) connections require protection for high transient overvoltages often associated with local AC mains connections. Certain Keithley Instruments measuring instruments may be connected to mains. These instruments will be marked as category II or higher.

Unless explicitly allowed in the specifications, operating manual, and instrument labels, do not connect any instrument to mains.

Exercise extreme caution when a shock hazard is present. Lethal voltage may be present on cable connector jacks or test fixtures. The American National Standards Institute (ANSI) states that a shock hazard exists when voltage levels greater than 30 V RMS, 42.4 V peak, or 60 VDC are present. A good safety practice is to expect that hazardous voltage is present in any unknown circuit before measuring.

Operators of this product must be protected from electric shock at all times. The responsible body must ensure that operators are prevented access and/or insulated from every connection point. In some cases, connections must be exposed to potential human contact. Product operators in these circumstances must be trained to protect themselves from the risk of electric shock. If the circuit is capable of operating at or above 1000 V, no conductive part of the circuit may be exposed.

Do not connect switching cards directly to unlimited power circuits. They are intended to be used with impedance-limited sources. NEVER connect switching cards directly to AC mains. When connecting sources to switching cards, install protective devices to limit fault current and voltage to the card.

Before operating an instrument, ensure that the line cord is connected to a properly-grounded power receptacle. Inspect the connecting cables, test leads, and jumpers for possible wear, cracks, or breaks before each use.

When installing equipment where access to the main power cord is restricted, such as rack mounting, a separate main input power disconnect device must be provided in close proximity to the equipment and within easy reach of the operator.

For maximum safety, do not touch the product, test cables, or any other instruments while power is applied to the circuit under test. ALWAYS remove power from the entire test system and discharge any capacitors before: connecting or disconnecting cables or jumpers, installing or removing switching cards, or making internal changes, such as installing or removing jumpers.

Do not touch any object that could provide a current path to the common side of the circuit under test or power line (earth) ground. Always make measurements with dry hands while standing on a dry, insulated surface capable of withstanding the voltage being measured.

For safety, instruments and accessories must be used in accordance with the operating instructions. If the instruments or accessories are used in a manner not specified in the operating instructions, the protection provided by the equipment may be impaired.

Do not exceed the maximum signal levels of the instruments and accessories. Maximum signal levels are defined in the specifications and operating information and shown on the instrument panels, test fixture panels, and switching cards.

When fuses are used in a product, replace with the same type and rating for continued protection against fire hazard.

Chassis connections must only be used as shield connections for measuring circuits, NOT as protective earth (safety ground) connections.

If you are using a test fixture, keep the lid closed while power is applied to the device under test. Safe operation requires the use of a lid interlock.

If a  screw is present, connect it to protective earth (safety ground) using the wire recommended in the user documentation.

The  symbol on an instrument means caution, risk of danger. The user must refer to the operating instructions located in the user documentation in all cases where the symbol is marked on the instrument.

The  symbol on an instrument means caution, risk of electric shock. Use standard safety precautions to avoid personal contact with these voltages.

The  symbol on an instrument shows that the surface may be hot. Avoid personal contact to prevent burns.

The  symbol indicates a connection terminal to the equipment frame.

If this  symbol is on a product, it indicates that mercury is present in the display lamp. Please note that the lamp must be properly disposed of according to federal, state, and local laws.

The **WARNING** heading in the user documentation explains dangers that might result in personal injury or death. Always read the associated information very carefully before performing the indicated procedure.

The **CAUTION** heading in the user documentation explains hazards that could damage the instrument. Such damage may invalidate the warranty.

Instrumentation and accessories shall not be connected to humans.

Before performing any maintenance, disconnect the line cord and all test cables.

To maintain protection from electric shock and fire, replacement components in mains circuits — including the power transformer, test leads, and input jacks — must be purchased from Keithley Instruments. Standard fuses with applicable national safety approvals may be used if the rating and type are the same. The detachable mains power cord provided with the instrument may only be replaced with a similarly rated power cord. Other components that are not safety-related may be purchased from other suppliers as long as they are equivalent to the original component (note that selected parts should be purchased only through Keithley Instruments to maintain accuracy and functionality of the product). If you are unsure about the applicability of a replacement component, call a Keithley Instruments office for information.

Unless otherwise noted in product-specific literature, Keithley Instruments instruments are designed to operate indoors only, in the following environment: Altitude at or below 2,000 m (6,562 ft); temperature 0 °C to 50 °C (32 °F to 122 °F); and pollution degree 1 or 2.

To clean an instrument, use a damp cloth or mild, water-based cleaner. Clean the exterior of the instrument only. Do not apply cleaner directly to the instrument or allow liquids to enter or spill on the instrument. Products that consist of a circuit board with no case or chassis (e.g., a data acquisition board for installation into a computer) should never require cleaning if handled according to instructions. If the board becomes contaminated and operation is affected, the board should be returned to the factory for proper cleaning/servicing.

Safety precaution revision as of March 2016.