

Model 600

Model 650

Installation and Operations Manual



WELL MASTER CORPORATION

v1.6.x 19/09/2013

WMCCONM-1K2

Modbus is a trademark of Modicon Inc.

Model 600/Model 650 Installation and Operations Manual

Copyright © 2013 Extreme Telematics Corp. All Rights Reserved.

Revision History

Rev	Date	Author	Changes
1.x.x	17/12/2010	Mark Scantlebury	Initial Version
1.4.x	27/04/2012	Mark Scantlebury	Update to match simpler menus. Use new pictures and part numbers.
1.6.x	19/09/2013	Mark Scantlebury	Add in vent time tracking, total stats and plunger stats. Add in Valve B Purge Add Digital Output Pulse

Table of Contents

1	INTRODUCTION.....	1
1.1	PURPOSE.....	1
1.2	OVERVIEW	1
1.3	ASSUMPTIONS	1
2	INSTALLATION.....	2
2.1	MOUNTING	2
2.1.1	<i>Wall/Stud Mount</i>	2
2.1.2	<i>Pipe Mount</i>	2
2.1.3	<i>Valve Mount</i>	3
2.2	GAS CONNECTIONS.....	3
2.2.1	<i>Supply</i>	3
2.2.2	<i>Valve</i>	4
2.2.3	<i>Vent</i>	4
2.3	GROUNDING.....	4
2.4	ELECTRICAL CONNECTIONS.....	4
2.4.1	<i>Solar Panel</i>	7
2.4.2	<i>Battery</i>	8
2.4.3	<i>Solenoids</i>	8
2.4.4	<i>Plunger Arrival Sensor</i>	9
2.4.5	<i>Pressure Inputs</i>	9
2.4.6	<i>Digital Outputs</i>	9
2.4.7	<i>COM Ports</i>	10
3	CONTROLLER OVERVIEW	11

3.1	START UP.....	11
3.2	DISPLAY.....	11
3.2.1	Menu Area.....	11
3.2.2	Status Area.....	11
3.2.3	Automatic Shut Off.....	12
3.2.4	Automatic Log Out.....	12
3.3	KEYPAD.....	12
3.3.1	Navigation Keys.....	13
3.3.2	Numeric Keys.....	14
3.3.3	Hot Keys.....	14
3.4	HOME SCREEN.....	16
3.4.1	Current State.....	17
3.4.2	Cycle Information.....	17
3.4.3	Current Date/Time.....	17
3.4.4	Change State.....	17
3.5	STATUS SCREENS.....	17
3.5.1	Battery Status.....	18
3.5.2	Solar Status.....	18
3.5.3	Valve Status.....	18
3.5.4	Device Status.....	18
4	CONTROLLER OPERATION.....	19
4.1	BATTERY MONITOR.....	19
4.1.1	Low Battery.....	19
4.2	CONTROLLER CONFIGURATIONS.....	20
4.2.1	Intermitting.....	20

4.2.2	<i>Plunger Arrival Sensor (PAS)</i>	21
4.2.3	<i>Valve B</i>	24
4.2.4	<i>Auto Catcher</i>	28
4.2.5	<i>Line Pressure</i>	29
4.2.6	<i>Timer/Velocity Optimization</i>	30
4.2.7	<i>Pressure Based Optimization</i>	34
4.3	DIGITAL OUTPUTS.....	41
4.3.1	<i>Mimic Valve</i>	41
4.3.2	<i>On Alarm</i>	41
5	MENU REFERENCE	43
5.1	HOT KEY MENUS.....	43
5.1.1	<i>Settings Menu</i>	43
5.1.2	<i>History Menu</i>	45
5.2	INSTALL MENU.....	49
5.2.1	<i>Date/Time</i>	49
5.2.2	<i>System</i>	49
5.2.3	<i>Security</i>	51
5.2.4	<i>Well Setup</i>	52
5.2.5	<i>Inputs</i>	55
5.2.6	<i>Outputs</i>	60
5.2.7	<i>Alarms</i>	62
5.2.8	<i>Optimize</i>	62
5.2.9	<i>Modbus</i>	67
6	MODBUS COMMUNICATIONS	69
7	TROUBLESHOOTING	70

8	SUPPORT	72
8.1	SOFTWARE UPGRADE	72
8.1.1	<i>Prerequisites</i>	<i>72</i>
8.1.2	<i>Setup</i>	<i>72</i>
8.1.3	<i>Upgrade Procedure</i>	<i>72</i>
8.1.4	<i>Upgrade Errors.....</i>	<i>73</i>
8.2	REPLACEMENT PARTS AND ACCESSORIES	73
8.3	TECHNICAL SUPPORT.....	75
8.3.1	<i>Contacting Support</i>	<i>75</i>
8.3.2	<i>Identifying the Issue.....</i>	<i>75</i>
8.3.3	<i>Reporting Software Issues</i>	<i>76</i>
8.3.4	<i>Repair Process.....</i>	<i>76</i>
9	ACRONYMS.....	77
10	INDEX.....	78

Index of Tables

TABLE 1 - ELECTRICAL CONNECTIONS SUMMARY	6
TABLE 2 - PRESSURE OPTIMIZATION MODES	34
TABLE 3 - SETTINGS SCREENS	43
TABLE 4 – RISE TIME LOG SCREENS	46
TABLE 5 - CYCLE LOG SCREENS.....	46
TABLE 6 – DAILY HISTORY SCREENS	48
TABLE 7 – TOTAL STATISTICS SCREENS.....	48
TABLE 8 – PLUNGER STATISTICS SCREENS	49
TABLE 9 - DATE/TIME SCREENS	49
TABLE 10 - SYSTEM SCREENS	50
TABLE 11 - SECURITY SCREENS	51
TABLE 12 – WELL SETUP SCREENS	52
TABLE 13 - INPUTS SCREENS	56
TABLE 14 - OUTPUTS SCREENS	60
TABLE 15 - ALARMS SCREENS.....	62
TABLE 16 - OPTIMIZE SCREENS	63
TABLE 17 - MODBUS MENUS.....	67
TABLE 18 - TROUBLESHOOTING GUIDE.....	70
TABLE 19 - AVAILABLE REPLACEMENT PARTS AND ACCESSORIES.....	74

Table of Figures

FIGURE 1 - UNIVERSAL MOUNTING BRACKET	2
FIGURE 2 - VALVE SOLENOID.....	3
FIGURE 3 - MODEL 600 PHYSICAL CONNECTIONS	5

FIGURE 4 - MODEL 650 PHYSICAL CONNECTIONS	6
FIGURE 5 - SOLAR PANEL	8
FIGURE 6 - HAWKEYE™ IS	9
FIGURE 7 - SCREEN LAYOUT	11
FIGURE 8 – KEYPAD LAYOUT	13
FIGURE 9 - INSTALL MENU	15
FIGURE 10 – HOME SCREEN STRUCTURE	17
FIGURE 11 - STATUS SCREENS.....	18
FIGURE 12 - WELL INTERMITTING.....	20
FIGURE 13 - BASIC CONTROLLER STATES.....	20
FIGURE 14 – PLUNGER ARRIVAL SENSOR OPERATION	21
FIGURE 15 - CONTROLLER OPERATION WITH PLUNGER ARRIVAL SENSOR (PAS)	22
FIGURE 16 - NON-ARRIVAL	22
FIGURE 17 - FAST TRIP	23
FIGURE 18 - DANGEROUS TRIP	23
FIGURE 19 - TOP VALVE WELL CONFIGURATION	24
FIGURE 20 - TOP VALVE OPERATION	24
FIGURE 21 - FLOW TEE WELL CONFIGURATION	25
FIGURE 22 - FLOW TEE OPERATION	25
FIGURE 23 - TANK VALVE WELL CONFIGURATION	26
FIGURE 24 - TANK VALVE OPERATION	26
FIGURE 25 – FLOW CONTROL VALVE WELL CONFIGURATION	27
FIGURE 26 – FLOW CONTROL VALVE OPERATION.....	27
FIGURE 27 - PURGE VALVE OPERATION.....	28
FIGURE 28 – AUTO CATCHER CONFIGURATION	28
FIGURE 29 - USING LINE PRESSURE	29

FIGURE 30 - LINE PRESSURE CYCLE.....	29
FIGURE 31 - EARLY ARRIVAL.....	30
FIGURE 32 - LATE ARRIVAL	31
FIGURE 33 - PRESSURE BASED OPTIMIZATION.....	34
FIGURE 34 - EXTENDED AFTERFLOW OPTIMIZATION.....	36
FIGURE 35 - CASING PRESSURE CLOSE CYCLE	36
FIGURE 36 - OPEN CASING PRESSURE RESET POINT	37
FIGURE 37 - AFTERFLOW CASING PRESSURE	37
FIGURE 38 - CASING PRESSURE ABSOLUTE METHOD	38
FIGURE 39 - CASING PRESSURE RATE DROP METHOD.....	38
FIGURE 40 - OPEN CASING LINE DIFFERENTIAL TRIP	39
FIGURE 41 - LEVEL BASED VALVE OUTPUT.....	41
FIGURE 42 - PULSE TO OPEN OR CLOSE VALVE OUTPUT	41
FIGURE 43 - LEVEL BASED ALARM OUTPUT	42

1 Introduction

1.1 Purpose

This manual is intended to provide all of the information required to set up and operate the Model 600/Model 650 Plunger Lift Controllers. As well, it covers basic troubleshooting techniques and support information.

1.2 Overview

The Model 600/Model 650 Plunger Lift Controller is a versatile gas well controller that can be used in a number of different configurations. It can function as a simple intermitter or with a plunger and can optimize a well based on pressures or plunger arrival time/velocity. In addition, the controller can be accessed remotely using the provided Modbus compatible RS485 communications port.

1.3 Assumptions

The following assumptions have been made when writing this manual:

- The reader has some knowledge of the operation of a gas well.
- A controller or installed simulator is available as a reference while reading this manual.

2 Installation

2.1 Mounting

Each controller is supplied with a universal mounting bracket. This bracket is designed to keep the controller away from other surfaces so that the vent can be properly routed. As well, it provides a number of different mounting configurations to meet any application.

Simply mount the bracket to the desired surface securely and then attach the controller to the bracket. Studs have been pre-pressed into the four corners to make attaching the controller simple.

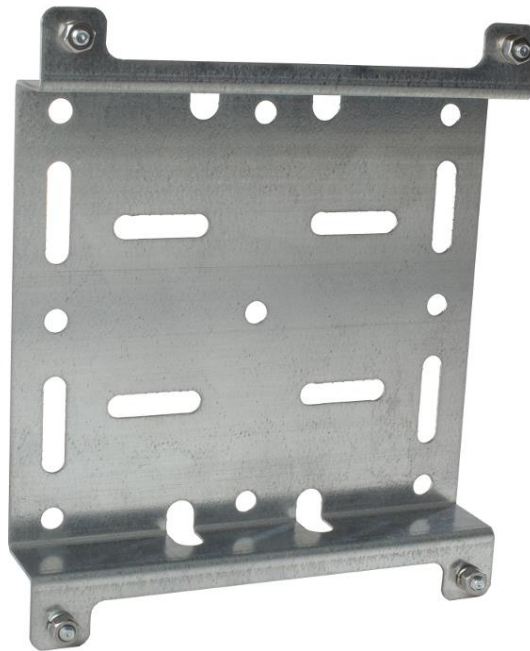

Figure 1 - Universal Mounting Bracket

2.1.1 Wall/Stud Mount

The universal mounting bracket includes nine holes that can be used for mounting to a wall or stud. To mount to a vertical stud, simply use three of the vertically aligned holes. For mounting to a horizontal stud, use one of the three horizontally aligned holes.

2.1.2 Pipe Mount

The long slots that run horizontally are intended for mounting to a vertical pipe, while the vertical slots are intended for mounting to a horizontal pipe. Use the appropriate set of slots to secure the mounting bracket with U-bolts/pipe clamps.

2.1.3 Valve Mount

Wider, shorter slots are provided along the bend to allow the bracket to be secured to a pneumatic valve. Simply remove 2 adjacent bolts from the top of the valve. Place the bracket over the holes and push the bolts through the bracket and valve, fastening them again.

2.2 Gas Connections

Each solenoid has 3 different connections which must be connected properly in order for the controller to operate the valve.

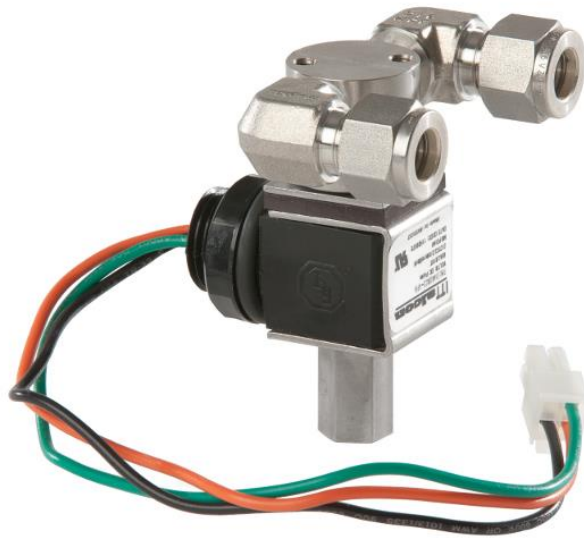

Figure 2 - Valve Solenoid

2.2.1 Supply

The supply side of the solenoid can be identified by the “IN” marking that is stamped on the body. A 90 degree elbow has been pre-installed to make it easier to terminate in the field.

Clean supply gas must be supplied in order to operate the valve. The solenoid is designed to work up to 60 psi, but will operate at lower pressures.

Dual valve assemblies are constructed so that the supply ports of the two solenoids are facing towards each other and are attached with a tee. Although two separate solenoids will perform the same function, a single supply connection makes installation simpler.

2.2.2 Valve

The valve side of the solenoid can be identified by the “CYL” marking that is stamped on the body. A 90 degree elbow has been pre-installed to make it easier to terminate in the field.

2.2.3 Vent

The vent faces towards the back of the enclosure and is threaded so that the appropriate fittings can be attached. The vent should be routed according to the appropriate local regulations.

2.3 Grounding

The controller is designed so that the circuit board is isolated from the enclosure and mounting hardware. This allows stray voltages to be routed away from the electronics through a ground point. If connected correctly, there is less chance of damage to the controller in the event of an electrical disruption.

A ground lug is provided on the bottom left corner of the enclosure. It is designed to fit up to 4 AWG wire. The enclosure should be grounded according to the appropriate local regulations.

2.4 Electrical Connections

The following is an outline of the locations that devices can be wired to. All connected devices must meet the entity parameters found in the ET-12001-1012-0000 Control Drawing.

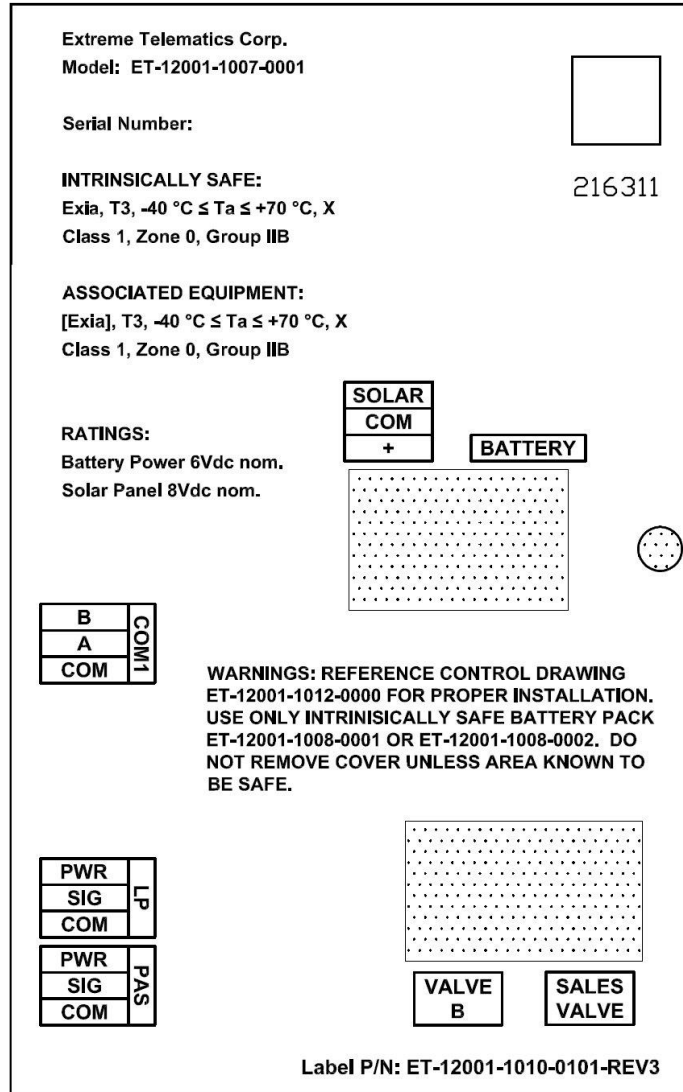

Figure 3 - Model 600 Physical Connections

The Model 600 model is limited to a maximum of 2 solenoids and has support for a Plunger Arrival Sensor (PAS), Line Pressure (LP), and Modbus Communications (COM1).

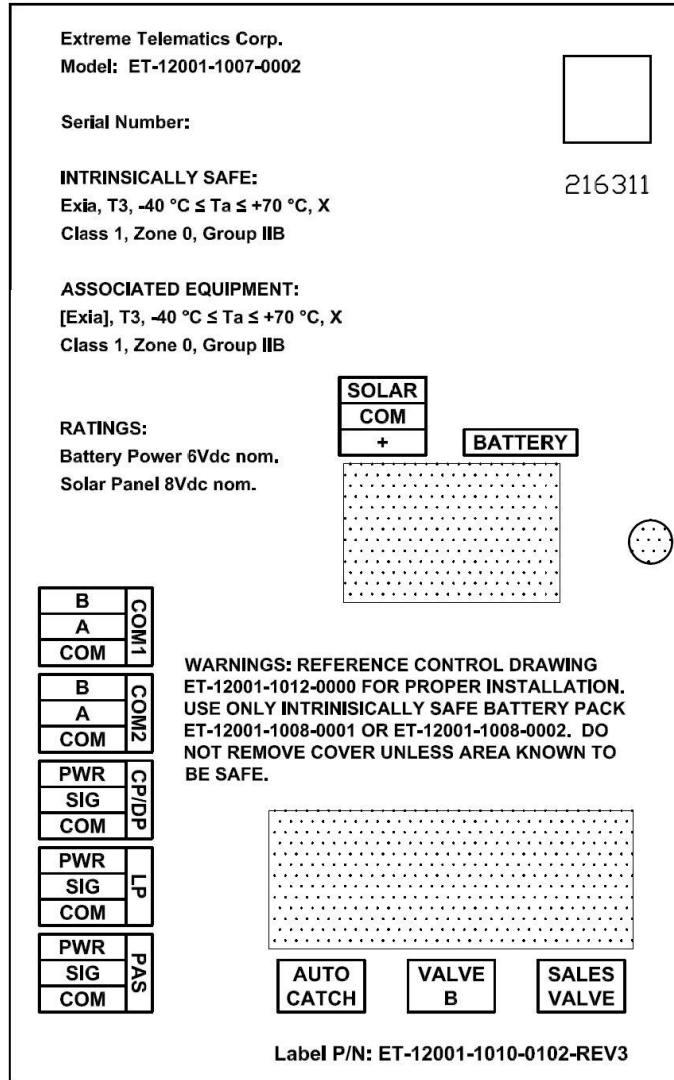

Figure 4 - Model 650 Physical Connections

The Model 650 has all of the same features, but includes support for an additional solenoid (AUTO CATCH), Casing Pressure or Differential Pressure (CP/DP) and additional Modbus Communication features (COM2).

The following table outlines all of the available connections for both models of controllers.

Table 1 - Electrical Connections Summary

Location	Devices To Connect	Description
Solar	Solar Panel	Use only an approved 1.1 W Solar Panel

Location	Devices To Connect	Description
Battery	6 V Battery	Use only an approved 6 V intrinsically safe battery.
Sales Valve	Sales Valve Solenoid	Use only an approved intrinsically safe solenoid.
Valve B	Valve B Solenoid	Use only an approved intrinsically safe solenoid.
Auto Catch	Auto Catch Solenoid	Use only an approved intrinsically safe solenoid.
PAS	Plunger Arrival Sensor	Connect signal and ground of a 2 or 3 wire plunger arrival sensor.
LP	Line Pressure Switch/Sensor	Connect a 2 wire switch to COM/SIG or a 3 wire sensor to all three connections to use line pressure features.
CP/DP	Casing Pressure/ Differential Pressure Switch/Sensor	Connect a 2 wire switch to COM/SIG or a 3 wire sensor to all three connections to use EITHER casing pressure OR differential pressure features.
COM 1	Differential RS485 device	Modbus slave connection Upgrade Port
COM 2	Differential RS485 device	Modbus master connection

2.4.1 Solar Panel

The solar panel is optional, but will ensure that the battery is topped up and that operation of the controller is not interrupted due to a low battery condition.

1. Install the solar panel in a location where it will face the sun throughout the day.
2. Connect a pair of wires to the terminals on the solar panel.

3. Connect the other end of the pair so that the minus (-) terminal on the solar panel is connected to the SOLAR COM input on the controller. Likewise, the plus (+) terminal on the solar panel must be connected to the SOLAR + input on the controller.



Figure 5 - Solar Panel

Warning: Only approved solar panels can be used with this controller. Panels that operate at higher voltages or current are unsafe and cannot be used. Please refer to section 8.2 Replacement Parts and Accessories for a full list of approved parts.

2.4.2 Battery

Each controller is shipped with the battery disconnected to save the life of the battery and ensure that the product has enough energy to operate before requiring solar charge. Simply plug the pre-installed battery connector into the spot marked BATTERY. The connector is not field replaceable as it requires a special tool.

Warning: Only approved batteries can be used with this controller. Protective components must never be bypassed as it is unsafe to do so. Please refer to section 8.2 Replacement Parts and Accessories for a full list of approved parts.

2.4.3 Solenoids

Each solenoid is supplied with a pre-installed connector. The connector is not field replaceable as it requires a special tool.

Press each solenoid connector into one of Sales Valve, Valve B, or Auto Catch until you hear it click. Every solenoid is the same, so it does not matter which one is plugged into a particular socket.

Warning: Only approved solenoids can be used with this controller. Using any other solenoid or extending the solenoid wires is unsafe. Please refer to section 8.2 Replacement Parts and Accessories for a full list of approved parts.

2.4.4 Plunger Arrival Sensor

The plunger arrival sensor connection has an unregulated power output that will be related to the battery voltage. As such, it cannot be used with any device that requires exactly 5V. It is recommended that Hawkeye™ IS is used, but most 2 and 3 wire plunger arrival sensors are supported.



Figure 6 - Hawkeye™ IS

If using a 3 wire plunger arrival sensor, connect power, signal and common to the appropriate connections on the terminal block. If using a 2 wire sensor, the power connection is omitted.

2.4.5 Pressure Inputs

Depending on the model, the controller comes with either one (Line) or two (Line and Casing /Differential) pressure inputs. These inputs are physically the same and support either two or three wire devices. Two wire devices only use the COM and SIG inputs, while three wire devices make use of the PWR output as well.

The PWR output will provide a regulated 5 V output that is used to power the attached device. This output is only turned on for a short duration while the sensor is being sampled, so measuring the power is not possible. As well, the SIG input is expecting to see an input of 0.5 – 4.5 V, which is translated to the appropriate value by the controller.

2.4.6 Digital Outputs

The digital output functionality is overlaid on the pressure inputs. To use the digital outputs, simply use the PWR and COM connections of a pressure input block when not in use by another

device. The output must be enabled in the outputs menu in the controller and the software will determine when to set the output to 5V or ground.

2.4.7 COM Ports

Each controller is equipped with at least one communications (COM) port. Both COM ports are designed to communicate with Modbus devices.

COM1 is disabled by default, but operates as a Modbus Slave when enabled. When enabled, all of the communication settings for this port are made visible and can be configured by the installer. In general, the communication settings must be configured to match the settings of the Modbus Master. This will allow the master to poll the controller as a slave to retrieve operational data. As well, the master may also write data to the controller to change settings or to change the controller's state.

COM2 functions as a Modbus Master and communicates with downstream devices. It can be used to retrieve pressure or flow readings, communicate with Modbus enabled plunger arrival sensors, or pass data through to a downstream controller.

Please refer to your local regulations to determine if an intrinsic safety barrier is required. This typically is the case if the communications modem is located in a less hazardous area.

3 Controller Overview

3.1 Start Up

On power up, the controller is initialized by performing the following operations:

- Load all previously saved values
- Close all valves
- Turn on the display
- Set the display to show the current controller state as the latest device status information.

The controller automatically enters the Close state when powering up and begins counting down.

3.2 Display

A Vacuum Fluorescent Display (VFD) is provided which consists of 2 lines x 16 characters. Each character is a 5x7 dot matrix with a full underline bar. The display is partitioned into 2 areas with an unused column between them for spacing.

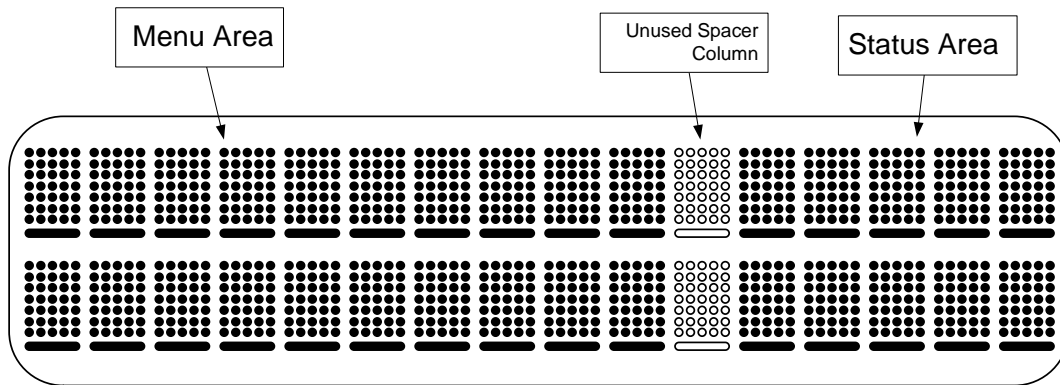

Figure 7 - Screen Layout

3.2.1 Menu Area

The content of the *Menu Area* (2 x 10 characters) shows the current state of the controller on start up. This area will change based on user keypad interaction. The current state information as well as the setup menu is available in this area.

3.2.2 Status Area

The *Status Area* (2 x 5 characters) constantly rotates through all enabled inputs and outputs. By default, this includes the battery voltage as well as the state of The Sales Valve. As other

options are enabled on the controller, additional information becomes available in this same area. For example, Valve B will be displayed if it has been enabled. If pressure devices such as line pressure and casing pressure are enabled, their current value will also be displayed.

3.2.3 Automatic Shut Off

To conserve power, the display will automatically go to sleep if a key press has not been detected in the previous 30 seconds. This time can be modified by the user.

3.2.4 Automatic Log Out

If security is enabled, the active user will be automatically logged out if a key press has not been detected in the previous 10 minutes. This time can be modified by the user.

3.3 Keypad

An integrated keypad is included which allows the user to change settings, navigate through history, and control the well. Both models utilize the same keypad layout and functionality. The following sections discuss the various keys that are available.

The navigation and numeric keys are overlapped to provide both sets of functionality on fewer keys. The controller automatically knows what function to use based on the current controller display. When in the menus, the arrow keys are used. When editing a numeric screen, the same keys are interpreted as their numerical equivalent.

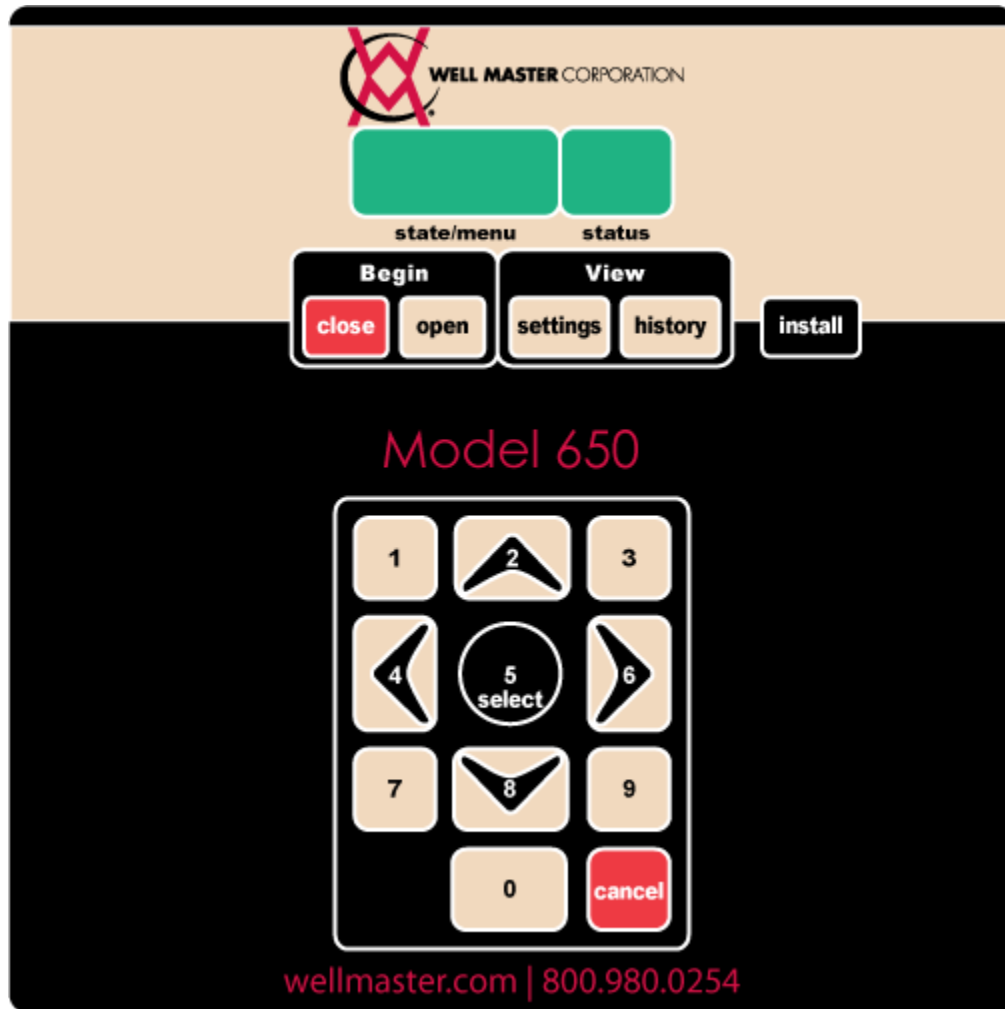

Figure 8 – Keypad Layout

3.3.1 Navigation Keys

The navigation keys are used to move through the menus in the controller and select items from lists.

3.3.1.1 Select

Select is used to enter a sub-menu, select a field to be edited, or save changes made while editing a field.

3.3.1.2 Cancel

Cancel is used to back up through the menu levels or to cancel editing a value.

3.3.1.3 Arrow Keys

The arrow keys allow the user to move up/down and left/right in the menu. If the display is on a line that has a sub menu associated with it, pressing "Right" will enter the sub menu.

Conversely, pressing the "Left" arrow will go back one level of menu depth. If a field can be edited the "Right" arrow will put the controller into edit mode.

If a numeric value is being edited, the arrow keys will act as their numeric value instead.

3.3.2 Numeric Keys

The numeric keys are used to input new values for numeric fields. Examples include entering new times and or setting numeric values such as Fast Trip Count. If a numeric field is not currently being edited, then the number keys are ignored.

3.3.3 Hot Keys

The hot keys are provided to take the user to special menus or provide instant action.

3.3.3.1 Close

Pressing *close* will send the controller to the close state, closing all valves.

3.3.3.2 Open

Pressing *open* will send the controller to the open portion of the cycle. The action that is taken depends on the number of valves configured, how they are set to operate, and if there are any special checks required, such as casing and/or line pressure. The normal mode of operation is to go to Rise, which opens The Sales Valve and waits for a plunger arrival to occur.

3.3.3.3 Settings

The *settings* key navigates to a special menu that contains all of the timers that are used by the controller as well as the set points for pressure devices.

More details can be seen about the settings menu, which is detailed below.

3.3.3.4 History

The *history* key navigates to a special menu that shows information about the recent operation of the well. This information is broken into plunger rise time (Rise Time), plunger cycle information (Cycle Log), daily production information (Daily), total production statistics (Total), and plunger statistics (Plunger).

More details can be seen about the history menu in section 5.1.1 Install

The *install* key navigates to the install menu. The user may be required to login if that option has been enabled. The default login is 000-0000. Once logged in, a number of sub menus are available.

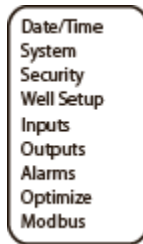

Figure 9 - Install Menu

3.3.3.5 *More details are available in section 5.1.2.3 Daily*

The controller maintains daily production statistics which are written to persistent memory when the current time-of-day passes the *Day Start* parameter. The following information is available in the Daily History menu:

Table 6 – Daily History Screens

Screen	Description
<i>Date and Total Cycles</i>	Shows the date for the given history record as well as the total number of cycles that occurred during that day.
<i>Open/Close Time</i>	Displays the total time that the well has been open and the total time the well has been closed for the day.
<i>Vent Time</i>	Displays the total amount of vent time for the day.
<i>Volume</i>	This shows the total volume for the given day. This is represented as e ³ m ³ .
<i>Cycle Counts</i>	There are a number of screens that are used to display all of the cycle types for the current day.
<i>Reset Log?</i>	This clears all of the daily log data.
<i>Day Start</i>	This defines the gas day cut off. When the controller passes this time each day, the history for the current day will stop and a new day will start.

3.3.3.6 *Total*

The controller maintains total production statistics which continually increases until the log is reset. The following information is available in the Total History menu:

Table 7 – Total Statistics Screens

Screen	Description
<i>Open/Close Time</i>	Displays the total time that the well has been open and the total time the well has been closed.
<i>Vent Time</i>	Displays the total amount of vent time.
<i>Volume</i>	This shows the total volume. This is represented as e ³ m ³ .
<i>Cycle Counts</i>	There are a number of screens that are used to display all of the cycle types.
<i>Reset Time</i>	Shows the time that the total statistics were last reset.
<i>Reset Log?</i>	This clears all of the total statistics data.

3.3.3.7 Plunger

The controller maintains total plunger statistics which continually increases until the log is reset. The following information is available in the Daily History menu:

Table 8 – Plunger Statistics Screens

Screen	Description
<i>Travel Distance</i>	Total distance that the plunger has travelled since the last reset.
<i>Plunger Arrivals</i>	Total number of plunger arrivals since the last reset.
<i>Reset Time</i>	Shows the time that the plunger statistics were last reset.
<i>Reset Log?</i>	This clears all of the daily log data.

Install Menu.

3.4 Home Screen

As soon as the controller powers on, if the user presses close/open, or if the user presses cancel to back out of the menus, the home screen will appear on the display. By default, this shows the current state of the controller and the time remaining until it switches state. As well, there are a number of screens available at this same level that show more detailed information

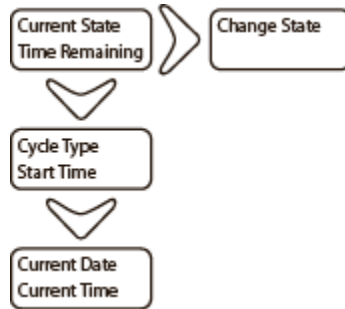

Figure 10 – Home Screen Structure

Scrolling down from the home screen will take you through a number of other screens. Information such as the cycle type, start time, and the current date/time are displayed here. Pressing select or the right arrow will take you to a screen that allows you to force the controller to change states.

3.4.1 Current State

This screen is shown by default when the controller is powered up. It shows the current part of the cycle that the controller and a timer that indicates when the state will change.

3.4.2 Cycle Information

This screen shows the information for the last cycle. This includes the type of cycle (Ok, Fast Trip, Non Arrival, etc...) as well as the time that the cycle started.

3.4.3 Current Date/Time

This screen simply shows the current date and time. If this information is incorrect, the user must login and change the date and time in the Date/Time menu. The date and time is reset back to January 1, 2000 when the battery is disconnected.

3.4.4 Change State

The controller can be manually forced into the Afterflow, Rise, or Close states by performing a manual state change. The controller will enter the selected state for a length of time set by the user in this screen.

3.5 Status Screens

When active, the display will automatically update the status area on the right hand side of the display. The information shown is a summary of the current operation of the controller.

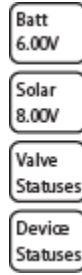

Figure 11 - Status Screens

3.5.1 Battery Status

This screen shows the current battery voltage with the solar charger disconnected so that it does not influence the reading. A battery level indicator is also shown in the top right hand corner to show how full the battery is. If the battery is currently being charged, a lightning bolt is shown instead of the battery indicator.

3.5.2 Solar Status

This shows the current voltage as seen on the solar panel input. The charger is disconnected during this reading so that it is not influenced by the battery/

3.5.3 Valve Status

Each enabled valve is shown on these screens. The screen shows whether the valve is currently open or closed.

3.5.4 Device Status

Each enabled device such as Line Pressure, Casing Pressure, etc... is shown on its own screen. The current value of the last reading is displayed. Please be aware that this may not be updated as soon as a change is made. Enabling some devices may not take effect until the next cycle starts. This can be achieved by pressing open or repowering the controller.

4 Controller Operation

The controller configuration can be accessed in two different ways:

- Through the menu using the display and keypad
- Using Modbus over the RS485 communications port.

The Model 600/Model 650 Modbus Communications User's Guide discusses everything from physical connection to data format and access. As such, the Modbus communications interface will not be discussed further in this manual.

When the controller starts up, all valves are closed and the controller is put into the Close state. The close timer starts decrementing. Once this timer has expired, the controller decides what action to take based on the controller configuration.

4.1 Battery Monitor

The controller samples the battery every 10 minutes, monitoring the voltage in order to prevent unpredictable valve operation. The battery voltage is reported as one of the following:

- *Normal*: The controller behaves normally. If 6 successive battery samples are below 5.5 V, the controller closes all valves and enters the *Low* state. A low battery alarm condition is recorded, which is reported in the history.
- *Low*: If 6 successive samples are above 6.0 V, the controller enters the *Normal* state. When entering the *Normal* state, the controller will restart to the *Close* state for a duration specified by the *Close Time* parameter.

During power on or reset, and before any valves are opened, the battery voltage is sampled. The *Normal* or *Low* state is entered based upon this sample.

4.1.1 Low Battery

The controller is designed to handle a number of failure conditions, most of which have already been discussed. If the controller senses that the battery is low, it will take action to ensure that the valve(s) are left in a known state. When a low battery condition has occurred, the controller will actuate the valve(s) and go into the Stopped state. The controller will remain in this state until the battery has recovered or an operator has intervened.

The state that the valve is placed in when a low battery condition occurs is based on the *Low Battery Fail Mode* parameter that is found in the Alarms menu.

4.2 Controller Configurations

The following sections describe the various ways that the controller can be configured. The configuration may be changed by modifying the parameters that are available through the user interface screens outlined in the preceding sections.

4.2.1 Intermitting

The controller is designed to act as a well intermitter in the most basic configuration. In this case, a plunger is not present in the well.

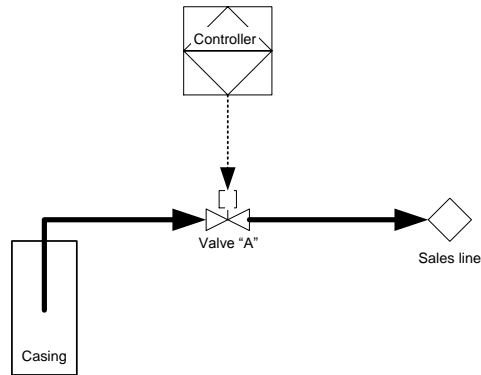

Figure 12 - Well Intermitting

In this configuration, Valve A is opened and closed based on a simple timer setup. The *Close Time* and *Afterflow Time* are used to determine when to open and close the well. The Arrival Sensor Device Type must be Disabled for the controller to act as a simple well intermitter.

At the start of the cycle, Valve A is closed and the Close Time is started. When the Close Time expires the controller moves to Afterflow and the Afterflow Time is started. Once this timer expires, the controller moves back to Close and the valve is closed, restarting the cycle.

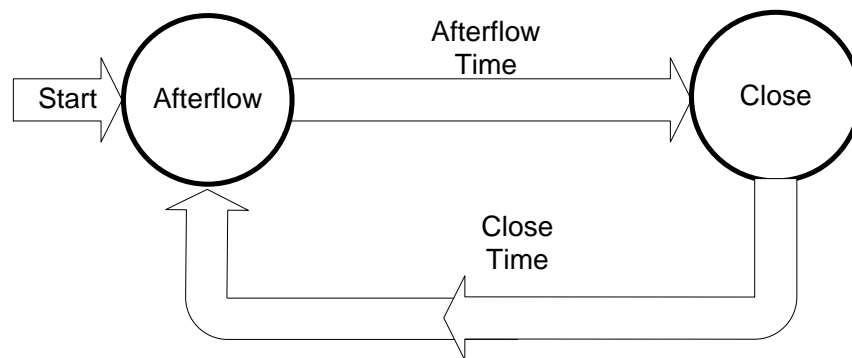

Figure 13 - Basic Controller States

4.2.2 Plunger Arrival Sensor (PAS)

The plunger lift controller is designed to operate primarily in the following plunger lift configuration:

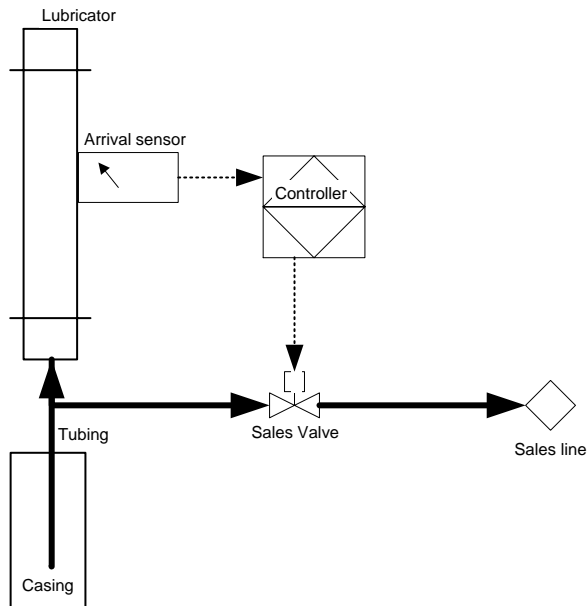

Figure 14 – Plunger Arrival Sensor Operation

In this application, a plunger travels between the bottom of the well tubing and the lubricator. The purpose of the plunger is to lift fluids which accumulate at the bottom of the well tubing. The lubricator acts as a trap for the plunger when it arrives at the surface and is fitted with a *Plunger Arrival Sensor*. The *Arrival Sensor* acts as a switch, closing its contacts as the plunger arrives.

When the valve is closed, the plunger falls to the bottom of the well tubing. After the expiry of the *Close Time*, the Sales Valve is opened, and the pressure in the gas formation drives the plunger and any accumulated fluids to the top of the well tubing. As the plunger arrives, the controller transitions to Afterflow. On expiry of the *Afterflow Time*, the Sales Valve is closed and the cycle repeats.

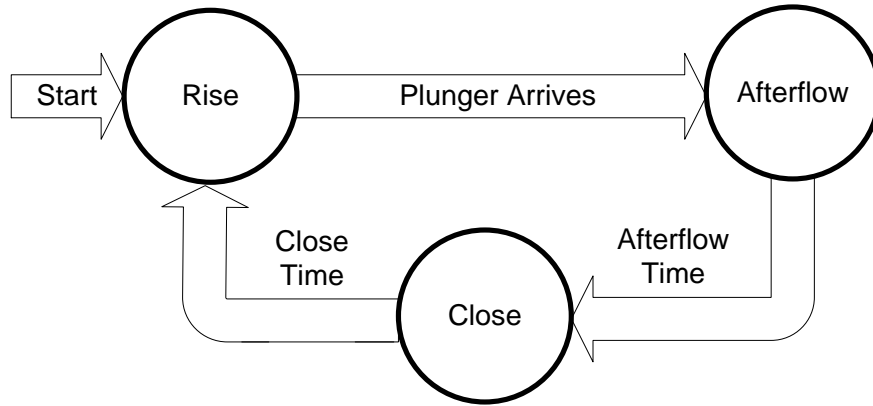

Figure 15 - Controller Operation with Plunger Arrival Sensor (PAS)

4.2.2.1 Non-Arrival

If the plunger fails to arrive within the *Rise Time*, a non-arrival cycle is recorded. In this case, The Sales Valve is closed for an extended amount of time (*Non-Arrival Close Time*). After a pre-determined number of *Non-Arrivals*, defined in the Alarms menu, the controller will move to the Stopped state and wait for operator intervention.

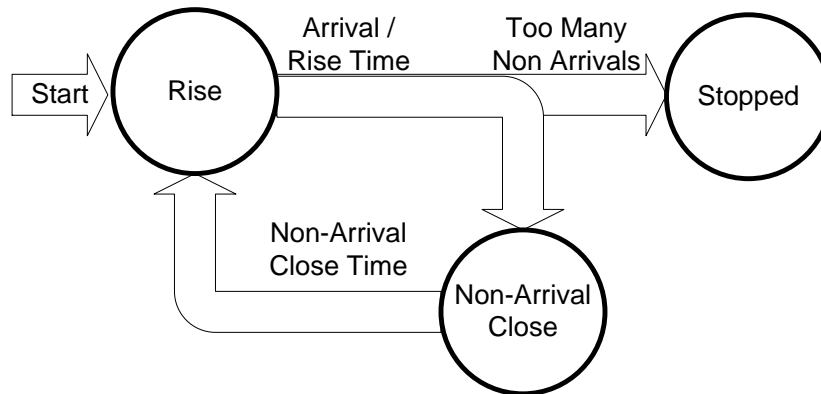

Figure 16 - Non-Arrival

4.2.2.2 Fast-Trip

If the plunger arrives within the *Fast-Trip Time*, a fast-trip cycle is declared. This may occur if the plunger did not fall to the bottom of the well during the Close portion of the last cycle and the plunger returns to the surface dry. When a fast trip occurs, the controller proceeds to the Afterflow portion of the cycle. After a predetermined number of fast trip occurrences, the controller will move to the Stopped state and wait for operator intervention to protect the well.

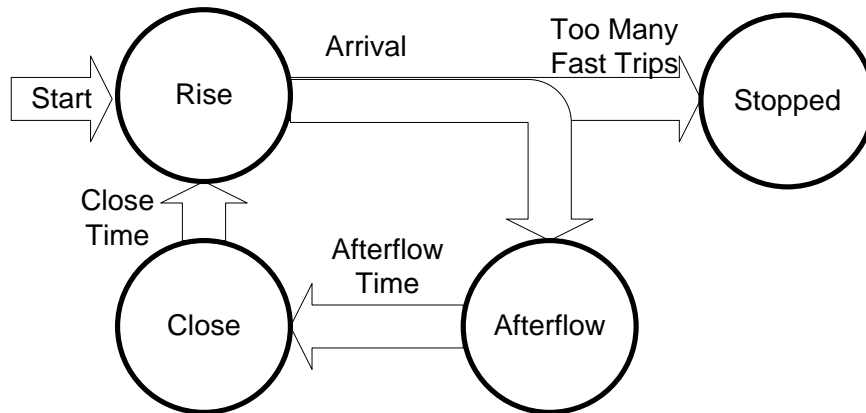

Figure 17 - Fast Trip

4.2.2.3 Danger Trip

If the plunger arrives within the *Danger Time*, a danger trip cycle is declared. This may occur if the plunger did not fall to the bottom of the well during the Close portion of the last cycle and the plunger returns to the surface dry. This time is set to correspond to an extremely fast plunger that has the potential to damage the spring with a single impact. When a dangerous trip occurs, the controller proceeds immediately to the Stopped state and waits for operator intervention to protect the well.

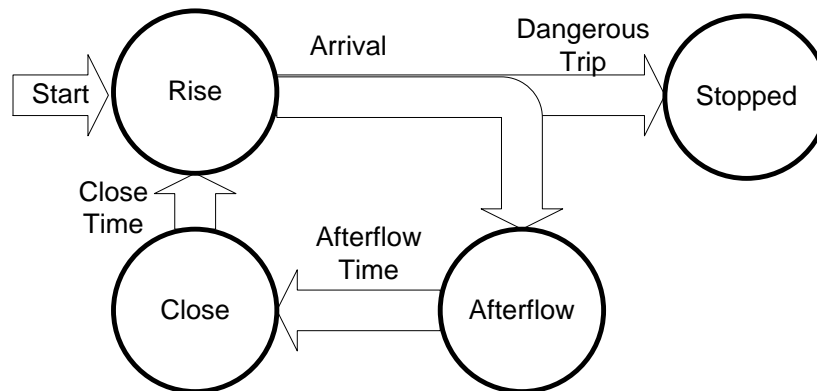

Figure 18 - Dangerous Trip

4.2.2.4 PAS Delay

Some manufacturers of plunger arrival sensors will close their switch contacts on power up. Setting a *PAS Delay Time* allows the controller to ignore this glitch.

This may also be used when the *Close Time* is short when using a continuous or free cycle plunger. This allows time for the plunger to leave the lubricator and the movement of the internal parts to settle before looking at the plunger arrival sensor output.

4.2.3 Valve B

The well may also be equipped with a second valve (Valve B). This valve may be installed in one of 5 configurations. These configurations are illustrated and described below.

4.2.3.1 Top Valve

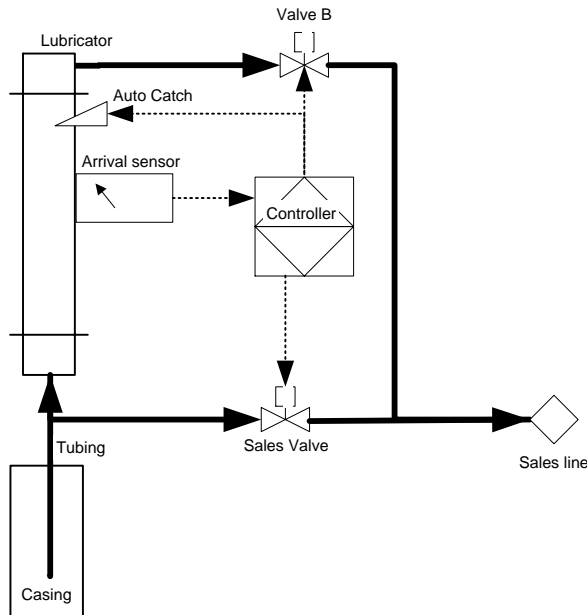

Figure 19 - Top Valve Well Configuration

The *Valve B Type* must be set to line and the *Afterflow Valve Configuration* must be set to Sales in order to operate the controller in a Top Valve configuration.

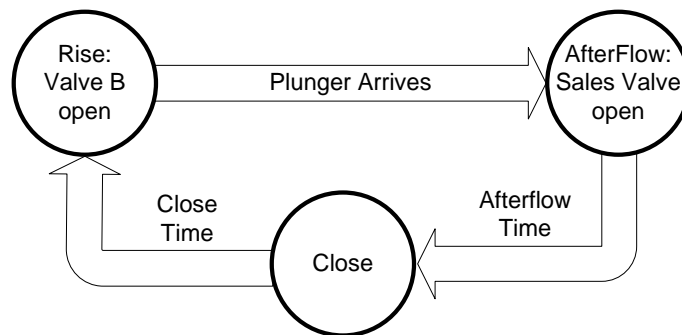

Figure 20 - Top Valve Operation

During the Rise portion of the cycle, Valve B is open and The Sales Valve is closed. The location of Valve B is such that the plunger will be driven fully into the lubricator upon arrival without

requiring excessive (i.e. sub-optimal) velocity. A short time after the plunger arrival, The Sales Valve is opened and Valve B is closed. The location of The Sales Valve causes the Plunger to be held within the Lubricator while gas is flowing with sufficient pressure. In this configuration, the well may be equipped with an auto catch which is driven from the Valve B gas supply line.

4.2.3.2 Flow Tee

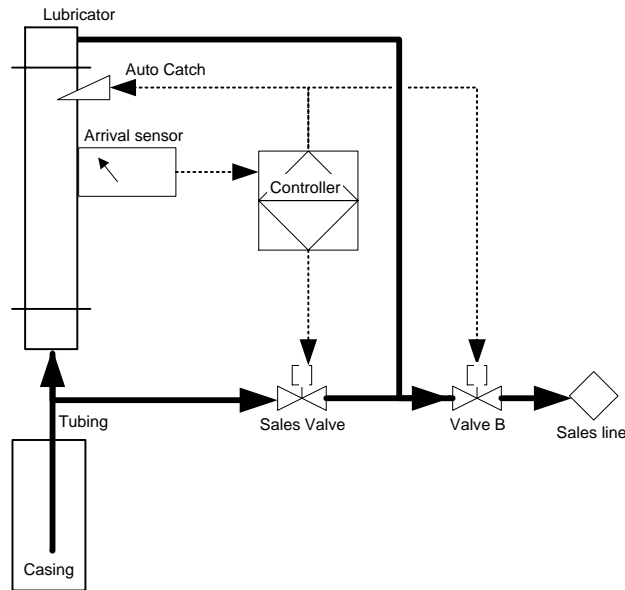

Figure 21 - Flow Tee Well Configuration

The Top Valve configuration has the disadvantage of requiring that a valve gas control line be installed between the separator shack and well-head. To avoid this, a Flow Tee configuration is often used. Operation is the same as for the Top valve except that, in the Afterflow portion of the cycle, both valves are left open.

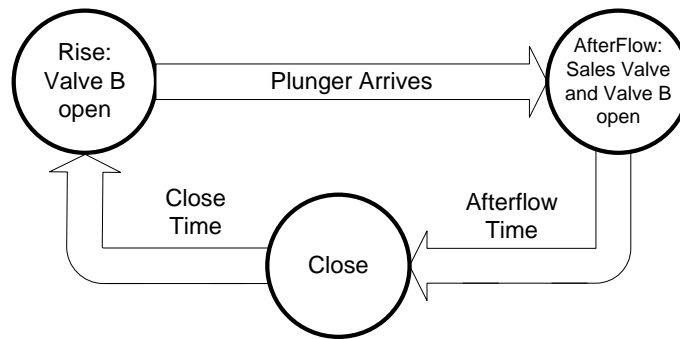

Figure 22 - Flow Tee Operation

To achieve this configuration, the *Valve B Type* must be set to line and the *Afterflow Valve Configuration* must be set to Sales/B.

4.2.3.3 Tank Valve

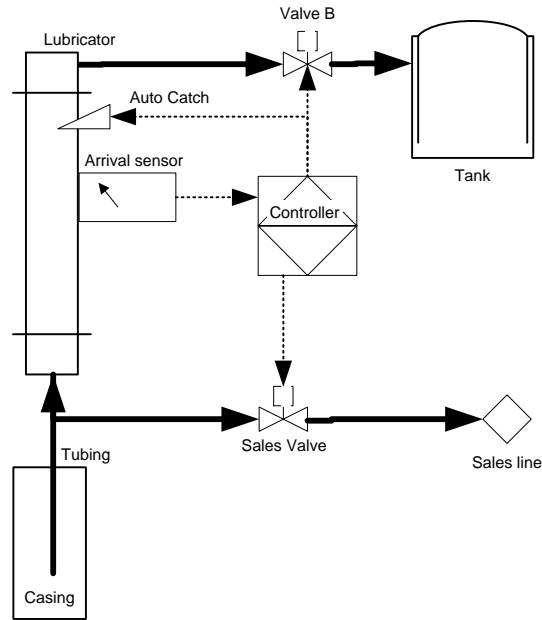

Figure 23 - Tank Valve Well Configuration

If Valve B is connected to a Tank, The Sales Valve is opened at the start of the Rise portion of the cycle. If the plunger does not arrive within a specified time, then the valves are toggled (i.e. simultaneously open Valve B and close the Sales Valve). When the plunger arrives, the valves may be toggled again. The purpose of the tank is to assist in plunger lift by exerting less back pressure on the well tubing than that exerted from the sales Line.

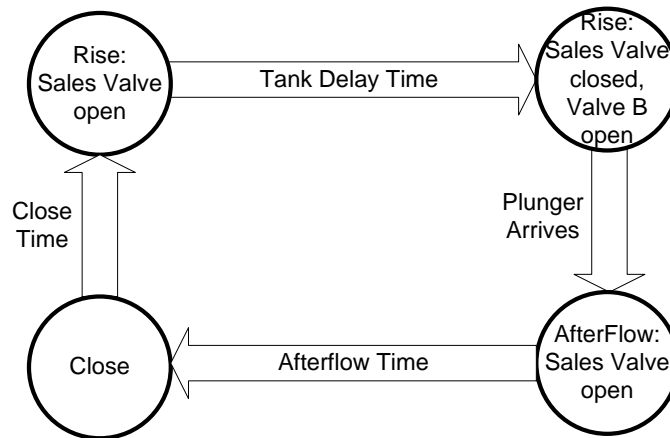

Figure 24 - Tank Valve Operation

4.2.3.4 *Flow Control Valve*

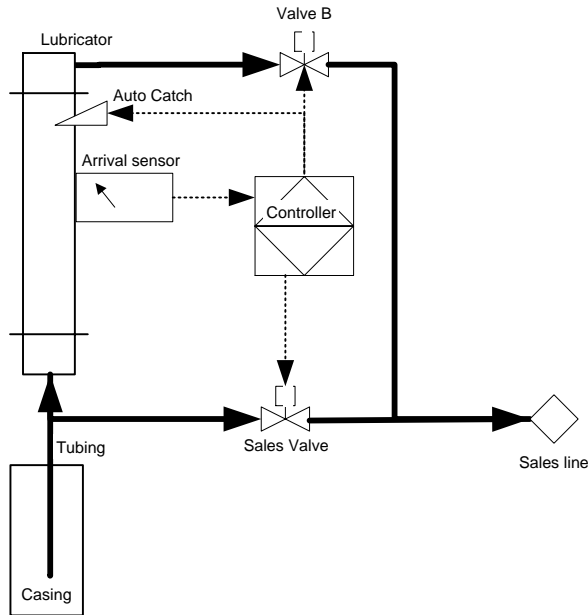

Figure 25 – Flow Control Valve Well Configuration

This mode of operation allows the well to flow through 2 ports of the lubricator during the Rise portion of the cycle. Once the plunger has arrived, Valve B is closed and the well continues to flow through the sales valve.

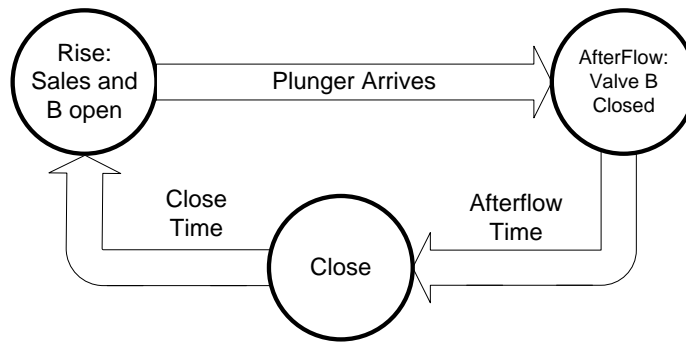

Figure 26 – Flow Control Valve Operation

4.2.3.5 *Purge Valve*

The purge valve option allows the well to be purged through Valve B just prior to the opening of the Sales Valve and the start of Rise. A configurable Purge Time sets how before the start of Rise that Valve B is opened.

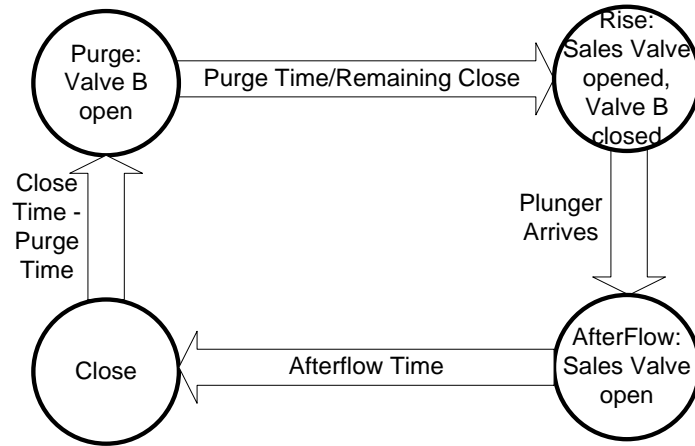

Figure 27 - Purge Valve Operation

4.2.4 Auto Catcher

The lubricator may be fitted with an auto catcher that allows the plunger to be held at surface during the Afterflow portion of the cycle. The auto catcher can be engaged either at the start of Rise or once the plunger arrival is detected to prevent the damage caused by repeated impacts from the plunger. Also, the auto catcher may be released sometime after the well is closed by setting the Auto Catcher Hold Time.

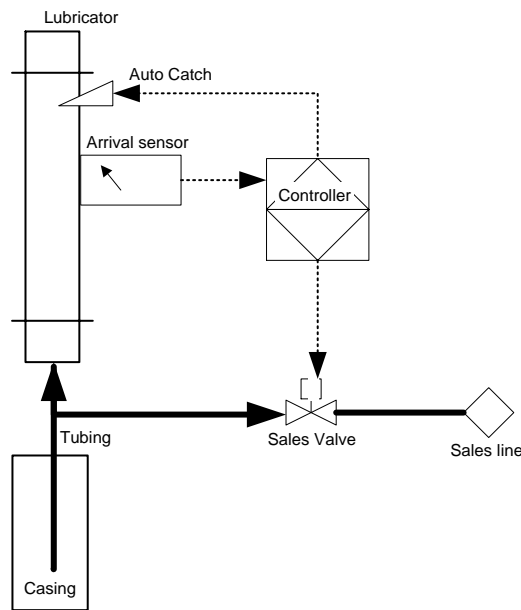

Figure 28 – Auto Catcher Configuration

4.2.5 Line Pressure

The well may be equipped with a line pressure switch or sensor. This device is configured to be “tripped” when the pressure in the sales line exceeds a pre-determined threshold.

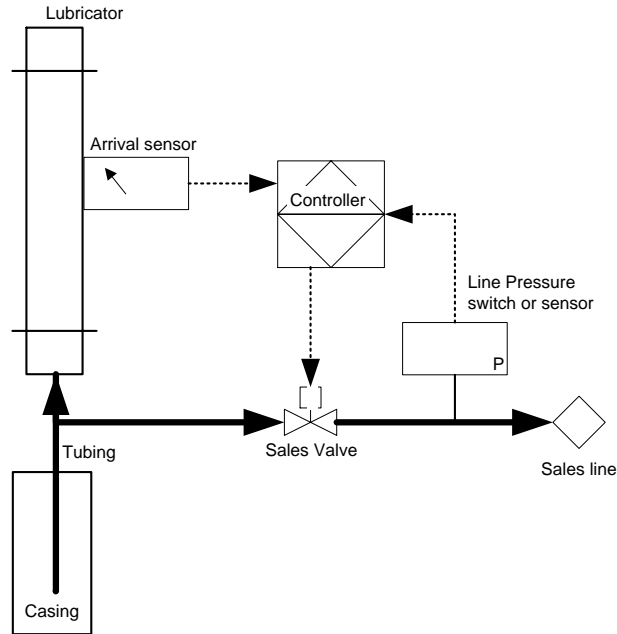

Figure 29 - Using Line Pressure

The controller monitors the state of the switch just before the Rise portion of the cycle. The cycle is delayed if the pressure is high. It is also monitored during the Afterflow portion of the cycle. The well is shut-in if the pressure is high.

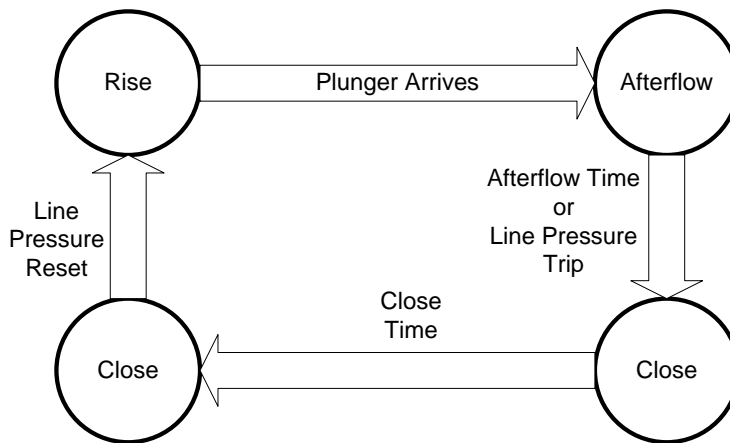

Figure 30 - Line Pressure Cycle

4.2.6 Timer/Velocity Optimization

The goal of timer based optimization is to get the plunger to arrive exactly at a desired or Target Rise Time. Adjustments are made to either the Afterflow or Close Time on each arrival at the plunger. The algorithm is proportional meaning that a small miss will result in a small change or no change at all, while a large miss will result in a much larger change.

4.2.6.1 Principle of Operation

With each arrival of the plunger, the time it takes to come to surface (Actual Rise Time) is compared to the Target Rise Time and is used to calculate the adjustment. The aggressiveness of the algorithm can be controlled by changing the Scale Factor. There are two different algorithms that allow the operator to select what times the adjustments are based on, either the difference between the minimum and maximum times or the current time.

Whether the plunger arrives early or late, they are treated in the same manner and the same calculation is used. An early arrival occurs when the plunger arrives before the Target Rise.

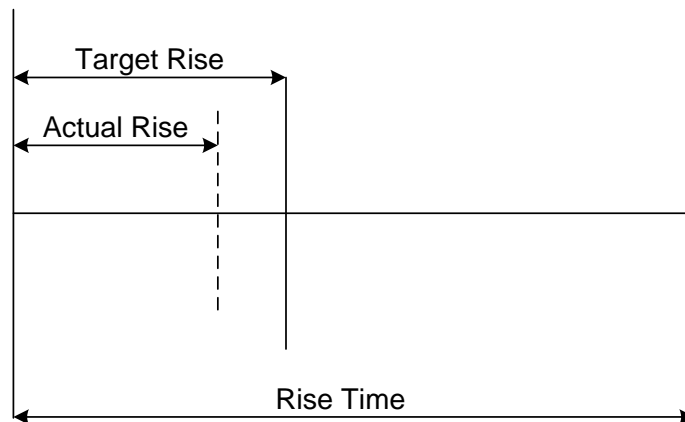

Figure 31 - Early Arrival

A late arrival occurs when the plunger arrives after the Target Rise.

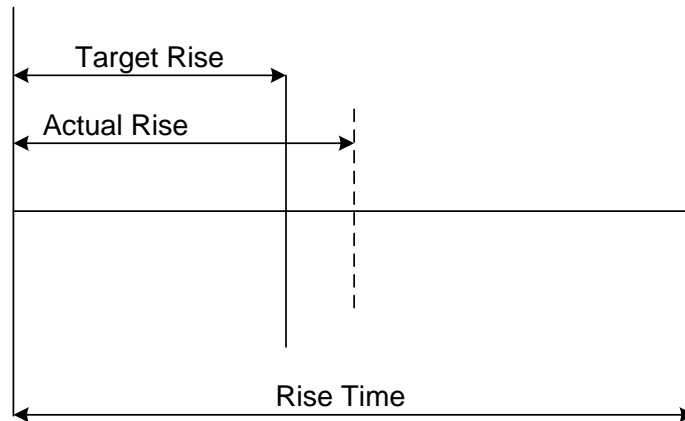

Figure 32 - Late Arrival

4.2.6.1.1 Max - Min Optimization

This optimization is selected by default. It uses the difference between the minimum and maximum parameters to determine the size of the changes that will be applied. The drawback to this algorithm is that if the difference between the minimum and maximum is large, the changes can be quite large. To protect against very large changes, the default Scale Factor is set to 1% and is limited to a maximum of 15%. The minimum and maximum parameters may need to be modified as well conditions change to ensure that the changes are not too large.

To determine changes to the Afterflow Time, the following formula is used:

$$\Delta Afterflow = \frac{TargetRise - ActualRise}{TargetRise} \times ScaleFactor_{AF} \times [Max_{AF} - Min_{AF}]$$

The same formula is used for close, but the Close Scale Factor, Minimum Close Time and Maximum Close Time are used instead.

$$\Delta Close = \frac{TargetRise - ActualRise}{TargetRise} \times ScaleFactor_{CL} \times [Max_{CL} - Min_{CL}]$$

As you can see, in either case, the larger the difference between the Actual Rise Time and Target Rise Time, the larger the response will be. The Scale Factor reduces the magnitude of the change. Finally, the result is multiplied by the difference in the maximum and minimum times.

4.2.6.1.2 Current Time Optimization

The current time optimization does not use the minimum and maximum parameters. They simply serve as boundaries, meaning they can be set to appropriate long term values and will not need to be changed regularly.

In this case, the magnitude of the change is dictated by the current Afterflow Time or Close Time, meaning that the operator does not have to be as concerned that large changes will be made to a time that is currently very small. For this reason, the default Scale Factor is 10% and is allowed to be set up to a maximum of 100%.

To determine changes to the Afterflow Time, the following formula is used:

$$\Delta Afterflow = \frac{TargetRise - ActualRise}{TargetRise} \times ScaleFactor_{AF} \times Afterflow$$

The same formula is used for close, but the Close Scale Factor and Close Time are used instead.

$$\Delta Close = \frac{TargetRise - ActualRise}{TargetRise} \times ScaleFactor_{CL} \times Close$$

Once again, the difference between the Actual Rise Time and Target Rise Time sets the magnitude of the response, which is reduced by the Scale Factor. In this case the result is multiplied by the current time. If the current time is short, then small changes will be made. If the current time is longer, then larger changes will be made.

NOTE: If the initial time or minimum time is very small (less than 1 minute) or the Scale Factor is set to 0%, the calculation will result in a very small or zero result, leading to no change, regardless of when the plunger arrives.

4.2.6.2 Optimization Types

The following sections outline the different optimization types that make use of the above Timer Optimization.

4.2.6.2.1 Afterflow Time Optimization (Maximize Gas)

The goal of Afterflow Optimization is to fix the *Close Time* and automatically find a stable *Afterflow Time* that ensures the plunger travels fast enough to bring up the fluids yet travels at a safe speed.

The *Afterflow Time* moves up and down to vary the time the plunger is held at surface, thus varying the amount of accumulated liquids between plunger cycles. If the plunger arrives early, the well will be allowed to flow longer (makes less trips). If the plunger arrives late, the well will shut-in earlier in to send the plunger down sooner (makes more trips).

$$Afterflow = Afterflow + \Delta Afterflow$$

In this equation, a change is made to Afterflow. All that is required is that the change is positive when the plunger is early and negative when the plunger is late.

4.2.6.2.2 Close Time Optimization (Maximize Fluids)

The goal of Close Optimization is to fix the *Afterflow Time* and automatically find a stable *Close Time* that ensures the plunger travels fast enough to bring up the fluids yet travels at a safe speed.

The *Close Time* moves up and down to vary the time the plunger is left at bottom, thus varying the amount of accumulated liquids between plunger cycles. If the plunger arrives late, time is added to the *Close Time*. If the plunger arrives early, time is subtracted from the *Close Time*.

This can be shown as the formula below:

$$Close = Close - \Delta Close$$

4.2.6.2.3 Close Then Afterflow Optimization (Maximize Fluids then Gas)

This optimization scheme works the same as the previous two sections, but the algorithm first adjusts the *Close Time*. The goal is to minimize the *Close Time* and then maximize the *Afterflow Time*.

With each early arrival of the plunger, the *Close Time* is reduced. If the *Close Time* is at the minimum, the *Afterflow Time* is increased until it reaches the maximum. If the plunger arrives late, we first reduce the *Afterflow*. If the *Afterflow* is at the minimum, we add to the *Close* until it reaches the maximum.

4.2.7 Pressure Based Optimization

In addition to the line pressure switch/sensor, the well may be equipped with a casing pressure switch/sensor and/or a flow differential pressure switch/sensor.

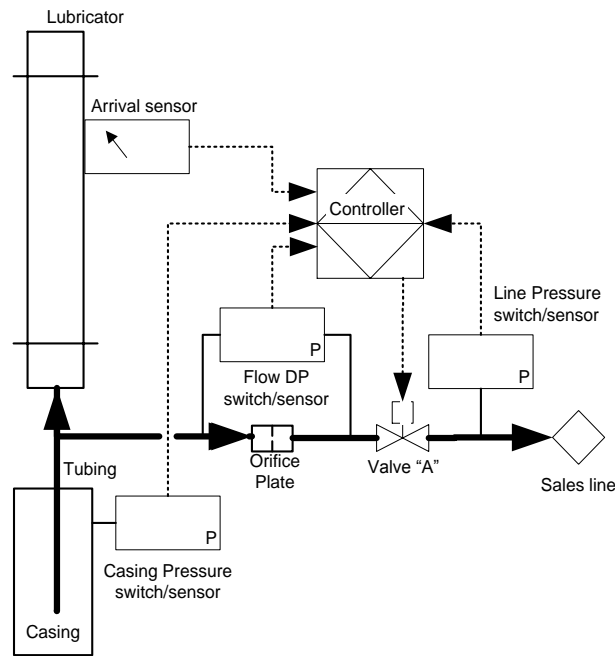

Figure 33 - Pressure Based Optimization

The following table describes the different optimization schemes that are used depending on the devices that are enabled.

Table 2 - Pressure Optimization Modes

Ref	Line Pressure	Casing Pressure	Differential Pressure	Optimization
1	disabled	disabled	disabled	none
2	disabled	disabled	switch	1
3	disabled	disabled	sensor	2
4	disabled	switch	disabled	3
5	disabled	sensor	disabled	4
6	switch	disabled	disabled	none
7	switch	disabled	switch	1

Ref	Line Pressure	Casing Pressure	Differential Pressure	Optimization
8	switch	disabled	sensor	2
9	switch	switch	disabled	3
10	switch	sensor	disabled	4, 6
11	sensor	disabled	disabled	none
12	sensor	disabled	switch	1
13	sensor	disabled	sensor	2, 5
14	sensor	switch	disabled	3
15	sensor	sensor	disabled	6, 7

1. Stay in Afterflow until the *Afterflow Time* expires AND: the *Maximum Afterflow Time* expires or the *Differential Pressure* switch trips.
2. Stay in Afterflow until the *Afterflow Time* expires and: the *Maximum Afterflow Time* expires or the *Differential Pressure* drops below an operator-entered threshold.
3. Monitor the Casing Pressure switch after the *Close Time* expires. Stay shut-in while the Casing Pressure switch is tripped.
4. Monitor the Casing Pressure sensor after the *Close Time* expires. Stay shut-in while the Casing Pressure is below an operator-entered set-point.
5. During Rise, Afterflow: Calculate the Flow Rate using a simplified orifice meter formula. Stay in Afterflow until the *Afterflow Time* expires. Stay in Afterflow until the *Maximum Afterflow Time* expires or the Flow Rate drops below an operator-entered threshold. Calculate and save daily production volumes based on the calculated flow rate.
6. During Afterflow: Monitor the Casing Pressure.¹ Keep the well flowing until the *Afterflow Time* expires AND: the *Maximum Afterflow Time* expires or the Casing Pressure falls below a set point (Absolute) or the rate of fall drops below a set point and a timer expires (Rate Drop).. See diagram below. Other algorithms are also available to monitor Casing Pressure in the Afterflow portion of the cycle.

¹ Do not monitor Casing and Line pressure sensors within the *Arrival Guard* time of plunger arrival.

7. During Close: After the *Close* or *Non-Arrival Close Time* expires, monitor the Casing/Line differential pressure. Start a new cycle when the Casing/Line pressure difference exceeds an operator-entered threshold.

The following diagram illustrates the controller behaviour when using various extended flow devices.

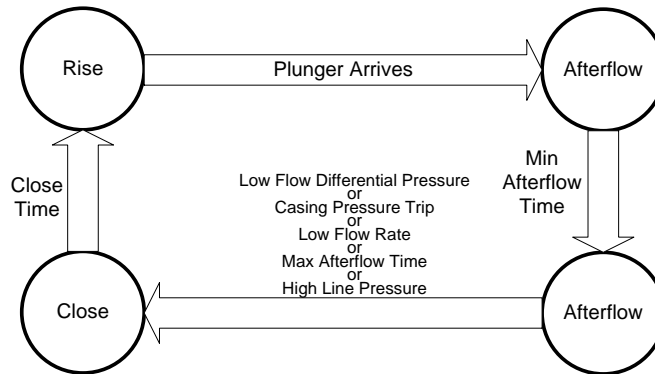

Figure 34 - Extended Afterflow Optimization

4.2.7.1 Casing Pressure

Casing Pressure can be used on its own or in combination with Line Pressure. This section discusses how Casing Pressure can be used on its own. Some of the optimization schemes behave the same when line pressure is turned on, while others will cause the controller to switch to using Casing Line Differential Pressure. The following controller actions will only take place if a Casing Pressure device has been enabled.

4.2.7.1.1 Close

The Casing Pressure is not monitored until the end of the Close portion of the cycle. Once the *Close Time* has expired, the well will be held closed until the Casing Pressure device has been reset.

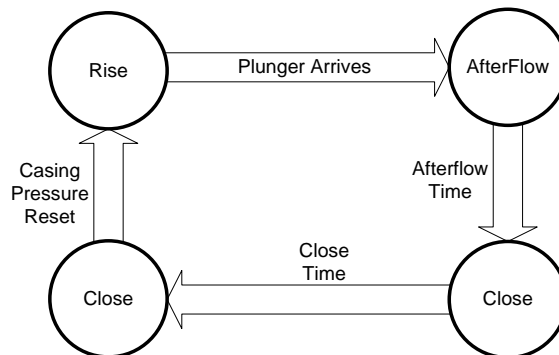

Figure 35 - Casing Pressure Close Cycle

If a switch is used, it must be in the reset position and must stay there for at least the stable time. If the *Casing Pressure Device Type* is configured as a sensor, then the sensor value must exceed the *Open Casing Pressure Reset Point* and stay there for at least the *Open Casing Pressure Stable Time*.

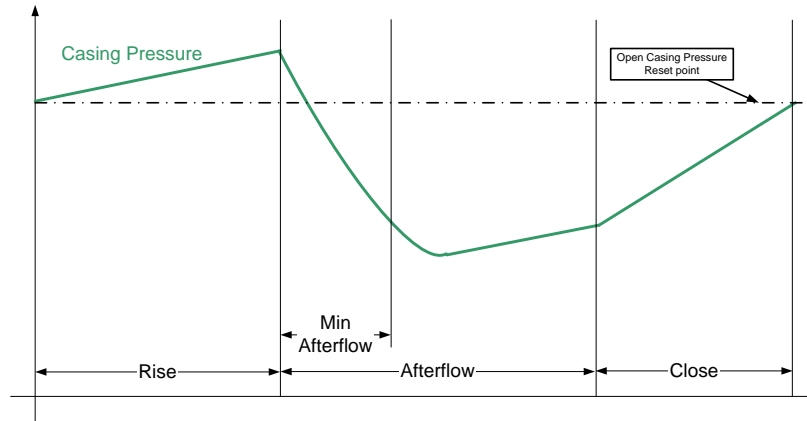

Figure 36 - Open Casing Pressure Reset Point

4.2.7.1.2 Afterflow

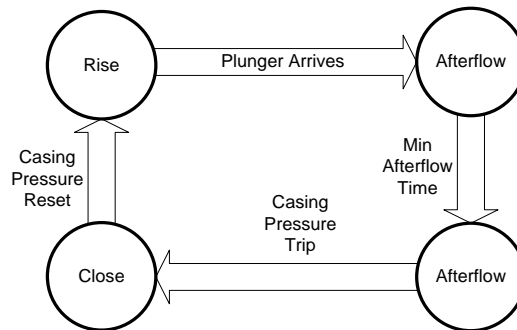

Figure 37 - Afterflow Casing Pressure

During the Afterflow portion of the cycle, the Casing Pressure is monitored one of three different ways if the *Casing Pressure Device Type* has been configured as a sensor. If the Casing Pressure trips during Afterflow, the well is closed as soon as the *Afterflow Time* expires. If the Casing Pressure has not tripped by the end of the *Afterflow Time*, then the Casing Pressure will continue to be monitored during the extended portion of Afterflow. A trip during this time will cause the well to be closed once the applicable *Stable Time* has been met. The following sections describe the different Casing Pressure monitors that can be configured.

4.2.7.1.2.1 Absolute

This method simply looks for a drop in the Casing Pressure. Once the Casing Pressure drops below the *Close Casing Pressure Trip Point* and stays there for at least the time defined by the *Close Casing Pressure Stable Time*, the well will be shut in.

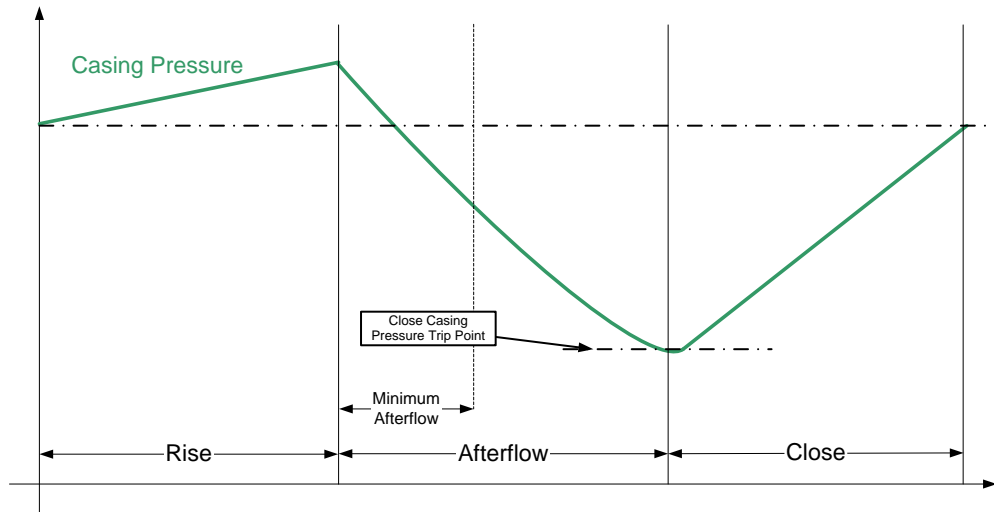

Figure 38 - Casing Pressure Absolute Method

4.2.7.1.2.2 Rate Drop

The Rate Drop method monitors the change in the Casing Pressure over time. As the rate of change slows and becomes lower than the *Casing Pressure Rate Threshold*, the *Trip Delay Time* is started. When this timer expires the well will be shut-in.

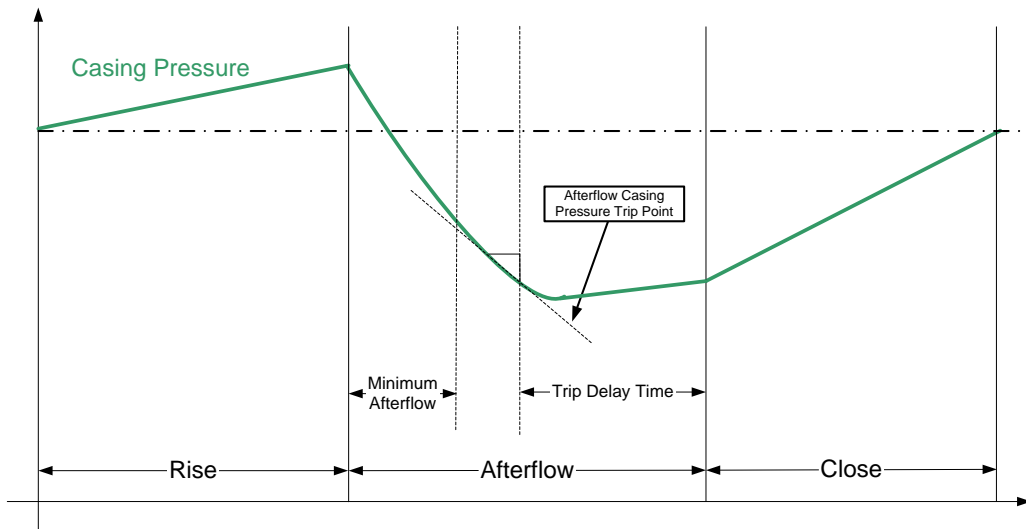

Figure 39 - Casing Pressure Rate Drop Method

4.2.7.2 Casing Line Differential Pressure

If a Casing Pressure Sensor and a Line Pressure Sensor are both enabled, Casing Line Differential Pressure will be used to determine when the controller can move from Close to Open. The difference will be taken between these two values and then compared to the *Open Casing Line Differential Pressure Reset Point*. Once the differential exceeds the reset point and stays above

it for at least the *Open Casing Line Differential Pressure Stable Time*, the well will open. Please note that casing pressure alone is used when determining when to go from open to close.

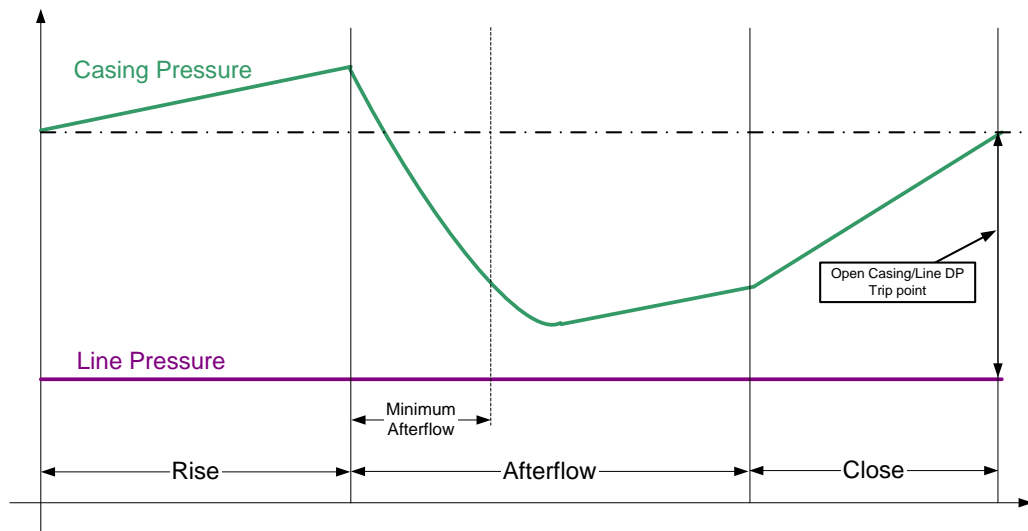

Figure 40 - Open Casing Line Differential Trip

4.2.7.3 Differential Pressure

The *Differential Pressure Device Type* can be configured as either a switch or sensor. When it is configured as a switch, it will automatically drop out of Afterflow when the switch trips. A trip indicates that the differential is below a trip point set externally. The differential is proportional to the flow. A drop in flow is represented as a drop in differential. As the well begins to water in, the differential will decrease.

When the *Differential Pressure Device Type* is enabled as sensor, the controller will behave in the same manner. The difference is that the *Flow Differential Pressure Trip Point* and *Differential Pressure Reset Point* must be configured to tell the controller when to shut in the well. If a Line Pressure sensor is used in conjunction with a Differential Pressure Sensor, then a flow rate can be estimated. Please refer to the Flow Rate section below.

4.2.7.4 Flow Rate

There are several ways to obtain a Flow Rate for optimization. They are discussed in detail in the sections below.

When the Flow Rate is available, the *Afterflow Time* of the controller is optimized. If the Flow Rate is a numerical value, the well is shut-in when the Flow Rate drops below the *Flow Rate Trip Point* and remains there for at least the *Flow Rate Stable Time*.

The Flow Rate value is also used to provide an estimated daily production. The flow is summed over time and the resultant production numbers are shown in the daily logs, which can be viewed by pressing the History hot key.

4.2.7.4.1 Calculated

The flow rate can be calculated if a Line Pressure sensor and a Flow Differential Pressure Sensor are used. This method will require a set of orifice plate parameters to be entered in the Inputs menu. A Meter Factor is derived from a look up table using the *Meter Run Size* and *Orifice Plate Size*. The Gas Temperature and *Gas Specific Gravity* are entered by the installer and are NOT updated real time. This calculation will provide an estimated flow that can be used for optimization. Please note that the production values that are derived from the calculation are not suitable for custody transfer.

4.2.7.4.2 Switch

The *Flow Rate Device Type* can also be configured as a switch. This allows the well to be shut in when the switch trips. Since there is no value associated with the Flow Rate, production numbers will not be provided.

4.2.7.4.3 Virtual

This configuration for Flow Rate allows the well to be optimized based on a Flow Rate from another system. This mode of operation requires a Flow Rate to be written to a Modbus register. This incoming value is then compared against the *Flow Rate Trip Point* to determine when to shut-in the well. Since a value is available for Flow Rate, the production numbers are calculated and displayed in the daily logs.

4.2.7.4.4 Sensor

The *Flow Rate Device Type* can also be set to sensor which uses an analog input. This input value is scaled to provide a flow value. This option is currently available, but has not been tailored to match any specific flow sensor at this point. Development would be required to fully implement this solution.

4.3 Digital Outputs

The controller is equipped with 1 or 2 digital outputs based on the model that is being used. There are a number of different functions that can be achieved depending on how the outputs are configured. The following sections show some of the common configurations.

4.3.1 Mimic Valve

The digital outputs can mimic any valve that is enabled on the controller. If there is a valve, such as an auto catch that you would like to mimic that is not available; first ensure that the auto catch is enabled.

4.3.1.1 Level

By default, the output is turned ON (5 V) when a given valve is opened. The output is turned OFF (0 V) as soon as the valve is closed. This is useful when connecting to a relay. The relay is energized when the valve is open, allowing devices such as an electric valve to be powered. When the valve is closed, the power to the relay is removed, cutting power to the electric valve.

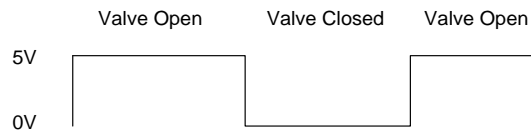

Figure 41 - Level Based Valve Output

4.3.1.2 Pulse

Alternatively, the output can be set to pulse. In this instance, we can set the output to pulse on open or pulse on close. When the desired valve operation occurs, the output is turned ON (5 V) for a specified amount of time (in milliseconds). After this time has lapsed, the output is turned OFF (0V).

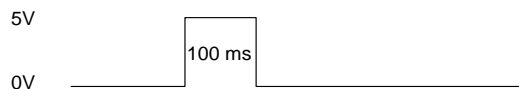

Figure 42 - Pulse to Open or Close Valve Output

This is useful for communicating with interfaces that require a short duration pulse instead of level that is held until the valve state changes. One example is the Kimray Electro Hydraulic Valve. This valve requires 2 signals, one which pulses when the valve is expected to open and another that is expected to pulse when the valve is closed.

4.3.2 On Alarm

This feature is used to communicate with other systems when the controller has gone into an alarm state. If the controller stops operating because it has a low battery or another alarm condition has caused the internal state machine to shut the well in, the output will be turned ON

(5 V). When the alarm condition is cleared and normal operation resumes, the output will be turned OFF (0 V).

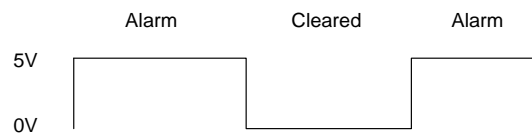

Figure 43 - Level Based Alarm Output

5 Menu Reference

5.1 Hot Key Menus

The following menus are available to the operator without logging in. Simply press the corresponding hot key to access the menus.

5.1.1 Settings Menu

The *settings* hot key navigates to a special menu that contains all of the timers that are used by the controller as well as the set points for pressure devices. The timers control how long the controller leaves the well open, waits for an arrival, closes the well in, and more. These settings give the installer/operator control over how the well behaves. The following is a list of the timers and settings that are available in this menu:

Table 3 - Settings Screens

Screen	Description	Default Value
<i>Close Time</i>	This determines the duration of the Close portion of the cycle.	0h18m11s
<i>Non-Arrival Close Time</i>	This determines the duration of the Close portion of the cycle following a non-arrival. Not used if the <i>Arrival Sensor</i> is disabled.	0h36m22s
<i>Rise Time</i>	This time is used to indicate that the plunger is not likely to arrive at the surface unless special action is taken. If this time expires before the plunger arrives, the controller will bypass the Afterflow portion of the cycle and close the valves for the Non-Arrival Close Time, or possibly shutdown the well. The intent is to allow extra pressure to build in order to lift the plunger on the next cycle. The Rise Time may not be set to zero. If the <i>Arrival Sensor</i> is disabled, this defines the time spent in the Rise portion of the cycle. That is, the controller will advance to Afterflow when this time expires.	0h6m40s

Screen	Description	Default Value
<i>Fast Trip Time</i>	This time is used to indicate that the Plunger did not likely fall to the bottom of the well. The well will be shut-in if a number of consecutive fast trips have occurred. Not used if the <i>Arrival Sensor</i> is disabled.	0h03m10s
<i>Target Rise Time</i>	This is the time that the plunger is expected to arrive after the well has been opened. It is only used when running Timer Based Optimization. The controller will increase or decrease the <i>Afterflow or Close Time</i> in order to try and cause the plunger to arrive at this time. Not used if the <i>Plunger Arrival Sensor</i> or Timer Based Optimization is disabled.	0h04m00s
<i>Afterflow Time</i>	The Afterflow portion of the cycle is terminated when this time expires. When “extended-afterflow” ² devices are enabled, the controller will extend the Afterflow time instead of advancing to Close if none of the devices have already tripped.	1h00m00s
<i>Line Pressure Trip Point</i>	When the <i>Line Pressure Device Type</i> is <i>Sensor</i> , defines the pressure, above which, the well will be shut-in.	90.0 psi
<i>Open Casing Pressure Trip Point</i>	When the <i>Casing Pressure Device Type</i> is <i>Sensor</i> , and the <i>Line Pressure Device Type</i> is <u>not</u> <i>Sensor</i> , defines the casing pressure, below which, the well will stay shut-in.	90.0 psi

² The “Extended-Afterflow” devices are:

- Casing Pressure Switch/Sensor
- Flow Differential Pressure Switch/Sensor
- Flow Switch/Sensor/Virtual

Screen	Description	Default Value
<i>Open Casing Line Differential Trip Point</i>	When the <i>Casing</i> and <i>Line Pressure Device Types</i> are both <i>Sensor</i> , defines the pressure difference, below which the well will stay shut-in.	50.0 psi
<i>Close Casing Pressure Rate Threshold</i>	When the <i>Casing Pressure Device Type</i> is <i>Sensor</i> , defines the rate at which the casing pressure is falling that causes an event. It is used for Casing Pressure Rate of Change optimization and is the point at which the Trip Delay Timer is started, after which the well is shut. This screen is only visible if the <i>Close Casing Pressure Type</i> is set as <i>Rate Drop</i> .	1.0 psi/min
<i>Close Casing Pressure Trip Point</i>	When the <i>Casing Pressure Device Type</i> is <i>Sensor</i> , this defines the pressure above which the well will stay flowing. This screen is only visible if the <i>Casing Pressure Device Type</i> is set as <i>Absolute</i> .	150.0 psi
<i>Close Differential Pressure Trip Point</i>	When the <i>Differential Pressure Device Type</i> is <i>Sensor</i> , this defines the differential pressure which will cause a trip condition to be reset.	20.0 "WC
<i>Flow Rate Trip Point</i>	When the <i>Differential Pressure and Line Pressure Device Types</i> are both <i>Sensor OR Flow is Sensor/Virtual</i> , this defines the rate above which the well will stay flowing.	18.0 e3m3/d

5.1.2 History Menu

5.1.2.1 Rise Time Log

The rise time log is a shortened version of the cycle log. It's primary purpose is to provide a quick reference to the most recent rise times for the last 25 cycles.

The following information is saved for each cycle:

Table 4 – Rise Time Log Screens

Screen	Description
<i>Cycle Type and Rise Duration</i>	<p>This screen shows the type of cycle that occurred as well as the Rise Time of the plunger.</p> <p>The cycle type will be one of:</p> <ul style="list-style-type: none"> Waiting Normal Fast-trip Non-Arrival Maximum Afterflow Line Pressure Shut-In Low Battery Shutdown Operator Change Startup
<i>Reset Log?</i>	This clears all of the cycle log data.

5.1.2.2 Cycle Log

The cycle log is a history of each cycle that the controller goes through. A log entry is written at the end of a cycle, which is defined as the point when the controller finishes the *Close Time*. Therefore, the controller will write the first cycle log entry after the controller starts and the initial *Close Time* expires. Each log entry is stored in persistent memory so that it is maintained through any power disruptions. A maximum of 25 log entries will be saved. Once this limit is reached, new entries are written over top of the oldest entry.

The following information is saved for each cycle:

Table 5 - Cycle Log Screens

Screen	Description
<i>Number of Cycles</i>	The total number of plunger cycles currently stored in the Cycle Log.
<i>Cycle Type and</i>	This screen shows the type of cycle that occurred as well as the date

<i>Start Time</i>	<p>and time that the cycle started.</p> <p>The cycle type will be one of:</p> <ul style="list-style-type: none"> Waiting Normal Fast-trip Non-Arrival Maximum Afterflow Line Pressure Shut-In Low Battery Shutdown Operator Change Startup
<i>Rise Duration</i>	This value shows the time that it took the plunger to come to surface once the well was opened. This screen is not displayed if the arrival sensor has been disabled.
<i>Afterflow Duration</i>	This is the total <i>Afterflow Time</i> for this cycle.
<i>Vent Duration</i>	Shows the amount of vent time during this cycle.
<i>Close Duration</i>	This is the amount of <i>Close Time</i> for the given cycle. It may be longer than the specified <i>Close Time</i> if the well is held in close by devices such as line pressure or casing pressure.
<i>Minimum Afterflow Casing Pressure</i>	This is the value of casing pressure that caused the well to go from open to close. This screen is only displayed if Pressure Based Optimization is being used and the Casing Pressure device is configured as a sensor.
<i>Reset Log?</i>	This clears all of the cycle log data.

5.1.2.3 Daily

The controller maintains daily production statistics which are written to persistent memory when the current time-of-day passes the *Day Start* parameter. The following information is available in the Daily History menu:

Table 6 – Daily History Screens

Screen	Description
<i>Date and Total Cycles</i>	Shows the date for the given history record as well as the total number of cycles that occurred during that day.
<i>Open/Close Time</i>	Displays the total time that the well has been open and the total time the well has been closed for the day.
<i>Vent Time</i>	Displays the total amount of vent time for the day.
<i>Volume</i>	This shows the total volume for the given day. This is represented as e ³ m ³ .
<i>Cycle Counts</i>	There are a number of screens that are used to display all of the cycle types for the current day.
<i>Reset Log?</i>	This clears all of the daily log data.
<i>Day Start</i>	This defines the gas day cut off. When the controller passes this time each day, the history for the current day will stop and a new day will start.

5.1.2.4 Total

The controller maintains total production statistics which continually increases until the log is reset. The following information is available in the Total History menu:

Table 7 – Total Statistics Screens

Screen	Description
<i>Open/Close Time</i>	Displays the total time that the well has been open and the total time the well has been closed.
<i>Vent Time</i>	Displays the total amount of vent time.
<i>Volume</i>	This shows the total volume. This is represented as e ³ m ³ .
<i>Cycle Counts</i>	There are a number of screens that are used to display all of the cycle types.
<i>Reset Time</i>	Shows the time that the total statistics were last reset.
<i>Reset Log?</i>	This clears all of the total statistics data.

5.1.2.5 Plunger

The controller maintains total plunger statistics which continually increases until the log is reset. The following information is available in the Daily History menu:

Table 8 – Plunger Statistics Screens

Screen	Description
<i>Travel Distance</i>	Total distance that the plunger has travelled since the last reset.
<i>Plunger Arrivals</i>	Total number of plunger arrivals since the last reset.
<i>Reset Time</i>	Shows the time that the plunger statistics were last reset.
<i>Reset Log?</i>	This clears all of the daily log data.

5.2 Install Menu

If security has been enabled, users must log in here in order to see the menus below. The install menu is entered by pressing the *install* hot key. The default login is 000-0000, which can be changed in the security menu.

5.2.1 Date/Time

This menu allows the date and time to be configured. There is also a screen that allows daylight savings time to be enabled. The following is list of all of the available screens:

Table 9 - Date/Time Screens

Screen	Description	Default
<i>Date</i>	Allows the user to set the current date.	Jan 1, 2000
<i>Day Confirm</i>	This confirms the current day of the week when the date is set.	N/A
<i>Time</i>	Allows the user to set the current time. Please note that this is in 24 hr time (i.e. 1:00 pm is entered as 13:00)	00:00
<i>DST Enable</i>	If enabled, the controller will automatically adjust 2 times a year for daylight savings.	disabled

5.2.2 System

The System menu provides information specific to the given controller. This includes information such as the serial number and firmware version. Features can be enabled, the display brightness can be adjusted, and the controller settings can be reset to factory defaults.

If any errors have been reported by the controller, they can be found at the end of this menu. The following is a list of the available screens:

Table 10 - System Screens

Screen	Description	Default
<i>Display Level</i>	Sets the screen brightness. Can be used to save power or adapt to different lighting conditions.	50%
<i>Display Auto Off</i>	This sets the amount of time after the last key press that the display will stay on.	1m00s
<i>Units</i>	Set the controller to use imperial or metric units.	Metric
<i>Serial Number</i>	The serial number of the controller. This is required if features need to be enabled on the controller or it is to be returned for repair.	N/A
<i>Software Version</i>	This identifies the specific firmware version that is currently running on the controller. This is required if issues are reported. Please refer to the release notes for this version to see a list of known issues.	N/A
<i>Hardware Version</i>	Shows the current version of hardware. This is used to manage different generations of hardware. It also helps troubleshoot any future issues that may be linked to a specific version of hardware.	N/A
<i>Timer Optimization Option</i>	This feature allows the controller to optimize the well based on plunger arrival time. The <i>Afterflow or Close Time</i> is manipulated in order to change the next arrival time of the plunger. This screen does not appear in the Model 650 as this feature is always available.	Disabled
<i>Restore Defaults</i>	This will reset all controller settings back to the factory defaults. The user will be prompted to confirm this action before the settings are restored.	No

Screen	Description	Default
<i>Error Log</i>	This screen will only appear if a detectable error has occurred. Some errors will result in the controller restarting. This is the first place that should be checked if the controller is restarting itself.	N/A
<i>Reset Error Log</i>	If there are entries in the error log this screen will appear. It allows you to clear the error log. You will be prompted to confirm this action.	No

5.2.3 Security

The Security menu allows the currently logged in user to logout. Installers are able to view and change both the Operator and Installer login IDs.

Table 11 - Security Screens

Screen	Description	Default
<i>Secure Login</i>	Allows the installer to add security to the menu. If this is disabled, no login is requested and none of the following screens are displayed.	disabled
<i>Logout</i>	This screen forces a log out. The screen will move back to the main status screen when the operator has logged out. The operator will be required to enter a password to regain entry to the Setup menu.	N/A
<i>Auto Logout Time</i>	The amount of time after the last key press that the user will remain logged in.	10m00s
<i>Operator ID</i>	This screen allows the Installer to set an <i>Operator ID</i> . This allows another user to have limited access to the Setup menu. This screen is only visible to a logged in Installer.	000-0000
<i>Installer ID</i>	This screen allows the Installer to change the current Installer ID. This screen is only visible to a logged in Installer. Note: If the Installer and Operator IDs are configured to be the same number, the user will be logged in as the Installer when using this code.	000-0000

5.2.4 Well Setup

The well setup menu allows the installer to define some basic parameters of the well such as the depth, the plunger type, and the desired velocities. The depth and velocities can be set to auto calculate the various timer values.

Table 12 – Well Setup Screens

Screen	Description	Default
<i>Plunger Type</i>	Identifies the type of plunger currently in the well. This allows the controller to modify some of the default settings that are related to the plunger type.	Conventional
<i>Well Depth</i>	Specifies the depth of the well in meters. This is used in conjunction with the velocities specified below to automatically populate values for the timers. This can be specified as any integer value between 1 and 50,000 m	1000 m
<i>Danger Velocity</i>	This is the average velocity at which the plunger is moving at a dangerous velocity. A single run at this velocity is likely to damage the well head. When entered, the <i>Fast Trip Time</i> will be re-calculated based on this parameter and the well depth.	640 m/min
<i>Danger Time</i>	This time is used to indicate that the Plunger did not likely fall to the bottom of the well. The well will be shut-in immediately if a dangerous trip has occurred. Not used if the Arrival Sensor is disabled.	0h01m34s
<i>Fast Trip Velocity</i>	This is the average velocity at which the plunger is moving much faster than expected. Repetitive runs at this velocity may damage the well head. When entered, the <i>Fast Trip Time</i> will be re-calculated based on this parameter and the well depth.	250 m/min

Screen	Description	Default
<i>Fast Trip Time</i>	<p>This time is used to indicate that the Plunger did not likely fall to the bottom of the well. The well will be shut-in if a number of consecutive fast trips have occurred.</p> <p>Not used if the Arrival Sensor is disabled.</p>	0h03m10s
<i>Rise Velocity</i>	<p>This is the average velocity at which the plunger is moving much slower than expected and is unlikely to arrive.</p> <p>When entered, the <i>Rise Time</i> will be re-calculated based on this parameter and the well depth.</p>	150 m/min
<i>Rise Time</i>	<p>This time is used to indicate that the plunger is not likely to arrive at the surface unless special action is taken. If this time expires before the plunger arrives, the controller will bypass the Afterflow portion of the cycle and close the valves for the Non-Arrival Close Time, or possibly shutdown the well. The intent is to allow extra pressure to build in order to lift the plunger on the next cycle. The Rise Time may not be set to zero.</p> <p>If the Arrival Sensor is disabled, this defines the time spent in the Rise portion of the cycle. That is, the controller will advance to Afterflow when this time expires.</p>	0h6m40s
<i>Target Rise Velocity</i>	<p>This is the average velocity at which the plunger should travel in order to operate the well the most efficiently.</p> <p>When entered, the <i>Target Rise Time</i> will be re-calculated based on this parameter and the well depth.</p>	250 m/min

Screen	Description	Default
<i>Target Rise Time</i>	<p>This is the time that the plunger is expected to arrive after the well has been opened. It is only used when running Timer Based Optimization. The controller will increase or decrease the Afterflow or Close Time in order to try and cause the plunger to arrive at this time.</p> <p>Not used if the Plunger Arrival Sensor or Timer Based Optimization is disabled.</p>	0h04m00s
<i>Close Velocity</i>	<p>This is the average velocity at which the plunger is expected to fall in the well, including travelling through the water that is at the bottom of the well..</p> <p>When entered, the <i>Rise Time</i> will be re-calculated based on this parameter and the well depth.</p>	55 m/min
<i>Minimum Close Time</i>	<p>This determines the minimum time for of the Close portion of the cycle.</p> <p>This value prevents the operator from setting the Close Time outside of acceptable parameters.</p> <p>It also used for time based optimization.</p>	0h18m11s
<i>Maximum Close Time</i>	<p>This determines the maximum time of the Close portion of the cycle.</p> <p>This value prevents the operator from setting the Close Time outside of acceptable parameters.</p> <p>It also used for time based optimization.</p>	8h00m00s
<i>Close Time</i>	<p>This determines the duration of the Close portion of the cycle.</p>	0h18m11s
<i>Non-Arrival Close Time</i>	<p>This determines the duration of the Close portion of the cycle following a non-arrival.</p> <p>Not used if the Arrival Sensor is disabled.</p>	0h36m22s

Screen	Description	Default
<i>Minimum Afterflow Time</i>	<p>This sets the minimum amount of time for Afterflow.</p> <p>This value prevents the operator from setting the Afterflow Time outside of acceptable parameters.</p> <p>It also used for both pressure and time based optimization. In pressure based optimization, it ensures that pressure devices cannot terminate the Afterflow Time too early.</p>	1h00m00s
<i>Maximum Afterflow Time</i>	<p>This sets the maximum amount of time for Afterflow.</p> <p>This value prevents the operator from setting the Afterflow Time outside of acceptable parameters.</p> <p>It also used for both pressure and time based optimization. In pressure based optimization, it ensures that pressure devices do not hold the well open for an extraordinarily long time.</p>	8h00m00s
<i>Afterflow Time</i>	<p>The Afterflow portion of the cycle is terminated when this time expires.</p> <p>When “extended-afterflow”³ devices are enabled, the controller will extend the Afterflow time instead of advancing to Close if none of the devices have already tripped.</p>	1h00m00s

5.2.5 Inputs

The Inputs menu lists all of the available inputs, such as arrival sensor and line pressure sensor. Other input devices will be available when the Pressure Optimization feature has been enabled. These devices include casing pressure, flow differential pressure, and flow.

³ The “Extended-Afterflow” devices are:

- Casing Pressure Switch/Sensor
- Flow Differential Pressure Switch/Sensor
- Flow Switch/Sensor/Virtual

Table 13 - Inputs Screens

Screen	Description	Default
<i>PAS</i>	Informs the controller if a Plunger Arrival Sensor (PAS) is connected. If disabled, the Rise cycle will run to completion and then switch to Afterflow.	<i>Enabled</i>
<i>PAS Delay Time</i>	This sets the amount of time to ignore plunger arrival signals at the start of the rise time. This is necessary for some manufacturer's sensors that send a signal as soon as they are powered up.	<i>Disabled</i>
<i>PAS Switch Polarity</i>	Allows the type of arrival sensor to be configured. The controller can detect an arrival on a close or open of a switch.	<i>Normally Open (Detects on a switch close)</i>
<i>Line Pressure Device Type</i>	Enables the use of a Line Pressure Switch or Sensor. Disabled = Device not installed or unused. Switch = Discrete Input Switch installed and enabled. Sensor = A Line Pressure Analog Sensor is installed.	<i>Disabled</i>
<i>Line Pressure Range</i>	When the <i>Line Pressure Device Type</i> is <i>sensor</i> , defines the range of the sensor.	500.0 psi
<i>Line Pressure Switch Polarity</i>	Configures the type of Line Pressure switch to use. The controller can detect a Line Pressure trip on a close or open of a switch.	<i>Normally Open (Detects on a switch close)</i>
<i>Casing Pressure Device Type</i>	Enables the use of a Casing Pressure Switch or Sensor. Disabled = Device not installed or unused. Switch = Discrete Input Switch installed and enabled. Sensor = A Casing Pressure Analog Sensor is installed. This screen is only available on the Model 650.	<i>Disabled</i>

Screen	Description	Default
<i>Casing Pressure Range</i>	When the <i>Casing Pressure Device Type</i> is Sensor, defines the range of sensor. This screen is only available on the Model 650.	500.0 psi
<i>Casing Pressure Switch Polarity</i>	Configures the type of Casing Pressure switch to use. The controller can detect a Casing Pressure trip on a close or open of a switch. This screen is only available on the Model 650.	<i>Normally Open (Detects on a switch close)</i>
<i>Differential Pressure Device Type</i>	Enables the use of a Differential Pressure Switch or Sensor. Disabled = Device not installed or unused. Switch = Discrete Input Switch installed and enabled. Sensor = A Pressure Analog Sensor is installed. This screen is only available on Model 650.	<i>Disabled</i>
<i>Differential Pressure Range</i>	When the <i>Differential Pressure Device Type</i> is Sensor, defines the range of sensor. This screen is only available on the Model 650.	150.0 "WC
<i>Differential Pressure Switch Polarity</i>	Configures the type of Differential Pressure switch to use. The controller can detect a Flow Differential Pressure trip on a close or open of a switch. This screen is only available on the Model 650.	<i>Normally Open (Detects on a switch close)</i>

Screen	Description	Default
<i>Flow Rate Device Type</i>	<p>Enables the use of a Flow Switch, Sensor, or Virtual.</p> <p>Disabled = Device not installed or unused.</p> <p>Switch = Discrete Input Switch installed and enabled.</p> <p>Sensor = A Pressure Analog Sensor is installed.</p> <p>This screen is disabled if the <i>Differential Pressure Device Type</i> and the <i>Line Pressure Device Type</i> are both configured as <i>Sensor</i>. This configuration causes the Flow Rate to be calculated automatically.</p> <p>This screen is only available on the Model 650.</p>	<i>Disabled</i>
<i>Flow Rate Range</i>	<p>When the <i>Flow Rate Device Type</i> is <i>Sensor</i>, defines the range of sensor.</p> <p>This screen is only available on the Model 650.</p>	10.0 e3m3/d
<i>Flow Rate Switch Polarity</i>	<p>Configures the type of Flow Rate switch to use. The controller can detect a Flow Rate trip on a close or open of a switch.</p> <p>This screen is only available on the Model 650.</p>	<i>Normally Open (Detects on a switch close)</i>
<i>Pressure Sensor Scan Time</i>	<p>Defines the rate at which all pressure sensors are read.</p>	00m01s
<i>Pressure Switch Scan Time</i>	<p>Defines the rate at which all pressure switches are read.</p>	00m01s
<i>Meter Run Size</i>	<p>When the <i>Differential Pressure Device Type</i> and the <i>Line Pressure Device Type</i> are both <i>Sensor</i>, defines the meter run diameter used for flow rate calculations.</p> <p>This screen is only available on the Model 650.</p>	2 inches

Screen	Description	Default
<i>Orifice Size</i>	<p>When <i>Differential Pressure Device Type</i> and the <i>Line Pressure Device Type</i> are both <i>Sensor</i>, defines the orifice diameter used for flow rate calculations.</p> <p>This screen is only available on Model 650.</p>	1.000 inches
<i>Gas Temperature</i>	<p>When the <i>Differential Pressure Device Type</i> and the <i>Line Pressure Device Type</i> are both <i>Sensor</i>, defines the gas temperature used for flow rate calculations.</p> <p>This screen is only available on the Model 650.</p>	60 °F
<i>Gas Specific Gravity</i>	<p>When <i>Differential Pressure Device Type</i> and the <i>Line Pressure Device Type</i> are both <i>Sensor</i>, defines the specific gravity (relative to air) used for flow rate calculations.</p> <p>This screen is only available on the Model 650.</p>	0.60

5.2.6 Outputs

The Outputs menu allows the installer to configure the behaviour of Valve B and the Auto Catch (only available on the Model 650).

Table 14 - Outputs Screens

Screen	Description	Default
<i>Valve B Type</i>	<p>Defines Valve B operation:</p> <p><i>Disabled:</i> Valve B not present or unused. The controller will only assert control on the Sales Valve.</p> <p><i>Line:</i> Valve B is connected to the Sales Line. It can be opened or closed during the Afterflow portion of the cycle based on the Afterflow Valve Configuration.</p> <p><i>Tank:</i> Valve B is connected to a Tank.</p> <p><i>Flow Control:</i> Valve B is opened during Rise and closed during Afterflow.</p> <p><i>Purge:</i> Valve B is opened at the end of Close for a set duration of time.</p>	<i>Disabled</i>
<i>Purge Time</i>	The amount of time that Valve B is purged before the opening of the Sales Valve.	<i>0h00m01s</i>
<i>Tank Delay Time</i>	<p>When Valve B is configured as a Tank Valve, the flow is switched from The Sales Valve to Valve B during the Rise portion of the cycle if the Plunger does not arrive within this time. It must be less than the Rise Time.</p> <p>Not used if set to zero or if Valve B is disabled.</p>	<i>0h05m00s</i>
<i>Afterflow Delay Time</i>	<p>When Valve B is enabled, this defines the amount of time the controller will wait following a plunger arrival before opening The Sales Valve. This is done to ensure that the plunger has moved fully into the Lubricator following a plunger arrival sensor signal. It is also used to ensure that any liquids are flushed through the system.</p> <p>Not used if Valve B Is disabled or if set to zero.</p>	<i>0h00m00s</i>

<i>Afterflow Valve Configuration</i>	<p>This parameter allows the user to configure which valves should be open during the Afterflow portion of the cycle when operating in dual valve mode.</p> <p>Valve B is open during Afterflow to keep the Auto Catch activated. It can be left closed during the Afterflow portion of the cycle for configurations where an Auto Catch is not installed.</p>	<i>Sales/B</i>
<i>Auto Catch</i>	<p>The Auto Catch can be set to engage on the start of the Rise cycle when the Sales Valve is opened or on the arrival of the plunger.</p> <p>The Auto Catch is only available on the Model 650.</p>	<i>Disabled</i>
<i>Auto Catch Hold Time</i>	<p>This parameter sets the amount of time to hold the plunger at surface after the Sales Valve has been closed.</p> <p>This parameter is not used if the Auto Catch is disabled.</p>	<i>Disabled</i>
<i>DO1-LP Power</i>	Sets the operation to use the LP Power connection for.	Default (Power a LP sensor)
<i>DO1 Signal</i>	<p>Sets what type of output signal is desired:</p> <p>Level – High signal when open and low when closed</p> <p>Pulse Open – Pulse high for a set time on open</p> <p>Pulse Close – Pulse high for a set time on close</p>	Level
<i>DO1 Time</i>	Specify the time to pulse the output for.	1000 ms
<i>DO2-CP/DP Power</i>	<p>Sets the operation to use the CP/DP Power connection for.</p> <p>This screen is only available on the Model 650.</p>	Default (Power a CP/DP Sensor)

<i>DO2 Signal</i>	Sets what type of output signal is desired: Level – High signal when open and low when closed Pulse Open – Pulse high for a set time on open Pulse Close – Pulse high for a set time on close	Level
<i>DO2 Time</i>	Specify the time to pulse the output for.	1000 ms

5.2.7 Alarms

The alarms menu allows parameters such as the number of Fast Trips or Non-Arrivals that can occur before the controller shuts the well in. There are also settings that determine if the well is shut in or opened when an alarm condition occurs.

Table 15 - Alarms Screens

Screen	Description	Default
<i>Non-Arrival Count</i>	The controller will shutdown the well after “Non-Arrival Count” consecutive plunger non-arrivals. Not used if set to zero. Not used if the Arrival Sensor is disabled.	Disabled
<i>Fast Trip Count</i>	The controller will shutdown the well after “Fast Trip Count” consecutive fast trips. Not used if set to zero. Not used if the <i>Fast Trip Time</i> is set to 0. Not used if the Arrival Sensor is disabled.	2
<i>Low Battery Fail Mode</i>	This screen allows the user to configure the behaviour of the controller for this type of failure. The user can decide to have the controller fail Closed or Open.	Closed
<i>Fast Trip Fail Mode</i>	This screen allows the user to configure the behaviour of the controller for this type of failure. The user can decide to have the controller fail Closed or Open.	Closed
<i>Non Arrival Fail Mode</i>	This screen allows the user to configure the behaviour of the controller for this type of failure. The user can decide to have the controller fail Closed or Open.	Closed

5.2.8 Optimize

The optimize menu allows the optimization mode such as Timer or Pressure to be selected. The available optimization schemes depend on the features that have been enabled for a particular

controller. Depending on the optimization scheme chosen, a number of additional screens become available.

Table 16 - Optimize Screens

Screen	Description	Default
<i>Optimization Type</i>	<p>This screen is used to select the type of optimization. The selections that are available depend on the model of controller. Possible choices include:</p> <ul style="list-style-type: none"> • Disabled • Afterflow Time Optimization • Close Time Optimization, • Close Then Afterflow Time Optimization • Pressure Optimization <p>Pressure optimization only available on Model 650.</p> <p>Time Optimization only available on Model 650 when the Timer Optimization feature is unlocked.</p>	Disabled
<i>Adjust Using</i>	<p>Specifies what key parameter to use in the proportional time based adjustments. Options are:</p> <p>Max – Min: Take the max parameter (Afterflow or Close) minus the min parameter to determine how large of a response to generate.</p> <p>Current Time.: Take the current time parameter (Afterfflow or Close Time) to determine how large of a response to generate.</p>	Max - Min
<i>Afterflow Scale Factor</i>	<p>This scaling factor determines how aggressively the controller makes adjustments to the Afterflow Time during Timer Based Optimization. It effectively dampens the response.</p> <p>Maximum is 15% for Max – Min optimization.</p>	<p>1% for Max – Min</p> <p>10% for Current</p>

Screen	Description	Default
<i>Close Scale Factor</i>	This scaling factor determines how aggressively the controller makes adjustments to the Close Time during Timer Based Optimization. Maximum is 15% for Max – Min optimization.	1% for Max – Min 10% for Current
<i>Line Pressure Trip Point</i>	When the <i>Line Pressure Device Type</i> is <i>Sensor</i> , defines the pressure, above which, the well will be shut-in.	90.0 psi
<i>Line Pressure Reset Point</i>	When the <i>Line Pressure Device Type</i> is <i>Sensor</i> , defines the pressure, below which, a Line Pressure trip condition will be cleared.	85.0 psi
<i>Line Pressure Stable Time</i>	When the <i>Line Pressure Device Type</i> is enabled, defines the time required for the line pressure to stabilize above the <i>Line Pressure Trip Point</i> , or below the <i>Line Pressure Reset Point</i> , in order to declare a trip or reset condition.	0h00m05s
<i>Open Casing Pressure Trip Point</i>	When the <i>Casing Pressure Device Type</i> is <i>Sensor</i> , and the <i>Line Pressure Device Type</i> is <u>not</u> <i>Sensor</i> , defines the casing pressure, below which, the well will stay shut-in.	90.0 psi
<i>Open Casing Pressure Reset Point</i>	When the <i>Casing Pressure Device Type</i> is <i>Sensor</i> , and the <i>Line Pressure Device Type</i> is <u>not</u> <i>Sensor</i> , defines the pressure, above which, the well will be opened.	95.0 psi
<i>Open Casing Pressure Stable Time</i>	When the <i>Casing Pressure Device Type</i> is enabled, and the <i>Line Pressure Device Type</i> is <u>not</u> <i>Sensor</i> , defines the time required for the line pressure to stabilize above the <i>Open Casing Pressure Reset Point</i> , or below the <i>Open Casing Pressure Trip Point</i> , in order to declare a trip or reset condition.	0h00m05s
<i>Open Casing/Line Differential Pressure Trip Point</i>	When the <i>Casing</i> and <i>Line Pressure Device Types</i> are both <i>Sensor</i> , defines the pressure difference, below which the well will stay shut-in.	50.0 psi

Screen	Description	Default
<i>Open Casing/Line Differential Pressure Reset Point</i>	When the <i>Casing</i> and <i>Line Pressure Device Types</i> are both <i>Sensor</i> , defines the pressure difference, above which the well will be opened.	55.0 psi
<i>Open Casing/Line Differential Pressure Stable Time</i>	When the <i>Casing</i> and <i>Line Pressure Device Types</i> are both <i>Sensor</i> , defines the time required for the pressure difference to stabilize above the <i>Open Casing/Line Differential Pressure Reset Point</i> , or below the <i>Open Casing/Line Differential Pressure Trip Point</i> , in order to declare a reset or trip condition.	0h00m05s
<i>Close Casing Pressure Type</i>	<p>This determines which algorithm to use for closing the well when the <i>Casing Pressure Device Type</i> is <i>Sensor</i>. The options are:</p> <p style="text-align: center;"><i>Absolute</i></p> <p style="text-align: center;"><i>Rate Drop</i></p> <p>These optimization algorithms are discussed further in the 4.2.7.1 Casing Pressure section.</p>	Absolute
<i>Close Casing Pressure Rate Threshold</i>	<p>When the <i>Casing Pressure Device Type</i> is <i>Sensor</i>, defines the rate at which the casing pressure is falling that causes an event.</p> <p>It is used for Casing Pressure Rate of Change optimization and is the point at which the Trip Delay Timer is started, after which the well is shut.</p> <p>This screen is only visible if the <i>Close Casing Pressure Type</i> is set as <i>Rate Drop</i>.</p>	1.0 psi/min
<i>Close Casing Pressure Trip Point</i>	<p>When the <i>Casing Pressure Device Type</i> is <i>Sensor</i>, this defines the pressure above which the well will stay flowing.</p> <p>This screen is only visible if the <i>Casing Pressure Device Type</i> is set as <i>Absolute</i>.</p>	150.0 psi

Screen	Description	Default
<i>Close Casing Pressure Reset Point</i>	When the <i>Casing Pressure Device Type</i> is <i>Sensor</i> , defines the pressure which will cause a trip condition to be reset. This screen is only visible if the <i>Close Casing Pressure Device Type</i> is set as <i>Absolute</i> .	155.0 psi
<i>Close Casing Pressure Stable Time</i>	When the <i>Casing Pressure Device Type</i> is <i>Sensor</i> , this defines the time required for the pressure to stabilize below the <i>Close Casing Pressure Trip Point</i> , or above the <i>Close Casing Pressure Reset Point</i> , in order to declare a trip or reset condition. This screen is only visible if the <i>Close Casing Pressure Device Type</i> is set as <i>Absolute</i> .	0h00m05s
<i>Trip Delay Time</i>	This screen specifies the amount of time to delay before closing the well in when using Rate Drop Casing Pressure Optimization. Please refer to the Optimization screens for more information.	1h00m01s
<i>Close Differential Pressure Trip Point</i>	When the <i>Differential Pressure Device Type</i> is <i>Sensor</i> , this defines the pressure which will cause a trip condition to be reset.	20.0 "WC
<i>Close Differential Pressure Reset Point</i>	When the <i>Differential Pressure Device Type</i> is <i>Sensor</i> , this defines the pressure which will cause a trip condition to be reset.	22.0 "WC
<i>Close Differential Pressure Stable Time</i>	When the <i>Differential Pressure Device Type</i> is enabled, this defines the time required for the pressure to stabilize below the <i>Flow Differential Pressure Point</i> , or above the <i>Flow Differential Pressure Reset Point</i> , in order to declare a trip or reset condition.	0h00m05s
<i>Flow Rate Trip Point</i>	When the <i>Differential Pressure and Line Pressure Device Types</i> are both <i>Sensor OR Flow is Sensor/Virtual</i> , this defines the rate above which the well will stay flowing.	18.0 e3m3/d

Screen	Description	Default
<i>Flow Rate Reset Point</i>	When the <i>Differential Pressure and Line Pressure Device Types</i> are both <i>Sensor OR Flow is Sensor/Virtual</i> , this defines the rate which will cause a trip condition to be reset.	19.0 e3m3/d
<i>Flow Rate Stable Time</i>	When the <i>Differential Pressure and Line Pressure Device Types</i> are both <i>Sensor OR Flow is Sensor/Virtual</i> , this defines the time required for the rate to stabilize below the trip point, or above the reset point, in order to declare a trip or reset condition.	0h00m05s
<i>Arrival Guard Time</i>	This specifies a waiting period after the arrival of the plunger before we attach the pressure devices to ensure that their readings have stabilized.	Disabled

5.2.9 Modbus

The Modbus menu will only appear if the Modbus feature has been enabled on the controller. This feature allows data to be retrieved by a SCADA host remotely. This menu contains all of the settings that are available for Modbus communications. These settings must match the settings that are used in the SCADA host.

Table 17 - Modbus Menus

Screen	Description	Default
<i>Modbus Port</i>	Sets whether the Modbus port is active or not on. It is disabled by default to save power.	disabled
<i>Station Address</i>	Defines the Modbus station. Valid values are 1 to 247. This setting must match the settings on your Modbus master.	1
<i>Protocol</i>	The specific Modbus protocol that is use. This can be set to either RTU or ASCII. This setting must match the settings on your Modbus master.	RTU

Screen	Description	Default
<i>Baud Rate</i>	The speed of the serial port. This setting must match the settings on your Modbus master.	9600
<i>Data Bits</i>	Sets the number of data bits in each character. This setting must match the settings on your Modbus master.	8
<i>Parity</i>	The parity of the character. This setting must match the settings on your Modbus master.	None
<i>Stop Bits</i>	The number of stop bits per character. This setting must match the settings on your Modbus master.	1
<i>Time Format</i>	Specifies how time and dates are represented in the Modbus registers. Seconds format will utilize one or more registers to show elapsed seconds. H:M:S format allocates separate registers for Hours, Minutes, and Seconds. Please refer to the Modbus Communications User's Guide for more details.	seconds

6 Modbus Communications

The controller is equipped with an RS-485 port which is designed primarily to provide communications to a SCADA system. This port provides most of the functions available from the front panel user interface using the Modbus protocol. The Model 600/Model 650 Modbus Communications User's Guide discusses the physical connections, communications settings, and the available registers.

7 Troubleshooting

The following outlines a number of common issues that may be encountered.

Table 18 - Troubleshooting Guide

Issue	Cause	Resolution
The display won't come on when the battery is plugged in.	The fuse is blown on the battery	Return the controller to be repaired. To avoid this issue, make sure to avoid shorting the battery connections.
	Battery is unplugged or there is a loose connection	Plug in the battery and check all connections
	Battery is dead	Charge the battery as per the directions on the side of the battery. If it does not hold a charge, contact us to purchase a new battery.
	Software has been erased	Reprogram the software using the software upgrade procedure.
Pressing a button does not produce the desired response.	A key is stuck on the keypad	The keypad will need to be replaced. Please contact us to arrange for the controller to be repaired.
	The main core of the controller has been shocked	The controller core must be replaced. Please contact us to arrange for the controller to be repaired. To avoid this, always transport the controller board in a static protection bag and avoid touching any exposed connections along the back of the controller without appropriate grounding.

Issue	Cause	Resolution
Cannot Log in to the Setup Menu	You have forgotten your operator/installer ID.	If the Operator ID has been forgotten, use the Installer ID. If the Installer ID has been forgotten, please contact us to generate a new ID on a per controller basis.
Timer Optimization adjustments are too large	The algorithm is setup to be too aggressive.	Reduce the appropriate scale factor.
Timer Optimization takes too long to adjust to the right value	The algorithm is not setup to be aggressive enough.	Increase the appropriate scale factor.
Fast Trips do not shut in the well	Fast Trips are disabled	Set the Fast Trips in the Alarms menu to something other than disabled.
	The fast trip alarm mode is set to fail open	Change the Fast Trip Fail Mode to Closed in the Alarms menu.
Non-Arrivals do not shut in the well	Non-Arrivals are disabled	Set the Non-Arrivals in the Alarms menu to something other than disabled.
	The non-arrival alarm mode is set to fail open	Change the Non-Arrival Fail Mode to Closed in the Alarms menu.
Controller is sitting in the stopped state	The battery is low	Replace the battery and ensure that the solar panel is connected and positioned correctly.
	Too many fast trips have occurred	Correct the issue with the well and set the controller to resume normal operation.
	Too many non-arrivals have occurred	Correct the issue with the well and set the controller to resume normal operation.

8 Support

8.1 Software Upgrade

On occasion, software upgrades are made available. These releases will contain new features as well as resolutions to issues found in the product. The release notes describe the changes that are available in each release. The new software can be downloaded through the communications port whether the Modbus option is enabled or not.

It is recommended that the controller be removed from the well before the upgrade is performed as the valve operation cannot be trusted during the upgrade.

8.1.1 Prerequisites

The following equipment is required to upgrade the controller:

- Battery
- Laptop with a USB port
- USB to RS485 converter
- Latest firmware file

8.1.2 Setup

1. Ensure that the USB to RS485 adapter is configured in 2 wire mode.
2. Wire the RDA(-) to COM1 A and RDB(+) to COM1 B. The GND can be wired to the unlabeled connection on COM1 between A and B, but is not necessary.
3. Plug adapter into an available USB port.
4. Install the drivers that were provided with the USB to RS485 converter

8.1.3 Upgrade Procedure

1. Hold the ***install*** button down
2. Plug the battery into the controller
3. Release the ***install*** button
4. If the controller does not enter the upgrade program, the previous software that was installed may not include this program.
5. Follow the prompts on the screen to erase the current firmware. To abort the upgrade process at this point, unplug the battery.

6. When prompted to do so, download the firmware
 - a. Open ETC Vision
 - b. Browse to the latest .etc file.
 - c. Select the appropriate COM port from the drop down list.
 - d. Click the Connect button
 - e. Select Download
7. The display on the controller should change to show the status of the download and a progress bar should appear on the screen, showing how much code has been downloaded.
8. When the download is complete, the controller should start normally.

8.1.4 Upgrade Errors

During the download of a firmware image, errors may occasionally occur. If this does happen, simply repeat the procedure again, making sure to erase the current firmware. If an error occurs multiple times in a row, contact Extreme Telematics Corp.

The following is a list of errors that may be seen:

Err 1 – Invalid file format. The Bootloader found information in the serial stream that did not match the expected format. This could be a transmission error or an error with the file.

Err 2 – Dropped Characters. While parsing the incoming stream, extra characters were detected. This typically means that some data was lost.

Err 3 – Character Buffer Overrun. Incoming characters were lost because the controller was too busy processing to service the incoming data.

Err 4 – Flash Buffer Over Run. This means that there is a back log saving to the controller.

Err 5 – Character Buffer Under Run. The controller was expecting to parse more incoming characters, but there are none available.

8.2 Replacement Parts and Accessories

Several replacement parts or accessories are available for purchase. These items are listed in the table below with their associated part numbers. Please contact sales for the current price list.

Table 19 - Available Replacement Parts and Accessories

Part Number	Name	Description
ET-00000-0000-0247	1.1 W Solar Panel	6V, 1.1W CSA Class 1 Div 2 Intrinsically safe solar panel
ET-12001-1008-0001	5 Ah Replacement Battery	CSA approved replacement battery with intrinsically safe protection.
ET-12001-1008-0002	8 Ah Replacement Battery	CSA approved replacement battery with intrinsically safe protection.
ET-12000-1011-0001	Single Valve Assembly, 3/8" tubing, AMP-DUAC connector	Includes a pneumatic valve solenoid, 2 3/8" NPT elbows, an O Ring, Nylon Lock Nut and connector.
ET-12000-1011-0002	Dual Valve Assembly, 3/8" tubing, AMP-DUAC connector	Includes 2 pneumatic valve solenoids, 2 3/8" NPT elbows, a Tee, a 3/8" NPT connector, 2 O Rings, 2 Nylon Lock Nuts, and connectors.
ET-00000-0000-0230	Valve Solenoid Core	Includes the plastic molded solenoid core and wires
ET-00000-0000-0231	Valve Piston and Spring	Includes the internal valve piston and attached spring assembly
ET-12000-1009-0003	Battery Bracket	Replacement bracket used to retain either battery.
ET-11000-1019-0000	Plunger Arrival Sensor	Use with the plunger lift controller to detect a plunger arrival.
ET-00000-0000-0235	2 Pin Connector	2 Pin Weidmuller connector
ET-00000-0000-0236	3 Pin Connector	3 Pin Weidmuller connector

ET-00000-0000-0060	1/2" Liquid Tight Knockout Seal	NEMA rated plug to prevent water and dust from entering unused holes.
--------------------	---------------------------------	---

8.3 Technical Support

8.3.1 Contacting Support

Support is available from your current service technician. If an issue does arise, they should be the first point of contact. Here are the other ways we can be reached:

8.3.1.1 Web

Please visit our website at:

<http://www.wellmaster.com>

8.3.1.2 Phone

Well Master Corporation support can be contacted via phone at our office in Golden, CO at (303) 980-0254 Mon – Fri, 8:00 am to 5:00 pm MST.

8.3.2 Identifying the Issue

Please take the time to identify the issue that is being experienced. Many issues can be resolved by simply upgrading the controller to the latest software. If the issue still persists, please try and determine if there is an issue with the software or hardware. Here are some common indications of each type of issue:

8.3.2.1 Hardware

- Battery is not charging
- Some display pixels do not power up
- The controller display does not come up and the controller does not draw any current
- A key is stuck

8.3.2.2 Firmware

- The controller restarts itself (goes back to close at an incorrect time)
- There are entries in the error log (Located in the System menu)
- Controller behaviour is erratic
- The same issue happens across multiple controllers

8.3.3 Reporting Software Issues

We strive to provide the best software possible that is free of defects. As with any controller, there may be issues. When issues do arise, please do the following:

- Copy down any errors that are found in the error log
- Note the controller configuration
- Note what was being done on the controller when the issue occurred
- Note the serial number and version number of the controller that experienced the issue
- Detail instructions on how to repeat the issue if possible

8.3.4 Repair Process

Please contact your service technician and arrange to have the controller repaired. Please be ready to explain the issues that are being experienced. A detailed account of the problem will be required so that the issue can be addressed in a timely fashion. Returned controllers will take approximately 4 – 6 weeks to be diagnosed and repaired.

9 Acronyms

ADC	Analog-to-Digital Converter
AI	Analog Input
CVC	Configurable Valve Controller
DAC	Digital-to-Analog Converter
DI	Digital Input
DO	Digital Output
ESD	Emergency Shut Down
N/C	Normally Closed
N/O	Normally Open
PAS	Plunger Arrival Sensor
PSI	Pounds per Square Inch
R	Read Permission
RTU	Remote Terminal Unit
R/W	Read/Write Permission
SCADA	Supervisory Control And Data Acquisition
V	Volts
VFD	Vacuum Fluorescent Display
VI	Virtual Input

10 Index

A

Afterflow

Delay Time	60
Duration	47
Maximum	55
Minimum.....	44, 55
Time	22, 39, 55
Valve Configuration	61

Alarms.....

Arrival Guard

Time	67
------------	----

Auto Catch

Delay Time	61
------------------	----

B

Battery

Fail Mode	19, 62
Low.....	19

Baud Rate

C

Casing Line Differential.....

Casing Pressure.....

Absolute	37
Device Type.....	56
Range	57

Rate Drop	38
-----------------	----

Rate Threshold	38
----------------------	----

Switch Polarity	57
-----------------------	----

Change State.....

Close

Duration	47
Maximum	54
Minimum.....	43, 54
Time	22, 54
Velocity.....	54

Close Casing Pressure

Rate Threshold	45, 65
Reset Point	66
Stable Time.....	37, 66
Trip Point.....	37, 45, 65, 66
Type.....	65

Close Differential Pressure

Reset Point	66
Stable Time.....	66
Trip Point.....	66

Current State

D

Danger

Time	23, 52
------------	--------

Trip.....	23	Velocity.....	52
Velocity	52	Flow Differential Pressure	
Data Bits	68	Trip Point.....	45
Date/Time.....	17, 49	Flow Rate	35, 39, 58
Daylight Savings.....	49	Calculated.....	40
Differential Pressure.....	7, 34, 36, 39, 40, 55, 57, 58, 59, 65	Device Type	58
Device Type.....	39	Range	58
Range	57	Reset Point	67
Reset Point.....	39	Sensor.....	40
Switch Polarity	57	Stable Time.....	67
Trip Point.....	39	Switch.....	40
Display	11	Switch Polarity	58
Auto Off	50	Trip Point.....	39, 40, 45, 66
Level.....	50	Virtual.....	40
Dual Valve		G	
Flow Tee.....	25	Gas Temperature.....	59
Tank Valve.....	26, 27	H	
Top Valve	24	Hardware Version.....	50
E		History.....	14, 45
Error Log	51	Cycle Log	46
F		Daily.....	15, 16, 47, 48, 49
Fast Trip	23	Hot Keys.....	14
Count.....	62	I	
Fail Mode	62, 71	Install Menu	49
Time	23, 44, 52, 53, 62	Alarms	62

Inputs	55	N	
Modbus	67	Non-Arrival.....	22
Optimize.....	62	Close Time	43, 54
Outputs	60	Count.....	62
Security	51	Fail Mode	62
System.....	49	O	
Well Setup.....	52	Open	14
Installation.....	2	Open Casing Line Differential Pressure	
Installer ID	51, 71	Reset Point	38, 65
Intermitting	20	Stable Time.....	39, 65
K		Trip Point.....	45, 64
Keypad.....	12	Open Casing Pressure	
L		Reset Point	64
Line Pressure	7, 29	Stable Time.....	64
Device Type.....	56	Trip Point.....	44, 64
Range	56	Operator ID.....	51
Reset Point.....	64	Optimization Type	63
Switch Polarity	56	Orifice Size	59
Trip Point.....	44, 64	P	
Logout.....	51	Parity.....	68
Auto	51	PAS.....	7, 56
M		Delay Time.....	23, 56
Meter Run Size	58	Switch Polarity	56
Minimum Afterflow Casing Pressure.....	47	Plunger Arrival Sensor	7, 21, 56
Modbus.....	19, 67, 69	Plunger Type	52

Pressure Based Optimization	34	Specific Gravity	59
Protocol	67	Station Address.....	67
R		Stop Bits.....	68
Restore Defaults	50	T	
Rise		Tank Delay Time	60
Duration	47	Target Rise	
Time	22, 43, 53, 54, 60	Time	32, 33, 44, 53, 54
Velocity	53	Velocity.....	53
S		Time Format	68
Sales Valve	7	Timer Optimization.....	30, 50
Scale Factor	63, 64	Afterflow	32
Secure Login	51	Trip Delay Time.....	38, 66
Serial Number.....	50	V	
Software Upgrade	72	Valve B	7, 12, 24, 26, 60, 61
Software Version	50	W	
Solar Panel.....	6, 7, 8, 71, 74	Well Depth.....	52