

# *Grizzly* *Industrial, Inc.*®

## MODEL H8068 CLASSIC-STYLE GUITAR KIT OWNER'S MANUAL



COPYRIGHT © NOVEMBER, 2006 BY GRIZZLY INDUSTRIAL, INC. REVISED OCTOBER, 2013 (BL)  
**WARNING: NO PORTION OF THIS MANUAL MAY BE REPRODUCED IN ANY SHAPE  
OR FORM WITHOUT THE WRITTEN APPROVAL OF GRIZZLY INDUSTRIAL, INC.**  
#BL8535 PRINTED IN JAPAN

V1.10.13



# **WARNING!**

**Some dust created by power sanding, sawing, grinding, drilling, and other construction activities contains chemicals known to the State of California to cause cancer, birth defects or other reproductive harm. Some examples of these chemicals are:**

- **Lead from lead-based paints.**
- **Crystalline silica from bricks, cement and other masonry products.**
- **Arsenic and chromium from chemically-treated lumber.**

**Your risk from these exposures varies, depending on how often you do this type of work. To reduce your exposure to these chemicals: Work in a well ventilated area, and work with approved safety equipment, such as those dust masks that are specially designed to filter out microscopic particles.**

# Table of Contents

<b>SECTION 1: SAFETY</b> .....	<b>2</b>
<b>SECTION 2: INTRODUCTION</b> .....	<b>3</b>
Foreword .....	3
Contact Info .....	3
<b>SECTION 3: PARTS INVENTORY</b> .....	<b>4</b>
Inventory.....	4
Supplies/Tools.....	5
Identification .....	6
<b>SECTION 4: ASSEMBLY</b> .....	<b>7</b>
Sanding Body.....	7
Sanding Neck.....	7
Finishing Neck.....	8
Finishing Body.....	9
Mounting Neck .....	10
Positioning Pick Guard, Control Plate & Bridge.....	12
Installing Ferrules .....	14
Mounting Tuners .....	15
Wiring Pickups.....	16
Installing Output Jack.....	17
Installing Bridge and Control Plate.....	17
Strap Buttons.....	18
Installing Nut.....	18
Winding Strings .....	19
String Retainers.....	20
<b>SECTION 5: SETUP</b> .....	<b>21</b>
General.....	21
Neck Adjustment .....	21
String Height.....	22
Pickup Height .....	23
Tuning .....	23
Setting Intonation .....	24
<b>SECTION 6: REFERENCE INFO</b> .....	<b>25</b>
Accessories .....	25
Electrical Components .....	27
Wiring Diagram.....	29
<b>WARRANTY AND RETURNS</b> .....	<b>30</b>

# SECTION 1: SAFETY

---

---

## WARNING

Always wear safety glasses or goggles when operating equipment. Everyday glasses or reading glasses are not safety glasses. Be certain the safety glasses you wear meet the appropriate standards of the American National Standards Institute (ANSI).

Because there are various ways to cut and join wood, you can make substitutions for the methods stated in this plan. We try to suggest the easiest methods possible. However, only you know your skills with each piece of machinery. Never compromise your safety by using a cutting method with which you are not comfortable. Instead, find an alternative approach that will yield the same result.

## WARNING

These instructions assume that you are intimately familiar with the safe operation and use of wood-working machinery and woodworking tools, and that you understand the techniques used to build this project. If you do not qualify for both of these criteria, **STOP building this project for your own safety.** Read and understand the owners manual for the machinery you intend to use, take a woodworking class or visit your local library for more information. Woodworking machinery and tools are inherently dangerous because they use sharp edges that can cause serious personal injury including amputation and death. Do not underestimate the ability of these tools and machinery to cause injury. Never operate any tool without all guards in place and always wear approved safety glasses. For your own safety, please heed this warning.

# SECTION 2: INTRODUCTION

---

---

## Foreword

---

---

We are proud to offer the Model H8068 Classic-Style Guitar Kit. This kit is a part of a growing Grizzly family of fine woodworking products. When assembled according to the guidelines set forth in this manual, you can expect years of enjoyment from your guitar.

We are pleased to provide this manual for the Model H8068 Classic-Style Guitar Kit. It was written to guide you through assembly, review safety considerations, and cover general information. It represents our effort to produce the best documentation possible.

## Contact Info

---

---

If you have any comments regarding this manual, please write to us at the address below:

Grizzly Industrial, Inc.  
c/o Technical Documentation Manager  
P.O. Box 2069  
Bellingham, WA 98227-2069  
Email: manuals@grizzly.com

We stand behind our products. If you have any service questions or parts requests, please call or write us at the location listed below.

Grizzly Industrial, Inc.  
1203 Lycoming Mall Circle  
Muncy, PA 17756  
Phone: (570) 546-9663  
Fax: (800) 438-5901  
E-Mail: techsupport@grizzly.com  
Web Site: <http://www.grizzly.com>



# SECTION 3: PARTS INVENTORY

## Inventory

REF PART#	DESCRIPTION	QTY	
1	PH8068001	Guitar Body	1
2	PH8068002	Neck	1
3	PH8068003	Pickguard	1
4	PH8068004	Silver Neckplate	1
5	PH8068005	Black Neckplate Setter	1
6	PH8068006	Tuning Machines	6
7	PH8068007	Audio Patch Cable	1
8	PH8068008	Control Plate	1
9	PH8068009	Bridge	1
10	PH8068010	Bushing	6
11	PH8068011	Output Jack Cover	1
12	PH8068012	Strings	6
13	PH8068013	Strap Buttons	2
14	PH8068014	#7 x 1-3/8" SS Screws	4
15	PH8068015	#5 x 5/8" SS Screws	4
16	PH8068016	#3 x 3/8" SS Screws	12
17	PH8068017	#2 x 3/8" SS Screws	13
18	PH8068018	#4 x 15/16" SS Screws	2
19	PH8068019	Bushing 3/32" x 3/16" x 3/32"	1
20	PH8068020	String Retainer	1
21	PH8068021	String Nut	1
22	PH8068022	Ferrules	6
23	PAW04M	Hex Wrench 4mm	1
24	PAW01.5M	Hex Wrench 1.5mm	1

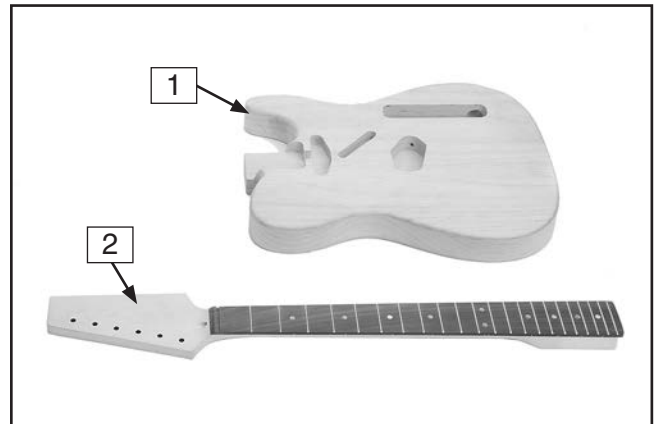

Figure 1. Boxed components.

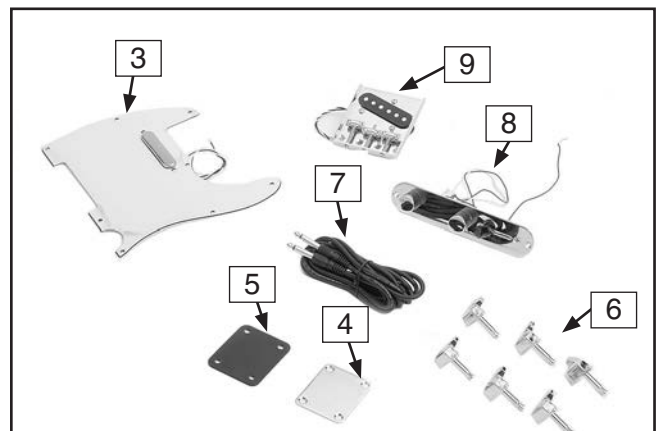

Figure 2. Guitar parts.

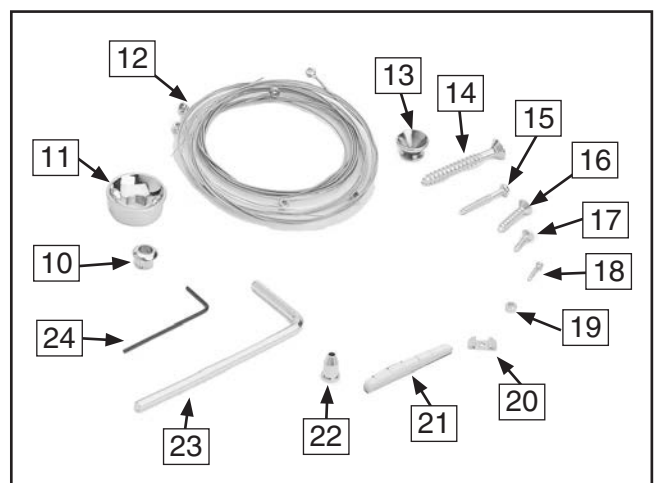

Figure 3. More guitar parts.



# Supplies/Tools

---

---

The majority of the wooden components in this kit are fully machined from the factory and are ready for assembly. A small amount of sanding and finishing is required to complete your guitar.

## Recommended Tools & Supplies:

- Sharp Pencil
- Drill Press
- Drill Bits:  $\frac{1}{16}$ " ,  $\frac{7}{64}$ " ,  $\frac{1}{8}$ " ,  $\frac{5}{16}$ " ,  $\frac{1}{4}$ "
- Electric/Cordless Drill
- Depth Stop
- NIOSH Approved Respirator
- ANSI Approved Safety Glasses
- Aluminum-Oxide Sanding Paper #150, #220 and #320 Grit
- Wet and Dry Sanding Paper #400, #600, and #1000 Grit
- Flexible Sanding Block
- Wood Glue
- Chisel or Razor Blade
- Phillips Head Screwdriver #1, #2
- $\frac{1}{4}$ " Steel Rod or a Coat Hanger
- Masking Tape

- Tack Cloth or Clean Soft Rag
- Sanding Sealer
- Assorted Wood Files
- Buffing Compounds
- Oil Wood Finish
- Soldering Iron and Solder
- Peghead Reamer or a Round File
- Rubber Dead Blow Hammer
- Tweezers, Pliers, Wire Cutters
- C-Clamps
- Temporary Wood Handle: Approximately 1" x 2" x 16"
- Guitar Capo
- Feeler Gauge Set
- Spray Primer and Finish (See Note below)
- Spray Gun and Compressor
- 18" Metal Straightedge ( $\frac{1}{32}$ " Resolution)
- 36" Metal Straightedge
- Steel Ruler ( $\frac{1}{64}$ " Resolution)
- Wood Dowel
- Wooden Blocks: Approximately 4" x 4" x 12" (2)
- Wood Shim  $\frac{7}{16}$ " Thick

**Note:** Use the same type of paint for primer and finish—either enamel or lacquer base. Do not use different base paints for priming or finishing or your results may not be desirable.



# Identification

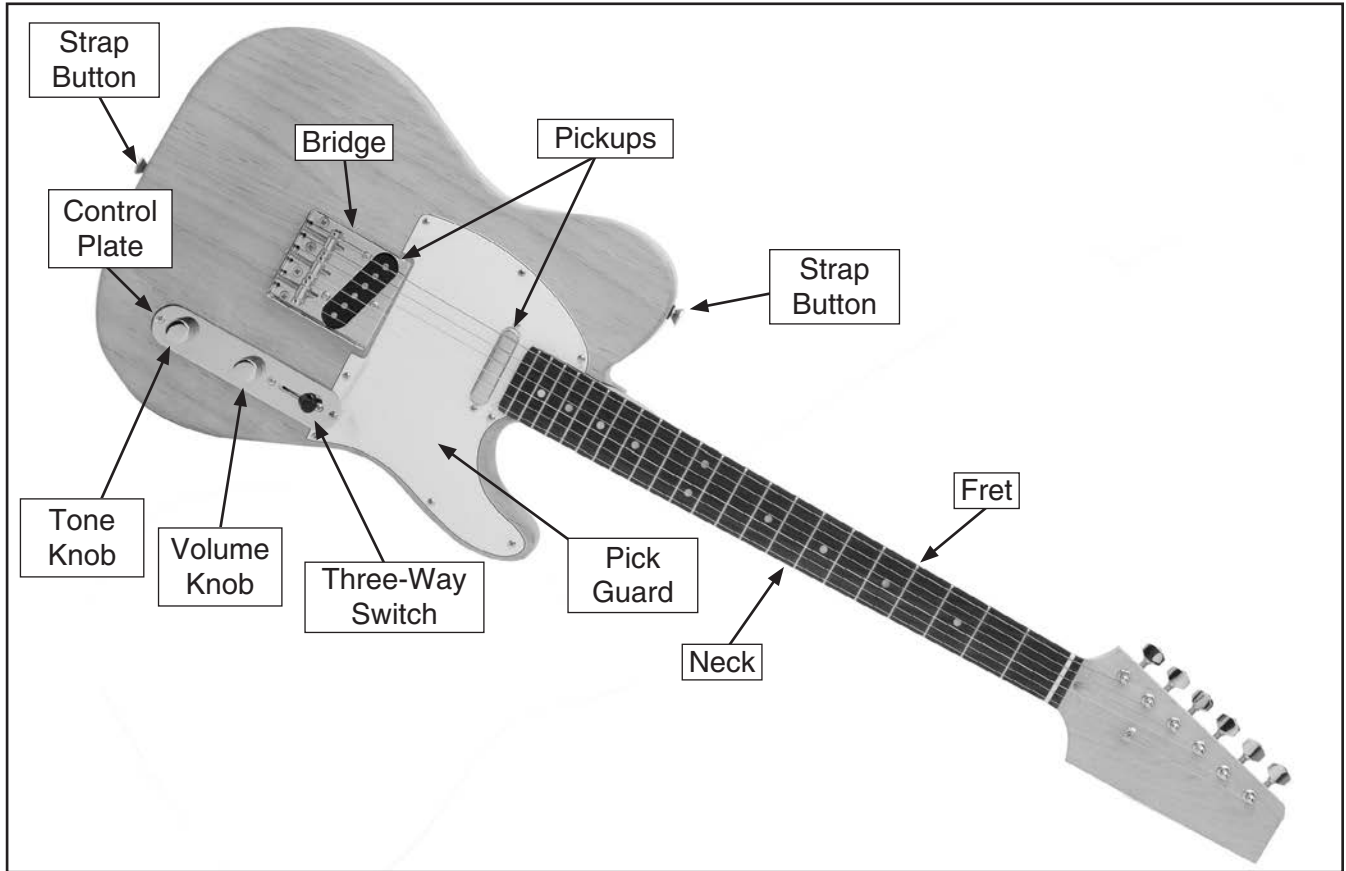

**Figure 4.** Model H8068 controls.

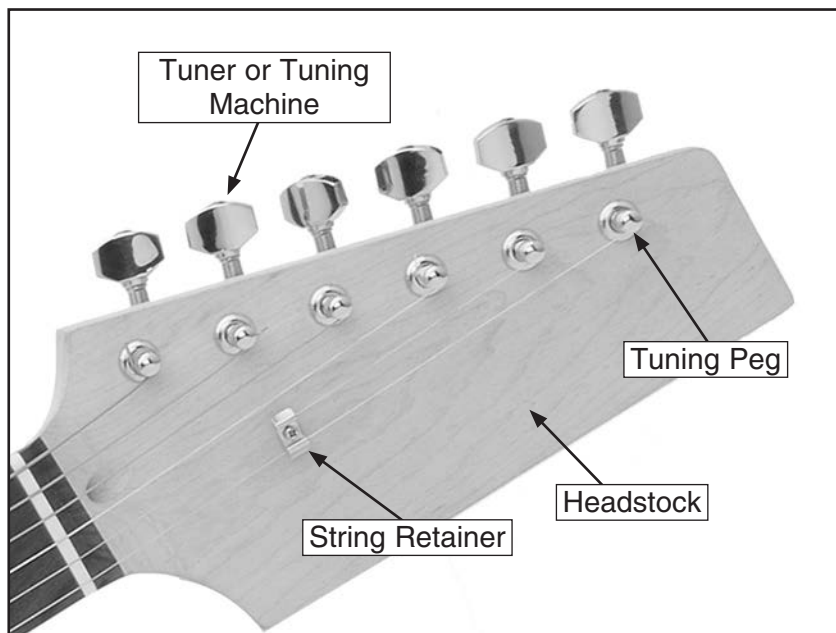

**Figure 5.** Model H8068 headstock features.





# SECTION 4: ASSEMBLY

---

---

## Sanding Body

---

---

The guitar body has been sanded at the factory, but it is up to you to do the final sanding before the finish is applied. To get a good finish, the body should be sanded with a series of sandpaper grits up to #320 grit.

**Components and Hardware Needed:** Qty  
Guitar Body ..... 1

### To sand the guitar body:

1. **Wear a NIOSH-approved respirator and ANSI-approved safety glasses when sanding wood!**
2. Use a flexible sanding block with #150 grit aluminum-oxide sanding paper to sand the guitar body until there is a consistent scratch pattern on the entire surface.

**Note:** *DO NOT round over the neck pocket or the body cavities.*

*When hand sanding, always sand in the same direction as the wood grain.*

3. Resand the entire guitar body with #220 grit sanding paper and lightly round over the outside edges of the body.
4. Wipe the guitar body with a damp cloth to “raise” the wood grain.
5. Wait until the wood is dry and resand the entire body with #220 grit sandpaper to sand the “raised” grain smooth.

6. Repeat **Step 4 & 5.**

**Note:** *If you want to stain your guitar, the stain should be applied now before continuing with the next step. Stains cannot be applied to the guitar body after the sanding sealer is applied.*

7. Apply a primer if you plan to paint the guitar a solid color. Apply a coat of sanding sealer if you stained the guitar. Use the sealer or primer according to the manufacturer's instructions.

**Note:** *Make sure the primer or sealer you use is compatible with your finish.*

8. When the sanding sealer or primer is dry, use #320 grit sandpaper for final sanding. **DO NOT** sand through to bare wood.

## Sanding Neck

---

---

Like the guitar body, the guitar neck has been rough sanded at the factory. Final sanding should be done as described in the previous sub-section **Sanding the Body**. Consider applying inlays or additional design work on the fretboard and headstock before final sanding.

**Note:** *If you are considering inlays or other design work, take your time and test your designs in scrap wood before performing the work on the instrument.*

The fretboard requires no sanding. Sanding the fretboard will affect the playability of the guitar and could lead to unreparable damage.



# Finishing Neck

Some of the finishing options include stains, lacquers, varnishes and oil finishes. Traditionally this style of guitar has a clear finish on the neck. Depending on the type, finishes can be applied with a spray gun, brush, rag, or a spray can. Finish materials and books on finishing instruments can be ordered through Grizzly Industrial or numerous luthier supply catalogs.

**Components and Hardware Needed:** Qty  
Guitar Neck ..... 1

## To finish the guitar neck:

1. Mask off the surface of the fretboard. Carefully press all the masking tape edges securely to the fretboard. The finish coat can seep under these edges, especially near corners, uneven edges, and places where the frets meet the fingerboard.
2. Make an "S" shaped hook out of  $\frac{1}{4}$ " steel rod, or a coat hanger that has been folded in half.
3. Wipe the entire neck with a tack cloth or a soft clean rag to remove any dust.
4. Thread the hook through the upper peghole and hang the neck in the finishing room.



5. Apply the finish according to **Finishing the Body, Steps 5–11, on Page 9.**
6. Before wet sanding, remove the masking tape from the fretboard and carefully scrape any excess finish off the fretboard with a razor blade or chisel, as shown in **Figure 6.**

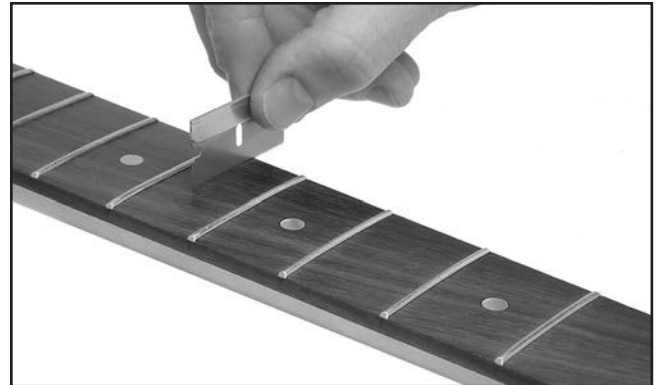

**Figure 6.** Scraping the fretboard.

7. Use a clean rag to wipe wood finishing oil on the surface of the fretboard.



# Finishing Body

This guitar looks incredible with a clear finish to highlight the wood grain patterns. The surface can be stained prior to finishing or a transparent pigment can be added to the finish. These instructions guide you through a very basic finishing process. Books describing different guitar finishing techniques are available through luthier supply catalogs, or through your local library. Clear finish materials and books on finishing can be ordered through Grizzly Industrial. Finishing a guitar is a difficult task. If you are unsure of your skills; do your research, practice on scrap wood, or take it to a professional.

Components and Hardware Needed:	Qty
Guitar Body .....	1

## To finish the guitar body:

1. Mask off the neck pocket. Press the masking tape tight against the edges of the pocket so the finish does not seep under the tape.
2. Screw through the neck pocket screw holes into a long piece of wood to use for a handle during spraying. Drill a hole in the end of the handle for hanging from a hook.
3. Wipe the entire guitar body with a tack cloth or a soft clean rag to remove any dust.
4. Thread the hook through the temporary handle and hang the body in the finish room.
5. Apply several thin coats of the finish, following the manufacturer's instructions. Multiple thin coats usually produce a better quality finish than one heavy coat.

6. Sand the entire body with #400 grit wet and dry sandpaper after at least three coats of finish have been applied. DO NOT sand through the finish—be especially careful on the edges.

7. Apply more finish, sanding between coats, until the finish is the desired thickness.

**Note:** *If finishing with a solid color, you may wish to apply several coats of a clear finish over the top, sanding between coats, to add depth to the finish.*

8. When the final coat has dried at least a week, preferably a month, remove the temporary handle and masking.

9. Wet sand the finish using #600 grit wet and dry sandpaper on a sanding block, followed with #1000 grit wet and dry sandpaper.

10. Buff the finish by hand or with a buffer, starting with a medium polish and work up to a high gloss polish.

**Note:** *If using a buffing machine, be extremely careful to avoid going through the finish, especially on the edges.*

## NOTICE

Dust particles suspended in the air will settle on wet finishes, causing less than satisfactory results. To avoid this problem:

- Leave the finishing room undisturbed for 24 hours prior to applying the finish.
- Avoid making unnecessary movements upon entering the finish room.
- Apply the finish to the desired guitar parts and immediately leave the finish room.
- DO NOT return to the room until the specified drying time has elapsed.



# Mounting Neck

Components and Hardware Needed:	Qty
Guitar Body .....	1
Neck .....	1
Silver Neckplate.....	1
Black Neckplate Setter.....	1
#7 x 1 $\frac{3}{8}$ " Stainless Steel Screws .....	4

**Note:** Unless otherwise indicated, we strongly recommend using a drill press for the majority of drilling in this manual to obtain the most precise results. However, an electric/cordless drill fitted with a depth stop or a drill stand can be used if you do not have a drill press.

## To mount the neck to the guitar body:

1. Insert the neck into the neck pocket, and check to make sure the neck and body are flush as shown in **Figure 7**.

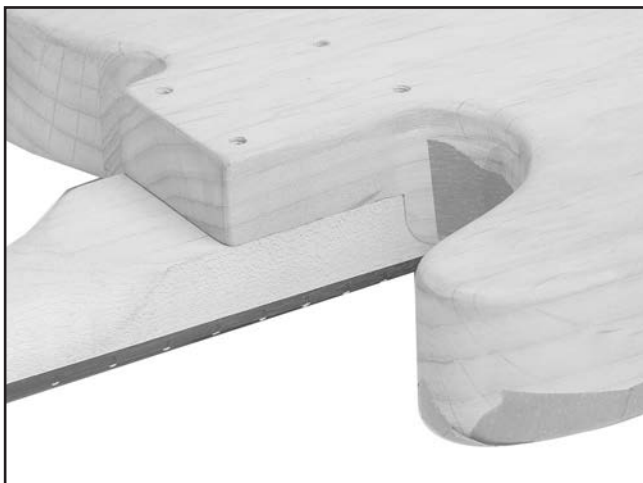

**Figure 7.** Making neck and body flush.

2. Clamp the neck and body together.

3. Set the guitar facedown on top of two 4x4's (cut to 12") for support.
4. Insert a  $\frac{1}{8}$ " drill bit into a neck hole (**Figure 8**). While pressing down slightly, twist the drill bit by hand to make a pilot hole.



**Figure 8.** Making a pilot hole in the neck.

5. Unclamp the neck from the body.

## To determine neck mounting hole depth:

1. Secure the  $\frac{1}{8}$ " drill bit in the drill press chuck, raise the table, and set the neck fretboard-down on the table.
2. Set the drill press depth stop so the tip of the bit will ONLY drive half way through the eck.

**Note:** Correctly set the depth stop or the bit may drill through the fretboard!



### Another way to determine neck mounting hole depth (Optional):

1. Insert the neck into the neck pocket.
2. Place the neckplate and neckplate setter on top of the body so a mounting hole protrudes beyond the body and neck.
3. Insert a #7 x 1<sup>3</sup>/<sub>8</sub>" screw through the plates so it hangs down to the side of the neck and body.
4. Gently mark the screw tip depth with a pencil (**Figure 9**).

**Note:** You may want to cover the screw tip marking location with masking tape to avoid scratching the finish.



**Figure 9.** Using screw tip depth to set depth stop.

5. Set the neck fretboard face down on the drill press table, and set the depth stop to the mark from **Step 4**.

### To drill mounting holes in the neck:

1. Lower the 1/8" drill bit over the center of a pilot hole and drill the hole.
2. Repeat **Step 1** for each of the three remaining pilot holes.

### To mount the neck to the body:

1. Insert the neck into the neck pocket, and place the neckplate and neckplate setter on the body.

**Note:** Do not glue the neck to the body.

2. Align the mounting holes in the neck and body.
3. Fasten the four #7 x 1<sup>3</sup>/<sub>8</sub>" screws, but do not final tighten them (**Figure 10**).



**Figure 10.** Fastening neck to body.



# Positioning Pick Guard, Control Plate & Bridge

The following steps require you to mark the guitar body. To avoid damaging the finish, place masking tape on the guitar body and gently mark the tape.

In the following steps the bridge, control plate, and pick guard will be installed temporarily to correctly orient them.

<b>Components and Hardware Needed:</b>	<b>Qty</b>
Guitar Body and Neck.....	1
Pick Guard.....	1
Control Plate.....	1
Stainless Steel Screws #3 x 3/8".....	10
Bridge.....	1
Stainless Steel Screws #5 x 5/8".....	4

## To position the pick guard, control plate and bridge:

1. Remove the neck from the guitar body.
2. Thread the pick guard pickup wires through the center cavity into the control plate cavity, then place the pick guard on the body.
3. Secure the neck to the body.
4. Tuck the control plate wires into the control plate cavity.
5. Place the control plate on the body so it fits snugly into the curve on the pick guard as shown in **Figure 11**.

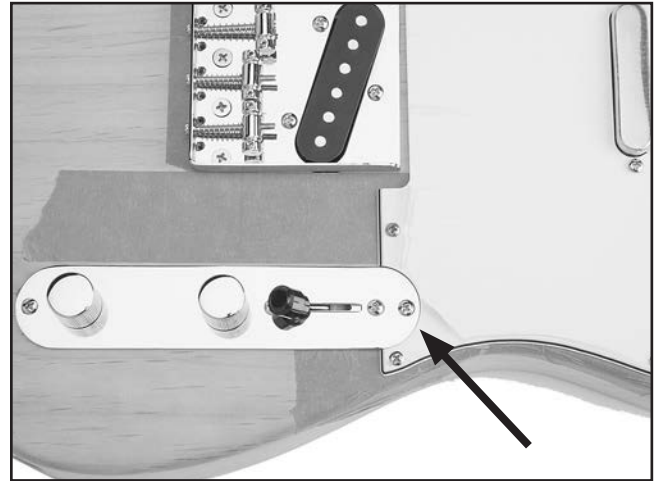

**Figure 11.** Control plate fits into pick guard.

6. Place a long straightedge over the center of the fretboard inlays and over the bridge cavity, and mark the center line on the guitar body (**Figure 12**).

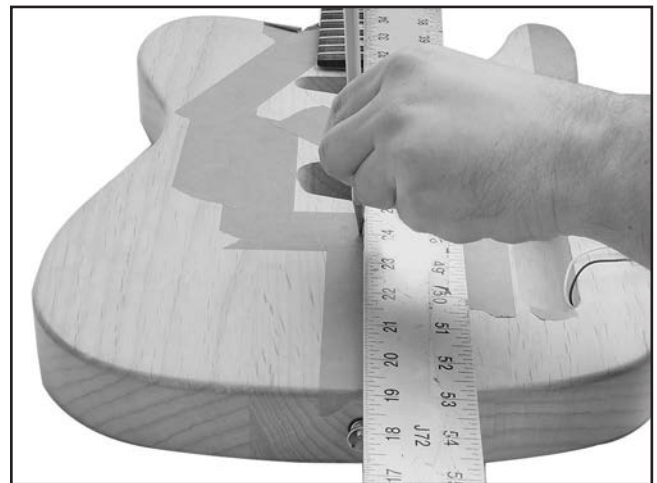

**Figure 12.** Marking center line.

7. Place a ruler across the body at several locations and mark the half way point to double check the center line location against the mark in **Step 6**.





8. Insert the bridge into the bridge cavity and align the bridge with the guitar center line.
9. Using the long straightedge, measure  $25\frac{1}{2}$ " from the fretboard side of the nut slot (**Figure 13**) along the center line to the bridge point (**Figure 14**), and mark this location on the guitar.

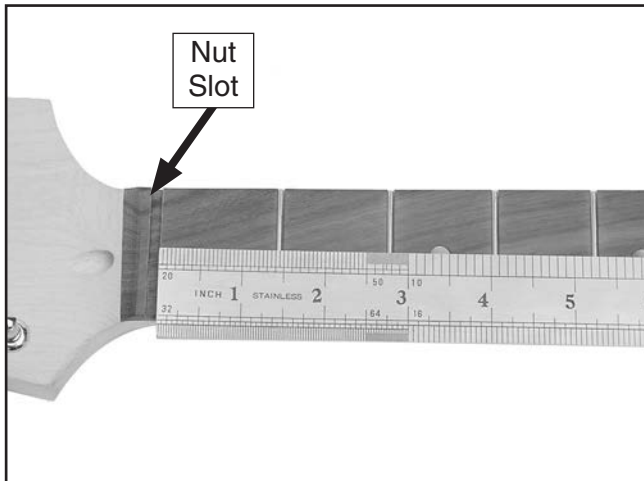

**Figure 13.** Measuring  $25\frac{1}{2}$ " from nut along center line.

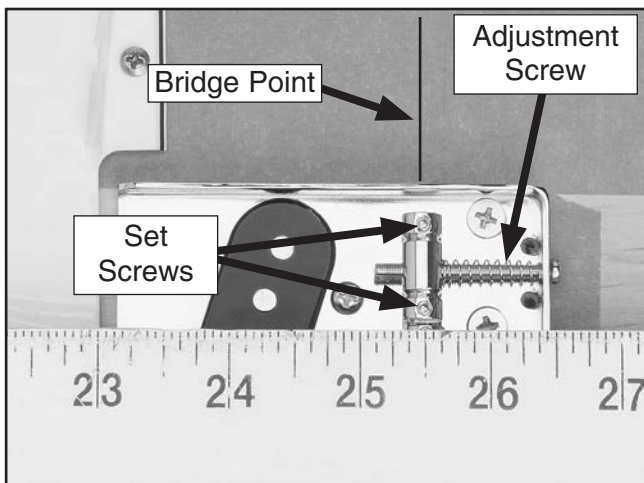

**Figure 14.** Bridge point and high E saddle adjustment screw.

10. Using a Phillips head screwdriver, turn the lower saddle adjustment screw so the set screws shown in **Figure 14** are centered over the bridge point.

11. Align the control plate, pick guard, and bridge so the bridge is parallel to the control plate (leave an even distance between the pickguard and bridge).
12. Mark the mounting holes for the control plate (**Figure 15**), pick guard, and bridge, then remove these components and the neck.

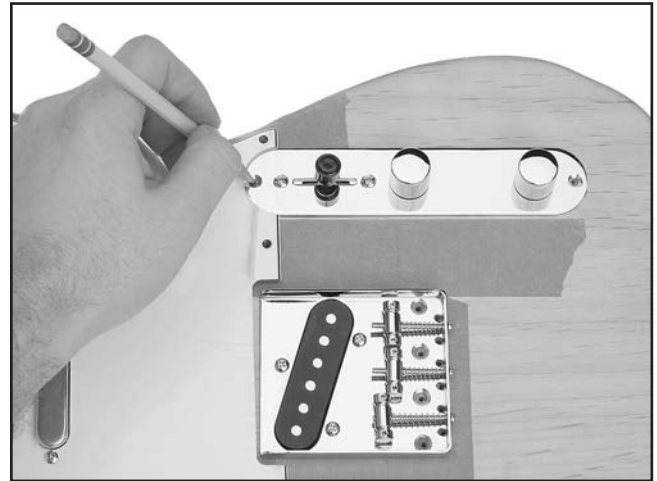

**Figure 15.** Marking control plate holes.

**Note:** Take care to correctly position the control plate mounting holes so you do not drill into the control plate cavity.

13. Using a  $\frac{1}{16}$ " drill bit, drill  $\frac{3}{8}$ " deep holes in the body for the pick guard and control plate.
14. Set the depth stop on the drill press to  $\frac{7}{8}$ " and drill the four bridge mounting holes with a  $\frac{7}{64}$ " drill bit.
15. Mount the pick guard and control plate to the body with the #3 x  $\frac{3}{8}$ " screws, secure the neck to the body, and fasten the bridge with the four #5 x  $\frac{5}{8}$ " screws.
16. Determine whether you want to mount the strings through the bridge or whether you want to mount them to the body using the ferrules.

—If you decide to mount the strings through the bridge, skip to **Mounting Tuners, Page 15**.

—If you decide to mount the strings through the body, go to **Installing Ferrules, Page 14**.



# Installing Ferrules

The strings can be installed optionally through the body using the ferrules. One advantage of using the ferrules is that the strings will sustain notes longer. Ferrules can be mounted flush (**Figure 16**) or above (**Figure 17**) the surface of the guitar.

Components and Hardware Needed:	Qty
Guitar Body .....	1
Ferrules .....	6

## To install the ferrules:

1. Mark the six string holes (**Page 6**) on the bridge. (The holes are parallel with the guitar body.)

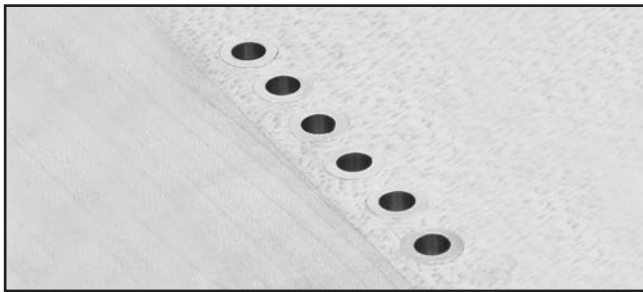

**Figure 16.** Flush mounted ferrules.

**Tip:** You can mark the holes using a drill bit mounted in a drill press. Position the drill bit in a ferrule hole and, with the drill **OFF**, turn the chuck by hand until the bit breaks the wood surface.



**Figure 17.** Above surface mounted ferrules.

2. Remove the neck, pick guard, control plate and bridge.
3. Secure a  $\frac{7}{64}$ " drill bit in the drill press.

4. To minimize tear out, tape the back of the guitar where the pilot bit will emerge from the ferrule holes, and place a board under the guitar.
5. Drill the pilot holes through the body.
6. Determine whether you want to flush mount the ferrules or let them sit above the body. For flush mounting instructions, go to **Flush Mounting**. To mount ferrules above the guitar body, go to **Above Surface Mounting**.

## Flush Mounting

1. Place the body topside down on a drill press and drill  $\frac{15}{32}$ " down into the pilot hole using a  $\frac{1}{4}$ " bit.
2. Using a  $\frac{5}{16}$ " drill bit, drill  $\frac{1}{16}$ " deep into the pilot holes.

**Note:** We recommend setting the depth stop and using a  $\frac{5}{16}$ " end mill for greater precision.

3. Repeat **Steps 1-2** for each of the other ferrule holes.
4. Set the ferrules into the holes so they are flush with the surface of the guitar.

## Above Surface Mounting

1. Place the top of the guitar face down on a drill press table, then drill  $\frac{13}{32}$ " down into the pilot hole using a  $\frac{1}{4}$ " bit.
2. **Note:** We recommend setting the depth stop for greater precision.
3. Repeat **Steps 1-2** for the five other ferrules.
4. Set the ferrules into the holes.
5. Go to **Mounting Tuners** on **Page 15**.





# Mounting Tuners

Components and Hardware Needed:	Qty
Neck .....	1
Tuners.....	1
Stainless Steel Screws #2 x $\frac{3}{8}$ " .....	2
Bushings.....	6

## To install the tuners:

1. Place the neck fretboard down on a flat surface and insert the tuners into the pre-drilled peghead holes.
2. Use a ruler to align the tuners so they are parallel, and mark the mounting holes as shown in **Figure 18**.

**Note:** Taping the ruler to the peghead may lessen movement while marking the tuner mounting holes.

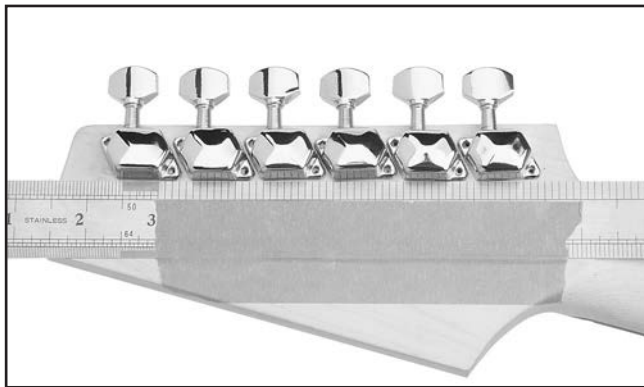

**Figure 18.** Tuners aligned.

3. Remove the tuners.
4. If the neck is attached to the body, remove it now.
5. Fasten a  $\frac{7}{16}$ " thick wood shim with tape on the top side of the peghead near the tip (**Figure 19**). This will help stabilize the neck during the next step.
6. Using a  $\frac{1}{16}$ " drill bit, drill  $\frac{3}{8}$ " deep holes into the back of the peghead (**Figure 19**).

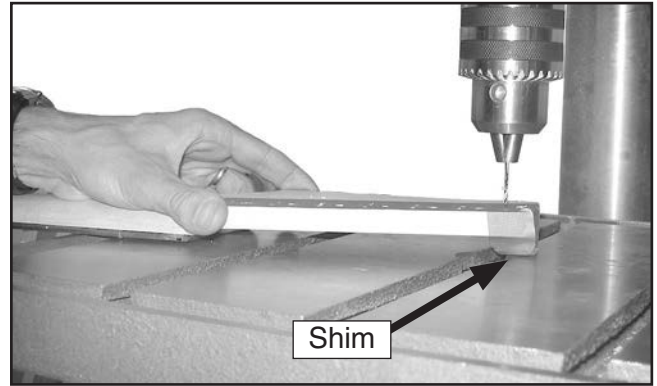

**Figure 19.** Peghead supported with shim.

**Note:** Drilling the holes deeper than  $\frac{3}{8}$ " could result in drilling out through the top of the peghead. Set the correct depth with the depth stop on your drill press.

7. Place the pegboard face up on a level surface, and use a dead blow hammer or a dowel in a drill press to drive the six bushings into the tuner mounting holes (**Figure 20**).

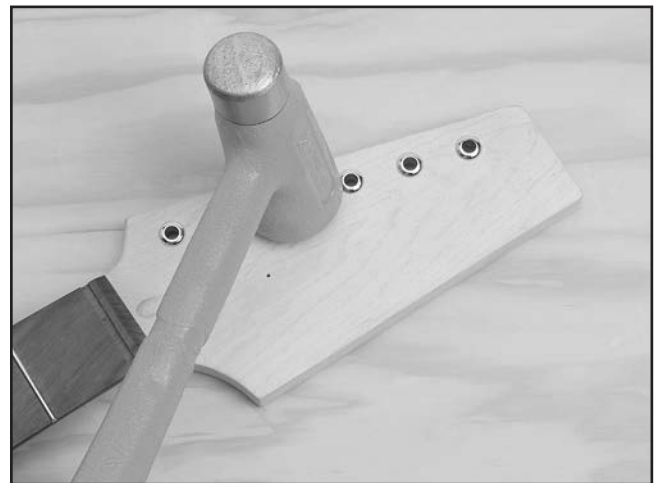

**Figure 20.** Installing bushings on peghead.

**Note:** If you have trouble inserting the bushings, turn a drill bit by hand in the top of the hole to widen it just enough to insert the bushing.

8. Turn the neck over, insert the tuners into the bushings, and mount them with the #2 x  $\frac{3}{8}$ " screws.



# Wiring Pickups

This guitar comes with a control plate that has most of the components soldered in place. You only need to solder the pickup wires onto the three way switch and volume control. If done incorrectly, soldering the wires may cause damage to the components. If you are unsure of your skills; do your research, practice on scrap wires, or take it to a professional.

Components and Hardware Needed:	Qty
Guitar Body .....	1
Control Plate.....	1
Pick Guard.....	1
Bridge .....	1

## To wire the pickups:

1. Remove the bridge and control plate.
2. Thread the pick guard pickup and bridge pickup wires through the channels and holes into the control plate cavity as shown in **Figure 21**.

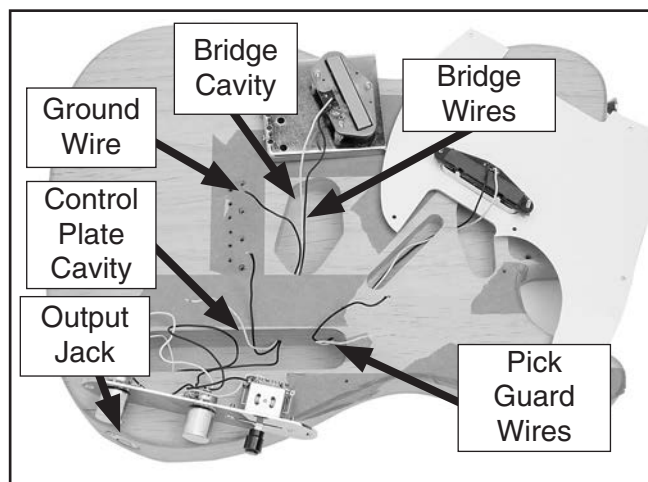

**Figure 21.** Wires threaded through body.

3. Thread the ground wire through the hole in the control plate cavity into the bridge cavity (**Figure 21**).
4. Push the audio jack out through the hole in the end of the body.
5. Solder the pickup wires onto the volume and three way switch as shown in the **Wiring Diagram** on **Page 29** and the **Electrical Photos** on **Pages 27-28**.
6. Remove the plastic wrapping on the pick guard, if you have not already done so.
7. Fasten the pick guard to the body with the #3 x  $\frac{3}{8}$ " screws. Do not fasten the control plate or bridge yet.



# Installing Output Jack

Components and Hardware Needed:	Qty
Output Jack .....	1
Output Jack Cover.....	1
Stainless Steel Screws #3 x $\frac{3}{8}$ " .....	2

## To install the output jack:

1. Thread the output jack onto the jack cover.
2. Place the output jack cover in the jack cavity, and mark the mounting holes.
3. Using a  $\frac{1}{16}$ " drill bit, drill  $\frac{3}{8}$ " holes at a  $45^\circ$  angle into the body as shown in **Figure 22**.

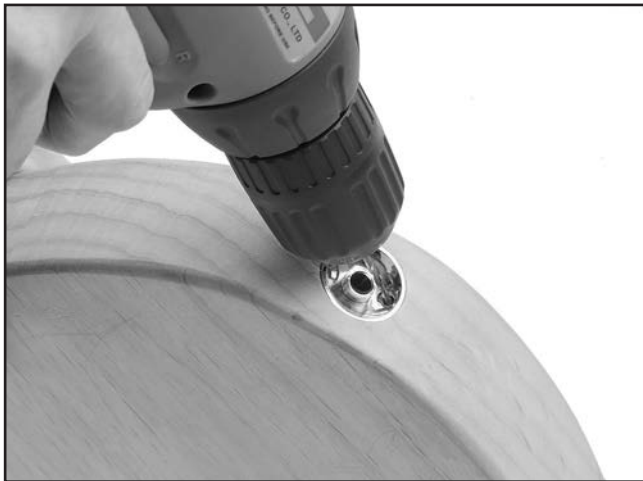

**Figure 22.** Drilling output jack mounting holes.

4. Mount the output jack cover with two #3 x  $\frac{3}{8}$ " screws.

# Installing Bridge and Control Plate

To reduce humming, the ground wire must contact the bridge plate.

Components and Hardware Needed:	Qty
Guitar Body .....	1
Bridge .....	1
Control Plate.....	1
Stainless Steel Screws #5 x $\frac{5}{8}$ " .....	4
Stainless Steel Screws #4 x $\frac{15}{16}$ " .....	2

## To position the ground wire under the bridge:

1. Place the exposed end of the ground wire above the bridge cavity (see **Figure 23**), and place the bridge over it so the bridge and wire make contact.
2. Tape the ground wire in the bridge cavity to keep the exposed portion from moving.



**Figure 23.** Ground wire above bridge cavity.

3. Secure the bridge with the #5 x  $\frac{5}{8}$ " screws and the control plate with the #4 x  $\frac{15}{16}$ " screws.



# Strap Buttons

The strap buttons are positioned on the guitar as shown in **Figure 24**.

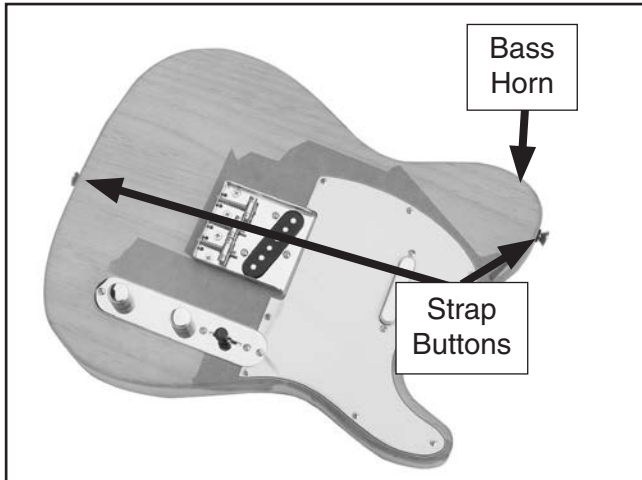

**Figure 24.** Strap buttons.

Components and Hardware Needed	Qty
Guitar.....	1
Stainless Steel Screws #4 x 15/16" .....	2
Strap Buttons.....	2

### To attach the strap buttons to the guitar:

1. Using a 1/16" drill bit, drill 3/4" deep holes at the end of the guitar—on the center line— and on the bass horn (**Figure 24**).
2. Secure each of the strap buttons to the guitar body with a #4 screw.

# Installing Nut

Components and Hardware Needed:	Qty
Guitar Body .....	1
Nut .....	4
Neck .....	1
Black Neckplate Setter .....	1
Silver Neckplate .....	1
Stainless Steel Screws #7 x 1 3/8" .....	4

### To install the nut:

1. Install the neck onto the body.
2. Use a chisel or razor blade to scrape any finish out of the nut slot. **DO NOT** remove any wood from the nut slot.
3. Sand one side of the nut on a piece of sandpaper by hand until it fits snugly into the nut slot as shown in **Figure 25**. Make sure the large slots on the nut face the top of the neck and the small slots face the bottom of the neck.

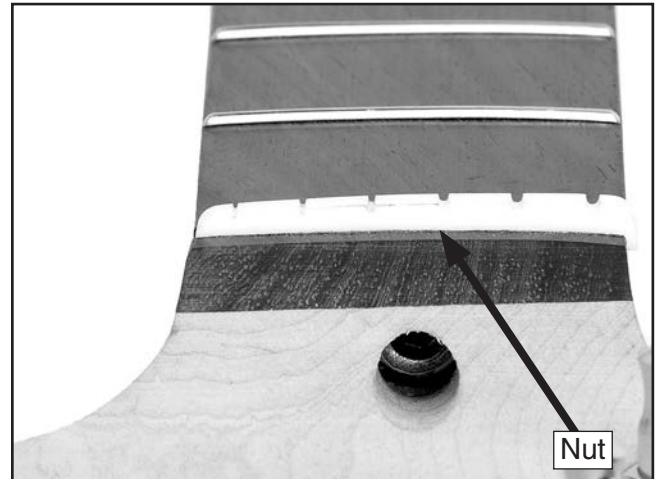

**Figure 25.** Nut installed.

4. Remove the nut, spread a thin layer of glue in the nut slot, and center the nut in the nut slot.
5. Install the strings, as described on **Page 19**, to hold the nut in place until the glue dries.
6. Wipe away the excess glue before it sets up, then allow the glue to dry for 24 hours.



# Winding Strings

Strings can be installed through the body using the ferrules or they can be installed through the bridge.

Components and Hardware Needed:	Qty
Guitar.....	1
Strings .....	6

The correct position of the guitar strings is shown in **Figure 26**. The thin High E string is the "1st" string and the thick Low E string is the "6th."

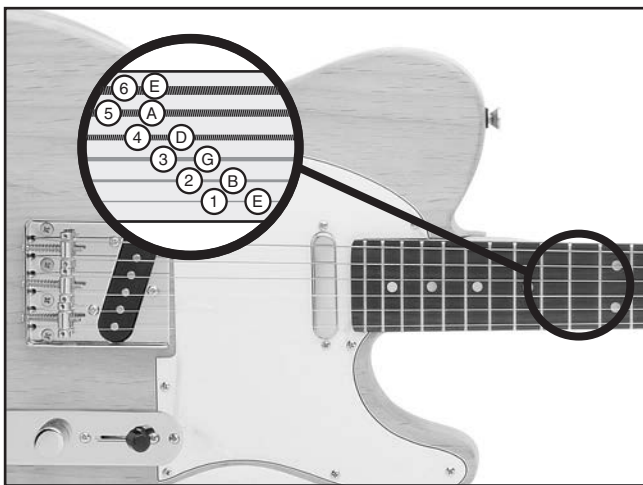

**Figure 26.** Correct string locations.

## To install strings through the body:

1. If you installed ferrules, thread the 1st string through the ferrule as shown in **Figure 27**.

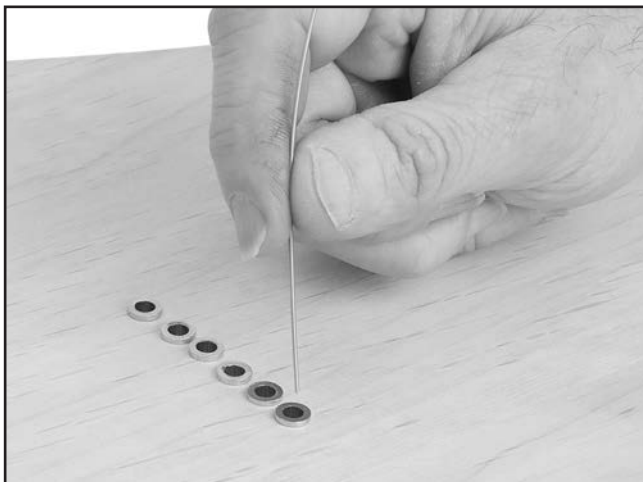

**Figure 27.** Threading string through ferrule.

2. Thread the string through the hole in the top of the guitar and through the bridge.
3. Guide the string across the saddle, over the nut, and through the hole in the corresponding tuner.
4. Allow only enough slack in the string for 2-3 rotations around the tuner.

**Note:** *If too much slack is allowed, then the string could wind off the machine head after many successive rotations. If not enough slack is allowed, then the string may not hold the winding tension.*

5. Bend the string at a right angle across the edge of the machine head.
6. Rotate the tuners until the string just begins to hold the winding tension (**Figure 28**).

**Note:** *DO NOT tighten the strings beyond the initial tensioning at this time. Final tensioning should be completed during the string tuning process.*



**Figure 28.** String wrapped around tuner.

7. Use wire cutters (optional) to cut off the excess string.
8. Repeat the above process for the remaining strings.





### To install the strings using only the bridge:

1. Slide the 1st string through the corresponding hole in the bridge (**Figure 29**).
2. Repeat **Steps 3-8** in the previous subsection.

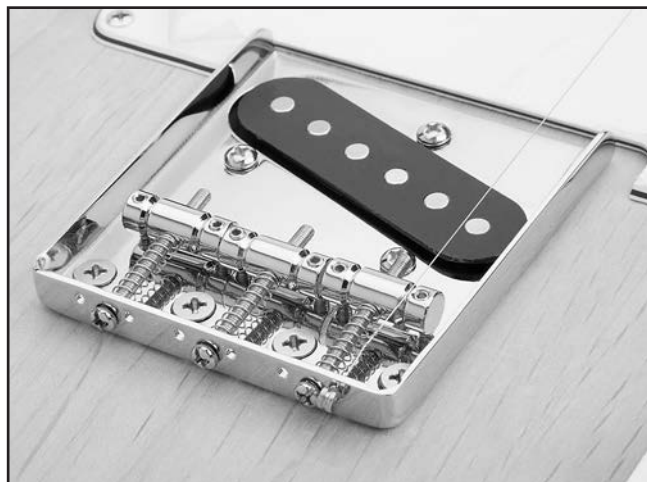
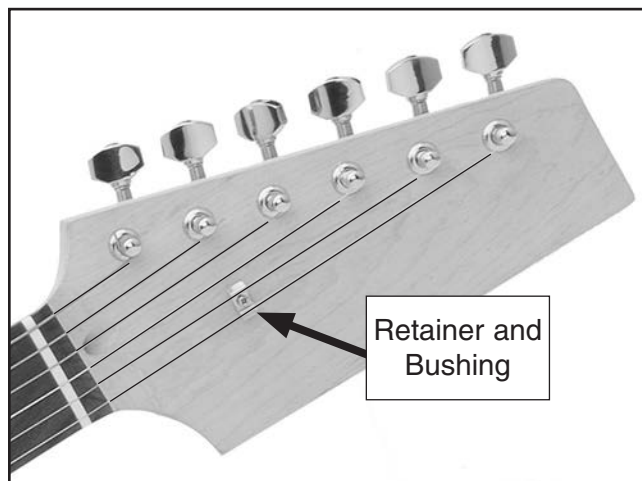

**Figure 29.** 1st string installed.

## String Retainers

Components and Hardware Needed:	Qty
Guitar.....	1
Retainer.....	1
Stainless Steel Screw #2 x 3/8".....	1
Bushing.....	1

The string retainer mounts between the 1st and 2nd strings (**Figure 30**).



**Figure 30.** String retainer locations.

### To install the string retainer:

1. Place the string retainer on top of the 1st and 2nd string near the second tuner.
2. Using a 1/16" drill bit, drill 1/4" deep holes straight through the holes in the string retainers.

**Note:** *Drilling the holes deeper than 1/2" could result in drilling out the bottom of the peghead.*

3. Slide a #2 x 3/8" screw through a retainer and small bushing, and fasten it to the back hole on the headstock (**Figure 30**).



# SECTION 5: SETUP

## General

Guitar set up is an art that requires skill, patience and experience. If you have the patience, you can acquire the skill and experience. If you don't have the patience, you may want to have your guitar set up by a qualified guitar technician.

This section on set up is a general overview of set up practices. We highly recommended that you research more in-depth methods. Books on setting up electric guitars can be ordered through Grizzly Industrial, luthier supply catalogs, or may be available through your local library.

## Neck Adjustment

The guitar neck was adjusted perfectly straight before it was packaged; however, the moisture content of wood acclimates to the humidity of the surrounding environment. This characteristic results in movement of the wood components with regards to alignment. It is not uncommon for the neck to require adjustment several times each year, especially in regions where the seasonal climate changes are more drastic.

**Components and Hardware Needed:** Qty  
Guitar with Strings Installed ..... 1

### Tools Needed

Metal Straightedge 18" ..... 1  
Hex Wrench 4mm..... 1  
Feeler Gauge Set..... 1  
Phillips Head Screwdriver..... 1

**To adjust the bow of the guitar neck:**

1. Tighten the strings to playing tension.
2. Place a straightedge from the 1st fret to the 17th. Measure any gaps between the straightedge and the frets with the feeler gauge.  
  
—If the neck is flat, or bowed up 0.012" or less, the neck is set up correctly. Continue to the next subsection.  
  
—If the gap is greater than 0.012", or if the neck bows away from the straightedge, continue to **Step 3**.
3. Loosen the strings and turn the truss rod nut in the base of the neck (**Figure 31**) counterclockwise with a 4mm wrench to release tension on the neck. Retighten until the nut begins to grab.

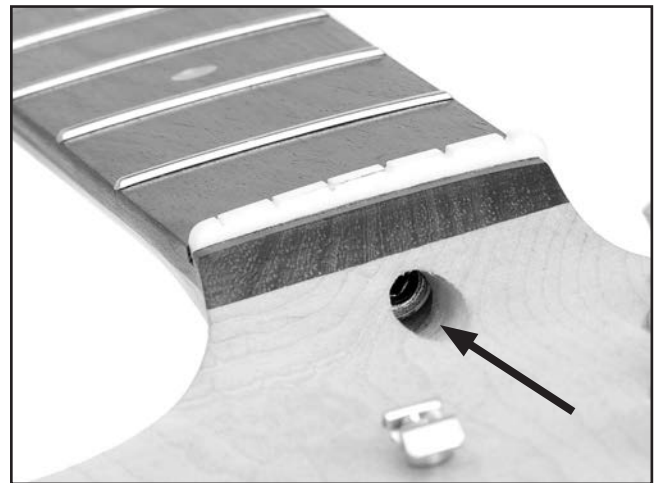

**Figure 31.** Truss rod nut.

4. To flatten a down bow, turn the truss rod nut a 1/4 turn clockwise. To correct an up bow, turn the nut a 1/4 turn counterclockwise.
5. Tighten the strings and recheck the neck with the straightedge.  
  
—If the neck is correctly adjusted, go to the next section.  
  
—If the neck is still out of adjustment return to **Step 3**.



# String Height

Tools Needed	Qty
Hex Wrench 1.5mm .....	1
Guitar Capo .....	1
Metal Straightedge .....	1
Steel Ruler ( $\frac{1}{64}$ " Resolution).....	1

Correct string height is crucial for maximizing the playability of your electric guitar. The string height is the distance between the top face of the fret and the bottom face of the string (**Figure 32**).

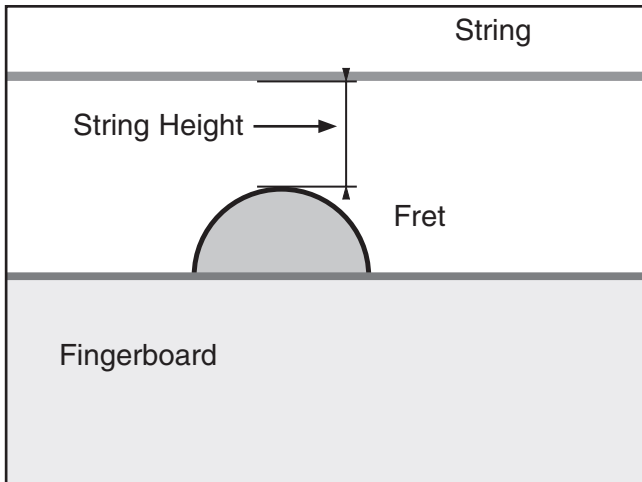

**Figure 32.** String height measurement.

## To adjust the string height:

1. Place a capo on the 1st fret.
2. Measure the string height at the twelfth fret as shown in **Figure 33**.

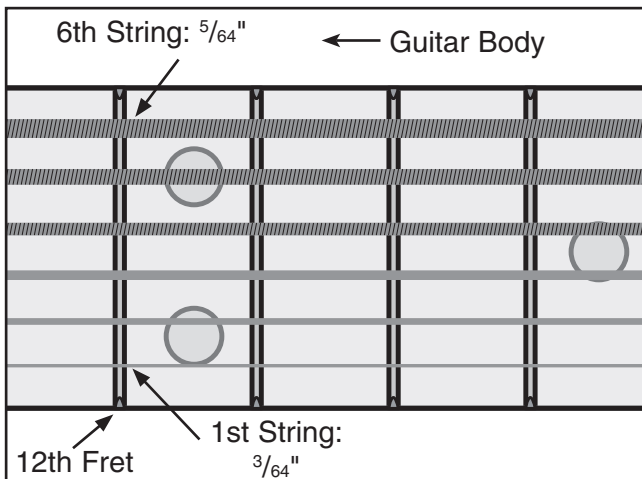

**Figure 33.** Correct 12th fret string heights.

The 1st string measurement should be  $\frac{3}{64}$ ", the 6th string measurement should be  $\frac{5}{64}$ ".

—If the string heights are correct, then continue to the next sub-section.

—If the string heights are incorrect at the 12th fret, then continue to the next step.

3. Use the included 1.5mm hex wrench to adjust the saddle height setscrews (**Figure 34**) until the string heights are correct.

—Turn the screws clockwise to raise the height of the string saddle; therefore, increasing the string height.

—Turn the screws counterclockwise to lower the height of the string saddle, therefore, decreasing the string height.

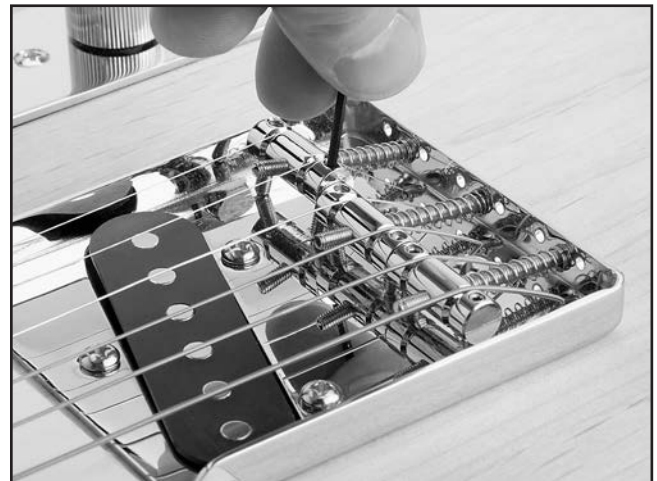

**Figure 34.** Adjusting string height.

4. Adjust the middle strings so they gradually increase in height from the 1st string height through the 6th string height.
5. Remove the capo.





# Pickup Height

Pickup height can have a dramatic effect on the audio output signal. The closer the strings are to the pickup, the higher the audio output signal will be. If the strings are too close, distortion is caused by magnetic interference from the electronic components.

Tools Needed	Qty
Metal Straightedge .....	1
Phillips Head Screwdriver.....	1

## To measure the string height at the pickup:

1. Measure the height of the 1st and 6th strings at the pickup while the strings are “fretted” at the 22nd fret (**Figure 35**).

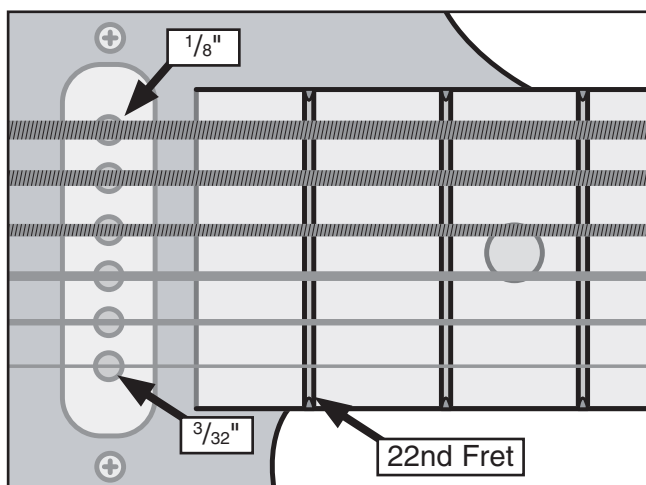

**Figure 35.** String heights over the pickup.

2. With a Phillips head screwdriver, adjust the screws on each side of the pickup until the 1st string is  $\frac{3}{32}''$  above the pickup and the 6th string is  $\frac{1}{8}''$  above the pickup.

—Turn the screws clockwise to raise the height of the pick up, therefore, decreasing the string height.

—Turn the screws counterclockwise to lower the height of the pick up, therefore, increasing the string height.

# Tuning

Tuning is an important guitar concept. If the guitar is not in tune, the resulting sound is unpleasant. These instructions explain how to tune by ear. You can also tune by using an electronic tuner such as the Grizzly T23099 Chromatic Tuner shown on **Page 25**.

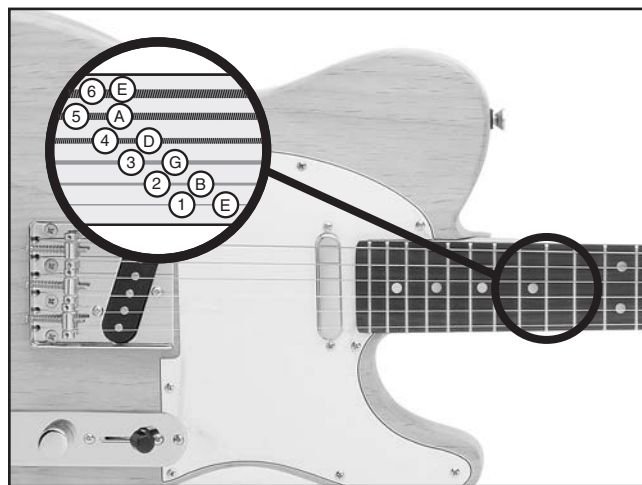

**Figure 36.** Example of standard tuning.

## To tune the guitar:

1. Play a Low E pitch on a piano, a tuning fork, or an electronic computer file.
2. Play an open (non-fretted) 6th string and adjust the tuner to match the Low E.

**Note:** Always tune up. If the string is tuned high, loosen the string to lower the pitch, then tune the string up to the correct note.

3. Tune the 5th string by playing the 6th string while it is being pressed (fretted) at the 5th fret, and then play the open 5th string. Adjust the 5th string tuner until the notes match.



4. Tune the 4th string by playing the 5th string while it is being pressed (fretted) at the 4th fret, and then play the open 4th string. Adjust the 4th string tuner until the notes match.
5. Perform the same tuning step on the and 3rd string.
6. When tuning the 2nd string, fret the 3rd string at the 4th fret instead of the 5th fret.
7. Tune the 1st string in the same manner as the 6th, 5th, 4th, and 3rd strings.

## Setting Intonation

---

Tools Needed	Qty
Phillips Head Screwdriver.....	1

Setting the intonation adjusts the length of the string to correct for flatness/sharpness on each string. This is a simple process that takes a lot of trial and error.

### To set the intonation:

1. Lightly touch and then release the 1st string directly above the twelfth fret as you pluck the string to play a harmonic note.
2. Now pluck the string while holding it fretted at the twelfth fret. If this note is sharper than the note played in **Step 1**, move the saddle away from the neck by turning the saddle adjustment screw (**Figure 37**) clockwise. If this note is flat in comparison, move the saddle toward the neck.

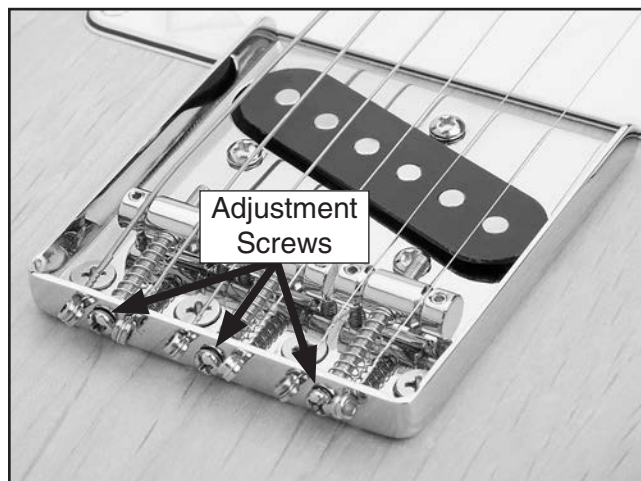

**Figure 37.** Saddle adjustment screws.

**Note:** This can also be done with an electronic tuner by tuning the harmonic note to be exactly in tune and then adjusting the saddle until the note played in **Step 2** is also in tune.

3. Repeat **Steps 1–2** until the string is in tune. Repeat the process for the rest of the strings.



# SECTION 6: REFERENCE INFO

## Accessories

### **NOTICE**

Refer to our website or latest catalog for additional recommended accessories.

#### **H5962—Guitar Stand-Electric/Archtop**

- Stable stand keeps electric and archtop guitars safe yet accessible on stage or on display
- Folds up for easy transporting
- Three adjustable locking positions
- Padded protection at all contact points
- Non-slip rubber feet



Figure 38. Model H5962 Guitar Stand.

#### **T23099—Chromatic Tuner/Metronome**

This metronome/tuner is suitable for all electric and acoustic stringed instruments. It has an easy-to-read LCD display and is able to tune notes: A, A#, B, C, C#, D, D#, E, F, F#, G, and G#. Seven beat settings and 5 rhythms make this versatile device a must for the novice or experienced musician.



Figure 39. T23099 Chromatic Tuner.

#### **H4412—The Guitar Handbook.**

The Guitar Handbook is the complete guide to playing the guitar — from simple chords to advanced improvisations. Its unique learning program combines step-by-step photographs with a chord dictionary containing over 800 easy-to-follow fingerings. It is also a comprehensive manual on guitar hardware and performance technology, sound equipment and special effects. 256 pages.

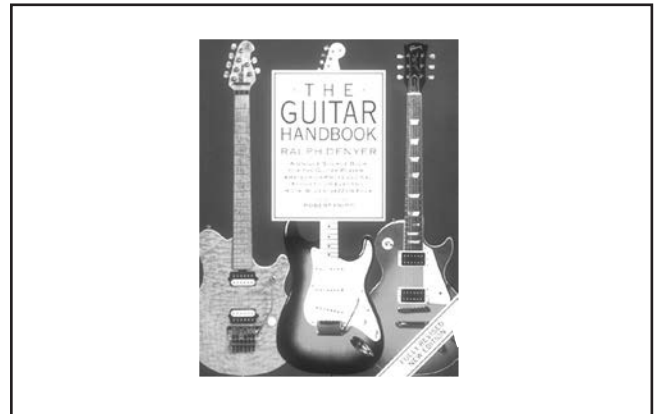

Figure 40. The Guitar Handbook.

#### **T21359—Guitar Finishing DVD**

This DVD gives very specific instructions for finishing a guitar with aerosols. It shows the steps necessary for a toned finish, a sunburst effect, and a clear finish using Behlen Vinyl Sealer, Stringed Instrument Lacquer, Starcast Amber Guitar Toner, and Encore Brown Guitar Toner aerosols.

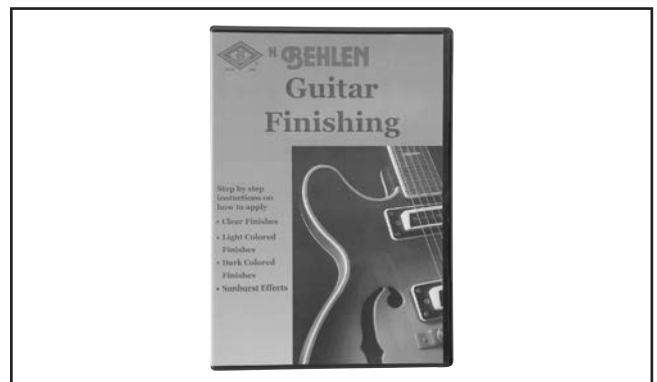

Figure 41. Guitar Finishing DVD.

**order online at [www.grizzly.com](http://www.grizzly.com) or call 1-800-523-4777**



- H2499—Small Half-Mask Respirator**
- H3631—Medium Half-Mask Respirator**
- H3632—Large Half-Mask Respirator**
- H3635—Cartridge Filter Pair P100**

Wood dust has been linked to nasal cancer and severe respiratory illnesses. If you work around-dust everyday, a half-mask respirator can be a lifesaver. Also compatible with safety glasses!



**Figure 42.** Half-mask respirator with disposable cartridge filters.

- T20501—Face Shield Crown Protector 4"**
- T20502—Face Shield Crown Protector 7"**
- T20503—Face Shield Window**
- T20452—"Kirova" Anti-Reflective S. Glasses**
- T20451—"Kirova" Clear Safety Glasses**
- H0736—Shop Fox® Safety Glasses**
- H7194—Bifocal Safety Glasses 1.5**
- H7195—Bifocal Safety Glasses 2.0**
- H7196—Bifocal Safety Glasses 2.5**



**Figure 43.** Eye protection assortment.

- H3901—Behlen Jet Spray™ Clear Lacquer—Flat**
- H3903—Behlen Jet Spray™ Clear Lacquer—Satin**
- H3937—Behlen Top Coat Lacquer - Satin**
- H3938—Behlen Sanding Sealer, 13 Oz.**

Behlen Master Top Coat Lacquer Sealer is an alcohol and water resistant, high solid nitrocellulose lacquer sealer. Use to seal and protect Behlen solvent based stains and other Master Aerosols. Master Topcoat Lacquer Sealer performs like a spray gun applied finish. 13 fl. oz. Cannot ship air.



**Figure 44.** H3938—BEHLEN Sanding Sealer

- H0818—Fine Prepolishing Paste, 1.85 Lb.**
  - H4873—Medium Prepolish Liquid, 1 Qt.**
  - H0821—High Gloss Polishing Liquid, 1 Qt.**
- Menzerna professional polishing compounds will remove any fine scratches from the finish and give your instrument the incredibly high gloss finish that you are looking for.



**Figure 45.** Menzerna pre-polishing paste.

**order online at [www.grizzly.com](http://www.grizzly.com) or call 1-800-523-4777**



# Electrical Components

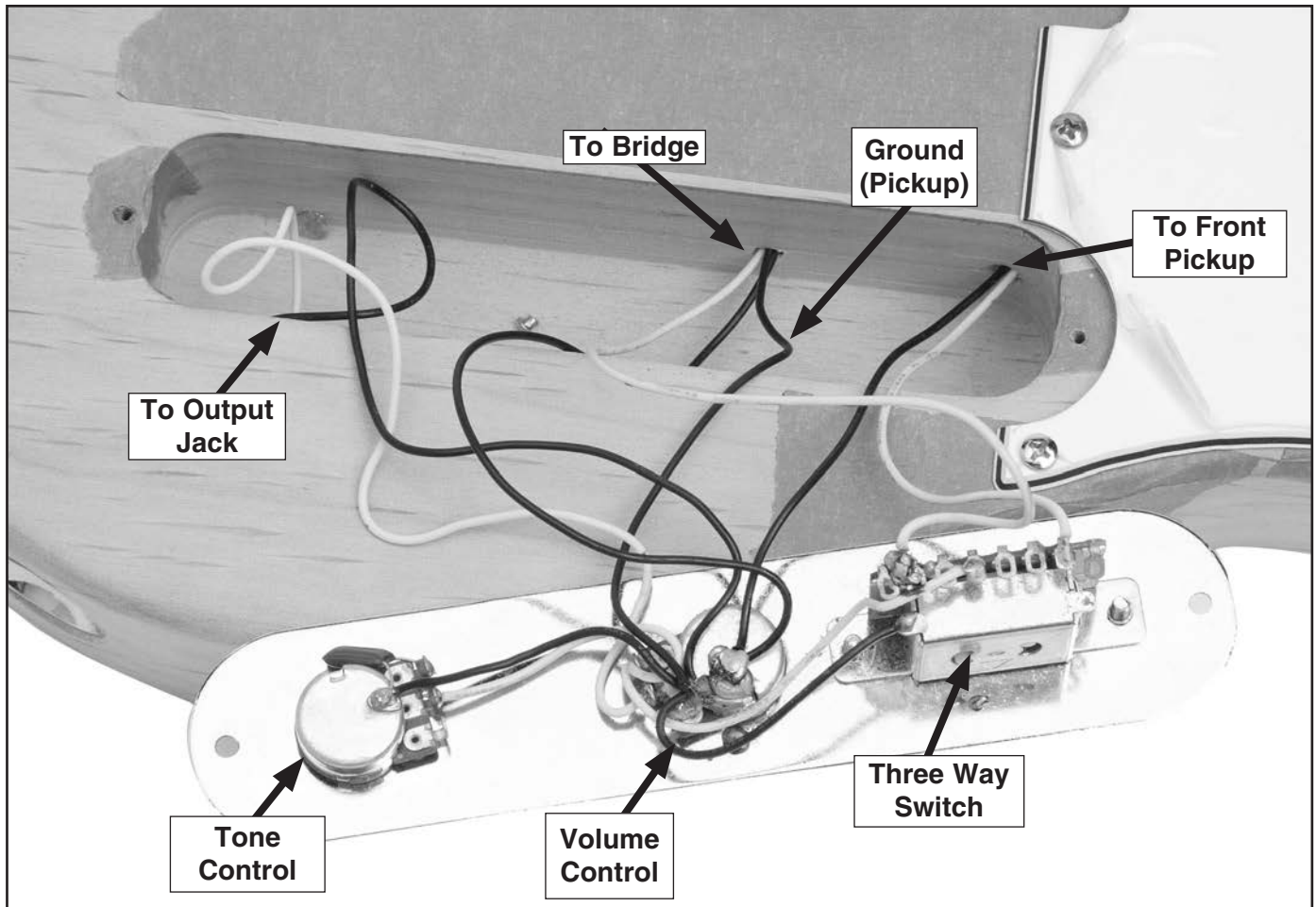

Figure 46. Control plate wiring.



Figure 47. Output jack wiring.





# Electrical Components

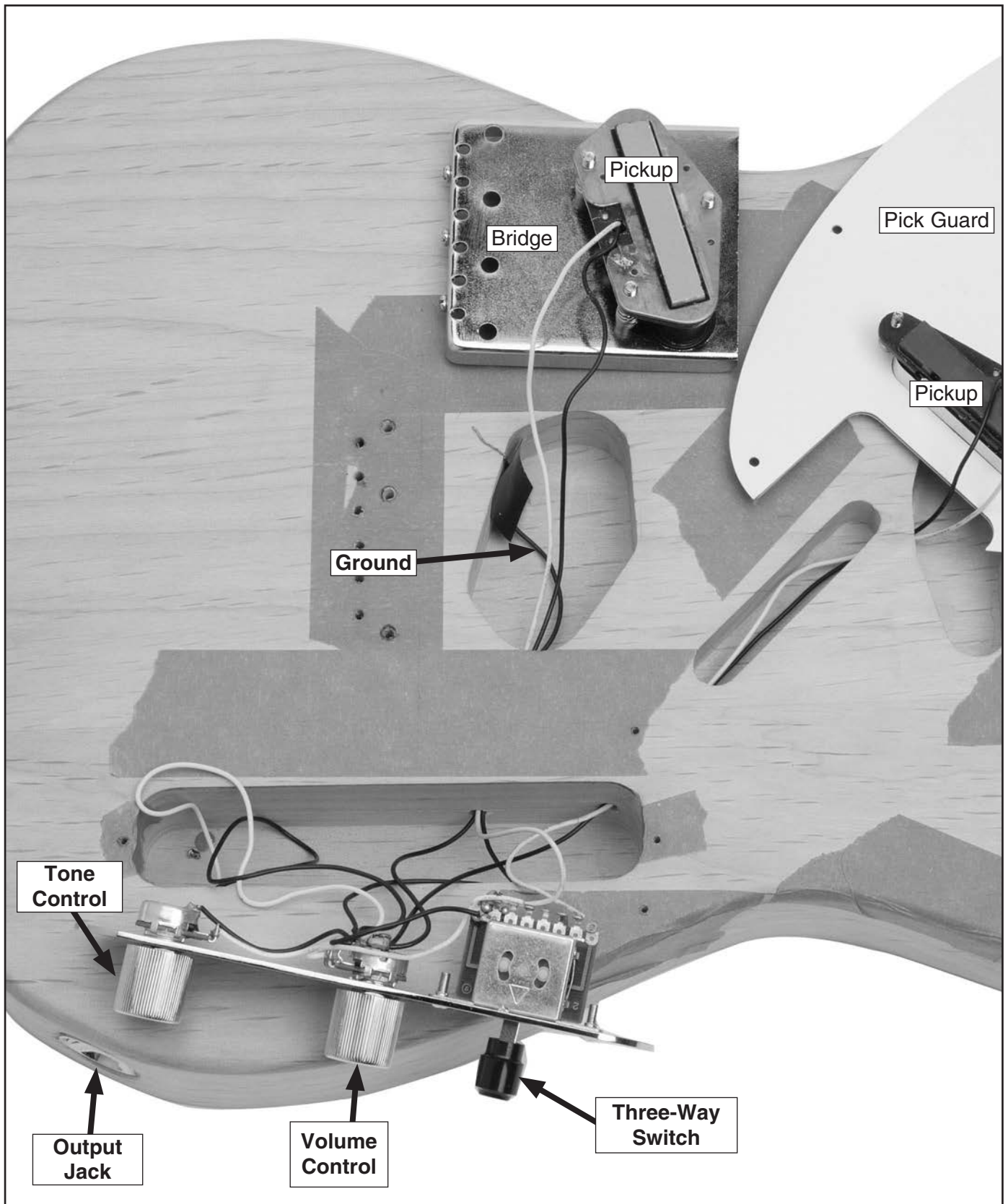

Figure 48. Model H8068 overall wiring.



# Wiring Diagram

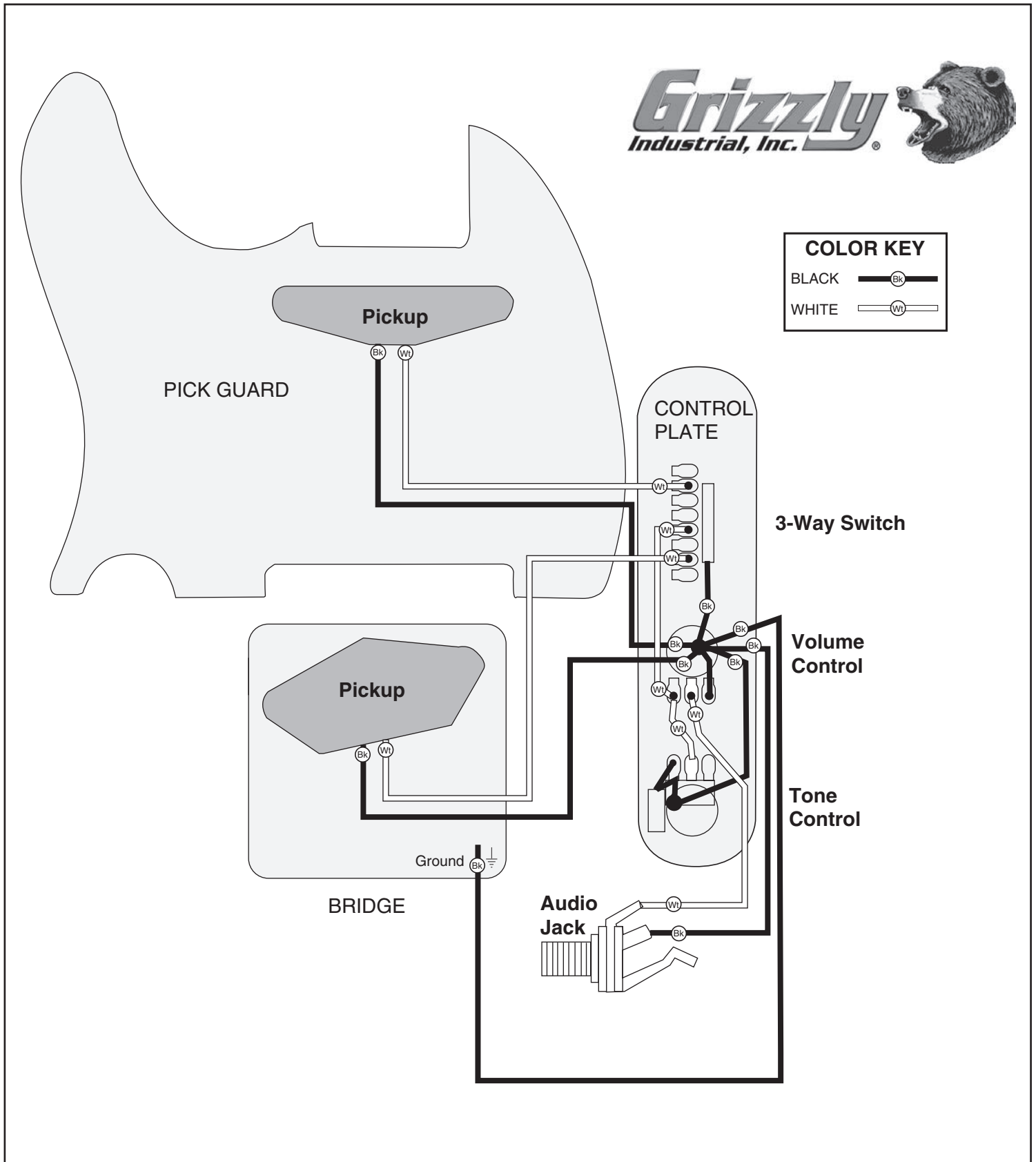

Figure 49. Model H8068 wiring diagram.



# WARRANTY AND RETURNS

---

Grizzly Industrial, Inc. warrants every product it sells for a period of **1 year** to the original purchaser from the date of purchase. This warranty does not apply to defects due directly or indirectly to misuse, abuse, negligence, accidents, repairs or alterations or lack of maintenance. This is Grizzly's sole written warranty and any and all warranties that may be implied by law, including any merchantability or fitness, for any particular purpose, are hereby limited to the duration of this written warranty. We do not warrant or represent that the merchandise complies with the provisions of any law or acts unless the manufacturer so warrants. In no event shall Grizzly's liability under this warranty exceed the purchase price paid for the product and any legal actions brought against Grizzly shall be tried in the State of Washington, County of Whatcom.

We shall in no event be liable for death, injuries to persons or property or for incidental, contingent, special, or consequential damages arising from the use of our products.

To take advantage of this warranty, contact us by mail or phone and give us all the details. We will then issue you a "Return Number," which must be clearly posted on the outside as well as the inside of the carton. We will not accept any item back without this number. Proof of purchase must accompany the merchandise.

The manufacturers reserve the right to change specifications at any time because they constantly strive to achieve better quality equipment. We make every effort to ensure that our products meet high quality and durability standards and we hope you never need to use this warranty.

Please feel free to write or call us if you have any questions about the machine or the manual.

Thank you again for your business and continued support. We hope to serve you again soon.







# WARRANTY CARD

Name \_\_\_\_\_  
 Street \_\_\_\_\_  
 City \_\_\_\_\_ State \_\_\_\_\_ Zip \_\_\_\_\_  
 Phone # \_\_\_\_\_ Email \_\_\_\_\_  
 Model # \_\_\_\_\_ Order # \_\_\_\_\_ Serial # \_\_\_\_\_

The following information is given on a voluntary basis. It will be used for marketing purposes to help us develop better products and services. **Of course, all information is strictly confidential.**

1. How did you learn about us?

Advertisement                       Friend                       Catalog  
 Card Deck                               Website                       Other:

2. Which of the following magazines do you subscribe to?

<input type="checkbox"/> Cabinetmaker & FDM	<input type="checkbox"/> Popular Science	<input type="checkbox"/> Wooden Boat
<input type="checkbox"/> Family Handyman	<input type="checkbox"/> Popular Woodworking	<input type="checkbox"/> Woodshop News
<input type="checkbox"/> Hand Loader	<input type="checkbox"/> Precision Shooter	<input type="checkbox"/> Woodsmith
<input type="checkbox"/> Handy	<input type="checkbox"/> Projects in Metal	<input type="checkbox"/> Woodwork
<input type="checkbox"/> Home Shop Machinist	<input type="checkbox"/> RC Modeler	<input type="checkbox"/> Woodworker West
<input type="checkbox"/> Journal of Light Cont.	<input type="checkbox"/> Rifle	<input type="checkbox"/> Woodworker's Journal
<input type="checkbox"/> Live Steam	<input type="checkbox"/> Shop Notes	<input type="checkbox"/> Other:
<input type="checkbox"/> Model Airplane News	<input type="checkbox"/> Shotgun News	
<input type="checkbox"/> Old House Journal	<input type="checkbox"/> Today's Homeowner	
<input type="checkbox"/> Popular Mechanics	<input type="checkbox"/> Wood	

3. What is your annual household income?

\$20,000-\$29,000                       \$30,000-\$39,000                       \$40,000-\$49,000  
 \$50,000-\$59,000                       \$60,000-\$69,000                       \$70,000+

4. What is your age group?

20-29                                       30-39                                       40-49  
 50-59                                       60-69                                       70+

5. How long have you been a woodworker/metalworker?

0-2 Years                       2-8 Years                       8-20 Years                       20+ Years

6. How many of your machines or tools are Grizzly?

0-2                       3-5                       6-9                       10+

7. Do you think your machine represents a good value?                       Yes                       No

8. Would you recommend Grizzly Industrial to a friend?                       Yes                       No

9. Would you allow us to use your name as a reference for Grizzly customers in your area?

**Note: We never use names more than 3 times.**                       Yes                       No

10. Comments: \_\_\_\_\_  
 \_\_\_\_\_  
 \_\_\_\_\_

CUT ALONG DOTTED LINE

FOLD ALONG DOTTED LINE

\_\_\_\_\_
\_\_\_\_\_
\_\_\_\_\_



Place Stamp Here



GRIZZLY INDUSTRIAL, INC.
P.O. BOX 2069
BELLINGHAM, WA 98227-2069



FOLD ALONG DOTTED LINE

Send a Grizzly Catalog to a friend:

Name \_\_\_\_\_
Street \_\_\_\_\_
City \_\_\_\_\_ State \_\_\_\_\_ Zip \_\_\_\_\_

TAPE ALONG EDGES--PLEASE DO NOT STAPLE



***grizzly.com***<sup>®</sup>  
**TOOL WEBSITE**

Buy Direct and Save with Grizzly<sup>®</sup> – Trusted, Proven and a Great Value!  
~Since 1983~

*Visit Our Website Today For  
Current Specials!*

**ORDER  
24 HOURS A DAY!  
1-800-523-4777**

