



INSTRUCTION MANUAL

Model: HLC-3596L-1

support@vipclub.app

833-969-2075 / 1 (770) 298-8947

ASSEMBLY GUIDE

Congratulations, you are now the owner of the new chair!

Before enjoying the comfortable chair, you have to assemble it . This assembly guide will take you through the basic assembly process. To make sure your assembly progress goes smoothly, please follow the assembly instructions **especially the important safety information.**

It is possible to assemble the chair by your own, while having **a second person to help you will make it easier.**

Please check if there are any missing parts in the package before start. If there are any issues, please don't hesitate to drop us an email and we'll help you ASAP.

If you run into any difficulty during the assembly, remember to check out the assembly Video to see if you've missed something. If you're still unable to resolve your problems , drop us an email and our support team will assist you.















<https://qygjuser.s3.us-east-2.amazonaws.com/HL-LOGO/3596.mp4>

WARNING

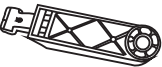
To ensure proper assembly, please follow all steps and use all parts. Failure to follow this warning can result in serious injury to yourself or others.

Package List

- Without further ado, we kindly suggest you to list all parts needed for the chair first.

(1)*1 Back Support 	(2)*1 Seat Cushion 	(3)*2 Armrest 
(4)*1 Mechanism 	(5)*1 Gas Lift 	(6)*1 Base 
(7)*5 Legs 	(8)*5 Casters 	(9)*4 Bolts 
(10)*8 Bolts 	(11)*8 Caps 	(12)*1 Wrench 

Assembly Instruction

1

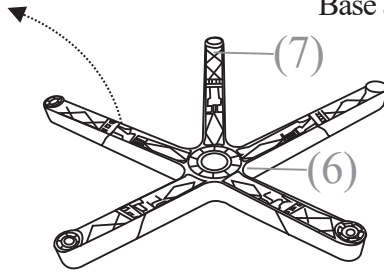
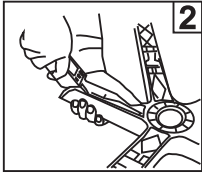
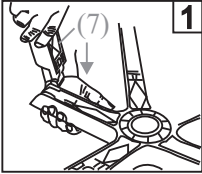

• Step 1:

Turn the Base **(6)** upside down, Align the leg **(7)** into with the Base and press the Leg **(7)** down.

• Step 2:

Insert the Casters **(8)** into the holes at the end of each Base Leg. And then insert the Gas Lift **(5)** to the base.

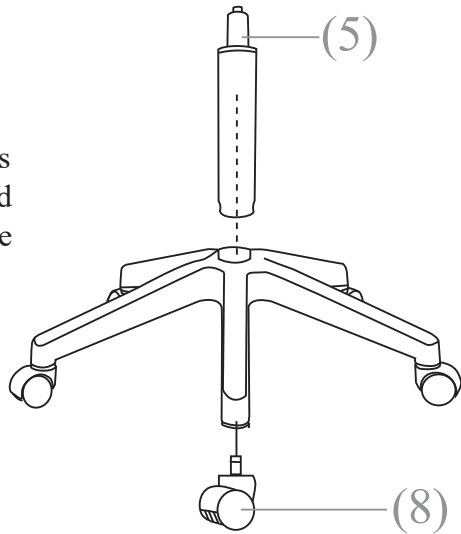

• Step 3 :

Align the Mechanism (4) over the pre-drilled holes underneath the Seat Cushion (2), make sure the front of the mechanism is facing the front of the Seat.

Attach the Mechanism to the Seat Cushion using Four Bolts (9), tighten all the bolts with the Wrench (12).

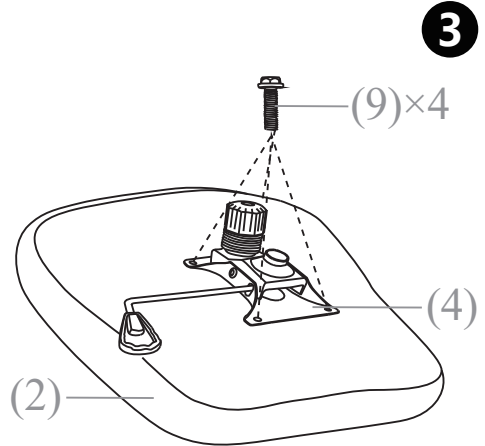

3

4

• Step 4 :

Turn the Seat Cushion (2) upright and align the center hole of the Seat Plate over the lift, then push the Seat Cushion down onto the lift firmly until the connection is secure.

Attach the Armrest (3) to the Seat Cushion (2) with Two Bolts (10), using the Wrench (12). The installation of the other side Armrest is the same.



Note 1: The same marks on both seat and armrests are tips for installing the armrests in the correct direction.

Note 2: Armrests are labeled with letter "L" (left) or "R" (right).

• Step 5 :

Lay the Back Cushion **(1)** on the seat of the chair with the top of the cushion toward the front.

Attach the Back Cushion **(1)** to the Arms by inserting one Bolt **(10)** in the Lower holes with the Wrench **(12)**.

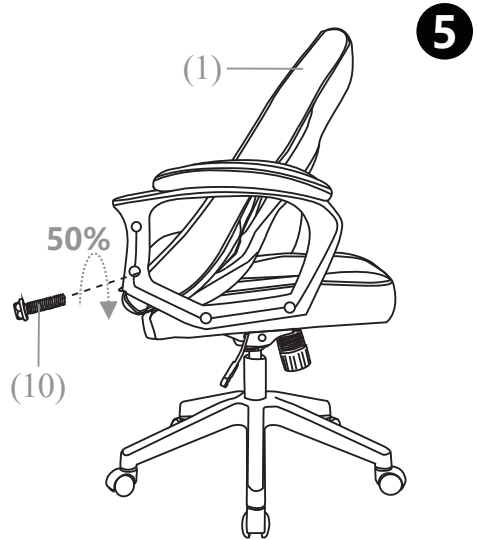

6

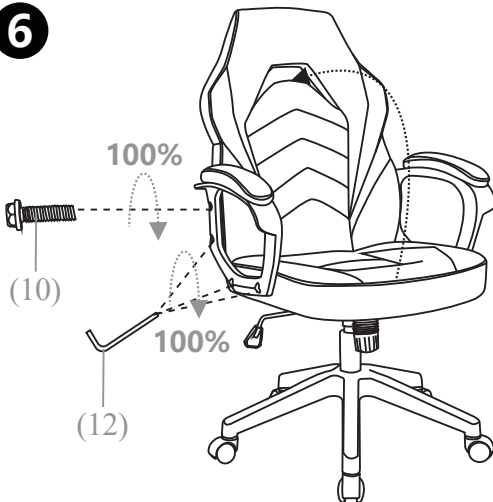

• Step 6 :

Rotate the back of the chair up, then secure it with the Bolt **(10)** use the Wrench **(12)**. Adjust the balance on each side of the chair, and fully tighten all the bolts at this step.

7

• **Step 7 :**

Press Four small Caps **(11)** into screw holes of each side.

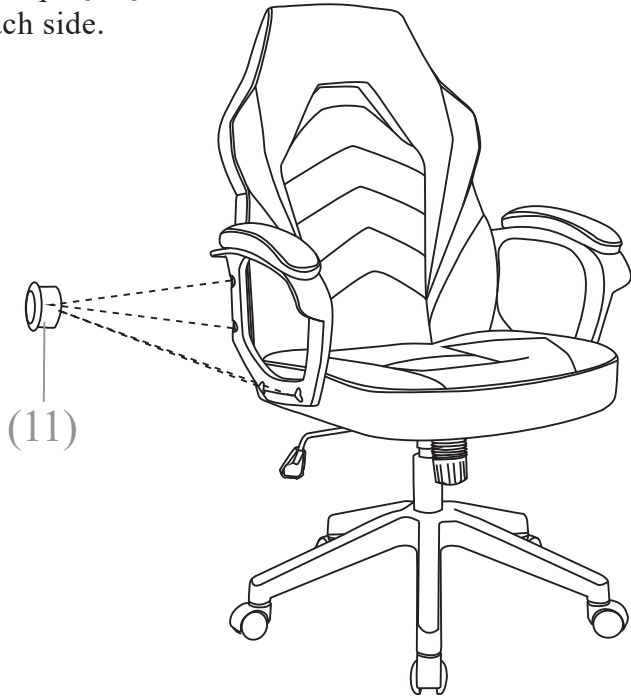

CAUTION:

Make sure all bolts and screws are fully tightened before using chair. Lubricate all moving parts and tighten all bolts/screws every 6 month or whenever needed.

Instructions For Use

1. Seat Height: Paddle-shaped lever on the right side

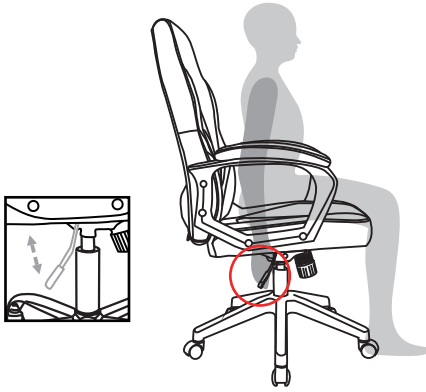

To raise:

While taking your weight off chair, lift lever up.



To lower:

While seated, lift lever up.

* At the proper height, your feet should rest flat on the floor.

2. Tilt Tension: Long stem under the seat with knob

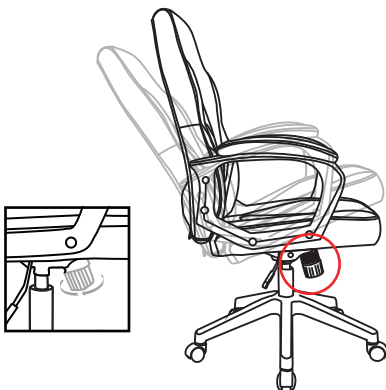

To increase tension:

While seated, turn knob forward (Counter clockwise).



To decrease tension:

While seated, turn knob backward (Clockwise).

* Set the tilt tension to control the resistance you feel when leaning back.

3. Operating the tilt lockout

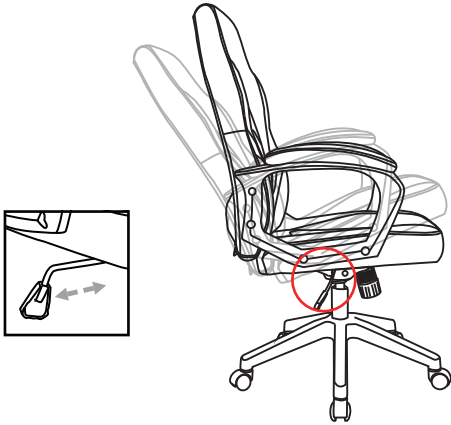

To let your chair tilt back, pull the control handle out.

To stop your chair from tilting, sit forward, then push the control handle in.

Safety And Maintenance

- Do not stand on the chair, Do Not use the chair as a stepladder.
- Use this product for seating one person at a time.
- Do not use the chair unless all bolts and screws are firmly secured.
- Avoid contact with sharp objects to prevent puncturing the fabric.
- Every 6 months, check all bolts and screws to ensure they are tight.
- To clean, spot clean only using a damp towel and mild cleaner, first test on a small, unseen area of fabric.
- Chair weight limit not to exceed 250 lbs.

Safety Information



Sit in the center of the chair, with your back to the backrest



Do not sit at the front edge of the chair



Do not stand on the chair



Do not use the chair with more than one person



Do not push the chair around when a person is sitting in it



Do not push down on the backrest when a person is reclined



Do not place all your weight on only the backrest

Limited Warranty

The producer promises to repair or replace any chair that is found to be defective in material or workmanship within one(1) and year from the date of original purchase so long as you, the original purchaser, still owns it. This is your sole and exclusive remedy. This warranty is subject to the provisions below.

EXCLUSIONS:

- This warranty does not apply and no other warranty applies to:
 - Normal wear and tear, which are to be expected over the course of ownership.
 - Misuse, abuse, or excessive use of the product.
 - Modifications or attachments to the product that are not approved by the manufacturer.
 - Products that were not installed, used or maintained in accordance with product instructions and warnings.
 - Products used for rental or commercial purposes.
 - Damage caused by the carrier in-transit is handled under separate terms.

SEATING USAGE:

Normal use for seating is identified as the equivalent of a single shift, forty- (40) hour workweek. To the extent that a seating product is used in a manner exceeding this, the applicable warranty period will be reduced in a pro-rata manner.

Some retailers might have custom models imported directly from the factory and therefore are not supported by our local service team because we don't have the correct parts, please contact your retailer directly for support. If you have any questions about that we will be happy to assist and identify those items.

RETURN POLICY:

We adopt a 30 days return policy which means that all products purchased on this website may be returned to us within the timeframe. You need to contact us within 30 days after the product(s) came into your possession and the product(s) must be returned to us without any undue delays.

Returned products must be returned in the same condition as they were sent and they must be sent in its original packaging.

If the product is not faulty, (i.e. if you changed your mind or if you are unhappy with the product for some other reason), the cost of shipping will all on you. And it is your responsibility that the package arrives safely to us so we recommend that you use a courier service where it is possible to track the shipment.

If the product is faulty when you receive it please contact us and we will help you out (see more information under Manufacturer Warranty).

We reserve the right to give a partial refund in cases when the product(s) is not in an unused condition, is damaged or has missing parts not due to our error.

HOW RETURNS WORK:

Contact us through the contact form on our website and attach the invoice to the message as proof of purchase. And please also write the reason for return.

We will then get back to you as soon as possible with information on where to send the product(s).

As soon as we have received the product(s) and made an inspection we will inform you of our decision.

If a refund is approved we will automatically credit the purchase to your credit card or original method of payment.

If the product(s) is damaged, not in its original condition or missing parts we will inform you if you are eligible for a partial refund. This is decided from case to case depending on the severity of the damages or what parts are missing.

support@vipclub.app
833-969-2075 / 1 (770) 298-8947