



MAX-PLANCK-GESELLSCHAFT

**Max Planck Institute Magdeburg
Preprints**

Ulrike Baur Peter Benner Lihong Feng

**Model order reduction for linear and
nonlinear systems: a system-theoretic
perspective**



Abstract

In the past decades, Model Order Reduction (MOR) has demonstrated its robustness and wide applicability for simulating large-scale mathematical models in engineering and the sciences. Recently, MOR has been intensively further developed for increasingly complex dynamical systems. Wide applications of MOR have been found not only in simulation, but also in optimization and control. In this survey paper, we review some popular MOR methods for linear and nonlinear large-scale dynamical systems, mainly used in electrical and control engineering, in computational electromagnetics, as well as in micro- and nano-electro-mechanical systems (NEMS/MEMS) design. This complements recent surveys on generating reduced-order models for parameter-dependent problems [37, 53, 169] which we do not consider here. Besides reviewing existing methods and the computational techniques needed to implement them, open issues are discussed, and some new results are proposed.

Impressum:

Max Planck Institute for Dynamics of Complex Technical Systems, Magdeburg

Publisher:

Max Planck Institute for
Dynamics of Complex Technical Systems

Address:

Max Planck Institute for
Dynamics of Complex Technical Systems
Sandtorstr. 1
39106 Magdeburg

<http://www.mpi-magdeburg.mpg.de/preprints/>

1 Introduction

In this paper we are concerned with continuous-time systems of the following general form,

$$\begin{aligned}\frac{d}{dt}g(x(t)) &= f(x(t)) + Bu(t), \\ y(t) &= L^T x(t),\end{aligned}\tag{1}$$

where $x(t) \in \mathbb{R}^n$ is the vector of unknowns, also called “state vector” in control or electrical engineering, the entries of $x(t)$ are referred to as “state variables”. $B \in \mathbb{R}^{n \times m}$, $L \in \mathbb{R}^{n \times q}$ are input and output matrices, and $g, f : \mathbb{R}^n \rightarrow \mathbb{R}^n$. The state space dimension n is called the order of the system and is assumed to be very large. Systems where the input $u(\cdot)$ and the output $y(\cdot)$ are both scalar functions are called single-input single-output (SISO) systems. Correspondingly, if both $u(\cdot)$ and $y(\cdot)$ are vector functions, the system is called multi-input multi-output (MIMO) system. For MIMO systems we generally require that the dimensions of the input and output spaces are much smaller than the dimension of the state space, i.e. $m, q \ll n$.

In many engineering applications, e.g. microelectronics, Microelectromechanical systems (MEMS), electromagnetism, fluid dynamics and control etc, complex large-scale mathematical models have to be solved, for example, the system in (1). It usually consists of a large number of differential equations and/or additional algebraic equations. The number of the degrees of freedom easily reaches $n \geq O(10^5)$.

Conventional numerical simulation methods cannot handle the many-query requirement in the applications, where the large system must be repeatedly solved. It is quite usual, that one solution has not yet obtained after several days. Model order reduction (MOR) has been proved to be very promising in obtaining a reliable solution much more quickly.

The general goal of MOR is to reduce the original degrees of freedom to a very small size, while the input-output accuracy is kept. To this end, the state vector $x(t)$ is projected onto a low-dimensional subspace, while the redundant or “less important” elements in $x(t)$ are removed.

Through discovering an approximation for $x(t)$, a transformation matrix V , and a projection matrix $W \in \mathbb{R}^{n \times r}$ are computed. Usually, it is required $W^T V = I_r$, such that VW^T is a projector onto an r -dimensional subspace. Here, I_r is the identity matrix in $\mathbb{R}^{r \times r}$, and $r \ll n$.

A reduced model is obtained by the approximation $x(t) \approx Vz(t)$,

$$\begin{aligned}\frac{dg(Vz(t))}{dt} &= f(Vz(t)) + Bu(t) + \text{res}(t), \\ \hat{y}(t) &= L^T Vz(t),\end{aligned}\tag{2}$$

and a Petrov-Galerkin projection with W ,

$$\frac{dW^T g(Vz(t))}{dt} = W^T f(Vz(t)) + W^T Bu(t),\tag{3}$$

where $W^T \text{res}(t) \equiv 0$ holds. The model reduction methods differ in the choice of the matrices W and V . One basic requirement is that the behavior of the reduced model

should be sufficiently “close” to that of the original model, i.e., given the input $u(\cdot)$ to both systems, the error between the output response of the reduced model $\hat{y}(\cdot)$ and that of the original model $y(\cdot)$ should be very small in some norm. Then, the original model can be replaced by the reduced model in the later analysis.

We call (1) a linear system if $g(\cdot)$ and $f(\cdot)$ are linear, otherwise the system is called a nonlinear (control-affine) system. MOR methods for linear systems have already been well developed. The methods for nonlinear systems are mainly extensions of the MOR methods for linear systems. We discuss them separately in Section 2 and Section 3. In each section, we point out some open problems and elaborate the difficulties. Besides, we also present some new results. In order to clearly analyze the problems, we give some illustrative numerical simulation results.

With the ongoing development of MOR methods, the complex dynamical systems tackled become more and more complicated. Many complex mathematical models nowadays include parameters that may be considered as deterministic or stochastic variables. MOR for parametric systems is a vast topic. Various kinds of methods have been proposed to deal with parametric systems, like multi-moment matching methods, interpolation based methods, methods based on proper orthogonal decomposition (POD), reduced basis methods etc. An extensive number of papers has been published in both of these areas. MOR for parametric and stochastic systems is not further considered here since this is beyond the focus of the survey. For a very detailed explanation of reduced basis approximations (and a posteriori error estimation) for parametric systems, we refer to [169]. A more general, but less detailed, perspective on MOR methods for parametric systems is given in [37]. Reduced basis approaches for stochastic problems are reviewed in [53] whereas a review of computational stochastic methods (also model reduction techniques) with emphasis on spectral stochastic approaches can be found in [147].

Furthermore, this work is somewhat limited since MOR methods for some special systems are not included, e.g., systems with a large number of inputs/outputs and second order systems. MOR for systems with a large number of inputs and outputs currently focus on linear systems. This issue is not widely noticed in the past, but attracts more attention at present [49, 72, 137, 133, 145, 178]. MOR on second order systems is discussed e.g. in [18, 39, 69, 173, 185, 202].

Methods based on pure eigenvalue considerations as modal truncation for linear systems [61, 62, 140] and an approach related to approximate inertial manifolds for the order reduction of nonlinear problems [115] are also not discussed here.

To sum up, this survey discusses well-established to very recent approaches for MOR of linear and nonlinear systems. We are focusing here on large-scale dynamical systems with (control) inputs and with a user’s interest in observing/controlling certain output variables, sometimes called the *quantities of interest*. Thus, the MOR methods under consideration are based on systems theory with emphasis on frequency domain considerations. In particular, most approaches discussed here are based on the transfer function representation of the given dynamical system in frequency domain, lending itself to the problem of rational approximation. That is, the model reduction problem is solved by finding a low-order rational function approximating the given transfer function. This clearly distinguishes the approaches we focus on from snapshot based

methods like POD or the reduced basis method.

2 Model order reduction of linear systems

We first consider linear time-invariant (LTI) systems

$$\begin{aligned}\dot{x}(t) &= Ax(t) + Bu(t), \\ y(t) &= L^T x(t),\end{aligned}\tag{4}$$

with a constant matrix $A \in \mathbb{R}^{n \times n}$ and $\dot{x}(t) \equiv \frac{d}{dt}x(t)$. For simplicity, the initial condition is assumed to be zero, i.e., $x(0) = 0$ (systems with $x(0) \neq 0$ will be discussed later). Furthermore, we restrict our attention to stable systems, that is, all eigenvalues of the system matrix A , denoted by $\Lambda(A)$, are assumed to be in the open left half of the complex plane \mathbb{C}^- . We shortly comment on methods for unstable systems later. Linear, large-scale systems arise in many practical applications as, for instance, in circuit simulations and in control problems where the underlying physical process is modeled by partial differential equations. For these problems we are interested in constructing reduced-order systems

$$\begin{aligned}\dot{\hat{x}}(t) &= \hat{A}\hat{x}(t) + \hat{B}u(t), \\ \hat{y}(t) &= \hat{L}^T \hat{x}(t),\end{aligned}\tag{5}$$

where $\hat{A} = W^T A V \in \mathbb{R}^{r \times r}$, $\hat{B} = W^T B \in \mathbb{R}^{r \times m}$, $\hat{L} = V^T L \in \mathbb{R}^{r \times q}$, and $r \ll n$, with good approximation properties for (4).

2.1 Gramian based model order reduction

For linear problems, as considered in systems theory and control of ordinary differential or partial differential equations, balanced truncation (BT) [143, 144] and related methods are the methods of choice since they have some desirable properties: they preserve the stability of the system [157] and provide a global computable error bound between the transfer function of the original system and that of the reduced-order system [66, 94]. This implies bounds in the frequency domain and in the time domain via the theorem by Plancherel.

The transfer function or transfer function matrix (TFM) of the system (4) $H(s) \in \mathbb{C}^{q \times m}$ is defined as the relation between the output response and the input signal in the frequency domain (assuming $x(0) = 0$)

$$H(s) = Y(s)/U(s) = L^T (sI - A)^{-1} B,\tag{6}$$

where $Y(s)$ and $U(s)$ are obtained by applying the Laplace transformation to (4):

$$\begin{aligned}sX(s) &= AX(s) + BU(s), \\ Y(s) &= L^T X(s).\end{aligned}$$

Driving the original and the reduced-order system with the same input $u(\cdot)$, an expression for the error between the original and the reduced system output is obtained:

$$\|y - \hat{y}\|_2 \leq \|H - \hat{H}\|_\infty \|u\|_2, \quad (7)$$

where $\hat{H}(s)$ is the TFM of the reduced system (5), $\|\cdot\|_2$ is the \mathcal{L}_2 -norm for square-integrable functions, and $\|\cdot\|_\infty$ denotes the \mathcal{H}_∞ -norm of a rational transfer function, which is given for stable systems by

$$\|H\|_\infty = \sup_{\omega \in \mathbb{R}} \sigma_{\max}(H(j\omega)),$$

see, for instance [5, p.126]. Here, $\sigma_{\max}(H(j\omega))$ is the largest singular value of the $q \times m$ matrix $H(j\omega)$ and $j = \sqrt{-1}$. The error estimate (7) is valid both in time domain and in frequency domain.

Standard BT doesn't preserve the passivity of the system. In the meantime, there exist several implementations of passivity-preserving balancing-related model reduction. These methods are applicable to standard state space systems as well as to differential-algebraic equations (DAEs), see [160, 164, 174, 201].

The basic idea of BT relies on balancing the two system Gramians, the controllability Gramian P and the observability Gramian Q , defined as follows (see, e.g. [125]):

$$P = \int_0^\infty e^{At} B B^T e^{A^T t} dt, \quad Q = \int_0^\infty e^{A^T t} L L^T e^{At} dt, \quad (8)$$

by applying a transformation $T \in \mathbb{R}^{n \times n}$, $\det(T) \neq 0$, to (4),

$$\begin{aligned} \dot{\tilde{x}}(t) &= T A T^{-1} \tilde{x}(t) + T B u(t), \\ y(t) &= L^T T^{-1} \tilde{x}(t). \end{aligned} \quad (9)$$

The transformation is chosen so that the Gramians \tilde{P} and \tilde{Q} are equal and diagonal:

$$\tilde{P} = T P T^T = \tilde{Q} = T^{-T} Q T^{-1} = \Sigma = \text{diag}(\sigma_1, \sigma_2, \dots, \sigma_n), \quad (10)$$

where $\sigma_1, \dots, \sigma_n$ are the non-increasingly ordered Hankel singular values (HSVs) of the system (4). The matrices V and W for computing the reduced-order system (5) can be constructed from the dominant invariant subspace of $\tilde{P}\tilde{Q}$ where the eigenvalues of $\tilde{P}\tilde{Q}$ are related to the HSVs by $\sigma_i = \sqrt{\lambda_i(\tilde{P}\tilde{Q})}$ for $i = 1, \dots, n$. Projecting the system onto the eigenspaces corresponding to the largest eigenvalues keeps the important dynamics of the system, i.e., the states which are easiest to reach and easiest to observe. The global error between $H(\cdot)$ and $\hat{H}(\cdot)$ is bounded by

$$\|H - \hat{H}\|_\infty \leq 2(\sigma_{r+1} + \sigma_{r+2} + \dots + \sigma_n), \quad (11)$$

where $\sigma_{r+1}, \dots, \sigma_n$ are the neglected HSVs. The error bound (11) allows for an adaptive choice of the reduced order r depending on a prescribed error tolerance.

For descriptor systems or generalized state space systems,

$$\begin{aligned} C\dot{x}(t) &= -Gx(t) + Bu(t), \\ y(t) &= L^T x(t), \end{aligned} \quad (12)$$

where the matrix $C \in \mathbb{R}^{n \times n}$ might be singular, there exist generalizations of balanced truncation, see, for instance, [10, 27, 138, 142, 156, 183, 184]. Note that for nonsingular C the system (12) can be transformed to a system in standard form (4) by setting $A = -C^{-1}G$.

In the following paragraphs we will discuss different implementations of BT. For a survey on balanced truncation model reduction see [105].

Balanced truncation

The original balanced truncation [143, 144] computes a balancing transformation matrix T by spectral decompositions of P and of the projected Gramian Q :

$$\begin{aligned} V_P^T P V_P &= \Lambda_P^2, \\ V_Q^T [(V_P \Lambda_P)^T Q (V_P \Lambda_P)] V_Q &= \Lambda_Q^2, \end{aligned}$$

where $V_P, V_Q \in \mathbb{R}^{n \times n}$ are real orthogonal and the entries in $\Lambda_P = \text{diag}(\lambda_1^P, \dots, \lambda_n^P)$, $\Lambda_Q = \text{diag}(\lambda_1^Q, \dots, \lambda_n^Q)$ are in non-increasing order. Applying the similarity transformation

$$T = V_P \Lambda_P V_Q \Lambda_Q^{-1/2} \in \mathbb{R}^{n \times n}$$

to (4) results in a balanced system (9) satisfying (10). We denote the transformed matrices by $\tilde{A} = T A T^{-1}$, $\tilde{B} = T B$, $\tilde{L}^T = L^T T^{-1}$. A reduced-order system (5) can be computed by simple truncation from the balanced realization in partitioned form:

$$\begin{aligned} \dot{\tilde{x}}(t) &= \begin{bmatrix} \tilde{A}_{11} & \tilde{A}_{12} \\ \tilde{A}_{21} & \tilde{A}_{22} \end{bmatrix} \tilde{x}(t) + \begin{bmatrix} \tilde{B}_1 \\ \tilde{B}_2 \end{bmatrix} u(t), \\ y(t) &= \begin{bmatrix} \tilde{L}_1^T & \tilde{L}_2^T \end{bmatrix} \tilde{x}(t), \end{aligned}$$

with $\tilde{A}_{11} \in \mathbb{R}^{r \times r}$, i.e. $\hat{A} = \tilde{A}_{11}$, $\hat{B} = \tilde{B}_1$, and $\hat{L} = \tilde{L}_1$.

Square-root method of balanced truncation

An efficient and numerically more robust implementation of BT, the square-root (SR) method [126, 187], is based on Cholesky factorizations of the Gramians, i.e. $P = Z_P Z_P^T$ and $Q = Z_Q Z_Q^T$. The transformation matrices V and W are computed by a singular value decomposition (SVD) of the product of the Cholesky factors,

$$Z_P^T Z_Q = \begin{bmatrix} \tilde{U}_1 & \tilde{U}_2 \end{bmatrix} \begin{bmatrix} \tilde{\Sigma}_1 & 0 \\ 0 & \tilde{\Sigma}_2 \end{bmatrix} \begin{bmatrix} \tilde{V}_1^T \\ \tilde{V}_2^T \end{bmatrix}, \quad (13)$$

with $\tilde{\Sigma}_1 = \text{diag}(\sigma_1, \dots, \sigma_r)$.

The singular values $\{\sigma_1, \dots, \sigma_n\}$, which equal the HSVs of the system, are assumed to be in non-increasing order. Then, the matrices

$$W^T = \tilde{\Sigma}_1^{-1/2} \tilde{V}_1^T Z_Q^T \in \mathbb{R}^{r \times n}, \quad V = Z_P \tilde{U}_1 \tilde{\Sigma}_1^{-1/2} \in \mathbb{R}^{n \times r},$$

are parts of the balancing transformation matrix T ,

$$T = \begin{bmatrix} W^T \\ * \end{bmatrix}, \quad T^{-1} = [V, *],$$

and directly balance and reduce the system (4) following step (2) and (3). Note that $Z_P \tilde{U}_1, Z_Q \tilde{V}_1$ are the right and left eigenvectors, respectively, of PQ corresponding to the r largest eigenvalues.

The SR method computes a balanced and stable reduced system which satisfies the BT error bound (11).

For highly unbalanced systems it is not advised to compute balanced reduced-order systems by possibly ill conditioned transformation matrices. This motivates the development of balancing-free MOR methods.

Balancing-free methods

The Schur method [172] computes a reduced-order system by projecting onto the dominant left and right eigenspaces of PQ without computing balancing transformations. The algorithm enhances the numerical robustness of the SR method in some aspects. Based on Schur decompositions of PQ , the right and left eigenspaces $V_r \in \mathbb{R}^{n \times r}$ and $V_\ell \in \mathbb{R}^{n \times r}$ of the matrix corresponding to the r largest eigenvalues are computed. By an SVD of the product of the two dominant invariant subspaces,

$$V_\ell^T V_r = \tilde{U} \tilde{\Sigma} \tilde{V}^T,$$

the transformation matrices

$$W^T = \tilde{\Sigma}^{-1/2} \tilde{U}^T V_\ell^T \in \mathbb{R}^{r \times n}, \quad V = V_r \tilde{V} \tilde{\Sigma}^{-1/2} \in \mathbb{R}^{n \times r}$$

are derived. The resulting reduced-order system (3) is not balanced but still satisfies the balanced truncation error bound (11).

The balancing-free SR method [192] combines the SR with the Schur method using orthogonal bases of $\text{range}(V)$ and $\text{range}(W)$ from two QR factorizations:

$$Z_P \tilde{U}_1 = [P_1 \ P_2] \begin{bmatrix} \hat{R} \\ 0 \end{bmatrix}, \quad Z_Q \tilde{V}_1 = [Q_1 \ Q_2] \begin{bmatrix} \tilde{R} \\ 0 \end{bmatrix},$$

where the matrices \tilde{U}_1 and \tilde{V}_1 were computed by (13) and Z_P, Z_Q are the Cholesky factors of the Gramians. A further SVD

$$Q_1^T P_1 = \tilde{U} \tilde{\Sigma} \tilde{V}^T$$

yields the well-conditioned transformation matrices

$$W^T = \tilde{\Sigma}^{-1/2} \tilde{U}^T Q_1 \in \mathbb{R}^{r \times n}, \quad V = P_1 \tilde{V} \tilde{\Sigma}^{-1/2} \in \mathbb{R}^{n \times r}.$$

The reduced-order system is obtained by (2) and (3). Note that a numerically robust implementation would avoid the explicit computation of the product PQ by using a product QR algorithm (see [123] and the references therein) and a product SVD [78, 109] instead.

Cross-Gramian method

A closely related class of methods which contains information about the controllability as well as the observability of the system is based on another system Gramian, the cross-Gramian,

$$X_{CG} := \int_0^\infty e^{At} B L^T e^{At} dt. \quad (14)$$

For SISO or symmetric MIMO systems (systems with symmetric TFM) it satisfies

$$X_{CG}^2 = PQ,$$

such that the dominant invariant subspace of the cross-Gramian can be used for MOR [79, 80, 127]. The reduced-order model has the same properties as in BT model reduction, i.e. the stability is preserved and a computable global error bound exists.

In [3], the dominant eigenspace of X_{CG} is computed by an ordered real Schur form,

$$\begin{bmatrix} U_1^T \\ U_2^T \end{bmatrix} X_{CG} \begin{bmatrix} U_1 & U_2 \end{bmatrix} = \begin{bmatrix} S_{11} & S_{12} \\ 0 & S_{22} \end{bmatrix},$$

followed by a block diagonalization, using the solution X of a Sylvester equation

$$S_{11}X - XS_{22} + S_{12} = 0.$$

The reduced-order system is obtained without computing balancing transformations, applying the transformation matrices

$$W^T = U_1^T - X^T U_2^T \in \mathbb{R}^{r \times n}, \quad V = U_1 \in \mathbb{R}^{n \times r}$$

directly in step (2) and (3). Model reduction based on the cross-Gramian is also considered in [6, 23, 181].

Computing the Gramians

The computation of the system Gramians (or of factors of them) as first computational step is required in all methods described above. The Gramians (8) are equivalently given by the solutions of the two Lyapunov equations

$$AP + PA^T + BB^T = 0, \quad A^T Q + QA + LL^T = 0, \quad (15)$$

such that the main computational task in most implementations is the solution of these matrix equations. At the end of this paragraph we will mention an alternative approach for computing the Gramians by numerical quadrature.

The cross-Gramian (14) is given by the solution of one Sylvester equation,

$$AX_{CG} + X_{CG}A + BL^T = 0.$$

The matrix equations are of the same dimension as the original system, thus the work complexity of BT and related methods is usually $O(n^3)$ and the storage requirements are of order $O(n^2)$.

Direct methods and standard iterative approaches for the solution of Lyapunov equations are therefore restricted to problems of size $n = O(1000)$ (depending on the computer capacities) and hence of limited use. Using recent MATLAB[®] distributions for 64 Bit operating systems [141], larger Lyapunov equations with orders up to a few thousands can be solved with direct methods provided that sufficient memory is available. Using parallel algorithms for distributed memory machines [43, 44, 47] or modern multi-core or multi-GPU systems [36], the limits of these techniques can be further advanced nowadays.

The (balancing-free) SR methods as described above are based on Cholesky factors of the Gramians. These methods and related approaches can also be implemented by using low-rank approximations to the Gramians [44], i.e.

$$P \approx \tilde{Z}_P \tilde{Z}_P^T, \quad Q \approx \tilde{Z}_Q \tilde{Z}_Q^T, \quad (16)$$

with $\tilde{Z}_P \in \mathbb{R}^{n \times r_P}$ and $\tilde{Z}_Q \in \mathbb{R}^{n \times r_Q}$. This was motivated by the observation that in the large-scale setting often the Gramians have a low numerical rank $r_P, r_Q \ll n$, [7, 97, 154, 182]. Thus, it is advised to use implementations based on such low-rank approximations since they usually need significantly less storage and are of reduced costs. This problem has attracted the interest of many mathematicians, there are many iterative methods which exploit the low-rank property particularly for the solution of large-scale, sparse Lyapunov equations, see, e.g.,

- Krylov subspace methods [188, 67, 68, 111, 113, 114, 116, 118, 136, 171, 179, 180], and tensor Krylov subspace methods [31, 124],
- the factorized sign function iteration [34, 42, 43], and data-sparse implementations of the method [22, 24, 99],
- multi-grid methods [152, 167], based on low-rank arithmetic [98],
- low-rank alternating direction implicit (ADI) methods or Smith iterations, e.g., the Cholesky Factor ADI (CF-ADI) algorithm [40, 129, 131, 153], cyclic low-rank Smith methods [108, 153] and parallelizations of the low-rank ADI iteration [9],
- a method based on optimization on a Riemannian manifold [32, 191].

Due to the progress in computer hardware, but even more because of advances in techniques from Numerical Linear Algebra, Lyapunov equations for really large scale

systems with n up to a billion can nowadays be solved on standard workstations. We will describe the implementation of BT model order reduction based on these techniques, yielding approximate low-rank Gramians, in the next paragraph.

The use of efficient solvers for large-scale Lyapunov equations improves the implementations of BT, see, e.g., [24, 26, 41, 44, 47, 107, 163, 189] and of balancing-related model reduction methods, e.g., an optimal Hankel norm approximation [48, 94], singular perturbation approximation [45, 139, 192], frequency weighted BT [66, 93, 105], and balanced stochastic truncation [46].

For unstable systems, generalizations of BT can be applied, see [20, 33, 205]. The major computational problems arising in these approaches are similar to those for usual BT since they require the numerical solution of algebraic Bernoulli equations (ABEs) and/or of Lyapunov equations. Numerical methods for the solution of ABEs require $O(n^3)$ flops and the storage of $O(n^2)$ real numbers. Using parallel distributed-memory computers the iterative solvers benefit from their suitability to apply parallel implementation techniques [20, 33].

Yet another approach for implementing an “approximate” BT method is based on avoiding the explicit solution of the Lyapunov equations (15) by applying numerical quadrature to the integral form of the Gramians (8). Instead of computing these integrals directly in the time domain [171], the integrals of the Gramians in frequency domain (applying Parseval’s theorem [176, pp. 410-411]) are approximated by

$$\begin{aligned} P &= \frac{1}{2\pi} \int_{-\infty}^{\infty} (j\omega I - A)^{-1} B B^T (j\omega I - A^T)^{-1} d\omega \\ &\approx \sum_{i=1}^m w_i (j\omega_i I - A)^{-1} B B^T (j\omega_i I - A^T), \end{aligned} \quad (17)$$

using weights w_i and quadrature points ω_i , $i = 1, \dots, m$. This technique was introduced first in [195] and was interpreted there as frequency-domain POD — it can be understood as dual POD, using snapshots of the dynamical system itself for the controllability Gramian and snapshots of the dual system for the observability Gramian. The approach was later called Poor Man’s Truncated Balanced Reduction (PMTBR) method in [161]. Note that PMTBR as introduced in [161] is only suitable for systems with $A = A^T$ and $B = L$ and hence $P = Q$. The transformation matrix V for MOR is obtained from an eigendecomposition of the approximate Gramian. For PMTBR, the error between the approximate and the original Gramian is highly dependent on the numerical quadrature scheme and the chosen underlying frequency integral (i.e. the range spanned by the quadrature points ω_i).

Properties of the reduced-order model using approximate Gramians

In general, using low-rank approximations to the system Gramians (16) or approximations of the Gramians for a given frequency range computed by numerical quadrature, it can not be assured that model reduction by BT still preserves the stability of the original system. However, in practice, this seems to be negligible.

The global error bound (11) is based on the assumption that the transformation matrices for MOR are computed in exact arithmetic. Using approximate low-rank factors Z_P , Z_Q , the bound is expected to hold only approximately, see [24, 107].

Moreover, the original error bound cannot be computed anymore since only a few HSVs $\{\sigma_1, \dots, \sigma_k\}$ with $k := \min\{r_P, r_Q\}$ were computed by all low-rank methods. The remaining HSVs $\{\sigma_{k+1}, \dots, \sigma_n\}$ have to be estimated.

Dominant subspace projection

The dominant subspace projection method (DSPMR) [155] is a heuristic, balancing-free method that uses approximate low-rank factors \tilde{Z}_P, \tilde{Z}_Q from (16). An orthonormal basis V for the projection (with $V = W$) is computed using an economy-size SVD of

$$Z = [\tilde{Z}_P, \tilde{Z}_Q] \in \mathbb{R}^{n \times (r_P + r_Q)}$$

with $(r_P + r_Q) \ll n$ and $r := \text{rank}(Z)$:

$$Z = \tilde{U} \tilde{\Sigma} \tilde{V}^T, \quad \tilde{U} \in \mathbb{R}^{n \times (r_P + r_Q)}.$$

Then VV^T with $V := [\tilde{u}_1, \dots, \tilde{u}_r] \in \mathbb{R}^{n \times r}$ is a projector onto the range of Z and

$$\text{range}(V) = \text{range}(\tilde{Z}_P) + \text{range}(\tilde{Z}_Q).$$

A modification of this method is proposed in [130] where the system is projected onto the sum of the dominant eigenspaces of the two Gramians. By a choice of $k \leq \min\{r_P, r_Q\}$ and two economy-size SVDs of the approximate low-rank factors

$$\tilde{Z}_P = \tilde{U}_P \tilde{\Sigma}_P \tilde{V}_P^T, \quad \tilde{Z}_Q = \tilde{U}_Q \tilde{\Sigma}_Q \tilde{V}_Q^T,$$

an orthogonal projection V onto an r dimensional space is obtained by a QR decomposition of the first k columns of \tilde{U}_P and \tilde{U}_Q ,

$$\begin{bmatrix} \tilde{U}_P(:, 1:k), \tilde{U}_Q(:, 1:k) \end{bmatrix} = VR,$$

with $k \leq r = \text{rank}(V) \leq 2k$.

Error bound for systems with nonzero initial conditions

We want to point at an often neglected aspect concerning the global error bound of balanced truncation. The original bound (11) is derived only for systems with zero initial conditions. For systems with $x(0) \neq 0$ it can be observed that the error between the original output and the reduced output can be rather large. We illustrate this observation for a random system of size $n = 100$ in Fig. 1 and Fig. 2.

The system is reduced to order $r = 4$ by balanced truncation. Both the original system and the reduced model are simulated in time domain with a sine wave input of amplitude 10. In Fig. 1 it can be seen that the time simulation of the reduced-order system is not distinguishable from the original one using zero initial values. If the initial states are chosen as random values with relatively large norm, i.e. $\|x(0)\|_2 = O(10^3)$, the two time simulation results differ significantly as illustrated in Fig. 2. This remarkable error is caused by an additional part in the estimate of the output

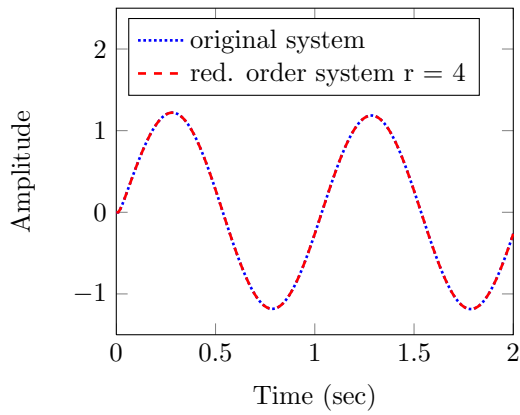

Fig. 1 Time simulation with zero initial conditions

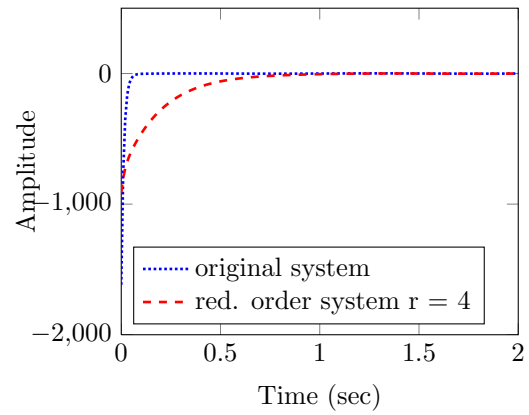

Fig. 2 Time simulation, non-zero initial conditions

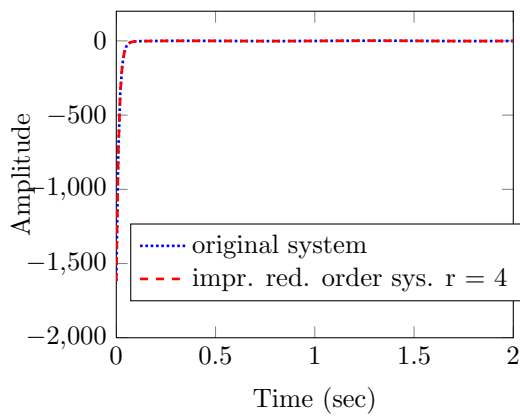

Fig. 3 Time simulation with non-zero initial conditions, improved version

error (7) for systems with non-zero initial conditions. The system output is calculated in the frequency domain by

$$y(s) = (L^T(sI_n - A)^{-1}B)u(s) + L^T(sI_n - A)^{-1}x(0),$$

and

$$\hat{y}(s) = (\hat{L}^T(sI_r - \hat{A})^{-1}\hat{B})u(s) + \hat{L}^T(sI_r - \hat{A})^{-1}W^T x(0),$$

respectively, which expands the error between the outputs in (7), i.e. the BT error bound (11), to

$$\|y - \hat{y}\|_2 \leq 2 \sum_{i=r+1}^n \sigma_i \|u\|_2 + \|L^T[(sI_n - A)^{-1} - V(sI_r - \hat{A})^{-1}W^T]\|_\infty \|x(0)\|_2.$$

In [110], an extension of the standard balanced truncation method to systems with inhomogeneous initial conditions is presented and error estimates were given. We propose a slightly different approach and derive an error bound at the end of this section. For systems with $x(0) = x_0 \neq 0$, we propose to apply BT to a transformation of (4)

$$\begin{aligned} \dot{\tilde{x}}(t) &= A\tilde{x}(t) + \tilde{B}\tilde{u}(t), \\ \tilde{y}(t) &= L^T(\tilde{x}(t) + x_0), \end{aligned} \quad (18)$$

with $\tilde{x}(t) = x(t) - x_0$, $\tilde{x}(0) = 0$ and $\tilde{B} = [B, Ax_0]$ and $\tilde{u}(t) = [u(t), 1]^T$. The reduced system is obtained by using the approximation $\tilde{x} \approx V\hat{x}$:

$$\begin{aligned} \dot{\hat{x}}(t) &= \hat{A}\hat{x}(t) + \hat{B}\tilde{u}(t), \\ \hat{y}(t) &= \hat{L}^T\hat{x}(t) + L^T x_0, \end{aligned} \quad (19)$$

where $\hat{A} = W^T A V$, $\hat{B} = W^T \tilde{B}$, $\hat{L} = V^T L$. The output $y(t)$ of the original system in (4) is approximated by the output of the reduced system in (19), $y(t) \approx \hat{y}(t)$.

The results of the modified approach are shown in **Fig. 3** using the same non-zero initial conditions as in **Fig. 2**. It is observed that the time simulation results of the original and the reduced-order system nearly coincide. From Laplace transformations of (18) and (19), the error between $y(s)$ and $\hat{y}(s)$ in (19) can be bounded by:

$$\begin{aligned} \|y(s) - \hat{y}(s)\| &= \|\tilde{y}(s) - \hat{y}(s)\| \quad (\text{because } y(t) = \tilde{y}(t)) \\ &= \|(L^T \tilde{x}(s) + L^T x(0)/s) - (\hat{L}^T \hat{x}(s) + L^T x(0)/s)\| \\ &= \|L^T(sI_n - A)^{-1}\tilde{B}\tilde{u}(s) - \hat{L}^T(sI_r - \hat{A})^{-1}\hat{B}\tilde{u}(s)\| \\ &\leq \|L^T(sI_n - A)^{-1}\tilde{B} - \hat{L}^T(sI_r - \hat{A})^{-1}\hat{B}\| \|\tilde{u}(s)\| \\ &\leq 2 \sum_{i=r+1}^n \tilde{\sigma}_i \|\tilde{u}\|_2. \end{aligned}$$

Note, that the $\tilde{\sigma}_i$'s are not the HSVs of the original system (4) but of the associated system:

$$\begin{aligned} \dot{x}(t) &= Ax(t) + \tilde{B}u(t), \\ y(t) &= L^T x(t). \end{aligned} \quad (20)$$

We denote the controllability Gramian of the original system (4) by P , the corresponding balancing transformation by T and the Gramian of (20) by $\tilde{P}(x_0)$. The difference between the two Gramians is given by

$$\Delta(x_0) := P - \tilde{P}(x_0) = - \int_0^{\infty} e^{At} A x_0 x_0^T A^T e^{A^T t} dt.$$

Since A is stable, we may choose $M, \omega > 0$ such that

$$\|e^{At}\|_2 \leq M e^{-\omega t}, \quad \text{for all } t \geq 0.$$

Then Bauer-Fike [95, Theo. 7.2.2] gives the following estimate for the difference of the HSVs:

$$\begin{aligned} |\sigma_i^2 - \tilde{\sigma}_i^2| &= |\lambda_i(PQ) - \lambda_i(\tilde{P}(x_0)Q)| \\ &= |\lambda_i(PQ) - \lambda_i(PQ - \Delta(x_0)Q)| \\ &\leq \|T\|_2 \|T^{-1}\|_2 \|\Delta(x_0)Q\|_2 \\ &\leq \|T\|_2 \|T^{-1}\|_2 \|A\|_2^2 \|x_0\|_2^2 \|Q\|_2 \int_0^{\infty} M^2 e^{-2\omega t} dt \\ &\leq \|T\|_2 \|T^{-1}\|_2 \|A\|_2^2 \|x_0\|_2^2 \|Q\|_2 \frac{M^2}{2\omega}. \end{aligned}$$

2.2 Methods based on Krylov subspaces

The next important class of MOR methods for linear systems is based on Krylov subspaces. They are often called moment-matching methods or Padé approximation methods. These methods are very efficient in many engineering applications, including circuit simulation and simulation of machine tools [69].

Methods based on Krylov subspaces are often designed for a direct application to descriptor systems (12). In order to be in agreement with the previous section, we describe the methods for the application to the standard state space system in (4).

The basic steps are as follows. First, the transfer function (6) is expanded into a power series at an expansion point $s_0 \in \mathbb{C} \cup \infty$. Let $s = s_0 + \sigma$, then, within the convergence radius of the series, we have

$$\begin{aligned} H(s_0 + \sigma) &= L^T [(s_0 + \sigma)I - A]^{-1} B = L^T [\sigma I + (s_0 I - A)]^{-1} B \\ &= L^T [I + \sigma(s_0 I - A)^{-1}]^{-1} [(s_0 I - A)]^{-1} B \\ &= L^T [I - \sigma(s_0 I - A)^{-1} + \sigma^2 [(s_0 I - A)^{-1}]^2 + \dots] \times (s_0 I - A)^{-1} B \\ &= \sum_{i=0}^{\infty} \underbrace{L^T [-(s_0 I - A)^{-1}]^i (s_0 I - A)^{-1} B}_{:= m_i(s_0)} \sigma^i, \end{aligned}$$

where $m_i(s_0)$ are called the moments of the transfer function about s_0 for $i = 0, 1, 2, \dots$. If the expansion point is chosen as zero then the moments simplify to $m_i(0) =$

$L^T(-A^{-1})^{i+1}B$. For $s_0 = \infty$ the moments are also called Markov parameters which can be computed by $L^T A^{i-1} B$.

The goal in moment-matching model reduction is the construction of a reduced-order system where some moments \hat{m}_i of the associated transfer function \hat{H} match some moments of the original transfer function H . A few important classes of approximations are listed in **Table 1**.

Name of reduced-order system	Matched moments
Padé approximation [19]	$m_i(s_0) = \hat{m}_i(s_0), \quad i = 0, 1, \dots, 2r - 1$
Partial realization [96]	$m_i(\infty) = \hat{m}_i(\infty), \quad i = 0, 1, \dots, 2r - 1$
Multipoint Padé approximation or rational interpolation [4, 19]	$m_i(s_j) = \hat{m}_i(s_j), \quad i = 0, 1, \dots, 2r_j - 1,$ for $j = 1, \dots, k,$ and $r_1 + \dots + r_k = r$

Table 1: Some examples for MOR by moment-matching

The matrices V and W for model order reduction can be computed from the vectors which are associated with the moments, for example, using one expansion point $s_0 = 0$, by

$$\text{range}(V) = \text{span}\{A^{-1}B, (A^{-1})^2B, \dots, (A^{-1})^rB\}, \quad (21)$$

$$\text{range}(W) = \text{span}\{L, A^{-T}L, (A^{-T})^2L, \dots, (A^{-T})^{r-1}L\}. \quad (22)$$

The derived reduced-order system matches the first $2r$ moments; the corresponding transfer function \hat{H} has good approximation properties around 0. Using a set of k distinct expansion points $\{s_1, \dots, s_k\}$, the reduced-order system obtained by, e.g.,

$$\text{range}(V) = \text{span}\{(A - s_1I)^{-1}B, \dots, (A - s_kI)^{-1}B\}, \quad (23)$$

$$\text{range}(W) = \text{span}\{(A - s_1I)^{-T}L, \dots, (A - s_kI)^{-T}L\}, \quad (24)$$

matches the first two moments at each $s_j, j = 1, \dots, k$, see [101]. For the case of one expansion point in (21), (22), it can be seen that the columns of V, W span Krylov subspaces which can easily be computed by Arnoldi or Lanczos methods. The matrices V and W in (23), (24) can be computed with the rational Krylov algorithm in [101] or with the modified Gram-Schmidt process. In these algorithms only a few number of linear systems need to be solved, where matrix-vector multiplications are only used if using iterative solvers, which are simple to implement and the complexity of the resulting methods is roughly $O(nk^2)$ for a sparse matrix A .

A reduced-order system (5) is obtained following (2) and (3).

The early work on moment-matching is the Asymptotic Waveform Evaluation (AWE) method in [162]. However, this method suffers from numerical instability because the moments are explicitly computed. For instance, instead of computing the matrices V and W in (21), (22), the vectors on the right hand sides of (21) are directly computed to obtain the moments and the poles of the transfer function. As a result, the vectors become linearly dependent, and converge to an eigenvector of the matrix A corresponding to the smallest eigenvalue.

To overcome the numerical instability of the AWE method, more recent work led to numerically more robust methods as Padé via Lanczos (PVL) [70] (see also [71, 92]), and a passive reduced-order interconnect macromodeling algorithm (PRIMA) [148]. Here, the orthogonal bases V and W of the Krylov subspaces (e.g. in (21)-(24)) are computed implicitly, and the moments are implicitly matched by the reduced model. For matching the transfer function over a larger frequency range, rational methods including multiple expansion points as the dual rational Arnoldi and the rational Lanczos method were proposed in [101]. Using restarting techniques as described in [102] or the implicitly restarted dual Arnoldi method in [117], a subsystem is retained as reduced-order model which has purely stable eigenvalues.

In general, methods based on Krylov subspaces do not preserve important properties of the original system as stability and passivity. For some reduced-order systems this can be achieved using post-processing techniques [13, 14]. For RCL sub-circuits there exist several approaches where the reduced-order models are guaranteed to be stable and passive, see [15, 89, 90, 91, 120, 148, 177]. Further preservation of structural properties can be found, e.g. in [88, 134].

Issues on automatic generation of the reduced model

Some important issues for moment-matching methods are: How to adaptively determine the number and the location of the expansion points, and the number of the matched moments? How to determine the order of the reduced model? Is there any error bound for the reduced model? These issues have to be considered if the reduced model needs to be automatically generated. Automatic generation of the reduced model is very important for the robustness of the related simulation tools in today's design automation for MEMS and Integrated circuits (IC).

To illustrate this problem, we show some simulation results for a system obtained from modeling large-scale interconnects in IC design (see Fig. 4). The interesting frequency range is $\omega \in [0, 2\pi 10^{10}]$. The method PRIMA in [148] is used to obtain the transfer function of the reduced model.

Fig. 5– Fig. 8 show the magnitudes of the relative errors between the original transfer function $H(s)$ and the reduced transfer function $\hat{H}(s)$ of order $r = 54$, obtained using different expansion points and numbers of moments matched. The reduced transfer function used in Fig. 5 is computed by expanding $H(s)$ at zero and by matching 54 moments. For Fig. 6, $\hat{H}(s)$ is obtained by expanding $H(s)$ at a high frequency $\omega = 2\pi 10^{10}$ (the corresponding expansion point is $s_0 = j\omega$, $j = \sqrt{-1}$), and by matching 27 moments. Since the computed matrix V using this s_0 is a complex matrix, the final projection matrix is the combination of the real and the imaginary parts of V , and thus has $27 \times 2 = 54$ columns (there is no deflation in the Arnoldi process in PRIMA for this example). We see that if only one expansion point is chosen, $\hat{H}(s)$ is accurate only in a limited frequency band. Classical moment-matching (i.e., $s_0 = 0$) apparently is more accurate than using the high frequency expansion point as can be seen from Fig. 6. The reason is that it matches twice the number of moments. However, there are still large errors around the high frequency $\omega = 2\pi 10^{10}$ in Fig. 5 where expansion at this frequency yields a small error there. The relative errors obtained

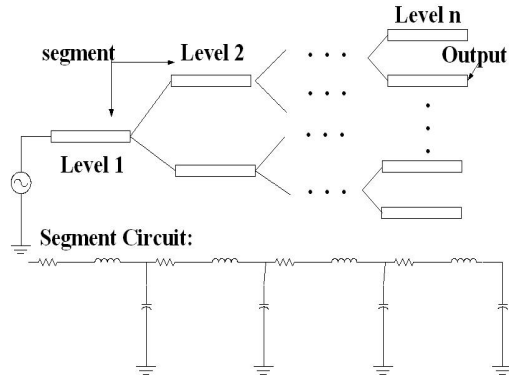

Fig. 4 An interconnect circuit example

by expanding $H(s)$ at both zero and $\omega = 2\pi 10^{10}$ can be seen in Fig. 7 and Fig. 8. In Fig. 7, 34 moments at zero and 10 moments at $\omega = 2\pi 10^{10}$ are matched to get $\hat{H}(s)$. 14 moments at zero and 20 moments at $\omega = 2\pi 10^{10}$ are matched by the reduced transfer function used in Fig. 8. The relative error shown in Fig. 7 is very small and is below the usual accuracy needs in industrial applications, whereas the one in Fig. 8 exhibits large errors at the frequencies in the middle. The above analysis shows that the accuracy of the reduced model depends not only on the choice of the expansion points, but also on the number of the moments matched.

An early method called CFH (Complex Frequency Hopping) is proposed in [58] to describe a principle of choosing multiple expansion points of the transfer function. By using a binary search algorithm, the expansion points are chosen with respect to the common poles contained in both circles of the neighboring expansion points. However, like the AWE method in [162], the poles of the transfer function are computed based on explicit computation of the moments. Therefore, the computed poles are actually not accurate, because of numerical instability, although they would represent the actual poles if computed with precise arithmetic. A transfer function-based approach is proposed in [1] by using a similar binary search algorithm as in [58]. However, one reduced model is constructed at each expansion point, which means 10 reduced models are constructed if 10 expansion points are chosen. Furthermore, the reduced models are obtained by explicitly calculating the moments, which causes the same numerical instability problem as in [162].

Recent progresses on the above issues

Remarkable progresses have been made in this active research area since the early work in [1, 58]. In [59], the expansion points are automatically selected according to the error between the j th order moments $m_j(s_i)$ and $\hat{m}_j(s_i)$. There is not a stopping

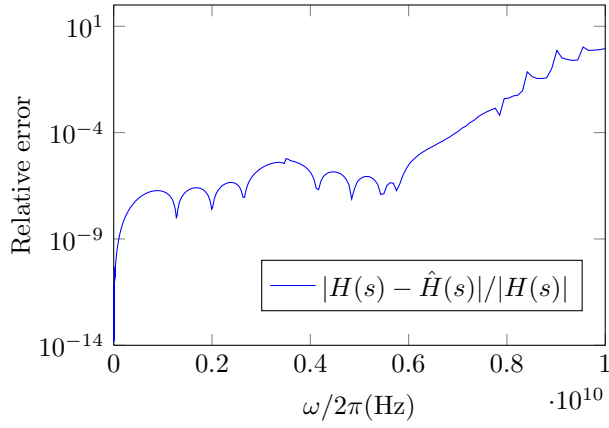

Fig. 5 Relative error of $\hat{H}(s)$ by expanding $H(s)$ at $\omega = 0$ (54 moments matched)

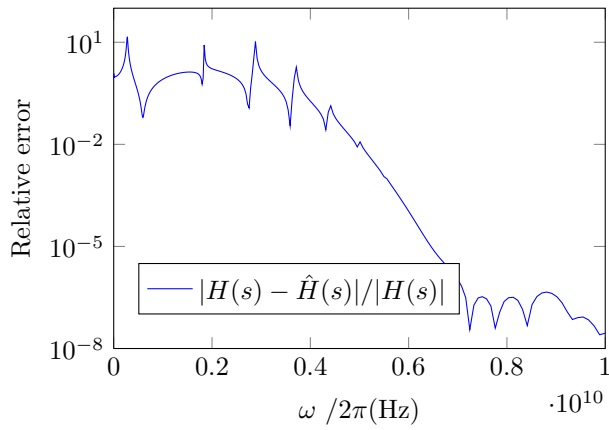

Fig. 6 Relative error of $\hat{H}(s)$ expanding $H(s)$ at $\omega = 2\pi 10^{10}$ (27 moments matched)

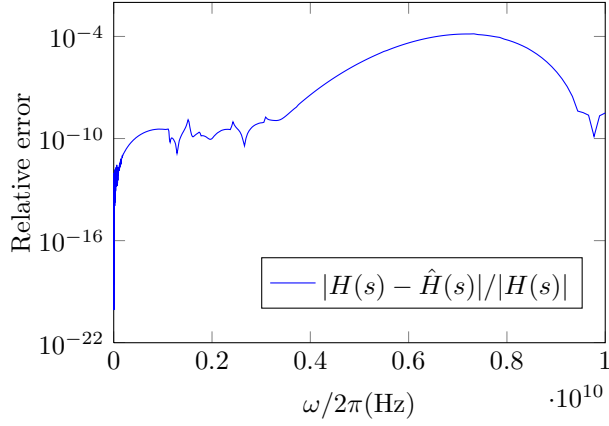

Fig. 7 Relative error of $\hat{H}(s)$ by expanding $H(s)$ at $\omega = 0$ (34 moments matched) and at $\omega = 2\pi 10^{10}$ (10 moments matched)

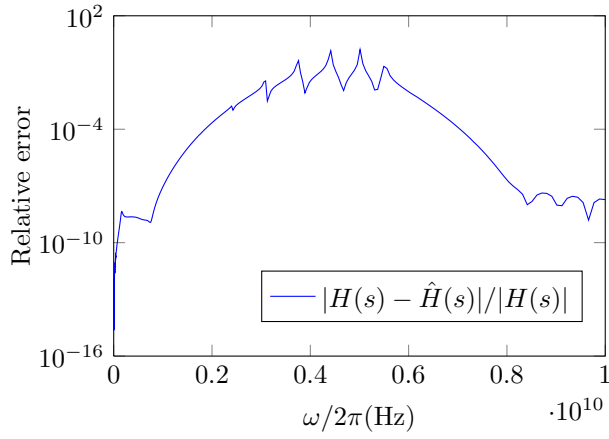

Fig. 8 Relative error of $\hat{H}(s)$ by expanding $H(s)$ at $\omega = 0$ (14 moments matched) and at $\omega = 2\pi 10^{10}$ (20 moments matched)

criterion for the selection process since no error estimation for the reduced model is available. As a result, the reduced model cannot be derived automatically.

A few years ago, the issue of multi-point expansion of the transfer function was readdressed in [106]. Methods based on interpolation are proposed in the paper, which claim some rules for selecting the interpolation points needed for approximating the transfer function. However, the methods are actually not adaptive in choosing the number of interpolation points. In [106] it is shown that the \mathcal{H}_2 -error

$$\|H - \hat{H}\|_{\mathcal{H}_2} := \left(\frac{1}{2\pi} \int_{-\infty}^{\infty} |H(j\omega) - \hat{H}(j\omega)|^2 d\omega \right)^{1/2}$$

is minimized for SISO systems if the expansion points are chosen as $s_j = -\hat{\lambda}_j$, where $\hat{\lambda}_1, \hat{\lambda}_2, \dots, \hat{\lambda}_k$ are the simple poles of the reduced order system (the mirror images of \hat{H}). For this optimal shift selection, the following moments are matched:

$$m_0(-\lambda_j) = \hat{m}_0(-\lambda_j), \quad m_1(-\lambda_j) = \hat{m}_1(-\lambda_j),$$

for $j = 1, \dots, k$. An iterative rational Krylov algorithm (IRKA) [106, Algorithm 4.1] is proposed and successfully applied to larger problems. The method is numerically effective, only LU decompositions and linear solvers are required and the solution satisfies interpolation based first-order necessary conditions for \mathcal{H}_2 optimality. The preservation of stability cannot be guaranteed in advance but only seems to be a problem for an initial shift selection which is very different from the mirror spectrum of A . A generalization of the approach to MIMO systems can be found in [55, 106, 190]. Based on IRKA, a new interpolatory approach for \mathcal{H}_∞ approximation was developed in [83]. The method can be efficiently applied to large-scale SISO systems and computes high fidelity (nearly optimal) \mathcal{H}_∞ solutions.

In a recently published work [65] an adaptive computation of shifts for rational Krylov subspace methods of Galerkin type is presented. This approach computes slightly less accurate reduced-order systems than IRKA but with much less computational cost.

The SPARK algorithm in [150] is an iterative scheme to adaptively chose the expansion points in Krylov subspace methods, and in particular the order of the reduced model. It implicitly guarantees preservation of stability and contains an optimization algorithm that converges to an \mathcal{H}_2 optimum. Though less efficient than IRKA, it allows to choose the reduced order on-the-fly and does not suffer from the stability issue. In general, only the first moment at each expansion point is matched. There is limited flexibility of adaptively choosing the number of moments.

An adaptive approach similar to the idea in [1, 58] is proposed in [76]. There are some advantages over the algorithms in [1, 58]. Firstly, a single reduced model can be obtained. Secondly, the error estimation of the reduced model is the error between the reduced model and the original model computed at a few points in the frequency interval. This can be computed cheaply. Thirdly, the moments are computed based on implicit moment-matching [148], which can maintain numerical stability.

Finally, according to the adaptive scheme, not only the expansion points, the number of matched moments, but also the order of the reduced model can be determined adaptively.

A new method is proposed in [50]. The method addresses the problem of adaptively choosing the expansion points based on a similar binary principle as the methods in [76]. It is shown that the adaptive rules of selecting the expansion points in [50] can be combined with the method of selecting the moments in [128] to give an adaptive scheme of selecting both the expansion points and the moments. How to determine the order of the reduced model is unknown.

All the above adaptive schemes include more or less heuristics, since there is not a convincing error estimation for the reduced model. Earlier results concerning error bounds for Krylov subspace based methods [17] yield only local bounds for the transfer function. Such error bounds can only be used to estimate the accuracy of the transfer function in a certain frequency range, and cannot give a global estimation in the whole frequency domain. Some heuristic error indicators are proposed in [101, 25], where the error between the transfer functions of two different reduced models are used as the error of the reduced model. However, they are not provable error estimations for the error between the reduced model and the full system.

A provable error estimator for lossless systems (systems without resistors) which is independent from the choice of expansion points is introduced in [121, 122].

A posterior error estimation for linear time invariant systems is proposed in [74]. The error estimation is an error bound for the transfer function. According to the error estimation, the expansion points can be adaptively selected through a greedy algorithm, where the point which causes the biggest error is selected as the next expansion point. So far, the method is valid only for special linear time invariant systems in (12), where C is symmetric positive definite, G is symmetric.

A Gramian-based output error bound is proposed in [197]. The error bound requires the explicit computation of the observability Gramian Q and is therefore not computationally practical for very large systems. However, using a certain factorization of the error system yields an \mathcal{H}_2 error bound which is valid for any reduced system obtained by Krylov subspace methods provided that the observability Gramian has been computed once [199]. In [151], global \mathcal{H}_2 and \mathcal{H}_∞ error bounds for Krylov subspace methods are derived. They apply to systems with C symmetric positive definite and $G + G^T > 0$.

Another method of adaptively selecting the expansion points is proposed in [194]. The expansion points are selected also through certain greedy algorithm. However, during the greedy algorithm, the error estimation for the reduced model is based on the error between the state vector of the original system and the approximate state vector computed from the reduced model, rather than the error between the transfer functions used in [74]. Most often, we are interested in the time domain output response or the transfer function of the system, but not in the state vector. The error between the output of the original system and that of the reduced model often tends to be overestimated by the error between the state vectors. It is not clear how to automatically choose the expansion points based on other moment-matching methods as described in [70, 148], which are widely used in circuit and MEMS simulation.

For survey papers on model reduction based on Krylov subspaces see, e.g. [11, 86, 87, 75].

2.3 Hybrid methods

Hybrid methods try to benefit from the combination of Krylov subspace methods with Gramian based approaches. They compute intermediate models of moderate but still high order by a projection onto Krylov subspaces. The reduced size of the intermediate model allows for a further reduction by implementations of BT (and related methods) based on direct methods for the solution of Lyapunov equations [119]. Note, that for hybrid methods the preservation of stability in the first reduction step plays an essential role. Otherwise, a further reduction by BT would not be possible. A framework for this two-step approach allowing also for other reduction techniques in the first step is discussed in [200]. An approach using Krylov subspace projection in both steps is described [196].

2.4 Relationships between different methods

In this subsection, we will explore relationships between some of the methods for linear model order reduction. Since for general unsymmetric systems, connections between different methods are not obvious, we concentrate on symmetric systems where $A = A^T$ and $B = L$. Note that for symmetric systems, the two Gramians P and Q are equal. Therefore, MOR by BT simplifies to the problem of computing the dominant invariant subspace $V_1 \in \mathbb{R}^{n \times r}$ of the Gramian P ,

$$P = [V_1, V_2] \begin{pmatrix} \Lambda_1 & 0 \\ 0 & \Lambda_2 \end{pmatrix} [V_1, V_2]^T,$$

with non-increasingly ordered eigenvalues $\text{diag}(\Lambda_1) \cup \text{diag}(\Lambda_2) = \{\lambda_1, \dots, \lambda_n\}$. Note that $V = V_1$ is used as transformation matrix (with $W = V$) for MOR in (2) and (3).

Therefore, if the Gramian is approximated via its low-rank factor $Z \in \mathbb{R}^{n \times r_P}$ where r_P is the numerical rank of P , $P \approx ZZ^T$, the original BT method as well as the SR method, the Schur method, the cross-Gramian approach, DSPMR, and the modification on DSPMR given in [130], project onto $\mathcal{V} := \text{range}(V_1)$ with

$$\text{range}(P) = \text{range}(Z) \supseteq \text{range}(V_1) = \mathcal{V}.$$

Thus, we do not distinguish between these methods in the following. Instead, we examine how the range of the low-rank approximate factor Z differs for some algorithms proposed for the numerical solution of matrix equations.

We consider the CF-ADI algorithm [131], the numerical quadrature in (17) [161], and a POD approach for the computation of a low-rank factor Z that can be used in the Gramian based model reduction methods mentioned above. Let Z be the m th CF-ADI approximation to the Cholesky factor of P and the number m be chosen as the largest number such that the columns in Z are linearly independent. For distinct

CF-ADI shifts $\{p_1, \dots, p_m\}$, and by use of $A_i := A + p_i I$, the columns of Z in [131] span the subspace

$$\begin{aligned} \text{range}(P) &\stackrel{(*)}{=} \text{range}(Z) \\ &\stackrel{(**)}{=} \text{span} \left\{ (A_1^{-1}B, \dots, \prod_{i=1}^m A_i^{-1}B) \right\} \\ &\stackrel{(***)}{=} \text{span} \{A_1^{-1}B\} \oplus \dots \oplus \text{span} \{A_m^{-1}B\} \\ &= \text{span} \{A_1^{-1}B, \dots, A_m^{-1}B\}. \end{aligned} \quad (25)$$

(*) [131, Prop. 7.6], (**) [131, Prop. 7.3], (***) [131, Theo. 5.4]

If the Gramian P is approximated by numerical quadrature as in PMTBR [161], the factor Z is described by

$$Z = [(j\omega_1 I - A)^{-1}B, \dots, (j\omega_m I - A)^{-1}B] \text{diag}(\sqrt{w_1}, \dots, \sqrt{w_m}), \quad (26)$$

where $\{w_1, \dots, w_m\}$ are the weights and $\{\omega_1, \dots, \omega_m\}$ are the frequency sampling points.

This formulation of Z is very similar to the one computed by the POD method as introduced in [195]:

$$Z = 1/\sqrt{m}[(j\omega_1 I - A)^{-1}B, \dots, (j\omega_m I - A)^{-1}B], \quad (27)$$

where $(j\omega_i I - A)^{-1}B$, $i = 1, 2, \dots, m$, are called the snapshots. This approach can be considered as POD in frequency domain since ω_i are frequency sampling points.

The above observations provide some insights into possible connections between the factors Z for the different methods, which are summarized in the following propositions.

Proposition 1. For stable linear systems (4) with $A = A^T$ and $B = L$, the method PMTBR and POD in frequency domain compute an equivalent factor Z , if the frequency points ω_i in (26) and in (27) are chosen equal, and the weights in (26) are taken as $w_i = 1/\sqrt{m}$, for $i = 1, 2, \dots, m$.

Proof. This can be concluded from (26) and (27). \square

Proposition 2. For stable linear systems (4) with $A = A^T$ and $B = L$, the columns of the Cholesky factor Z computed by the CF-ADI algorithm after m iteration steps and by PMTBR using m distinct frequency points span the same subspace if the CF-ADI shifts $\{p_1, \dots, p_m\}$ in (25) and the quadrature points $\{-j\omega_1, \dots, -j\omega_m\}$ in (26) for PMTBR are chosen equal.

Proof. Can simply be followed from (25) and (26). \square

As discussed in Section 2.2, the transformation matrix V (with $W = V$) for moment-matching methods using multiple interpolation points $\{s_1, \dots, s_m\}$ can be computed by

$$\text{range}(V) = \text{span}\{(A + s_1 I)^{-1}B, \dots, (A + s_m I)^{-1}B\}. \quad (28)$$

Then from (25), (26), (27), (28), we get the following equivalence result of Gramian based methods and moment-matching.

Proposition 3. For stable linear systems (4) with $A = A^T$ and $B = L$, all Gramian based methods with a low-rank factor Z computed by CF-ADI (25), by PMTBR (26) as well as by POD in frequency domain (27) can be considered as moment-matching methods.

Proof. It directly follows that the transformation matrices V computed by each of these methods as the dominant invariant subspace of the Gramians corresponding to the low-rank factors in (25), (26), (27), respectively, form an orthonormal basis for the subspace \mathcal{V} with $\mathcal{V} \subseteq \text{span}\{(A + s_1 I)^{-1}B, \dots, (A + s_m I)^{-1}B\}$, see (28). \square

There are other works which explore relations between different methods for computing low-rank solutions of Lyapunov equations.

It is shown in [81, 84, 188] that approximations to the solutions of Sylvester equations obtained from ADI and rational Krylov subspace methods coincide for \mathcal{H}_2 -optimal shifts. The connection of ADI and Krylov subspace methods is exploited in [198] for providing a constructive way of computing the ADI approximation.

For connections between (balanced) POD and MOR by rational interpolation, we refer to [149]. In this work, the selection of time sampling points and of the numerical method for computing the (time-domain) snapshots for POD is set into correlation to interpolation at infinity or at certain distinct points.

For surveys on MOR methods for linear large-scale systems, see [5, 6, 11, 85, 86], for techniques especially for micro-electro-mechanical systems and for systems that arise in circuit simulation, see [12, 75].

At the end of this section we summarize open issues and problems of interest in MOR for linear systems.

1. Gramian based MOR fails to reduce highly undamped systems since the Lyapunov solvers don't converge. One way out might be a different stopping criterion as, for instance proposed in [38], the convergence of some of the Hankel singular values.
2. Still progress is needed in the development of efficient solvers for large-scale matrix equations corresponding to general systems.
3. Improvements on the efficient computation of sharp and rigorous global error bounds for Krylov subspace methods (though partially solved in [74, 199, 151, 122]) would be valuable.

3 Model order reduction for nonlinear systems

In this section we consider nonlinear systems which appear in many engineering applications in the following form,

$$\begin{aligned} \frac{dx(t)}{dt} &= f(x(t)) + Bu(t), \\ y(t) &= L^T x(t), \end{aligned} \tag{29}$$

where $x(t) \in \mathbb{R}^n$ and $f(\cdot) \in \mathbb{R}^n$ is a nonlinear, vector valued function. The reduced model

$$\frac{dz(t)}{dt} = W^T f(Vz(t)) + W^T Bu(t) \quad (30)$$

can be obtained with a projection matrix W and a transformation matrix V with $W^T V = I$. At present there are several kinds of MOR methods for nonlinear systems. One method is the quadratic method [57], which is also the simplest one. The bilinearization method [16, 158] is more accurate than the quadratic method. Methods based on variational analysis [29, 30, 77, 103, 104, 159, 170], in general, yield smaller errors than the previous two methods. A method based on a piece-wise linear approximation of the nonlinear function $f(\cdot)$ [165] could be preferred when dealing with strong nonlinearities. These methods are, in some sense, extensions of the moment-matching methods or of BT for linear systems. They can be considered as frequency domain MOR methods, where transfer functions are used to measure the accuracy of the reduced model.

All nonlinear MOR methods as mentioned above either approximate the nonlinearity $f(Vz(t))$ by a polynomial of low degree [16, 57, 77, 158, 159] (can also be, a weighted sum of some low degree polynomials [165]), or transform (29) into a quadratic bilinear system [29, 30, 103, 104]. There, the direct computation of $f(Vz(t))$ in the reduced model (30) is replaced by the evaluation of a polynomial or a quadratic bilinear approximation. For other time-domain and snapshot-based nonlinear MOR methods like POD and the reduced basis method [100], the nonlinearity $f(Vz(t))$ must be directly evaluated. There are some techniques, which provide efficient estimates of $f(Vz(t))$ as the (discrete) empirical interpolation methods (DEIM or EIM) [21, 56], the missing point estimation method [8], or a best points interpolation method [146]. In [112], three different methods of approximating $f(Vz(t))$ are analyzed and compared in detail: a polynomial approximation [57, 77, 159], an approximation by a weighted sum of low degree polynomials or linear functions [165] and an approximation (estimation) by DEIM interpolation [56].

As already mentioned in the introduction, we are focusing here on frequency domain considerations and generalizations of moment matching. Thus, we will not discuss POD and other methods based on sampling in this section.

Throughout the section we use the nonlinear circuit example in Fig. 9 (see [57]) to provide some simulation results. The order of the original nonlinear system with $n = 100$ is rather small, but it suffices to illustrate basic properties of the discussed methods.

3.1 Quadratic method

We first analyze the quadratic MOR method proposed in [57]. This method approximates the nonlinear function $f(\cdot)$ by its Taylor expansion at, e.g., $x_0 = 0$, which can be rewritten into a Kronecker product formulation of x ,

$$f(x(t)) = f(0) + A_1 x(t) + A_2(x(t) \otimes x(t)) + A_3(x(t) \otimes x(t) \otimes x(t)) + \dots, \quad (31)$$

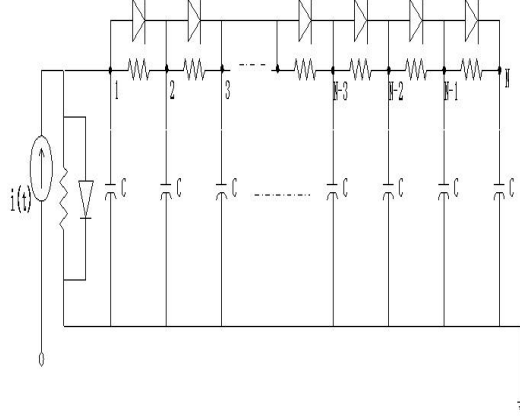

Fig. 9 Nonlinear circuit example

where $A_1 \in \mathbb{R}^{n \times n}$ is the Jacobian of f and, in general, $A_j \in \mathbb{R}^{n \times n^j}$ denotes a matrix of the j th partial derivatives of f . A quadratic system is obtained by a truncation of (31)

$$\begin{aligned} \frac{dx(t)}{dt} &= A_1 x(t) + A_2(x(t) \otimes x(t)) + Bu(t) + f(0), \\ y(t) &= L^T x(t). \end{aligned} \quad (32)$$

If $f(0) = 0$, the transformation matrix V is computed as an orthonormal basis of the Krylov subspace K_q as below

$$\text{range}(V) = \text{span}\{A_1^{-1}B, A_1^{-2}B, \dots, A_1^{-q}B\} =: K_q(A_1^{-1}, A_1^{-1}B). \quad (33)$$

Note that V is constructed only by use of the linear part of the quadratic system.

By approximating $x \approx Vz$, a reduced-order system is derived,

$$\begin{aligned} \frac{dz(t)}{dt} &= V^T A_1 Vz(t) + V^T A_2(Vz(t) \otimes Vz(t)) + V^T Bu(t), \\ y &= L^T Vz(t). \end{aligned}$$

It can be seen that the idea of the quadratic method comes from the moment-matching method for linear systems. The transformation matrix V is computed in the same way as moment-matching methods.

If $f(0) \neq 0$, then $f(0)$ can be considered as a part of the input, i.e. the system in (32) can be reformulated into,

$$\begin{aligned} \frac{dx(t)}{dt} &= A_1 x(t) + A_2(x(t) \otimes x(t)) + [B, f(0)][u(t), 1]^T, \\ y(t) &= L^T x(t), \end{aligned}$$

which is a multiple input system. The input matrix B in (32) is replaced by the matrix $[B, f(0)]$, which means $f(0)$ can always be treated as a part of the input matrix of the system, therefore for simplicity, we assume below $f(0) = 0$.

3.2 Bilinearization method

It is shown in [170, 175], that a bilinear system can be obtained by applying the Carleman linearization process to the nonlinear system (29). In [16, 158], the bilinear system is derived by approximating $f(x(t))$ with a two-degree polynomial in the Carleman linearization process. By use of the first two terms in (31), we obtain the following approximation of $f(x(t))$,

$$f(x(t)) \approx A_1 x(t) + A_2(x(t) \otimes x(t)).$$

With the definitions

$$\begin{aligned} x_\otimes &= \begin{pmatrix} x(t) \\ x(t) \otimes x(t) \end{pmatrix}, \quad B_\otimes = \begin{pmatrix} B \\ 0 \end{pmatrix}, \quad L_\otimes = \begin{pmatrix} L \\ 0 \end{pmatrix}, \\ A_\otimes &= \begin{pmatrix} A_1 & A_2 \\ 0 & A_1 \otimes I + I \otimes A_1 \end{pmatrix}, \\ N_\otimes &= \begin{pmatrix} 0 & 0 \\ B \otimes I + I \otimes B & 0 \end{pmatrix}, \end{aligned}$$

the nonlinear system (29) can be approximated by the following bilinear system,

$$\begin{aligned} \frac{dx_\otimes}{dt} &= A_\otimes x_\otimes + N_\otimes x_\otimes u(t) + B_\otimes u(t), \\ y(t) &= L_\otimes^\top x_\otimes, \end{aligned} \quad (34)$$

see [16, 158] for more details. We can see that the above bilinear system is of much larger state-space dimension than the original nonlinear system (29). It is possible to use more than the first two terms in (31) to get more complex bilinear systems, where the dimension of the resulting bilinear system is even larger, see [82, 170]. In the following we will introduce the process of constructing the transformation matrix V for MOR.

Once the nonlinear system is approximated by the bilinear system (34), there are several choices of doing MOR. Multimoment-matching methods extend the moment-matching methods for linear systems to bilinear systems by studying the transfer function of the bilinear system. Following the principle of the Gramian based MOR methods for linear systems, the Gramian based bilinear MOR methods construct the matrices W and V by exploring the Gramians of the bilinear systems. These two kinds of methods will be described and discussed separately.

Multimoment-matching methods

The bilinearization MOR methods in [16, 158] construct the matrices W, V , $W = V$ for the reduced model by approximating the transfer function of the bilinear system. These two methods are analyzed. Then, a method [73] is introduced, which is a combination of them and is shown to be more robust than both methods. Note that only SISO systems are considered in [16, 158]. For MIMO systems, the expression of the transfer function will be different, see [82, 135]. In [135], a method similar to [158]

was extended to MIMO systems. In the following description, we restrict ourselves to SISO bilinear systems.

The output response of the bilinear system (34) can be expressed by a Volterra series [170],

$$y(t) = \sum_{k=1}^{\infty} y_k(t),$$

with $y_k(t)$ described by

$$y_k(t) = \int_0^t \int_0^{t_1} \dots \int_0^{t_k} h_k^{(reg)}(t_1, \dots, t_k) u(t - t_1 - t_2 \dots - t_k) \times \\ u(t - t_2 - t_3 \dots - t_k) \dots u(t - t_k) dt_k \dots dt_1$$

and

$$h_k^{(reg)}(t_1, \dots, t_k) = L_{\otimes}^T e^{A_{\otimes} t_k} N_{\otimes} e^{A_{\otimes} t_{k-1}} \dots N_{\otimes} e^{A_{\otimes} t_1} B_{\otimes}. \quad (35)$$

In (35), $h_k^{(reg)}$ is called the regular kernel of k th degree. The multivariate Laplace transform of this kernel defines the k th transfer function $H_k^{(reg)}$:

$$H_k^{(reg)}(s_1, \dots, s_k) = L_{\otimes}^T (s_k I - A_{\otimes})^{-1} N_{\otimes} (s_{k-1} I - A_{\otimes})^{-1} N_{\otimes} \dots N_{\otimes} (s_1 I - A_{\otimes})^{-1} B_{\otimes}. \quad (36)$$

By using the Neumann expansion around 0,

$$(I - sA_{\otimes}^{-1})^{-1} = I + sA_{\otimes}^{-1} + s^2 A_{\otimes}^{-2} + s^3 A_{\otimes}^{-3} + \dots,$$

$H_k^{(reg)}(s_1, s_2, \dots, s_k)$ can be expanded in a multivariable Maclaurin series,

$$H_k^{(reg)}(s_1, \dots, s_k) = \sum_{l_k=1}^{\infty} \dots \sum_{l_1=1}^{\infty} m(l_1, \dots, l_k) s_1^{l_1-1} s_2^{l_2-1} \dots s_k^{l_k-1}, \quad (37)$$

with so called k th order multimoments $m(l_1, \dots, l_k)$ defined by

$$m(l_1, \dots, l_k) = (-1)^k L_{\otimes}^T A_{\otimes}^{-l_k} N_{\otimes} \dots A_{\otimes}^{-l_2} N_{\otimes} A_{\otimes}^{-l_1} B_{\otimes}, \quad l_1, \dots, l_k = 1, 2, \dots \quad (38)$$

Construction of the transformation matrices

In [158], the transformation matrix V is constructed from a series of Krylov subspaces for given $q_1, \dots, q_J \in \mathbb{N}$ by the following J steps:

$$\text{range}(V^{(1)}) = K_{q_1}(A_{\otimes}^{-1}, B_{\otimes}), \quad (39)$$

and

$$\text{range}(V^{(j)}) = K_{q_j}(A_{\otimes}^{-1}, N_{\otimes} V^{(j-1)}), \quad (40)$$

for $1 < j < J$. The matrix V is defined by the union of the subspaces that are spanned by the columns of $V^{(j)}$,

$$\text{range}(V) = \bigcup_{j=1}^J \text{colspan}\{V^{(j)}\}. \quad (41)$$

Using $x_\otimes \approx Vz_\otimes$ in (34), and multiplying with V^T from the left on both sides of the first equation, the reduced-order model for the nonlinear system (29) is given by

$$\begin{aligned}\frac{dz_\otimes}{dt} &= \hat{A}_\otimes z_\otimes + \hat{N}_\otimes z_\otimes u(t) + \hat{B}_\otimes u(t), \\ \hat{y}(t) &= \hat{L}_\otimes^T z_\otimes,\end{aligned}\quad (42)$$

where $\hat{A}_\otimes = V^T A_\otimes V$, $\hat{N}_\otimes = V^T N_\otimes V$, $\hat{B}_\otimes = V^T B_\otimes$, $\hat{L}_\otimes = V^T L_\otimes$.

There are two differences between the methods in [158] and [16]. One is that the Krylov subspaces for generating V in (41) are different. In [16] the Krylov subspaces are as follows:

$$\text{range}(V^{(1)}) = K_{q_1}(A_\otimes^{-1}, A_\otimes^{-1}B_\otimes), \quad (43)$$

and for $j > 1$,

$$\text{range}(V^{(j)}) = K_{q_j}(A_\otimes^{-1}, A_\otimes^{-1}N_\otimes V^{(j-1)}). \quad (44)$$

The final transformation matrix V is

$$\text{range}(V) = \bigcup_{j=1}^J \text{colspan}\{V^{(j)}\}. \quad (45)$$

From the definition of the multimoments in (38), we see that all of the indices l_1, l_2, \dots, l_n in the multimoments start from 1, therefore the first vectors in the Krylov subspaces generating $V^{(j)}$, $j = 1, 2, \dots$, should be $A_\otimes^{-1}B_\otimes$, $A_\otimes^{-1}N_\otimes V^{(j)}$, $j = 1, 2, \dots$ respectively, rather than B_\otimes , $N_\otimes V^{(j)}$, $j = 1, 2, \dots$ as defined in (39)-(41). As a result, the definitions in (39)-(41) include the following redundant vectors,

$$B_\otimes, N_\otimes V^{(j)}, j = 1, 2, \dots,$$

which are not the multimoments of the regular kernel, and may affect the accuracy of the reduced model.

The other difference is that in [16], the reduced model of the bilinear system (34) is derived in the following more complex way: First, A_\otimes^{-1} is multiplied from the left on both sides of the equation

$$\begin{aligned}A_\otimes^{-1} \frac{dx_\otimes}{dt} &= x_\otimes + A_\otimes^{-1}N_\otimes x_\otimes u(t) + A_\otimes^{-1}B_\otimes u(t), \\ y(t) &= L_\otimes^T x_\otimes.\end{aligned}$$

Using the approximation $x_\otimes \approx Vz_\otimes$ and by some further transformations, the reduced model is obtained

$$\begin{aligned}\frac{dz_\otimes}{dt} &= \tilde{A}_\otimes z + \tilde{N}_\otimes z_\otimes u(t) + \tilde{A}_\otimes V^T A_\otimes^{-1} B_\otimes u(t), \\ y(t) &= L_\otimes^T V z_\otimes,\end{aligned}\quad (46)$$

where $\tilde{A}_\otimes = (V^T A_\otimes^{-1} V)^{-1}$, $\tilde{N}_\otimes = \tilde{A}_\otimes V^T A_\otimes^{-1} N_\otimes V$.

In [73], it is proved that if the projection matrix V is constructed with (43)-(45) rather than (39)-(41), then the reduced model in (42) can match as many multimoments as the reduced model (46). This is a combination of both methods, which provides a different way of model reduction for bilinear systems. Here, we name the third method in [73] as BICOMB. If the reduced model in (42) is obtained by BICOMB, it is not only as accurate as the reduced model in (46) but also can be obtained more efficiently than (46) (without computing the inverse of A_\otimes).

Simulation results of the proposed method BICOMB

Simulation results are missing in [73] to further aid the theoretical analysis there. We present some simulation results of the method BICOMB, and compare it with [158] as well as with [16]. We use the same input functions $u(t) = e^{-t}$ and $u(t) = (\cos(2\pi t/10) + 1)/2$ as in [16] to see if the accuracy of [158] is improved by BICOMB. We apply the same practical scheme proposed in Section 4 in [16] to construct the projection matrix V . That is, we first define q_1 for $V^{(1)}$ in (43), then we take the first p_2 columns in $V^{(1)}$ (denoted by $V^{(1)}[1 : p_2]$) to construct $V^{(2)}$ in (44). The matrix $V^{(2)}$ is actually constructed by

$$\text{range}(V^{(2)}) = K_{q_2}(A_{\otimes}^{-1}, A_{\otimes}^{-1}N_{\otimes}V^{(1)}[1 : p_2]).$$

Here we only take two matrices $V^{(1)}$ and $V^{(2)}$ for the final V in (45) as in [16]. In the end, the number of columns in $V^{(2)}$ is $q_2 \times p_2$ if there is no deflation during the orthogonalization process. We take $q_1 = 20$, $p_2 = 1$, $q_2 = 1$ for all methods.

The time-domain output responses $y(t)$ of the nonlinear circuit excited by different inputs are presented in Fig. 10 and Fig. 11. The relative errors

$$\epsilon^{re} = \|y(t) - \hat{y}(t)\|_2 / \|y(t)\|_2$$

of the outputs $\hat{y}(t)$ computed by different methods are shown in Fig. 12 and Fig. 13, where $y(t)$ is the output computed by full simulation of the original nonlinear system. From the figures we can see that BICOMB is as accurate as the method in [16] and the accuracy of the method in [158] is really improved by BICOMB. By using BICOMB instead, the complexity of the method in [16] is largely reduced. It is noticed that Neumann expansion around zero is used to get the series expansion (37) of the k th transfer function in (36). It is possible to use nonzero expansion as well. It is shown in [54] that a reduced model with better accuracy can be derived with the nonzero multi-expansion points $\sigma_1, \dots, \sigma_q$ for the Neumann expansion of $H_k^{(reg)}$.

Common issues for multimoment-matching methods

All the three methods above need to construct a transformation matrix V . The transformation matrix V depends on the multimoments included in (39)-(41) or in (43)-(45). The accuracy of the reduced system depends on the number of multimoments included in V . However, different choices of q_1, p_2, q_2, \dots influence the accuracy of the reduced-order system as can be seen in Fig. 14- Fig. 17. The order of all reduced models is $q_1 + p_2 \times q_2 = 21$. The results in Fig. 14 and in Fig. 15 are obtained from BICOMB, and the results in Fig. 16 and in Fig. 17 are produced by the method in [16]. The accuracy of both methods depends on the proper choice of q_1, p_2, q_2 . However, we can observe the following principles in Fig. 14- Fig. 17. If we choose q_1 large enough (here 17) then the accuracy of the reduced-order system is not improved significantly by a further increase of q_1 (20). On the contrary, if q_1 is too small (here 5) then the error will be large. Thus, matching sufficiently many multimoments of first degree is important for the accuracy of the reduced model.

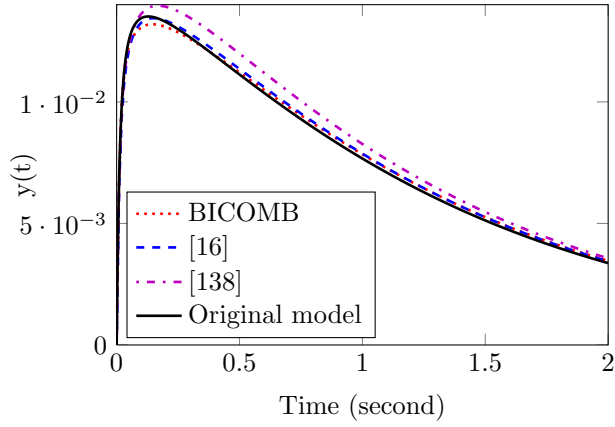

Fig. 10 Output responses by input $u(t) = e^{-t}$

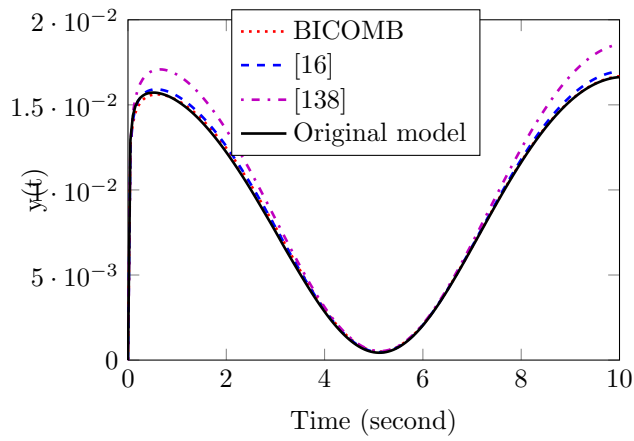

Fig. 11 Output responses by input $u(t) = (\cos(2\pi t/10) + 1)/2$

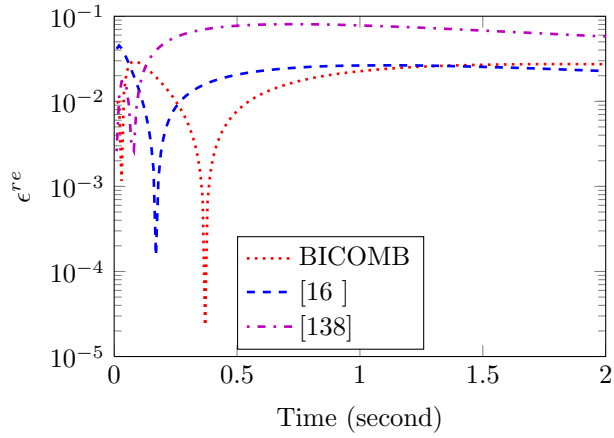

Fig. 12 Relative errors for input $u(t) = e^{-t}$

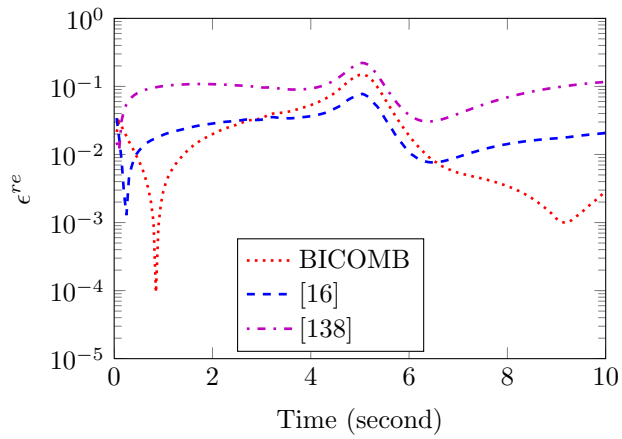

Fig. 13 Relative errors for input $u(t) = (\cos(2\pi t/10) + 1)/2$

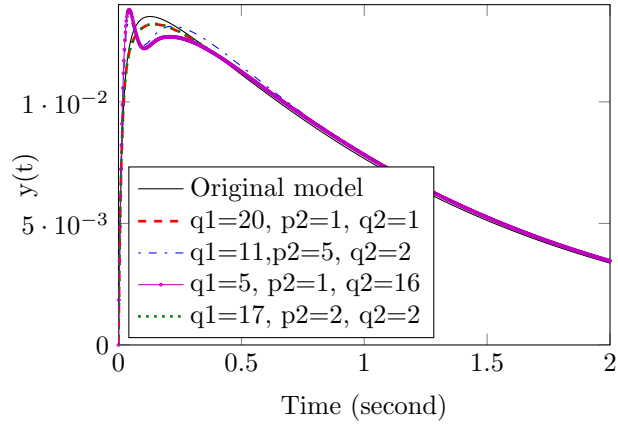

Fig. 14 Output response by input $u(t) = e^{-t}$ for BICOMB

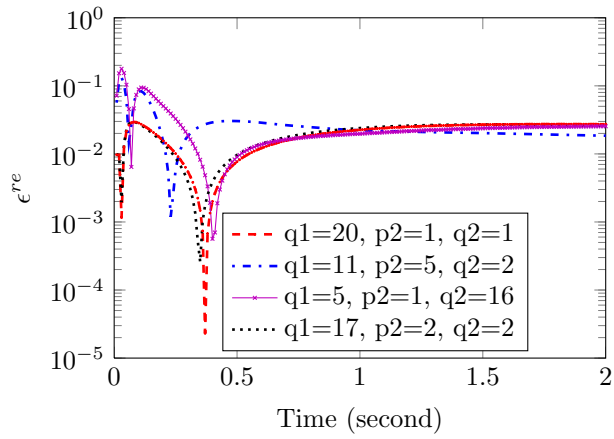

Fig. 15 Output response by input $u(t) = e^{-t}$ for BICOMB

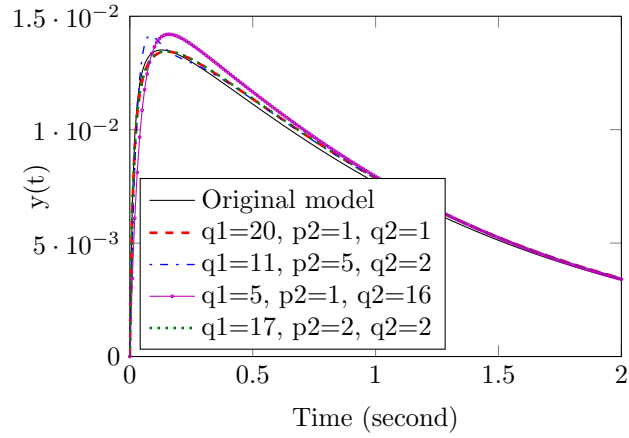

Fig. 16 Output response by input $u(t) = e^{-t}$ for [16]

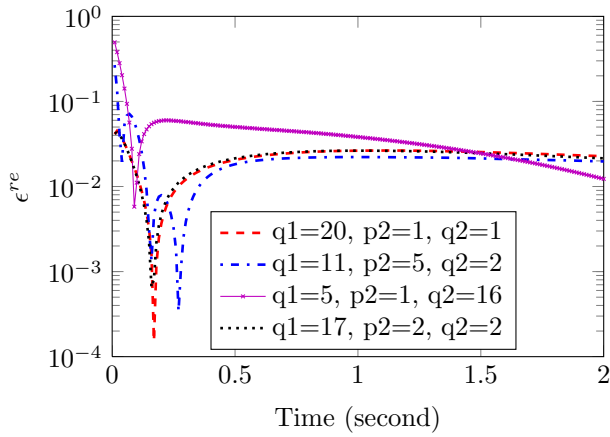

Fig. 17 Output response by input $u(t) = e^{-t}$ for [16]

Balanced truncation for bilinear systems

Another possibility of reducing bilinear systems is the BT bilinear MOR method which was proposed first in [2] and reviewed and further developed in [60] and [35]. The idea is similar to the standard BT method for linear state space systems as presented in Section 2.1. To get the reduced model, the two Gramians P and Q need to be computed from the generalized Lyapunov equations for the bilinear system in (34):

$$\begin{aligned} A_{\otimes}P + PA_{\otimes}^T + N_{\otimes}PN_{\otimes}^T &= -B_{\otimes}B_{\otimes}^T, \\ A_{\otimes}^TQ + QA_{\otimes} + N_{\otimes}^TQN_{\otimes} &= -L_{\otimes}L_{\otimes}^T. \end{aligned} \quad (47)$$

Analogously to the linear system, a transformation matrix $T = V_P\Lambda_P V_Q\Lambda_Q^{-1/2}$ can be computed from the spectral decomposition of the Gramian P and of the projected Gramian $(V_P\Lambda_P)^TQ(V_P\Lambda_P)$:

$$\begin{aligned} V_P^T P V_P &= \Lambda_P^2, \\ V_Q^T [(V_P\Lambda_P)^T Q (V_P\Lambda_P)] V_Q &= \Lambda_Q^2. \end{aligned} \quad (48)$$

The balanced bilinear system is

$$\begin{aligned} \frac{dx_{\otimes}}{dt} &= T^{-1}A_{\otimes}Tx_{\otimes} + T^{-1}N_{\otimes}Tx_{\otimes}u(t) + T^{-1}B_{\otimes}u(t), \\ y(t) &= L_{\otimes}^T Tx_{\otimes}. \end{aligned} \quad (49)$$

The Gramians of the balanced bilinear system become equal and diagonal. Recalling the linear case, the reduced model can be obtained likewise, by truncating the part in the system matrices in (49) corresponding to small values on the diagonal of the Gramian.

Although it is shown in [35], that the BT bilinear MOR method often outperforms the multimoment-matching method, it is obvious that two generalized Lyapunov equations must be solved, which is computationally complicated. Fast numerical methods need to be developed for large-scale systems. The error bound for the reduced model remains unknown for this approach.

Interpolation-based \mathcal{H}_2 -model reduction for bilinear systems

The definition of the \mathcal{H}_2 -norm was extended to bilinear systems in [203]. An alternative computation of this norm was proposed and used to derive first order necessary conditions for \mathcal{H}_2 -optimality of the reduced model in [28]. Furthermore, it is shown that if the reduced model is \mathcal{H}_2 -optimal, then the Volterra series of the reduced bilinear system interpolates the Volterra series of the original system in the frequency domain. See [82] for more discussions about interpolation properties of the reduced bilinear system.

Two algorithms were presented in [28] which compute reduced-order systems that locally minimize the \mathcal{H}_2 -error. The first algorithm computes the matrices W and V from the solutions X and Y of two generalized Sylvester equations:

$$\begin{aligned} A_{\otimes}X + X\hat{A}_{\otimes}^T + N_{\otimes}X\hat{N}_{\otimes}^T &= -B_{\otimes}\hat{B}_{\otimes}^T, \\ A_{\otimes}^TY + Y\hat{A}_{\otimes} + N_{\otimes}^TY\hat{N}_{\otimes} &= -L_{\otimes}\hat{L}_{\otimes}^T, \end{aligned}$$

where $\hat{A}_\otimes = W^T A_\otimes V$, $\hat{N}_\otimes = W^T N_\otimes V$, $\hat{B}_\otimes = W^T B_\otimes$, $\hat{L}_\otimes^T = L_\otimes^T V$. Here $W^T = (U^T V)^{-1} U^T$. The columns in U and V are orthogonalizations of Y and X , respectively. The reduced model obtained after convergence (consisting of $\hat{A}_\otimes, \hat{N}_\otimes, \hat{B}_\otimes, \hat{L}_\otimes$) satisfies the \mathcal{H}_2 -optimal necessary conditions. This is also the case for the solution computed by the second algorithm in [28], which is called BIRKA. BIRKA is a generalization of the iterative rational Krylov algorithm and is shown to compute more accurate reduced-order systems w.r.t. the relative \mathcal{H}_2 -norm than BT by several numerical examples.

3.3 Variational analysis method

The third kind of nonlinear MOR methods [30, 77, 103, 104, 132, 159] originates from the variational analysis in nonlinear systems theory [170]. In [77, 132, 159], the original nonlinear system is firstly approximated by a polynomial system, then the variational analysis is applied to the polynomial system to get a reduced polynomial system. In [30, 103, 104], an exact quadratic-bilinear transform of the nonlinear system is proposed, such that the nonlinear system can be represented by a quadratic-bilinear system without loss of accuracy, but at the sacrifice of increased state variables. The variational analysis is finally applied to the quadratic-bilinear system to obtain a quadratic-bilinear reduced model.

Methods using polynomial approximation

In the following, we describe the method developed in [77]. The main difference of the method in [159] from the method in [77] is the construction of the projection matrices V_2 and V_3 , and will be explained later.

With the Taylor expansion of $f(x(t))$ in (31), the original nonlinear system (29) is first approximated by a second order polynomial system

$$\begin{aligned} \frac{dx(t)}{dt} &= A_1 x(t) + A_2(x(t) \otimes x(t)) + Bu(t), \\ y(t) &= L^T x(t), \end{aligned} \quad (50)$$

or by a third order polynomial system

$$\begin{aligned} \frac{dx(t)}{dt} &= A_1 x(t) + A_2(x(t) \otimes x(t)) + A_3(x(t) \otimes x(t) \otimes x(t)) + Bu(t), \\ y(t) &= L^T x(t). \end{aligned} \quad (51)$$

It is shown that the original nonlinear system (29) is equivalent to a group of linear systems. Thus, the transformation matrix V can be computed from the linear systems.

Consider the response of (29) to the special input $\alpha u(t)$,

$$\begin{aligned} \frac{dx(t)}{dt} &= f(x(t)) + B(\alpha u(t)), \\ y(t) &= L^T x(t), \end{aligned} \quad (52)$$

where α is an arbitrarily small number. Assuming that the response to $u(t) = 0$ is $x(t) = 0$ (in [170], it is called forced response), then $x(t)$ can be expanded into a power series in α ,

$$x(t) = \alpha x_1(t) + \alpha^2 x_2(t) + \alpha^3 x_3(t) + \dots \quad (53)$$

Substituting both (53) and (31) into the right hand side and (53) into the left hand side of (52), we get

$$\alpha \frac{dx_1(t)}{dt} + \alpha^2 \frac{dx_2(t)}{dt} + \alpha^3 \frac{dx_3(t)}{dt} + \dots = \alpha A_1 x_1(t) + \alpha^2 [A_1 x_2(t) + A_2(x_1(t) \otimes x_1(t))] + \dots + B(\alpha u(t)).$$

Since this equation holds for all α , coefficients of powers of α can be equated. This gives the variational equations:

$$\frac{dx_1(t)}{dt} = A_1 x_1(t) + Bu(t), \quad (54)$$

$$\frac{dx_2(t)}{dt} = A_1 x_2(t) + A_2(x_1(t) \otimes x_1(t)), \quad (55)$$

$$\begin{aligned} \frac{dx_3(t)}{dt} = & A_1 x_3(t) + A_2(x_1(t) \otimes x_2(t) + x_2(t) \otimes x_1(t)) \\ & + A_3(x_1(t) \otimes x_1(t) \otimes x_1(t)), \dots \end{aligned} \quad (56)$$

It is worth pointing out that the assumptions on the forced response can be relaxed, and similar variational equations on $x_\delta = x(t) - \hat{x}(t)$ can be derived. Here $\hat{x}(t)$ is the response of a certain input $\hat{u}(t)$ for a fixed initial state $x(0) = x_0$. For detailed discussion, see Section 3.4 in [170].

Construction of the transformation matrix

We notice that all of these variational equations are linear systems of order n for the vectors of unknowns $x_1(t)$, $x_2(t)$, \dots , respectively. Since $x(t)$ is a linear combination of $x_1(t)$, $x_2(t)$, \dots (see (53)), they stay in the same subspace. The transformation matrix V can be computed from the subspace containing $x_1(t)$, $x_2(t)$, \dots .

Based on this observation, the method in [77] constructs V based on the linear variational equations (54)-(56) rather than from the nonlinear system. From the moment-matching MOR for linear systems, a transformation matrix V_1 for $x_1(t)$ in the first linear system (54) is constructed as

$$\text{range}(V_1) = \text{span}\{A_1^{-1}B, A_1^{-2}B, \dots, A_1^{-q_1}B\}.$$

Then, $x_1(t)$ can be approximated by $x_1(t) \approx V_1 z_1(t)$. The transformation matrix V_2 for $x_2(t)$ in the second linear system (55) is similarly constructed by

$$\text{range}(V_2) = \text{span}\{A_1^{-1}A_2, A_1^{-2}A_2, \dots, A_1^{-q_2}A_2\}, \quad (57)$$

such that $x_2(t) \approx V_2 z_2(t)$. The transformation matrix V_3 for $x_3(t)$ in (56) can be derived in a similar way [168]. From (53), we have

$$x(t) \approx \alpha V_1 z_1(t) + \alpha^2 V_2 z_2(t) + \alpha^3 V_3 z_3(t),$$

which indicates that the solution $x(t)$ of (51) can be approximated by the linear combination of the column vectors in V_1 , V_2 and V_3 . Therefore the final transformation matrix V can be computed by

$$\text{range}(V) = \text{colspan}\{V_1, V_2, V_3\}. \quad (58)$$

The reduced model is thus derived from the polynomial system (51) and by approximation $x(t) \approx Vz(t)$,

$$\begin{aligned} \frac{dz(t)}{dt} &= V^T A_1 Vz(t) + V^T A_2 (Vz(t) \otimes Vz(t)) + \\ &\quad V^T A_3 (Vz(t) \otimes Vz(t) \otimes Vz(t)) + V^T Bu(t), \\ y(t) &= L^T Vz(t). \end{aligned}$$

The approach can be applied analogously to (50). The advantage of this method is that it has the flexibility to use a more accurate polynomial system (51) to approximate the original nonlinear system. Furthermore, given a fixed polynomial system, the transformation matrix V can be constructed by using more than the three linear systems in (54)-(56), which may produce a more accurate model.

It is possible that for the quadratic method, the system (32) can also be replaced by a more accurate polynomial system. However, the transformation matrix V computed by the quadratic method is much less accurate than the matrix V in (58), because it is computed only by the linear part of the nonlinear system.

For approximation of the original nonlinear system (29), the bilinear system is less accurate than the polynomial system (51). Moreover, since the bilinear system is derived by approximating the nonlinear function $f(x)$ by its Taylor expansion up to the second order, the transformation matrix V only uses the information of the Taylor expansion of $f(x)$ at most to the second order, which is less accurate than the matrix V computed by the variational analysis method.

One of the problems of the variational analysis method is that the number of the vectors in the subspace for constructing V_2 or V_3 is very large. It is impossible to include all of them to compute V_2 or V_3 . Therefore, the question is which vectors should be used to construct V_1 , V_2 , V_3 ?

In [159], the second projection matrix \tilde{V}_2 is constructed from the approximate system by replacing x_1 with $V_1 z_1$ in (55),

$$\frac{dx_2(t)}{dt} = A_1 x_2(t) + A_2 (V_1 z_1(t) \otimes V_1 z_1(t)), \quad (59)$$

as basis of

$$\text{range}(\tilde{V}_2) = \text{span}\{A_1^{-1} A_2 (V_1 \otimes V_1), A_1^{-2} A_2 (V_1 \otimes V_1), \dots, A_1^{-q_2} A_2 (V_1 \otimes V_1)\}. \quad (60)$$

The advantage of this approach is that there are much less columns in $A_2 (V_1 \otimes V_1)$ than in A_2 in (57). Thus, \tilde{V}_2 matches more moments than V_2 in (57) if the matrices have the same number of columns. However, \tilde{V}_2 only matches approximate moments because the input matrix A_2 in (55) is approximated by $A_2 (V_1 \otimes V_1)$ in (60). Therefore, although

\tilde{V}_2 matches more moments, its accuracy is weakened by the approximate moments. In **Fig. 18** and **Fig. 19** the accuracy of the two methods is compared.

By computing reduced models of the same order $r = 9$, the method in [77] is slightly more accurate than the method in [159].

At the end of this subsection, we would like to mention another method [132] which is based on both, Volterra series expansion of the output response and variational analysis. Here, the original system (29) is approximated by the polynomial system in (51) rather than by a bilinear system. Then, the Volterra series representation of the output response of the polynomial system is employed to introduce the nonlinear transfer functions of (51). The k th order nonlinear transfer function is similar to the k th transfer function $H_k^{(reg)}(s_1, s_2, \dots, s_k)$ for the bilinear system. The transformation matrix V is constructed based on the moments of the nonlinear transfer functions. Instead of doing Laplace transform of the Volterra kernels as in (36), the nonlinear transfer functions are computed from the variational linear systems (54) - (56), whose transfer functions are equivalent with the first order, second order and third order nonlinear transfer functions, respectively. The basic idea of [132] is quite similar to the methods in [16] and [158]. The main difference is that [16] and [158] are based on the bilinear approximation of the original nonlinear system, whereas [132] is based on a more accurate approximation (51).

Methods based on quadratic-bilinearization

The previously described nonlinear MOR methods approximate firstly the nonlinear function $f(\cdot)$ by a polynomial and reduce the approximate polynomial system afterward. When the function $f(\cdot)$ is weakly nonlinear, approximations by a polynomial of degree two (32), (34), (50) or by a polynomial of degree three (51) are sufficiently well. However, if $f(\cdot)$ is strongly nonlinear, the low-degree polynomial approximations are insufficient. An approximation by higher degree polynomials is much more complex. Furthermore, it is much more difficult to compute its corresponding reduced-order form and the storage requirements are prohibitive even if the original state space dimension is moderate.

The methods based on quadratic-bilinearization provide a solution for the above problems caused by polynomial approximation. Instead of approximating the nonlinear part $f(x)$ by a polynomial function, some equivalent transformations are applied to the nonlinear system in (29). The nonlinear system is firstly transformed into a polynomial system by adding polynomial algebraic equations or by taking Lie derivatives and adding more differential equations. The polynomial system is then transformed into a quadratic-bilinear system by either adding quadratic algebraic equations or taking Lie derivatives again. The detailed explanation can be found in [103, 104].

The equivalent quadratic-bilinear system is as below

$$\tilde{x} = G_1\tilde{x} + G_2(\tilde{x} \otimes \tilde{x}) + D_1\tilde{x}u + D_2(\tilde{x} \otimes \tilde{x})u + \tilde{B}u(t), \quad (61)$$

where \tilde{x} is the expanded state vector, which includes the state vector x for the original nonlinear system. It is noticed that in [103, 104], the system (61) is called quadratic-linear differential algebraic equation (QLDAE). However, the system above obviously

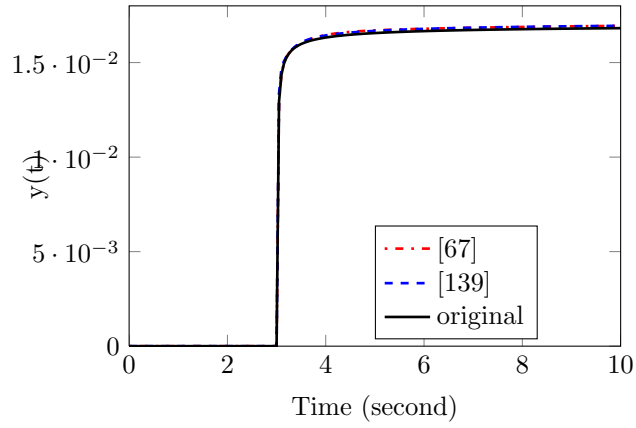

Fig. 18 Output response by input $u(t) = 0$ for $t < 3$, $u(t) = 1$ for $t \geq 3$

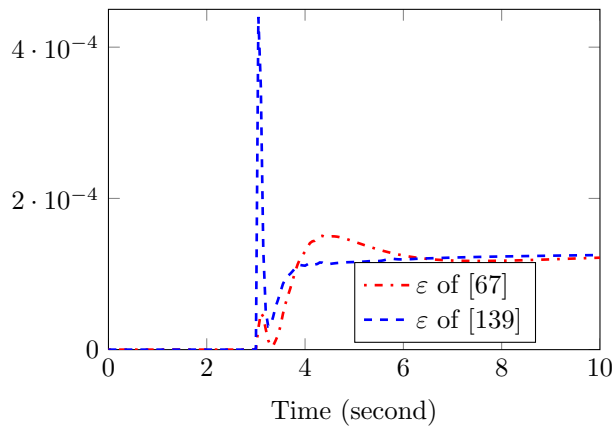

Fig. 19 Output error $\varepsilon = \|y(t) - \hat{y}(t)\|_2$ by input $u(t) = 0$ for $t < 3$, $u(t) = 1$ for $t \geq 3$

includes the bilinear term $D_1 \tilde{x}u$ and the quadratic-bilinear term $D_2(\tilde{x} \otimes \tilde{x})u$. Therefore, the notion quadratic-bilinear differential algebraic equations (QBDAEs) as introduced in [30] is used in this paper.

Once the QBDAEs are derived after several steps of transformations, the variational analysis (52)-(56) in the previous subsection can be applied to the QBDAEs. The transformation matrix V can also be computed likewise. Then, Galerkin projection can be applied to (61) to get the reduced QBDAEs, which are considered as reduced model for the original nonlinear system in (29).

It is discussed above that starting from the second variational equation (55), the input matrix has many vectors, which make the computation of the transformation matrix V_2 tricky. In [103, 104], a different way of computing the transformation matrix V for the reduced model is proposed based on the transfer functions of the QBDAEs (61). The expression of the transfer functions of the QBDAEs can be originally found in [170]. For example, the first two transfer functions are

$$\begin{aligned} H_1(s) &= L^T(sI - G_1)^{-1}B, \\ H_2(s_1, s_2) &= \frac{1}{2!}L^T[(s_1 + s_2)I - G_1]^{-1} \times \\ &\quad \{G_2[H_1(s_1) \otimes H_1(s_2) + H_1(s_2) \otimes H_1(s_1)] + \\ &\quad D_1[H_1(s_1) + H_2(s_2)]\}. \end{aligned} \quad (62)$$

Using Taylor expansions of the transfer functions, the matrix V can be recursively computed from the coefficients of the series expansions. The Taylor expansions of H_1 and H_2 at zero expansion point (nonzero expansion is straight forward) are given as

$$\begin{aligned} H_1(s) &= L^T \sum_{k=0}^{\infty} A^k R_1 s^k, \\ H_2(s_1, s_2) &= \frac{1}{2!}L^T \sum_{i=0}^k A^{k+1}(s_1 + s_2)^k \\ &\quad \{G_2[(\sum_{k=0}^{\infty} A^k R_1 s_1^k) \otimes (\sum_{k=0}^{\infty} A^k R_1 s_2^k) + \\ &\quad (\sum_{k=0}^{\infty} A^k R_1 s_2^k) \otimes (\sum_{k=0}^{\infty} A^k R_1 s_1^k)] + \\ &\quad D_1[\sum_{k=0}^{\infty} A^k R_1 s_1^k + \sum_{k=0}^{\infty} A^k R_1 s_2^k]\}, \end{aligned} \quad (63)$$

where $A = G_1^{-1}$, $R_1 = -G_1^{-1}B$. In [103, 104], the transformation matrix V is constructed as

$$\begin{aligned} \text{range}(V_1) &= \text{span}\{A^i R_1, i \leq q\}, \\ \text{range}(V_2) &= \text{span}\{A^{i+1} D_1 A^j R_1, i + j \leq q\}, \\ \text{range}(V_3) &= \text{span}\{A^{i+1} G_2(A^j R_1) \otimes (A^k R_1), i + j + k \leq q, k \leq j\}, \\ \text{range}(V) &= \text{span}\{V_1, V_2, V_3\} \end{aligned} \quad (64)$$

It can be seen that if the system matrix B is a vector, the Kronecker product $(A^j R_1) \otimes (A^k R_1)$ is also a vector so that the construction of V_3 is easy. In general, if B has m columns, $(A^j R_1) \otimes (A^k R_1)$ has m^2 columns. The number of columns in $(A^j R_1) \otimes$

$(A^k R_1)$ is still moderate if m is small. This is an advantage over the way of computing V through variational analysis.

In [30], the method is extended to two-sided projection based on the transfer functions (62) of the QBDAEs. It is proved that by using two-sided projection, the reduced transfer function matches almost double the moments of the original transfer functions which are matched by the one-sided projection used in [103, 104]. Simulation results also show better accuracy than the one-sided projection. However, the two-sided projection sometimes causes numerical instability, which may produce unstable reduced models [30].

Note that the subspace dimension in (64) will grow exponentially if the coefficients of the series expansion of the higher order transfer functions, e.g. $H_3(s_1, s_2, s_3)$, are also included to compute the transformation matrix V . This easily leads to a reduced model with no reduced number of equations. In [204], the higher order multivariate transfer functions $H_2(s_1, s_2)$, $H_3(s_1, s_2, s_3), \dots$, are transformed to single- s transfer functions $H_2(s)$, $H_3(s), \dots$ by association of variables without losing accuracy. The series expansion of $H_2(s)$ or $H_3(s)$ only depends on the single variable s , such that the exponential growth of the subspace dimension can be avoided. Compared with the method in [104], a more compact reduced model with the same accuracy can be obtained. The theory on association of variables can be found in [170].

Recall that if the original nonlinear system is a system of ODEs, the QBDAEs usually are a system of differential algebraic equations after quadratic-bilinearization. It is not clear how to determine the index of the QBDAEs which may cause problem when solving the reduced model.

3.4 Trajectory piecewise-linear method

Another approach to circumvent the difficulties of polynomial approximation is piecewise approximation. The trajectory piecewise-linear method proposed in [165] is more robust than the polynomial approximation methods when dealing with strongly nonlinear systems. In [166], an error bound for this method is given, and stability and passivity preservation properties are discussed. The trajectory piecewise-linear method first linearizes the nonlinear function $f(\cdot)$ at a number of linearization points x_i , $i = 0, 1, \dots, k$, where x_0 is the initial value for the nonlinear system (29). Then $f(\cdot)$ is approximated by the weighted summation of these linearizations $f(x(t)) \approx \sum_{i=0}^k \tilde{w}_i(x(t))(f(x_i) + A_i(x(t) - x_i))$. Here, A_i is the Jacobian matrix of $f(\cdot)$ at x_i and $\tilde{w}_i(x(t))$ are the weights for $i = 0, 1, \dots, k$. Finally, the original nonlinear system can be approximated by the weighted combination of linear systems,

$$\begin{aligned} \frac{dx(t)}{dt} &= \sum_{i=0}^k \tilde{w}_i(x(t))f(x_i) + \sum_{i=0}^k \tilde{w}_i(x(t))A_i(x(t) - x_i) + Bu(t), \\ y(t) &= L^T x(t). \end{aligned} \quad (65)$$

A transformation matrix V is computed as orthonormal basis of the subspace spanned by x_0 and the Krylov subspace below

$$\text{range}\{v_1, \dots, v_{r-1}\} = \text{span}\{A_0^{-1}B, \dots, A_0^{-(r-1)}B\}.$$

The reduced model is obtained from the piecewise-linear system (65) using the approximation $x(t) \approx Vz(t)$,

$$\begin{aligned}\frac{dz(t)}{dt} &= \left(\sum_{i=0}^k V^T A_i V w_i(z(t)) \right) z(t) + \sum_{i=0}^k V^T (f(x_i) - A_i x_i) w_i(z(t)) + V^T B u(t), \\ y(t) &= L^T V z(t).\end{aligned}$$

Here, w_i , $i = 0, 1, \dots, k$, denote weights depending on z which can be computed according to the distances between the projected linearization points $V^T x_i$ and the current state vector z of the reduced model.

The linearization points are chosen by selecting a training input $u(t)$ and an initial state x_0

for the nonlinear system and simulating the full nonlinear system piece by piece. The procedure is briefly as follows: 1) A linearized model around state x_i (initially $i = 0$) is generated; 2) The linearized model is simulated while $\|x - x_i\| < \delta$, i.e., while the current state $x(t)$ is close enough to the last linearization point; 3) Once $\|x - x_i\| \geq \delta$, a new linearization point x_{i+1} is taken. Then, it will be returned to step 1). Note that in order to get the trajectory, the full system has to be simulated. Instead of simulating the full system, a fast algorithm for computing an approximate trajectory is also proposed in the paper.

The weak point of this method is that a training input has to be chosen to get a trajectory of the unknown vector $x(t)$. There still exist problems on how to choose the optimal training inputs so that the trajectory can represent the behavior of the state vector $x(t)$. If the training inputs are chosen far away from the actual inputs, then the computed trajectory will depart from the actual behavior of the state vector $x(t)$ and the reduced model will lose accuracy.

The computation of the weight functions \tilde{w}_i in the above linear system is also more or less heuristic. Instead of using the linear approximation for each piece, polynomial approximation can be used piece wisely [63]. More related papers based on similar ideas of piecewise linearization are [51, 64, 193, 186]. The generation of stable piecewise-linear reduced models is discussed in [52]. A more detailed review on piecewise linearization MOR methods can be found in [112].

Finally, hot topics remain open for nonlinear MOR methods. They are summarized below:

1. One common problem for nonlinear MOR methods based on system-theoretic approaches is that there is not a practical error bound for the reduced model.
2. The problem of choosing optimal expansion points (interpolation points), solved for linear systems in [106] and extended to bilinear systems in [28, 82] still remains in multimoment-matching in quadratic-bilinearization methods.
3. What is a proper choice of the number of multimoments for the multimoment-matching bilinearization methods? Even for linear systems, there is no optimal algorithm working satisfactory in all situations.

4. Still, fast numerical algorithms for solving large-scale generalized Lyapunov and generalized Sylvester equations as they arise in BT bilinear and in \mathcal{H}_2 -MOR have to be developed.
5. The index of the QBDAE representation of a smooth nonlinear system is not known in general. Furthermore, it is unclear how the index is influenced by reducing the system. Is the reduced-order system stable?
6. A good selection of training inputs and linearization points for the trajectory piecewise linear method is not known a priori.

4 Conclusions

In this survey, MOR methods for linear and nonlinear systems are reviewed. We have focused here on methods with system-theoretic background. They mostly employ the transfer function of the original LTI system or generalizations thereof in the nonlinear case. As transfer functions are scalar or matrix-valued rational functions of a complex variable, these MOR methods can also be understood as rational approximation. In contrast to POD and RB methods, they do not rely on snapshots and are independent of the chosen input function, i.e., they need no training sets.

We have discussed similarities and differences among various methods. Some numerical comparisons show the advantages and drawbacks of these approaches. A few new points of view are proposed for both linear and nonlinear MOR. We have also highlighted the remarkable progress made for MOR applied to linear systems throughout the last few years, though various issues remain and further advances in the numerical algorithms are welcome. A number of open problems for linear and in particular nonlinear systems are pointed out. Some of them are current work in progress, some might need further attention in the future.

Acknowledgments

We would like to thank Tobias Breiten, Heiko Panzer and Thomas Wolf for reading a draft version of this manuscript and providing various suggestions for improvement.

References

- [1] Achar, R., Nakhla, M.: Simulation of high-speed interconnects. *Proceedings of the IEEE* **89**(5), 693–728 (2001)
- [2] Al-Baiyat, S., Bettayeb, M.: A new model reduction scheme for k-power bilinear systems. In: *Proceedings of the 32nd IEEE Conference on Decision and Control*, 1993., vol. 1, pp. 22–27 (1993). DOI 10.1109/CDC.1993.325196
- [3] Aldhaheri, R.: Model order reduction via real Schur-form decomposition. *Internat. J. Control* **53**(3), 709–716 (1991)

- [4] Anderson, B., Antoulas, A.: Rational interpolation and state-variable realizations. *Linear Algebra Appl.* **137/138**, 479–509 (1990)
- [5] Antoulas, A.: *Approximation of Large-Scale Dynamical Systems*. SIAM Publications, Philadelphia, PA (2005)
- [6] Antoulas, A., Sorensen, D., Gugercin, S.: A survey of model reduction methods for large-scale systems. *Contemp. Math.* **280**, 193–219 (2001)
- [7] Antoulas, A., Sorensen, D., Zhou, Y.: On the decay rate of Hankel singular values and related issues. *Sys. Control Lett.* **46**(5), 323–342 (2002)
- [8] Astrid, P., Weiland, S., Willcox, K., Backx, T.: Missing point estimation in models described by proper orthogonal decomposition. *IEEE Trans. Automat. Control* **53**(10), 2237–2251 (2008)
- [9] Badía, J., Benner, P., Mayo, R., Quintana-Ortí, E.: Solving large sparse Lyapunov equations on parallel computers. In: B. Monien, R. Feldmann (eds.) *Euro-Par 2002 – Parallel Processing*, no. 2400 in *Lecture Notes in Computer Science*, pp. 687–690. Springer-Verlag, Berlin, Heidelberg, New York (2002)
- [10] Badía, J., Benner, P., Mayo, R., Quintana-Ortí, E., Quintana-Ortí, G., Remón, A.: Balanced truncation model reduction of large and sparse generalized linear systems. *Tech. Rep. Chemnitz Scientific Computing Preprints 06-04*, Fakultät für Mathematik, TU Chemnitz (2006)
- [11] Bai, Z.: Krylov subspace techniques for reduced-order modeling of large-scale dynamical systems. *Appl. Numer. Math* **43**(1–2), 9–44 (2002)
- [12] Bai, Z., Dewilde, P., Freund, R.: Reduced-order modeling. In: *Handbook of numerical analysis*. Vol. XIII, *Handb. Numer. Anal.*, XIII, pp. 825–891. North-Holland, Amsterdam (2005)
- [13] Bai, Z., Feldmann, P., Freund, R.: How to make theoretically passive reduced-order models passive in practice. In: *Proceedings of the IEEE 1998 Custom Integrated Circuits Conference*, pp. 207–210. IEEE (1998). URL citeseer.ist.psu.edu/article/bai98how.html
- [14] Bai, Z., Freund, R.: A partial Padé-via-Lanczos method for reduced-order modeling. In: *Proceedings of the Eighth Conference of the International Linear Algebra Society (Barcelona, 1999)*, vol. 332/334, pp. 139–164 (2001)
- [15] Bai, Z., Freund, R.: A symmetric band Lanczos process based on coupled recurrences and some applications. *SIAM J. Sci. Comput.* **23**(2), 542–562 (electronic) (2001)
- [16] Bai, Z., Skoogh, D.: A projection method for model reduction of bilinear dynamical systems. *Linear Algebra Appl.* **415**(2–3), 406–425 (2006)

- [17] Bai, Z., Slone, R., Smith, W., Ye, Q.: Error bound for reduced system model by Padé approximation via the Lanczos process. *IEEE Trans. Comput.-Aided Des. Integr. Circuits Syst.* **18**(2), 133–141 (1999)
- [18] Bai, Z., Su, Y.F.: Dimension reduction of large-scale second-order dynamical systems via a second-order Arnoldi method. *SIAM J. Sci. Comput.* **26**(5), 1692–1709 (2005)
- [19] Baker, G.: *Essentials of Padé approximation*. Academic Press (1975)
- [20] Barrachina, S., Benner, P., Quintana-Ortí, E., Quintana-Ortí, G.: Parallel algorithms for balanced truncation of large-scale unstable systems. In: *Proc. 44th IEEE Conf. Decis. Control ECC 2005*, pp. 2248–2253 (2005)
- [21] Barrault, M., Maday, Y., Nguyen, N.C., Patera, A.T.: An ‘empirical interpolation’ method: application to efficient reduced-basis discretization of partial differential equations. *C. R. Acad. Sci. Paris, Ser. I* **339**, 667–672 (2004)
- [22] Baur, U., Benner, P.: Factorized solution of Lyapunov equations based on hierarchical matrix arithmetic. *Computing* **78**(3), 211–234 (2006)
- [23] Baur, U., Benner, P.: Cross-gramian based model reduction for data-sparse systems. *Electronic Transactions on Numerical Analysis (ETNA)* **31**, 256–270 (2008)
- [24] Baur, U., Benner, P.: Gramian-based model reduction for data-sparse systems. *SIAM J. Sci. Comput.* **31**(1), 776–798 (2008)
- [25] Bechtold, T., Rudnyi, E.B., Korvink, J.G.: Error indicators for fully automatic extraction of heat-transfer macromodels for MEMS. *Journal of Micromechanics and Microengineering* **15**(3), 430–440 (2005)
- [26] Benner, P.: Solving large-scale control problems. *IEEE Control Systems Magazine* **14**(1), 44–59 (2004)
- [27] Benner, P.: Advances in balancing-related model reduction for circuit simulation. In: J. Roos, L. Costa (eds.) *Scientific Computing in Electrical Engineering SCEE 2008, Mathematics in Industry*, vol. 14, pp. 469–482. Springer-Verlag, Berlin/Heidelberg (2010)
- [28] Benner, P., Breiten, T.: Interpolation-based h_2 -model reduction of bilinear control systems. *SIAM J. Matrix Anal. Appl.* **33**(3), 859–885 (2012)
- [29] Benner, P., Breiten, T.: Krylov-subspace based model reduction of nonlinear circuit models using bilinear and quadratic-linear approximations. In: M. Günther, A. Bartel, M. Brunk, S. Schöps, M. Striebel (eds.) *Progress in Industrial Mathematics at ECMI 2010, Mathematics in Industry*, vol. 17, pp. 153–159. Springer-Verlag, Berlin (2012)

- [30] Benner, P., Breiten, T.: Two-sided moment matching methods for nonlinear model reduction. Preprint MPIMD/12-12, Max Planck Institute Magdeburg Preprints (2012). Available from <http://www.mpi-magdeburg.mpg.de/preprints/>
- [31] Benner, P., Breiten, T.: Low rank methods for a class of generalized Lyapunov equations and related issues. *Numerische Mathematik* **124**(3), 441–470 (2013)
- [32] Benner, P., Breiten, T.: On optimality of approximate low rank solutions of large-scale matrix equations. *Sys. Control Lett.* **to appear** (2013)
- [33] Benner, P., Castillo, M., Quintana-Ortí, E., Quintana-Ortí, G.: Parallel model reduction of large-scale unstable systems. In: G. Joubert, W. Nagel, F. Peters, W. Walter (eds.) *Parallel Computing: Software Technology, Algorithms, Architectures & Applications. Proc. Intl. Conf. ParCo2003, Dresden, Germany, Advances in Parallel Computing*, vol. 13, pp. 251–258. Elsevier B.V. (North-Holland) (2004)
- [34] Benner, P., Claver, J., Quintana-Ortí, E.: Efficient solution of coupled Lyapunov equations via matrix sign function iteration. In: A.D. et al. (ed.) *Proc. 3rd Portuguese Conf. on Automatic Control CONTROLO'98, Coimbra*, pp. 205–210 (1998)
- [35] Benner, P., Damm, T.: Lyapunov equations, energy functionals, and model order reduction of bilinear and stochastic systems. *SIAM J. Cont. Optim.* **49**(2), 686–711 (2011)
- [36] Benner, P., Ezzatti, P., Kressner, D., Quintana-Ortí, E., Remón, A.: A mixed-precision algorithm for the solution of Lyapunov equations on hybrid CPUGPU platforms. *Parallel Computing* **37**(8), 439–450 (2011). DOI <http://dx.doi.org/10.1016/j.parco.2010.12.002>. URL <http://www.sciencedirect.com/science/article/pii/S0167819110001560>
- [37] Benner, P., Gugercin, S., Willcox, K.: A survey of model reduction methods for parametric systems. Preprint MPIMD/13-14, Max Planck Institute Magdeburg Preprints (2013). Available from <http://www.mpi-magdeburg.mpg.de/preprints/>
- [38] Benner, P., Kürschner, P., Saak, J.: A goal-oriented dual LR-ADI for balanced truncation. In: I. Troch, F. Breitenecker (eds.) *7th Vienna International Conference on Mathematical Modelling, IFAC-PapersOnlines, Mathematical Modelling*, vol. 7, pp. 752–757. Vienna Univ. of Technology (2012)
- [39] Benner, P., Kürschner, P., Saak, J.: An improved numerical method for balanced truncation for symmetric second order systems. *Math. Comput. Model. Dyn. Syst.* **19**(6), 593–615 (2013). DOI [10.1080/13873954.2013.794363](https://doi.org/10.1080/13873954.2013.794363)

- [40] Benner, P., Li, J.R., Penzl, T.: Numerical solution of large Lyapunov equations, Riccati equations, and linear-quadratic control problems. *Numer. Algorithms* **15**(9), 755–777 (2008)
- [41] Benner, P., Quintana-Ortí, E.: Model reduction based on spectral projection methods. Chapter 1 (pages 5–48) of [?]
- [42] Benner, P., Quintana-Ortí, E.: Solving stable generalized Lyapunov equations with the matrix sign function. *Numer. Algorithms* **20**(1), 75–100 (1999)
- [43] Benner, P., Quintana-Ortí, E., Quintana-Ortí, G.: A portable subroutine library for solving linear control problems on distributed memory computers. In: G. Cooperman, E. Jessen, G. Michler (eds.) *Workshop on Wide Area Networks and High Performance Computing*, Essen (Germany), September 1998, *Lecture Notes in Control and Information*, pp. 61–88. Springer-Verlag, Berlin/Heidelberg, Germany (1999)
- [44] Benner, P., Quintana-Ortí, E., Quintana-Ortí, G.: Balanced truncation model reduction of large-scale dense systems on parallel computers. *Math. Comput. Model. Dyn. Syst.* **6**(4), 383–405 (2000)
- [45] Benner, P., Quintana-Ortí, E., Quintana-Ortí, G.: Singular perturbation approximation of large, dense linear systems. In: *Proc. 2000 IEEE Intl. Symp. CACSD*, Anchorage, Alaska, USA, September 25–27, 2000, pp. 255–260. IEEE Press, Piscataway, NJ (2000)
- [46] Benner, P., Quintana-Ortí, E., Quintana-Ortí, G.: Efficient numerical algorithms for balanced stochastic truncation. *Int. J. Appl. Math. Comp. Sci.* **11**(5), 1123–1150 (2001)
- [47] Benner, P., Quintana-Ortí, E., Quintana-Ortí, G.: State-space truncation methods for parallel model reduction of large-scale systems. *Parallel Comput.* **29**, 1701–1722 (2003)
- [48] Benner, P., Quintana-Ortí, E., Quintana-Ortí, G.: Computing optimal Hankel norm approximations of large-scale systems. In: *Proc. 43rd IEEE Conf. Decision Contr.*, pp. 3078–3083. Omnipress, Madison, WI (2004)
- [49] Benner, P., Schneider, A.: Model reduction for linear descriptor systems with many ports. In: M. Günther, A. Bartel, M. Brunk, S. Schöps, M. Striebel (eds.) *Progress in Industrial Mathematics at ECMI 2010, Mathematics in Industry*, vol. 17, pp. 137–143. Springer-Verlag, Berlin/Heidelberg, Germany (2012)
- [50] Bollhöfer, M., Bodendiek, A.: Adaptive-order rational Arnoldi method for Maxwell’s equations. In: *Scientific Computing in Electrical Engineering (Abstracts)*, pp. 77–78 (2012)

- [51] Bond, B., Daniel, L.: Parameterized model order reduction of nonlinear dynamical systems. In: In Proc. International Conference on Computer-Aided Design, pp. 487–494 (2005)
- [52] Bond, B., Daniel, L.: Stable reduced models for nonlinear descriptor systems through piecewise-linear approximation and projection. *IEEE Trans. Comput.-Aided Des. Integr. Circuits Syst.* **28**(10), 1467–1480 (2009)
- [53] Boyaval, S., Le Bris, C., Lelièvre, T., Maday, Y., Nguyen, N., Patera, A.: Reduced basis techniques for stochastic problems. *Archives of Computational Methods in Engineering* **17**(4), 435–454 (2010). DOI 10.1007/s11831-010-9056-z. URL <http://dx.doi.org/10.1007/s11831-010-9056-z>
- [54] Breiten, T., Damm, T.: Krylov subspace methods for model order reduction of bilinear control systems. *Sys. Control Lett.* **59**(10), 443–450 (2010)
- [55] Bunse-Gerstner, A., Kubalinska, D., Vossen, G., Wilczek, D.: h_2 -norm optimal model reduction for large scale discrete dynamical MIMO systems. *J. Comput. Appl. Math.* **233**(5), 1202–1216 (2010). DOI <http://dx.doi.org/10.1016/j.cam.2008.12.029>
- [56] Chaturantabut, S., Sorensen, D.C.: Nonlinear model reduction via discrete empirical interpolation. *SIAM J. Sci. Comput.* **32**(5), 2737–2764 (2010)
- [57] Chen, Y.: Model order reduction for nonlinear systems. Master’s thesis, Massachusetts Institute of Technology (1999)
- [58] Chiprout, E., Nakhla, M.: Analysis of interconnect networks using complex frequency hopping (CFH). *IEEE Trans. Comput.-Aided Des. Integr. Circuits Syst.* **14**(2), 186–200 (1995)
- [59] Chu, C., Lai, M., Feng, W.: MIMO interconnects order reductions by using the multiple point adaptive-order rational global Arnoldi algorithm. *IEICE Transactions on Electronics* **E89-C**(6), 792–802 (2006)
- [60] Condon, M., Ivanov, R.: Krylov subspaces from bilinear representations of nonlinear systems. *COMPEL Mathematics in Electrical and Electronic Engineering* **26**(2), 399–406 (2007)
- [61] Craig, R., Bampton, M.: Coupling of substructures for dynamic analysis. *AIAA J.* **6**, 1313–1319 (1968)
- [62] Davison, E.: A method for simplifying linear dynamic systems. *IEEE Trans. Automat. Control* **AC-11**, 93–101 (1966)
- [63] Dong, N., Roychowdhury, J.: Piecewise polynomial nonlinear model reduction. In: In Proc. Design Automation Conference, pp. 484–489 (2003)

- [64] Dong, N., Roychowdhury, J.: Automated extraction of broadly applicable nonlinear analog macromodels from SPICE-level descriptions. In: Custom Integrated Circuits Conference, 2004. Proceedings of the IEEE 2004, pp. 117–120 (2004)
- [65] Druskin, V., Simoncini, V.: Adaptive rational Krylov subspaces for large-scale dynamical systems. *Sys. Control Lett.* **60**, 546–560 (2011)
- [66] Enns, D.: Model reduction with balanced realization: an error bound and a frequency weighted generalization. In: Proc. 23rd IEEE Conf. Decis. Control, pp. 127–132. Las Vegas, NV (1984)
- [67] Eppler, A., Bollhöfer, M.: An alternative way of solving large Lyapunov equations. *Proc. Appl. Math. Mech.* **10**(1), 547–548 (2010)
- [68] Eppler, A., Bollhöfer, M.: Structure-preserving GMRES methods for solving large Lyapunov equations. In: M. Günther, A. Bartel, M. Brunk, S. Schöps, M. Striebel (eds.) *Progress in Industrial Mathematics at ECMI 2010, Mathematics in Industry*, vol. 17, pp. 131–136. Springer-Verlag, Berlin (2012)
- [69] Faßbender, H., Soppa, A.: Machine tool simulation based on reduced order FE models. *Math. Comput. Simulation* **82**(3), 404–413 (2011)
- [70] Feldmann, P., Freund, R.: Efficient linear circuit analysis by Padé approximation via the Lanczos process. In: Proceedings of EURO-DAC '94 with EURO-VHDL '94, Grenoble, France, pp. 170–175. IEEE Computer Society Press (1994). URL citeseer.ist.psu.edu/feldmann94efficient.html
- [71] Feldmann, P., Freund, R.: Efficient linear circuit analysis by Padé approximation via the Lanczos process. *IEEE Trans. Comput.-Aided Des. Integr. Circuits Syst.* **14**, 639–649 (1995)
- [72] Feldmann, P., Liu, F.: Sparse and efficient reduced order modeling of linear subcircuits with large number of terminals. In: In Proc. International Conference on Computer-Aided Design, pp. 88–92 (2004)
- [73] Feng, L., Benner, P.: A note on projection techniques for model order reduction of bilinear systems. In: *Numerical Analysis and Applied Mathematics: International Conference of Numerical Analysis and Applied Mathematics*, pp. 208–211 (2007)
- [74] Feng, L., Benner, P.: Automatic model order reduction by moment-matching according to an efficient output error bound. In: *Scientific Computing in Electrical Engineering (Abstracts)*, pp. 71–72 (2012)
- [75] Feng, L., Benner, P., Korvink, J.: System-level modeling of MEMS by means of model order reduction (mathematical approximation)—mathematical background. In: T. Bechtold, G. Schrag, L. Feng (eds.) *System-Level Modeling of MEMS, Advanced Micro & Nanosystems*. Wiley-VCH (2013)

- [76] Feng, L., Korvink, J., Benner, P.: A fully adaptive scheme for model order reduction based on moment-matching. Preprint MPIMD/12-14, Max Planck Institute Magdeburg Preprints (2012). Available from <http://www.mpi-magdeburg.mpg.de/preprints/>
- [77] Feng, L., Zeng, X., Chiang, C., Zhou, D., Fang, Q.: Direct nonlinear order reduction with variational analysis. In Proc. Design Automation and Test in Europe pp. 1316–1321 (2004)
- [78] Fernando, K., Hammarling, S.: A product induced singular value decomposition for two matrices and balanced realization. In: B.D. et al. (ed.) Linear Algebra in Signals, Systems and Control, pp. 128–140. SIAM, Philadelphia, PA (1988)
- [79] Fernando, K., Nicholson, H.: On the structure of balanced and other principal representations of SISO systems. IEEE Trans. Automat. Control **28**(2), 228–231 (1983)
- [80] Fernando, K., Nicholson, H.: On a fundamental property of the cross-Gramian matrix. IEEE Trans. Circuits Syst. **CAS-31**(5), 504–505 (1984)
- [81] Flagg, G.: H₂-optimal interpolation: New properties and applications. In: Talk given at the 2010 SIAM Annual Meeting. Pittsburgh (PA) (2010)
- [82] Flagg, G.: Interpolation methods for the model reduction of bilinear systems. Ph.D. thesis, Virginia Polytechnic Institute and State University (2012)
- [83] Flagg, G., Beattie, C., Gugercin, S.: Interpolatory \mathcal{H}_∞ model reduction. Sys. Control Lett. **62**(7), 567–574 (2013)
- [84] Flagg, G., Gugercin, S.: On the {ADI} method for the Sylvester equation and the optimal- \mathcal{H}_2 points. Applied Numerical Mathematics **64**(0), 50–58 (2013)
- [85] Fortuna, L., Nummari, G., Gallo, A.: Model Order Reduction Techniques with Applications in Electrical Engineering. Springer-Verlag (1992)
- [86] Freund, R.: Krylov subspace methods for reduced-order modeling in circuit simulation. J. Comput. Appl. Math. **123**, 395–421 (2000)
- [87] Freund, R.: Model reduction methods based on Krylov subspaces. Acta Numerica **12**, 267–319 (2003)
- [88] Freund, R.: SPRIM: Structure-preserving reduced-order interconnect macro-modeling. In: In Proc. International Conference on Computer-Aided Design, pp. 80–87 (2004)
- [89] Freund, R., Feldmann, P.: Reduced-order modeling of large passive linear circuits by means of the SyPVL algorithm. In: Technical Digest of the 1996 IEEE/ACM International Conference on Computer-Aided Design, pp. 280–287. IEEE Computer Society Press (1996)

- [90] Freund, R., Feldmann, P.: The SyMPVL algorithm and its applications to interconnect simulation. In: Proceedings of the 1997 International Conference on Simulation of Semiconductor Processes and Devices, pp. 113–116. IEEE (1997). URL citeseer.ist.psu.edu/freund97sympvl.html
- [91] Freund, R., Feldmann, P.: Reduced-order modeling of large linear passive multi-terminal circuits using matrix-Padé approximation. In: Proceedings of the Design, Automation and Test in Europe Conference 1998, pp. 530–537. IEEE Computer Society Press (1998). URL citeseer.ist.psu.edu/article/freund98reducedorder.html
- [92] Gallivan, K., Grimme, E., Van Dooren, P.: Asymptotic waveform evaluation via a Lanczos method. *Applied Mathematics Letters* **7**(5), 75–80 (1994)
- [93] Gawronski, W., Juang, J.N.: Model reduction in limited time and frequency intervals. *Internat. J. Systems Sci.* **21**(2), 349–376 (1990)
- [94] Glover, K.: All optimal Hankel-norm approximations of linear multivariable systems and their L^∞ norms. *Internat. J. Control* **39**, 1115–1193 (1984)
- [95] Golub, G., Van Loan, C.: *Matrix Computations*, third edn. Johns Hopkins University Press, Baltimore (1996)
- [96] Gragg, W., Lindquist, A.: On the partial realization problem. *Linear Algebra Appl.* **50**, 277–319 (1983)
- [97] Grasedyck, L.: Existence of a low rank or \mathcal{H} -matrix approximant to the solution of a Sylvester equation. *Numer. Linear Algebra Appl.* **11**(4), 371–389 (2004)
- [98] Grasedyck, L., Hackbusch, W.: A multigrid method to solve large scale Sylvester equations. *SIAM J. Matrix Anal. Appl.* **29**(3), 870–894 (2007)
- [99] Grasedyck, L., Hackbusch, W., Khoromskij, B.: Solution of large scale algebraic matrix Riccati equations by use of hierarchical matrices. *Computing* **70**(2), 121–165 (2003)
- [100] Grepl, M., Maday, Y., Nguyen, N., Patera, A.: Efficient reduced-basis treatment of nonaffine and nonlinear partial differential equations. *ESAIM: Math. Model. Num.* **41**(03), 575–605 (2007)
- [101] Grimme, E.: *Krylov projection methods for model reduction*. Ph.D. thesis, Univ. Illinois, Urbana-Champaign (1997)
- [102] Grimme, E., Sorensen, D., Van Dooren, P.: Model reduction of state space systems via an implicitly restarted Lanczos method. *Numer. Algorithms* **12**, 1–31 (1996)
- [103] Gu, C.: QLMOR: A new projection-based approach for nonlinear model order reduction. In: *In Proc. International Conference on Computer-Aided Design*, pp. 389–396 (2009)

- [104] Gu, C.: QLMOR: A projection-based nonlinear model order reduction approach using quadratic-linear representation of nonlinear systems. *IEEE Trans. Comput.-Aided Design* **30**(9), 1307–1320 (2011)
- [105] Gugercin, S., Antoulas, A.: A survey of model reduction by balanced truncation and some new results. *Internat. J. Control* **77**(8), 748–766 (2004)
- [106] Gugercin, S., Antoulas, A., Beattie, C.: \mathcal{H}_2 model reduction for large-scale linear dynamical systems. *SIAM J. Matrix Anal. Appl.* **30**(2), 609–638 (2008)
- [107] Gugercin, S., Li, J.R.: Smith-type methods for balanced truncation of large systems. Chapter 2 (pages 49–82) of [?]
- [108] Gugercin, S., Sorensen, D.C., Antoulas, A.C.: A modified low-rank Smith method for large-scale Lyapunov equations. *Numer. Algorithms* **32**(1), 27–55 (2003)
- [109] Heath, M., Laub, A., Paige, C., Ward, R.: Computing the SVD of a product of two matrices. *SIAM J. Sci. Statist. Comput.* **7**, 1147–1159 (1987)
- [110] Heinkenschloss, M., Reis, T., Antoulas, A.: Balanced truncation model reduction for systems with inhomogeneous initial conditions. *Automatica* **47**, 559–564 (2011)
- [111] Hochbruck, M., Starke, G.: Preconditioned Krylov subspace methods for Lyapunov matrix equations. *SIAM J. Matrix Anal. Appl.* **16**(1), 156–171 (1995)
- [112] Hochman, A., Vasilyev, D.M., Rewieński, M.J., White, J.K.: Projection-based nonlinear model order reduction. In: T. Bechtold, G. Schrag, L. Feng (eds.) *System-Level Modeling of MEMS, Advanced Micro & Nanosystems*. Wiley-VCH (2013)
- [113] Hodel, A., Tenison, B., Poolla, K.: Numerical solution of the Lyapunov equation by approximate power iteration. *Linear Algebra Appl.* **236**, 205–230 (1996)
- [114] Hu, D., Reichel, L.: Krylov-subspace methods for the Sylvester equation. *Linear Algebra Appl.* **172**, 283–313 (1992)
- [115] Ito, K., Kunisch, K.: Reduced order control based on approximate inertial manifolds. *Linear Algebra Appl.* **415**(2–3), 531–541 (2006)
- [116] Jaimoukha, I., Kasenally, E.: Krylov subspace methods for solving large Lyapunov equations. *SIAM J. Numer. Anal.* **31**, 227–251 (1994)
- [117] Jaimoukha, I., Kasenally, E.: Implicitly restarted Krylov subspace methods for stable partial realizations. *SIAM J. Matrix Anal. Appl.* **18**(3), 633–652 (1997)
- [118] Jbilou, K., Riquet, A.: Projection methods for large Lyapunov matrix equations. *Linear Algebra Appl.* **415**, 344–358 (2006)

- [119] Kamon, M., Wang, F., White, J.: Generating nearly optimally compact models from krylov-subspace based reduced-order models. *IEEE Trans. Circuits and Systems* **47**(4), 239–248 (2000)
- [120] Kerns, K., Wemple, I., Yang, A.: Stable and efficient reduction of substrate model networks using congruence transforms. In: *ICCAD '95: Proceedings of the 1995 IEEE/ACM international conference on Computer-aided design*, pp. 207–214. Washington, DC, USA (1995)
- [121] Konkel, Y., Farle, O., Dyczij-Edlinger, R.: Ein Fehlerschätzer für die Krylov-Unterraum basierte Ordnungsreduktion zeitharmonischer Anregungsprobleme (in German). In: B. Lohmann, A. Kugi (eds.) *Tagungsband GMA-FA 1.30, 'Modellbildung, Identifikation und Simulation in der Automatisierungstechnik'*, pp. 139–149 (2008)
- [122] Konkel, Y., Farle, O., Sommer, A., S.Burgard, Dyczij-Edlinger, R.: A Posteriori Error Bounds for Krylov-Based Fast Frequency Sweeps of Finite-Element Systems. *IEEE Trans. Magn.* **to appear** (2014)
- [123] Kressner, D.: Numerical methods for general and structured eigenvalue problems, *Lecture Notes in Computational Science and Engineering*, vol. 46. Springer-Verlag, Berlin (2005)
- [124] Kressner, D., Tobler, C.: Krylov subspace methods for linear systems with tensor product structure. *SIAM J. Matrix Anal. Appl.* **31**(4), 1688–1714 (2010)
- [125] Lancaster, P.: Explicit solutions of linear matrix equations. *SIAM Rev.* **12**, 544–566 (1970)
- [126] Laub, A., Heath, M., Paige, C., Ward, R.: Computation of system balancing transformations and other application of simultaneous diagonalization algorithms. *IEEE Trans. Automat. Control* **34**, 115–122 (1987)
- [127] Laub, A., Silverman, L., Verma, M.: A note on cross-Grammians for symmetric realizations. *Proceedings of the IEEE Trans. Circuits Syst.* **71**(7), 904–905 (1983)
- [128] Lee, H., Chu, C., Feng, W.: An adaptive-order rational Arnoldi method for model-order reductions of linear time-invariant systems. *Linear Algebra Appl.* **415**(23), 235–261 (2006)
- [129] Li, J.R., Wang, F., White, J.: An efficient Lyapunov equation-based approach for generating reduced-order models of interconnect. In: *In Proc. Design Automation Conference*, pp. 1–6 (1999)
- [130] Li, J.R., White, J.: Reduction of large circuit models via low rank approximate gramians. *Int. J. Appl. Math. Comp. Sci.* **11**(5), 1151–1171 (2001)
- [131] Li, J.R., White, J.: Low rank solution of Lyapunov equations. *SIAM J. Matrix Anal. Appl.* **24**(1), 260–280 (2002)

- [132] Li, P., Pileggi, L.: NORM: Compact model order reduction of weakly nonlinear systems. In: In Proc. Design Automation Conference, pp. 472–477 (2003)
- [133] Li, P., Shi, W.: Model order reduction of linear networks with massive ports via frequency-dependent port packing. In: In Proc. International Conference on Computer-Aided Design, pp. 267–272 (2006)
- [134] Li, R., Bai, Z.: Structure-preserving model reduction using a Krylov subspace projection formulation. *Comm. Math. Sci* **3**(2), 179–199 (2005)
- [135] Lin, Y., Bao, L., Wei, Y.: A model-order reduction method based on Krylov subspace for MIMO bilinear dynamical systems. *J. Appl. Math & Computing* **25**(1-2), 293–304 (2007)
- [136] Lin, Y., Simoncini, V.: Minimal residual methods for large scale Lyapunov equations. *Applied Numerical Mathematics* **72**, 52–71 (2013)
- [137] Liu, P., Tan, X.D., Li, H., Qi, Z., Kong, J., McGaughy, B., He, L.: An efficient method for termical reduction of interconnect circuits considering delay variations. In: In Proc. International Conference on Computer-Aided Design, pp. 820–825 (2005)
- [138] Liu, W., Sreeram, V.: Model reduction of singular systems. In: Proc.39th IEEE Conf. Dec. Control 2000, pp. 2373–2378 (2000)
- [139] Liu, Y., Anderson, B.: Controller reduction via stable factorization and balancing. *Internat. J. Control* **44**, 507–531 (1986)
- [140] Marschall, S.: An approximate method for reducing the order of a linear system. *Contr. Eng.* **10**, 642–648 (1966)
- [141] The MathWorks, Inc., <http://www.matlab.com>:
- [142] Mehrmann, V., Stykel, T.: Balanced truncation model reduction for large-scale systems in descriptor form. Chapter 3 (pages 83–115) of [?]
- [143] Moore, B.C.: Principal component analysis in linear systems: Controllability, observability, and model reduction. *IEEE Trans. Automat. Control* **AC-26**, 17–32 (1981)
- [144] Mullis, C., Roberts, R.: Synthesis of minimum roundoff noise fixed point digital filters. *IEEE Trans. Circuits and Systems* **CAS-23**(9), 551–562 (1976)
- [145] Nakhla, N., Nakhla, M., Achar, R.: Sparse and passive reduction of massively coupled large multiport interconnects. In: In Proc. International Conference on Computer-Aided Design, pp. 622–626 (2007)
- [146] Nguyen, N., Patera, A., Peraire, J.: A best points interpolation method for efficient approximation of parametrized functions. *Internat. J. Numer. Meth. Eng.* **73**(4), 521–543 (2008)

- [147] Nouy, A.: Recent developments in spectral stochastic methods for the numerical solution of stochastic partial differential equations. *Archives of Computational Methods in Engineering* **16**(3), 251–285 (2009). DOI 10.1007/s11831-009-9034-5. URL <http://dx.doi.org/10.1007/s11831-009-9034-5>
- [148] Odabasioglu, A., Celik, M., Pileggi, L.: PRIMA: passive reduced-order interconnect macromodeling algorithm. *IEEE Trans. Comput.-Aided Des. Integr. Circuits Syst.* **17**(8), 645–654 (1998)
- [149] Opmeer, M.: Model order reduction by balanced proper orthogonal decomposition and by rational interpolation. *IEEE Trans. Automat. Control* **57**(2), 472–477 (2012)
- [150] Panzer, H., Jaensch, S., Wolf, T., Lohmann, B.: A greedy rational Krylov method for h_2 -pseudooptimal model order reduction with preservation of stability. In: *Proceedings of the American Control Conference*, pp. 5512–5517 (2013)
- [151] Panzer, H., Wolf, T., Lohmann, B.: h_2 and h_∞ error bounds for model order reduction of second order systems by Krylov subspace methods. In: *Proceedings of the European Control Conference* (2013)
- [152] Penzl, T.: A multi-grid method for generalized Lyapunov equations. Tech. Rep. SFB393/97-24, Fakultät für Mathematik, TU Chemnitz, 09107 Chemnitz, FRG (1997). Available from <http://www.tu-chemnitz.de/sfb393/sfb97pr.html>.
- [153] Penzl, T.: A cyclic low-rank Smith method for large sparse Lyapunov equations. *SIAM J. Sci. Comput.* **21**(4), 1401–1418 (1999/00)
- [154] Penzl, T.: Eigenvalue decay bounds for solutions of Lyapunov equations: the symmetric case. *Sys. Control Lett.* **40**, 139–144 (2000)
- [155] Penzl, T.: Algorithms for model reduction of large dynamical systems. *Linear Algebra Appl.* **415**(2–3), 322–343 (2006). (Reprint of Technical Report SFB393/99-40, TU Chemnitz, 1999.)
- [156] Perev, K., Shafai, B.: Balanced realization and model reduction of singular systems. *Internat. J. Systems Sci.* **25**(6), 1039–1052 (1994)
- [157] Pernebo, L., Silverman, L.: Model reduction via balanced state space representations. *IEEE Trans. Automat. Control* **27**(2), 382–387 (1982)
- [158] Phillips, J.: Projection frameworks for model reduction of weakly nonlinear systems. In: *In Proc. Design Automation Conference*, pp. 184–189 (2000)
- [159] Phillips, J.: Projection-based approaches for model reduction of weakly nonlinear time-varying systems. *IEEE Trans. Comput.-Aided Des. Integr. Circuits Syst.* **22**(2), 171–187 (2003)

- [160] Phillips, J., Daniel, L., Silveira, L.: Guaranteed passive balancing transformations for model order reduction. *IEEE Trans. Comput.-Aided Des. Integr. Circuits Syst.* **22**(8), 1027–1041 (2003)
- [161] Phillips, J., Silveira, L.: Poor man’s TBR: A simple model reduction scheme. *IEEE Trans. Comput.-Aided Des. Integr. Circuits Syst.* **24**(1), 43–55 (2005)
- [162] Pillage, L., Rohrer, R.: Asymptotic waveform evaluation for timing analysis. *IEEE Trans. Comput.-Aided Design* **9**, 325–366 (1990)
- [163] Rabieci, P., Pedram, M.: Model order reduction of large circuits using balanced truncation. In: *Proc. of Asia and South Pacific Design Automation Conf.*, pp. 237–240 (1999)
- [164] Reis, T., Stykel, T.: Positive real and bounded real balancing for model reduction of descriptor systems. *Internat. J. Control* **83**(1), 74–88 (2010)
- [165] Rewieński, M., White, J.: A trajectory piecewise-linear approach to model order reduction and fast simulation of nonlinear circuits and micromachined devices. *IEEE Trans. Comput.-Aided Des. Integr. Circuits Syst.* **22**(2), 155–170 (2003)
- [166] Rewieński, M., White, J.: Model order reduction for nonlinear dynamical systems based on trajectory piecewise-linear approximations. *Linear Algebra Appl.* **415**(2-3), 426–454 (2006)
- [167] Rosen, I., Wang, C.: A multi-level technique for the approximate solution of operator Lyapunov and algebraic Riccati equations. *SIAM J. Numer. Anal.* **32**(2), 514–541 (1995)
- [168] Roychowdhury, J.: Reduced-order modeling of time-varying system. *IEEE Trans. Circuits and Systems II* **46**(10), 1273–1288 (1999)
- [169] Rozza, G., Huynh, D., Patera, A.: Reduced basis approximation and a posteriori error estimation for affinely parametrized elliptic coercive partial differential equations. *Archives of Computational Methods in Engineering* **15**(3), 229–275 (2008). DOI 10.1007/s11831-008-9019-9. URL <http://dx.doi.org/10.1007/s11831-008-9019-9>
- [170] Rugh, W.: *Nonlinear System Theory*. The Johns Hopkins University Press, Baltimore (1981)
- [171] Saad, Y.: Numerical solution of large Lyapunov equations. In: M.A. Kaashoek, J.H. van Schuppen, A.C.M. Ran (eds.) *Signal Processing, Scattering, Operator Theory and Numerical Methods*, pp. 503–511. Birkhäuser (1990)
- [172] Safonov, M., Chiang, R.: A Schur method for balanced truncation model reduction. *IEEE Trans. Automat. Control* **34**(7), 729–733 (1989)

- [173] Salimbahrami, B., Lohmann, B.: Order reduction of large scale second-order systems using Krylov subspace methods. *Linear Algebra Appl.* pp. 385–405 (2006)
- [174] Saraswat, D., Achar, R., Nakhla, M.: Projection based fast passive compact macromodeling of high-speed VLSI circuits and interconnects. In: *Proc. 18th Int. Conf. VLSI Design 2005*, pp. 629–633 (2005)
- [175] Sastry, S.: *Nonlinear Systems: Analysis, Stability, and Control, Interdisciplinary Applied Mathematics*, vol. 10. Springer-Verlag, New York (1999)
- [176] Siebert, W.M.: *Circuits, signals, and systems*. MIT Press, Cambridge, MA, USA (1986)
- [177] Silveira, L., Kamon, M., Elfadel, I., White, J.: A coordinate-transformed Arnoldi algorithm for generating guaranteed stable reduced order models of arbitrary RLC circuits. In: *In Proc. International Conference on Computer-Aided Design*, pp. 288–294 (1996)
- [178] Silveira, L., Phillips, J.: Exploiting input information in a model reduction algorithm for massively coupled parasitic networks. In: *In Proc. Design Automation Conference*, pp. 385–388 (2004)
- [179] Simoncini, V.: A new iterative method for solving large-scale Lyapunov matrix equations. *SIAM J. Sci. Comput.* **29**(3), 1268–1288 (2007)
- [180] Simoncini, V., Druskin, V.: Convergence analysis of projection methods for the numerical solution of large Lyapunov equations. *SIAM J. Numer. Anal.* **47**(2), 828–843 (2009)
- [181] Sorensen, D., Antoulas, A.: The Sylvester equation and approximate balanced reduction. *Linear Algebra Appl.* **351/352**, 671–700 (2002)
- [182] Sorensen, D., Zhou, Y.: Bounds on eigenvalue decay rates and sensitivity of solutions to Lyapunov equations. *Tech. Rep. TR02-07*, Dept. of Comp. Appl. Math., Rice University, Houston, TX (2002). Available online from <http://www.caam.rice.edu/caam/trs/tr02.html#TR02-07>
- [183] Stykel, T.: Gramian-based model reduction for descriptor systems. *Math. Control, Signals, Sys.* **16**(4), 297–319 (2004)
- [184] Stykel, T.: Balanced truncation model reduction for semidiscretized Stokes equation. *Linear Algebra Appl.* **415**(2-3), 262–289 (2006)
- [185] Su, Y.F., Wang, J., Zeng, X., Bai, Z., Chiang, C., Zhou, D.: SAPOR: Second-order Arnoldi method for passive order reduction of RCS circuits. In: *In Proc. International Conference on Computer-Aided Design*, pp. 74–79 (2004)

- [186] Tiwary, S., Rutenbar, R.: Scalable trajectory methods for on-demand analog macromodel extraction. In: In Proc. Design Automation Conference, pp. 403–408 (2005)
- [187] Tombs, M., Postlethwaite, I.: Truncated balanced realization of a stable non-minimal state-space system. *Internat. J. Control* **46**(4), 1319–1330 (1987)
- [188] V. Druskin, L.K., Simoncini, V.: Analysis of the rational Krylov subspace and ADI methods for solving the Lyapunov equation. *SIAM J. Numer. Anal.* **49**(5), 1875–1898 (2011)
- [189] Van Dooren, P.: Gramian based model reduction of large-scale dynamical systems. In: D. Griffiths, G. Watson (eds.) *Numerical Analysis 1999. Proc. 18th Dundee Biennial Conference on Numerical Analysis*, pp. 231–247. London, UK (2000)
- [190] Van Dooren, P., Gallivan, K., Absil, P.A.: \mathcal{H}_2 -optimal model reduction of MIMO systems. *Applied Mathematics Letters* **21**(12), 1267–1273 (2008)
- [191] Vandereycken, B., Vandewalle, S.: A Riemannian optimization approach for computing low-rank solutions of Lyapunov equations related databases. *SIAM J. Matrix Anal. Appl.* **31**(5), 2553–2579 (2010)
- [192] Varga, A.: Efficient minimal realization procedure based on balancing. In: *Prepr. of the IMACS Symp. on Modelling and Control of Technological Systems*, vol. 2, pp. 42–47 (1991)
- [193] Vasilyev, D., Rewieński, M., White, J.: A TBR-based trajectory piecewise-linear algorithm for generating accurate low-order models for nonlinear analog circuits and MEMS. In: In Proc. Design Automation Conference, pp. 490–495 (2003)
- [194] Villena, J.F., Silveira, L.M.: Multi-dimensional automatic sampling schemes for multi-point modeling methodologies. *IEEE Trans. Comput.-Aided Des. Integr. Circuits Syst.* **30**(8), 1141–1151 (2011)
- [195] Willcox, K., Peraire, J.: Balanced model reduction via the proper orthogonal decomposition. *AIAA J.* **40**(11), 2323–2330 (2002)
- [196] Wittig, T., Munteanu, I., Schuhmann, R., Weiland, T.: Two-step Lanczos algorithm for model order reduction. In: *IEEE Transactions on Magnetics*, vol. 38, pp. 673–676 (2002)
- [197] Wolf, T., Panzer, H., Lohmann, B.: Gramian-based error bound in model reduction by Krylov subspace methods. In: In Proc. IFAC World Congress, pp. 3587–3591 (2011)
- [198] Wolf, T., Panzer, H., Lohmann, B.: ADI-Lösung großer Ljapunow-Gleichungen mittels Krylov-Methoden und neue Formulierung des Residuums (in German).

- In: O. Sawodny, J. Adamy (eds.) Tagungsband GMA-FA 1.30, 'Modellbildung, Identifikation und Simulation in der Automatisierungstechnik', pp. 291–303 (2012)
- [199] Wolf, T., Panzer, H., Lohmann, B.: Sylvester equations and the factorization of the error system in Krylov subspace methods. In: Proceedings of the 7th Vienna Conference on Mathematical Modelling (MATHMOD). Vienna, Austria (2012)
- [200] Wolf, T., Panzer, H., Lohmann, B.: Model reduction by approximate balanced truncation: A unifying framework. *at-Automatisierungstechnik* **61**(8), 545–556 (2013)
- [201] Yan, B., Tan, X.D., Liu, P., McGaughy, B.: Passive interconnect macromodeling via balanced truncation of linear systems in descriptor form. In: In Proc. Design Automation Conference, pp. 355–360 (2007)
- [202] Yan, B., Tan, X.D., Liu, P., McGaughy, B.: SBPOR: Second-order balanced truncation for passive order reduction of RLC circuits. In: In Proc. Design Automation Conference, pp. 158–161 (2007)
- [203] Zhang, L., Lam, J.: On \mathcal{H}_2 model reduction of bilinear systems. *Automatica* **38**(2), 205–216 (2002)
- [204] Zhang, Y., Liu, H., Wang, Q., Fong, N., Wong, N.: Fast nonlinear model order reduction via associated transforms of high-order Volterra transfer functions. In: In Proc. Design Automation Conference, pp. 289–294 (2012)
- [205] Zhou, K., Salomon, G., Wu, E.: Balanced realization and model reduction for unstable systems. *Int. J. Robust Nonlinear Control* **9**(3), 183–198 (1999)

