

**Modelling techniques: Biophysical  
spatial and temporal modelling  
30<sup>th</sup> October 2018**

**Bethanna Jackson**



# What is a model?

- “A **model** is a pattern, plan, representation or description designed to show the main object or workings of an object, system, or concept.”

(Wikipedia, 2009)

“A **model** is a simplified version of the real system that approximately simulates the excitation-response relations”

(Bear, 1987)

In our context (SEEA-EEA support), the word model also covers interpolation and extrapolation techniques, look up tables etc.

# Types of spatial models:

- **Look-up tables:** specific values are attributed to every pixel in a certain class, usually a land cover class.
- **Statistical approaches:** ecosystem services flow, asset or condition is related to explanatory variables such as soils, land cover, climate, distance from a road, etc., using a statistical relation derived from survey data.
- **Geostatistical interpolation:** techniques such as kriging rely on statistical algorithms to predict the value of un-sampled pixels on the basis of nearby pixels in combination with other characteristics of the pixel.
- **Process based modeling:** involves predicting ecosystem services flows based on modelling of the ecological and/or ecosystem management processes involved.

# SEEA-EEA Biophysical modelling

- **Why?**

- Accounts require a full spatial cover of ecosystem condition, services flows or asset values. Hence – condition indicators, services, and asset need to be defined for the total total area of the accounting area.
- Often – for some services or condition indicators - data are only available for specific locations. Usually, data from various sources and scales need to be combined (e.g., point point field data and satellite data)
- **Spatial models** can be used to integrate point and spatial data and obtain full spatial cover of information, and to model ecosystem services flows.
- **Temporal models** are required for the asset account, where the flow of services during asset life needs to be considered. This may involve linking changes in condition to condition to changes in ecosystem services flows

# Biophysical modelling

= modelling biological and/or physical processes in order to analyze the biophysical elements of an ecosystem account.

- In the condition account: modelling of ecosystem state indicators
- In the ecosystem services account: modelling the supply of ecosystem services by ecosystem, in an accounting period
- In the asset account: modelling the supply of ecosystem services, by ecosystem, during the ecosystem asset life (spatial and temporal dimension)

# SEEA-EEA accounts, tools and linkages

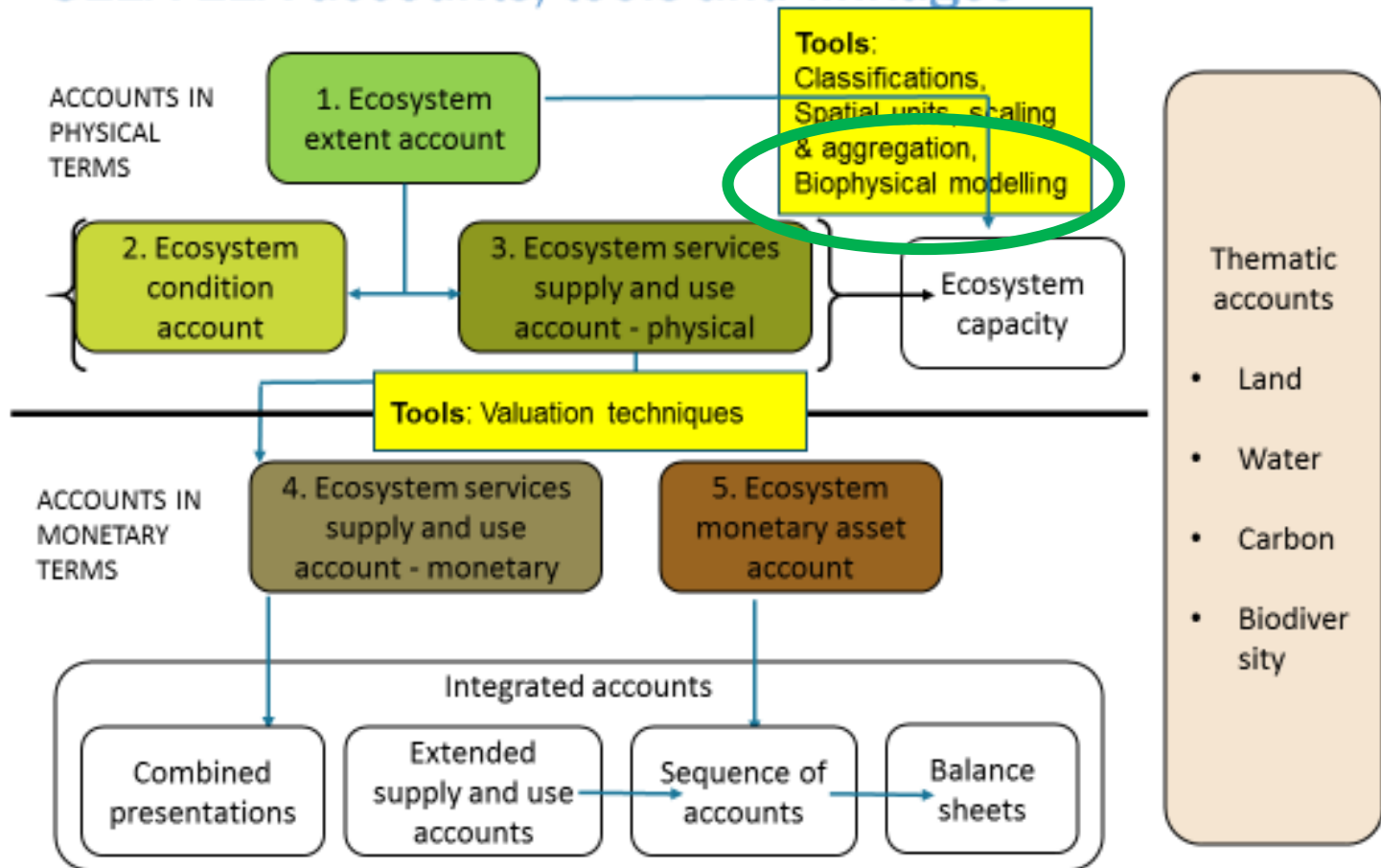

# Why model?

- Determine the effects of management decisions on catchments (e.g. groundwater extraction, stream restoration, gravel extraction, agricultural intensification, etc)
- Forecasting: weather, flood, hazard, climate change etc.
- Assess impact of change (e.g. land use and climate) on resources and hazards
- Hypothesis testing - improve our understanding (does this pathway exist? Is this process significant?)
- *A model is not always an equation or a computer software package- you are modelling the world in your head all the time...*

# Data Issues to consider

- Monitoring issues – data error
- Point measurements versus integrated measurements (e.g. soil moisture content at a “point” versus stream discharge at the outflow of a catchment)
- Also issues of inferring from small sample measurements..
- **Human error/missing metadata**
- **A lot of “data” is actually inferred by putting a different type of “data” through a model; e.g. radar rainfall, streamflow, evaporation.**



# We use models, data and process understanding together to:

- improve understanding of current functioning of a system- hypothesis testing (does this pathway exist, is this process significant)
- better understand the sensitivity of a system to change (do we need to worry about land use, climate change, etc, in this catchment)
- To predict the past (why?), the future, and interpolate or extrapolate in space (predicting the past and future are extrapolation in time)
- *Very important to distinguish between interpolation and extrapolation (using models in circumstances they have not been tested/ "validated" in)*

**We are continuously improving our understanding and predictive ability- an iterative process**

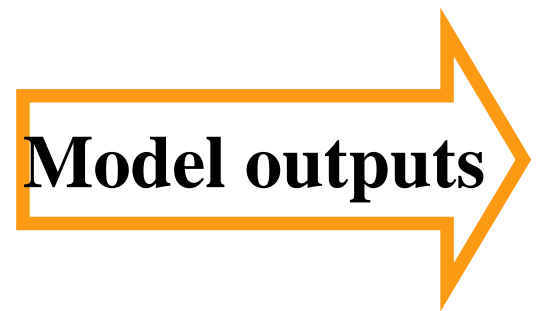
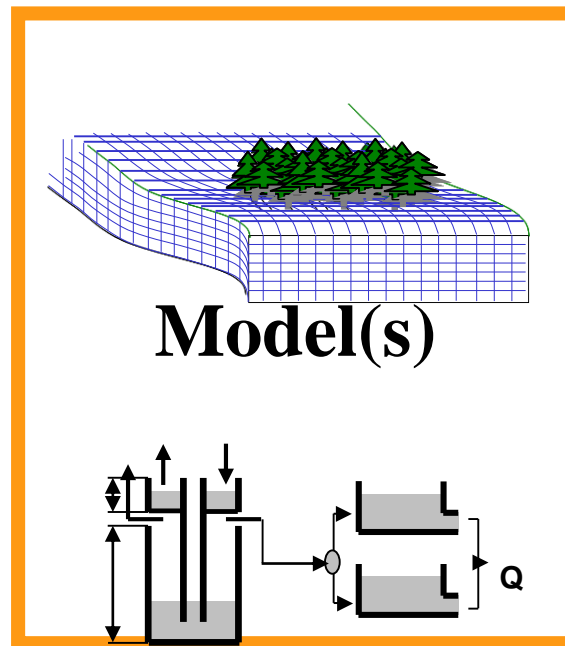
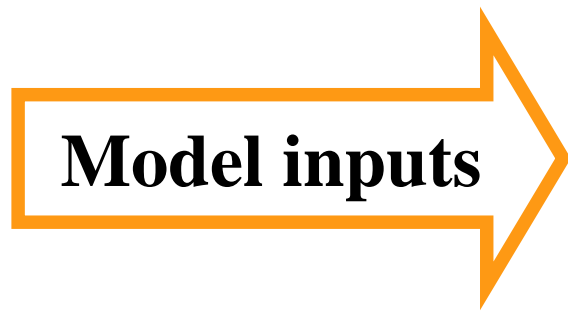
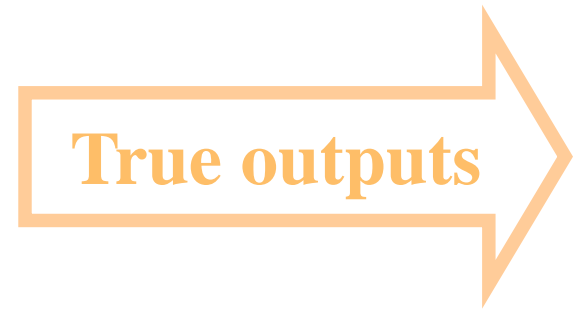
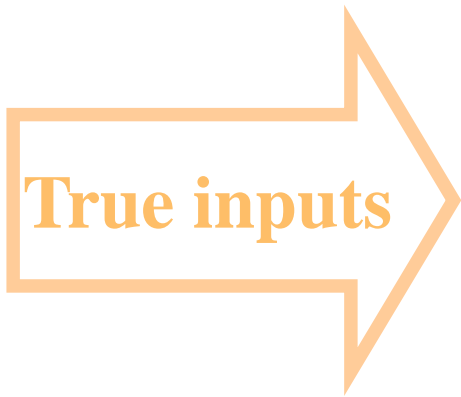

# Model development

Models should be of appropriate complexity with respect to the performance required and associated uncertainty. This structure should be a function of (Wagener, 1998):

- the modelling purpose,
- the characteristics of the system,
- the data available.

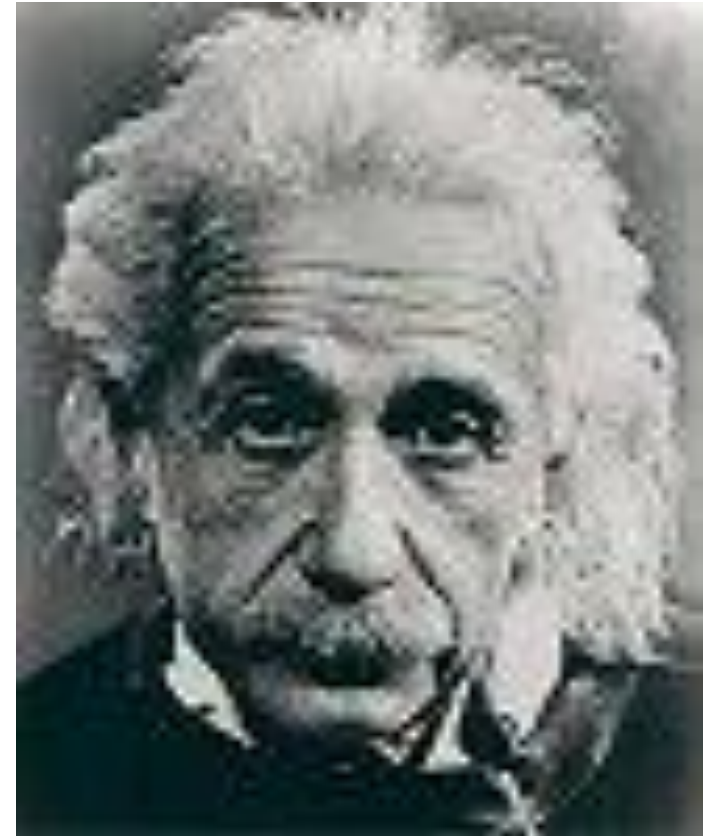

## The Wisdom of Einstein

*“Make everything as simple as possible but not simpler”*

# What type of model (1)?

- Empirical or metric (based on observation, “data driven”, e.g. artificial neural networks)
- Conceptual – conceptualisation of the system- e.g. my soil acts as an analog to a set of pipes with different diameters...
- “Physics” based (mathematical-physics form based on continuum mechanics)
- Hybrid – mix of two or three types of the above (most models are hybrids!)
- *What’s best often depends on whether we are interpolating or extrapolating:*

# What type of model (2)?

Ⓢ Lumped: spatially averaged



Ⓢ Distributed: variables vary in space  
(can be **semi** or **fully** distributed)

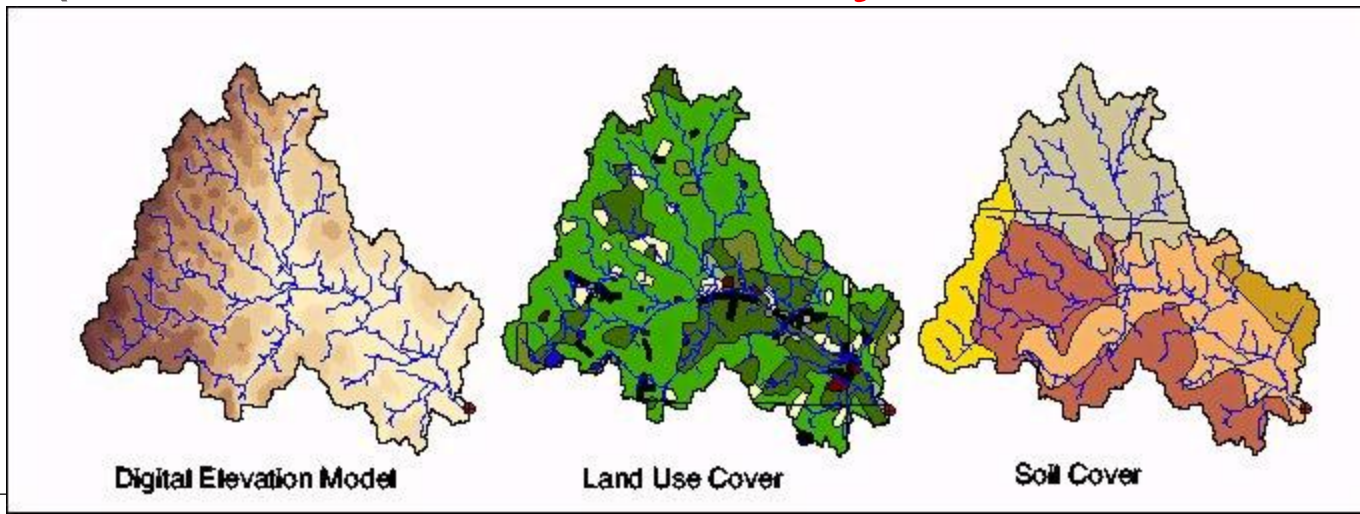

# What scale?

- Spatial
  - *Local or Regional, Plot, Hillslope, Small Catchment, Large Catchment, Global...*
- Temporal
  - *Short or Long Term, Resolution of Data (15 min, Hourly, Daily, Weekly, Yearly...)*
- Model Validity
  - *Models are set up for particular spatial and temporal scales*
  - *Beware of using established models outside these limits*
- Data Validity
  - *Point (sampling, drilling)*
  - *Bulk (geophysics, remote sensed, integrated (e.g. flow))*
  - *Beware of using point data for regional models*

# Fully distributed (1D-3D), semi-distributed, lumped...

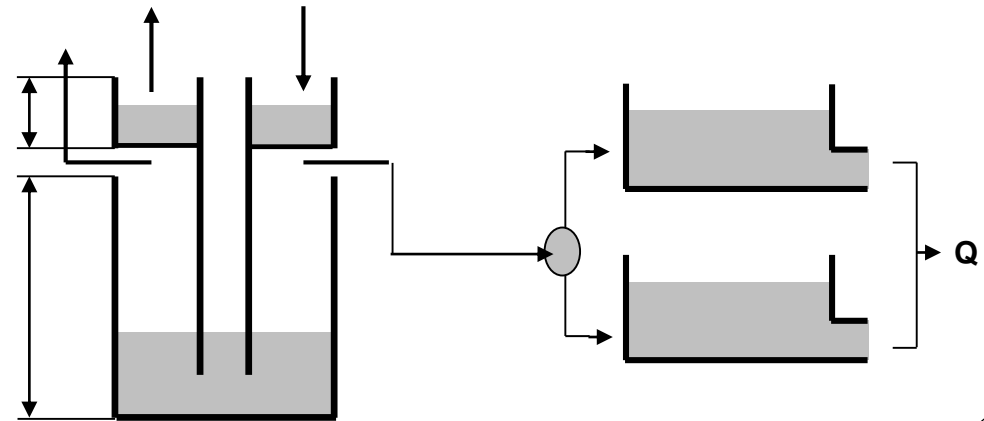
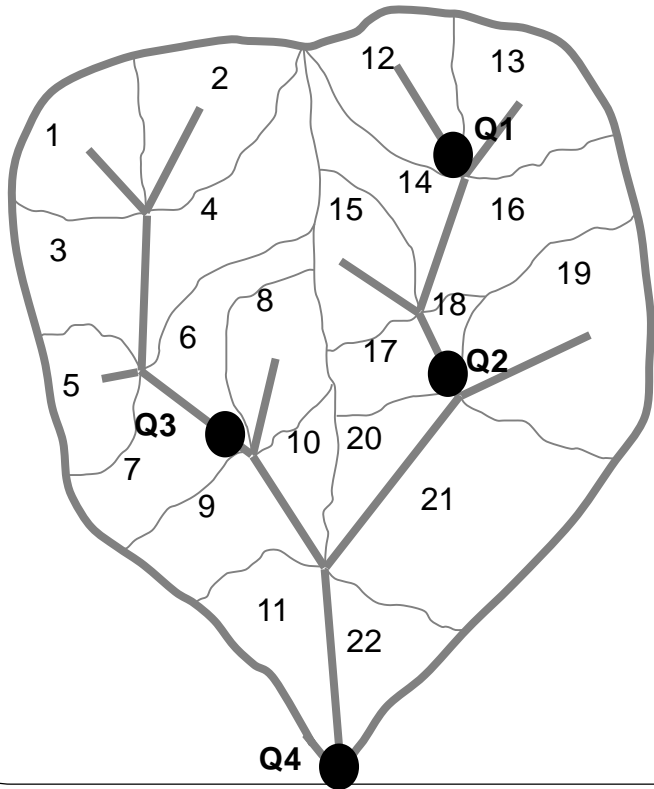
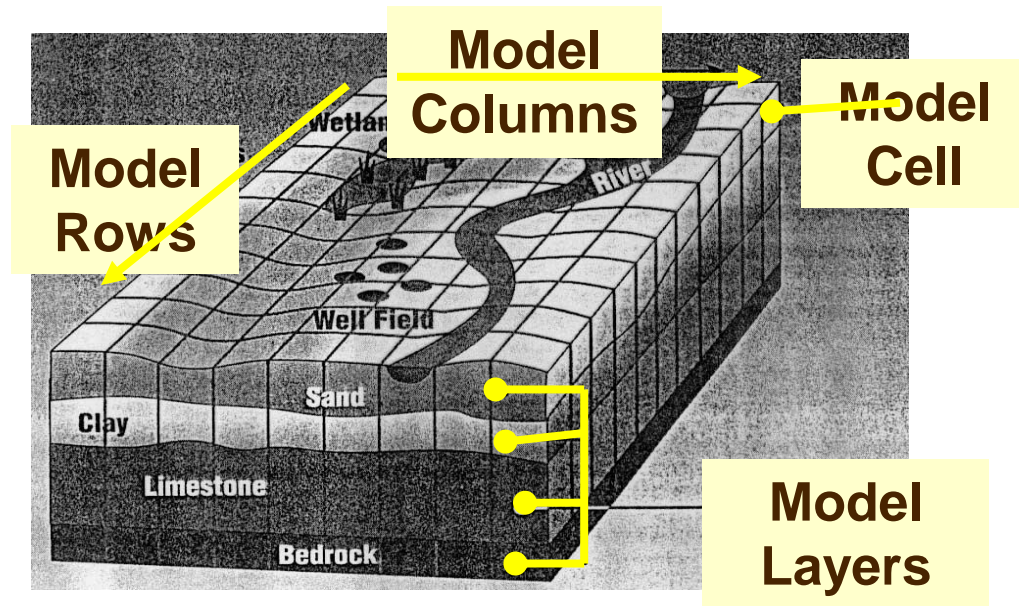

# Model components in physical systems

- inputs (  $u(t)$  )
- initial states (  $x(0)$  )
- parameters (  $\theta$  /  $\theta(t)$  )
- **model structure (  $M$  )**
- **System boundary (  $B(t)$  ),**
- states (  $x(t)$  )
- outputs (  $y(t)$  )

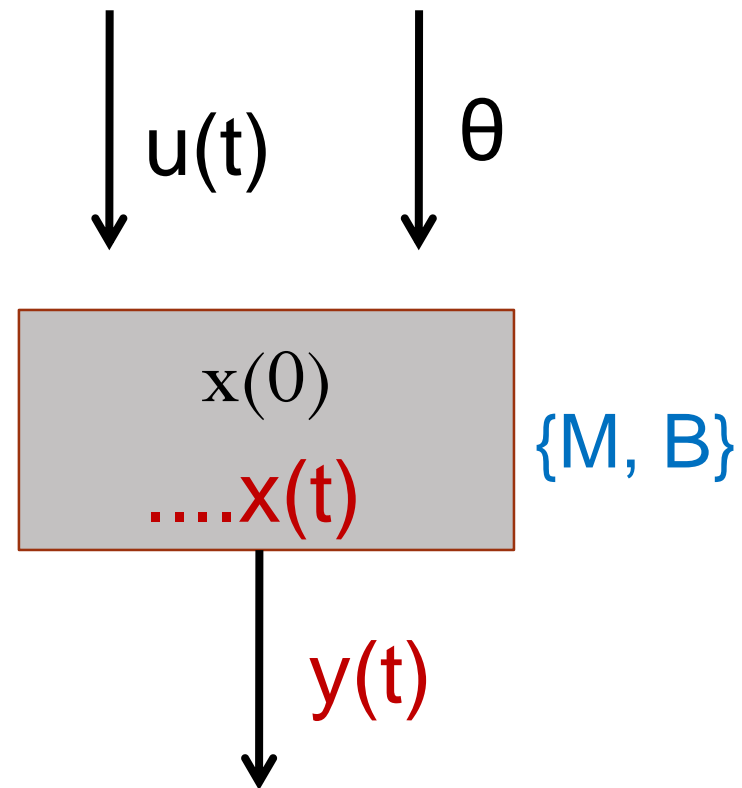



# Starting point for many models... **mass budget (and/or energy budget)**

- Always check for physical sense (structure and behaviour consistent with understanding of reality)
- Model could perform well for wrong reasons!!

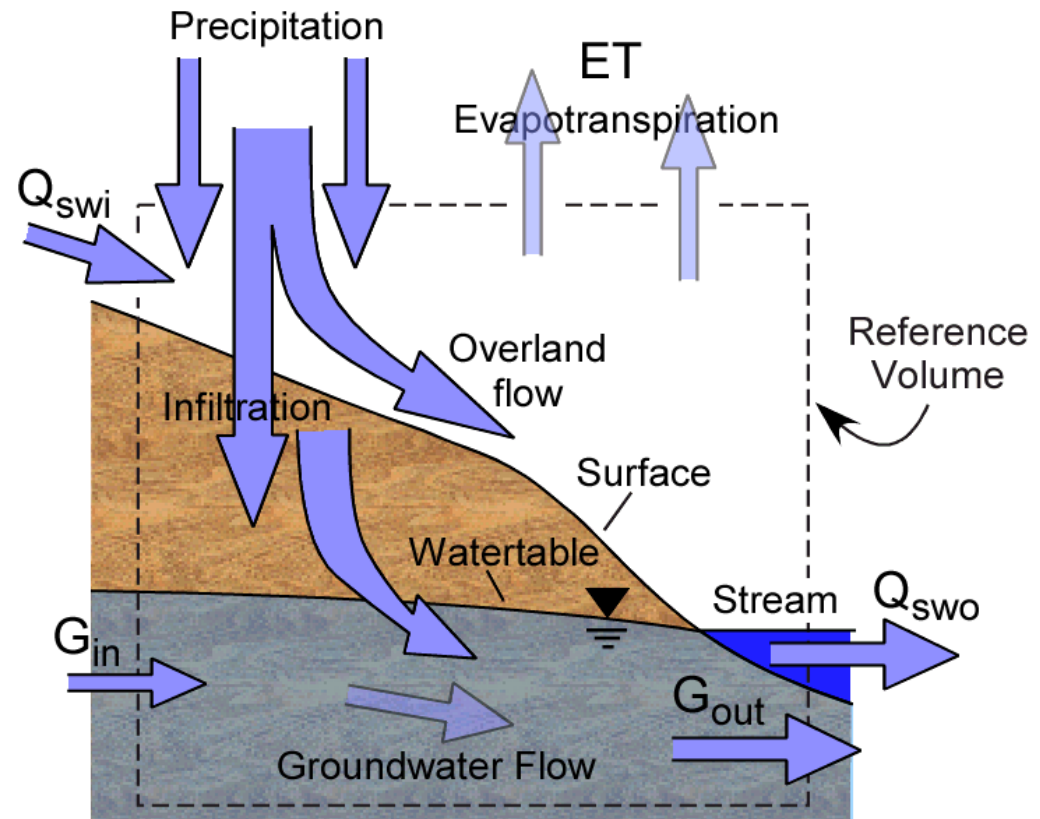

# How do we decide what constitutes a “good fit?”

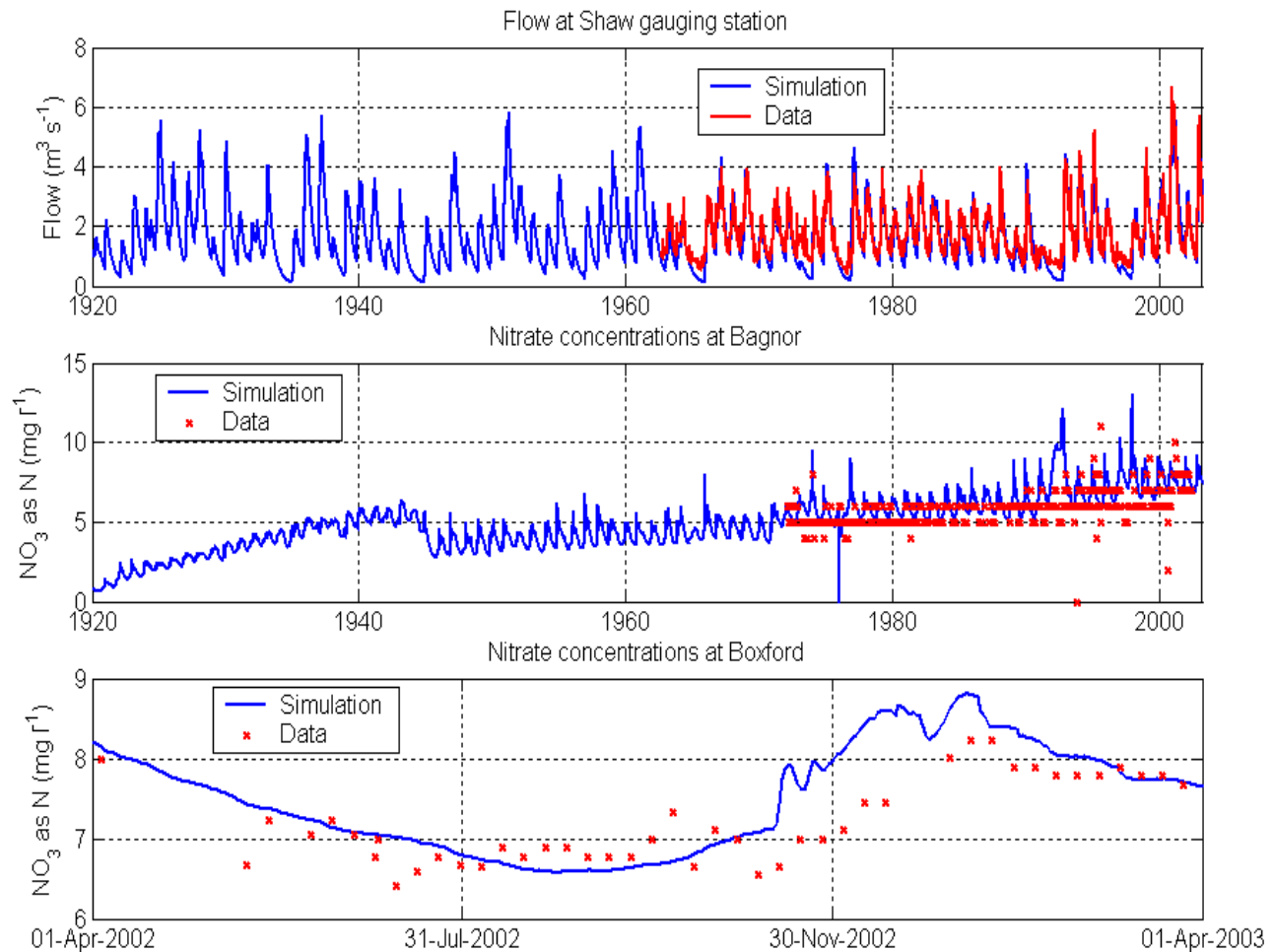

# Can group errors into three categories:

- **Data errors** (in inputs, outputs and initial conditions)
- **Parameter errors**
- **Structural errors** arising from model assumptions, omissions, approximations and implementation issues (boundary choice can be considered part of the conceptualisation process)

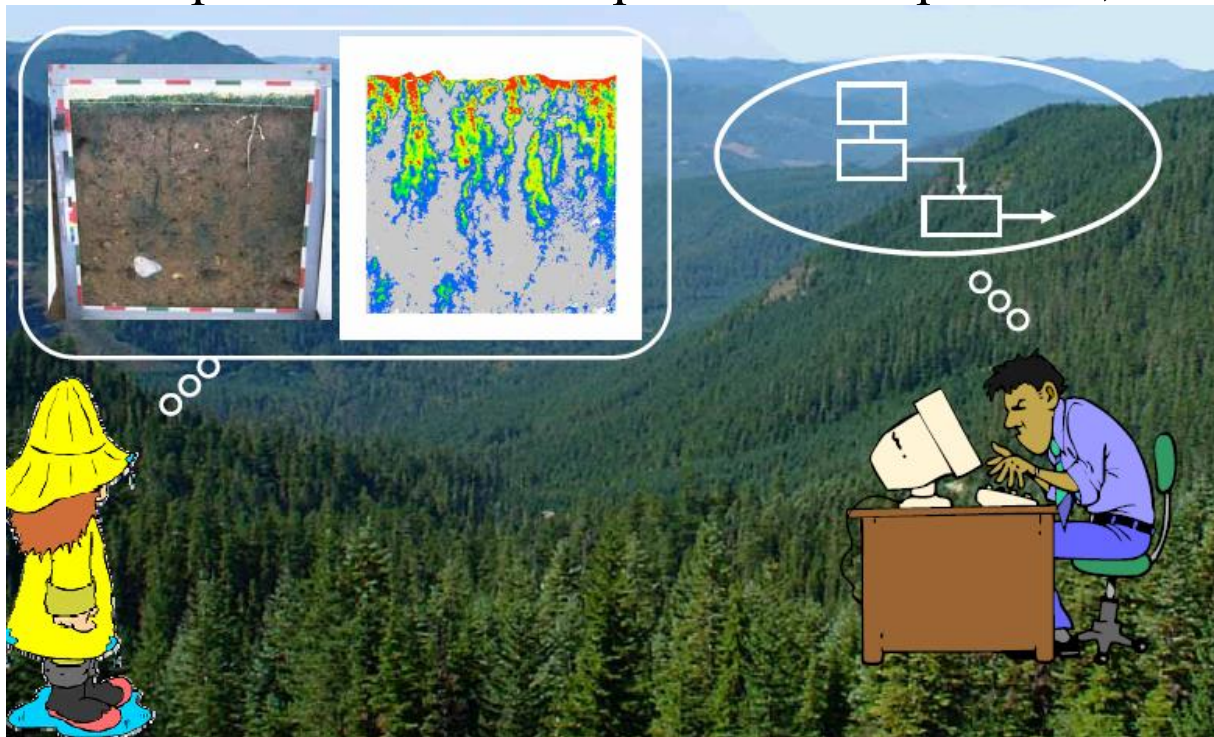

**How could we predict  
soil erosion?**

**What's important?**

**What's our conceptual  
“model”?**

LAND USE

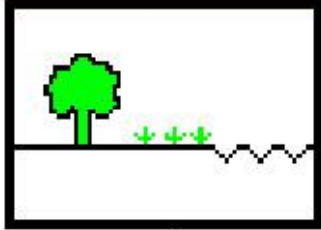

RELIEF

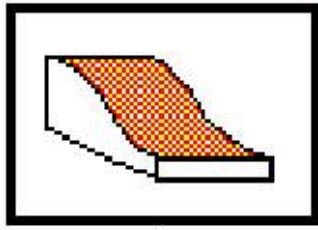

SOIL



CLIMATE



SOIL EROSION  
SENSITIVITY

SOIL EROSION  
RISK

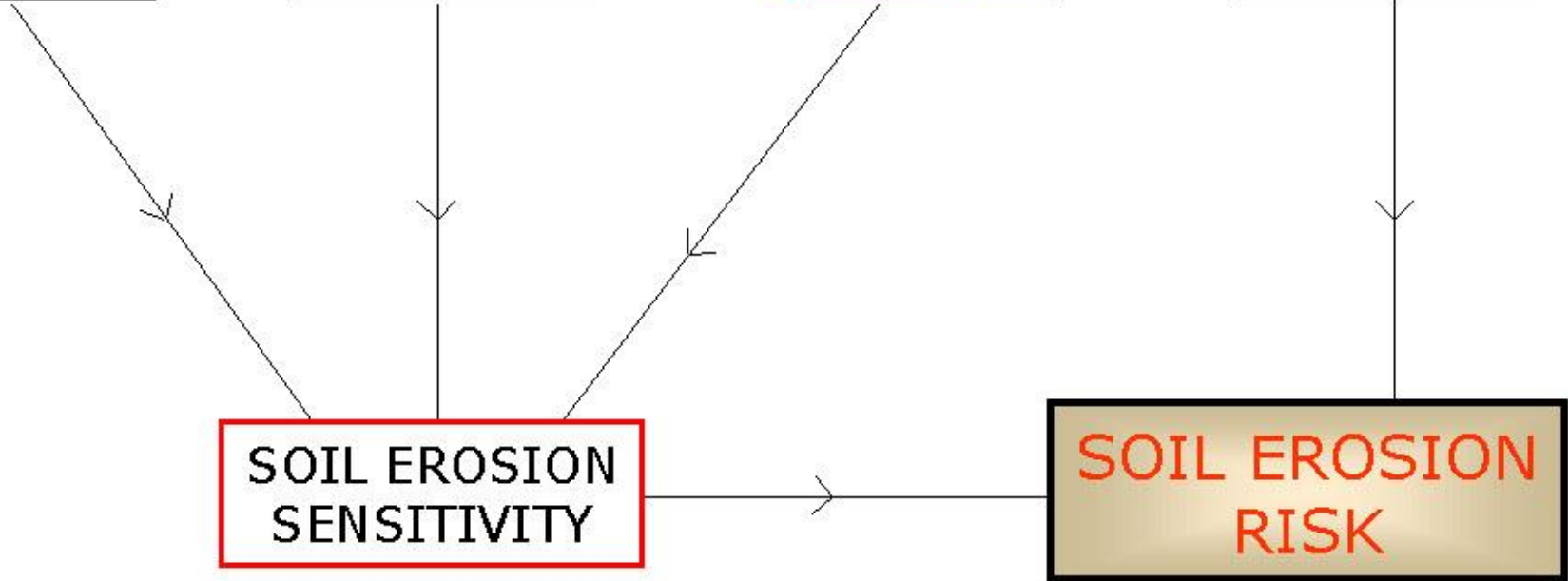

# (Revised) Universal Soil Loss Equation

Both RUSLE and USLE are expressed as:

$$A = \underline{R} * \underline{K} * \underline{LS} * \underline{C} * \underline{P}$$

Where

**A** = estimated average soil loss in tons per acre per year

**R** = rainfall-runoff erosivity factor

**K** = soil erodibility factor

**L** = slope length factor

**S** = slope steepness factor

**C** = cover-management factor

**P** = support practice factor

(See <http://www.iwr.msu.edu/rusle/> for further detail)

# Models of soil erosion by overland flow

simplified, semi-empirical  
models for special cases



realistic, process-based,  
general models

## (R)USLE2D

- detachment limited
- no deposition
- new LS based on upslope area
- standard RKCP
- standard GIS tools

## USPED

- transport capacity limited
- net erosion/deposition as  $\text{div } \mathbf{q}_s \sim \text{div } T_c \cdot s_0$
- standard RKCP, but new par. would be better
- standard GIS tools

## SIMWE

.....

- detachment through transport capacity ltd.
- continuity equation
- event based
- simplified WEPP parameters
- new tool linked to GIS

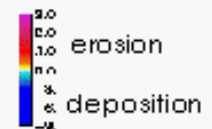
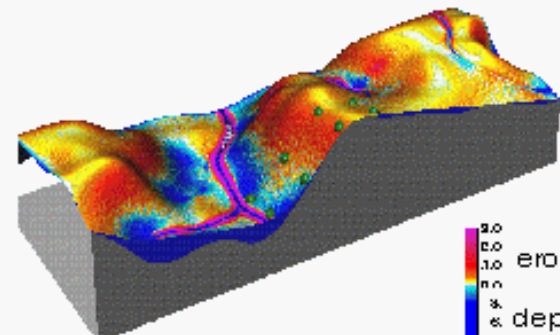
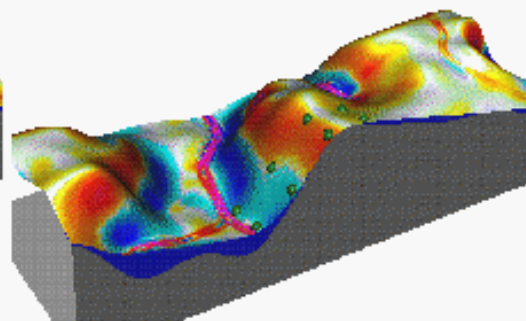
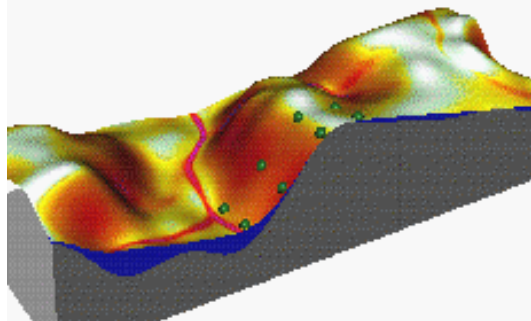

# Erosion and sediment delivery prediction (Bassenthwaite catchment, England)

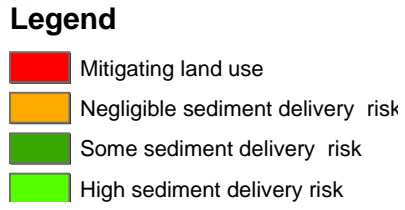
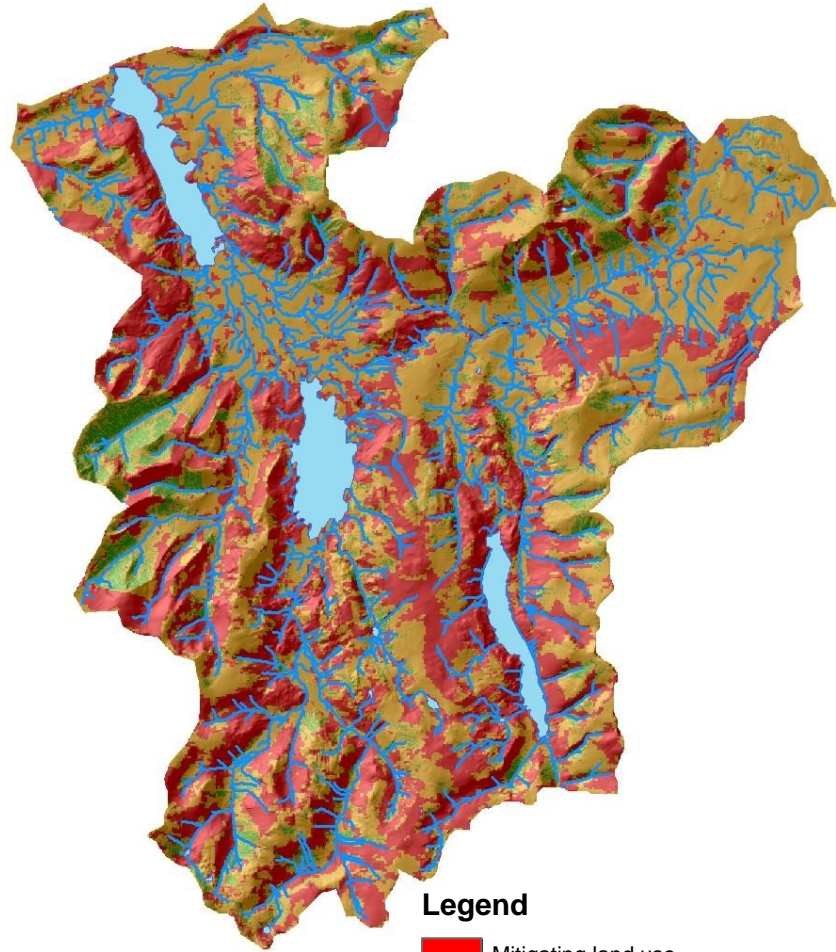
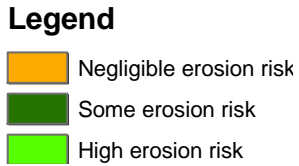



# Example: modelling sediment-related river management issues in upland fluvial systems

---



Reduced channel conveyance capacity



# Sediment-related river management issues in upland fluvial systems:

River Wharfe

2002-2004 aggradation

2050s climate scenario

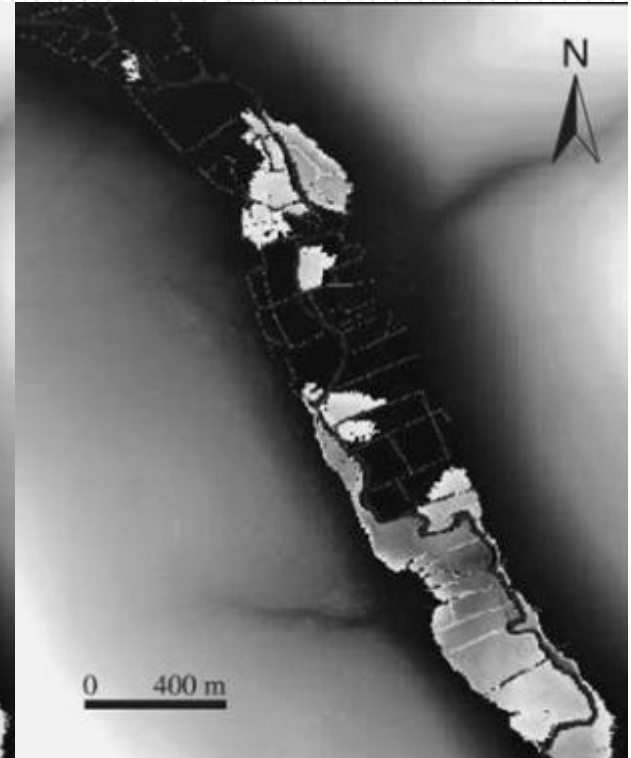
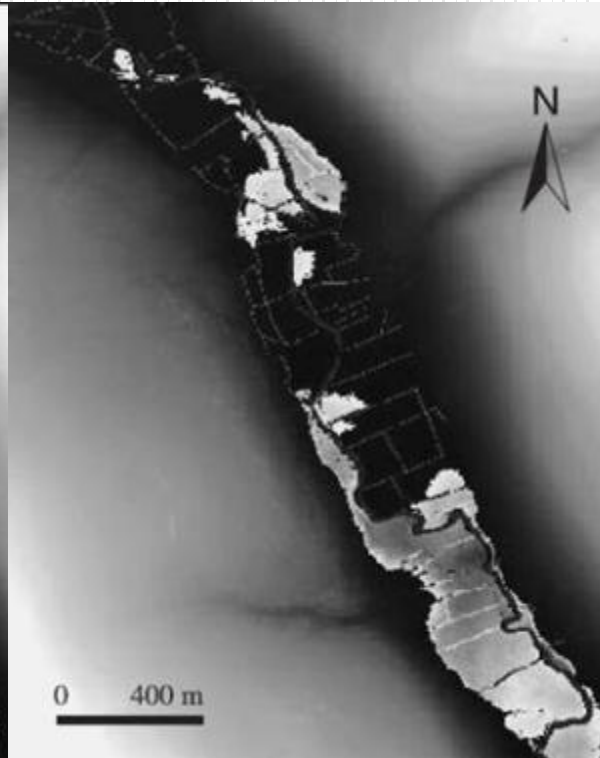
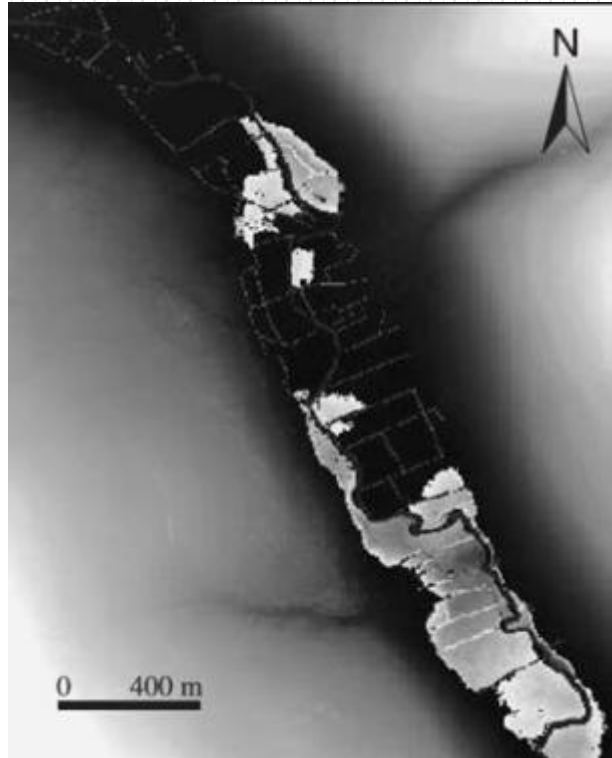

Baseline (1-in-0.5 year flood)

+5.7%

+12.2%

Upland gravel-bed river

Combined effect: +38.2%

# Mapping Wales (21,000 km<sup>2</sup>) at 5m x 5m scale: ~800 million elements

## Carbon emissions

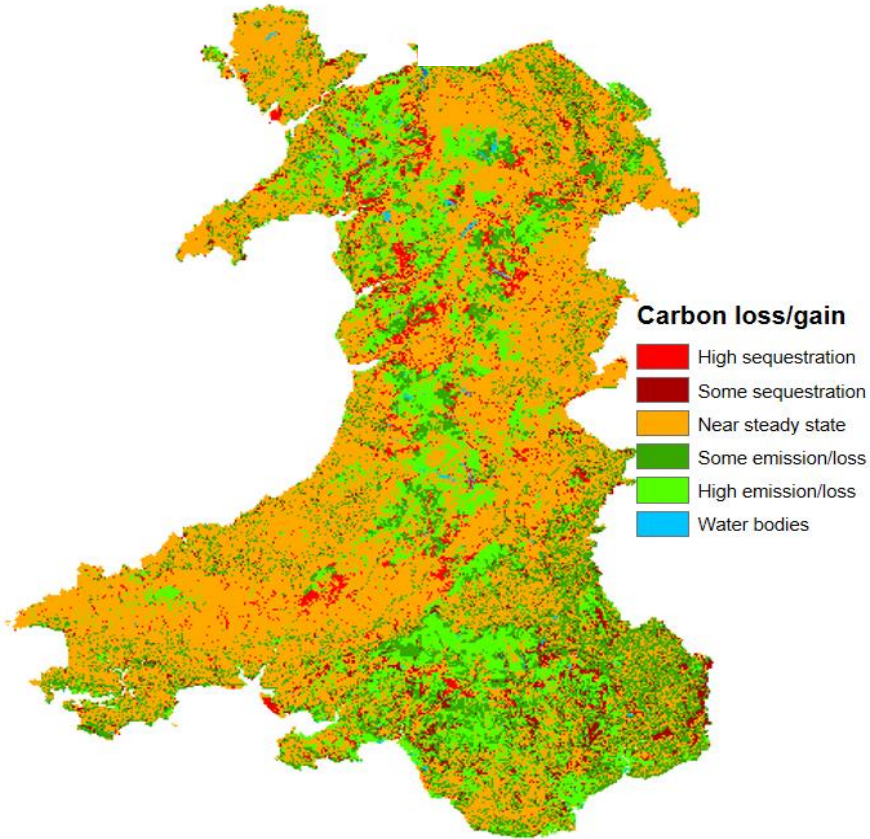

## Nitrate in rivers

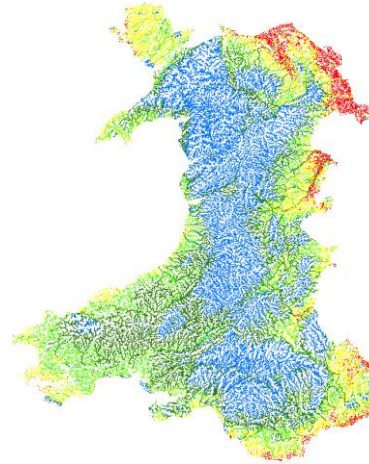

## Agricultural use

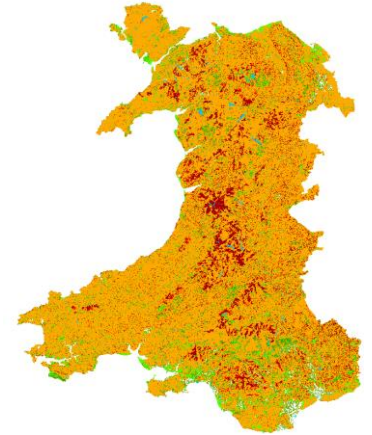

## Flood mitigation

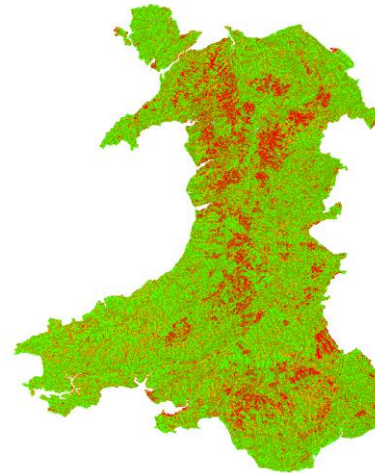

## Woodland priorities

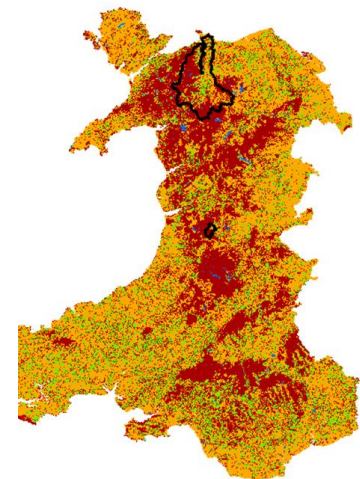

# Evaluating LUCI output e.g. Water quality

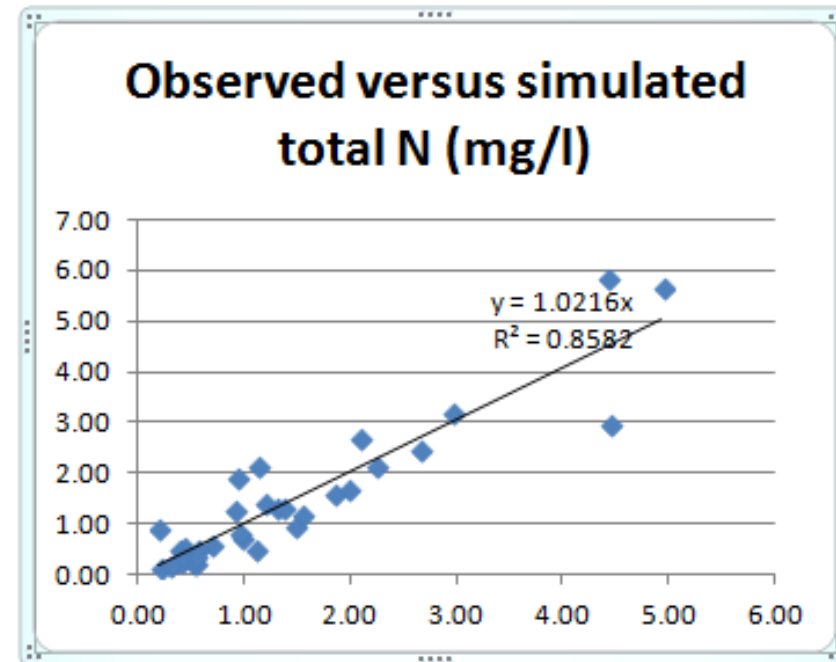
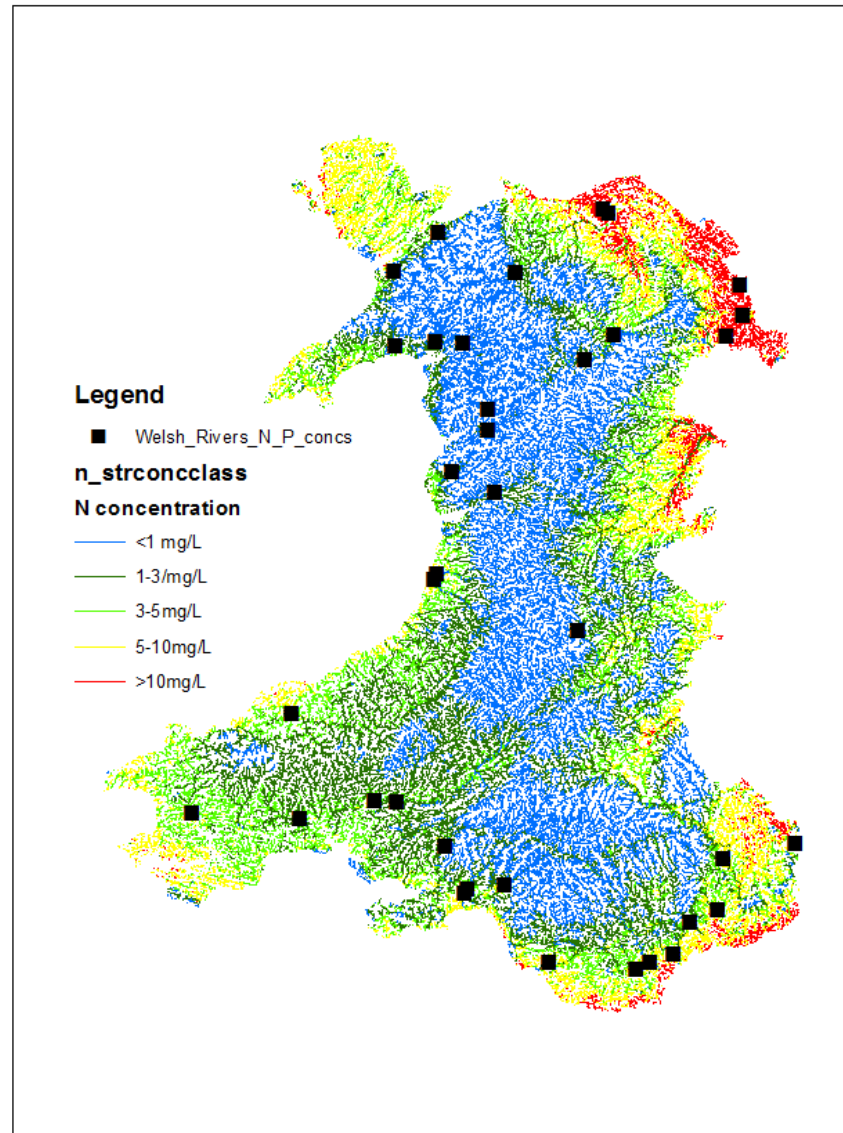

# Habitat Connectivity & Fragmentation approaches

Broadleaved  
woodland

Minimum focal  
area: **2 ha**

Maximum cost  
distance  
through hostile  
terrain: **2.5 km**

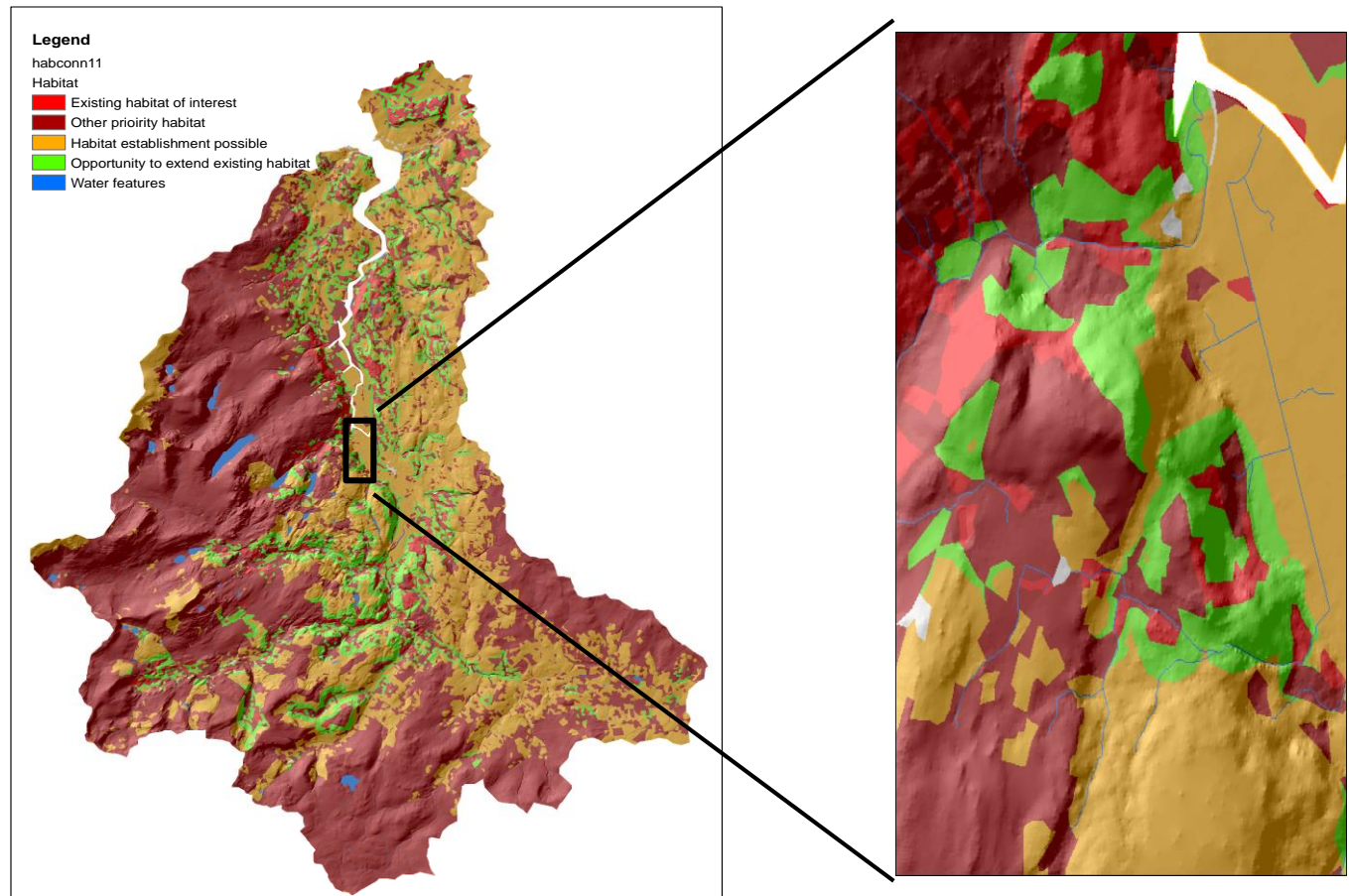

# Habitat suitability

## Legend

- Existing wading bird & other wetland habitat
- Other identified "priority habitat"
- No existing identified habitat or suitability for wading bird habitat
- Opportunities to establish additional wading bird habitat

## Legend

- Broadleaved woodland
- Other identified "priority habitat"
- Marginal gains from planting woodland
- Opportunities for enhanced connectivity of habitat

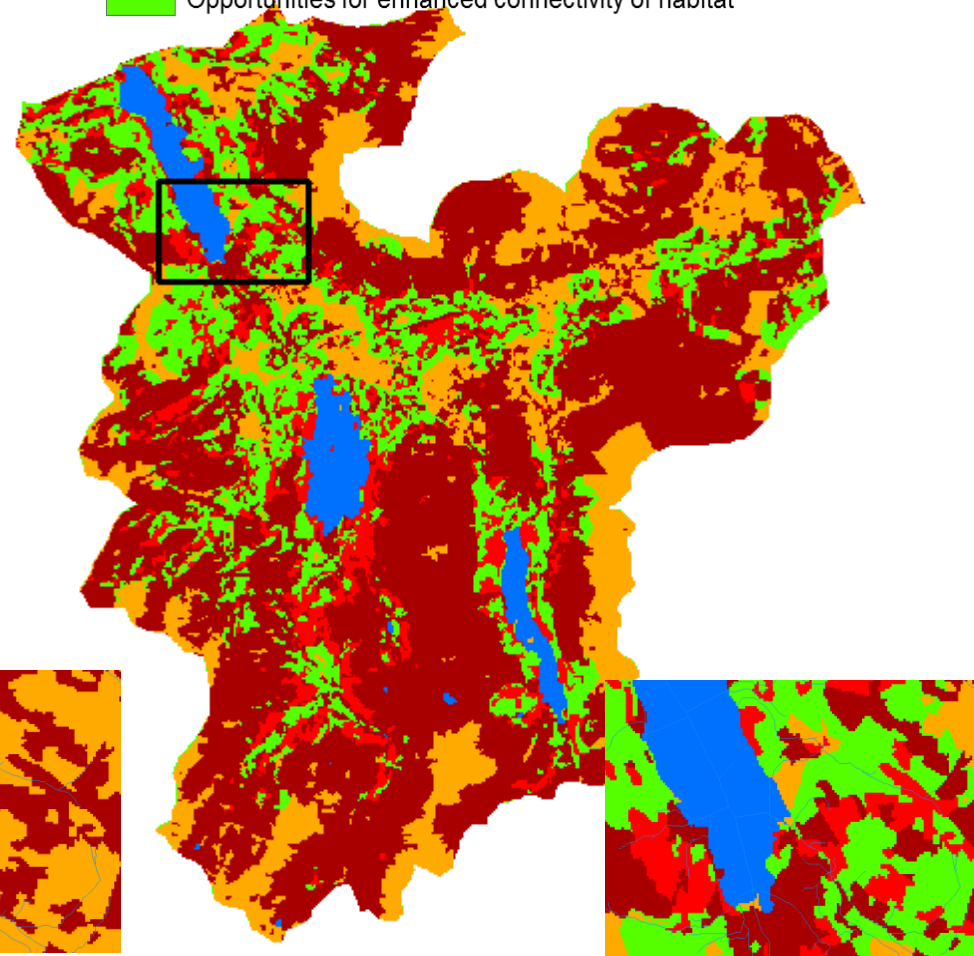
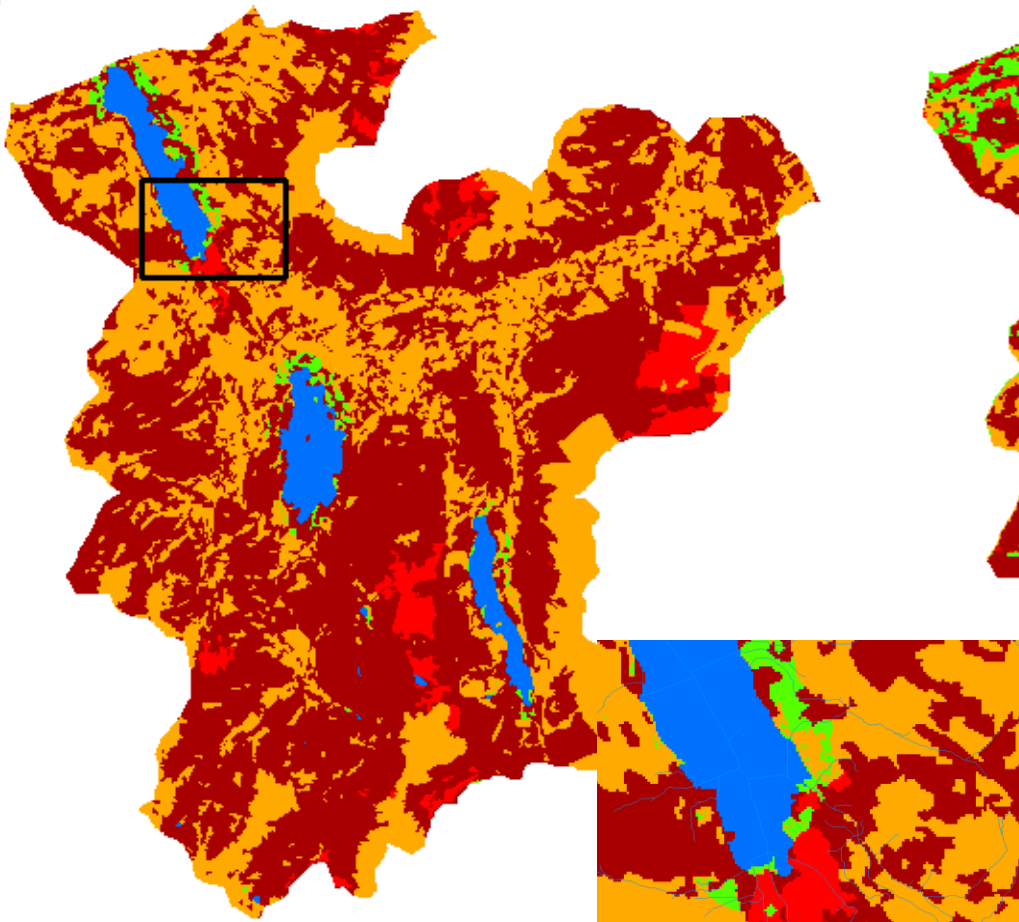

# Richness, mean patch size, diversity/evenness indices

## Mean patch size (ha)

### MEANPATCH

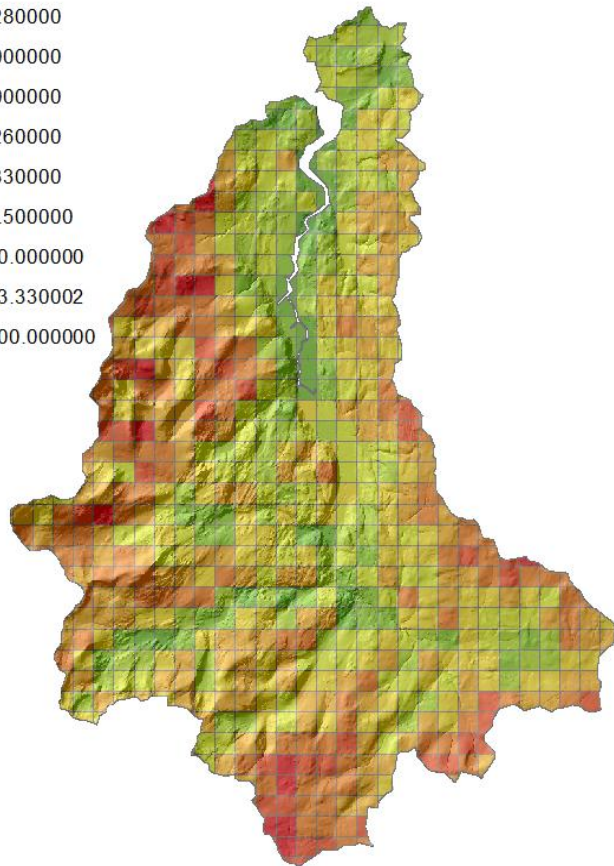
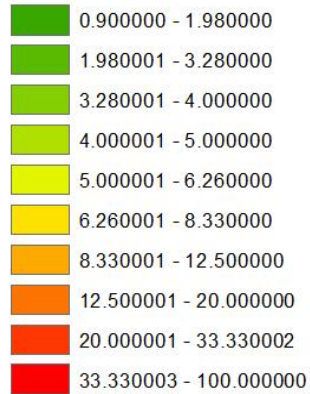

## Shannon

### Shannon indice

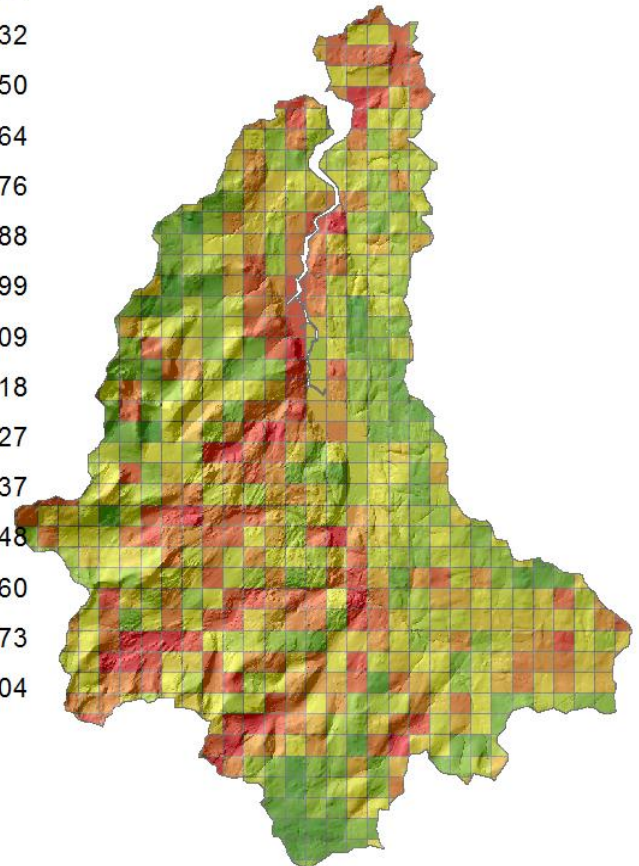
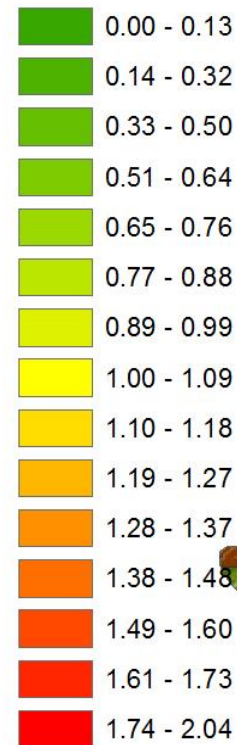

# Biodiversity: species level



## Stacked species distribution models

*Drosera rotundifolia*

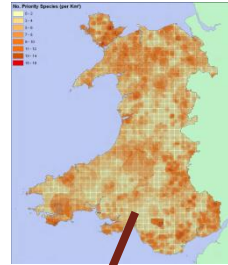
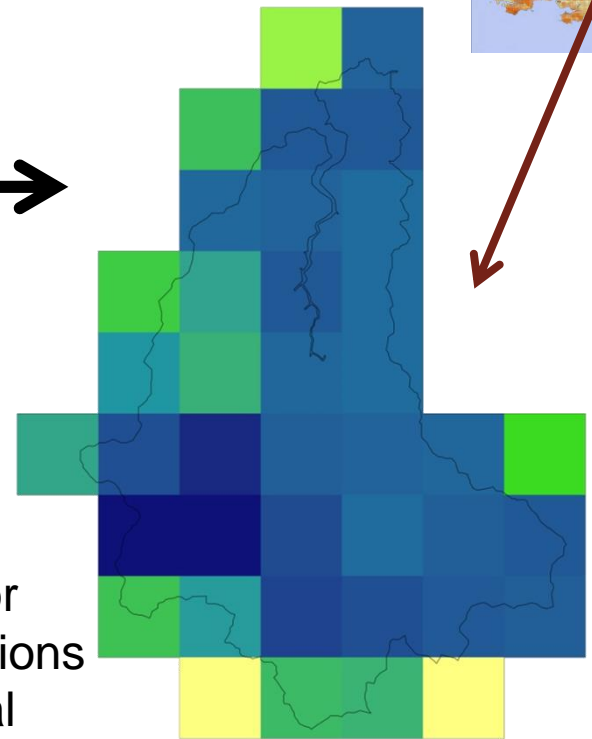
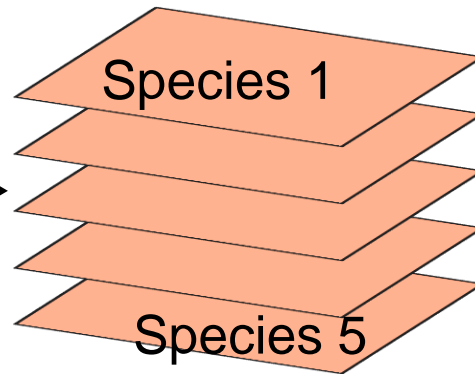
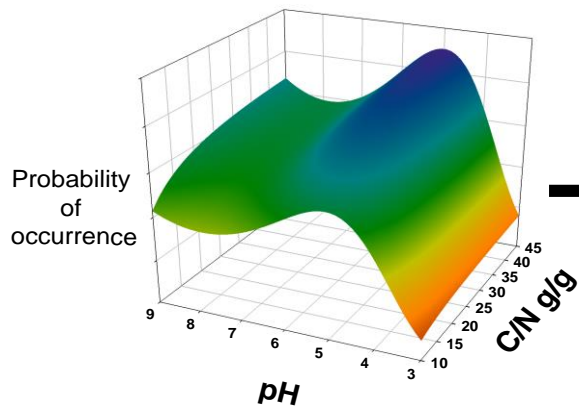

Linking to existing niche models for UK plants (Multimove) to map species richness (shown here for one catchment in Wales). Predictions of the distributions of individual species can be combined to predict total biodiversity.



# Things to remember about models

- Models are important for prediction, hypothesis testing and management. We cannot measure everywhere or “everywhen”.
- Their selection is usually based on data availability, spatial representation, computational cost, model robustness, user familiarity and user preference
- Classification is based on their structure (empirical, conceptual, physics-based, or *hybrid*), spatial representation (lumped, semi-distributed and fully distributed), spatial scale and temporal scale.
- Need to assess uncertainty in model predictions

## WARNINGS:

- Rubbish input + “good model” = rubbish out ???
- Rubbish input + rubbish model can give “correct” answer ???

# Biophysical Modelling

- Biophysical modelling can help fill data gaps
- Biophysical modelling can help estimate future conditions, services and capacity
- It supports scenario analysis
- Many biophysical models are spatial and combine data from many sources
- Geographic Information Systems (GIS) and pre-defined modelling packages have methods and formulas included
- Some models may be better than others, depending on purpose of analysis and data context