



MODELS SHOWN: HPCB48NS 48-INCH PROFESSIONAL SERIES CHIMNEY WALL HOOD AND PRD486JDGU 48-INCH PROFESSIONAL SERIES PRO GRAND® DUAL-FUEL RANGE

VENTILATION PROFESSIONAL & MASTERPIECE® SERIES

No need to worry about lingering odors or smoke with our elegant, powerful ventilation systems, featuring design accents that complement our Professional Series or our Masterpiece® Collection. These sophisticated ventilation systems remove smoke, grease and unhealthy airborne contaminants. From standard wall to specialty hoods, downdrafts, island and custom inserts, each model has one thing in common: legendary Thermador performance. These powerful, quiet systems tackle unwanted smoke, grease, heat and odors—quietly and efficiently—with ventilation power ranging from 600 to 1,300 CFM.







RANGE, RANGETOP AND VENTILATION MATRIX PROFESSIONAL SERIES

✓ = PERFECT FIT ✓ = VIABLE OPTION



		27-INCH DEPTH		
 <p>27-INCH DEPTH, 18-INCH TALL WALL HOODS</p>	36" PH36GS	✓		
	42" PH42GS	✓		
	48" PH48GS		✓	✓
	54" PH54GS		✓	✓
 <p>24-INCH DEPTH, 18-INCH TALL WALL HOODS</p>	30" PH30HS			
	36" PH36HS	✓		
	48" PH48HS		✓	✓
 <p>24-INCH DEPTH, 11-INCH TALL WALL HOODS</p>	30" HPWB30FS			
	36" HPWB36FS	✓		
	48" HPWB48FS		✓	✓
 <p>24-INCH DEPTH CHIMNEY WALL HOODS</p>	36" HPCN36NS / HPCB36NS	✓		
	48" HPCN48NS / HPCB48NS		✓	✓
 <p>ISLAND HOODS</p>	42" HPIN42HS	✓		
	48" HPIN48HS		✓	✓
 <p>CUSTOM INSERTS</p>	36" VCIN36JP / 36" VCIB36JP	✓		
	48" VCIN48JP / 48" VCIB48JP		✓	✓
	54" VCIN54JP / 54" VCIB54JP		✓	✓

For optimal performance, the width of the hood should equal that of the cooktop or rangetop or exceed it by 3 inches on either side. Install these hoods only with Thermador Blowers.





 30-INCH PRO HARMONY			 36-INCH PRO HARMONY			 48-INCH PRO HARMONY			 30-INCH RANGETOP			 36-INCH RANGETOP			 48-INCH RANGETOP		
24-INCH DEPTH						24-INCH DEPTH											
✓	✓					✓	✓										
	✓						✓										
		✓						✓									
		✓						✓									
✓						✓											
✓	✓					✓	✓										
		✓						✓									
✓						✓											
✓	✓					✓	✓										
	✓						✓										
		✓						✓									
✓	✓					✓	✓										
		✓						✓									
✓	✓					✓	✓										
		✓						✓									
		✓						✓									

COOKTOP AND VENTILATION MATRIX

MASTERPIECE® SERIES

					
		30-INCH INDUCTION	36-INCH INDUCTION/ FREEDOM® INDUCTION	30-INCH GAS COOKTOP	36-INCH GAS COOKTOP
 WALL HOODS	30" HMWN30FS	✓		✓	
	48" HMWN48FS		✓		✓
 WALL HOODS WITH BLOWER	30" HMWB30FS	✓		✓	
	36" HMWB36FS	✓	✓	✓	✓
 CHIMNEY WALL HOODS	36" HMCN36FS	✓	✓	✓	✓
	42" HMCN42FS		✓		✓
 CHIMNEY WALL HOODS WITH BLOWER	36" HMCB36FS	✓	✓	✓	✓
	42" HMCB42FS		✓		✓
 DRAWER HOOD WITH BLOWER	36" HDDW36FS	✓	✓	✓	✓
 ISLAND HOODS WITH BLOWER	40" HMIB40HS	✓	✓	✓	✓
	42" HPIB42HS	✓	✓	✓	✓
	48" HPIB48HS*		✓		✓
 CUSTOM INSERTS	30" VCI230DS†	✓		✓	
	36" VCI236DS†	✓	✓	✓	✓
	48" VCI248DS†		✓		✓
 DOWNDRAFTS	30" UCVM30FS	✓		✓	
	36" UCVM36FS		✓		✓

For optimal performance, the width of the hood should equal that of the cooktop or rangetop or exceed it by 3 inches on either side. Install these hoods only with Thermador Blowers.
 *Compatible with cooktops of widths up to 42" †Also compatible with Pro Grand Ranges, Pro Harmony Ranges and Professional Rangetops.

			
30-INCH ELECTRIC COOKTOP	30-INCH SENSOR ELECTRIC COOKTOP	36-INCH ELECTRIC COOKTOP	36-INCH SENSOR ELECTRIC COOKTOP
✓	✓		
		✓	✓
✓	✓		
✓	✓	✓	✓
✓	✓	✓	✓
		✓	✓
✓	✓	✓	✓
		✓	✓
✓	✓	✓	✓
✓	✓	✓	✓
✓	✓	✓	✓
		✓	✓
✓	✓		
✓	✓	✓	✓
		✓	✓
✓	✓		
		✓	✓

BLOWER SELECTION AND DUCT GUIDE PROFESSIONAL SERIES

Type	Model No.	Available Sizes (Widths)	Blower Information			Model No.	Total Amps @ 120 Volts, 60 Hz	
			CFM	Remote	In-line			Integrated
WALL HOODS	PH_GS	36" / 42" / 48" / 54"	600			•	VTN630N	10.3
			1000			•	VTN1030N	13.6
			600	•			VTR630D	12.1
			1000	•			VTR1030D	14.0
			1300	•			VTR1330E	17.5
	HPWB_FS	30" / 36" / 48"	600		•		VTI610D	12.1
			1000		•		VTI1010D	14.0
			600			•	Included	3.4
			1200			•	Included	10.2
			600	•			VTR630D	6.9
	PH_HS	30" / 36" / 48"	1000	•			VTR1030D	8.8
			1300	•			VTR1330E	12.3
			600		•		VTI610D	6.9
			1000		•		VTI1010D	8.8
			600			•	VTN630N	5.0
CHIMNEY WALL HOODS	HPCN_NS	36" / 48"	1000			•	VTN1030N	8.4
			600	•			VTR630D	6.9
			1000	•			VTR1030D	8.8
			1300	•			VTR1330E	12.3
			600		•		VTI610D	6.9
HPCB_NS	36" / 48"	1000			•	VTN1080N	12.7	
		600	•			VTR630D	6.9	
		1000	•			VTR1030D	8.8	
		1300	•			VTR1330E	12.3	
		600		•		VTI610D	6.9	
ISLAND HOODS	HPIN_HS	42" / 48"	1000			•	VTI1010D	8.8
			600		•		VTN630N	5.0
			1000			•	VTN1030N	8.4
			600	•			VTR630D	6.9
			1000	•			VTR1030D	8.8
CUSTOM INSERTS	VCIB_JP	36" / 48" / 54"	1300	•			VTR1330E	12.3
			600		•		VTI610D	6.9
			1000		•		VTI1010D	8.8
			1000			•	Included	12.7
			600	•			VTR630D	6.9
VCIN_JP	36" / 48" / 54"	1000	•			VTR1030D	8.8	
		1300	•			VTR1330E	12.3	
		600		•		VTI610D	6.9	
		1000		•		VTI1010D	8.8	
		600			•	VTN630N	10.3	
			1000			•	VTN1030N	13.6

MASTERPIECE® SERIES

WALL HOODS	HMWN_FS	30"	600			•	VTN600F	4.6
			600	•			VTR630D	4.3
			1000	•			VTR1030D	7.8
			600		•		VTI610D	5.8
			1000		•		VTI1010D	7.6
	HMWB_FS	30" / 36"	600			•	VTN600F	4.6
			1000			•	VTN1000F	8.8
			600	•			VTR630D	4.3
			1000	•			VTR1030D	7.8
			1300	•			VTR1330E	9.2
CHIMNEY WALL HOODS	HMCN_FS	36" / 42"	600		•		VTI610D	5.8
			1000		•		VTI1010D	7.6
			600	•			Included	4.9
			600	•			Included	4.9
			600	•			Included	5.2
ISLAND HOODS	HPIB_HS	42" / 48"	600			•	Included	5.2
			600	•			VTR630D	5.2
CUSTOM INSERTS	VCI2_DS	30" / 36" / 48"	1000	•			VTR1030D	7.8
			1300	•			VTR1330E	9.5
			600		•	•	VTI610D	5.8
			1000		•	•	VTI1010D	7.6
DOWNDRAFT	UCVM_FS	30" / 36"	600			•	VTN600CV2C	6.7
			600	•			VTR630D	6.7
			1000	•			VTR1030D	10.2
			600		•		VTI610D	5.8
			1000			•	VTI1010D	7.6

*Purchase separately at most hardware stores, unless otherwise indicated with a Thermador model number.

BLOWER OPTIONS AND PRESSURE CURVES

INTEGRATED (MOUNTED IN HOOD)

VTN600CV2C – 600 CFM

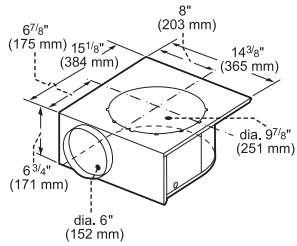
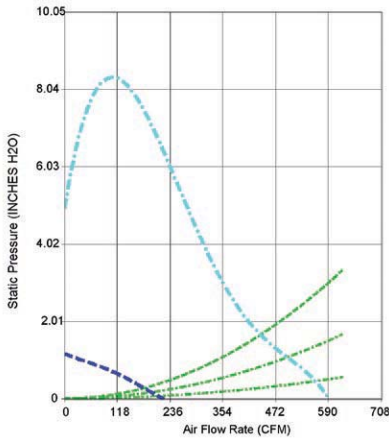

measurements in inches and mm

VTN600F – 600 CFM

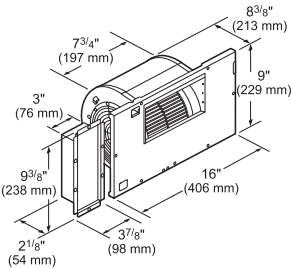
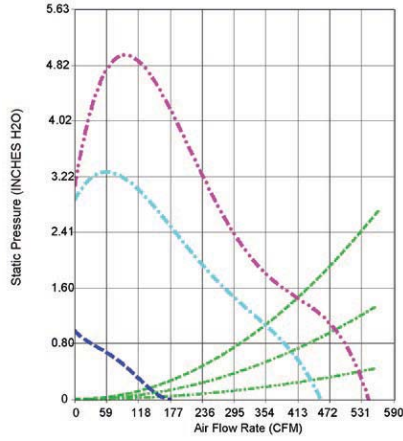

measurements in inches and mm

VTN630N – 600 CFM

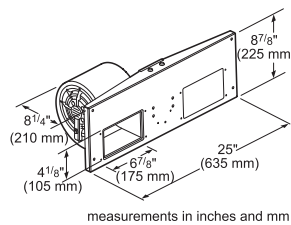
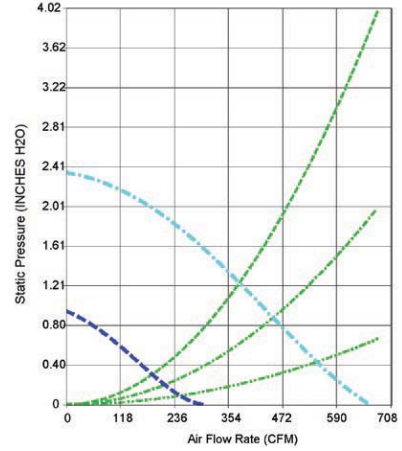

measurements in inches and mm

VTN1080N – 1000 CFM

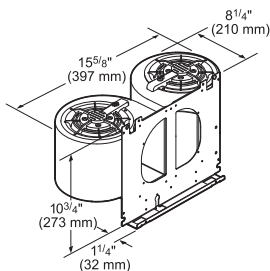
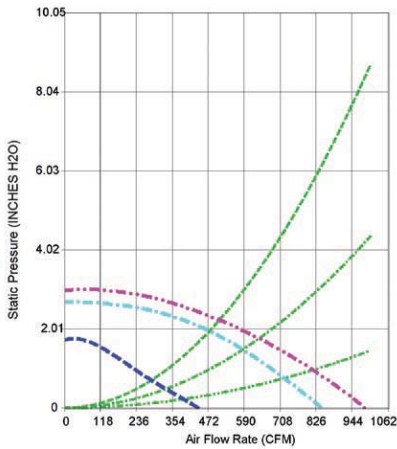

measurements in inches and mm

VTN1000F – 1000 CFM

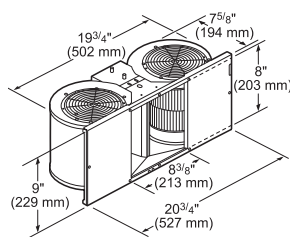
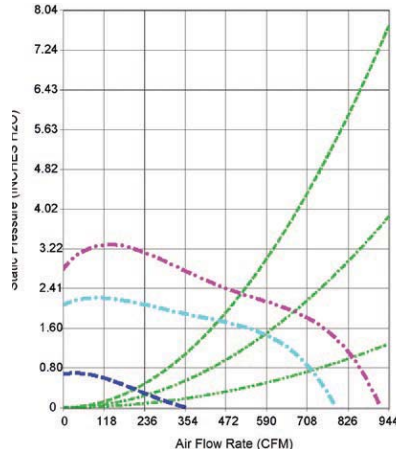

measurements in inches and mm

VTN1030N – 1000 CFM

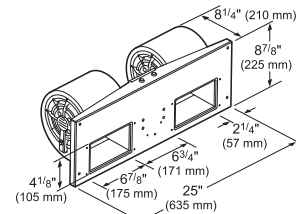
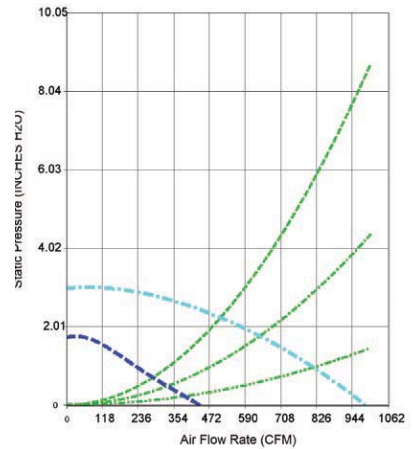

measurements in inches and mm

BLOWER OPTIONS AND PRESSURE CURVES

REMOTE (MOUNTED TO ROOF OR EXTERNAL WALL)

VTR630D – 600 CFM

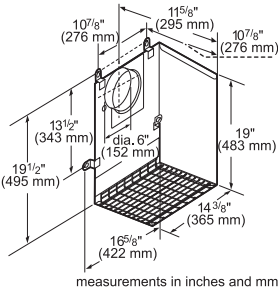
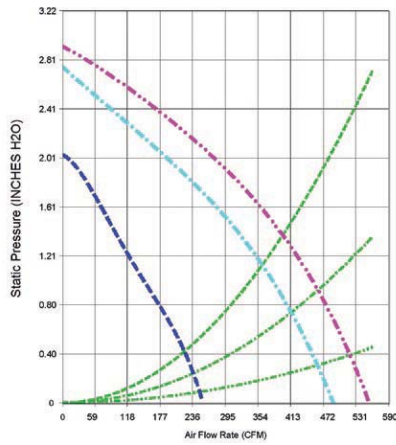

VTR1030D – 1000 CFM

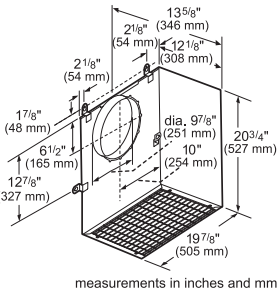
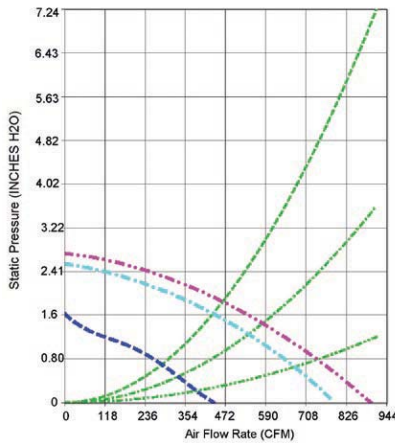

VTR1330E – 1300 CFM

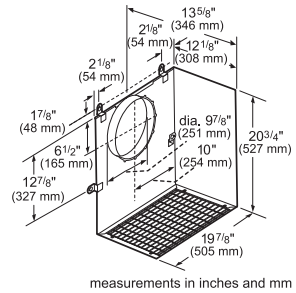
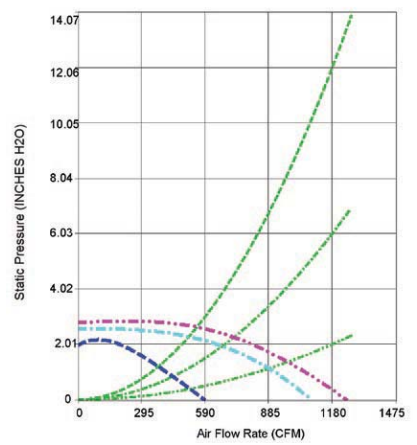

INLINE (MOUNTED BETWEEN KITCHEN AND EXTERNAL WALL)

VTI610D – 600 CFM

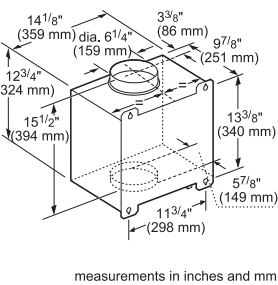
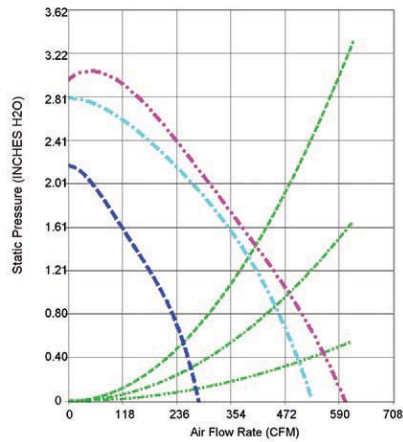



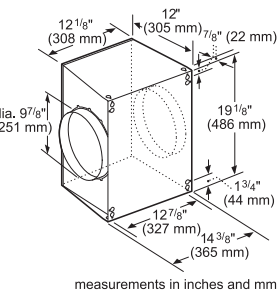
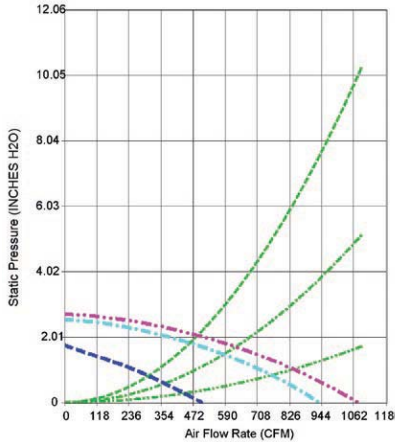





VTI1010D – 1000 CFM





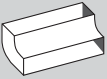
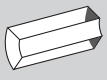







- Speed 1
- - - Speed 3
- · · Speed 4
- - - Ø 4"
- - - Ø 5"
- - - Ø 6"

NOTE: All measurements are made with 3 ft. straight duct, 90° bend followed by 1 ft. straight duct. These are NOT free blowing measurements.

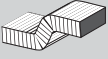
EQUIVALENT DUCT LENGTHS FOR COMMONLY USED TRANSITIONS

DUCT PIECE	SIZE OF DUCT PIECE (IN.)	EQUIVALENT LENGTH (FT.)
 Smooth Straight	6	1.2
	7	0.95
	8	0.7
	10	0.6
 3 1/4" x 10" Straight	N/A	1
 3 1/4" x 14" Straight	N/A	0.7
 90° Elbow Round	6	12
	7	8
	8	6
 45° Elbow Round	6	5
	7	4
	8	3
 3 1/4" x 10" 90° Elbow Round	N/A	5
 3 1/4" x 10" 45° Elbow Round	N/A	15
 3 1/4" x 10" Flat Elbow	N/A	20
 Round to 3 1/4" x 10"	6	1
	7	1
 3 1/4" x 10" to Round	6	5
	7	3
 Round to 3 1/4" x 10" 90° Elbow	6	10
	7	8

DUCT PIECE	SIZE OF DUCT PIECE (IN.)	EQUIVALENT LENGTH (FT.)
 3 1/4" x 10" to Round 90° Elbow	6	10
	7	5
 3 1/4" x 10" Center Reverse Elbow Left	N/A	15
 3 1/4" x 10" Center Reverse Elbow Right	N/A	25
 3 1/4" x 10" Left Reverse Elbow	N/A	15
 3 1/4" x 10" Right Reverse Elbow	N/A	25
 Round Wall Cap	6	2
	7	2
	8	2
	10	2
 Round Roof Cap	6	2
	7	2
	8	2
 2' Long 3 1/4" x 10" Flex	N/A	20
 3 1/4" x 10" to Round	10	1
 7" Inline Backdraft Damper	7	
 3 1/4" x 10" Roof Jack and Shutter	N/A	

NOTE: These commonly used installation parts can be purchased at a local hardware store. Thermador does not manufacture all these parts.

VENTILATION HOODS THAT FIT WITH YOUR KITCHEN

When selecting a ventilation system, choose from one of our two sophisticated appliance collections. Select Professional Series for the ultimate in cooking and venting power or the Masterpiece Series for its sleek styling and numerous convenience functions.



WALL HOODS

Wall hoods offer exceptional, quiet performance and distinctive design options.

- Efficient, high quality, all stainless steel filters
- Halogen lighting
- Deep enclosure area for excellent capture
- Removable dishwasher-safe grease collection tray
- Recirculation option at 600 CFM



CHIMNEY WALL HOODS

Our chimney style wall hoods create a dramatic focal point in the kitchen.

- Adjustable chimney heights suit a range of ceilings
- All stainless steel or stainless steel with glass designs available
- Halogen lighting
- Dishwasher-safe, stainless steel frame filters
- Automatic Clean Filter Reminder light



ISLAND HOODS

Thermador Island Hoods offer excellent overall efficiency in drawing away smoke, moisture and heat.

- An option for when a wall surface is not available
- Dishwasher-safe, stainless steel filters
- Slim and sleek design that does not obstruct the views beyond your kitchen
- Halogen lighting
- All stainless steel or stainless steel with elegant glass canopy design



CUSTOM INSERTS

To create a seamless design with wall or island applications, use custom hood inserts.

- Available options for all types of cooking surfaces
- User-friendly ventilation controls or remote control options
- Wall or island applications
- Halogen lighting



DOWNDRAFTS

Downdraft ventilation offers space efficiency and a sleek look for non-professional cooktops.

- Over 13-inch intake
- Full-face filter combines a filter with splatter shield in one easy-to-remove, dishwasher-safe element
- Ideal in island applications
- 600 CFM recirculation kit option with integrated blower is available for difficult-to-duct situations



MODELS SHOWN: PH48HS WALL HOOD AND PRG486GDH PRO HARMONY RANGE AND PA12CVRJ GRIDDLE COVER ACCESSORY

VENTILATION WALL HOODS

Thermador Wall Hoods put the finishing touch on your cooking system, with deep capture areas for the best overall efficiency in drawing away smoke, moisture and heat. These elegant hoods combine style with vigorous performance, generating ventilation power from 600 to 1,300 CFM. Available in a variety of heights, widths and depths, they accommodate your individual venting needs. All models include brilliant halogen lighting for enhanced visibility and convenient speed controls. For ultra-simple cleanup, the removable filters and grease collection trays fit easily in your dishwasher.

WALL HOODS FEATURES & BENEFITS



HALOGEN LIGHTS

Bright halogen lighting spotlights your best recipes.

DELAYED SHUT-OFF

For the greatest efficiency, our Professional ventilation models include delayed shut-off to tackle lingering odors. (Except HMWB30FS, HMWB36FS)

POWERFUL VENTILATION

Breathe deeply with the air-freshening power of up to 1,300 CFM. Our HPWB Series Professional Hood now has blower included for ease of installation.

TIME-TO-CLEAN-FILTER LIGHT

Easy cleanup: all Thermador ventilation filters are dishwasher-safe, and many hoods feature a built-in Time-to-Clean-Filter reminder light. (Except HMWB30FS, HMWB36FS)



BAFFLE FILTERS

Unique low-profile, commercial-style baffle filters maximize grease capture without affecting flow, and they're dishwasher-safe for easy cleanup.

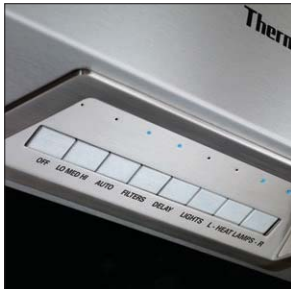

EXTERIOR CONTROLS

Easy-to-clean, easy-to-use push-button controls put accuracy at your fingertips.



KEEP-HOT SHELF

Hold dishes at serving temperature on our optional Keep-Hot Shelf. (Perfect for PH36GS, PH42GS, and PH48GS)

PLANNING INFORMATION

MODEL OPTIONS

When selecting a ventilation system, choose from one of our two sophisticated appliance collections. Select Professional Series for the ultimate in cooking and venting power or the Masterpiece Series for its sleek styling and numerous convenience functions. Thermador Wall Hoods are available in various depths and heights to fit your kitchen plans and are meticulously crafted for both function and design. Be sure to reference the correct model information in this design guide.

ELECTRICAL SPECIFICATIONS

Be sure your Thermador Wall Hood is properly installed and grounded by a qualified technician. Installation, electrical connections and grounding must comply with all applicable local codes.

Install a suitable conduit box (not furnished). An appropriately-sized, UL-listed conduit connector must be used to correctly attach the conduit to the junction box. Remote blowers require a 5-wire installation.

MODEL	REQUIRED CIRCUIT BREAKER
	120V AC, 60 Hz
PH36GS, PH42GS, PH48GS, PH54GS	15 or 20 Amp
PH30HS, PH36HS, PH48HS	15 or 20 Amp
HPWB30FS, HPWB36FS, HPWB48FS	15 or 20 Amp
HMWN30FS, HMWN48FS	15 or 20 Amp
HMWB30FS, HMWB36FS	15 or 20 Amp

WALL HOODS

PLANNING INFORMATION

INSTALLATION CONSIDERATIONS

The information in this design guide provides key features, product dimensions, cutouts and installation specifications. Before installing a Thermador Wall Hood, be sure to verify the cutout dimensions and electrical connections. Also, always consult with the installation manual packed with the product for complete details before installing.

Thermador Wall Hoods may be installed above a Thermador Cooktop or Range to create a convenient cooking center. Refer to the appropriate section for additional specifications.

HOOD WIDTH

The hood width should be no less than the width of the cooking surface. Where space is not restricted, a wider hood can be used to increase your capture area.

DISTANCE FROM COOKING SURFACE

Proper mounting height is very important. If a hood is mounted too low, it may be difficult to cook and be unsafe. If a hood is mounted too high, performance may be compromised. For optimal performance, the distance from the cooking surface to the bottom of the hood should be a minimum of 30", unless otherwise noted. Please refer to the installation manual for each hood and cooktop / range model for proper hood mounting heights.

AVAILABLE CEILING HEIGHT

The standard ceiling height can vary from region to region and in homes built in different eras. Ceiling heights, even in the same room, can sometimes vary by as much as several inches. Kitchen ceiling heights can vary between 7'6" (or 90") to over 10' (or 120").

Before selecting a Thermador Hood, check the available installation space and any extra space that may remain after proper installation of a hood and cooktop or range. This extra space can be filled using Thermador's stainless steel duct cover accessories or integrated with kitchen cabinetry. The space can also be adjusted by raising or lowering your hood within the recommended range (typically 30" to 36" above the cooking surface).

CHOOSING THE CORRECT BLOWER

A variety of interior and exterior blower options (Remote, Inline or Integrated) are available for Thermador's Professional and Masterpiece Series Hoods. If the unit you have selected does not have a blower, one can be purchased separately. Blower selection will vary based on the volume of air that needs to be moved and the length and location of the duct run. For long duct runs with multiple turns and bends, consider using a more powerful blower. For the most efficient air flow exhaust, use a straight run or as few elbows as possible.

Remote Blowers (VTR Series)

Depending on your preference and ducting situation, these blowers can be mounted on the roof or exterior wall of your home. An exterior installation may be more appealing to reduce noise in the kitchen.

Inline Blowers (VTI series)

To minimize noise in the kitchen, these blowers are mounted along the duct line anywhere between the kitchen and the exterior wall. If you have easy access to your duct line (in an attic, for example), this may be an appealing option.

Integrated Blowers (VTN series)

These blowers are purchased separately and integrated into the hood or onto the downdraft unit at the time of installation. This option allows you to select your ideal hood with the exact power you require. Integrated blowers are included with HPWB30FS, HPWB36FS and HPWB48FS.

CHOOSING THE RIGHT CFM

The power of the cooktop or range, measured in BTU, is perhaps the most important factor in determining CFM needs for a hood.

You should also consider the cooking space and cooking style of your client.

- More demanding cooks usually require more exhaust capacity to handle moisture generated by boiling large pots of water or the grease and smoke resulting from grilling or frying. This cooking style could require a hood or downdraft system with airflow of 600 to 1,300 CFM.
- For those who are used to preparing quick meals in a relatively small kitchen, a hood with 600 CFM may be adequate ventilation for the cooking space.
- If the cooking surface is in a peninsula or island, a larger capacity hood can provide better capture when there are cross currents and when the hood needs to be mounted higher. Downdraft ventilation systems are also a good alternative.
- High heat cooking or aromatic foods may require additional CFM. Increasing capture area by 3" on each side is also a recommended way to address this issue.

LENGTH AND SIZE OF DUCTWORK

Do not use flexible duct; it creates back pressure / air turbulence and reduces performance.

Straight runs and gradual turns are best. Use the shortest route with the fewest turns possible.

Proper performance is dependent upon proper ducting. Use a qualified and trained installer. Local building codes may require the use of make-up air systems when using ducted ventilation systems greater than specified CFM of air movement. The specified CFM varies from locale to locale. Consult your HVAC professional for specific requirements in your area.

If using a 10" duct, Thermador recommends not exceeding 50 feet of duct. Transitions, elbows and wall or roof caps are all factors that will add more static pressure, therefore increasing your equivalent duct run.



WARRANTY

Limited warranty parts and labor (2 year)

See page 298 for additional warranty details.

VENTILATION

27-INCH DEPTH WALL HOOD (36"/42"/48"/54")

PH36GS / PH42GS / PH48GS / PH54GS



PROFESSIONAL

PH36GS – 36-Inch

PH42GS – 42-Inch

PH48GS – 48-Inch

PH54GS – 54-Inch

SPECIFICATIONS

Available Hood Widths	36" / 42" / 48" / 54"
UL Approved for Damp Environments	Yes
Blower	Sold Separately – See Blower Options Table
Duct Size at Discharge	10" Round
Ducting Direction	Vertical or Horizontal
Dishwasher-safe Filters	Commercial-Style Baffle
Halogen Lighting 120 Volt, 40 Watt Max., G-9 Base, Included	36" – 2 Bulbs 42" / 48" / 54" – 4 Bulbs
Infrared Keep-Hot Lights PAR-38 175W or PAR-40 250W, Included	2
Electrical	120V AC, 60Hz

PH36GS / PH42GS / PH48GS / PH54GS

PERFORMANCE

- Three fan speeds
- Auto function senses heat from the cooking surface and adjusts fan speeds
- Powerfully Quiet ventilation systems
- Extended capture area ensures removal of smoke and odor
- Built-in 'Clean Filter' reminder light illuminates after 40 hours of operation
- Delayed shut-off tackles lingering odors for up to 10 minutes
- Dimmer lighting – for a soft lighting effect
- Two Infrared Keep-Hot Lamps hold food warm until serving time
- Dishwasher-safe stainless steel baffle filters
- Dishwasher-safe grease collection trays are easily removed
- Filter systems are highly efficient at capturing grease
- Vertical or horizontal ducting direction
- Seven different blowers to choose from the lineup according to cooking needs
- Choose from Inline, Remote or Integrated Blowers
- Blowers sold separately
- Hood includes filters, backdraft damper and transition
- Approved by CSA / UL for damp environments

DESIGN

- 27" depth hood is a perfect companion to the Pro Grand Professional Range
- Chiseled design for a seamless integration into any kitchen
- Brushed stainless steel finish
- Halogen lighting spotlights your best recipes
- Easy-to-view recessed control panel with stainless steel buttons
- Stainless steel professional baffle filters

ACCESSORIES

Keep-Hot Shelf

- KHS36QS 36" wide – Stainless steel finish
 KHS42QS 42" wide – Convenient shelf allows dishes to keep hot at serving temperature.
 KHS48QS 48" wide – Includes stainless steel backguard and two shelves.

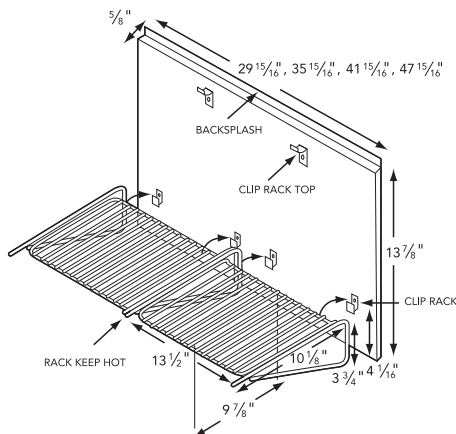

Duct Cover

Stainless steel duct cover for wall hood applications

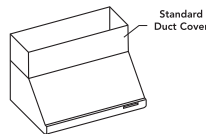

Width	6-Inch High	12-Inch High
36-Inch	DC36US	DCT36US
42-Inch	N/A	DCT42US
48-Inch	DC48US	DCT48US

Stainless Steel Backsplash

PA36JBS 36" wide
 PA48JBS 48" wide

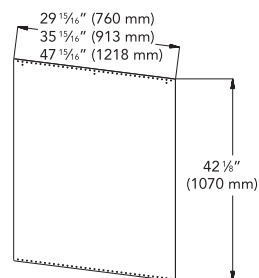

VENTILATION 27-INCH DEPTH WALL HOOD (36"/42"/48"/54")

PH36GS / PH42GS / PH48GS / PH54GS

INSTALLATION OPTIONS

Thermador Wall Hoods may be installed above a Thermador Cooktop or Range to create a convenient cooking center. Refer to the appropriate section for additional specifications.

Hood installation height above a cooktop or range can vary. To obtain the necessary installation height above a Thermador Professional Cooktop or Range, consult the appliance's installation manual. Accessory 6" and / or 12" tall duct covers are used to fill the space between the hood and ceiling.

Both vertical and horizontal discharge is possible with either mounting method. The hood is shipped ready for vertical discharge.

REMOTE BLOWER ACCESSORIES

Roofplate RFPLT600
For use with Remote Blower VTR630D

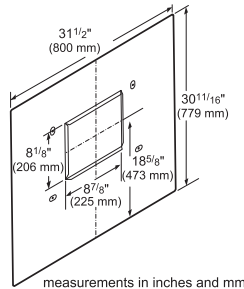

Roofplate RFPLT1000
For use with Remote Blowers VTR1030D and VTR1330E

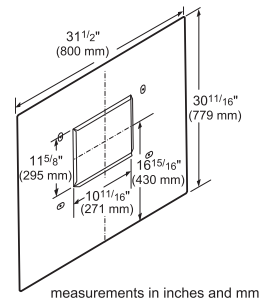

EXTNCB25
25 ft. Blower Connector Cable for use with the following Inline and Remote blowers:
VTR630D,
VTR1030D,
VTR1330E,
VTI610D,
VTI1010D

BLOWER OPTIONS

REMOTE

VTR630D – 600 CFM	Use Roofplate RFPLT600 in roof-mount applications
VTR1030D – 1000 CFM	Use Roofplate RFPLT1000 in roof-mount applications
VTR1330E – 1300 CFM	Use Roofplate RFPLT1000 in roof-mount applications

INLINE

VTI610D – 600 CFM	Use WC10 Wall Cap
VTI1010D – 1000 CFM	Use WC10 Wall Cap

INTEGRATED

VTN630N – 600 CFM	Use WC10 Wall Cap
VTN1030N – 1000 CFM	Use WC10 Wall Cap

HOOD DIMENSIONS

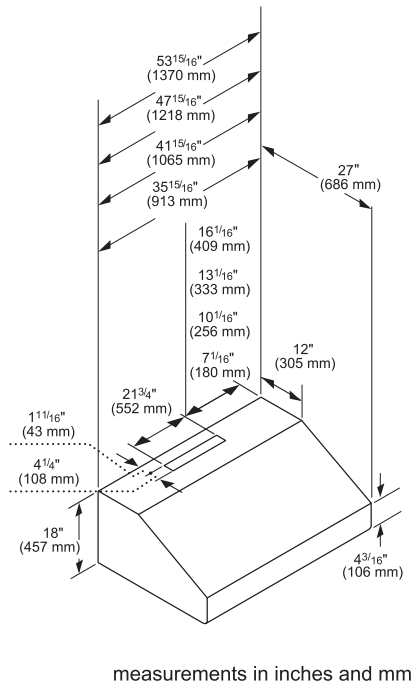

ROOF JACK, WALL CAP & TRANSITION

Roof Jack – RJ310

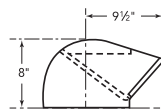

Wall Cap – WC10

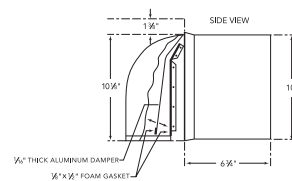

Transition

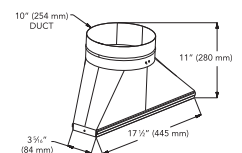

REMOTE (Mounted to roof or external wall)

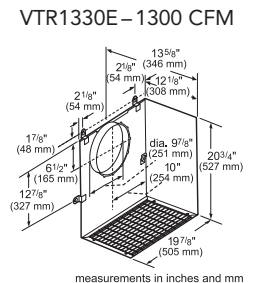
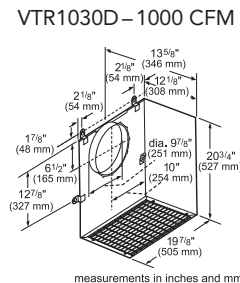
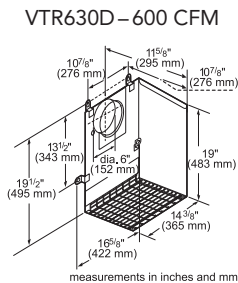

INLINE (Mounted between kitchen and external wall)

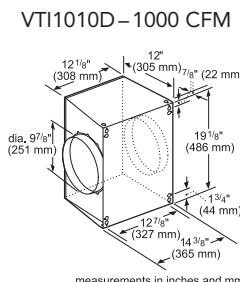
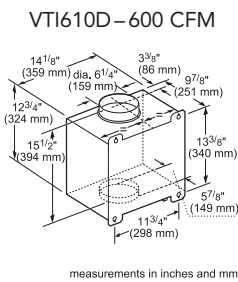

INTEGRATED (Mounted in hood)

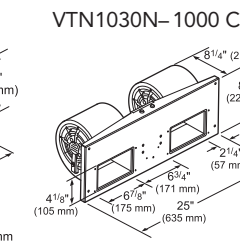
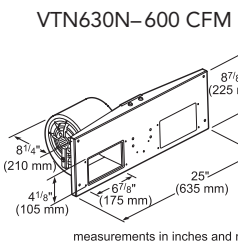

VENTILATION

24-INCH DEPTH WALL HOOD (30"/36"/48")

PH30HS / PH36HS / PH48HS



PROFESSIONAL

PH30HS – 30-Inch

PH36HS – 36-Inch

PH48HS – 48-Inch

SPECIFICATIONS

Available Hood Widths	30" / 36" / 48"
CSA Approved for Damp Environments	Yes
Blower	Sold Separately – See Blower Options Table
Duct Size at Discharge	10"
Ducting Direction	Vertical or Horizontal
Dishwasher-safe Filters	Commercial-Style Stainless Steel Baffle Filter
Halogen Lighting 120 Volt, 40 Watt Max., G-9 Base, Included	30" / 36" – 2 Bulbs 48" – 4 Bulbs
Electrical	120V AC, 60Hz

PH30HS / PH36HS / PH48HS

PERFORMANCE

- Three fan speeds
- Delayed shut-off tackles lingering odors for up to 10 minutes
- Built-in 'Clean Filter' reminder light illuminates after 40 hours of operation
- Filter systems are highly efficient at capturing grease
- Dishwasher-safe grease collection trays are easily removed
- Powerfully Quiet ventilation systems
- Blowers sold separately
- Seven different blowers to choose from the lineup according to cooking needs
- Choose from Inline, Remote or Integrated Blowers
- 10" Round duct size
- Vertical or horizontal ducting direction
- Hood includes filters, backdraft damper and transition
- Approved by CSL for damp environments

DESIGN

- 24" depth hood is 18" tall and a perfect companion with Pro Harmony Ranges and Rangetops
- Chiseled design for a seamless integration into any kitchen
- Brushed stainless steel finish
- Stainless steel control buttons
- Halogen lighting spotlights your best recipes
- Stainless steel professional style baffle filters
- Dishwasher-safe stainless steel baffle filters
- Dimmer lighting – for a soft lighting effect

ACCESSORIES

Keep-Hot Shelf

- KHS30QS 30" wide – Stainless steel finish
 KHS36QS 36" wide – Convenient shelf allows dishes to keep hot at serving temperature.
 KHS42QS 42" wide – Includes stainless steel backguard and two shelves.
 KHS48QS 48" wide

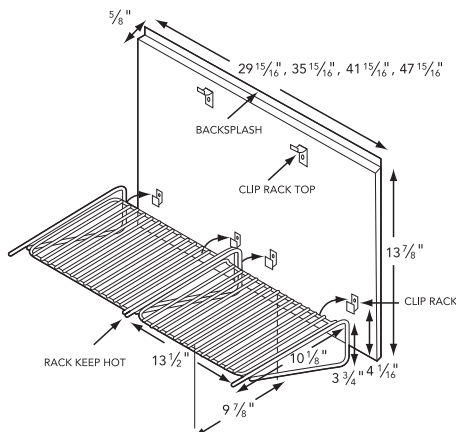

Duct Cover

Stainless steel duct cover for wall hood applications

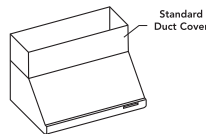

Width	6-Inch High	12-Inch High
30-Inch	DC30US	DCT30US
36-Inch	DC36US	DCT36US
48-Inch	DC48US	DCT48US

Stainless Steel Backsplash

- PA30JBS 30" wide
 PA36JBS 36" wide
 PA48JBS 48" wide

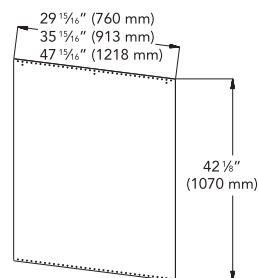

VENTILATION 24-INCH DEPTH WALL HOOD (30"/36"/48")

PH30HS / PH36HS / PH48HS

INSTALLATION OPTIONS

Thermador Wall Hoods may be installed above a Thermador Cooktop or Range to create a convenient cooking center. Refer to the appropriate section for additional specifications.

Hood installation height above a cooktop or range can vary. To obtain the necessary installation height above a Thermador Professional Cooktop or Range, consult the appliance's installation manual. Accessory 6" and / or 12" duct covers are used to fill the space between the hood and ceiling.

Both vertical and horizontal discharge is possible with either mounting method. The hood is shipped ready for vertical discharge.

HOOD DIMENSIONS

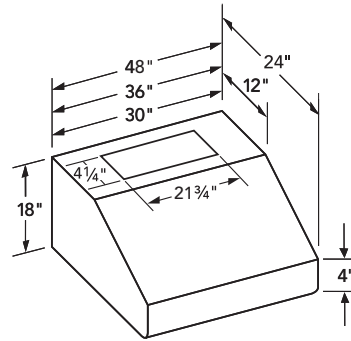

ROOF JACK, WALL CAP & TRANSITION

Roof Jack—RJ310

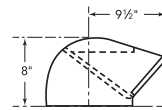

Wall Cap—WC10

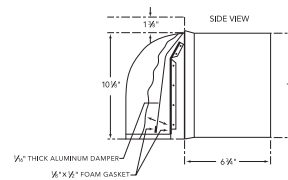

Transition

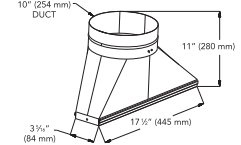

BLOWER OPTIONS

REMOTE

VTR630D—600 CFM	Use Roofplate RFPLT600 in roof-mount applications
VTR1030D—1000 CFM	Use Roofplate RFPLT1000 in roof-mount applications
VTR1330E—1300 CFM	Use Roofplate RFPLT1000 in roof-mount applications

INLINE

VTI610D—600 CFM	
VTI1010D—1000 CFM	

INTEGRATED

VTN630N—600 CFM	Use WC10 Wall Cap
VTN1030N—1000 CFM	Use WC10 Wall Cap

See page 147 for further details.

REMOTE (Mounted to roof or external wall)

VTR630D—600 CFM

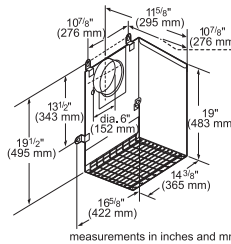

VTR1030D—1000 CFM

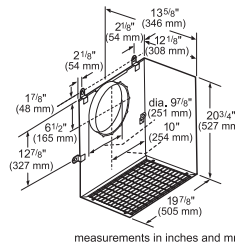

VTR1330E—1300 CFM

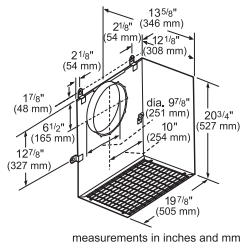

REMOTE BLOWER ACCESSORIES

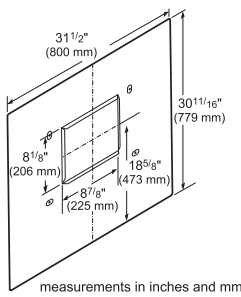

Roofplate RFPLT600
For use with Remote Blower VTR630D

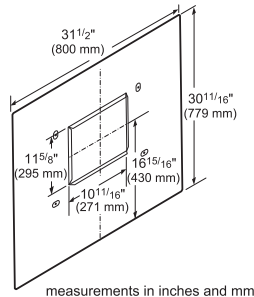

Roofplate RFPLT1000
For use with Remote Blowers VTR1030D and VTR1330E

INLINE (Mounted between kitchen and external wall)

VTI610D—600 CFM

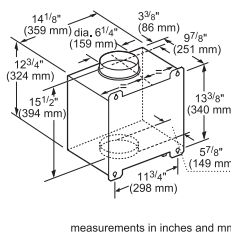

VTI1010D—1000 CFM

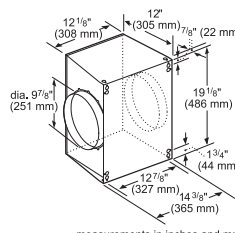

INTEGRATED (Mounted in hood)

VTN630N—600 CFM

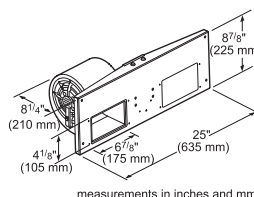

VTN1030N—1000 CFM

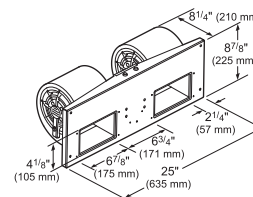

EXTNCB25

25 ft. Blower Connector Cable for use with the following Inline and Remote blowers: VTR630D, VTR1030D, VTR1330E, VTI610D, VTI1010D

VENTILATION

24-INCH DEPTH WALL HOOD WITH BLOWER (30"/36"/48")

HPWB30FS / HPWB36FS / HPWB48FS



PROFESSIONAL

HPWB30FS – 30-Inch

HPWB36FS – 36-Inch

HPWB48FS – 48-Inch

SPECIFICATIONS

Available Hood Widths	30" / 36" / 48"
Blower	30" – 600 CFM Blower Included 36" – 1200 CFM Blower Included 48" – 1200 CFM Blower Included
Duct Size at Discharge	10" Round
Ducting Direction	Vertical
Dishwasher-safe Filters	Low-Profile Baffle
Halogen Lighting 120 Volt, 50 Watt Max., GU10 Base, Not Included	30" / 36" – 2 Bulbs 48" – 3 Bulbs
Electrical	120V AC, 60Hz

HPWB30FS / HPWB36FS / HPWB48FS

PERFORMANCE

- 600 CFM Integrated Blower included with HPWB30FS; 1,200 CFM Integrated Blower included with HPWB36FS and HPWB48FS
- Recirculation possible with kit RECIRC_FS (max 600 CFM)
- Three fan speeds
- Delayed shut-off tackles lingering odors for up to 10 minutes
- Built-in 'Clean Filter' reminder light illuminates after 40 hours of operation
- Dimmer lighting – for a soft lighting effect
- Filter systems are highly efficient at capturing grease
- Grease collection trays are easily removed and dishwasher-safe
- Powerfully Quiet ventilation systems
- 10" Round duct size
- Vertical ducting direction
- Hood includes filters, backdraft damper and transition
- Accessories include: Stainless steel duct covers in 6" or 12" heights
- Replacement charcoal filters available (CHFILT3036)

DESIGN

- Brushed stainless steel finish
- Welded, polished seams for a flawless design
- Stainless steel button controls
- Halogen lighting spotlights your best recipes
- Dishwasher-safe low-profile baffle filters

ACCESSORIES

Duct Cover

Stainless steel duct cover for wall hood applications

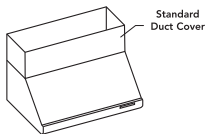

Width	6-Inch High	12-Inch High
30-Inch	DC30US	DCT30US
36-Inch	DC36US	DCT36US
48-Inch	DC48US	DCT48US

Stainless Steel Backsplash

PA30JBS 30" wide
PA36JBS 36" wide
PA48JBS 48" wide

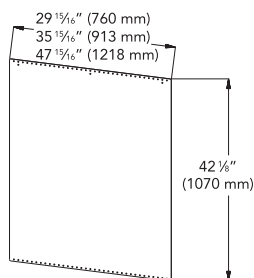

Recirculation Kit for 30" Hood Only

RECIRC30FS 30" wide

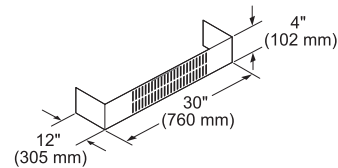

measurements in inches and mm

- Stainless steel finish
- Perfect for hard to duct installations
- Use with 600 CFM blowers only

Replacement Charcoal Filters

CHFILT3036

For use with Recirculation Kit RECIRC_FS

VENTILATION

24-INCH DEPTH WALL HOOD WITH BLOWER (30"/36"/48")

HPWB30FS / HPWB36FS / HPWB48FS

INSTALLATION OPTIONS

Thermador Wall Hoods may be installed above a Thermador Cooktop or Range to create a convenient cooking center. Refer to the appropriate section for additional specifications.

Hood installation height above a cooktop or range can vary. To obtain the necessary installation height above a Thermador Professional Cooktop or Range, consult the appliance's installation manual. Accessory 6" and / or 12" duct covers are used to fill the space between the hood and ceiling.

This Thermador Wall Hood can be mounted on a wall or suspended from a cabinet. The cabinet must be structurally joined to the wall studs to support the weight of this hood.

These hoods are designed to be used for vertical discharge. A ductless, recirculation installation is possible with kit RECIRC_FS.

HOOD DIMENSIONS

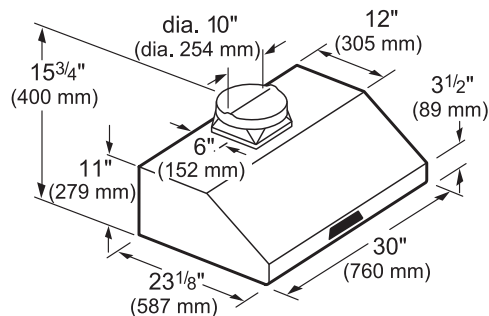

measurements in inches and mm

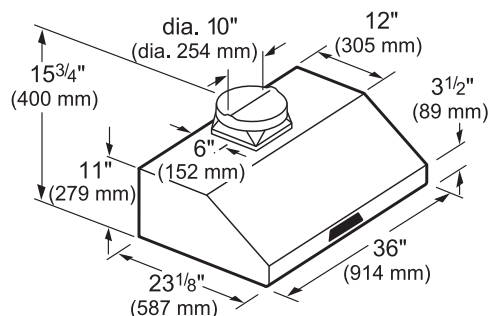

measurements in inches and mm

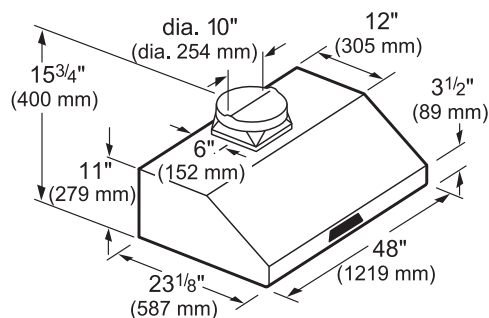

measurements in inches and mm

BLOWER PRESSURE CURVES

HPWB30FS

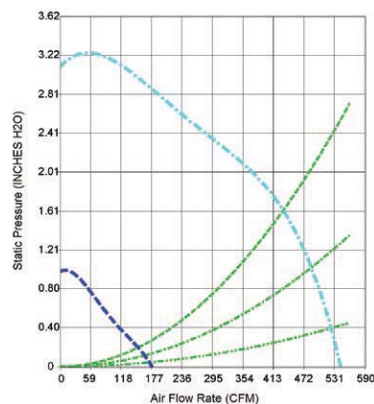

HPWB36FS

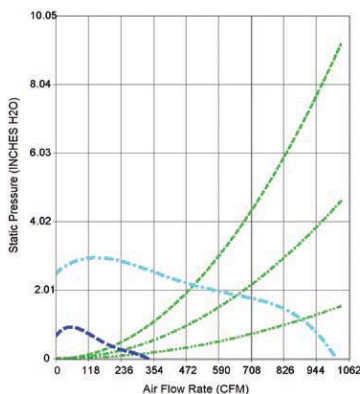

HPWB48FS

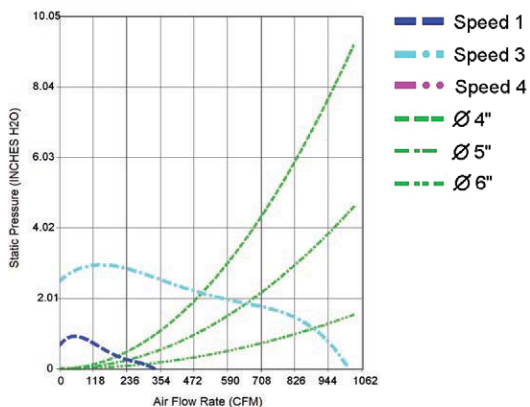

NOTE: All measurements are made with 3 ft. straight duct, 90° bend and 1 ft. straight duct at exhaust. These are NOT free blowing measurements.

VENTILATION WALL HOOD (30"/48")

HMWN30FS / HMWN48FS



MASTERPIECE

HMWN30FS – 30-Inch

HMWN48FS – 48-Inch

SPECIFICATIONS

Available Hood Widths	30" / 48"
Blower	Sold separately – See Blower Options table
Duct Size at Discharge	10" Round
Ducting Direction	Vertical
Dishwasher-safe Filters	Low-Profile Baffle
Halogen Lighting	30" – 2 Bulbs
120 Volt, 50 Watt Max., GU10 Base, Not Included	48" – 3 Bulbs
Electrical	120V AC, 60Hz

HMWN30FS / HMWN48FS

PERFORMANCE

- Recirculation possible with kit RECIRC_FS (max 600 CFM)
- Three fan speeds plus 10 minute high-power operation mode
- Built-in 'Clean Filter' reminder light illuminates after 40 hours of operation
- Delayed shut-off tackles lingering odors for up to 10 minutes
- Dishwasher-safe low-profile baffle filters
- Grease collection trays are easily removed and dishwasher-safe
- Filter systems are highly efficient at capturing grease
- Powerfully Quiet ventilation systems
- 10" Round duct size
- Vertical ducting direction
- Hood includes filters, lights, backdraft damper and transition
- Blowers sold separately
- Choose from Inline, Remote or Integrated Blowers
- Accessories include: Stainless steel duct covers in 6" or 12" heights
- Replacement charcoal filters available (CHFILT3036)

DESIGN

- Brushed stainless steel finish
- Welded, polished seams for a flawless design
- Premium electronic touch controls
- Halogen lighting spotlights your best recipes

ACCESSORIES

Duct Cover

Stainless steel duct cover for wall hood applications

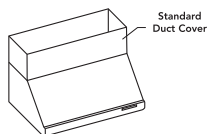

Width	6-Inch High	12-Inch High
30-Inch	DC30US	DCT30US
48-Inch	DC48US	DCT48US

Recirculation Kit

RECIRC30FS 30" wide

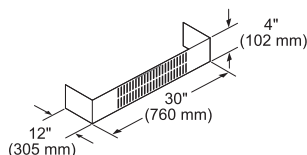

measurements in inches and mm

Stainless Steel Backsplash

PA30JBS 30" wide
PA48JBS 48" wide

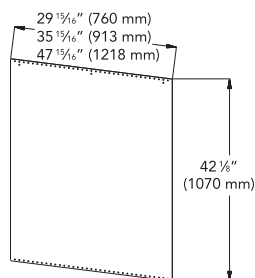

- Stainless steel finish
- Perfect for hard to duct installations
- Use with 600 CFM blowers only

Replacement Charcoal Filters

CHFILT3036

For use with Recirculation Kit RECIRC_FS

VENTILATION WALL HOOD (30"/48")

HMWN30FS / HMWN48FS

INSTALLATION OPTIONS

Thermador Wall Hoods may be installed above a Thermador Cooktop or Range to create a convenient cooking center. Refer to the appropriate section for additional specifications.

Hood installation height above a cooktop or range can vary. To obtain the necessary installation height above a Thermador Professional Cooktop or Range, consult the appliance's installation manual. Accessory 6" and / or 12" duct covers are used to fill the space between the hood and ceiling.

This Thermador Wall Hood can be mounted on a wall or suspended from a cabinet. The cabinet must be structurally joined to the wall studs to support the weight of this hood.

These hoods are designed to be used for vertical discharge. A ductless, recirculation installation is possible with kit RECIRC_FS.

These hoods are not recommended to be used over indoor grills.

HOOD DIMENSIONS

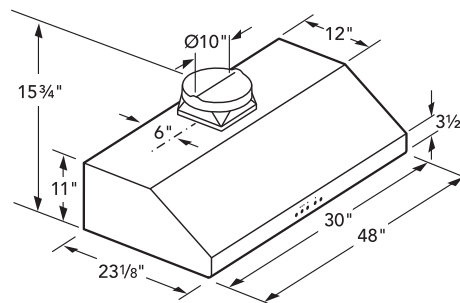

BLOWER OPTIONS

REMOTE

VTR630D – 600 CFM	Use Roofplate RFPLT600 in roof-mount applications
VTR1030D – 1000 CFM	Use Roofplate RFPLT1000 in roof-mount applications
VTR1330E – 1300 CFM	Use Roofplate RFPLT1000 in roof-mount applications

INLINE

VTI610D – 600 CFM	
VTI1010D – 1000 CFM	

INTEGRATED

VTN600F – 600 CFM	
VTN1000F – 1000 CFM	Not for use with 30" hood

See page 147 for further details.

REMOTE (Mounted to roof or external wall)

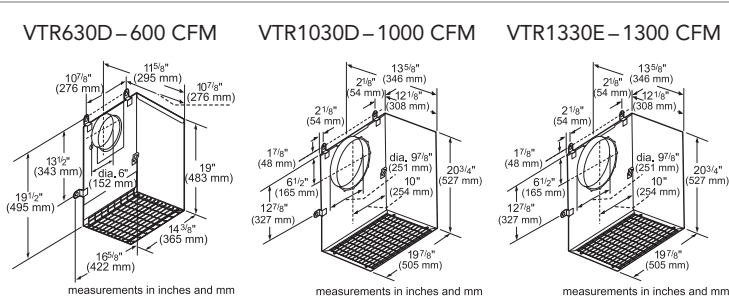

INLINE (Mounted between kitchen and external wall)

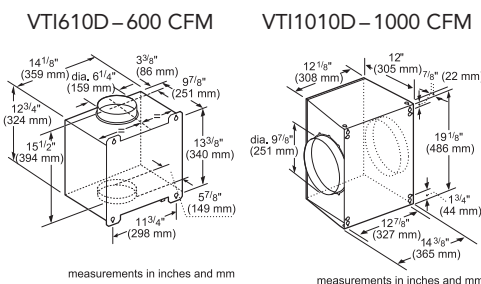

REMOTE BLOWER ACCESSORIES

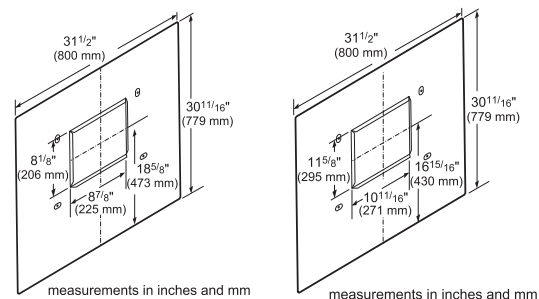

Roofplate RFPLT600
For use with Remote Blower VTR630D

Roofplate RFPLT1000
For use with Remote Blowers VTR1030D and VTR1330E

INTEGRATED (Mounted in hood)

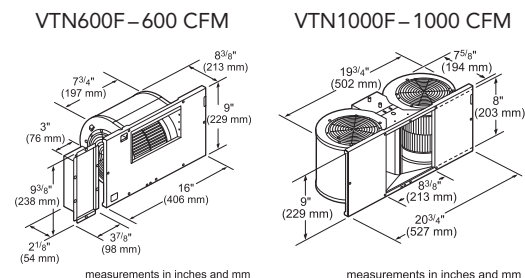

VENTILATION WALL HOOD WITH BLOWER (30"/36")

HMWB30FS / HMWB36FS



MASTERPIECE

HMWB30FS – 30-Inch

HMWB36FS – 36-Inch

SPECIFICATIONS

Available Hood Widths	30" / 36"
Blower	600 CFM Blower Included
Duct Size at Discharge	10" Round
Ducting Direction	Vertical
Dishwasher-safe Filters	Low-Profile Baffle
Halogen Lighting 120 Volt, 50 Watt Max., GU10 Base, Not Included	2 Bulbs
Electrical	120V AC, 60Hz

HMWB30FS / HMWB36FS

PERFORMANCE

- 600 CFM Integrated Blower included
- Recirculation possible with kit RECIRC_FS (max 600 CFM)
- Three fan speeds plus 10 minute high-power operation mode
- Built-in 'Clean Filter' reminder light illuminates after 40 hours of operation
- Delayed shut-off tackles lingering odors for up to 10 minutes
- Dishwasher-safe low-profile baffle filters
- Grease collection trays are easily removed and dishwasher-safe
- Filter systems are highly efficient at capturing grease
- Powerfully Quiet ventilation systems
- 10" Round duct size
- Vertical ducting direction
- Hood includes filters, lights, backdraft damper and transition
- Accessories include: Stainless steel duct covers in 6" or 12" heights
- Replacement charcoal filters available (CHFILT3036)

DESIGN

- Brushed stainless steel finish
- Welded, polished seams for a flawless design
- Easy-to-operate control buttons
- Halogen lighting spotlights your best recipes

ACCESSORIES

Duct Cover

Stainless steel duct cover
for wall hood applications

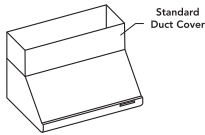

Width	6-Inch High	12-Inch High
30-Inch	DC30US	DCT30US
36-Inch	DC36US	DCT36US
48-Inch	DC48US	DCT48US

Stainless Steel Backsplash

PA30JBS 30" wide
PA36JBS 36" wide

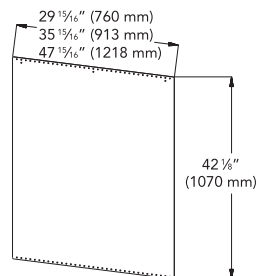

Recirculation Kit

RECIRC30FS 30" wide
RECIRC36FS 36" wide

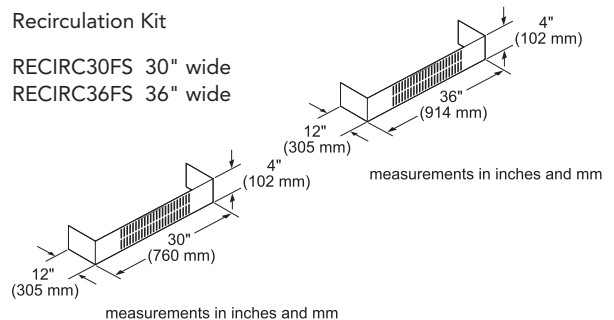

- Stainless steel finish
- Perfect for hard to duct installations
- Use with 600 CFM blowers only

Replacement Charcoal Filters

CHFILT3036

For use with Recirculation Kit RECIRC_FS

VENTILATION WALL HOOD WITH BLOWER (30"/36")

HMWB30FS / HMWB36FS

INSTALLATION OPTIONS

Thermador Wall Hoods may be installed above a Thermador Cooktop or Range to create a convenient cooking center. Refer to the appropriate section for additional specifications.

Hood installation height above a cooktop or range can vary. To obtain the necessary installation height above a Thermador Professional® Cooktop or Range, consult the appliance's installation manual. Accessory 6" and / or 12" duct covers are used to fill the space between the hood and ceiling.

This Thermador Wall Hood can be mounted on a wall or suspended from a cabinet. The cabinet must be structurally joined to the wall studs to support the weight of this hood.

These hoods are designed to be used for vertical discharge. A ductless, recirculation installation is possible with kit RECIRC_FS.

These hoods are not recommended to be used over indoor grills.

HOOD DIMENSIONS

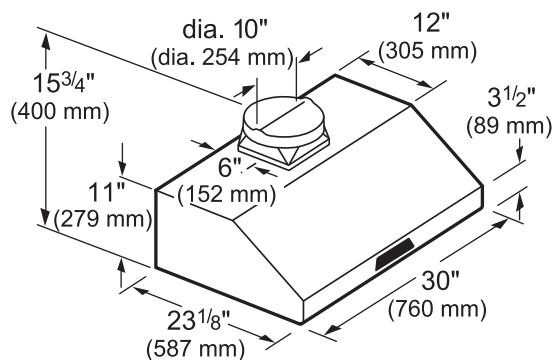

measurements in inches and mm

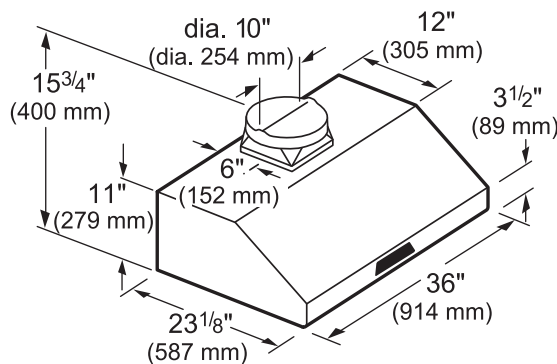

measurements in inches and mm

BLOWER PRESSURE CURVES

HMWB30FS

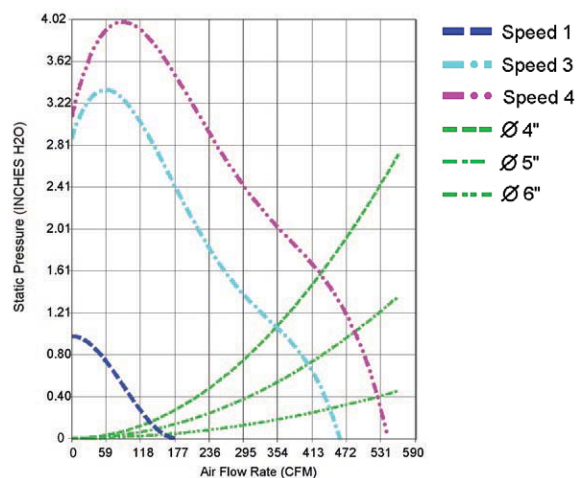

HMWB36FS

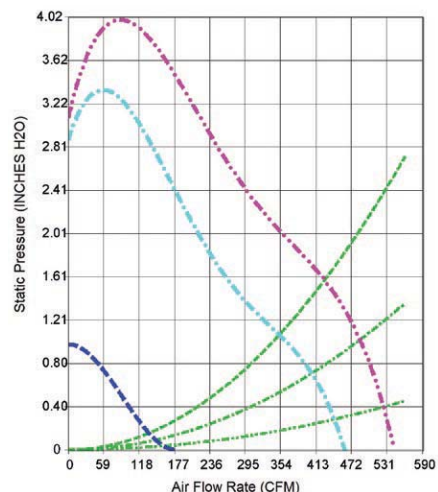

NOTE: All measurements are made with 3 ft. straight duct, 90° bend and 1 ft. straight duct at exhaust. These are NOT free blowing measurements.



MODELS SHOWN: HDDW36FS CHIMNEY WALL DRAWER HOOD, SGSX365FS GAS COOKTOP AND MED301JS BUILT-IN OVEN

VENTILATION CHIMNEY WALL HOODS

Our Professional Series chimney style wall hoods impart a more contemporary feel to the kitchen space while Masterpiece® Series impart a more traditional feel. Each model is adjustable to suit a range of ceiling heights and includes conveniences such as dishwasher-safe filters and electronic controls. Halogen lighting brilliantly illuminates your cooking space for excellent visibility.

CHIMNEY WALL HOODS

FEATURES & BENEFITS



HALOGEN LIGHTS

Bright halogen lighting spotlights your best recipes.



MESH FILTERS

Aluminum mesh filters with stainless steel frame maximize grease capture without affecting flow and feature a quick release latch for easy cleanup.



ELECTRONIC TOUCH CONTROL

The sleek electronic touch control panel is easy-to-use and easy-to-clean.

TIME-TO-CLEAN-FILTER LIGHT

Easy cleanup: All Thermador ventilation filters are dishwasher-safe, and many hoods feature a built-in Time-to-Clean-Filter reminder light. (Except HMCB36FS, HMCB42FS)

DELAYED SHUT-OFF

For the greatest efficiency, our Professional and Masterpiece® ventilation models include delayed shut-off to tackle lingering odors. (Except HMCB36FS, HMCB42FS)

PLANNING INFORMATION

MODEL OPTIONS

Thermador Chimney Wall Hoods feature sleek styling and numerous convenience functions. Chimney Wall Hoods are available in 36-inch, 42-inch and 48-inch widths and are adjustable to suit a range of ceiling heights. All stainless steel or stainless steel with glass designs are available. Be sure to reference the correct model information in this design guide.

ELECTRICAL SPECIFICATIONS

Be sure your Thermador Chimney Wall Hood is properly installed and grounded by a qualified technician. Installation, electrical connections and grounding must comply with all applicable local codes.

If possible, site the earthed socket directly behind the chimney paneling. The grounded socket should be connected via its own circuit. If the grounded socket is no longer accessible following installation of the hood, ensure that there is a permanently installed disconnect.

MODEL	REQUIRED CIRCUIT BREAKER
	120V AC, 60 Hz
HPCN36NS, HPCN48NS, HPCB36NS, HPCB48NS, HMCN36FS, HMCN42FS, HMCB36FS, HMCB42FS, HDDW36FS	15 Amp

INSTALLATION CONSIDERATIONS

The information in this design guide provides key features, product dimensions, cutouts and installation specifications. Before installing a Thermador Chimney Wall Hood, be sure to verify the cutout dimensions and electrical connections. Also, always consult with the installation manual packed with the product for complete details before installing.

Thermador Chimney Wall Hoods may be installed above a Thermador non-professional gas, electric, or induction cooktop to create a convenient cooking center. Refer to the appropriate section for additional specifications.

DISTANCE FROM COOKING SURFACE

Proper mounting height is very important. If a hood is mounted too low, it may be difficult to cook and be unsafe. If a hood is mounted too high, performance may be compromised.

For optimal performance, the distance from the cooking surface to the bottom of the hood should be a minimum of 30", unless otherwise noted. Please refer to the installation manual for each hood and cooktop / range model for proper hood mounting heights.

HOOD WIDTH

The hood width should be no less than the width of the cooking surface. Where space is not restricted, a wider hood can be used to increase your capture area.

CHIMNEY WALL HOODS PLANNING INFORMATION

AVAILABLE CEILING HEIGHT

The standard ceiling height can vary from region to region and in homes built in different eras. Ceiling heights, even in the same room, can sometimes vary by as much as several inches. Kitchen ceiling heights can vary between 7'6" (or 90") to over 10' (or 120").

Before selecting your hood, check your available installation space and any extra space that may remain after proper installation of your hood and cooktop or range. This extra space can be filled using Thermador's Stainless Steel Duct Cover or Chimney Extension Accessories. The space can also be adjusted by raising or lowering your hood within the recommended range (typically 30" to 36" above the cooking surface).

CHOOSING THE CORRECT BLOWER

A variety of interior and exterior blower options (Remote, Inline or Integrated) are available for Thermador's Professional and Masterpiece® Series Hoods. If the unit you have selected does not have a blower included, one can be purchased separately. Blower selection will vary based on the volume of air that needs to be moved and the length and location of the duct run. For long duct runs with multiple turns and bends, consider using a more powerful blower. For the most efficient air flow exhaust, use a straight run or as few elbows as possible.

Remote Blowers (VTR Series)

Depending on your preference and ducting situation, these blowers can be mounted on the roof or exterior wall of your home. An exterior installation may be more appealing to reduce noise in the kitchen.

Inline Blowers (VTI series)

To minimize noise in the kitchen, these blowers are mounted along the duct line anywhere between the kitchen and the exterior wall. If you have easy access to your duct line (in an attic, for example), this may be an appealing option.

Integrated Blowers (VTN series)

These blowers are purchased separately and integrated into the hood or onto the downdraft unit at the time of installation. This option allows you to select your ideal hood with the exact power you require.

SPECIAL NOTE: Always allow access to the blower for serviceability, should it be needed.

CHOOSING THE RIGHT CFM

The power of the cooktop or range, measured in BTU, is perhaps the most important factor in determining CFM needs for a hood.

You should also consider the cooking space and cooking style of your client.

- More demanding cooks usually require more exhaust capacity to handle moisture generated by boiling large pots of water or the grease and smoke resulting from grilling or frying. This cooking style could require a hood or downdraft system with airflow of 600 to 1,300 CFM.
- High heat cooking or aromatic foods may require additional CFM. Increasing capture area by 3" on each side is also a recommended way to address this issue.
- For those who are used to preparing quick meals in a relatively small kitchen, a hood with 400 to 600 CFM may be adequate ventilation for the cooking space.
- If the cooking surface is in a peninsula or island, a larger capacity hood can provide better capture when there are cross currents and when the hood needs to be mounted higher. Downdraft ventilation systems are also a good alternative.

LENGTH AND SIZE OF DUCTWORK

Proper performance is dependent upon proper ducting. Use a qualified and trained installer.

Do not use flexible duct; it creates back pressure / air turbulence and reduces performance.

Straight runs and gradual turns are best. Use the shortest route with the fewest turns possible.

Local building codes may require the use of makeup air systems when using ducted ventilation systems greater than specified CFM of air movement. The specified CFM varies from locale to locale. Consult your HVAC professional for specific requirements in your area.

If using a 10" duct, Thermador recommends not exceeding 50 feet of duct. Transitions, elbows and wall or roof caps are all factors that will add more static pressure, therefore increasing your equivalent duct run.

WARRANTY

Limited warranty parts and labor (2 year)



See page 298 for additional warranty details.

VENTILATION CHIMNEY WALL HOOD (36"/48")

HPCN36NS / HPCN48NS



PROFESSIONAL

HPCN36NS – 36-Inch

HPCN48NS – 48-Inch

SPECIFICATIONS

Available Hood Widths	36" / 48"
Blower	Sold Separately — See Blower Options Table
Duct Size at Discharge	10" Round
Ducting Direction	Vertical
Dishwasher-safe Filters	Stainless Steel Baffle
Halogen Lighting	36-Inch – 2 Bulbs 48-Inch – 4 Bulbs
120 Volt, 40 Watt Max., G-9 Base, Included	
Electrical	120V AC, 60Hz

HPCN36NS / HPCN48NS

PERFORMANCE

- Three fan speeds
- Powerfully Quiet® ventilation systems
- Dimmer lighting – for a soft lighting effect
- Dishwasher safe stainless steel baffle filters
- Dishwasher safe grease collection trays are easily removed
- Filter systems are highly efficient at capturing grease
- Vertical ducting direction
- Six different blowers to choose from the line up according to cooking needs
- Choose from Inline, Remote or Integrated Blowers
- Blowers sold separately
- Hood includes filters, backdraft damper and transition
- 10" Round duct size

DESIGN

- Chiseled design for a seamless integration into any kitchen
- Halogen lighting spotlights your best recipes
- Brushed stainless steel finish
- Stainless steel control buttons
- Stainless steel duct covers available as an accessory
- Thermador Professional Series Chimney style wall hoods impart a more contemporary feel to the kitchen space and create a dramatic gathering point.
- Delayed shut-off tackles lingering odors for up to ten minutes
- Auto function senses the heat from the cooking surface and adjusts the fan speeds
- Built-in 'Clean Filter' reminder light illuminates after 40 hours of operation

ACCESSORIES

6" Duct Cover

CHMHP366N
CHMHP486N

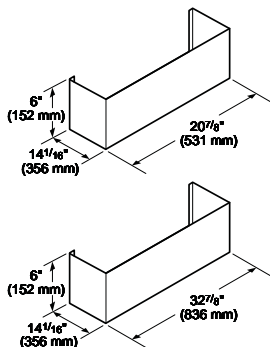

12" Duct Cover

CHMHP3612N
CHMHP4812N

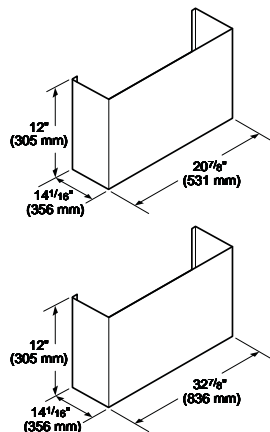

18" x 35" Duct Cover

CHMHP36TSN
CHMHP48TSN

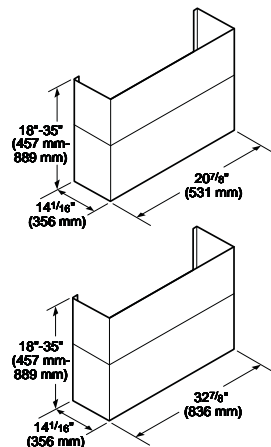

Keep-Hot Shelf

KHS36QS 36" wide
KHS48QS 48" wide

- Stainless steel finish
- Convenient shelf allows dishes to keep hot at serving temperature.
- Includes stainless steel backguard and two shelves.

Stainless Steel Backsplash

PA36JBS 36" wide
PA48JBS 48" wide

VENTILATION CHIMNEY WALL HOOD WITH BLOWER (36"/48")

HPCB36NS / HPCB48NS



PROFESSIONAL

HPCB36NS – 36-Inch

HPCB48NS – 48-Inch

HPCB36NS / HPCB48NS

PERFORMANCE

- Three fan speeds
- Dimmer lighting - for a soft lighting effect
- Dishwasher safe stainless steel baffle filters
- Dishwasher safe grease collection trays are easily removed
- Filter systems are highly efficient at capturing grease
- Vertical ducting direction
- 1000 CFM Internal Blower included
- Hood includes filters, backdraft damper and transition
- 10" Round duct size

DESIGN

- 24" depth hood is 18" tall and a perfect companion with Pro Ranges and Rangetops
- Chiseled design for a seamless integration into any kitchen
- Halogen lighting spotlights your best recipes
- Brushed stainless steel finish
- Stainless steel control buttons
- Stainless steel duct covers available as an accessory

SPECIFICATIONS

Available Hood Widths	36" / 48"
Blower	1000 CFM Blower Included
Duct Size at Discharge	10" Round
Ducting Direction	Vertical
Dishwasher-safe Filters	Stainless Steel Baffle
Halogen Lighting	36-Inch – 2 Bulbs
120 Volt, 40 Watt Max., G-9 Base, Included	48-Inch – 4 Bulbs
Electrical	120V AC, 60Hz

ACCESSORIES

6" Duct Cover

CHMHP366N
CHMHP486N

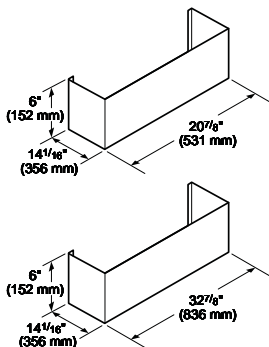

12" Duct Cover

CHMHP3612N
CHMHP4812N

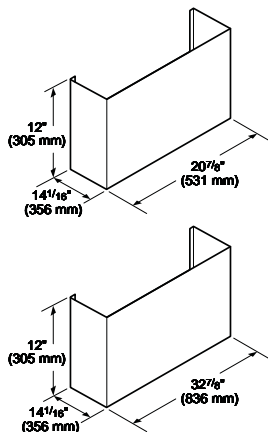

18" x 35" Duct Cover

CHMHP36TSN
CHMHP48TSN

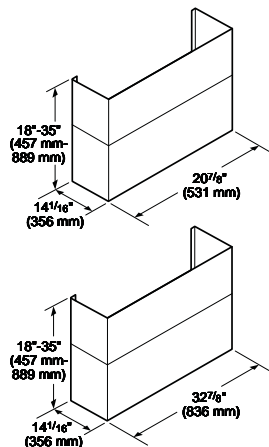

Keep-Hot Shelf

KHS36QS 36" wide
KHS48QS 48" wide

- Stainless steel finish
- Convenient shelf allows dishes to keep hot at serving temperature.
- Includes stainless steel backguard and two shelves.

Stainless Steel Backsplash

PA36JBS 36" wide
PA48JBS 48" wide

VENTILATION CHIMNEY WALL HOOD WITH BLOWER (36"/48")

HPCB36NS / HPCB48NS

INSTALLATION OPTIONS

Thermador Chimney Wall Hoods may be installed above a Thermador professional range or rangetop to create a convenient cooking center. Refer to the appropriate section for additional specifications.

Hood installation height above a cooktop can vary. To obtain the necessary installation height above a Thermador non-professional gas, electric, or induction cooktop, consult the appliance's installation manual.

Thermador Chimney Wall Hoods must be mounted on a wall.

These hoods are designed to be used for vertical discharge. A 1,000 CFM integrated blower is included.

HOOD DIMENSIONS

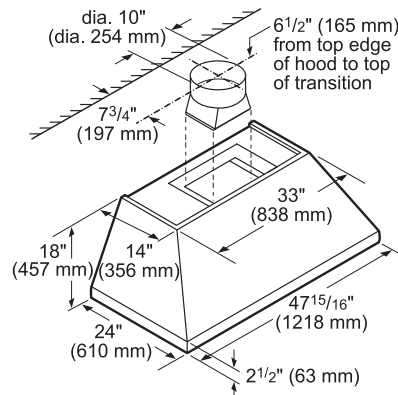
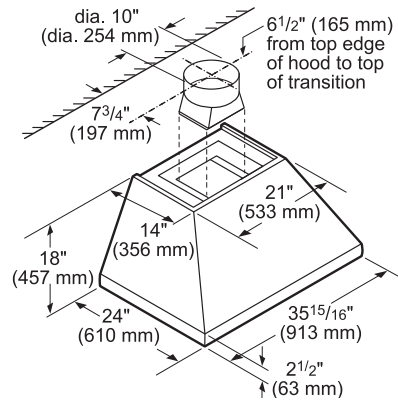

VENTILATION CHIMNEY WALL HOOD (36"/42")

HMCN36FS / HMCN42FS



MASTERPIECE®

HMCN36FS – 36-Inch

HMCN42FS – 42-Inch

HMCN36FS / HMCN42FS

PERFORMANCE

- Three fan speeds plus 10 minute high-power operation mode
- Delayed shut-off tackles lingering odors for up to 10 minutes
- Built-in 'Clean Filter' reminder light illuminates after 40 hours of operation
- Dimmer lighting—for those hours after a late meal
- Dishwasher-safe stainless-frame mesh filters
- Filter systems are highly efficient at capturing grease
- Powerfully Quiet® ventilation systems
- Vertical ducting direction
- 8" Round duct size
- Telescopic chimney—adjustable at installation
- Blowers sold separately
- Choose from Inline, Remote or Integrated Blowers

DESIGN

- Brushed stainless steel finish
- Welded, polished seams for a flawless design
- Premium electronic touch controls
- Halogen lighting spotlights your best recipes

SPECIFICATIONS

Available Hood Widths	36" / 42"
Blower	Sold Separately— See Blower Options Table
Duct Size at Discharge	8" Round
Ducting Direction	Vertical
Ceiling Heights	8' 2" ft. to 9 ft.
Dishwasher-safe Filters	3 Mesh with Stainless-Frame
Halogen Lighting 12 Volt, 20 Watt Max., G-4 Base, Included	3 Bulbs
Electrical	120V AC, 60Hz

ACCESSORIES

Chimney Extension

CHIMXHMC

Stainless steel chimney hood extension for up to 11-foot ceiling applications. Extension replaces upper section of standard chimney extension. May require fabrication to reduce height.

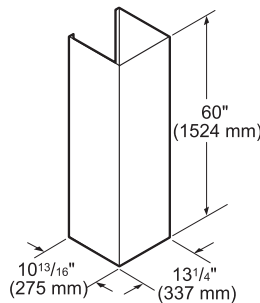

measurements in inches and mm

VENTILATION CHIMNEY WALL HOOD (36"/42")

HMCN36FS / HMCN42FS

INSTALLATION OPTIONS

Thermador Chimney Wall Hoods may be installed above a Thermador non-professional gas, electric, or induction cooktop to create a convenient cooking center. Refer to the appropriate section for additional specifications.

Hood installation height above a cooktop can vary. To obtain the necessary installation height above a Thermador non-professional gas, electric, or induction cooktop, consult the appliance's installation manual.

Thermador Chimney Wall Hoods must be mounted on a wall.

These hoods are designed to be used for vertical discharge. The HMCN_FS hood offers the flexibility to choose a blower from our lineup to fit your installation needs. All other chimney wall hoods have the convenience of integrated blowers.

HOOD DIMENSIONS

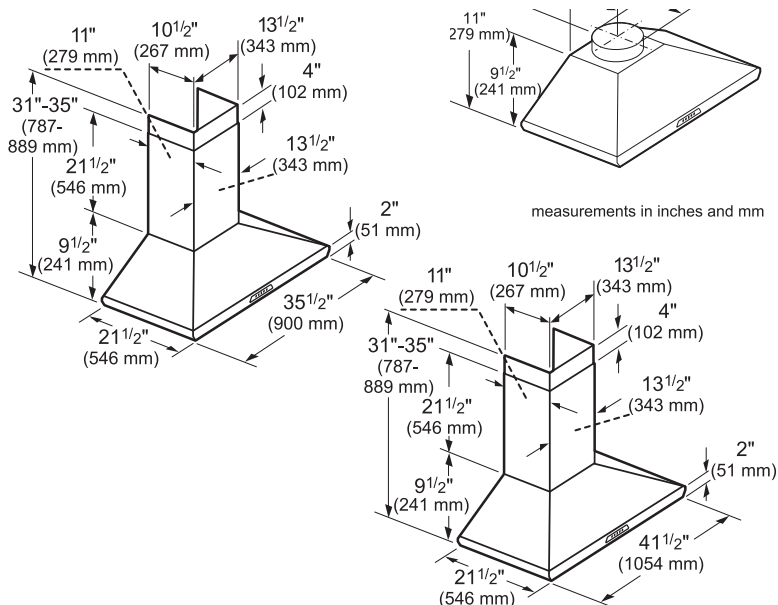

BLOWER OPTIONS

REMOTE

VTR630D – 600 CFM	Use Roofplate RFPLT600 in roof-mount applications
VTR1030D – 1000 CFM	Use Roofplate RFPLT1000 in roof-mount applications
VTR1330E – 1300 CFM	Use Roofplate RFPLT1000 in roof-mount applications

INLINE

VTI610D – 600 CFM	
VTI1010D – 1000 CFM	

INTEGRATED

VTN1080N – 1000 CFM	
---------------------	--

See page 161 for further details.

REMOTE (Mounted to roof or external wall)

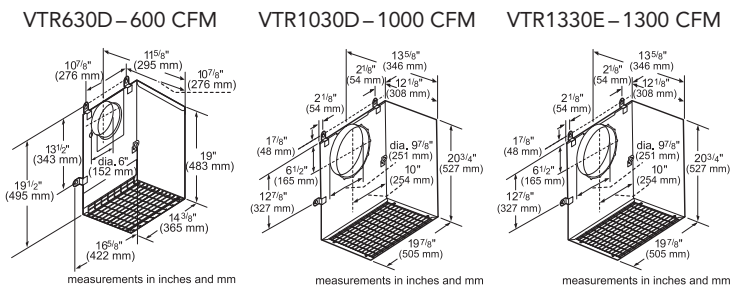

REMOTE BLOWER ACCESSORIES

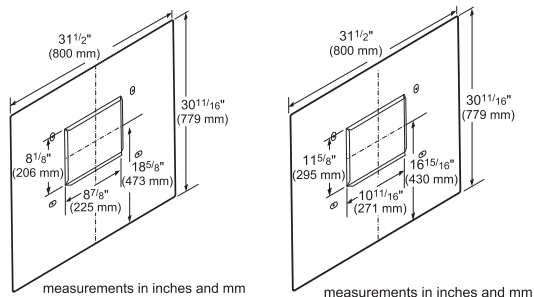

Roofplate RFPLT600
For use with Remote Blower VTR630D

Roofplate RFPLT1000
For use with Remote Blowers VTR1030D and VTR1330E

INLINE (Mounted between kitchen and external wall)

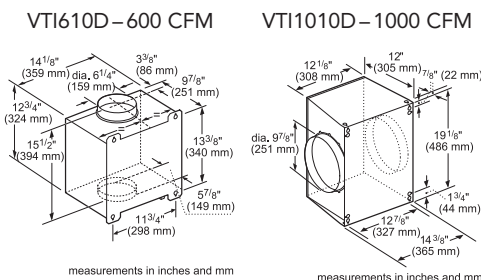

INTEGRATED (Mounted in hood)

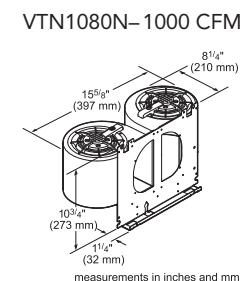

VENTILATION CHIMNEY WALL HOOD WITH BLOWER (36"/42")

HMCB36FS / HMCB42FS



MASTERPIECE®

HMCB36FS – 36-Inch

HMCB42FS – 42-Inch

HMCB36FS / HMCB42FS

PERFORMANCE

- 600 CFM Integrated Blower included
- Three fan speeds plus 10 minute high-power operation mode
- Dishwasher-safe stainless-frame mesh filters
- Filter systems are highly efficient at capturing grease
- Powerfully Quiet® ventilation systems
- 6" Round duct size
- Vertical ducting direction
- Telescopic chimney – adjustable at installation
- Hood includes filters, lights, backdraft damper and transition

DESIGN

- Brushed stainless steel finish
- Welded, polished seams for a flawless design
- Easy-to-operate control buttons
- Halogen lighting spotlights your best recipes

SPECIFICATIONS

Available Hood Widths	36" / 42"
Blower	600 CFM Blower Included
Duct Size at Discharge	6" Round
Ducting Direction	Vertical
Ceiling Heights	8' 2" ft. to 9 ft.
Dishwasher-safe Filters	3 Mesh with Stainless-Frame
Halogen Lighting 12 Volt, 20 Watt Max., G-4 Base, Included	3 Bulbs
Electrical	120V AC, 60Hz

ACCESSORIES

Chimney Extension

CHIMXHMC

Stainless steel chimney hood extension for up to 11-foot ceiling applications. Extension replaces upper section of standard chimney extension. May require fabrication to reduce height.

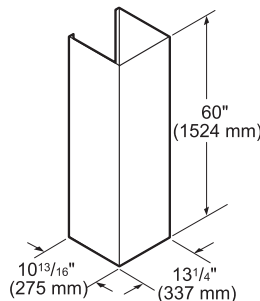

measurements in inches and mm

VENTILATION CHIMNEY WALL HOOD WITH BLOWER (36"/42")

HMCB36FS / HMCB42FS

INSTALLATION OPTIONS

Thermador Chimney Wall Hoods may be installed above a Thermador non-professional gas, electric, or induction cooktop to create a convenient cooking center. Refer to the appropriate section for additional specifications.

Hood installation height above a cooktop can vary. To obtain the necessary installation height above a Thermador non-professional gas, electric, or induction cooktop, consult the appliance's installation manual.

Thermador Chimney Wall Hoods must be mounted on a wall.

These hoods are designed to be used for vertical discharge. A 600 CFM integrated blower is included.

HOOD DIMENSIONS

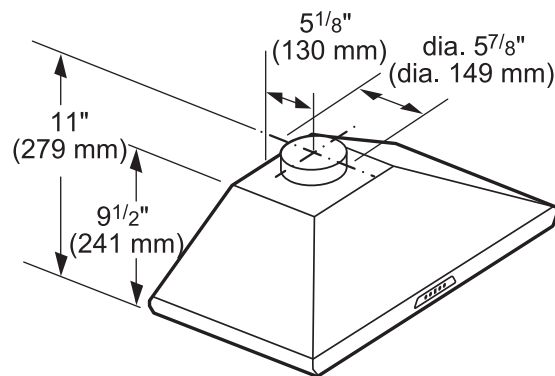

measurements in inches and mm

BLOWER PRESSURE CURVES

HMCB36FS

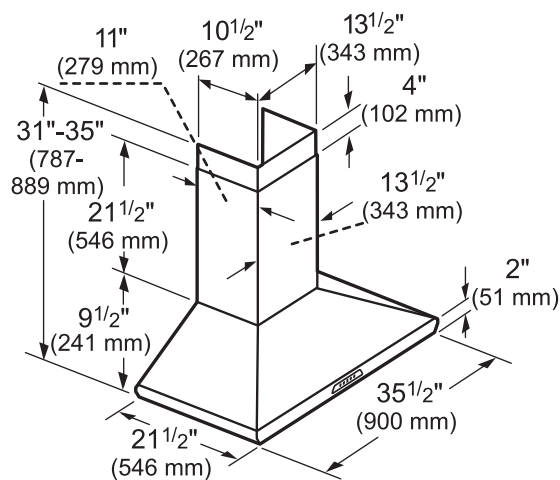
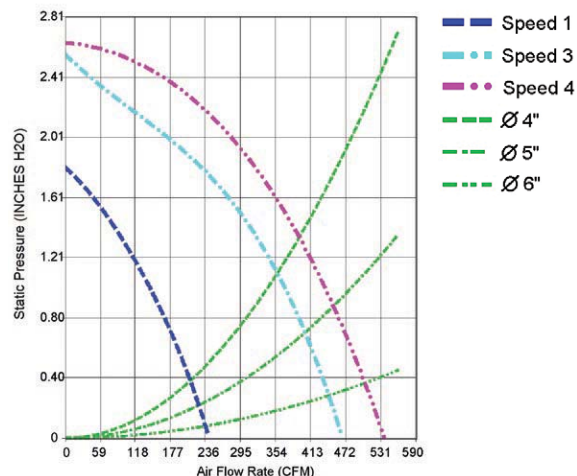

measurements in inches and mm

HMCB42FS

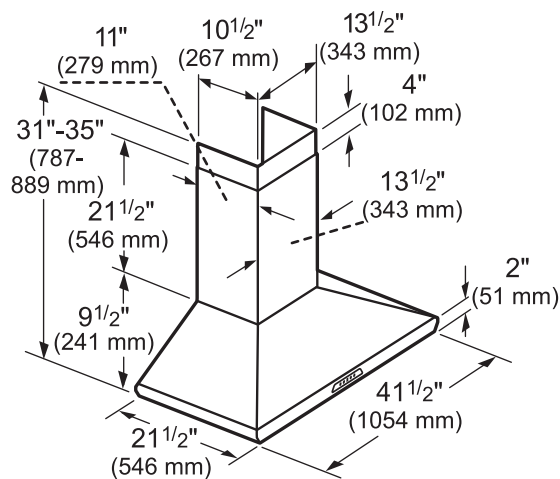
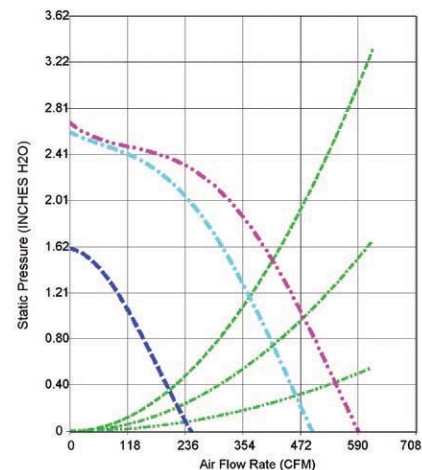

measurements in inches and mm

NOTE: All measurements are made with 3 ft. straight duct, 90° bend and 1 ft. straight duct at exhaust. These are NOT free blowing measurements.

VENTILATION CHIMNEY WALL DRAWER HOOD (36")

HDDW36FS



MASTERPIECE®

HDDW36FS-36-Inch

HDDW36FS

INNOVATION

- ★ - Unique sliding stainless canopy can be pushed back against the wall for increased head room
- ★ - 45% increase in capture area when hood is extended

PERFORMANCE

- 600 CFM Integrated Blower included
- Three fan speeds plus 10 minute high-power operation mode
- Built-in 'Clean Filter' reminder light illuminates after 40 hours of operation
- Delayed shut-off tackles lingering odors for up to 10 minutes
- Dimmer lighting—for those hours after a late meal
- Dishwasher-safe stainless-frame mesh filters
- Filter systems are highly efficient at capturing grease
- Powerfully Quiet® ventilation systems
- Sound insulation mats make this hood barely audible
- 6" Round duct size
- Vertical ducting direction
- Telescopic chimney—adjustable at installation
- Hood includes filters, backdraft damper and transition

DESIGN

- Brushed stainless steel finish
- Welded, polished seams for a flawless design
- Premium electronic touch controls
- Halogen lighting spotlights your best recipes

★ THERMADOR EXCLUSIVE

SPECIFICATIONS

Available Hood Widths	36"
Blower	600 CFM Blower Included
Duct Size at Discharge	6" Round
Ducting Direction	Vertical
Ceiling Heights	7 3/4 ft. to 9 1/2 ft.
Dishwasher-safe Filters	4 Mesh with Stainless-Frame
Halogen Lighting 12 Volt, 20 Watt Max., G-4 Base, Included	4 Bulbs
Electrical	120V AC, 60Hz

ACCESSORIES

Chimney Extension

CHIMXHDD

Stainless steel chimney hood extension for up to 11-foot ceiling applications. Extension replaces upper section of standard chimney extension. May require fabrication to reduce height.

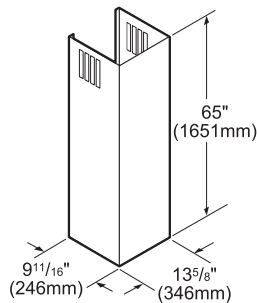

measurements in inches and mm

VENTILATION CHIMNEY WALL DRAWER HOOD (36")

HDDW36FS

INSTALLATION OPTIONS

Thermador Chimney Wall Hoods may be installed above a Thermador non-professional gas, electric, or induction cooktop to create a convenient cooking center. Refer to the appropriate section for additional specifications.

Hood installation height above a cooktop can vary. To obtain the necessary installation height above a Thermador non-professional gas, electric, or induction cooktop, consult the appliance's installation manual.

Thermador Chimney Wall Hoods must be mounted on a wall.

These hoods are designed to be used for vertical discharge. A 600 CFM integrated blower is included.

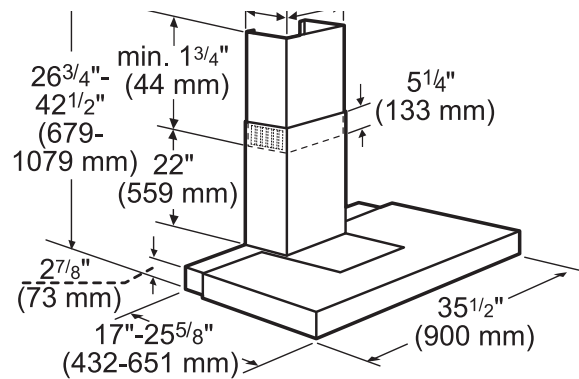

measurements in inches and mm

BLOWER PRESSURE CURVES

HDDW36FS

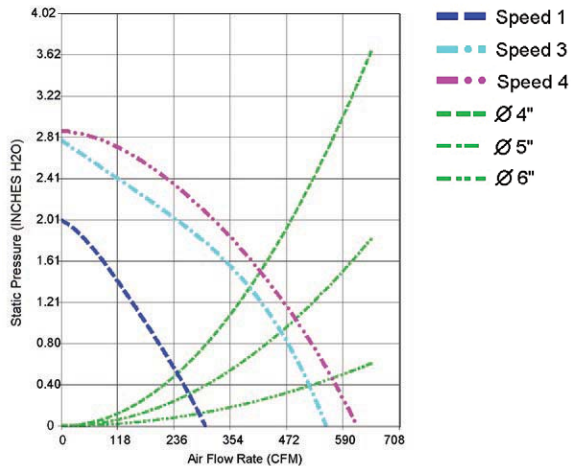

NOTE: All measurements are made with 3 ft. straight duct, 90° bend and 1 ft. straight duct at exhaust. These are NOT free blowing measurements.

INSTALLATION NOTE: This product ships with two transport brackets to hold the moveable canopy in place during shipping and installation. After installation, be sure to remove the brackets to operate the sliding drawer canopy.



Thermador

|▲|○|■|■|+|■|

VENTILATION

ISLAND

HOODS

Thermador Island Hoods put the finishing touches on your cooking system, with excellent overall efficiency in drawing away smoke, moisture and heat. The adjustable chimney height is perfect over island cooktop or range installations. Dishwasher-safe filters make cleanup easy.

ISLAND HOODS

FEATURES & BENEFITS



EXTERIOR CONTROLS

Easy-to-clean, easy-to-use push-button controls put accuracy at your fingertips.

POWERFULLY QUIET® OPERATION

Steam, smoke and odors are no problem for Thermador's ducted ventilation systems.

TIME-TO-CLEAN-FILTER LIGHT

Easy cleanup: All Thermador ventilation filters are dishwasher-safe, and many hoods feature a built-in Time-to-Clean-Filter reminder light.

DISHWASHER-SAFE FILTERS

Dishwasher-safe aluminum filters for easy-clean maintenance.

DELAYED SHUT-OFF

For the greatest efficiency, our ventilation models include delayed shut-off to tackle lingering odors.



HALOGEN LIGHTS

Bright halogen lighting spotlights your best recipes.

PLANNING INFORMATION

MODEL OPTIONS

Thermador Island Hoods are available in 40-inch, 42-inch and 48-inch widths and feature a stainless steel design and the 40-inch has an elegant glass canopy. All of our island hoods are adjustable to suit ceiling heights of up to 9'.

ELECTRICAL SPECIFICATIONS

Be sure your Thermador Island Hood is properly installed and grounded by a qualified technician. Installation, electrical connections and grounding must comply with all applicable local codes.

MODEL	REQUIRED CIRCUIT BREAKER
	120V AC, 60 Hz
HPIN42HS, HPIN48HS HPIB42HS, HPIB48HS HMIB40HS	Max 10 Amp

INSTALLATION CONSIDERATIONS

The information in this design guide provides key features, product dimensions and installation specifications. Before installing a Thermador Island Hood, be sure to verify the dimensions and electrical connections. Also, always consult with the installation manual packed with the product for complete details before installing.

Thermador Island Hoods may be installed above Thermador Cooktops to create a convenient cooking center. Refer to the appropriate section for additional specifications.

HOOD WIDTH

The hood width should be no less than the width of the cooking surface. Where space is not restricted, a wider hood can be used to increase your capture area. Island installations require a greater capture area; therefore the hoods used should overlap your cooking surface by a minimum of 3" to 6" on either side.

DISTANCE FROM COOKING SURFACE

Proper mounting height is very important. If a hood is mounted too low, it may be difficult to cook and be unsafe. If a hood is mounted too high, performance may be compromised. For optimal performance, the distance from the cooking surface to the bottom of the hood should be a minimum of 30", unless otherwise noted. Please refer to the installation manual for each hood and cooktop / range model for proper hood mounting heights.

ISLAND HOODS PLANNING INFORMATION

AVAILABLE CEILING HEIGHT

The standard ceiling height can vary from region to region and in homes built in different eras. Ceiling heights, even in the same room, can sometimes vary by as much as several inches. Kitchen ceiling heights can vary between 7'6" (or 90") to over 10' (or 120").

Before selecting a Thermador Hood, check the available installation space and any extra space that may remain after proper installation of a hood and cooktop or range. This extra space can be filled using Thermador's stainless steel duct cover accessories. The space can also be adjusted by raising or lowering your hood within the recommended range (typically 30" to 36" above the cooking surface).

CHOOSING THE CORRECT BLOWER

A variety of interior and exterior blower options (Remote or Inline) are available for Thermador's Island Hoods. If the unit you have selected does not have a blower, one can be purchased separately. Blower selection will vary based on the volume of air that needs to be moved and the length and location of the duct run. For long duct runs with multiple turns and bends, consider using a more powerful blower. For the most efficient air flow exhaust, use a straight run or as few elbows as possible.

Remote Blowers (VTR Series)

Depending on your preference and ducting situation, these blowers can be mounted on the roof or exterior wall of your home. An exterior installation may be more appealing to reduce noise in the kitchen.

Inline Blowers (VTI Series)

To minimize noise in the kitchen, these blowers are mounted along the duct line anywhere between the kitchen and the exterior wall. If you have easy access to your duct line (in an attic, for example), this may be an appealing option.

CHOOSING THE RIGHT CFM

The power of the cooktop or range, measured in BTU, is perhaps the most important factor in determining CFM needs for a hood.

You should also consider the cooking space and cooking style of your client.

- More demanding cooks usually require more exhaust capacity to handle moisture generated by boiling large pots of water or the grease and smoke resulting from grilling or frying. This cooking style could require a hood or downdraft system with airflow of 600 to 1,300 CFM.
- For those who are used to preparing quick meals in a relatively small kitchen, a hood with 400 to 600 CFM may be adequate ventilation for the cooking space.
- If the cooking surface is in a peninsula or island, a larger capacity hood can provide better capture when there are cross currents and when the hood needs to be mounted higher. Downdraft ventilation systems are also a good alternative.
- High heat cooking or aromatic foods may require additional CFM. Increasing capture area by 3" on each side is also a recommended way to address this issue.

LENGTH AND SIZE OF DUCTWORK

Do not use flexible duct; it creates back pressure / air turbulence and reduces performance.

Straight runs and gradual turns are best. Use the shortest route with the fewest turns possible.

Proper performance is dependent upon proper ducting. Use a qualified and trained installer. Local building codes may require the use of make-up air systems when using ducted ventilation systems greater than specified CFM of air movement. The specified CFM varies from locale to locale. Consult your HVAC professional for specific requirements in your area.

If using a 10" duct, Thermador recommends not exceeding 50 feet of duct. Transitions, elbows and wall or roof caps are all factors that will add more static pressure, therefore increasing your equivalent duct run.

WARRANTY

Limited warranty parts and labor (2 year)



See page 298 for additional warranty details.

VENTILATION

LOW PROFILE ISLAND HOOD (42"/48")

HPIN42HS / HPIN48HS



PROFESSIONAL

HPIN42HS – 42-Inch

HPIN48HS – 48-Inch

HPIN42HS / HPIN48HS

PERFORMANCE

- Three fan speeds
- Built-in 'Clean Filter' reminder light illuminates after 40 hours of operation
- Delayed shut-off tackles lingering odors for up to 10 minutes
- Dishwasher-safe frameless filters with stainless steel covers
- Filter systems are highly efficient at capturing grease
- Powerfully Quiet® ventilation systems
- Vertical ducting direction
- 6" round duct size
- Blowers sold separately

DESIGN

- Sleek appearance does not obstruct views beyond the kitchen
- Chiseled design for a seamless integration into any kitchen
- Halogen lighting spotlights your best recipes
- Brushed stainless steel finish
- Stainless steel control buttons

SPECIFICATIONS

Available Hood Widths	42" / 48"
Blower	Sold Separately — See Blower Options Table
Duct Size at Discharge	6" Round
Ducting Direction	Vertical
Ceiling Heights	8' 2" ft. to 9 ft.*
Dishwasher-safe Filters	Stainless Steel Filter
Halogen Lighting 12 Volt, 20 Watt Max., G-4 Base, Included	4 Bulbs
Electrical	120V AC, 60 Hz

*For 30" clearance above cooktop, minimum 98" ceiling height required

VENTILATION LOW PROFILE ISLAND HOOD (42"/48")

HPIN42HS / HPIN48HS

INSTALLATION OPTIONS

Thermador Island Hoods may be installed above a Thermador Cooktop to create a convenient cooking center. Refer to the appropriate section for additional specifications.

Hood installation height above a cooktop can vary. To obtain the necessary installation height above a Thermador Cooktop, consult the appliance's installation manual.

Thermador Island Hoods are suspended from the ceiling. These hoods are designed to be used for vertical discharge. A blower must be purchased separately.

HOOD DIMENSIONS

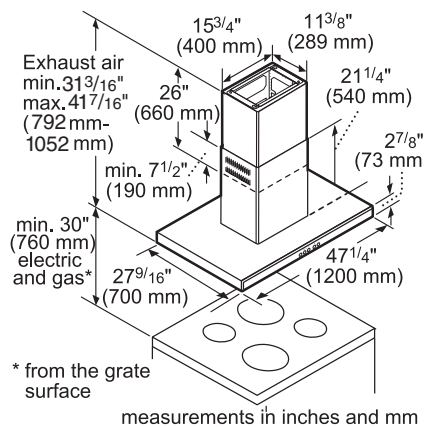
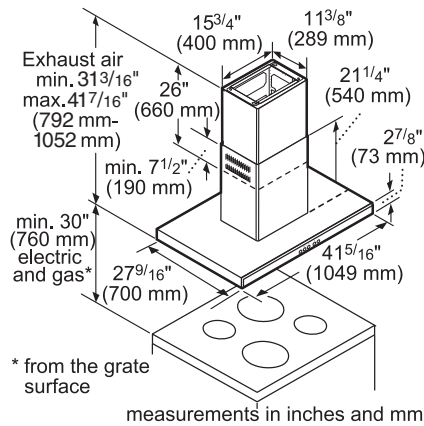

BLOWER OPTIONS

REMOTE

VTR630D – 600 CFM	Use Roofplate RFPLT600 in roof-mount applications
VTR1030D – 1000 CFM	Use Roofplate RFPLT1000 in roof-mount applications
VTR1330E – 1300 CFM	Use Roofplate RFPLT1000 in roof-mount applications

INLINE

VTI610D – 600 CFM
VTI1010D – 1000 CFM

See page 175 for further details.

REMOTE BLOWER ACCESSORIES

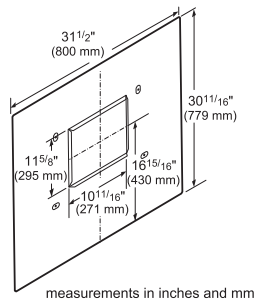
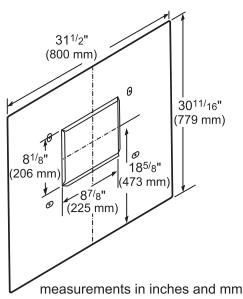

Roofplate RFPLT600
For use with Remote Blower VTR630D

Roofplate RFPLT1000
For use with Remote Blowers VTR1030D and VTR1330E

REMOTE (Mounted to roof or external wall)

1000 and 1300 CFM Blowers will require transition from 6" to 10" ducting

VTR630D – 600 CFM

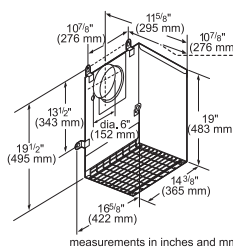

VTR1030D – 1000 CFM

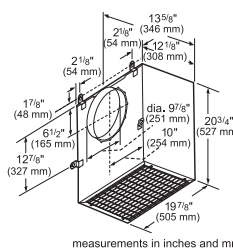

VTR1330E – 1300 CFM

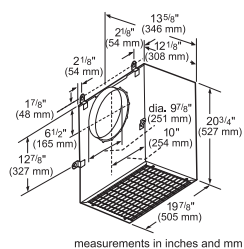

INLINE (Mounted between kitchen and external wall)

1000 and 1300 CFM Blowers will require transition from 6" to 10" ducting

VTI610D – 600 CFM

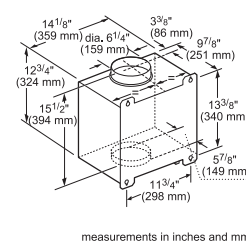

VTI1010D – 1000 CFM

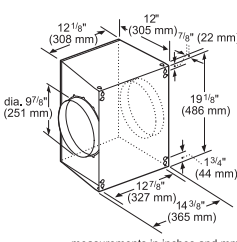

EXTNCB25

25 ft. Blower Connector Cable for use with the following Inline and Remote blowers: VTR630D, VTR1030D, VTR1330E, VTI610D, VTI1010D

VENTILATION

LOW PROFILE ISLAND HOOD WITH BLOWER (42"/48")

HPIB42HS / HPIB48HS



MASTERPIECE®

HPIB42HS – 42-Inch

HPIB48HS – 48-Inch

SPECIFICATIONS

Available Hood Widths	42" / 48"
Blower	600 CFM Blower Included
Duct Size at Discharge	6" Round
Ducting Direction	Vertical
Ceiling Heights	8' 2" ft. to 9 ft.
Dishwasher-safe Filters	Stainless Steel Filter
Halogen Lighting 12 Volt, 20 Watt Max., G-4 Base, Included	4 Bulbs
Electrical	120V AC, 60 Hz

HPIB42HS / HPIB48HS

PERFORMANCE

- 600 CFM Integrated Blower included
- Recirculation possible with kit RECIRISL
- Three fan speeds
- Built-in 'Clean Filter' reminder light illuminates after 40 hours of operation
- Delayed shut-off tackles lingering odors for up to 10 minutes
- Dishwasher-safe frameless filters with stainless steel covers
- Filter systems are highly efficient at capturing grease
- Powerfully Quiet® ventilation systems
- 6" Round duct size
- Vertical ducting direction
- All-in-one solution with an integrated blower included
- Hood includes filters, backdraft damper and transition
- Replacement charcoal filters available (CHFILISL)

DESIGN

- Sleek appearance does not obstruct views beyond the kitchen
- Brushed stainless steel finish
- Chiseled design for a seamless integration into any kitchen
- Halogen lighting spotlights your best recipes
- Stainless steel control buttons

ACCESSORIES

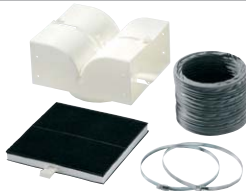

Island Hood Recirculation Kit

- RECIRISL
- Stainless steel finish
 - Perfect for hard to duct installations
 - Use with 600 CFM blowers only



Replacement Charcoal Filters

- CHFILISL
- For use with Recirculation Kit RECIRISL

VENTILATION GLASS ISLAND HOOD WITH BLOWER (40")

HMIB40HS



MASTERPIECE®

HMIB40HS – 40-Inch

SPECIFICATIONS

Available Hood Width	40"
Blower	600 CFM Blower Included
Duct Size at Discharge	6" Round
Ducting Direction	Vertical
Ceiling Heights	8' 2" ft. to 9 ft.
Dishwasher-safe Filters	Stainless Steel Mesh Filter
Halogen Lighting 12 Volt, 20 Watt Max., G-4 Base, Included	4 Bulbs
Electrical	120V AC, 60 Hz

HMIB40HS

PERFORMANCE

- 600 CFM Integrated Blower included
- An ideal solution for island cooktop installations
- Four fan speeds including one intensive level
- Built-in 'Clean Filter' reminder light illuminates after 40 hours of operation
- Delayed shut-off tackles lingering odors for up to 10 minutes
- Dimmer lighting – for a soft lighting effect completely adjustable by user
- Dishwasher-safe stainless steel mesh filters
- Filter systems are highly efficient at capturing grease
- Easy-to-operate control buttons
- Powerfully Quiet® ventilation systems
- Perfect fit for 30" & 36" cooktops
- 6" Round duct size
- Vertical ducting direction

DESIGN

- Stunning combination of glass and stainless steel with Masterpiece® design elements
- Chiseled design for a seamless integration into any kitchen
- Halogen lighting spotlights your best recipes
- Brushed stainless steel finish
- Premium electronic touch controls

ACCESSORIES

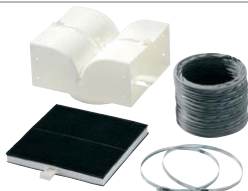

Island Hood Recirculation Kit

- RECIRISL
- Stainless steel finish
 - Perfect for hard to duct installations
 - Use with 600 CFM blowers only



Replacement Charcoal Filters

- CHFILISL
- For use with Recirculation Kit RECIRISL

VENTILATION GLASS ISLAND HOOD WITH BLOWER (40")

HMIB40HS

INSTALLATION OPTIONS

Thermador Island Hoods may be installed above a Thermador Masterpiece® Cooktop to create a convenient cooking center. Refer to the appropriate section for additional specifications.

Hood installation height above a cooktop can vary. To obtain the necessary installation height above a Thermador Cooktop, consult the appliance's installation manual.

Thermador Island Hoods are suspended from the ceiling. These hoods are designed to be used for vertical discharge. A 600 CFM blower is included.

BLOWER PRESSURE CURVES

HMIB40HS

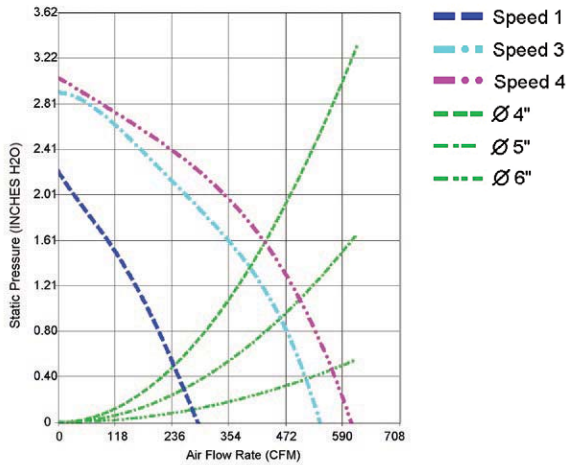

NOTE: All measurements are made with 3 ft. straight duct, 90° bend and 1 ft. straight duct at exhaust. These are NOT free blowing measurements.

EXTERNAL EXHAUST

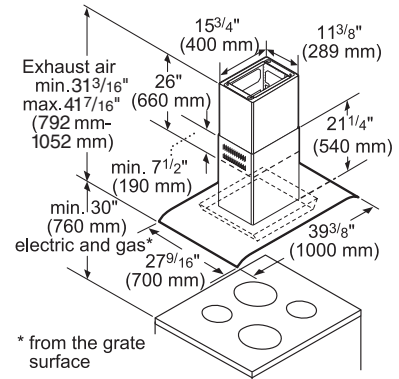

measurements in inches and mm

INTERNAL RECIRCULATION

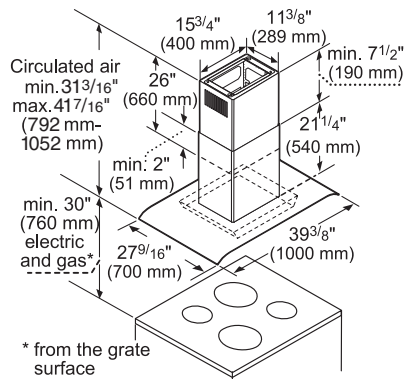

measurements in inches and mm



VENTILATION CUSTOM INSERTS

Use Thermador Custom Hood Inserts within custom hood applications to create a seamless design with wall or island applications. These inserts efficiently and quietly remove odor and steam with easy-to-access controls. Inserts are available for both professional and non-professional applications.

CUSTOM INSERTS FEATURES & BENEFITS



HALOGEN LIGHTS

Bright halogen lighting spotlights your best recipes.

CUSTOM HOOD INSERT

Specially designed for professional custom hood applications to create a concealed ventilation system.

TIME-TO-CLEAN-FILTER LIGHT

Easy cleanup: All Thermador ventilation filters are dishwasher-safe, and feature a built-in Time-to-Clean-Filter reminder light.

DELAYED SHUT-OFF

For the greatest efficiency, our ventilation models include delayed shut-off to tackle lingering odors.

PUSH BUTTON CONTROLS

Concealed three-speed, push-button controls are easy to use.

BAFFLE FILTERS

The commercial style baffle filters make high-grease cooking easy. The dishwasher-safe filters are stainless steel.



REMOTE VENTILATION CONTROL

Remote controls for customized ventilation applications are easy to use and have a sophisticated and professional style. (photo represents VCI2REMFS)



MESH FILTERS

Aluminum mesh filters with stainless steel frame maximize grease capture without affecting flow. (VCI230DS, VCI236DS, VCI248DS only)

BAFFLE FILTERS

Stainless steel commercial-style baffle filters maximize grease capture and they're dishwasher safe for easy clean-up. (VCIN and VCIB Series)

PLANNING INFORMATION

MODEL OPTIONS

Thermador Custom Hood Inserts are available for both professional and non-professional applications. The Professional Series Custom Hood Inserts are available in 36-inch, 48-inch, and 54-inch widths. The Masterpiece® Series Custom Hood Inserts are available in 30-inch, 36-inch, and 48-inch widths.

ELECTRICAL SPECIFICATIONS

Be sure your Thermador Custom Insert is properly installed and grounded by a qualified technician. Installation, electrical connections and grounding must comply with all applicable local codes.

MODEL	REQUIRED CIRCUIT BREAKER
	120V AC, 60 Hz
VCIN36JP, VCIB36JP, VCIN48JP, VCIB48JP, VCIN54JP, VCIB54JP, VCI230DS, VCI236DS, VCI248DS	15 Amp

INSTALLATION CONSIDERATIONS

The information in this design guide provides key features, product dimensions and installation specifications. Before installing a Thermador Custom Hood Insert, be sure to verify the dimensions and electrical connections. Also, always consult with the installation manual packed with the product for complete details before installing.

Professional Custom Series Hood Inserts are designed for installation with all professional-style cooktops and ranges. Masterpiece® Custom Series Hood Inserts are designed for installation with non-professional gas, electric or induction cooktops. Refer to the appropriate section for additional specifications.

HOOD WIDTH

The hood width should be no less than the width of the cooking surface. Where space is not restricted, a wider hood can be used to increase your capture area.

DISTANCE FROM COOKING SURFACE

Proper mounting height is very important. If a hood is mounted too low, it may be difficult to cook and be unsafe. If a hood is mounted too high, performance may be compromised. For optimal performance, the distance from the cooking surface to the bottom of the hood should be a minimum of 30", unless otherwise noted. Please refer to the installation manual for each hood and cooktop / range model for proper hood mounting heights.

CHOOSING THE CORRECT BLOWER

A variety of interior and exterior blower options Remote, Inline or Integrated are available for Thermador's Professional and Masterpiece® Series Hoods. If the unit you have selected does not have a blower included, one can be purchased separately. Blower selection will vary based on the volume of air that needs to be moved and the length and location of the duct run. For long duct runs with multiple turns and bends, consider using a more powerful blower.

Remote Blowers (VTR Series)

Depending on your preference and ducting situation, these blowers can be mounted on the roof or exterior wall of your home. An exterior installation may be more appealing to reduce noise in the kitchen.

Inline Blowers (VTI series)

To minimize noise in the kitchen, these blowers are mounted along the duct line anywhere between the kitchen and the exterior wall. If you have easy access to your duct line (in an attic, for example), this may be an appealing option.

Integrated Blowers (VTN series)

These blowers are included and are integrated into the hood or onto the downdraft unit at the time of installation. This option allows you to select your ideal hood with the exact power you require.

CHOOSING THE RIGHT CFM

The power of the cooktop or range, measured in BTU, is perhaps the most important factor in determining CFM needs for a hood.

You should also consider the cooking space and cooking style of your client.

- More demanding cooks usually require more exhaust capacity to handle moisture generated by boiling large pots of water or the grease and smoke resulting from grilling or frying. This cooking style could require a hood or downdraft system with airflow of 600 to 1,300 CFM.
- For those who are used to preparing quick meals in a relatively small kitchen, a hood with 400 to 600 CFM may be adequate ventilation for the cooking space.
- If the cooking surface is in a peninsula or island, a larger capacity hood can provide better capture when there are cross currents and when the hood needs to be mounted higher. Downdraft ventilation systems are also a good alternative.
- High heat cooking or aromatic foods may require additional CFM. Increasing capture area by 3" on each side is also a recommended way to address this issue.

LENGTH AND SIZE OF DUCTWORK

Do not use flexible duct; it creates back pressure / air turbulence and reduces performance.

Straight runs and gradual turns are best. Use the shortest route with the fewest turns possible.

Proper performance is dependent upon proper ducting. Use a qualified and trained installer. Local building codes may require the use of make-up air systems when using ducted ventilation systems greater than specified CFM of air movement. The specified CFM varies from locale to locale. Consult your HVAC professional for specific requirements in your area.

If using a 10" duct, Thermador recommends not exceeding 50 feet of duct. Transitions, elbows and wall or roof caps are all factors that will add more static pressure, therefore increasing your equivalent duct run.

INSTALLATION NOTE: Professional Rangetops and Ranges require that minimum distances be maintained from the cooking surface to combustible materials (i.e. a wood covering around the insert). These minimum distances range from 30" to 36" and can vary from product to product and by manufacturer. Refer to the installation manual of the rangetop or range prior to the design and installation of the custom hood insert.

WARRANTY

Limited warranty parts and labor (2 year).



See page 298 for additional warranty details.

VENTILATION CUSTOM INSERT (36"/48"/54")

VCIN36JP / VCIN48JP / VCIN54JP



PROFESSIONAL

VCIN36JP – 36-Inch

VCIN48JP – 48-Inch

VCIN54JP – 54-Inch

Custom hood insert for use within wall or island custom hood applications

SPECIFICATIONS

Available Hood Widths	36" / 48" / 54"
Blower	Sold Separately See Blower Options Table
Duct Size at Discharge	10" Round
Ducting Direction	Vertical
Dishwasher-safe Filters	Stainless Steel Baffles
Halogen Lighting 120 V, 40 Watt Max., G-9 Base, Included	36" – 2 Bulbs 48" / 54" – 4 Bulbs
Electrical	120V AC, 60Hz

VCIN36JP / VCIN48JP / VCIN54JP

PERFORMANCE

- Suitable for wall or island applications
- Three fan speeds
- Auto function senses heat from the cooking surface and adjusts fan speeds
- Built-in 'Clean Filter' reminder light illuminates after 40 hours of operation
- Delayed shut-off tackles lingering odors for up to 10 minutes
- Dishwasher-safe stainless steel baffle filters
- Filter systems are highly efficient at capturing grease
- Deep capture area allows for efficient capture of smoke and steam
- Powerfully Quiet® ventilation systems
- 10" duct outlet

DESIGN

- Stainless steel button controls
- Halogen lighting spotlights your best recipes
- Remote control accessory (operation of controls only from remote)

ROOF JACK, WALL CAP & TRANSITION

Roof Jack – RJ310

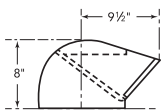

8-Inch Wall Cap – WC8

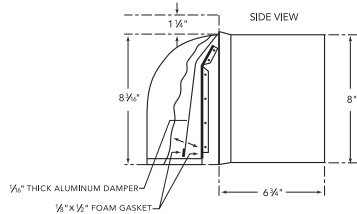

Wall Cap – WC310

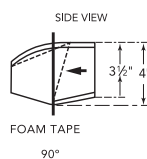

10-Inch Wall Cap – WC10

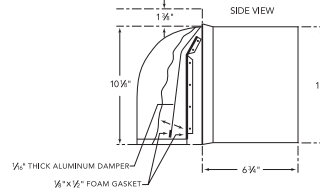

Transition

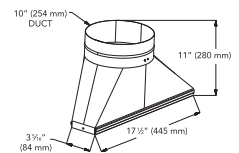

ACCESSORIES

Custom Hood Liners

LINER236 For 36" Insert VCIN36JP

LINER248 For 48" Insert VCIN48JP

LINER254 For 54" Insert VCIN54JP

- Stainless steel custom hood liners to protect the exterior base of custom insert

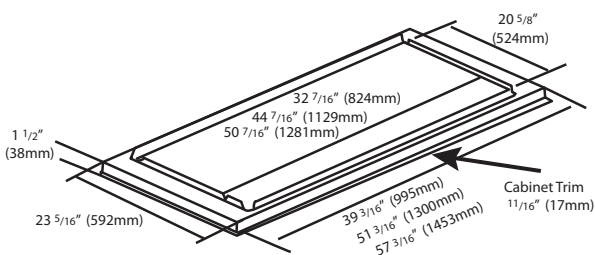

Remote Control Panel

VCI2REMK5

- Stainless steel finish
- Cable-connected to blower and hood controls (operation of controls only from remote)
- Cable length 30 ft.

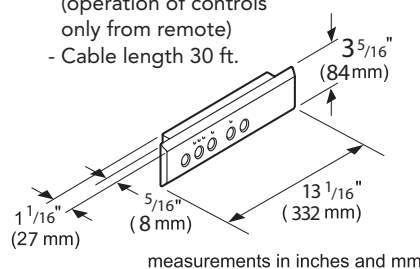

Stainless Steel Backsplash

PA36JBS 36" wide

PA48JBS 48" wide

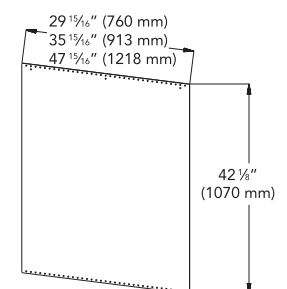

VENTILATION CUSTOM INSERT (36"/48"/54")

VCIN36JP / VCIN48JP / VCIN54JP

INSTALLATION OPTIONS

Thermador Custom Hood Inserts within custom hood applications create a seamless design with wall or island applications.

Thermador Professional® Series Custom Hood Inserts may be installed above a Thermador Professional® Cooktop or Range to create a convenient cooking center. Refer to the appropriate section for additional specifications.

Hood installation height above a cooktop can vary. Professional Rangetops and Ranges require that minimum distances be maintained from the cooking surface to combustible materials (i.e. a wood covering around the insert). These minimum distances range from 30" to 36" and can vary from product to product and by manufacturer. Refer to the installation manual of the rangetop or range prior to the design and installation of the custom hood insert.

These hoods are designed to be used for vertical discharge. A blower must be purchased separately.

BLOWER OPTIONS (for VCIN__JP)

REMOTE	
VTR630D – 600 CFM	Use Roofplate RFPLT600 in roof-mount applications
VTR1030D – 1000 CFM	Use Roofplate RFPLT1000 in roof-mount applications
VTR1330E – 1300 CFM	Use Roofplate RFPLT1000 in roof-mount applications

INLINE	
VTI610D – 600 CFM	
VTI1010D – 1000 CFM	
INTEGRATED	
VTN630N – 600 CFM	
VTN1030N – 1000 CFM	

See page 185 for further details.

REMOTE BLOWER ACCESSORIES

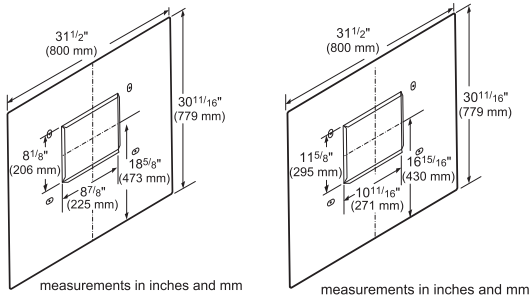

Roofplate RFPLT600
For use with Remote Blower VTR630D

Roofplate RFPLT1000
For use with Remote Blowers VTR1030D and VTR1330E

EXTNCB25

25 ft. Blower Connector Cable for use with the following Inline and Remote blowers: VTR630D, VTR1030D, VTR1330E, VTI610D, VTI1010D

HOOD DIMENSIONS

(See installation manual for complete planning instructions)

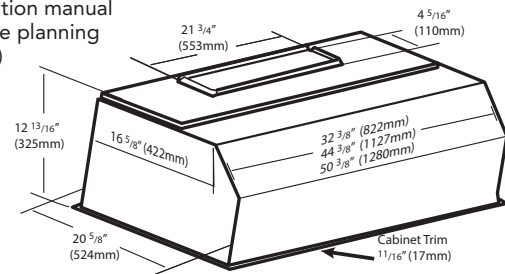

CUTOUT DIMENSIONS WHEN NOT USING A LINER

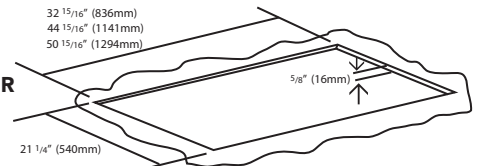

REMOTE (Mounted to roof or external wall)

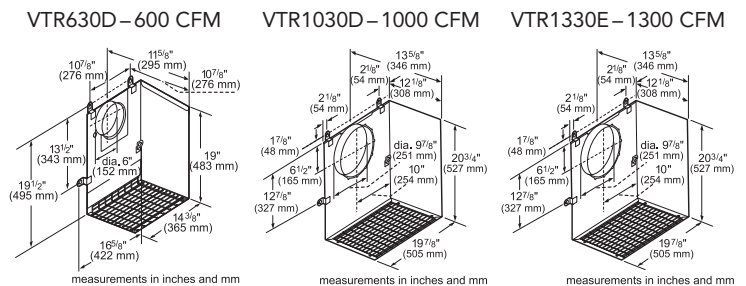

INLINE (Mounted between kitchen and external wall)

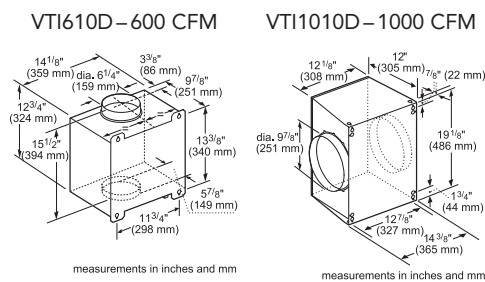

INTEGRATED (Mounted in hood)

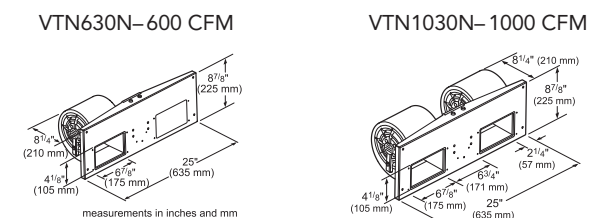

VENTILATION CUSTOM INSERT WITH BLOWER (36"/48"/54")

VCIB36JP / VCIB48JP / VCIB54JP



PROFESSIONAL

VCIB36JP – 36-Inch

VCIB48JP – 48-Inch

VCIB54JP – 54-Inch

Custom hood insert for use within wall or island custom hood applications

SPECIFICATIONS

Available Hood Widths	36" / 48" / 54"
Blower	Integrated 1000 CFM Blower Included
Duct Size at Discharge	10" Round
Ducting Direction	Vertical
Dishwasher-safe Filters	Stainless Steel Baffles
Halogen Lighting 120 V, 40 Watt Max., G-9 Base, Included	36" – 2 Bulbs 48" / 54" – 4 Bulbs
Electrical	120V AC, 60Hz

VCIB36JP / VCIB48JP / VCIB54JP

PERFORMANCE

- Suitable for wall or island applications
- Three fan speeds
- Auto function senses heat from the cooking surface and adjusts fan speeds
- Built-in 'Clean Filter' reminder light illuminates after 40 hours of operation
- Delayed shut-off tackles lingering odors for up to 10 minutes
- Dishwasher-safe stainless steel baffle filters
- Filter systems are highly efficient at capturing grease
- Deep capture area allows for efficient capture of smoke and steam
- Powerfully Quiet® ventilation systems
- 10" duct outlet

DESIGN

- A unique all in one box solution that includes the hood, a 1,000 CFM blower, liner, baffle filters, lights, transition and a back-draft damper
- Stainless steel button controls
- Halogen lighting spotlights your best recipes
- Remote control accessory (operation of controls only from remote)

ROOF JACK, WALL CAP & TRANSITION

Roof Jack – RJ310

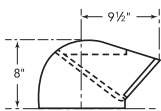

8-Inch Wall Cap – WC8

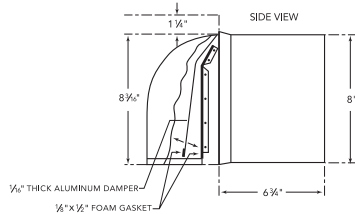

Wall Cap – WC310

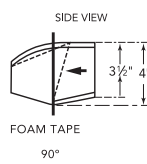

10-Inch Wall Cap – WC10

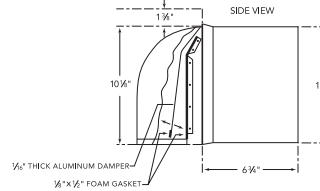

Transition

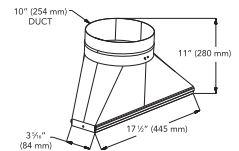

ACCESSORIES

Remote Control Panel

VC12REMKS

- Stainless steel finish
- Cable-connected to blower and hood controls (operation of controls only from remote)
- Cable length 30 ft.

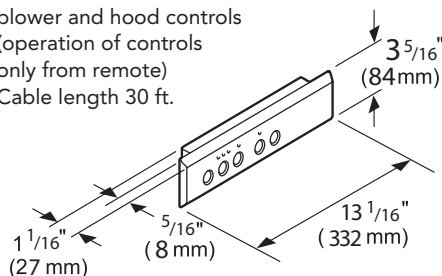

measurements in inches and mm

Stainless Steel
Backsplash

PA36JBS 36" wide
PA48JBS 48" wide

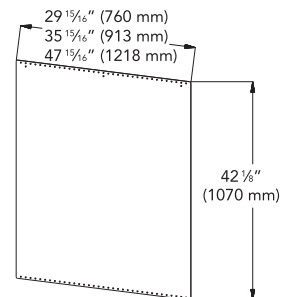

VENTILATION CUSTOM INSERT WITH BLOWER (36"/48"/54")

VCIB36JP / VCIB48JP / VCIB54JP

INSTALLATION OPTIONS

Thermador Custom Hood Inserts within custom hood applications create a seamless design with wall or island applications.

Thermador Professional® Series Custom Hood Inserts may be installed above a Thermador Professional® Cooktop or Range to create a convenient cooking center. Refer to the appropriate section for additional specifications.

Hood installation height above a cooktop can vary. Professional Rangetops and Ranges require that minimum distances be maintained from the cooking surface to combustible materials (i.e. a wood covering around the insert). These minimum distances range from 30" to 36" and can vary from product to product and by manufacturer. Refer to the installation manual of the rangetop or range prior to the design and installation of the custom hood insert.

These hoods are designed to be used for vertical discharge.

HOOD DIMENSIONS

(See installation manual for complete planning instructions)

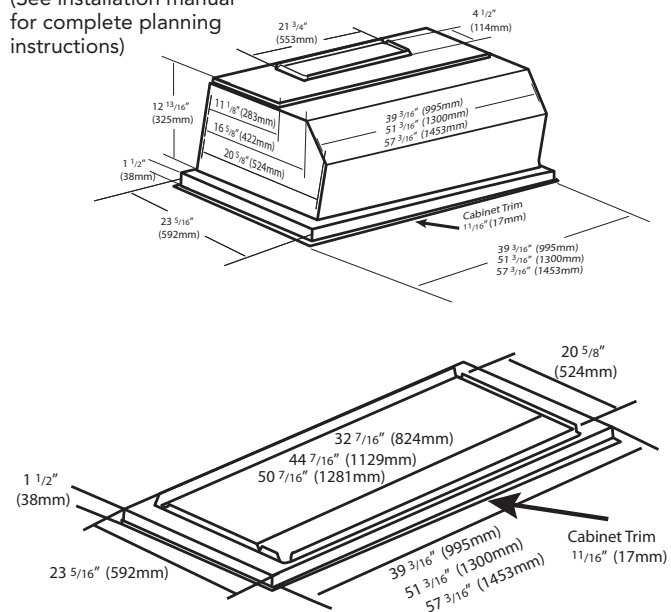

BLOWER PRESSURE CURVES

VCIB_JP

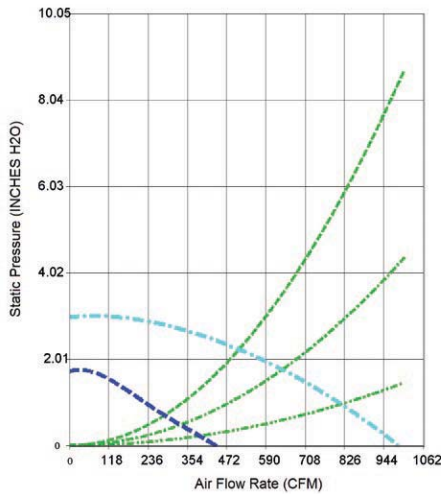

NOTE: All measurements are made with 3 ft. straight duct, 90° bend and 1 ft. straight duct at exhaust. These are NOT free blowing measurements.

CUTOUT DIMENSIONS WHEN USING A LINER

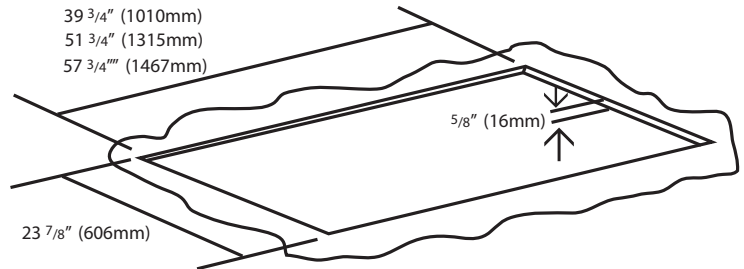

VENTILATION CUSTOM INSERT (30"/36"/48")

VCI230DS / VCI236DS / VCI248DS



MASTERPIECE®

VCI230DS – 30-Inch

VCI236DS – 36-Inch

VCI248DS – 48-Inch

Custom hood insert for use within wall or island custom hood applications

SPECIFICATIONS

Available Hood Widths	30" / 36" / 48"
Blower	Sold Separately — See Blower Options Table
Duct Size at Discharge	10" Round
Ducting Direction	Vertical
Dishwasher-safe Filters	Mesh (Baffle filters sold as an accessory)
Halogen Lighting	30" / 36" – 2 Bulbs 48" – 4 Bulbs
Electrical	120V AC, 60Hz

VCI230DS / VCI236DS / VCI248DS

PERFORMANCE

- Suitable for wall or island applications
- Three fan speeds
- Built-in 'Clean Filter' reminder light illuminates after 40 hours of operation
- Delayed shut-off tackles lingering odors for up to 10 minutes
- Dishwasher-safe aluminum mesh filters
- Filter systems are highly efficient at capturing grease
- Deep capture area allows for efficient capture of smoke and steam
- Powerfully Quiet® ventilation systems
- 10" Round duct size
- Vertical ducting direction
- Blowers sold separately
- Choose from Inline and Remote Blowers
- Accessories include: Liner, Remote Control and Stainless Steel Baffle Filters

DESIGN

- Stainless steel button controls
- Halogen lighting spotlights your best recipes

ROOF JACK & WALL CAP (For Integral and Inline blowers)

Roof Jack – RJ310

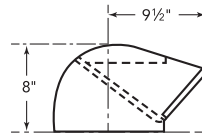

8-Inch Wall Cap – WC8

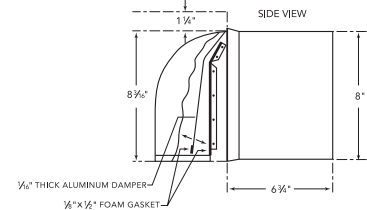

Wall Cap – WC310

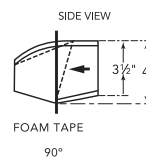

10-Inch Wall Cap – WC10

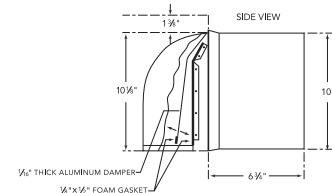

ACCESSORIES

Custom Hood Liners

LINER30 for 30" Insert
LINER36 for 36" Insert
LINER48 for 48" Insert

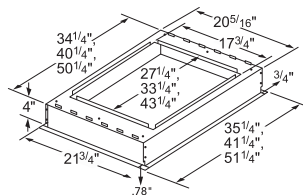

- Stainless steel custom hood liners to protect the exterior base of custom insert
- Custom hood liner completes custom insert installation

Remote Control Panel

VCI2REMFS

- Stainless steel finish
- Cable-connected to blower and hood controls (operation of controls only from remote)
- Cable length 13 ft.

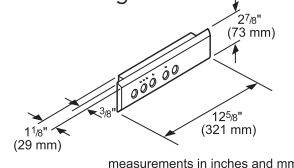

measurements in inches and mm

Baffle Filters

BAFFLT30 30" wide
BAFFLT36 36" wide
BAFFLT48 48" wide



- Stainless steel finish
- Unique low profile design maximizes grease capture
- Dishwasher-safe for easy cleanup

VENTILATION CUSTOM INSERT (30"/36"/48")

VCI230DS / VCI236DS / VCI248DS

INSTALLATION OPTIONS

Thermador Custom Hood Inserts within custom hood applications create a seamless design with wall or island applications.

Thermador Masterpiece Series Custom Hood Inserts may be installed above Thermador Cooktops to create a convenient cooking center. Refer to the appropriate section for additional specifications.

Hood installation height above a cooktop can vary. Cooktops require that minimum distances be maintained from the cooking surface to combustible materials (i.e. a wood covering around the insert). These minimum distances range from 30" to 36" and can vary from product to product and by manufacturer. Refer to the installation manual of the rangetop or range prior to the design and installation of the custom hood insert.

These hoods are designed to be used for vertical discharge. A blower must be purchased separately.

HOOD DIMENSIONS

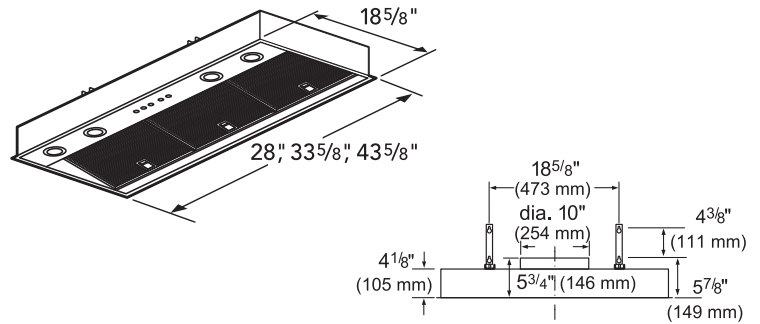

BLOWER OPTIONS

REMOTE

VTR630D – 600 CFM	Use Roofplate RFPLT600 in roof-mount applications
VTR1030D – 1000 CFM	Use Roofplate RFPLT1000 in roof-mount applications
VTR1330E – 1300 CFM	Use Roofplate RFPLT1000 in roof-mount applications

INLINE

VTI610D – 600 CFM	
VTI1010D* – 1000 CFM	

INTEGRATED

VTI1010D* – 1000 CFM	Inline blower can be used for an integrated solution
----------------------	------------------------------------------------------

See pages 194 for further details.

*Please visit thermador.com for tips & hints on installation of VTI1010D as an integrated solution

REMOTE (Mounted to roof or external wall)

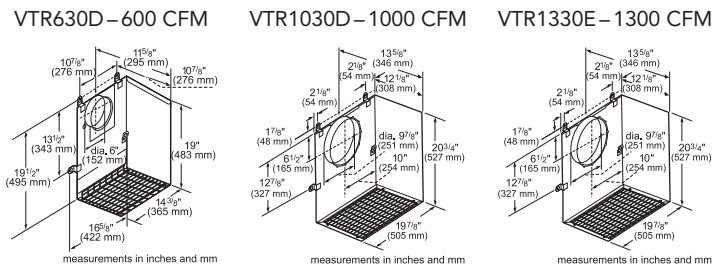

INLINE (Mounted between kitchen and external wall)

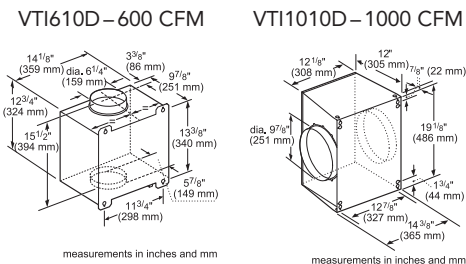

*Please refer to thermador.com for tips and hints on installation of VTI1010D as an integrated solution

REMOTE BLOWER ACCESSORIES

Roofplate
RFPLT600
For use with
Remote Blower
VTR630D

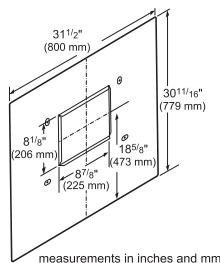

Roofplate
RFPLT1000
For use with
Remote Blower
VTR1030D

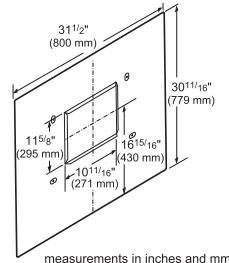

EXTNCB25

25 ft. Blower Connector Cable for use with the following Inline and Remote blowers: VTR630D, VTR1030D, VTR1330E, VTI610D, VTI1010D



VENTILATION DOWNDRAFT

If you prefer a concealed look, choose a Thermador Downdraft Ventilation Unit, which offers space efficiency when a hood is not preferred. The full-face filter combines a filter with a splatter shield in one easy-to-remove, dishwasher-safe element. Thermador invented the first retractable downdraft, and was also the first to introduce a recirculation option for downdrafts—making ventilation possible in any kitchen.

DOWNDRAFT FEATURES & BENEFITS



FULL 13-INCH RISE

With an over 13-inch intake, the UCVM rises well above even the tallest pans. This protects against splatters when cooking and provides better performance in capturing steam and smoke—even from the front burners.

DOWNDRAFT RECIRCULATION OPTION

Downdraft recirculation is now available for island or wall applications. Combine the performance of the UCVM Downdraft with the odor- and grease-capturing filters in the Recirculation Module for the perfect ventilation combination for anywhere in your kitchen.

FULL-FACE FILTERS

Full-face filters combine a filter with a splatter shield in one easy-to-remove, dishwasher-safe element. These filters maximize grease capture without affecting airflow.

PLANNING INFORMATION

MODEL OPTIONS

Thermador Downdraft Hoods are available in 30 and 36-inch widths to fit your kitchen plans and are meticulously crafted for both function and design. Be sure to reference the correct model information in this design guide.

ELECTRICAL SPECIFICATIONS

Be sure your Thermador Downdraft Hood is properly installed and grounded by a qualified technician. Installation, electrical connections and grounding must comply with all applicable local codes.

MODEL	REQUIRED CIRCUIT BREAKER
	120V AC, 60 Hz
UCVM30FS, UCVM36FS	15 Amp

INSTALLATION CONSIDERATIONS

The information in this design guide provides key features, product dimensions, cutouts and installation specifications. Before installing a Thermador Downdraft Hood, be sure to verify the cutout dimensions and electrical connections. Also, always consult with the installation manual packed with the product for complete details before installing.

Thermador Downdraft Hoods may be installed in a wall or island behind a Thermador non-professional gas, electric or induction cooktop to create a convenient cooking center. Refer to the appropriate section for additional specifications.

HOOD WIDTH

Downdraft ventilation units should be the same width as the cooking surfaces they are ventilating.

CHOOSING THE CORRECT BLOWER

A variety of interior and exterior blower options (Remote, Inline or Integrated) are available for Thermador's Downdraft Hoods. If the unit you have selected does not have a blower, one can be purchased separately. Blower selection will vary based on the volume of air that needs to be moved and the length and location of the duct run. For long duct runs with multiple turns and bends, consider using a more powerful blower. For the most efficient air flow exhaust, use a straight run or as few elbows as possible.

Remote Blowers (VTR Series)

Depending on your preference and ducting situation, these blowers can be mounted on the roof or exterior wall of your home. An exterior installation may be more appealing to reduce noise in the kitchen.

Inline Blowers (VTI series)

To minimize noise in the kitchen, these blowers are mounted along the duct line anywhere between the kitchen and the exterior wall. If you have easy access to your duct line (in an attic, for example), this may be an appealing option.

Integrated Blowers (VTN series)

These blowers are purchased separately and integrated into the hood or onto the downdraft unit at the time of installation. This option allows you to select your ideal hood with the exact power you require.

DOWNDRAFT FEATURES & BENEFITS

CHOOSING THE RIGHT CFM

The power of the cooktop, measured in BTU, is perhaps the most important factor in determining CFM needs for a hood.

You should also consider the cooking space and cooking style of your client.

- More demanding cooks usually require more exhaust capacity to handle moisture generated by boiling large pots of water or the grease and smoke resulting from grilling or frying. This cooking style could require a hood or downdraft system with airflow of 600 to 1,300 CFM.
- For those who are used to preparing quick meals in a relatively small kitchen, a hood with 600 CFM may be adequate ventilation for the cooking space.
- If the cooking surface is in a peninsula or island, a larger capacity hood can provide better capture when there are cross currents and when the hood needs to be mounted higher. Downdraft ventilation systems are also a good alternative.
- High heat cooking or aromatic foods may require additional CFM. Increasing capture area by 3" on each side is also a recommended way to address this issue.

LENGTH AND SIZE OF DUCTWORK

Do not use flexible duct; it creates back pressure / air turbulence and reduces performance.

Straight runs and gradual turns are best. Use the shortest route with the fewest turns possible.

Proper performance is dependent upon proper ducting. Use a qualified and trained installer. Local building codes may require the use of make-up air systems when using ducted ventilation systems greater than specified CFM of air movement. The specified CFM varies from locale to locale. Consult your HVAC professional for specific requirements in your area.

If using a 10" duct, Thermador recommends not exceeding 50 feet of duct. Transitions, elbows and wall or roof caps are all factors that will add more static pressure, therefore increasing your equivalent duct run.



WARRANTY

Limited warranty parts and labor (2 year)

See page 298 for additional warranty details.

BLOWER OPTIONS

REMOTE Requires CV2T6 or CV2T10 Transition

VTR630D – 600 CFM	Use Roofplate RFPLT600 in roof-mount applications
VTR1030D – 1000 CFM	Use Roofplate RFPLT1000 in roof-mount applications

INLINE Requires CV2T6 or CV2T10 Transition

VTI610D – 600 CFM
VTI1010D – 1000 CFM

INTEGRATED

VTN600CV2C – 600 CFM

REMOTE (Mounted to roof or external wall)

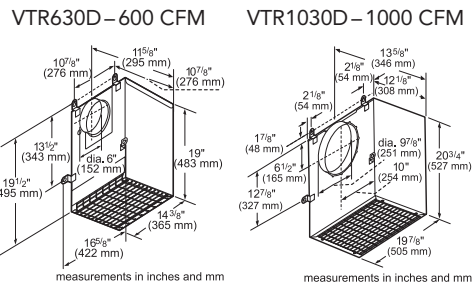

INLINE (Mounted between kitchen and external wall)

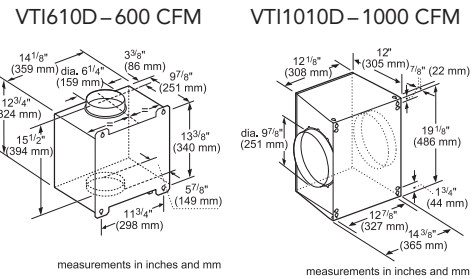

INTEGRATED (Mounted in hood)

VTN600CV2C – 600 CFM

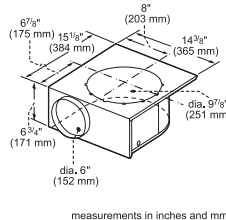

REMOTE BLOWER ACCESSORIES

Roofplate
RFPLT600
For use with
Remote Blower
VTR630D

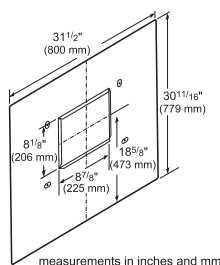

Roofplate
RFPLT1000
For use with
Remote Blower
VTR1030D

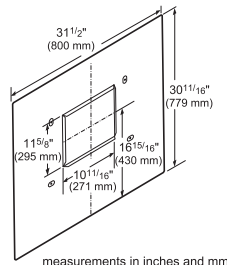

EXTNCB25

25 ft. Blower Connector Cable for use with the following Inline and Remote blowers: VTR630D, VTR1030D, VTR1330E, VTI610D, VTI1010D

VENTILATION DOWNDRAFT (30"/36")

UCVM30FS / UCVM36FS

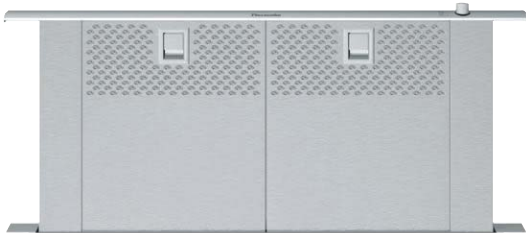

MASTERPIECE®

UCVM30FS – 30-Inch

UCVM36FS – 36-Inch

SPECIFICATIONS

Available Hood Widths	30" / 36"
Blower	Sold Separately — See Blower Options Table
Duct Size at Discharge	6" Round
Ducting Direction	Down, Left or Right
Dishwasher-safe Filters	Full-Face Mesh
Electrical	120V AC, 60Hz

UCVM30FS / UCVM36FS

PERFORMANCE

- Suitable for wall or island applications
- Downdraft rises over 13" to capture steam from the tallest pots
- Downdraft recirculation possible with module RECIRC36DF
- Three fan speeds
- Dishwasher-safe full-face filters also act as a splatter shield
- Filter systems are highly efficient at capturing grease
- Powerfully Quiet® ventilation systems
- Blowers sold separately
- Choose from Inline, Remote or Integrated Blowers

DESIGN

- Brushed stainless steel finish
- Easy-to-operate control buttons

TRANSITIONS

Transition piece required for installation of inline and remote blowers — downdraft applications only

CV2T6

Transition piece required for installation of 600 CFM Inline and Remote Blowers with 6" duct connections — downdraft applications only

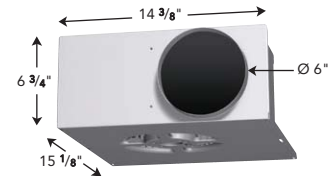

CV2T10

Improves overall performance when installing with Thermador's 1,000 CFM Inline or Remote Blowers with 10" duct connections — downdraft applications only

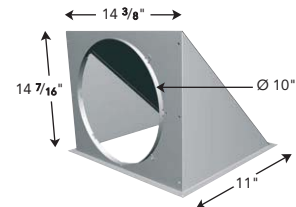

ACCESSORIES

Recirculation Kit

RECIRC36DF

- Comes complete with 2 charcoal filters, 2 venting grids, and ducting to transition to integrated blower (blower sold separately)
- For toekick heights of 4" or taller
- Wall or island applications
- Easily mounts to integrated blower (VTN600CV2C) under cooktop
- Toekick / socket can be vented in any direction
- Mounts to base of cabinet; recesses into toekick
- To be used only with Thermador Downdraft and Integrated Blower
- Replacement filters are ordered as a service item
- Filters should be replaced twice a year

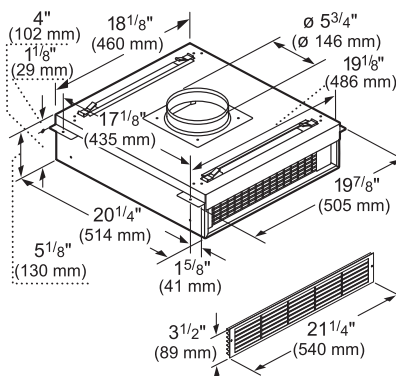
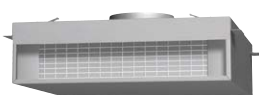

measurements in inches and mm

Replacement Charcoal Filters

Sold separately as service item #291108
(For use with recirculation module)

VENTILATION DOWNDRAFT (30"/36")

UCVM30FS / UCVM36FS

INSTALLATION OPTIONS

The Thermador Downdraft Hood System is available in 30-inch or 36-inch widths. It is intended for installation with Thermador non-professional gas, electric or induction cooktops only.

A Recirculation Kit (RECIRC36DF) can be purchased separately and used in conjunction with the Integral Blower if ducting to the outside is not a viable option. Refer to the appropriate section for additional specifications.

These hoods are designed to be used for side or downward discharge.

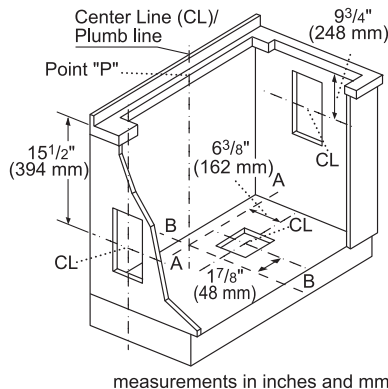
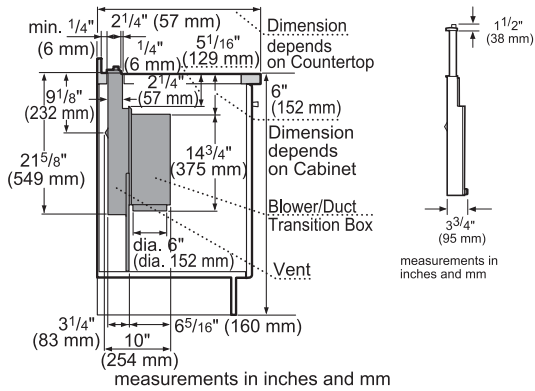
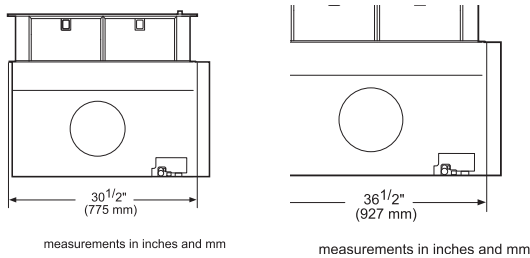
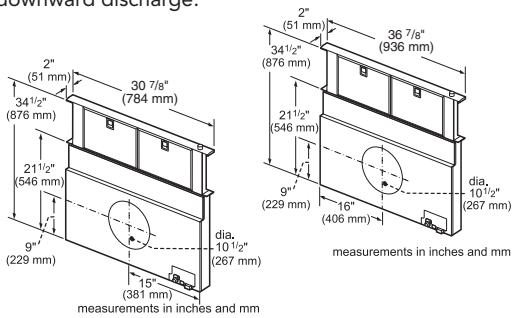

CUTOUT DIMENSIONS (TOP VIEW)

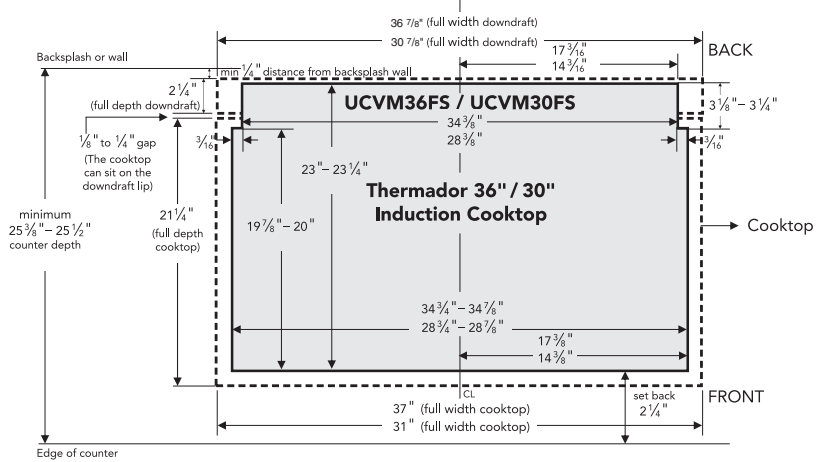

Note: For detailed electrical and gas hookups, please refer to cooktop installation instruction.

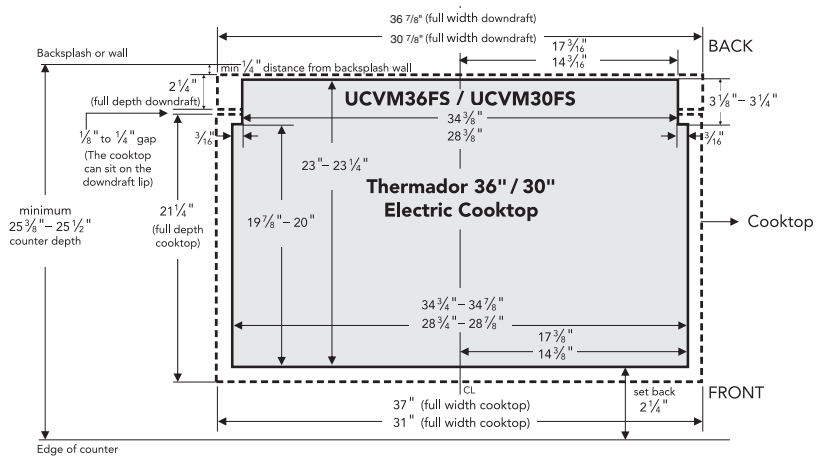

Note: For detailed electrical and gas hookups, please refer to cooktop installation instruction.

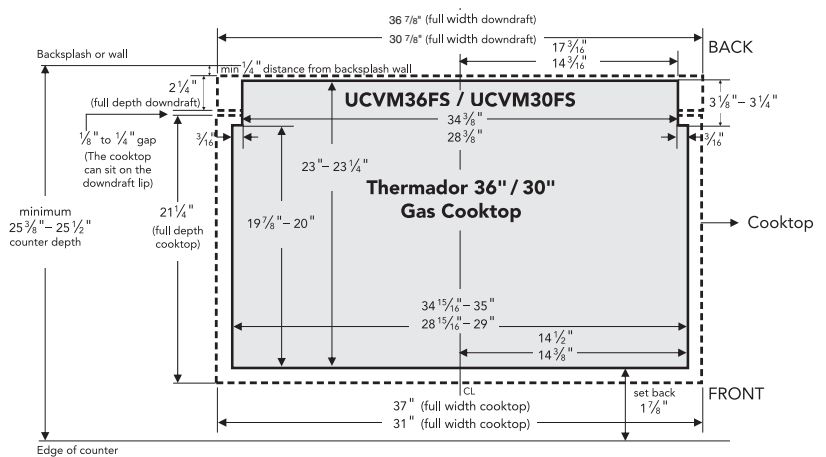

Note: For detailed electrical and gas hookups, please refer to cooktop installation instruction.

WARRANTY

PROFESSIONAL RANGES

Limited warranty, entire appliance, parts and labor (2 year)

PROFESSIONAL RANGETOPS

Limited warranty, entire appliance, parts and labor (2 year)

BUILT-IN OVENS

Limited warranty parts and labor (2 year)

INDUCTION COOKTOPS

Limited warranty, entire appliance, parts and labor (2 year)

Limited warranty for glass ceramic surface / electronic elements and switches; parts only (3rd to 5th year)

GAS COOKTOPS

Limited warranty, entire appliance, parts and labor (2 year)

ELECTRIC COOKTOPS

Limited warranty, entire appliance, parts and labor (2 year)

Limited warranty for glass ceramic surface / electronic elements and switches; parts only (3rd to 5th year)

VENTILATION

Limited warranty, entire appliance, parts and labor (2 year)

WARMING DRAWERS

Limited warranty, entire appliance, parts and labor (2 year)

MICROWAVE OVENS

Limited warranty, entire appliance, parts and labor (2 year)

REFRIGERATION

Limited two-year warranty, entire appliance, parts and labor on any part of the refrigerator that fails because of a manufacturing defect

Limited warranty for sealed refrigeration system*; parts and labor (3rd to 6th year)

Limited warranty for sealed refrigeration system*; parts only (7th to 12th year)

DISHWASHERS

Full warranty, entire appliance, parts and labor (2 year)

Limited warranty for microprocessor or printed circuit board; parts only (3rd to 5th year)

Limited warranty for racks (does not include rack components); parts only (3rd to 5th year)

Limited warranty for rust-through on inner tub liner; parts only (Lifetime)

COFFEE MACHINES

Limited warranty, entire appliance, parts and labor (2 year)

These warranties give you specific legal rights and you may have other rights that vary from state to state. Full warranty and limited warranty from date of installation. For complete warranty details, refer to your Use & Care manual, or ask your dealer.

Specifications are for planning purposes only. Refer to installation instructions and consult your countertop supplier prior to making counter opening. Consult with a heating and ventilation engineer for your specific ventilation requirements. For the most detailed information, refer to installation instructions accompanying product or write to Thermador indicating the model number. Specifications are correct at time of printing. Thermador reserves the right to change product specifications or design without notice. Some models are certified for use in Canada. Thermador is not responsible for products that are transported from the U.S. for use in Canada.

©2014 BSH Home Appliances Corporation. PDF update: 11/2014

*Sealed refrigeration system includes compressor, evaporator, condenser, dryer / strainer and connection tubing

EXPERIENCE THERMADOR®

Thermador is committed to giving you an enjoyable, creative and rewarding cooking experience. Whether you would like to research our products, watch a video of our chef searing the perfect scallop, or have questions on the use and care of your product, simply browse our online resource library at thermador.com

CONNECT WITH US

thermador.com/blog

 [facebook.com](https://www.facebook.com/thermador)

 twitter.com/thermador

 [youtube.com/thermadorhome](https://www.youtube.com/thermadorhome)

 [pinterest.com/thermador](https://www.pinterest.com/thermador)

 [instagram.com/thermadorhome](https://www.instagram.com/thermadorhome)

VISIT THE ABOVE SITES TO SHARE PHOTOS OF
YOUR NEW KITCHEN AND CREATIVE DISHES.

TAKE US WITH YOU

Visit the App Store™ or Google Play™ to download our Innovations app, including the Thermador Kitchen Ideas & Lookbook and the Thermador Kitchen Design and Planning Guide.

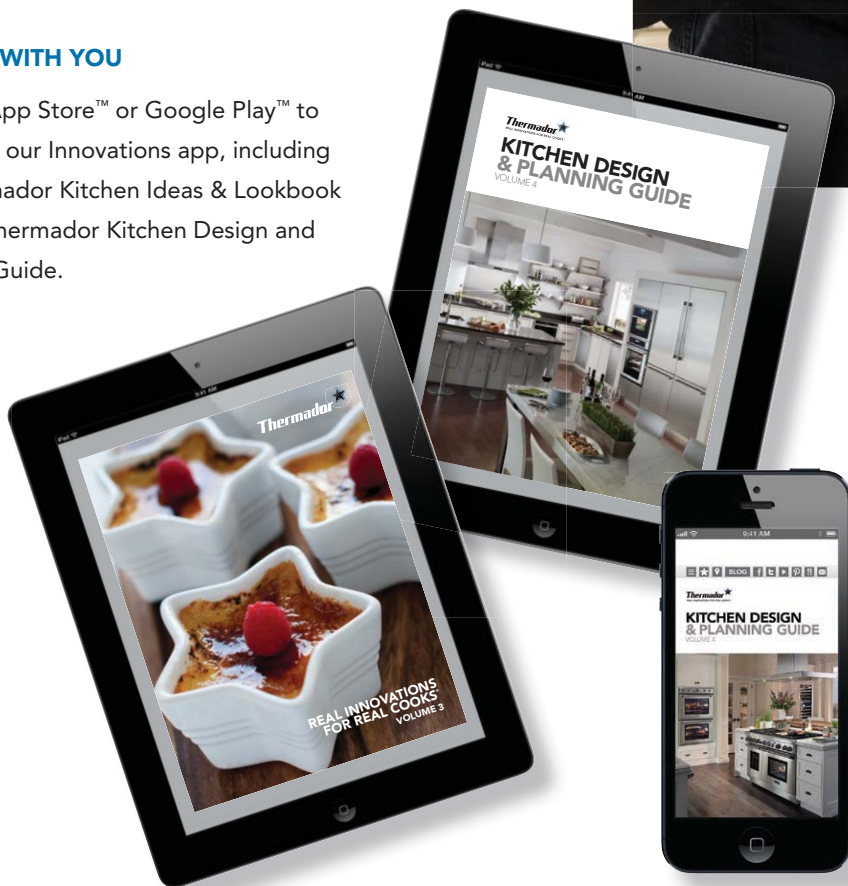

CUSTOMER SERVICE

For dedicated customer service on any Thermador product, please call: 1-800-735-4328 or contact us at thermador.com



1 800 735 4328

USA THERMADOR.COM
CANADA THERMADOR.CA