



# MECO OMAHA CANTILEVER RACK

SERIES 1000 THROUGH SERIES 5000

• MECO OMAHA CANTILEVER RACK FOR A NEAT AND ORDERLY INVENTORY SYSTEM



- INSTANT ACCESSIBILITY TO ONE PIECE OR A FULL LOAD
- FAST, CONVENIENT HANDLING OF LONG, UNWIDELY STOCK

## FOR STORAGE AND EASY SELECTION OF BAR STOCK, PIPE, STRUCTURALS, TUBING AND OTHER LONG ITEMS OR WHERE UNINTERRUPTED DECKING IS REQUIRED.

MECO OMAHA manufactures five basic capacity series to fit your storage requirements – from Series 1000 Medium Duty through the Series 5000 Extra Heavy Duty.

Available in upright heights from 6' to 20' with 2' through 10' brace widths (measured on center). Arms are completely adjustable on 3" centers to accommodate an infinite variety of items. Straight arms are available in nine different lengths with or without lips. Heavy Duty and Extra Heavy Duty arms are both available in seven lengths with or without lips. Inclined arms are available in seven lengths with or without lips. A wide range of base sizes allows custom designing of rack systems to your individual needs. Uprights are punched on both sides for versatility and can be used single sided or double sided depending on the size of base used. Note that arms must never be placed on the back side of a single-based upright.

MECO OMAHA CANTILEVER RACKS are modular within each basic capacity series so that additional arms, uprights and cross braces may be ordered at any time to add to your existing system. Different sized arms may be interchanged on racks to further tailor your racks to different uses. Standard and Heavy Duty arms (page 28) are designed for use on Series 3000, Series 4000 and Series 5000 uprights only. Series 1000 and Series 2000 components are not interchangeable with any other rack series.

Single sided uprights can be converted to doubles when used with longer bases designed to accommodate placement of arms on both sides. Upright capacities can be computed by multiplying the number of arms per upright by the individual arm capacities—NOT TO EXCEED TOTAL UPRIGHT CAPACITIES LISTED. Arm capacity is based on EVEN DISTRIBUTION OF LOAD. All racks are designed for quick assembly and come with complete instructions and hardware for installation.

Completely adjustable MECO OMAHA CANTILEVER RACKS eliminate storage problems. Heavy duty steel construction permits storage of tubes, bars, structurals and other long heavy items that must be kept off the floor. Bases can be used for extra storage. Forklift easily loads off and on arms and bases. Fast, convenient handling of heavy, long unwieldy stock. Instant accessibility to one piece or a full load. For longer materials, simply add braces and uprights to fit your requirements.

Specially designed MECO OMAHA CANTILEVER RACK systems may be required to meet your needs. MECO OMAHA representatives will work with you to develop the most feasible and economical rack system for your special situation. Special label requirements can be met at an additional cost. Ask us to quote prices and specifications for rack systems not covered in the MECO OMAHA BUYER'S GUIDE.

### DETAILED SPECIFICATIONS ARE SET FORTH ON THE FOLLOWING PAGES

| DESCRIPTION                          | UPRIGHT HEIGHTS                       | PAGE NO. |
|--------------------------------------|---------------------------------------|----------|
| Series 1000 Medium Duty              | 6', 7', 8', 10', 12'                  | 24       |
| Series 2000 Medium-Heavy Duty        | 8', 10', 12', 14', 16', 18', 20'      | 25       |
| Series 3000 Heavy Duty               | 8', 10', 12', 14', 15', 16', 18', 20' | 26       |
| Series 4000 Standard Heavy Duty      | 8', 10', 12', 14', 15', 16', 18', 20' | 27       |
| Series 5000 Extra Heavy Duty         | 12', 14', 15', 16', 18', 20'          | 28       |
| Series 1000 Starter and Add-on Units | 6', 8', 10'                           | 29       |
| Series 4000 Starter and Add-on Units | 8', 10', 12'                          | 29       |

Standard color for all cantilever rack components is gray. Custom colors available at additional cost.



# WHAT IS CANTILEVER RACK?

**Cantilever Rack** is a freestanding storage unit with horizontal load carrying arms extending outward from a single vertical column. The absence of a vertical support on the outboard ends of the arms permits uninterrupted storage of long lengths of material.

**Cantilever Rack** is the **ideal system for storing furniture, steel bars, pipe and tubing, lumber and other long, heavy items** that must be kept off the floor...provides instant accessibility to one piece or a full load. Forklift easily loads off and on arms and bases. Being modular in nature, additional arms, uprights and braces may be added as storage requirements change.

**Cantilever Rack** is comprised of three components:

- Uprights
- Arms
- Brace Sets

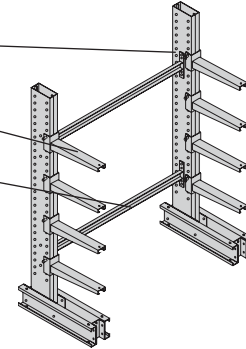

These components must be ordered in the appropriate quantities and capacities.

## UPRIGHTS

**Uprights** consist of a vertical column and a horizontal base which is bolted to the column. A minimum of two uprights must be ordered to form a storage bay. Each edge of the column is punched vertically on 3" centers so it may be used as

a single or double sided upright depending on the size of base used. **NOTE:** The arms must never be placed on the back side of a single sided upright and base. Standard upright and base color is gray.

### Single Sided Upright

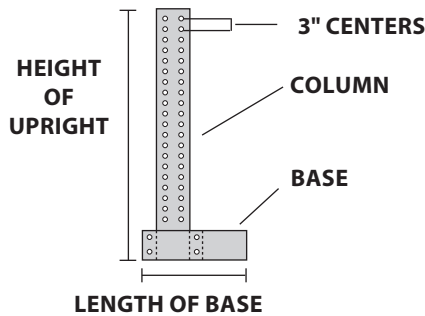

Holes are provided in the base to anchor the upright to the floor. Uprights must never be attached to walls, columns or other structures.

### Double Sided Upright

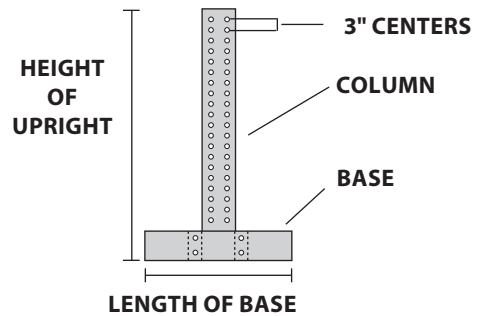

## ARMS

**Cantilever Arms** are the heart of the rack system. Proper selection can make or break a successful storage plan. **MECO OMAHA** offers straight arms (generally used for storing stable loads such as lumber, steel sheets, cartons and skids) and inclined arms (for cylindrical objects or loads that tend to roll forward). Arms can be adjusted

on 3" centers up and down the upright and are available in lengths to 60" in a variety of capacities. The hair pin keeper permits instant adjustability and is easily inserted and removed for adjustment of arm height. Lips are available on all **MECO OMAHA** arms. Standard arm color is gray.

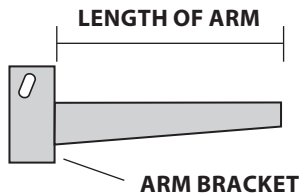

### Straight Arm

Straight arms up to 48" long have a minimum pitch of 3/8" per foot to compensate for deflection. 54" and 60" arms have a minimum pitch of 5/8" per foot.

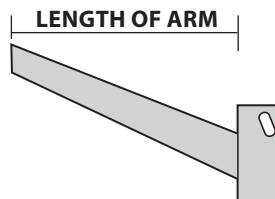

### Inclined Arm

Inclined arms have a pitch of 20° or approximately 4.36" per foot.



**MECO OMAHA**  
Hair Pin Keeper



### BRACE SETS

**Braces** are structural channel members that are bolted between pairs of uprights to provide lateral stability to the rack system. X-bracing is utilized to increase the lateral stability of the taller (15' to 20') uprights. Brace

lengths are measured from centerline of upright to centerline of the next upright and are sold in sets rather than individual pieces. Standard brace color is gray.

### Standard MECO OMAHA Brace Patterns

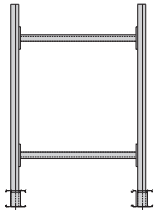

**"2B" Horizontal Brace Pattern**  
Used on 6' to 10' Series 1000 uprights and 8' Series 2000, Series 3000 and Series 4000 uprights.

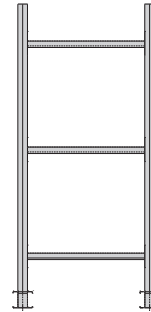

**"3B" Horizontal Brace Pattern**  
Used on 12' Series 1000 uprights, 10' to 14' Series 2000, Series 3000 and Series 4000 uprights and 12' to 14' Series 5000 uprights.

**"4BX" Horizontal Brace Pattern**  
Used on 16' to 20' Series 2000 uprights, 15' to 20' Series 3000, Series 4000 and Series 5000 uprights and all structural cantilever rack.

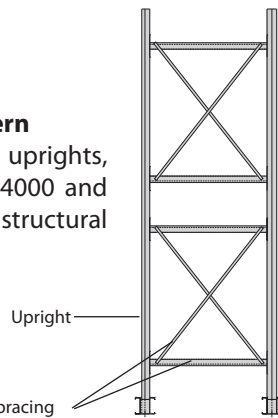

**"4BXX" Horizontal Brace Pattern**  
Used on all 15' to 20' uprights when the brace length exceeds 84" centerline to centerline of upright.

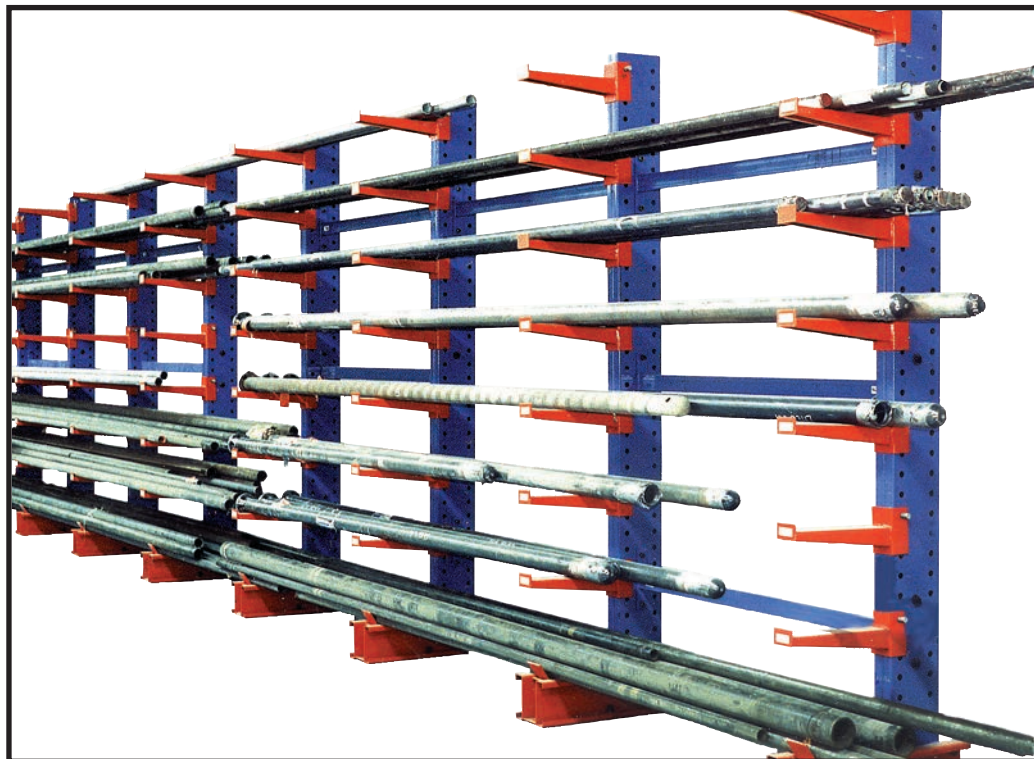
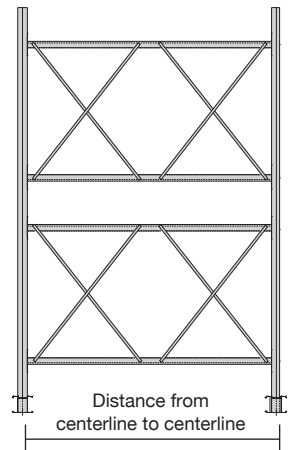

**MECO OMAHA cantilever rack application consisting of uprights, arms and braces.**

Standard color for all cantilever rack components is gray. Custom colors available at additional cost.



# DESIGNING A CANTILEVER RACK SYSTEM

The key to a successful cantilever rack system is the answer to one question: **What is the product (load) being stored?** The answer must include the **length, depth, height** and

**weight** of the product. Once this data is ascertained it becomes a simple matter to determine the required arms, uprights and braces.

## A. DETERMINE THE NUMBER AND SPACING OF ARMS

The load must be supported by enough arms to prevent load deflection. Deflection may cause damage to the load being stored as well as the arms (figure A1). To detect deflection, place the load over two wooden blocks (to represent cantilever arms) as shown in figure A2. If deflection is not present it is acceptable to use a two arm system as long as this does not create an overload

condition. If the load shows deflection use three blocks as shown in figure A3 or four blocks as in figure A4.

**IMPORTANT:** The load should overhang the end arms by one-half the distance from upright centerline to upright centerline. Failure to observe this measure may cause an overload condition on the arms.

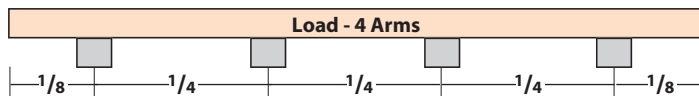
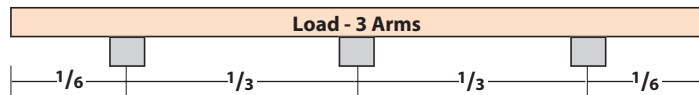
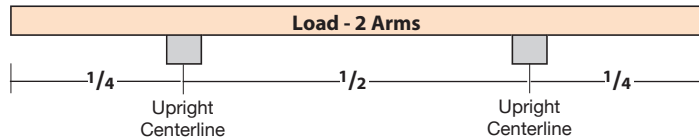
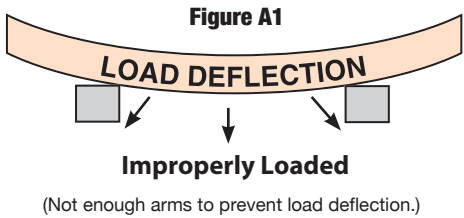

Adhering to these guidelines will ensure that each arm supports an equal amount of the load's weight.

## B. DETERMINE THE LENGTH OF THE ARMS

The depth of the load should never exceed the length of the arm. A 48" wide bundle of plywood requires a 48" long arm, bundles of steel 24" wide require a 24" arm and so on. Rated

arm capacities may be seriously diminished if proper loading techniques are not observed. Figures B1, B2 and B3 illustrate correct and incorrect arm loading.

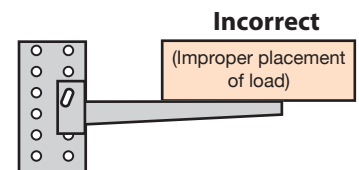
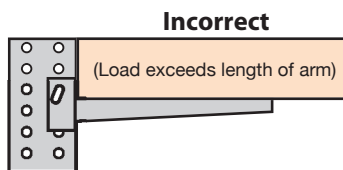
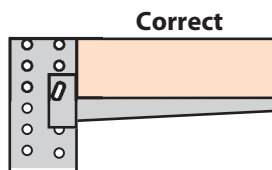

**NOTE:** All arm capacities are based on an evenly distributed load as in figures B4 and B5 below.

Evenly Distributed Load (front to back)  
Full rated arm capacity

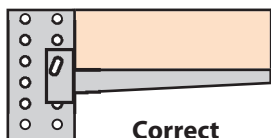

Centered Load  
Full rated arm capacity

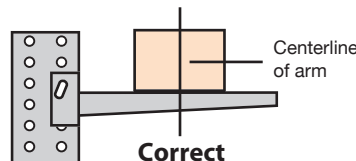

Tip Loading  
Arm capacity may be reduced by up to 50%







C. DETERMINE THE HEIGHT OF THE UPRIGHT

When determining the height of the upright it is important to consider the ceiling height, forklift reach, sprinkler systems and other factors, such as local building codes that might affect the overall height.

The height of the upright in figure C1 is determined by adding the base height, the number of loads to be stored, the arm thickness plus 6" clearance between the load and next arm. Contact your MECO OMAHA sales professional for various rack dimensions such as base height and arm thickness.

IMPORTANT: The load placed on the base does not diminish the rated capacity of the upright. Thus, the heaviest loads should be placed on the base.

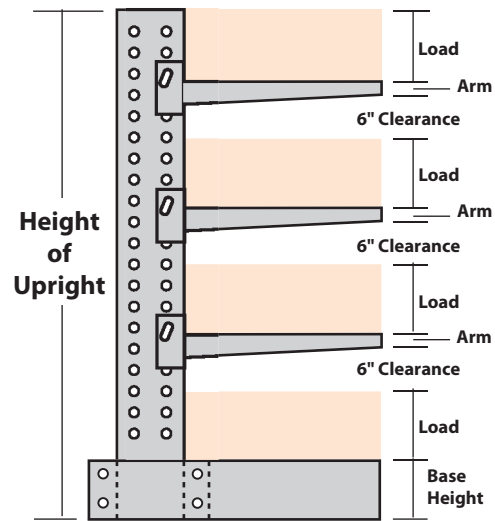

Figure C1

D. DETERMINE ARM AND UPRIGHT CAPACITIES

As previously discussed, each arm supports an equal amount of the load's weight. By determining the number of arms per level and dividing it into the weight per level, the required arm capacity can be determined (see example at right).

To determine the required capacity of each upright, multiply the number of arms per side by the load on each arm. In figure D1, each arm holds 2500 lbs. Twelve arms per side times 2500 lbs. per arm equals 30,000 lbs., which when divided by three uprights, results in a required minimum capacity of 10,000 lbs. per upright.

The correct upright can be selected by matching the minimum upright capacity of 10,000 lbs. with the upright capacities set forth on the following pages. Assuming a 48" arm, the U1061-NS on page 26 with 10,200 lbs. capacity and the U1061 on page 27 with 12,600 lbs. capacity are the only uprights that will handle the load. NOTE: The Series 1000 MU1057 has only 3100 lbs. capacity while the Series 2000 2U1062 has 8600 lbs. capacity.

The proper 48" arm (requiring 2500 lbs. of capacity) can be found on page 28: either the XHDSA48 at 2500 lbs. or the XHDSA483M at 3000 lbs. capacity.

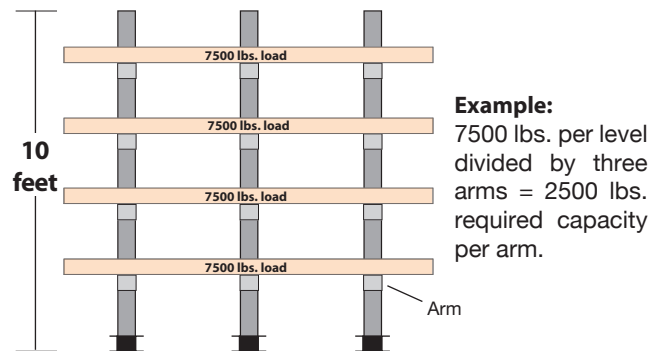

Figure D1

NOTE: Total arm capacity must never exceed total upright capacity.

E. DETERMINE BRACE LENGTH

Brace length is defined as the horizontal distance from centerline of upright to centerline of the next upright. Refer

to the various brace set charts for the brace length that most closely matches the arm spacing determined in step A.

The following pages set forth MECO OMAHA's wide range of cantilever racks – beginning with the Series 1000 Medium Duty on page 24 through the Series 5000 Extra Heavy Duty on page 28. MECO OMAHA representatives will work with you to develop the most feasible and economical rack system for your unique situation.



# MODERN EQUIPMENT COMPANY, INC.

OMAHA

## SERIES 1000 MEDIUM DUTY CANTILEVER RACK

EXCELLENT LOW COST STORAGE SYSTEM • IDEAL FOR MAINTENANCE DEPARTMENTS AND TOOL ROOMS

High quality **MECO OMAHA** Series 1000 Cantilever Rack is designed for use where heavier capacities are not required. This rack is similar to our popular heavier duty racks except for the use of lighter gauge steel and smaller dimensions of component parts. Available in 6', 7', 8', 10' and 12' single and double sided uprights with a choice of eight standard brace lengths (measured on center) to accommodate 12", 18", 24", 30", 36", 42" and 48" straight or inclined arms. Arms are completely adjustable on 3" centers up and down the full length of the uprights. Two or more uprights can be assembled into a continuous system.

This sturdy and stable rack is as convenient and versatile as the heavier duty racks but priced lower to reflect the reduced capacity. Installation is quick and easy. Racks can be tailored to your individual requirements. Uprights facilitate manual loading and unloading. Open base design affords easy forklift accessibility. Ideal for storing bar stock, pipe, tubing, lumber and many lightweight or hard-to-stock items that must be kept off the floor.



- EASY LOADING AND UNLOADING
- EVERY ITEM READILY AVAILABLE
- ALL WEIGHTS INCLUDE HARDWARE

MECO OMAHA SERIES 1000 UPRIGHTS, ARMS and BRACE SETS are not interchangeable with any other rack series.

| SINGLE SIDED UPRIGHTS |                |               |              |                |           |
|-----------------------|----------------|---------------|--------------|----------------|-----------|
| HEIGHT OF UPRIGHT     | LENGTH OF BASE | LENGTH OF ARM | WEIGHT (LBS) | CAPACITY (LBS) | MODEL NO. |
| 6'                    | 33"            | 12" & 18"     | 82           | 8,100 & 6,600  | MU633     |
|                       | 33"            | 24"           | 82           | 5,500          | MU633     |
|                       | 45"            | 30"           | 90           | 4,700          | MU645     |
|                       | 45"            | 36"           | 90           | 4,100          | MU645     |
|                       | 57"            | 42" & 48"     | 100          | 3,700 & 3,300  | MU657     |
| 7'                    | 33"            | 12" & 18"     | 89           | 7,900 & 6,400  | MU733     |
|                       | 33"            | 24"           | 89           | 5,300          | MU733     |
|                       | 45"            | 30"           | 97           | 4,600          | MU745     |
|                       | 45"            | 36"           | 97           | 4,100          | MU745     |
|                       | 57"            | 42" & 48"     | 107          | 3,700 & 3,300  | MU757     |
| 8'                    | 33"            | 12" & 18"     | 96           | 7,600 & 6,300  | MU833     |
|                       | 33"            | 24"           | 96           | 5,300          | MU833     |
|                       | 45"            | 30"           | 104          | 4,500          | MU845     |
|                       | 45"            | 36"           | 104          | 4,000          | MU845     |
|                       | 57"            | 42" & 48"     | 114          | 3,600 & 3,200  | MU857     |
| 10'                   | 33"            | 12" & 18"     | 110          | 7,100 & 5,900  | MU1033    |
|                       | 33"            | 24"           | 110          | 5,000          | MU1033    |
|                       | 45"            | 30"           | 118          | 4,400          | MU1045    |
|                       | 45"            | 36"           | 118          | 3,800          | MU1045    |
|                       | 57"            | 42" & 48"     | 128          | 3,400 & 3,100  | MU1057    |
| 12'                   | 33"            | 12" & 18"     | 124          | 6,500 & 5,400  | MU1233    |
|                       | 33"            | 24"           | 124          | 4,700          | MU1233    |
|                       | 45"            | 30"           | 132          | 4,100          | MU1245    |
|                       | 45"            | 36"           | 132          | 3,700          | MU1245    |
|                       | 57"            | 42" & 48"     | 142          | 3,300 & 3,000  | MU1257    |

| DOUBLE SIDED UPRIGHTS |                |               |              |                 |           |
|-----------------------|----------------|---------------|--------------|-----------------|-----------|
| HEIGHT OF UPRIGHT     | LENGTH OF BASE | LENGTH OF ARM | WEIGHT (LBS) | CAPACITY (LBS)  | MODEL NO. |
| 6'                    | 54"            | 12" & 18"     | 99           | 16,200 & 13,200 | MDU654    |
|                       | 54"            | 24"           | 99           | 11,000          | MDU654    |
|                       | 78"            | 30"           | 115          | 9,400           | MDU678    |
|                       | 78"            | 36"           | 115          | 8,200           | MDU678    |
|                       | 102"           | 42" & 48"     | 135          | 7,400 & 6,600   | MDU6102   |
| 7'                    | 54"            | 12" & 18"     | 106          | 15,800 & 12,800 | MDU754    |
|                       | 54"            | 24"           | 106          | 10,600          | MDU754    |
|                       | 78"            | 30"           | 122          | 9,200           | MDU778    |
|                       | 78"            | 36"           | 122          | 8,200           | MDU778    |
|                       | 102"           | 42" & 48"     | 142          | 7,400 & 6,600   | MDU7102   |
| 8'                    | 54"            | 12" & 18"     | 113          | 15,200 & 12,600 | MDU854    |
|                       | 54"            | 24"           | 113          | 10,600          | MDU854    |
|                       | 78"            | 30"           | 129          | 9,000           | MDU878    |
|                       | 78"            | 36"           | 129          | 8,000           | MDU878    |
|                       | 102"           | 42" & 48"     | 149          | 7,200 & 6,400   | MDU8102   |
| 10'                   | 54"            | 12" & 18"     | 127          | 14,200 & 11,800 | MDU1054   |
|                       | 54"            | 24"           | 127          | 10,000          | MDU1054   |
|                       | 78"            | 30"           | 143          | 8,800           | MDU1078   |
|                       | 78"            | 36"           | 143          | 7,600           | MDU1078   |
|                       | 102"           | 42" & 48"     | 163          | 6,800 & 6,200   | MDU10102  |
| 12'                   | 54"            | 12" & 18"     | 141          | 13,000 & 10,800 | MDU1254   |
|                       | 54"            | 24"           | 141          | 9,400           | MDU1254   |
|                       | 78"            | 30"           | 157          | 8,200           | MDU1278   |
|                       | 78"            | 36"           | 157          | 7,400           | MDU1278   |
|                       | 102"           | 42" & 48"     | 177          | 6,600 & 6,000   | MDU12102  |

| STRAIGHT ARMS |          |        |                       |                    |
|---------------|----------|--------|-----------------------|--------------------|
| LENGTH        | CAPACITY | WEIGHT | MODEL NO. WITHOUT LIP | MODEL NO. WITH LIP |
| 12"           | 1000 lbs | 6 lbs  | MSA12                 | MSA12L             |
| 18"           | 750 lbs  | 7 lbs  | MSA18                 | MSA18L             |
| 24"           | 600 lbs  | 8 lbs  | MSA24                 | MSA24L             |
| 30"           | 500 lbs  | 9 lbs  | MSA30                 | MSA30L             |
| 36"           | 400 lbs  | 10 lbs | MSA36                 | MSA36L             |
| 42"           | 350 lbs  | 13 lbs | MSA42                 | MSA42L             |
| 48"           | 300 lbs  | 15 lbs | MSA48                 | MSA48L             |

| INCLINED ARMS |          |        |                       |                    |
|---------------|----------|--------|-----------------------|--------------------|
| LENGTH        | CAPACITY | WEIGHT | MODEL NO. WITHOUT LIP | MODEL NO. WITH LIP |
| 12"           | 1000 lbs | 6 lbs  | MIA12                 | MIA12L             |
| 18"           | 750 lbs  | 7 lbs  | MIA18                 | MIA18L             |
| 24"           | 600 lbs  | 8 lbs  | MIA24                 | MIA24L             |
| 30"           | 500 lbs  | 9 lbs  | MIA30                 | MIA30L             |
| 36"           | 400 lbs  | 10 lbs | MIA36                 | MIA36L             |
| 42"           | 350 lbs  | 13 lbs | MIA42                 | MIA42L             |
| 48"           | 300 lbs  | 15 lbs | MIA48                 | MIA48L             |

**STRAIGHT ARMS** have a minimum pitch of 3/8" per foot to compensate for deflection. Arm capacities are based on an evenly distributed load.

**INCLINED ARMS** have a pitch of 20 degrees or approximately 4.36" per foot. Arm capacities are based on an evenly distributed load.

**NOTE:** Arm lips are not intended to bear any portion of the load.

| LENGTH* | BRACES FOR 6' - 10' UPRIGHTS - SET OF TWO |        | BRACES FOR 12' UPRIGHTS - SET OF THREE |        |
|---------|---|--------|--|--------|
|         | MODEL NO.                                 | WEIGHT | MODEL NO.                              | WEIGHT |
| 23"     | M2B24                                     | 21 lbs | M3B24                                  | 31 lbs |
| 35"     | M2B36                                     | 28 lbs | M3B36                                  | 41 lbs |
| 41"     | M2B42                                     | 31 lbs | M3B42                                  | 47 lbs |
| 47"     | M2B48                                     | 35 lbs | M3B48                                  | 52 lbs |
| 59"     | M2B60                                     | 42 lbs | M3B60                                  | 62 lbs |
| 71"     | M2B72                                     | 49 lbs | M3B72                                  | 73 lbs |
| 83"     | M2B84                                     | 56 lbs | M3B84                                  | 83 lbs |
| 95"     | M2B96                                     | 63 lbs | M3B96                                  | 94 lbs |

\* Length of braces is measured from center of upright to center of upright.



**SERIES 2000 MEDIUM-HEAVY DUTY CANTILEVER RACK**

MECO OMAHA SERIES 2000 UPRIGHTS, ARMS and BRACE SETS are not interchangeable with any other rack series.

| SINGLE SIDED UPRIGHTS |                |               |              |                 |           |
|-----------------------|----------------|---------------|--------------|-----------------|-----------|
| HEIGHT OF UPRIGHT     | LENGTH OF BASE | LENGTH OF ARM | WEIGHT (LBS) | CAPACITY (LBS)  | MODEL NO. |
| 8'                    | 38"            | 12" & 18"     | 188          | 18,100 & 15,300 | 2U838     |
|                       | 38"            | 24"           | 188          | 13,300          | 2U838     |
|                       | 50"            | 30" & 36"     | 201          | 11,800 & 10,600 | 2U850     |
|                       | 62"            | 42" & 48"     | 215          | 9,600 & 8,800   | 2U862     |
| 10'                   | 38"            | 12" & 18"     | 217          | 17,400 & 14,900 | 2U1038    |
|                       | 38"            | 24"           | 217          | 13,100          | 2U1038    |
|                       | 50"            | 30" & 36"     | 230          | 11,500 & 10,300 | 2U1050    |
|                       | 62"            | 42" & 48"     | 244          | 9,400 & 8,600   | 2U1062    |
| 12'                   | 38"            | 12" & 18"     | 245          | 16,800 & 14,500 | 2U1238    |
|                       | 38"            | 24"           | 245          | 12,600          | 2U1238    |
|                       | 50"            | 30" & 36"     | 258          | 11,200 & 10,200 | 2U1250    |
|                       | 62"            | 42" & 48"     | 272          | 9,300 & 8,500   | 2U1262    |
| 14'                   | 38"            | 12" & 18"     | 272          | 16,200 & 14,100 | 2U1438    |
|                       | 38"            | 24"           | 272          | 12,300          | 2U1438    |
|                       | 50"            | 30" & 36"     | 285          | 10,900 & 9,800  | 2U1450    |
|                       | 62"            | 42" & 48"     | 299          | 8,900 & 8,300   | 2U1462    |
| 16'                   | 38"            | 12" & 18"     | 299          | 15,800 & 13,800 | 2U1638    |
|                       | 38"            | 24"           | 299          | 12,100          | 2U1638    |
|                       | 50"            | 30" & 36"     | 312          | 10,600 & 9,400  | 2U1650    |
|                       | 62"            | 42" & 48"     | 326          | 8,400 & 7,500   | 2U1662    |
| 18'                   | 38"            | 12" & 18"     | 326          | 15,700 & 13,700 | 2U1838    |
|                       | 38"            | 24"           | 326          | 11,900          | 2U1838    |
|                       | 50"            | 30" & 36"     | 339          | 10,400 & 9,200  | 2U1850    |
|                       | 62"            | 42" & 48"     | 353          | 8,200 & 7,400   | 2U1862    |
| 20'                   | 38"            | 12" & 18"     | 353          | 15,600 & 13,600 | 2U2038    |
|                       | 38"            | 24"           | 353          | 11,700          | 2U2038    |
|                       | 50"            | 30" & 36"     | 366          | 10,200 & 9,000  | 2U2050    |
|                       | 62"            | 42" & 48"     | 380          | 8,100 & 7,300   | 2U2062    |

| DOUBLE SIDED UPRIGHTS |                |               |              |                 |           |
|-----------------------|----------------|---------------|--------------|-----------------|-----------|
| HEIGHT OF UPRIGHT     | LENGTH OF BASE | LENGTH OF ARM | WEIGHT (LBS) | CAPACITY (LBS)  | MODEL NO. |
| 8'                    | 59"            | 12" & 18"     | 216          | 36,200 & 30,600 | 2DU859    |
|                       | 59"            | 24"           | 216          | 26,600          | 2DU859    |
|                       | 83"            | 30" & 36"     | 243          | 23,600 & 21,200 | 2DU883    |
|                       | 107"           | 42" & 48"     | 270          | 19,200 & 17,600 | 2DU8107   |
| 10'                   | 59"            | 12" & 18"     | 245          | 34,800 & 29,800 | 2DU1059   |
|                       | 59"            | 24"           | 245          | 26,200          | 2DU1059   |
|                       | 83"            | 30" & 36"     | 272          | 23,000 & 20,600 | 2DU1083   |
|                       | 107"           | 42" & 48"     | 299          | 18,800 & 17,200 | 2DU10107  |
| 12'                   | 59"            | 12" & 18"     | 273          | 33,600 & 29,000 | 2DU1259   |
|                       | 59"            | 24"           | 273          | 25,200          | 2DU1259   |
|                       | 83"            | 30" & 36"     | 300          | 22,400 & 20,400 | 2DU1283   |
|                       | 107"           | 42" & 48"     | 327          | 18,600 & 17,000 | 2DU12107  |
| 14'                   | 59"            | 12" & 18"     | 300          | 32,400 & 28,200 | 2DU1459   |
|                       | 59"            | 24"           | 300          | 24,600          | 2DU1459   |
|                       | 83"            | 30" & 36"     | 327          | 21,800 & 19,600 | 2DU1483   |
|                       | 107"           | 42" & 48"     | 354          | 17,800 & 16,600 | 2DU14107  |
| 16'                   | 59"            | 12" & 18"     | 327          | 31,600 & 27,600 | 2DU1659   |
|                       | 59"            | 24"           | 327          | 24,200          | 2DU1659   |
|                       | 83"            | 30" & 36"     | 354          | 21,200 & 18,800 | 2DU1683   |
|                       | 107"           | 42" & 48"     | 381          | 16,800 & 15,000 | 2DU16107  |
| 18'                   | 59"            | 12" & 18"     | 354          | 31,400 & 27,400 | 2DU1859   |
|                       | 59"            | 24"           | 354          | 23,800          | 2DU1859   |
|                       | 83"            | 30" & 36"     | 381          | 20,800 & 18,400 | 2DU1883   |
|                       | 107"           | 42" & 48"     | 408          | 16,400 & 14,800 | 2DU18107  |
| 20'                   | 59"            | 12" & 18"     | 381          | 31,200 & 27,200 | 2DU2059   |
|                       | 59"            | 24"           | 381          | 23,400          | 2DU2059   |
|                       | 83"            | 30" & 36"     | 408          | 20,400 & 18,000 | 2DU2083   |
|                       | 107"           | 42" & 48"     | 435          | 16,200 & 14,600 | 2DU20107  |

| STRAIGHT ARMS |          |        |                       |                    |
|---------------|----------|--------|-----------------------|--------------------|
| LENGTH        | CAPACITY | WEIGHT | MODEL NO. WITHOUT LIP | MODEL NO. WITH LIP |
| 12"           | 2000 lbs | 7 lbs  | 2SA12                 | 2SA12L             |
| 18"           | 1500 lbs | 8 lbs  | 2SA18                 | 2SA18L             |
| 24"           | 1200 lbs | 9 lbs  | 2SA24                 | 2SA24L             |
| 30"           | 1000 lbs | 10 lbs | 2SA30                 | 2SA30L             |
| 36"           | 800 lbs  | 11 lbs | 2SA36                 | 2SA36L             |
| 42"           | 700 lbs  | 14 lbs | 2SA42                 | 2SA42L             |
| 48"           | 600 lbs  | 16 lbs | 2SA48                 | 2SA48L             |

| INCLINED ARMS |          |        |                       |                    |
|---------------|----------|--------|-----------------------|--------------------|
| LENGTH        | CAPACITY | WEIGHT | MODEL NO. WITHOUT LIP | MODEL NO. WITH LIP |
| 12"           | 2000 lbs | 7 lbs  | 2IA12                 | 2IA12L             |
| 18"           | 1500 lbs | 8 lbs  | 2IA18                 | 2IA18L             |
| 24"           | 1200 lbs | 9 lbs  | 2IA24                 | 2IA24L             |
| 30"           | 1000 lbs | 10 lbs | 2IA30                 | 2IA30L             |
| 36"           | 800 lbs  | 11 lbs | 2IA36                 | 2IA36L             |
| 42"           | 700 lbs  | 14 lbs | 2IA42                 | 2IA42L             |
| 48"           | 600 lbs  | 16 lbs | 2IA48                 | 2IA48L             |

STRAIGHT ARMS have a minimum pitch of 3/8" per foot to compensate for deflection. Arm capacities are based on an evenly distributed load.

INCLINED ARMS have a pitch of 20 degrees or approximately 4.36" per foot. Arm capacities are based on an evenly distributed load.

Note that arm lips are not intended to bear any portion of the load.



Single Sided Uprights

| HEAVY DUTY AND EXTRA HEAVY DUTY STRAIGHT ARMS |          |        |                       |                    |
|---|----------|--------|-----------------------|--------------------|
| LENGTH  | CAPACITY | WEIGHT | MODEL NO. WITHOUT LIP | MODEL NO. WITH LIP |
| 24"   | 2400 lbs | 14 lbs | 2HDSA24               | 2HDSA24L           |
| 30"   | 2000 lbs | 16 lbs | 2HDSA30               | 2HDSA30L           |
| 36"   | 1500 lbs | 18 lbs | 2HDSA36               | 2HDSA36L           |
|   | 2400 lbs | 23 lbs | 2XHDSA36              | 2XHDSA36L          |
| 42"   | 1400 lbs | 20 lbs | 2HDSA42               | 2HDSA42L           |
|   | 2400 lbs | 26 lbs | 2XHDSA42              | 2XHDSA42L          |
| 48"   | 1000 lbs | 21 lbs | 2HDSA481M             | 2HDSA48L1M         |
|   | 1500 lbs | 24 lbs | 2HDSA48               | 2HDSA48L           |
|   | 2000 lbs | 29 lbs | 2XHDSA48              | 2XHDSA48L          |



Double Sided Uprights

| LENGTH* | BRACES FOR 8' UPRIGHTS – SET OF TWO |         | BRACES FOR 10' - 14' UPRIGHTS – SET OF THREE |         | BRACES FOR 16' - 20' UPRIGHTS – SET OF FOUR INCLUDING X-BRACING |         |
|---------|-------------------------------------|---------|--|---------|---|---------|
|         | MODEL NO.                           | WEIGHT  | MODEL NO.                                    | WEIGHT  | MODEL NO.   | WEIGHT  |
| 23"     | 22B24                               | 21 lbs  | 23B24  | 31 lbs  | 24B24X  | 66 lbs  |
| 35"     | 22B36                               | 28 lbs  | 23B36  | 41 lbs  | 24B36X  | 81 lbs  |
| 41"     | 22B42                               | 31 lbs  | 23B42  | 47 lbs  | 24B42X  | 90 lbs  |
| 47"     | 22B48                               | 35 lbs  | 23B48  | 52 lbs  | 24B48X  | 97 lbs  |
| 59"     | 22B60                               | 42 lbs  | 23B60  | 62 lbs  | 24B60X  | 113 lbs |
| 71"     | 22B72                               | 49 lbs  | 23B72  | 73 lbs  | 24B72X  | 130 lbs |
| 83"     | 22B84                               | 56 lbs  | 23B84  | 83 lbs  | 24B84X  | 147 lbs |
| 95"     | 22B96                               | 63 lbs  | 23B96  | 94 lbs  | 24B96XX   | 182 lbs |
| 119"    | 22B120                              | 113 lbs | 23B120                                       | 170 lbs | 24B120XX  | 283 lbs |

\* Length of braces is measured from center of upright to center of upright.

ALL WEIGHTS INCLUDE HARDWARE



# MODERN EQUIPMENT COMPANY, INC.

OMAHA

## SERIES 3000 HEAVY DUTY CANTILEVER RACK

### UPRIGHTS

FOR YOUR NORMAL INDUSTRIAL STORAGE REQUIREMENTS

| SINGLE SIDED UPRIGHTS |                |               |               |                 |           | DOUBLE SIDED UPRIGHTS |                |                 |              |                 |            |
|-----------------------|----------------|---------------|---------------|-----------------|-----------|-----------------------|----------------|-----------------|--------------|-----------------|------------|
| HEIGHT OF UPRIGHT     | LENGTH OF BASE | LENGTH OF ARM | WEIGHT (LBS)  | CAPACITY (LBS)  | MODEL NO. | HEIGHT OF UPRIGHT     | LENGTH OF BASE | LENGTH OF ARM   | WEIGHT (LBS) | CAPACITY (LBS)  | MODEL NO.  |
| 8'                    | 31"            | 12" & 18"     | 217           | 23,000 & 19,200 | U831-NS   | 8'                    | 53"            | 12" & 18"       | 253          | 46,000 & 38,400 | DU853-NS   |
|                       | 37"            | 24"           | 225           | 16,500          | U837-NS   |                       | 65"            | 24"             | 270          | 33,000          | DU865-NS   |
|                       | 49"            | 30"           | 243           | 14,400          | U849-NS   |                       | 82"            | 30"             | 295          | 28,800          | DU882-NS   |
|                       | 49"            | 36"           | 243           | 12,800          | U849-NS   |                       | 82"            | 36"             | 295          | 25,600          | DU882-NS   |
|                       | 61"            | 42"           | 261           | 11,500          | U861-NS   |                       | 106"           | 42"             | 329          | 23,000          | DU8106-NS  |
|                       | 61"            | 48"           | 261           | 10,400          | U861-NS   |                       | 106"           | 48"             | 329          | 20,800          | DU8106-NS  |
| 74"                   | 54" & 60"      | 279           | 9,600 & 8,800 | U874-NS         | 130"      | 54" & 60"             | 364            | 19,200 & 17,600 | DU8130-NS    |                 |            |
| 10'                   | 31"            | 12" & 18"     | 255           | 22,200 & 18,600 | U1031-NS  | 10'                   | 53"            | 12" & 18"       | 291          | 44,400 & 37,200 | DU1053-NS  |
|                       | 37"            | 24"           | 263           | 16,100          | U1037-NS  |                       | 65"            | 24"             | 308          | 32,200          | DU1065-NS  |
|                       | 49"            | 30"           | 281           | 14,100          | U1049-NS  |                       | 82"            | 30"             | 333          | 28,200          | DU1082-NS  |
|                       | 49"            | 36"           | 281           | 12,500          | U1049-NS  |                       | 82"            | 36"             | 333          | 25,000          | DU1082-NS  |
|                       | 61"            | 42"           | 299           | 11,300          | U1061-NS  |                       | 106"           | 42"             | 367          | 22,600          | DU10106-NS |
|                       | 61"            | 48"           | 299           | 10,200          | U1061-NS  |                       | 106"           | 48"             | 367          | 20,400          | DU10106-NS |
| 74"                   | 54" & 60"      | 317           | 9,400 & 8,700 | U1074-NS        | 130"      | 54" & 60"             | 402            | 18,800 & 17,400 | DU10130-NS   |                 |            |
| 12'                   | 31"            | 12" & 18"     | 291           | 21,300 & 18,000 | U1231-NS  | 12'                   | 53"            | 12" & 18"       | 327          | 42,600 & 36,000 | DU1253-NS  |
|                       | 37"            | 24"           | 299           | 15,600          | U1237-NS  |                       | 65"            | 24"             | 344          | 31,200          | DU1265-NS  |
|                       | 49"            | 30"           | 317           | 13,700          | U1249-NS  |                       | 82"            | 30"             | 369          | 27,400          | DU1282-NS  |
|                       | 49"            | 36"           | 317           | 12,200          | U1249-NS  |                       | 82"            | 36"             | 369          | 24,400          | DU1282-NS  |
|                       | 61"            | 42"           | 335           | 11,000          | U1261-NS  |                       | 106"           | 42"             | 403          | 22,000          | DU12106-NS |
|                       | 61"            | 48"           | 335           | 10,100          | U1261-NS  |                       | 106"           | 48"             | 403          | 20,200          | DU12106-NS |
| 74"                   | 54" & 60"      | 353           | 9,200 & 8,600 | U1274-NS        | 130"      | 54" & 60"             | 438            | 18,400 & 17,200 | DU12130-NS   |                 |            |
| 14'                   | 37"            | 12" & 18"     | 338           | 20,500 & 17,400 | U1437-NS  | 14'                   | 65"            | 12" & 18"       | 382          | 41,000 & 34,800 | DU1465-NS  |
|                       | 37"            | 24"           | 338           | 15,100          | U1437-NS  |                       | 82"            | 24"             | 382          | 30,200          | DU1465-NS  |
|                       | 49"            | 30"           | 356           | 13,300          | U1449-NS  |                       | 82"            | 30"             | 407          | 26,600          | DU1482-NS  |
|                       | 49"            | 36"           | 356           | 11,800          | U1449-NS  |                       | 82"            | 36"             | 407          | 23,600          | DU1482-NS  |
|                       | 61"            | 42"           | 373           | 10,700          | U1461-NS  |                       | 106"           | 42"             | 442          | 21,400          | DU14106-NS |
|                       | 61"            | 48"           | 373           | 9,800           | U1461-NS  |                       | 106"           | 48"             | 442          | 19,600          | DU14106-NS |
| 74"                   | 54" & 60"      | 391           | 9,000 & 8,300 | U1474-NS        | 130"      | 54" & 60"             | 476            | 18,000 & 16,600 | DU14130-NS   |                 |            |
| 15'                   | 37"            | 12" & 18"     | 358           | 20,000 & 17,100 | U1537-NS  | 15'                   | 65"            | 12" & 18"       | 402          | 40,000 & 34,200 | DU1565-NS  |
|                       | 37"            | 24"           | 358           | 14,800          | U1537-NS  |                       | 82"            | 24"             | 402          | 29,600          | DU1565-NS  |
|                       | 49"            | 30"           | 375           | 13,200          | U1549-NS  |                       | 82"            | 30"             | 427          | 26,400          | DU1582-NS  |
|                       | 49"            | 36"           | 375           | 11,600          | U1549-NS  |                       | 82"            | 36"             | 427          | 23,200          | DU1582-NS  |
|                       | 61"            | 42"           | 393           | 10,500          | U1561-NS  |                       | 106"           | 42"             | 462          | 21,000          | DU15106-NS |
|                       | 61"            | 48"           | 393           | 9,700           | U1561-NS  |                       | 106"           | 48"             | 462          | 19,400          | DU15106-NS |
| 74"                   | 54" & 60"      | 411           | 8,900 & 8,300 | U1574-NS        | 130"      | 54" & 60"             | 496            | 17,800 & 16,600 | DU15130-NS   |                 |            |
| 16'                   | 37"            | 12" & 18"     | 376           | 19,300 & 16,600 | U1637-NS  | 16'                   | 65"            | 12" & 18"       | 420          | 38,600 & 33,200 | DU1665-NS  |
|                       | 37"            | 24"           | 376           | 14,400          | U1637-NS  |                       | 82"            | 24"             | 420          | 28,800          | DU1665-NS  |
|                       | 49"            | 30"           | 393           | 12,800          | U1649-NS  |                       | 82"            | 30"             | 445          | 25,600          | DU1682-NS  |
|                       | 49"            | 36"           | 393           | 11,300          | U1649-NS  |                       | 82"            | 36"             | 445          | 22,600          | DU1682-NS  |
|                       | 61"            | 42"           | 411           | 10,400          | U1661-NS  |                       | 106"           | 42"             | 479          | 20,800          | DU16106-NS |
|                       | 61"            | 48"           | 411           | 9,500           | U1661-NS  |                       | 106"           | 48"             | 479          | 19,000          | DU16106-NS |
| 74"                   | 54" & 60"      | 429           | 8,800 & 8,200 | U1674-NS        | 130"      | 54" & 60"             | 514            | 17,600 & 16,400 | DU16130-NS   |                 |            |
| 18'                   | 49"            | 12" & 18"     | 429           | 18,200 & 15,600 | U1849-NS  | 18'                   | 82"            | 12" & 18"       | 480          | 36,400 & 31,200 | DU1882-NS  |
|                       | 49"            | 24"           | 429           | 13,800          | U1849-NS  |                       | 82"            | 24"             | 480          | 27,600          | DU1882-NS  |
|                       | 49"            | 30"           | 429           | 12,300          | U1849-NS  |                       | 82"            | 30"             | 480          | 24,600          | DU1882-NS  |
|                       | 49"            | 36"           | 429           | 10,800          | U1849-NS  |                       | 82"            | 36"             | 480          | 21,600          | DU1882-NS  |
|                       | 61"            | 42"           | 446           | 9,900           | U1861-NS  |                       | 106"           | 42"             | 515          | 19,800          | DU18106-NS |
|                       | 61"            | 48"           | 446           | 9,200           | U1861-NS  |                       | 106"           | 48"             | 515          | 18,400          | DU18106-NS |
| 74"                   | 54" & 60"      | 464           | 8,500 & 8,000 | U1874-NS        | 130"      | 54" & 60"             | 549            | 17,000 & 16,000 | DU18130-NS   |                 |            |
| 20'                   | 49"            | 12" & 18"     | 464           | 16,700 & 14,600 | U2049-NS  | 20'                   | 82"            | 12" & 18"       | 516          | 33,400 & 29,200 | DU2082-NS  |
|                       | 49"            | 24"           | 464           | 12,900          | U2049-NS  |                       | 82"            | 24"             | 516          | 25,800          | DU2082-NS  |
|                       | 49"            | 30"           | 464           | 11,700          | U2049-NS  |                       | 82"            | 30"             | 516          | 23,400          | DU2082-NS  |
|                       | 49"            | 36"           | 464           | 10,400          | U2049-NS  |                       | 82"            | 36"             | 516          | 20,800          | DU2082-NS  |
|                       | 61"            | 42"           | 481           | 9,400           | U2061-NS  |                       | 106"           | 42"             | 550          | 18,800          | DU20106-NS |
|                       | 61"            | 48"           | 481           | 8,800           | U2061-NS  |                       | 106"           | 48"             | 550          | 17,600          | DU20106-NS |
| 74"                   | 54" & 60"      | 500           | 8,100 & 7,600 | U2074-NS        | 130"      | 54" & 60"             | 584            | 16,200 & 15,200 | DU20130-NS   |                 |            |

A MECO OMAHA rack system can be specifically designed to meet your individual requirements. MECO OMAHA representatives will work with you to develop the most feasible and economical rack system for your special situation.

### BRACE SETS

All braces can be used on SERIES 3000, SERIES 4000 or SERIES 5000 uprights only.

| LENGTH* | FOR 8' UPRIGHTS SET OF TWO |         | FOR 10' - 14' UPRIGHTS SET OF THREE |         | FOR 15' - 20' UPRIGHTS SET OF FOUR INCLUDING X-BRACING |         |
|---------|----------------------------|---------|-------------------------------------|---------|--|---------|
|         | MODEL NO.                  | WEIGHT  | MODEL NO.                           | WEIGHT  | MODEL NO.  | WEIGHT  |
| 24"     | 2B24                       | 21 lbs  | 3B24                                | 31 lbs  | 4B24X  | 66 lbs  |
| 36"     | 2B36                       | 28 lbs  | 3B36                                | 41 lbs  | 4B36X  | 81 lbs  |
| 42"     | 2B42                       | 31 lbs  | 3B42                                | 47 lbs  | 4B42X  | 90 lbs  |
| 48"     | 2B48                       | 35 lbs  | 3B48                                | 52 lbs  | 4B48X  | 97 lbs  |
| 60"     | 2B60                       | 42 lbs  | 3B60                                | 62 lbs  | 4B60X  | 113 lbs |
| 72"     | 2B72                       | 49 lbs  | 3B72                                | 73 lbs  | 4B72X  | 130 lbs |
| 84"     | 2B84                       | 56 lbs  | 3B84                                | 83 lbs  | 4B84X  | 147 lbs |
| 96"     | 2B96                       | 63 lbs  | 3B96                                | 94 lbs  | 4B96XX   | 182 lbs |
| 120"    | 2B120                      | 113 lbs | 3B120                               | 170 lbs | 4B120XX  | 283 lbs |

\*Length of braces is measured from center of upright to center of upright.

ALL WEIGHTS INCLUDE HARDWARE







**SERIES 4000 STANDARD HEAVY DUTY CANTILEVER RACK UPRIGHTS**

FOR YOUR NORMAL HEAVY DUTY INDUSTRIAL STORAGE REQUIREMENTS

| SINGLE SIDED UPRIGHTS |                |               |              |                 |           | DOUBLE SIDED UPRIGHTS |                |               |              |                 |           |
|-----------------------|----------------|---------------|--------------|-----------------|-----------|-----------------------|----------------|---------------|--------------|-----------------|-----------|
| HEIGHT OF UPRIGHT     | LENGTH OF BASE | LENGTH OF ARM | WEIGHT (LBS) | CAPACITY (LBS)  | MODEL NO. | HEIGHT OF UPRIGHT     | LENGTH OF BASE | LENGTH OF ARM | WEIGHT (LBS) | CAPACITY (LBS)  | MODEL NO. |
| 8'                    | 31"            | 12" & 18"     | 237          | 28,600 & 24,700 | U831      | 8'                    | 53"            | 12" & 18"     | 273          | 57,200 & 49,400 | DU853     |
|                       | 37"            | 24"           | 245          | 21,500          | U837      |                       | 65"            | 24"           | 290          | 43,000          | DU865     |
|                       | 49"            | 30"           | 263          | 18,300          | U849      |                       | 82"            | 30"           | 315          | 36,600          | DU882     |
|                       | 49"            | 36"           | 263          | 16,000          | U849      |                       | 82"            | 36"           | 315          | 32,000          | DU882     |
|                       | 61"            | 42"           | 281          | 14,200          | U861      |                       | 106"           | 42"           | 349          | 28,400          | DU8106    |
|                       | 61"            | 48"           | 281          | 12,800          | U861      |                       | 106"           | 48"           | 349          | 25,600          | DU8106    |
|                       | 74"            | 54" & 60"     | 299          | 11,600 & 10,700 | U874      |                       | 130"           | 54" & 60"     | 384          | 23,200 & 21,400 | DU8130    |
| 10'                   | 31"            | 12" & 18"     | 275          | 28,500 & 24,600 | U1031     | 10'                   | 53"            | 12" & 18"     | 311          | 57,000 & 49,200 | DU1053    |
|                       | 37"            | 24"           | 283          | 21,300          | U1037     |                       | 65"            | 24"           | 328          | 42,600          | DU1065    |
|                       | 49"            | 30"           | 301          | 18,200          | U1049     |                       | 82"            | 30"           | 353          | 36,400          | DU1082    |
|                       | 49"            | 36"           | 301          | 15,800          | U1049     |                       | 82"            | 36"           | 353          | 31,600          | DU1082    |
|                       | 61"            | 42"           | 319          | 14,100          | U1061     |                       | 106"           | 42"           | 387          | 28,200          | DU10106   |
|                       | 61"            | 48"           | 319          | 12,600          | U1061     |                       | 106"           | 48"           | 387          | 25,200          | DU10106   |
|                       | 74"            | 54" & 60"     | 337          | 11,500 & 10,600 | U1074     |                       | 130"           | 54" & 60"     | 422          | 23,000 & 21,200 | DU10130   |
| 12'                   | 31"            | 12" & 18"     | 311          | 28,200 & 24,400 | U1231     | 12'                   | 53"            | 12" & 18"     | 347          | 56,400 & 48,800 | DU1253    |
|                       | 37"            | 24"           | 319          | 20,900          | U1237     |                       | 65"            | 24"           | 364          | 41,800          | DU1265    |
|                       | 49"            | 30"           | 337          | 17,800          | U1249     |                       | 82"            | 30"           | 389          | 35,600          | DU1282    |
|                       | 49"            | 36"           | 337          | 15,600          | U1249     |                       | 82"            | 36"           | 389          | 31,200          | DU1282    |
|                       | 61"            | 42"           | 355          | 13,900          | U1261     |                       | 106"           | 42"           | 423          | 27,800          | DU12106   |
|                       | 61"            | 48"           | 355          | 12,500          | U1261     |                       | 106"           | 48"           | 423          | 25,000          | DU12106   |
|                       | 74"            | 54" & 60"     | 373          | 11,400 & 10,500 | U1274     |                       | 130"           | 54" & 60"     | 458          | 22,800 & 21,000 | DU12130   |
| 14'                   | 37"            | 12" & 18"     | 358          | 27,400 & 23,400 | U1437     | 14'                   | 65"            | 12" & 18"     | 402          | 54,800 & 46,800 | DU1465    |
|                       | 37"            | 24"           | 358          | 20,200          | U1437     |                       | 65"            | 24"           | 402          | 40,400          | DU1465    |
|                       | 49"            | 30"           | 376          | 17,600          | U1449     |                       | 82"            | 30"           | 427          | 35,200          | DU1482    |
|                       | 49"            | 36"           | 376          | 15,400          | U1449     |                       | 82"            | 36"           | 427          | 30,800          | DU1482    |
|                       | 61"            | 42"           | 393          | 13,700          | U1461     |                       | 106"           | 42"           | 462          | 27,400          | DU14106   |
|                       | 61"            | 48"           | 393          | 12,400          | U1461     |                       | 106"           | 48"           | 462          | 24,800          | DU14106   |
|                       | 74"            | 54" & 60"     | 411          | 11,300 & 10,400 | U1474     |                       | 130"           | 54" & 60"     | 496          | 22,600 & 20,800 | DU14130   |
| 15'                   | 37"            | 12" & 18"     | 378          | 27,100 & 22,600 | U1537     | 15'                   | 65"            | 12" & 18"     | 422          | 54,200 & 45,200 | DU1565    |
|                       | 37"            | 24"           | 378          | 19,200          | U1537     |                       | 65"            | 24"           | 422          | 38,400          | DU1565    |
|                       | 49"            | 30"           | 395          | 16,900          | U1549     |                       | 82"            | 30"           | 447          | 33,800          | DU1582    |
|                       | 49"            | 36"           | 395          | 15,000          | U1549     |                       | 82"            | 36"           | 447          | 30,000          | DU1582    |
|                       | 61"            | 42"           | 413          | 13,600          | U1561     |                       | 106"           | 42"           | 482          | 27,200          | DU15106   |
|                       | 61"            | 48"           | 413          | 12,300          | U1561     |                       | 106"           | 48"           | 482          | 24,600          | DU15106   |
|                       | 74"            | 54" & 60"     | 431          | 11,200 & 10,300 | U1574     |                       | 130"           | 54" & 60"     | 516          | 22,400 & 20,600 | DU15130   |
| 16'                   | 37"            | 12" & 18"     | 396          | 23,700 & 20,300 | U1637     | 16'                   | 65"            | 12" & 18"     | 440          | 47,400 & 40,600 | DU1665    |
|                       | 37"            | 24"           | 396          | 17,600          | U1637     |                       | 65"            | 24"           | 440          | 35,200          | DU1665    |
|                       | 49"            | 30"           | 413          | 15,300          | U1649     |                       | 82"            | 30"           | 465          | 30,600          | DU1682    |
|                       | 49"            | 36"           | 413          | 14,000          | U1649     |                       | 82"            | 36"           | 465          | 28,000          | DU1682    |
|                       | 61"            | 42"           | 431          | 12,900          | U1661     |                       | 106"           | 42"           | 499          | 25,800          | DU16106   |
|                       | 61"            | 48"           | 431          | 12,000          | U1661     |                       | 106"           | 48"           | 499          | 24,000          | DU16106   |
|                       | 74"            | 54" & 60"     | 449          | 11,100 & 10,300 | U1674     |                       | 130"           | 54" & 60"     | 534          | 22,200 & 20,600 | DU16130   |
| 18'                   | 49"            | 12" & 18"     | 449          | 22,200 & 19,200 | U1849     | 18'                   | 82"            | 12" & 18"     | 500          | 44,400 & 38,400 | DU1882    |
|                       | 49"            | 24"           | 449          | 16,700          | U1849     |                       | 82"            | 24"           | 500          | 33,400          | DU1882    |
|                       | 49"            | 30"           | 449          | 14,700          | U1849     |                       | 82"            | 30"           | 500          | 29,400          | DU1882    |
|                       | 49"            | 36"           | 449          | 13,600          | U1849     |                       | 82"            | 36"           | 500          | 27,200          | DU1882    |
|                       | 61"            | 42"           | 466          | 12,700          | U1861     |                       | 106"           | 42"           | 535          | 25,400          | DU18106   |
|                       | 61"            | 48"           | 466          | 11,900          | U1861     |                       | 106"           | 48"           | 535          | 23,800          | DU18106   |
|                       | 74"            | 54" & 60"     | 484          | 11,000 & 10,000 | U1874     |                       | 130"           | 54" & 60"     | 569          | 22,000 & 20,000 | DU18130   |
| 20'                   | 49"            | 12" & 18"     | 484          | 20,600 & 17,800 | U2049     | 20'                   | 82"            | 12" & 18"     | 536          | 41,200 & 35,600 | DU2082    |
|                       | 49"            | 24"           | 484          | 15,800          | U2049     |                       | 82"            | 24"           | 536          | 31,600          | DU2082    |
|                       | 49"            | 30"           | 484          | 13,900          | U2049     |                       | 82"            | 30"           | 536          | 27,800          | DU2082    |
|                       | 49"            | 36"           | 484          | 12,800          | U2049     |                       | 82"            | 36"           | 536          | 25,600          | DU2082    |
|                       | 61"            | 42"           | 501          | 11,900          | U2061     |                       | 106"           | 42"           | 570          | 23,800          | DU20106   |
|                       | 61"            | 48"           | 501          | 11,200          | U2061     |                       | 106"           | 48"           | 570          | 22,400          | DU20106   |
|                       | 74"            | 54" & 60"     | 520          | 10,500 & 9,800  | U2074     |                       | 130"           | 54" & 60"     | 604          | 21,000 & 19,600 | DU20130   |

A MECO OMAHA rack system can be specifically designed to meet your individual requirements. MECO OMAHA representatives will work with you to develop the most feasible and economical rack system for your special situation.

**ARMS** can be used on SERIES 3000, SERIES 4000 or SERIES 5000 uprights only. Capacities are based on an evenly distributed load. Note that arm lips are not intended to bear any portion of the load.

| STANDARD STRAIGHT ARMS |          |        |                       |                    |
|------------------------|----------|--------|-----------------------|--------------------|
| LENGTH                 | CAPACITY | WEIGHT | MODEL NO. WITHOUT LIP | MODEL NO. WITH LIP |
| 12"                    | 3000 lbs | 9 lbs  | SA12                  | SA12L              |
| 18"                    | 2500 lbs | 11 lbs | SA18                  | SA18L              |
| 24"                    | 2000 lbs | 13 lbs | SA24                  | SA24L              |
| 30"                    | 1500 lbs | 15 lbs | SA30                  | SA30L              |
| 36"                    | 1200 lbs | 17 lbs | SA36                  | SA36L              |
| 42"                    | 1100 lbs | 19 lbs | SA42                  | SA42L              |
| 48"                    | 1000 lbs | 21 lbs | SA48                  | SA48L              |
| 54"                    | 800 lbs  | 24 lbs | SA54                  | SA54L              |
| 60"                    | 600 lbs  | 26 lbs | SA60                  | SA60L              |

**STRAIGHT ARMS** through 48" long have a minimum pitch of 3/8" per foot to compensate for deflection. 54" and 60" arms have a minimum pitch of 5/8" per foot.

| STANDARD INCLINED ARMS |          |        |                       |                    |
|------------------------|----------|--------|-----------------------|--------------------|
| LENGTH                 | CAPACITY | WEIGHT | MODEL NO. WITHOUT LIP | MODEL NO. WITH LIP |
| 12"                    | 3000 lbs | 9 lbs  | IA12                  | IA12L              |
| 18"                    | 2500 lbs | 11 lbs | IA18                  | IA18L              |
| 24"                    | 2000 lbs | 13 lbs | IA24                  | IA24L              |
| 30"                    | 1500 lbs | 15 lbs | IA30                  | IA30L              |
| 36"                    | 1200 lbs | 17 lbs | IA36                  | IA36L              |
| 42"                    | 1100 lbs | 22 lbs | IA42                  | IA42L              |
| 48"                    | 1000 lbs | 23 lbs | IA48                  | IA48L              |

**INCLINED ARMS** have a pitch of 20 degrees or approximately 4.36" per foot.

**ALL WEIGHTS INCLUDE HARDWARE**

See page 28 for Heavy Duty and Extra Heavy Duty Straight Arms for use with uprights on pages 26 and 27.



**SERIES 5000 EXTRA HEAVY DUTY CANTILEVER RACK**

**UPRIGHTS**

FOR STORAGE REQUIREMENTS WHICH DEMAND HEAVIER CAPACITY RACKS

MECO OMAHA SERIES 5000 CANTILEVER RACK solves your extra heavy duty storage problems and easily handles your toughest storage requirements. Contact your MECO OMAHA representative for your special storage needs.

| SINGLE SIDED UPRIGHTS |                |               |              |                |           |
|-----------------------|----------------|---------------|--------------|----------------|-----------|
| HEIGHT OF UPRIGHT     | LENGTH OF BASE | LENGTH OF ARM | WEIGHT (LBS) | CAPACITY (LBS) | MODEL NO. |
| 12'                   | 40"            | 24"           | 410          | 28,700         | XU1240    |
|                       | 52"            | 30"           | 432          | 24,800         | XU1252    |
|                       | 52"            | 36"           | 432          | 21,900         | XU1252    |
|                       | 64"            | 42"           | 454          | 19,600         | XU1264    |
|                       | 64"            | 48"           | 454          | 17,700         | XU1264    |
|                       | 76"            | 54"           | 477          | 16,100         | XU1276    |
|                       | 76"            | 60"           | 477          | 14,900         | XU1276    |
| 14'                   | 40"            | 24"           | 455          | 28,400         | XU1440    |
|                       | 52"            | 30"           | 477          | 24,700         | XU1452    |
|                       | 52"            | 36"           | 477          | 21,000         | XU1452    |
|                       | 64"            | 42"           | 499          | 19,100         | XU1464    |
|                       | 64"            | 48"           | 499          | 17,600         | XU1464    |
|                       | 76"            | 54"           | 522          | 16,000         | XU1476    |
|                       | 76"            | 60"           | 522          | 14,600         | XU1476    |
| 15'                   | 52"            | 24"           | 497          | 28,200         | XU1552    |
|                       | 52"            | 30"           | 497          | 22,600         | XU1552    |
|                       | 52"            | 36"           | 497          | 20,700         | XU1552    |
|                       | 64"            | 42"           | 519          | 18,900         | XU1564    |
|                       | 64"            | 48"           | 519          | 17,400         | XU1564    |
|                       | 76"            | 54"           | 542          | 15,900         | XU1576    |
|                       | 76"            | 60"           | 542          | 14,500         | XU1576    |
| 16'                   | 52"            | 24"           | 522          | 27,600         | XU1652    |
|                       | 52"            | 30"           | 522          | 24,300         | XU1652    |
|                       | 52"            | 36"           | 522          | 20,500         | XU1652    |
|                       | 64"            | 42"           | 544          | 18,700         | XU1664    |
|                       | 64"            | 48"           | 544          | 17,200         | XU1664    |
|                       | 76"            | 54"           | 567          | 15,700         | XU1676    |
|                       | 76"            | 60"           | 567          | 14,400         | XU1676    |
| 18'                   | 52"            | 24"           | 565          | 25,900         | XU1852    |
|                       | 52"            | 30"           | 565          | 23,100         | XU1852    |
|                       | 52"            | 36"           | 565          | 20,400         | XU1852    |
|                       | 64"            | 42"           | 587          | 18,200         | XU1864    |
|                       | 64"            | 48"           | 587          | 16,800         | XU1864    |
|                       | 76"            | 54"           | 610          | 15,300         | XU1876    |
|                       | 76"            | 60"           | 610          | 14,100         | XU1876    |
| 20'                   | 52"            | 24"           | 607          | 25,300         | XU2052    |
|                       | 52"            | 30"           | 607          | 21,800         | XU2052    |
|                       | 52"            | 36"           | 607          | 19,700         | XU2052    |
|                       | 64"            | 42"           | 629          | 17,600         | XU2064    |
|                       | 64"            | 48"           | 629          | 16,300         | XU2064    |
|                       | 76"            | 54"           | 652          | 14,900         | XU2076    |
|                       | 76"            | 60"           | 652          | 13,800         | XU2076    |

| DOUBLE SIDED UPRIGHTS |                |               |              |                |           |
|-----------------------|----------------|---------------|--------------|----------------|-----------|
| HEIGHT OF UPRIGHT     | LENGTH OF BASE | LENGTH OF ARM | WEIGHT (LBS) | CAPACITY (LBS) | MODEL NO. |
| 12'                   | 66"            | 24"           | 464          | 57,400         | XDU1266   |
|                       | 84"            | 30"           | 498          | 49,600         | XDU1284   |
|                       | 84"            | 36"           | 498          | 43,800         | XDU1284   |
|                       | 108"           | 42"           | 542          | 39,200         | XDU12108  |
|                       | 108"           | 48"           | 542          | 35,400         | XDU12108  |
|                       | 132"           | 54"           | 586          | 32,200         | XDU12132  |
|                       | 132"           | 60"           | 586          | 29,800         | XDU12132  |
| 14'                   | 66"            | 24"           | 509          | 56,800         | XDU1466   |
|                       | 84"            | 30"           | 543          | 49,400         | XDU1484   |
|                       | 84"            | 36"           | 543          | 42,000         | XDU1484   |
|                       | 108"           | 42"           | 587          | 38,200         | XDU14108  |
|                       | 108"           | 48"           | 587          | 35,200         | XDU14108  |
|                       | 132"           | 54"           | 631          | 32,000         | XDU14132  |
|                       | 132"           | 60"           | 631          | 29,200         | XDU14132  |
| 15'                   | 84"            | 24"           | 563          | 56,400         | XDU1584   |
|                       | 84"            | 30"           | 563          | 45,200         | XDU1584   |
|                       | 84"            | 36"           | 563          | 41,400         | XDU1584   |
|                       | 108"           | 42"           | 607          | 37,800         | XDU15108  |
|                       | 108"           | 48"           | 607          | 34,800         | XDU15108  |
|                       | 132"           | 54"           | 651          | 31,800         | XDU15132  |
|                       | 132"           | 60"           | 651          | 29,000         | XDU15132  |
| 16'                   | 84"            | 24"           | 588          | 55,200         | XDU1684   |
|                       | 84"            | 30"           | 588          | 48,600         | XDU1684   |
|                       | 84"            | 36"           | 588          | 41,000         | XDU1684   |
|                       | 108"           | 42"           | 632          | 37,400         | XDU16108  |
|                       | 108"           | 48"           | 632          | 34,400         | XDU16108  |
|                       | 132"           | 54"           | 676          | 31,400         | XDU16132  |
|                       | 132"           | 60"           | 676          | 28,800         | XDU16132  |
| 18'                   | 84"            | 24"           | 630          | 51,800         | XDU1884   |
|                       | 84"            | 30"           | 630          | 46,200         | XDU1884   |
|                       | 84"            | 36"           | 630          | 40,800         | XDU1884   |
|                       | 108"           | 42"           | 674          | 36,400         | XDU18108  |
|                       | 108"           | 48"           | 674          | 33,600         | XDU18108  |
|                       | 132"           | 54"           | 719          | 30,600         | XDU18132  |
|                       | 132"           | 60"           | 719          | 28,200         | XDU18132  |
| 20'                   | 84"            | 24"           | 673          | 50,600         | XDU2084   |
|                       | 84"            | 30"           | 673          | 43,600         | XDU2084   |
|                       | 84"            | 36"           | 673          | 39,400         | XDU2084   |
|                       | 108"           | 42"           | 717          | 35,200         | XDU20108  |
|                       | 108"           | 48"           | 717          | 32,600         | XDU20108  |
|                       | 132"           | 54"           | 761          | 29,800         | XDU20132  |
|                       | 132"           | 60"           | 761          | 27,600         | XDU20132  |

**ARMS** can be used on SERIES 3000, SERIES 4000 or SERIES 5000 uprights only. Capacities are based on an evenly distributed load. Note that arm lips are not intended to bear any portion of the load.

| HEAVY DUTY AND EXTRA HEAVY DUTY STRAIGHT ARMS |          |        |                       |                    |
|---|----------|--------|-----------------------|--------------------|
| LENGTH  | CAPACITY | WEIGHT | MODEL NO. WITHOUT LIP | MODEL NO. WITH LIP |
| 36"   | 2175 lbs | 28 lbs | HDSA36                | HDSA36L            |
|   | 3400 lbs | 34 lbs | XHDSA36               | XHDSA36L           |
| 42"   | 1865 lbs | 31 lbs | HDSA42                | HDSA42L            |
|   | 2900 lbs | 37 lbs | XHDSA42               | XHDSA42L           |
| 48"   | 1630 lbs | 34 lbs | HDSA48                | HDSA48L            |
|   | 2000 lbs | 36 lbs | HDSA482M              | HDSA48L2M          |
|   | 2500 lbs | 40 lbs | XHDSA48               | XHDSA48L           |
|   | 3000 lbs | 39 lbs | XHDSA483M             | XHDSA48L3M         |
|   | 4000 lbs | 51 lbs | XHDSA484M             | XHDSA48L4M         |
| 54"   | 1440 lbs | 38 lbs | HDSA54                | HDSA54L            |
|   | 2000 lbs | 44 lbs | XHDSA54               | XHDSA54L           |
| 60"   | 1300 lbs | 42 lbs | HDSA60                | HDSA60L            |
|   | 1650 lbs | 46 lbs | XHDSA60               | XHDSA60L           |
|   | 2000 lbs | 61 lbs | XHDSA602M             | XHDSA60L2M         |

| MAXIMUM STANDARD ARMS PER UPRIGHT<br>(UPRIGHT CAPACITIES MUST BE OBSERVED) |                |                |
|--|----------------|----------------|
| UPRIGHT  | SINGLE UPRIGHT | DOUBLE UPRIGHT |
| 8'   | 9              | 18             |
| 10'  | 12             | 24             |
| 12'  | 14             | 28             |
| 14'  | 17             | 34             |
| 15'  | 18             | 36             |
| 16'  | 20             | 40             |
| 18'  | 22             | 44             |
| 20'  | 24             | 48             |

ALL WEIGHTS INCLUDE HARDWARE

See pages 26 and 27 for Brace Sets, Standard Straight Arms and Standard Inclined Arms for use with Series 5000 uprights.



## CANTILEVER RACK STARTER AND ADD-ON UNITS

A COMPLETE STORAGE SYSTEM DESIGNED WITH FLEXIBILITY AND SIMPLICITY IN MIND

MECO OMAHA has assembled the most popular Series 1000 and Series 4000 cantilever components to create Starter and Add-On units—take the guesswork out of selecting a rack system! Order a single or double sided starter unit consisting of 2 uprights, straight arms and braces to assemble a single bay storage unit.

Create a continuous rack system with add-on units which include 1 Series 1000 upright, straight arms and the appropriate brace set. Choose models in upright heights of 6', 8' or 10'. Series 4000 models are available in 8', 10' and 12' heights and easily handle lighter capacity requirements.

### SERIES 1000 MEDIUM DUTY CANTILEVER RACK

| STARTER UNITS  |             |                |             |             |          |                |              | ADD-ON UNITS   |             |          |              |
|--|-------------|----------------|-------------|-------------|----------|----------------|--------------|--|-------------|----------|--------------|
| INCLUDES: 2 UPRIGHTS, STRAIGHT ARMS, 1 BRACE SET<br>(47" BRACE SET FOR 6' AND 8' UPRIGHTS, 71" BRACE SET FOR 10' UPRIGHTS) |             |                |             |             |          |                |              | INCLUDES: 1 UPRIGHT, STRAIGHT ARMS, 1 BRACE SET<br>(47" BRACE SET FOR 6' AND 8' UPRIGHTS,<br>71" BRACE SET FOR 10' UPRIGHTS) |             |          |              |
| MODEL NO.  | UPRIGHT     |                | BASE        | ARMS*       |          |                | WEIGHT (LBS) | MODEL NO.  | ARMS*       |          | WEIGHT (LBS) |
|  | HEIGHT (FT) | CAPACITY (LBS) | LENGTH (IN) | LENGTH (IN) | QUANTITY | CAPACITY (LBS) |              |  | LENGTH (IN) | QUANTITY |              |
| <b>SINGLE SIDED UNITS</b>  |             |                |             |             |          |                |              |  |             |          |              |
| SM6  | 6           | 8,100          | 33          | 12          | 6        | 1,000          | 235          | AM6  | 12          | 3        | 135          |
| SM8  | 8           | 5,300          | 33          | 24          | 8        | 600            | 291          | AM8  | 24          | 4        | 163          |
| SM10   | 10          | 3,800          | 45          | 36          | 12       | 400            | 405          | AM10   | 36          | 6        | 227          |
| <b>DOUBLE SIDED UNITS</b>  |             |                |             |             |          |                |              |  |             |          |              |
| SMD6   | 6           | 16,200         | 54          | 12          | 12       | 1,000          | 305          | AMD6   | 12          | 6        | 170          |
| SMD8   | 8           | 10,600         | 54          | 24          | 16       | 600            | 389          | AMD8   | 24          | 8        | 212          |
| SMD10  | 10          | 7,600          | 78          | 36          | 24       | 400            | 575          | AMD10  | 36          | 12       | 312          |

\*Add Suffix "L" to Model Number for Arms with Lips.

### SERIES 4000 STANDARD HEAVY DUTY CANTILEVER RACK

| STARTER UNITS                                     |             |                |             |             |          |                |              | ADD-ON UNITS                                     |             |          |              |
|---|-------------|----------------|-------------|-------------|----------|----------------|--------------|--|-------------|----------|--------------|
| INCLUDES: 2 UPRIGHTS, STRAIGHT ARMS, 6' BRACE SET |             |                |             |             |          |                |              | INCLUDES: 1 UPRIGHT, STRAIGHT ARMS, 6' BRACE SET |             |          |              |
| MODEL NO.   | UPRIGHT     |                | BASE        | ARMS*       |          |                | WEIGHT (LBS) | MODEL NO.  | ARMS*       |          | WEIGHT (LBS) |
|   | HEIGHT (FT) | CAPACITY (LBS) | LENGTH (IN) | LENGTH (IN) | QUANTITY | CAPACITY (LBS) |              |  | LENGTH (IN) | QUANTITY |              |
| <b>SINGLE SIDED UNITS</b>                         |             |                |             |             |          |                |              |  |             |          |              |
| SU8   | 8           | 21,500         | 37          | 24          | 8        | 2,000          | 643          | AU8  | 24          | 4        | 346          |
| SU10  | 10          | 15,800         | 49          | 36          | 12       | 1,200          | 879          | AU10   | 36          | 6        | 476          |
| SU12  | 12          | 12,500         | 61          | 48          | 16       | 1,000          | 1,119        | AU12   | 48          | 8        | 596          |
| <b>DOUBLE SIDED UNITS</b>                         |             |                |             |             |          |                |              |  |             |          |              |
| SDU8  | 8           | 43,000         | 65          | 24          | 16       | 2,000          | 837          | ADU8   | 24          | 8        | 443          |
| SDU10   | 10          | 31,600         | 82          | 36          | 24       | 1,200          | 1,187        | ADU10  | 36          | 12       | 630          |
| SDU12   | 12          | 25,000         | 106         | 48          | 32       | 1,000          | 1,591        | ADU12  | 48          | 16       | 832          |

\* Add Suffix "L" to Model Number for Arms with Lips.

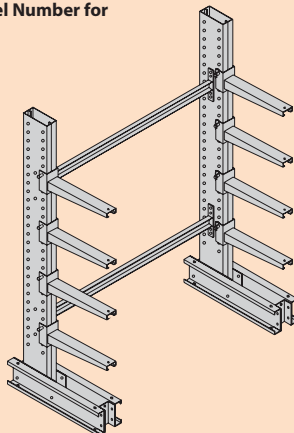

**SU8**  
STARTER UNIT

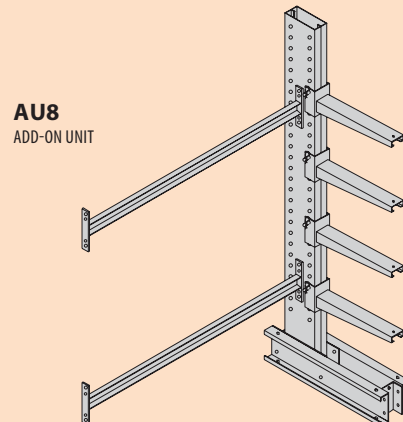

**AU8**  
ADD-ON UNIT



# CANTILEVER RACK ACCESSORIES and HEAVYWEIGHT STRUCTURAL CANTILEVER RACK

Lip extends 2" above the arm surface

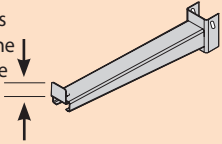

## Bolt-On Arm Lips

All MECO OMAHA cantilever arms are factory punched to accept a bolt-on lip at any time. Lips can also be removed when they are no longer required. Lips are not intended to bear any portion of the load.

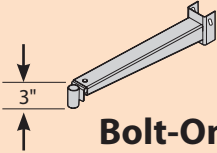

## Bolt-On Pipe Sockets

Pipe sockets can be field installed or removed as needs dictate—just like bolt-on lips. Inside diameter of the socket is 1 3/8". Removable pipe is not included. Pipe sockets are not intended to bear any portion of the load.

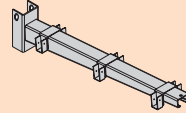

## Drop-In Deck Support Saddles

Add a plywood deck to the cantilever system to store bulky items such as boxes, cartons and furniture. MECO OMAHA will pre-engineer the saddles to accommodate 2x4 cross supports. Saddles must be positioned along the arm to ensure equal distribution of weight. Deck support saddles can also be provided for the bases. Saddles must be fastened to the arms and bases. Field drilling is required. Fasteners are not included. Other saddle styles available. Please inquire.

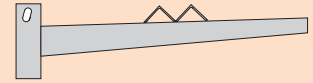

## Welded Axle Cradles

Reels, spools and rolls can be stored between arms with the addition of axle cradles. Axle is not included.

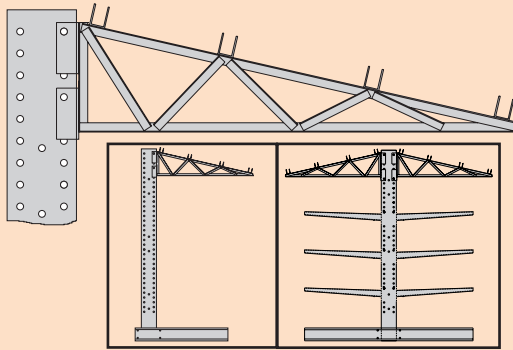

Single Sided Double Sided

## Roof Supports

Turn a cantilever rack system into covered storage with MECO OMAHA roof supports. Can be used as single or double sided roof (depending on length of base used). Purlin clips included. **NOTE:** The use of roof supports can significantly reduce the rack's capacity due to wind and snow loads. MECO OMAHA will custom design the roof supports to conform with local wind and snow load conditions.

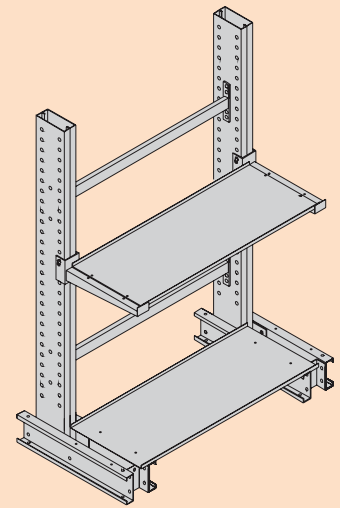

## Steel Decks

MECO OMAHA offers optional steel decks to withstand the harshest industrial environment. Ideal for storage of short lengths of material, dies, castings and other items that require an uninterrupted length of heavy duty decking. Steel angles are welded to the underside of the deck for additional strength. Arms and decks are precision drilled to accept mounting hardware.

STRUCTURAL WIDE FLANGE UPRIGHTS

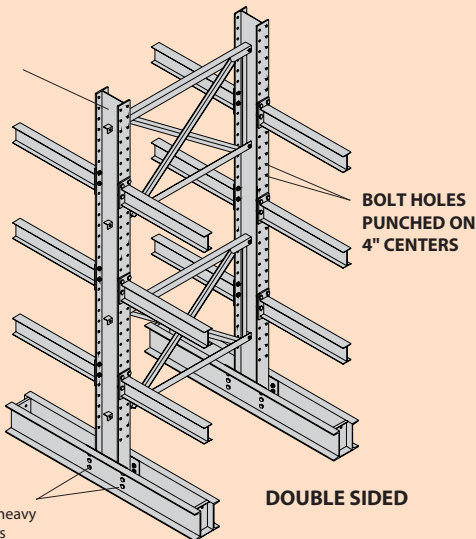

BOLT HOLES PUNCHED ON 4" CENTERS

STRUCTURAL BASE Attached to upright by heavy duty, high strength bolts

DOUBLE SIDED

## Structural Cantilever Rack

Select a MECO OMAHA Structural Cantilever Rack system when your load requirements surpass normal capacities. Uprights are fabricated from rugged structural wide flange beams. Heights are available through 24 feet. Bolt holes are punched on 4" centers the full height of the upright. Both single sided and double sided uprights are available. Structural bases are attached to the uprights by heavy duty, high strength bolts. Load on bases does not affect the total upright capacity.