

## Modern methods of construction

### Building on experience

This guide, prepared by Studio Partington, explores the paradox: if the arguments for houses to be manufactured like cars are so compelling, why is factory-built housing not more common? It investigates notable periods of innovation in house building and looks at elements of design as well as the social and economic influences that drive change. The guide charts the progression of innovation in timber, steel and concrete and considers the benefits and risks associated with different forms of construction.

By interrogating past failures as well as commending high quality design, this guide provides important lessons from history.

The NHBC Foundation, established in 2006, provides high quality research and practical guidance to support the house-building industry as it addresses the challenges of delivering 21st century new homes.

Visit [www.nhbcfoundation.org](http://www.nhbcfoundation.org) to find out more about the NHBC Foundation research programme.

## The NHBC Foundation Expert Panel

The NHBC Foundation's research programme is guided by the following panel of senior representatives from the industry:

### **Rt. Hon. Nick Raynsford**

*Chairman of the NHBC Foundation  
and Expert Panel*

### **Tony Battle**

*Joint Managing Director,  
Kind & Co*

### **Jane Briginshaw**

*Design and Sustainability  
Consultant, Jane Briginshaw  
and Associates*

### **Andrew Burke**

*Development Director,  
The Housing Forum*

### **Richard Cook**

*Group Development Director,  
Clarion Housing Group*

### **Paul Cooper**

*Managing Director,  
Stratfield Homes*

### **Hywel Davies**

*Technical Director,  
Chartered Institution of Building  
Services Engineers (CIBSE)*

### **Andrew Day**

*Head of Sustainability,  
Telford Homes plc*

### **Russell Denness**

*Group Chief Executive,  
Croudace Homes Group*

### **Michael Finn**

*Design and Technical Director,  
Barratt Developments plc*

### **Cliff Fudge**

*Technical Director, H+H UK Ltd*

### **Richard Hill**

*Chief Executive,  
One Housing Group*

### **Robin Nicholson CBE**

*Senior Partner, Cullinan Studio*

### **Tadj Oreszczyn**

*Director,  
The Bartlett School of Environment,  
Energy and Resources*

### **Geoff Pearce**

*Executive Director of Regeneration  
and Development,  
Swan Housing Association*

### **Gwyn Thomas**

*Head of Housing and Policy,  
BRE Trust*

### **Steve Turner**

*Head of Communications,  
Home Builders Federation*

### **Andy von Bradsky**

*Design and Delivery Advisor,  
Ministry of Housing, Communities  
& Local Government*

### **Karl Whiteman**

*Divisional Managing Director,  
Berkeley Homes*

### **Steve Wood**

*Chief Executive, NHBC*

### **Richard Smith**

*Head of Standards, Innovation and  
Research, NHBC, and Secretary to  
the Expert Panel*

# Modern methods of construction

Building on experience

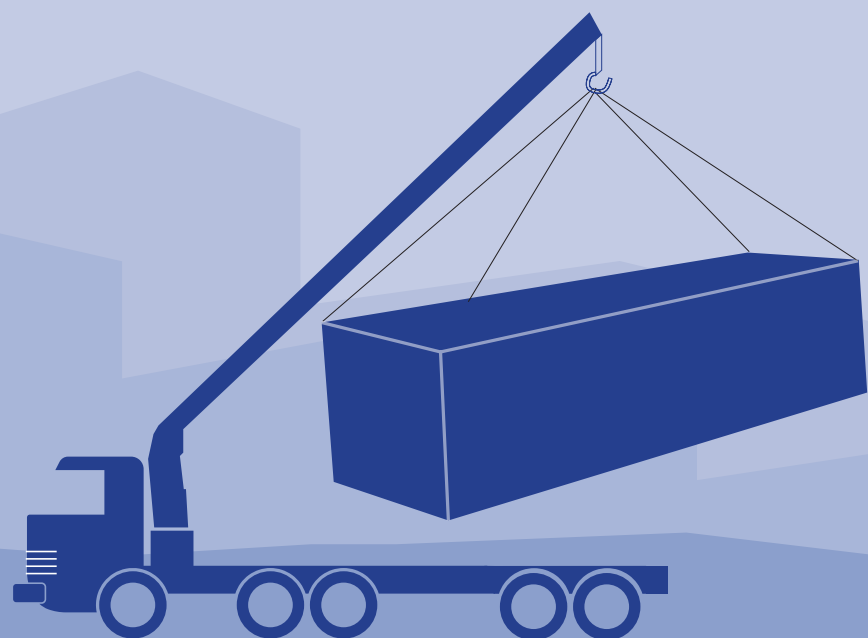

Guide

## Acknowledgements

This guide was researched, designed and written by  
**Suzanne Davenport**, Studio Partington and  
**Richard Partington**, Studio Partington.

NHBC Foundation would like to thank the following people for sharing their time, expertise and insights, and their own research, via interviews and participation in Studio Partington workshops.

**Simon Bayliss**, HTA Design

**Michael Black**, WELink Homes

**Matthew Butcher**, British Precast

**Jonathan Drage**, Metropolitan Workshop

**Jane Hearn**, The Prefab Museum

**Scott Hedges**, Bygghouse

**Josh Tidy**, Letchworth Garden City Heritage Foundation

**Elaine Toogood**, The Concrete Centre

**Sophie Walter**, Letchworth Garden City Heritage Foundation

**NHBC Foundation**

NHBC House

Davy Avenue

Knowlhill

Milton Keynes

MK5 8FP

Tel: 0344 633 1000

Email: [info@nhbcfoundation.org](mailto:info@nhbcfoundation.org)

Web: [www.nhbcfoundation.org](http://www.nhbcfoundation.org)

Twitter: [@nhbcfoundation](https://twitter.com/nhbcfoundation)

# Contents

Foreword	3
Introduction	4
Steel	6
Steel: Introduction	6
Origins: Early 20th century	8
Applications: 1940s and 1950s	10
Innovations: 1990s and 2000s	12
Future: 2020s	14
Steel: Summary	16
Concrete	18
Concrete: Introduction	18
Origins: Early 20th century	20
Applications: 1940s to 1970s	22
Innovations: 1960s to 2000s	24
Future: 2020s	26
Concrete: Summary	28
Timber	30
Timber: Introduction	30
Origins: Early 20th century	32
Applications: 1940s and 1950s	34
Innovations: 2000s	36
Future: 2020s	38
Timber: Summary	40
Conclusion	42
Endnotes	44
Image credits	44
Key sources and further reading	45

1	2	3	4	5
6	7	8	9	
10	11	12	13	

Overleaf:

1. Expanding Metal Co experimental cottage, Cheap Cottages Exhibition, Letchworth, 1905;
2. BISF prefabricated house at Ministry of Works' testing ground, Northolt, London, 1939–1945;
3. Murray Grove, London, 1999, volumetric construction using light steel frame for dense urban housing;
4. Mapleton Crescent, Wandsworth, London, exemplar volumetric housing, 2018;
5. St Hilda's, Leeds, 2018, panellised construction using light steel frame for low-rise family homes;
6. Cubitt's reinforced concrete 'The Roundhouse', Cheap Cottages Exhibition, Letchworth, 1905;
7. Cornish Unit precast houses at Hoo Peninsula, Medway, Kent. Thirty thousand were built 1946–1960s;
8. Brookwood Farm, Woking, 2009 insulating concrete formwork construction traditional looking houses;
9. Garden Halls student accommodation, London, 2017, brick-faced precast concrete façade;
10. Industrialised log building by Christoph & Unmack Company 1907–1940;
11. Swedish-made prefabricated timber houses, at Abbots Langley, Hertfordshire, 1945;
12. Oxley Woods prefabricated timber frame sustainable housing development, Milton Keynes, 2007;
13. Hanham Hall eco village structural insulated panel system (SIPS) construction, Bristol, 2015.





# Foreword

Calls for a system of prefabrication, which would enable us to build houses in the same way as cars and aeroplanes, have been made for nearly a century – often as a response to the extreme need that followed times of social and economic upheaval. As we navigate the COVID-19 crisis and come out of the EU, there is, again, an opportunity to innovate, to build better with homes that use new technology and delivery mechanisms, meet Net Zero Carbon targets, and provide jobs of the future.

Four years since the publication of my *Modernise or Die* review, which highlighted the construction sector's low productivity and declining and ageing workforce, we are at a critical time in the development of Modern Methods of Construction, MMC. The potential benefits of MMC are well rehearsed and compelling, but clearly have not been realised and conventional construction remains dominant in the UK. This guide, then, explores why this may be so, cutting out the rhetoric and focussing on technical developments in an attempt to build on experience and explain why factory-built housing is not more common.

There have been notable periods of innovation in house building and by exploring these historic developments, we can identify elements of high-quality design as well as the social and economic influences that drive change. And it doesn't shy away from interrogating past failures so as to avoid repeating mistakes that still stigmatise the concept of offsite construction.

This guide educates and informs consumers, builders, investors and insurers about MMC. It dispels the abiding image of post-war emergency housing that, despite its reputation, contained some clever engineering and durable

'I have been looking eagerly, ever since I took office, for some system of prefabrication which would enable us to build houses in the same way as cars and aeroplanes. So far my search has been in vain, but I do not despair.'<sup>1</sup>

Aneurin Bevan,  
Minister of State for Health, 1945

details. It also chimes well with the bold ambitions of a new report I have just co-authored, *Build Homes, Build Jobs, Build Innovation*, which calls for a step up in the delivery of a new generation of manufactured homes built responsibly with aesthetic and technical build quality at their heart.

We are able, today, to cherry-pick the best of the previous decades, and, in collaboration with advanced manufacturing methods, can transform the productivity and quality of house building. I hope that this guide can be an enabler to change.

Mark Farmer  
CEO, Cast Consultancy



# Introduction

The promised benefits of non-traditional and offsite construction are well documented: speed of onsite operations; fabrication quality; safer working conditions; material efficiency and reduced waste; and less noise and disruption for residents and neighbours. However, enthusiasm for non-traditional construction has ebbed and flowed, with government support in times of pressing need, followed by a return to traditional methods when housing for private sale has been to the fore.

Aside from a few earlier experiments, there have been three previous periods of serious development of non-traditional techniques:

- 1 After the First World War when there was a serious shortage of skilled labour, essential materials and industrial capacity, since this had all been focused on the war effort.
- 2 The large-scale building campaigns seeking to provide homes after the devastation of the Second World War combined with the government programme to replace slum housing.
- 3 The shift towards industrialised building and high-rise construction during the redevelopment of city centres and house building boom of the 1960s and 1970s.

The damaged reputation of factory-made homes meant that following the 1970s innovation was restricted to particular development types, such as student accommodation, or small-scale prototypes. Today, in a time of housing need, skills shortages, focus on health and safety and advanced technologies transforming the design and manufacture of structures and components, the case for non-traditional housing is again being made.



An exhibition prefabricated house under construction in the grounds of the Tate Gallery, London, 1945, showing the first section being swung into position onto the brick base

# Introduction

This guide does not set out to compete with the extensive social and design histories of non-traditional housing that already exist. However, it does attempt to throw some light on the recurring paradox: if the arguments for houses to be manufactured like cars are so compelling, why is factory-built housing not more common?

In this guide we look at the history of non-traditional housing through a range of different technologies and advancements since the 19th century.

The guide focuses on panellised and volumetric construction in three different materials (steel, concrete and timber) examining the inherent qualities of each material and its suitability for factory fabrication. Each period has been marked by public exhibitions and media interest ranging from the Cheap Cottages Exhibition at Letchworth in 1905 through to the 'Design for Manufacture' (or £60,000 house) of 2005.

There are undeniably successful applications over time and within each material approach when a number of factors have aligned, such as severe housing need, government backing and subsidy, shortages of skilled labour and materials and design expertise. However, with the exception of specific sectors that benefit from standardisation and repetition in design (hotels and student housing for example), all have failed, so far, to be scaled up and challenge mainstream housebuilding.

This guide examines what can be learned from the historic periods of experimentation, application and innovation. We highlight benefits as well as technical considerations in different systems. In some instances a system successfully innovated in certain areas but failed in others. We also chart past building component innovations, which in some cases emerged from non-traditional house designs (see NHBC Foundation report NF85 for further information about technical advances in conventional housebuilding). Standardised and prefabricated elements are now commonplace in modern conventional housebuilding, a profitable and innovating industry far removed from the stereotype of traditional construction (of bricks and mortar and roof timbers cut on site).

We can learn the lessons of the past and do better this time. We must harness technological advances and digitally enabled design and deliver economical and numerous factory-made homes to respond to pressing housing need and the climate crisis. Homes should be better performing, good-looking and long-lasting, be spacious and comfortable for their occupants and enhance neighbourhoods creating a distinctive sense of place.



# Steel: Introduction



Expanding Metal Co. experimental cottage, Cheap Cottages Exhibition, Letchworth, 1905



BISF prefabricated house at Ministry of Works' testing ground, Northolt, London, 1939–1945



Murray Grove, London, 1999, volumetric construction using light steel frame for dense urban housing



St Hilda's, Leeds, 2018, panellised construction using light steel frame for low-rise family homes

**Origins:**  
Early 20th century

Experimental steel framed cottages and wartime galvanised corrugated iron huts

**Applications:**  
1940s and 1950s

Development of many temporary and permanent steel framed houses post-war

**Innovations:**  
1990s and 2000s

Volumetric steel framed construction for stacked student and key worker housing

**Future:**  
2020s

Suitably designed volumetric and panellised systems for low-rise family homes and residential towers

# Steel: Introduction



The Dymaxion House by Buckminster Fuller, 1928–30

Interest in iron and steel as a material for domestic buildings began with the use of galvanised corrugated iron for colonial and wartime huts in the mid 19th century. Despite restrictive byelaws in Britain, there was a need for houses constructed using non-traditional methods and new materials, such as steel structural components. Firstly, the need was to construct at low cost (as in the case of the Letchworth Cheap Cottages Exhibition of 1905)<sup>2</sup> and later (after both wars) it was to overcome shortages of skilled labour and traditional materials.

It was not until just after the First World War that the use of pre-fabrication for housebuilding developed in a significant way in order to alleviate the acute housing shortage. More than 20 steel-framed housing systems were produced, such as the 1920s Telford steel framed house.

After the Second World War there was even greater demand for the rapid construction of new homes. In addition to the need to rebuild homes damaged as a result of the war, the government aimed to provide separate dwellings for every family and to complete slum clearances. Severe shortages of both skilled labour and materials, especially timber, together with a surplus of steel and aluminium, a result of geared up production for the war effort, sparked renewed interest in steel frame construction.

There are inherent challenges in detailing steel-framed homes, for instance, protecting corrosion-prone materials via roof overhangs, flashings and by isolating the construction from the ground to protect the steel frame. Cold bridging was also an issue until details were technically improved to separate the steel frame thermal path from external face to internal leaf. In a modern steel frame design the whole structure is wrapped in insulation and kept on the warm side of the construction. The precision and accuracy that can be applied to steel framing is compatible with factory manufacturing techniques. Light gauge steel – lightweight and galvanised structural frames fabricated from pressed (rather than rolled) cold formed steel sections – offers structural flexibility and material efficiency.

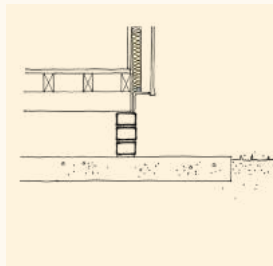

1944: Brick under-building protects metal structure

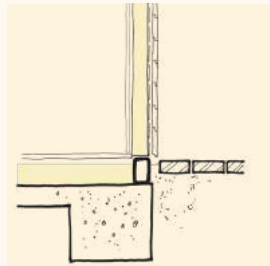

1999: Structure below ground requires additional protection

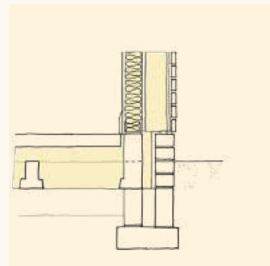

2019: Key interface between panels and ground floor



## Origins: Early 20th century

Steel and iron began to appear in building products once the technique for galvanising became widely available in the mid 19th century.

Early domestic buildings using iron were temporary 'portable' buildings constructed from galvanised corrugated iron, which were exported to the colonies and war zones overseas in large numbers from the 1840s onwards. A most remarkable achievement in 1855 was the completion of Isambard Kingdom Brunel's Crimean War, Renkioi Hospital in Turkey. This 1000-bed, prefabricated hospital was designed, shipped to the Dardanelles and constructed in an incredibly short ten months.

Although Brunel's hospital pavilions were mainly timber there were kitchen and laundry units built entirely of iron frame. The external cladding was also a tin sheet, polished to reflect the heat. Brunel devised a ventilation system that forced fresh air into each ward and made provision for insulation in the event of the buildings being used in winter.

### Features:

- ✓ Lightweight
- ✓ Prefabrication
- ✓ Cottages could be constructed at relatively low cost
- ✓ Demountable huts assembled quickly without scaffolding

### Drivers of demand:

- Overseas colonies and war zones
- Need to build cheap rental cottages for rural workers



British troops constructing Nissen huts, Fricourt, 1916



Maison Tropicale by Jean Prouvé under construction, 1951

### Nissen huts

Wartime need to provide portable shelters for troops and equipment led to a large range of industrially produced hut designs. The famous half-cylindrical Nissen Hut was designed and developed during the First World War and patented in 1916 by Major Nissen of the Royal Engineers. Nissen Huts were widely used in both the First and Second World Wars. Many huts were used as temporary housing after the Second World War.

Nissen Huts came in three sizes: 16ft, 24ft, or 30ft width and any number of 6ft bays long. A 16ft hut could be delivered on a single army lorry and installed by four people in six hours. The modular design of standardised components included a framework of semi-circular steel ribs and two skins of galvanised corrugated sheets.

### Prouvé's steel portal frame

In the 1930s Jean Prouvé refined and patented the now ubiquitous 'axial portal frame'. This two-legged bent steel frame became the basis of Prouvé's demountable houses, designed to house the homeless in France after the Second World War – an early example of mass-produced social housing that could be quickly assembled and immediately inhabited.

Steel, subject to strict quotas at the time, was reserved for the skeleton that could be lifted in place without a crane into which were inserted standardised wooden panels.

Prouvé designed different module sizes and lightweight factory-made cladding. The climate responsive 'Maisons Tropicales' designed for France's African colonies provided external shading, a protecting porch and ridge ventilation.

## Origins: Early 20th century



Letchworth Cottage No. 47 by New Expanded Metal Co. Ltd, 1905. Innovative use of metal lathing as a base for external render and internal plaster finish

### Letchworth Cheap Cottages Exhibition

Letchworth Garden City, Hertfordshire, was home to two experimental housing exhibitions of unique cottages in 1905 and a small estate in 1907. Insufficient rental yields and byelaws that allowed only expensive traditional materials made building for rent prohibitively expensive, leading to a shortage of cottages for rural workers.

'In search of a £150 cottage' (excluding land costs) architects produced innovative designs using new materials that were cheaper to construct. For example, the walls of cottage number 35 by Potter and Company comprised steel lathing bars clipped to either side of 75mm by 75mm steel joists supporting external render and plaster. In today's money £150 would be the same as a build cost of £18,300.

### Silver End Garden Village for Crittall

In 1926 Silver End Model Village, Essex was established by Francis Crittall for his steel window factory workers. The garden village featured open spaces and large gardens, modern houses with indoor bathrooms and hot running water so workers could live and socialise without ever having to leave. Various architects were commissioned to avoid repetitiveness in the house designs, which included flat roofed Modernist style houses.



Silver End, Essex: described as the 'Metal Window Kingdom of Happiness'



### A house with a smile

A house that gives you a welcome from afar—a house you'd like to build for yourself, a house that isn't just "a machine for living in," though it makes full use of every mechanical advantage that modern industry can offer. It is very clearly and agreeably a contemporary house: in and of the 20th century—an elegant and comfortable home. And these smiling, generous windows, upon which so much of its character depends, are

**STEEL WINDOWS—Rustproofed**

1956 Crittall advertisement for rustproofed steel windows

The use of relatively thin steel framed structures for housebuilding was hampered by restrictive Model Byelaws (extended to include rural areas as well as most municipalities in 1901) requiring thick structural walls. However, there was a need to provide houses at a low cost constructed using non-traditional methods.

The 1905 Letchworth Garden City Cheap Cottages Exhibition responded to a shortage of affordable dwellings for rural workers and launched a 20th century trend for model housing exhibitions. The fact that the land in Letchworth was owned by First Garden City Ltd meant that many of the building regulations of the time did not apply, giving architects more leeway. Descriptions are vague and the use of steel varied considerably, but six cottages incorporated steel structural frames, steel reinforcement, steel sheeting and/or steel lathing (bars or mesh) as a base for plaster or render.

The exhibition was a great public success attracting over 60,000 visitors. Some 130 cottages were built, of which 120 are still occupied – a testament to the standard of designs.

In the 1910s Crittall introduced universal profile steel window bars, available worldwide to window manufacturers improving component manufacturing efficiency, followed by standard 'cottage windows' for government housing schemes. Previously not commonly used in residential properties, prefabricated steel windows were used by housing schemes throughout Britain up until the 1980s.

# Applications: 1940s and 1950s

Industry turned to steel and aluminium in the immediate post-war period, as all available timber was diverted to the mining industry for pit propping. Having investigated national re-building programmes abroad, the Burt Committee, established in 1942, recommended prefabrication as the answer to post-war housing needs.

Using both the production and engineering capacity of aircraft manufacturers the 'Emergency Factory Made Homes' and 'Temporary Housing' programme delivered a number of innovative, transportable modular home types. Over 150,000 'prefabs' were designed, produced and erected between 1946 and 1949 across the UK.

In 1944 an exhibition was held at the Tate Gallery to display prefab designs, including AIROH (Aircraft Industries Research Organisation on Housing, which brought together more than a dozen aircraft manufacturers), Arcon (Architectural Consultants), Portal House/Palace and UK100 (also known as American) temporary steel frame bungalows.

## Features:

- ✓ Mass production of prefabricated homes
- ✓ Numerous metal framed house designs
- ✓ 'Volumetric' four-part temporary bungalows

## Drivers of demand:

- Post-war lack of skilled labour and building materials
- Housing shortage due to bombing and slum clearance
- Re-purposed aircraft industry



AIROH prefab, St Fagan's Museum, Cardiff: a forerunner of 'volumetric' construction



British Iron and Steel Federation (BISF) prefabricated house at the Ministry of Works' testing ground, Northolt, London, 1939–1945

### AIROH temporary bungalow

AIROH emerged out of the need to occupy idle factories and use up a stockpile of scrap aluminium from destroyed aircraft in the immediate post-war period. Although expensive at a cost of £1,600 each, the AIROH bungalow was the most manufactured prefab with 69,000 manufactured and distributed across the UK from 1945 to 1948.

The prefabricated aluminium bungalow was delivered on the back of trucks in four individual sections, that were fully fitted out internally, and bolted together into a house. An AIROH was erected in just 41 minutes at Whitehawk, Brighton in November 1946!

The AIROH, comprised of an aluminium alloy steel frame with aluminium sheet cladding, was technically one of the most advanced prefabs. Many outlived their 20-year life expectancy.

### British Iron and Steel Federation (BISF) permanent houses

The BISF house, designed by architect Sir Frederick Gibberd, was successful in numerical terms with 35,000 built across the country from 1944 to 1950, mainly as semi-detached pairs with some terraces. BISF houses were built as permanent homes with a similar expected lifespan to that of a traditional brick-built house.

The homes consciously adopted a modern aesthetic with lightweight vertical, ribbed steel cladding above a rendered metal lathing base.

The frame was bolted together on site.



# Applications: 1940s and 1950s



AIROH prototype house under construction, Tate Gallery, London, 1945



UK100 or American prefabricated house prototype, Tate Gallery, 1945

## AIROH: Ground floor

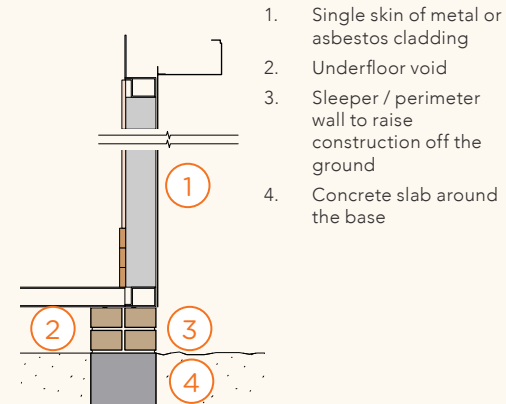

## In detail 1944

- ✓ Raised above ground: protects vulnerable materials and prevents rising damp
- ✓ Concrete 'apron' created around the base: flat, level, prepared surface allowed unit to be positioned and levelled accurately

## AIROH: Technical observations

Like other post-war house designs, the whole house is raised off the ground by a perimeter wall which protects the building materials from water ingress and allows for a void to be created under the building.

The roof creates a substantial overhang which protects the external building fabric and the vulnerable window head.

A small amount of mineral wool insulation was installed in the external wall panel. The approach ramp creates a level threshold and the door is protected by a projecting canopy.

## Innovations: 1990s and 2000s

By the end of the 20th century the scarcity of affordable urban dwellings prompted many housing providers to consider a new typology: compact flats for key workers in the public sector. Manufacturers could provide stacked organisation with repeating units of small floor area through light steel frame 'volumetric' construction. Compact plans were not compromised by transport limitations.

Volumetric units can be brought to site in a variety of forms; ranging from a basic structure only, to units with all internal and external finishes and services installed. Cold-formed light steel framing was widely used in other construction sectors.

Providers who were at the vanguard have not carried on with 'volumetric' construction. Quality, performance and maintenance benefits were not substantial enough to offset increased capital costs. However, panellised light steel structures continue to develop. Panel systems are transported easily and incorporated in hybrid constructions, including vertical infill between concrete frame.

### Features:

- ✓ Light steel frame 'volumetric' construction
- ✓ Repeated plan stacked for structural continuity and efficient services

### Drivers of demand:

- Compact dwellings for key workers
- Egan Report 1998 promoted offsite construction



Murray Grove, London, pioneered steel framed volumetric construction in 1999



Murray Grove level access over thresholds on the garden side



Raines Court, London, 2003 zinc façade

### Murray Grove, London, for Peabody by Cartwright Pickard, 1999

The first of its kind to use steel framed volumetric construction techniques to improve construction quality and radically reduce time on site. Thirty dwellings were created for key workers. Large building modules were fully fitted out in a factory and then assembled on site in just ten days. The units form a 'stacked' load bearing structure with no additional superstructure needed. However, the design of any volumetric module needs to account for the extra stresses caused by handling, transportation and lifting.

Level access over thresholds on the garden side enable ease of use for the widest range of people in line with Lifetime Homes (see 'in detail' overleaf on page 10).

### Raines Court, London, for Peabody by Allford Hall Monaghan Morris, 2003

Another Peabody scheme that pioneered volumetric construction. Unlike Murray Grove, which prioritised level access Lifetime Homes requirements, the units are raised above the ground on an in-situ concrete plinth, therefore the issues of vulnerability at ground floor level are avoided.

The building has retained the quality of its zinc façade and the palette of cladding materials is suitable for the urban environment and the building has weathered well. However, the metal cladding was installed on site, increasing the installation time and leaving modules exposed to the weather during construction.

# Innovations: 1990s and 2000s



Steel framed room modules are manufactured and fully fitted out in a British factory



Murray Grove: the project was on site for just six months

## Light steel volumetric construction: Ground floor

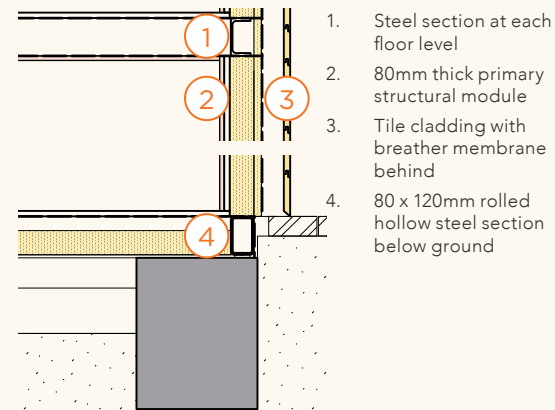

## In detail 1999

! Module floor is flush (or close to) the external ground. Extra precautions are necessary to protect the steel construction

## Light steel volumetric construction: Technical observations

The simplified section detail above illustrates the position of the rectangular section steel framing of the modular unit in relation to the external wall, ground floor and outside ground. A potential cold bridge could occur at the base of the unit, allowing heat to transfer out of the building.

A level threshold is created with this detail; however, the floor structure is positioned below the ground and is unventilated which places the steel material in a potentially vulnerable position.

At Murray Grove and Raines Court the modular units were delivered with internal services and fittings, but external cladding was applied on site.



## Future: 2020s

The early interest in 'volumetric' housing has found new markets in hotels and student housing realising the benefits of repetition and standardisation.

Open sided volumetric structures are now allowing adjacent modules to be stacked side by side to create large rooms and more conventional low-rise family homes. Panellised systems with flexible, standard details and components can be combined with varying amounts of site-applied finishes and fittings. This approach allows for traditional footings and below ground works and has sufficient flexibility, in theory, to deliver homes in varying styles and designs to suit local planning requirements and even consumer 'customisation'.

One particular challenge for the UK offsite industry, is how to reconcile factory production with the expectation that homes will look 'traditional'. Brick construction is not compatible with the requirement for lightness in transport or handling. Natural and synthetic brick tiles are one solution, but their use requires consideration of increased maintenance.

### Features:

- ✓ 'Volumetric' and panellised construction
- ✓ Dense urban housing
- ✓ Low-rise houses
- ✓ Lightweight finishes (brick tiles, metal cladding)

### Drivers of demand:

- Repetitive layout i.e. hotels and student housing
- Improved energy performance
- Farmer Review of UK construction 2016 'modernise or die'



Mapleton Crescent: factory-made modules delivered, stacked and linked



Mapleton Crescent: insulation, cladding and façade applied onsite

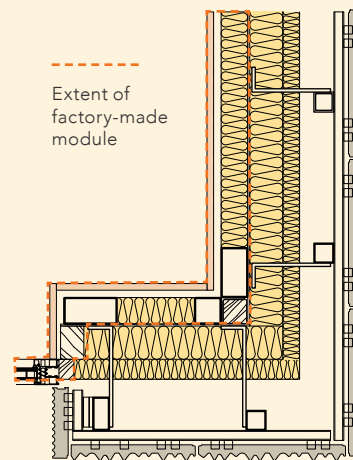

Mapleton Crescent: detail of wall build construction.



St Hilda's, Leeds, 2018: built using a light steel frame panellised system

### Mapleton Crescent, London by Metropolitan Workshop, 2018

This tower of micro-flats in Wandsworth, originally planned for traditional construction and then redesigned to suit volumetric, marries architectural quality and construction efficiency, raising hopes for wider use of modularisation.

Factory-made steel-framed units, each the size of half-a-flat, saved time and helped a tall 27-storey building to be constructed on a small and awkward site bordered by the Southside shopping centre and river Wandle. The 254 modules – that arrived on site complete with plasterboard, paint, windows, doors, wiring, plumbing, bathrooms and tiles – were linked together at a rate of one floor per day, using a special crane mounted to the top of the stair and lift core. By going up almost as soon as they arrive, the modules ease logistics on a tight site with nowhere to keep materials.

Mapleton Crescent succeeds by not aiming to look factory-made. The building has a pleasant slender profile and shifting rhythms of the two wings of accommodation around the stair and lift core. There is a considered relationship to the river and the aqua-green terracotta façade provides a sense of quality and durability.

### Light steel panellised system

The steel frame panels are factory-fitted with lightweight brick tile external cladding. However, they are delivered 'open' on the internal face and internal finishes are installed on site.

# Future: 2020s



Light gauge steel frame open panels, lining materials installed on site



Project Etopia demonstration home, Watford, 2019, uses 'Hyper SIPS' high performing structural insulated panels, which include steel

## Light steel panellised construction: Ground floor

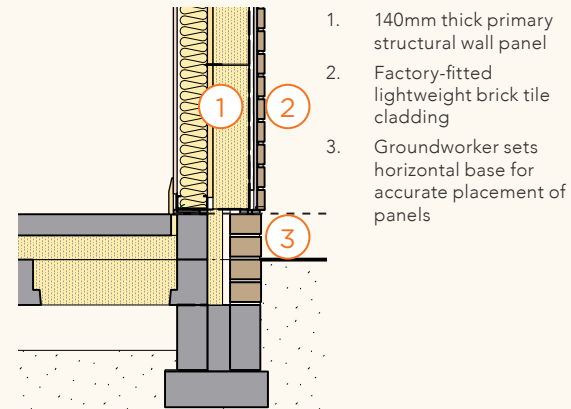

## In detail 2019

- ✓ Panels are delivered 'open' and internal finishes are then applied on site
- ✓ Traditional ground floor and substructure allow steel to be raised above damp proof course (DPC)
- ! Tighter tolerances for groundworks than conventional construction

## Light steel panellised construction: Technical observations

The substructure and suspended ground floor are constructed on site utilising a thermal ground floor, which is comprised of concrete beams with aerated insulating block infill above a ventilated underfloor void. The steel frame wall panel sits on a damp-proof course and is raised up 150mm above the external ground level, like a traditional house, allowing effective waterproofing and protecting the external cladding materials. Insulation continues below the wall panel to avoid a cold bridge at the base.

The steel frame panels are factory-fitted with lightweight brick tile external cladding. However, they are delivered 'open' on the internal face and internal finishes are installed on site.



# Steel: Summary

## Light steel frame benefits:

- ✓ Galvanised cold formed steel sections are widely used in the building industry and are part of a proven technology
- ✓ Modules/panels, comprised mostly of light steel members made from galvanised steel strip of 1 to 3.2mm thickness, are light and easily craned into position on site
- ✓ Light steel members are dimensionally stable and can be accurately cut and joined in a factory achieving a high level of quality often better than traditional construction
- ✓ Steel is the most recycled material in the world. The economic incentive and infrastructure for recycling steel exists, and when steel is recycled it is not downgraded

## Light steel frame technical considerations:

- ! Steel is prone to damage by water and needs to be protected by waterproof membranes and good construction detailing, such as, being raised off the ground, flashings and overhangs
- ! Steel requires fire protection. In volumetric construction the light steel framework is usually protected by fire resistant plasterboard. Cavity fire barriers are also required in the voids created between modules
- ! Steel is thermally highly conductive and requires insulation to prevent 'cold bridges', parts of the construction that allow heat to transfer out of the building
- ! Durability and increased maintenance of lightweight claddings should be considered

The lightweight nature of steel makes for easy transportation which led to the use of steel frame and galvanised corrugated iron sheeting in the earliest examples of prefabricated domestic buildings – the numerous huts shipped overseas from the mid 19th century to Britain's warzones and colonies. Exhibition cottages built at Letchworth in 1905 showed that steel frame and rendered metal lathing could deliver cheaper homes than traditional construction. Following the Second World War the might of the new aircraft industry and surplus of scrap aluminium demonstrated wide-scale prefabrication is possible, with 69,000 AIROH 'volumetric' bungalows rolled out in just three years. This ahead-of-its-time design included a traditionally built plinth raising the steel structure to protect it from corrosion.



Light steel framing was used as a cladding system in the early metal framed houses: there were examples at Letchworth and in the non-traditional post-war designs. Since then, cold formed steel sections, used in a similar way to traditional timber construction, have been widely adopted in many construction sectors. At the turn of the 20th century urban housing schemes pioneered residential use of light steel frame volumetric construction, exploiting the dimensional stability of steel to achieve a level of quality and performance better than traditional construction.

As well as new metal framed housebuilding systems there have been other innovations in building component design, which are now mainstays of conventional house construction. Crittall began manufacturing the first standard prefabricated steel windows in 1919. Widely installed until the 1980s, these steel windows were the precursor of today's factory-manufactured, high performing PVC-U and timber/aluminium double-glazed windows.

However, experiments and periods of development of metal framed housing have been followed by a return to traditional masonry construction. Although non-traditional steel houses of the 1940s to 1960s were not designated defective like a number of concrete designs, the challenges of detailing highly conductive steel construction were poorly understood. The homes were inadequately insulated leading to cold interiors and problems with condensation, damp and corrosion.

Volumetric light steel housing solutions, which resolved earlier construction detailing issues, have not been widely adopted in the housing sector. This is due to the, generally, higher capital cost failing to outweigh the benefits of faster erection and quality control for external finishes. However, the use of volumetric steel systems in hotel buildings, military buildings, health buildings and hospitals is widespread where the cost benefit applies.

# Steel: Summary

	Description	Key materials	Dimensions	Prefabrication/ labour-saving techniques	Building types and heights	Summary
<p>Light steel frame panels</p> 	<p>Prefabricated structural 2D wall/floor/roof panels</p>	<p>Light steel framework (usually 'C' section cold-formed members, made from thin 1-4mm steel strip, galvanised for corrosion protection)</p>	<p>Panel sizes limited by ease of transportation. Back of lorry/shipping container approximately W2.3m x H2.3m x L12m. Sizes also influenced by efficient use of standard (W1.2m x H2.4m) boarding</p>	<p>Can be brought to site in a variety of forms: from basic structure only or structure and external finishes ('open') to all external finishes and conduits installed ('closed')</p>	<p>Low-rise 2 to 3 storey family housing. Typically, 4 to 8 storey buildings, and up to 10 storeys</p>	<p>Light steel frame is a proven technology widely used in the building industry. It is incorporated in hybrid constructions, including vertical infill between concrete frame buildings</p>
<p>Light steel frame volumetric</p> 	<p>Prefabricated structural 3D complete rooms/ open-sided parts of rooms that are combined to make larger spaces</p>	<p>Cold formed light steel framework Hot-rolled (generally hollow) sections may be used at lifting points and corners of the units</p>	<p>Module sizes limited by ease of transportation. Back of lorry/shipping container approximately W2.3m x H2.3m x L12m. W4.3m x L18.3m is possible by road with police notice. Sizes also influenced by standard (W1.2 x H2.4m) boarding</p>	<p>Highly pre-fabricated. Generally brought to site with water-proofed structure and the majority of internal services and finishes installed. External finishes can be either factory- or site-applied.</p>	<p>Typically, 4 to 10 storeys (6 is usually the optimum). Thirty storey towers are possible</p>	<p>Volumetric construction light steel frame 3D modules are lightweight and feasible to transport. Used for hotels and student accommodation, military and prison buildings, health buildings and hospitals</p>
<p>Infill panels and pods</p> 	<p>Prefabricated non-loadbearing 2D infill panels or 3D toilet/bathroom/plant room pods</p>	<p>Cold formed light steel framework, typically less than 100mm width</p>	<p>Sizes influenced by efficient use of standard (W1.2m x H2.4m) boarding</p>	<p>High quality pods, including all walls, ceiling and floor delivered to site fully fitted out including tiling, sanitaryware, mechanical and electrical installations</p>	<p>Not applicable</p>	<p>Speeds up construction and saves coordination of different tradespeople.</p>

# Concrete: Introduction



Cubitt's reinforced concrete 'The Roundhouse', Cheap Cottages Exhibition, Letchworth, 1905

## Origins: Early 20th century

Avant-garde precast concrete systems and site labour-saving formwork systems using waste materials



Cornish Unit precast houses at Hoo Peninsula, Medway, Kent. Thirty thousand built 1946–1960s

## Applications: 1940s to 1970s

Innovative and numerous concrete designs built in large numbers. Some, mostly precast, types inherently defective



Brookwood Farm, Woking, 2009 insulating concrete formwork construction traditional looking houses

## Innovations: 2000s

Learning lessons of past catastrophes and insulating formwork systems used to pioneer energy efficiency improvements



Garden Halls student accommodation, London, 2017, brick-faced precast concrete façade

## Future: 2020s

Precast concrete used as a robust backing allowing durable masonry finishes, not possible with steel and timber systems



# Concrete: Introduction



Auguste Perret, 25 Rue de Franklin, Paris, 1903. Instead of being concealed, the concrete structure (columns, beams, wall panels and floor slabs) is clearly visible on the exterior

The impact of the Industrial Revolution on frame innovation is well documented. Less well known, perhaps, is the experimentation in concrete construction that occurred at the same time. Concrete, in various forms, has been used for house construction since the 1830s. A semi-detached pair of shuttered no fines concrete villas of 1852 were built by Richard Langley at East Cowes, Isle of Wight (listed in 2008). Reinforced concrete was first used in domestic construction by François Coignet in France in 1853 and William Wilkinson in England in 1854. Auguste Perret's apartment building on Rue Franklin in Paris of 1903 expressed its reinforced concrete frame structure on the exterior of the building. Reinforced precast concrete also featured in experimental designs at the 1905 Letchworth Cheap Cottages Exhibition.

European influences, in both design and technology, were evident at the Modern Houses Exhibition of 1934. However, the inter-war period of rapid city expansion was mainly characterised by the traditional looking 'semi' with applied timber framing, tile hanging and sloping roofs. Concrete with its inherent flexibility was used in Laing's 'Easiform' system (2,100 homes built from 1919 to 1928). Mass concrete was used to create the solid external walls of a home.

In a period of greater housing need after the Second World War the Easiform system was developed to create reinforced concrete cavity external walls. The simple reusable metal formwork of Easiform was used to build 100,000 homes from the 1920s to the 1970s. Government subsidies for high- and medium-rise developments brought reinforced concrete, both cast-in-situ and panellised precast, to the fore in the 1960s and 1970s. The highest annual housing construction rate was achieved in 1968 (over 425,000 homes were built).

The Ronan Point collapse in 1968 undermined public confidence in high-rise concrete buildings, ending their construction. In the early 1980s investigations by the BRE (Building Research Establishment) found defects in a number of, mostly precast, house types built in the immediate post-war period. Local authorities compensated owners by either buying back or repairing properties. However, precast concrete construction has continued to be developed for systematic and functional buildings and is today a widely used and well-understood technology.

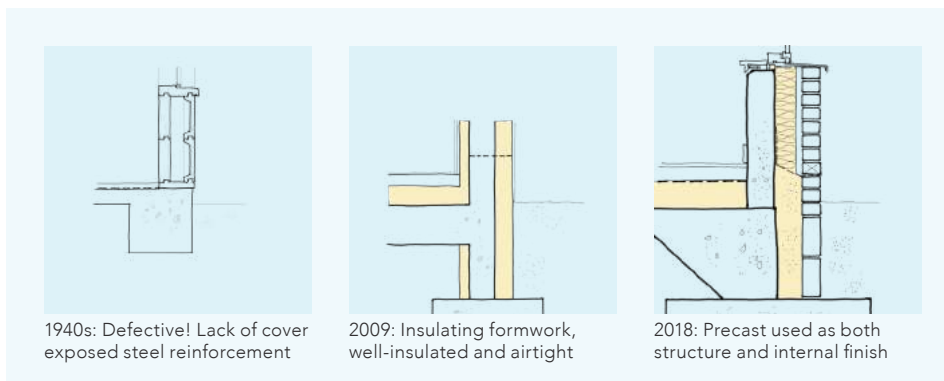

1940s: Defective! Lack of cover exposed steel reinforcement

2009: Insulating formwork, well-insulated and airtight

2018: Precast used as both structure and internal finish

# Origins: Early 20th century

Although there are Roman examples, in modern times the precast concrete process was developed by John Alexander Brodie, chief engineer for the City of Liverpool.

Brodie first designed his prefabricated system to house families in Liverpool displaced through demolition of slum areas. Little information remains but this innovative system was used for tenement apartment blocks. Eldon Street Labourers' Concrete Dwellings (built 1903–5; demolished in 1964) were economically built from precast concrete made using clinker from the Council's waste furnace as aggregate.<sup>3</sup> They pioneered prefabrication, the use of precast as a building material, concrete dwellings and the concept of mass production.

Brodie exhibited a prefabricated concrete panel house at Letchworth Cheap Cottages Exhibition in 1905. 158 Wilbury Road is a Grade II\* listed building protected 'as one of the earliest completely prefabricated systems in reinforced concrete in existence for domestic buildings'.

## Features:

- ✓ Economical
- ✓ Precast concrete panels can be quickly erected
- ✓ Cast-in-situ concrete systems maximising unskilled labour

## Drivers of demand:

- Need to house poorest families displaced by slum clearance
- Need to build cheap rental cottages for rural workers



Eldon Street Labourers' Concrete Dwellings, Liverpool, 1903–1905



158 Wilbury Road, Letchworth, 1905, Grade II\* listed both for its style and its radical prefabricated reinforced concrete construction

## Letchworth Cheap Cottages Exhibition

Letchworth Garden City, Hertfordshire, was home to two experimental housing exhibitions of unique cottages in 1905 and a small estate in 1907. Insufficient rental yields and byelaws that allowed only expensive traditional materials made building for rent prohibitively expensive, leading to a shortage of cottages for rural workers.

'In search of a £150 cottage' (excluding land costs) architects produced innovative designs using new materials that were cheaper to construct. 4 Cross Street (entry No. 58) by Gilbert Wilson Fraser for The Concrete Machinery Company, Liverpool, was judged best concrete cottage and built with blocks made on site, although the exhibition judges deprecated the use of concrete in imitation of stone.

On Wilbury Road were two revolutionary precast concrete cottages: No. 140 'The Round House' (entry No. 73), was a rationalised concrete panel construction designed by Hesketh and Stokes for Cubitt's (demolished 1987); No. 158 (entry No. 69a) was another pioneer of panel prefabrication and is one of the most significant of the early Letchworth buildings. Designed by John Alexander Brodie, the progressive use of precast concrete slabs was matched by a radical International (modern) style exterior.

4 Cross Street and 158 Wilbury Road both survive largely unaltered and are listed buildings, demonstrating the robustness of their experimental concrete constructions.



# Origins: Early 20th century



Easiform cast-in-situ concrete housing being constructed in 1926



Easiform house exhibited at the British Empire Exhibition in 1924–1925

## Laing Easiform Type 1

From 1919 John Laing and Sons developed homes built by casting concrete on site shuttered with reuseable metal formwork. This method became known as 'Easiform' when it was exhibited at the Wembley British Empire Exhibition in 1924–1925.

The first Easiform homes, of which 2,100 properties were built from 1919 to 1928, were constructed from rendered solid external walls of eight inches thick clinker aggregate concrete. The concrete was cast against standardised and reusable metal formwork, which was prefabricated at the Easiform Depot in Elstree, Hertfordshire. This formwork system reduced the need for skilled labourers. The cast-in-situ process was adaptable allowing for various dwelling types, including bungalows, semi-detached and terraced houses and flats, and different designs of roofs, porches and bay windows.

## Gidea Park Modern Homes Exhibition<sup>4</sup>

The 1934 Modern Homes Exhibition included 64 Heath Drive, by Francis Skinner and Tecton, the pioneering firm of modern architects established by Berthold Lubetkin. 64 Heath Drive was among their first works and is an intelligent design providing optimum levels of privacy and natural light. The house is 'L'-shaped in plan with principal rooms set in a wing facing the garden and large roof terrace.

The construction of the external wall, in a 'modern' architectural style, omitted copings, flashings and damp-proof course, which introduced multiple technical issues ranging from water ingress, cold bridges and staining.



Class E House, Modern Homes Exhibition, 64 Heath Drive, Gidea Park, London, view of the house from the south-west showing the terrace

The pre-First World War Letchworth Cheap Cottages Exhibition launched a 20th century trend for model housing exhibitions. In 1911 at Gidea Park, Romford, East London an exhibition was held showing 159 properties by 100 architects. There were houses designed by influential figures of the later Arts and Crafts Movement.

The subsequent Modern Homes Exhibition at Gidea Park of 1934 promoted architectural innovation and aimed to revive this garden suburb, which had failed to live up to its initial promise in the intervening years. The exhibition included a stand-out contemporary design, by Francis Skinner and Tecton at 64 Heath Drive. This radical contemporary design showcased the house's cast-in-situ reinforced concrete construction. Painted concrete, with marks apparent from the timber shuttering, is left exposed as the exterior finish.

Concrete was a material associated with The Machine Age. In fact, cast-in-situ concrete required extensive onsite carpentry to produce the formwork, depending on skilled tradespeople to achieve a 'factory' aesthetic. However, other cast-in-situ concrete building systems were developed which maximised the use of unskilled labour, for example, Laing Easiform Type I.

# Applications: 1940s to 1970s

Post-Second World War, there was a need for a great deal of new housing. New precast concrete and labour-saving cast-in-situ concrete techniques were adopted, particularly by The Ministry of Defence and local authorities. The re-building programme continued well into the 1960s and 1970s; standardised factory-produced panels were adopted for both low- and high-rise development.

However, precast concrete construction techniques in particular resulted in a large number of defects. There were three major technical considerations that were not fully understood at the time:

- 1 The necessary allowance of a suitable thickness of concrete to protect the internal steel reinforcement from corrosion
- 2 The adverse effects, over time, of various additives used to improve curing time
- 3 The failure of building codes to recognise the vulnerability of panel systems if one panel fails, known as progressive collapse

## Features:

- ✓ Range of precast and in-situ concrete designs
- ✓ Widely adopted by MOD and local authorities
- ! Some house types inherently defective

## Drivers of demand:

- Post-war lack of skilled labour and building materials
- Housing shortage due to bombing and slum clearance



Laing Easiform Type II housing at Gosport, Hampshire, circa 1950



Harold Macmillan, Minister of Housing and Local Government, opens Eastcote Estate houses in Middlesex, 1952. The houses, built by Wimpey, were erected in seven weeks.

## Laing Easiform Type II

John Laing and Sons Ltd continued to use and improve upon their Easiform methods after the Second World War. The system stayed in production until the 1970s; in total 100,000 properties were built. Easiform Type II differ from the early Easiform houses (see previous page for details) having cavity external walls. The outer wall leaf was formed of rendered dense reinforced concrete, while the inner wall leaf used clinker aggregate concrete. Carbonation to the depth of steel reinforcement (meaning the steel is able to corrode) is seen in external walls, particularly in pre-1960 properties.

## Wimpey No-Fines<sup>5</sup>

George Wimpey and Co developed a system of housing using rendered solid wall no-fines concrete and traditional construction methods.

Of all the post-war non-traditional housing systems, Wimpey No-Fines produced the largest number of dwellings. Three hundred thousand were built from the 1940s to 1970s, ranging from bungalows, semi-detached and terraced houses and low-rise blocks of flats up to five storeys. The design included dense reinforced concrete eaves beams and precast concrete lintels above ground floor windows.

Many Easiform and Wimpey No-Fines houses still exist and are generally suitable for mortgages. Their simple forms make them suitable for external wall insulation upgrades.

# Applications: 1940s to 1970s



Workmen constructing the precast concrete frame of an Orlit prefabricated house, circa 1945. Seventeen thousand were built from the 1940s to 1950s. Designated defective!



Cornish Unit precast concrete houses, Hoo Peninsula, Medway, Kent. Thirty thousand bungalows, semi-detached and terraced houses were built from 1946 to the 1960s. Designated defective!

## Orlit: Ground floor

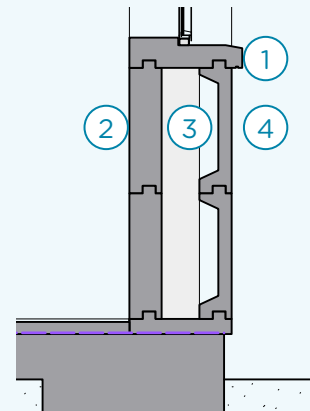

1. Concrete bonding sill spanning from inside to outside
2. Lightweight precast slabs with plasterboard on timber framing finish
3. Precast concrete frame within cavity
4. Precast concrete facing slabs

## In detail 1940s

- ! Precast concrete construction was often compromised by cold-bridges and an absence of appropriate reinforcement cover
- ! Additives to accelerate concrete curing also led to premature failure
- ✓ Many homes have exceeded their life expectancy

## Designated defective house types

In the early 1980s, investigation of fire damage to an Airey house revealed cracking caused by inadequate cover to the reinforcement and chemical changes to the surrounding concrete. Further investigations showed similar defects and potential for failure in other system-built homes. In 1984 the Secretary of State designated particular dwelling types as inherently defective.

The defective types were mainly precast concrete designs including Orlit and Cornish Unit, which were constructed in large numbers (illustrated on this page). Over 28,000 households were aided by Scheme of Assistance operated by local authorities. Most repairs were carried out using systems of reinstatement licensed, inspected and certified by PRC Homes Ltd, a wholly owned subsidiary of NHBC.



# Innovations: 1960s to 2000s

Social housing built in the post-war period is often regarded as aesthetically and technically flawed and, although there is a resurgence of interest in iconic schemes like Park Hill in Sheffield, there has also been widespread demolition and rebuilding of failing estates. The repetitive appearance of off-the-shelf high-rise systems (reflecting a 'factory' aesthetic) has never found popular acceptance in the UK.

However, precast concrete construction has continued to be developed for systematic, functional buildings and as part of standalone and hybrid structures. It is now a widely used and well-understood technology.

There is also growing interest in the renovation of the low-rise housing stock from this period as often well-liked homes near the end of their design life. Existing structures are re-clad and protected from the elements, while being brought up to current environmental standards.

## Features:

- ✓ Large precast concrete panel systems
- ✓ Insulating concrete formwork (ICF) systems
- ! Ronan point progressive (house-of-cards) collapse

## Drivers of demand:

- Lack of public confidence and withdrawal of funding for local authority high-rises
- Return to traditional appearance
- 2016 zero carbon homes target<sup>6</sup>



Ronan Point infamously collapsed in 1968 denting confidence in prefab high-rises



Arena Central, Birmingham, 2019 using up-to-date precast construction



NCH 2050, the UK's first Energiesprong renovation pilot completed in 2018

### Ronan Point by Taylor Woodrow Anglian

In May 1968 there was a gas explosion within Ronan Point, a 22 storey residential block built from large prefabricated concrete sections and completed only two months before. An entire corner of the tower block suffered a progressive collapse, killing four people and injuring seventeen others. A public enquiry concluded the concrete structure was unsound as panels were not sufficiently tied together. Building Regulations were revised in response. This finding seriously undermined public confidence in Modernist prefabricated high-rise buildings of the time, ending their construction. Many similar blocks were demolished in the next 20 years.

### Arena Central, Birmingham

This two block (17 and 22 storeys) residential development utilises precast concrete systems for the building's structural frame, cladding and balcony units. Using a crosswall concrete solution for the main structural frame, benefits to this project included the installation of doors and windows offsite as part of the factory process. This resulted in an impressive speed of construction on a restricted site.

### MFC housing, Nottingham<sup>7</sup>

Nottingham City Homes (NCH) has a large portfolio of 1960s MFC prefabricated concrete terraced homes and two-storey flats. The precast concrete panel structure is extremely robust. However, the upper front and rear external walls of lightweight timber construction with tile or timber cladding is nearing the end of its life after 50 years and homes are now being refurbished to Energiesprong principles.<sup>8</sup>

# Innovations: 1960s to 2000s



Near Passive House cottages, Chewton Mendip, Somerset, 2009 by Arthur Bland



Concrete is poured into the insulating formwork at Chewton Mendip cottages



Hollow blocks of insulating material are stacked to create the mould for structural concrete walls



Brookwood Farm, Woking, 2009: ICF construction with traditional appearance

## Chewton Mendip ICF cottages: Ground floor

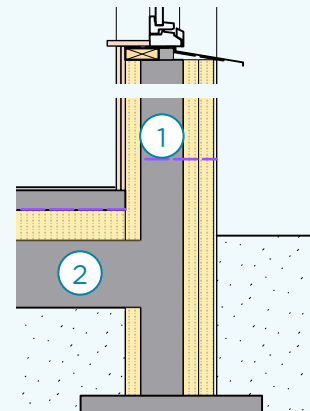

1. Concrete infill between faces of permanent formwork blocks
2. Concrete slab cast-in-situ to form homogeneous structure

## In detail 2009

- ✓ Formwork assembled on site without skilled labour
- ✓ Inherently robust and airtight structure
- ! Site operations and multiple deliveries still required for concrete infill

## Chewton Mendip ICF cottages: Technical observations

External walls were formed out of ICF (insulating concrete formwork) hollow blocks of polystyrene (EPS or XPS) insulation that stack together, creating a mould for concrete to be poured into, and are left in place as the building's thermal insulation wrapping the structural core.

The use of ICF stacked in simple building blocks, like the post-war Easiform formwork system, has the potential to quickly construct very solid, homogeneous house structures without the use of skilled labourers. This easy to monitor system generally provides very well insulated and airtight construction and, used with rendered or adhered finishes, almost no cold bridges. However, although popular abroad (especially in earthquake regions) ICF has had modest uptake in the UK and is mainly used for self-build or one-off houses. The reasons for mainstream housebuilding's lack of interest in ICF are unclear but are perhaps down to the hybrid nature of the system and cost comparisons with ubiquitous light concrete blocks.



## Future: 2020s

Despite the technical issues specific to housing and high-rise applications that arose in the mid 20th century, precast components have been used consistently in the wider construction industry. Through civil engineering and technical applications, the precast industry has continued to evolve and learn from previous failings. The relationship between reinforcement position and longevity is better understood and technical standards regarding additives have developed.

Concrete can be used as a robust 'backing' for heavy weight façade finishes. Panel systems now incorporate multiple layers to include insulation and weather protecting cavities. Designers are increasingly exploiting the potential for concrete to support or integrate masonry and brickwork to provide factory-made façades with durable finishes that answer many of the concerns raised by lightweight rain-screen cladding systems.

### Features:

- ✓ Cross wall construction and insulated panels
- ✓ Systems combine structure and finishes
- ✓ Complicated façade profiles assembled offsite

### Drivers of demand:

- Multi-unit structures such as hotels and student housing
- Constrained urban sites
- Reducing safety risks



Example of precast concrete cross wall construction, a fast and convenient way to produce multi-unit structures



Insulated panels provide a ready-made external envelope with various finishes

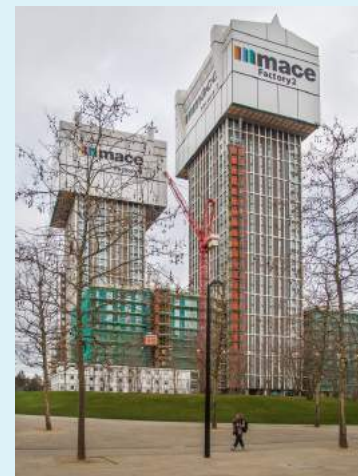

Mace 'Jump Factory', No. 8 East Village, Stratford, London, 2018

### Cross wall construction

A structurally efficient and economical construction technique where precast concrete walls placed in series transfer loads to the foundations. The walls support floors, beams and roofs and also act as shear walls. This technique is typically suited to buildings up to five storeys with the cross walls stacking vertically, however, taller buildings are possible using a hybrid system. The cellular arrangement provides excellent acoustic and fire performance, without relying on additional finishes.

### Insulated precast sandwich panels

Insulated panels, constructed offsite, comprise an outer wall leaf of precast concrete, an insulating layer and an inner wall leaf of plain concrete finished for painting. The wall leaves are connected using low thermal conductivity proprietary plastic ties to eliminate cold bridging. Windows can also be fitted to panels during manufacture. Sandwich panels providing the structure, internal and external finish reducing scaffolding and eliminating wet trades, such as plastering, on site.

### High-rise innovation by Mace

The 'Jump Factory' was pioneered in the UK by Mace at the Olympic Park, Stratford in 2012. A giant marquee was built over the building footprint at No. 8 East Village (482 homes built using precast concrete construction) creating an indoor construction site, improving noise, reducing safety risks and preventing environmental delays. The 'factory' is jumped up as each floor is completed. In 2019 Mace introduced a new evolution, High Rise Solutions (HRS) system, which will be used for the construction of twin residential towers also in Stratford, London.



# Future: 2020s



Hox Park, Egham, Surrey, 2018 by Studio Partington provides 500 student rooms using a prefabricated concrete superstructure, bringing cost, programme, resilience and environment benefits



Garden Halls, Kings Cross, London, 2017, by TP Bennett/Maccreanor Lavington providing 1,200 student rooms and constructed from around 1,100 precast panels incorporating 4 brick types



## Hox Park: Ground floor

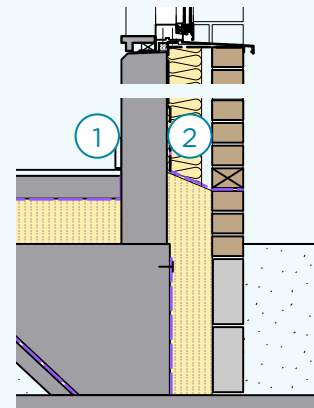

1. Precast concrete wall with painted internal finish
2. Wide cavity with mineral wool insulation

## In detail 2018

- ✓ Precast concrete forms structure and inner leaf of cavity
- ✓ Windows installed before brickwork to create water-tight envelope
- ✓ Traditional external brick details
- ✓ Robust internal finish appropriate for student accommodation

## Hox Park: Technical observations

Precast concrete offsite construction and prefabricated bathroom pods installed throughout allowed the project to be completed on budget and in time for the start of the 2018/2019 academic year. High quality accommodation resulted in almost all of the rooms being reserved upon completion.

Precast construction allowed for accuracy and consistency, vital when constructing a repetitive programme within a restricted timeframe. Concrete walls and floors were meticulously detailed to house all services within the structure, omitting the need for a ceiling void or a complicated floor build up and enabling generous floor to ceiling heights throughout. A fitting canvas for student living, concrete offers effective acoustic barriers between rooms, is easily maintainable and provides durable interiors. Expanses of thermal mass and significant insulation to external walls, maintains a naturally cool environment in the summer, and is warmer in the winter, eschewing the need for additional heating reducing energy costs.

# Concrete: Summary

## Precast concrete benefits:

- ✓ Robust and durable material, which resists weather, when installed with adequate reinforcement cover
- ✓ Capacity to support heavy cladding finishes (brick, stone etc.)
- ✓ Good sound insulation by walls and floors is easily achieved using the inherent mass and damping qualities of concrete. Robust Details provide high performance separating wall and floor constructions that are expected to be sufficiently reliable not to need the pre-completion testing normally required by the Building Regulations
- ✓ In fire, concrete performs well – it has the highest fire resistance classification (class A1) under EN 13501-1:2007- A1:2009. In most cases, concrete does not require any additional fire-protection because it is a non-combustible material

## Precast concrete technical considerations:

- ! Careful thought is needed for the design and construction of panel joints. Standards for joining panels, including faced façade panels, are described in BS8297:2017
- ! Concrete is thermally conductive and generally has to be insulated by a separate external layer of insulation. Thought is needed to avoid cold bridges
- ! Concrete (cast-in-situ or precast) is not readily altered, so particular consideration of future adaptations and flexibility is needed. Typically, knock-out panels and soft spots are incorporated where changes can be anticipated.
- ! Embodied energy is potentially high, but this needs investigation on a 'project by project' basis to establish the cement content and the emissions associated with manufacture and transport.





Throughout the latter half of the 19th century and the early years of the 20th century concrete was trialled for use in domestic construction. Liverpool chief engineer, John Alexander Brodie recognised the potential to build houses quickly and cheaply in concrete using factory production – precasting concrete panels, which could be quickly erected in-situ. Making a further economy, Brodie's Eldon Street labourers' apartments, Liverpool, 1903–5, included a waste clinker as aggregate. The system was also intended for mass production where benefits 'can be most fully obtained'.

After the First World War systems were developed which allowed houses to be constructed from cast-in-situ concrete but maximised the use of unskilled labour. John Laing and Sons developed the Easiform house design from 1919, using metal shuttering fabricated at the Easiform Depot in Elstree, Hertfordshire. Laing developed the Easiform system post-Second World War replacing the earlier mass concrete solid external walls with reinforced concrete cavity walls. Among the many non-traditional housing designs, it was the cast-in-situ concrete designs that were constructed in the greatest numbers (100,000 Easiform Type II and 300,000 Wimpey No-Fines were built up until the 1970s).

The Wimpey system used no-fines concrete, a type of lightweight concrete that can be poured in greater heights and compacts easily. Formwork systems (like Easiform and Wimpey No-Fines) were replaced in the 1970s by light concrete blocks, which are now a mainstay of conventional housebuilding. The concept was continued by the development of ICF (insulating concrete formwork) in the 1970s. Hollow blocks of polystyrene insulation that stack together, creating a mould for concrete to be poured into, and are left in place as the building's thermal insulation wrapping the structural core. However, despite being a simple labour-saving system that has been established for decades and inherently well-insulated and airtight, ICF systems are still in their infancy in the UK.

Despite the Ronan Point collapse in 1968 ending the construction of Modernist prefabricated high- and medium-rise residential developments and the failures that came to light in the early 1980s of post-war concrete house designs, precast continued to be developed for other construction sectors. Reinforcement placement for longevity and the effects of additives are now better understood. Used structurally as efficient cross wall construction, insulated precast sandwich panels and ICF or as non-load-bearing precast cladding, concrete creates a robust backing suitable for the durable and heavyweight brick or stone finishes intrinsic to the UK's housing tradition and expected by occupiers.

# Concrete: Summary

	Description	Key materials	Dimensions	Prefabrication/ labour-saving techniques	Building types and heights	Summary
<p>Cross wall</p> 	<p>Prefabricated structural 2D wall panels, placed in series perpendicular to the lateral axis of the building</p>	<p>Precast concrete walls reinforced over openings. Called 'box frame construction' when combined with precast floors. Façades commonly use precast concrete cladding, including insulated sandwich panels</p>	<p>Panel sizes limited by weight and ease of transportation. Back of lorry/shipping container approx. W2.3m x H2.3 x L12m</p>	<p>Factory-made, precision-engineered, concrete structural components. Bespoke solutions using standard details. Precast cladding provided in a variety of finishes. Power-floated finish can be painted to provide durable interiors</p>	<p>Repetitive multi-unit buildings, with rooms of up to 4 x 9m, and typically up to 5 storeys high. Cross wall structures up to and including 22 storeys have been completed in the UK</p>	<p>Structurally efficient and economical building with good acoustic and fire separation. Walls must stack so only suitable for buildings where all the floors have the same layouts. Used for hotels, student accommodation, and micro apartments</p>
<p>Precast concrete</p> 	<p>Prefabricated structural 2D wall/floor/roof panels</p>	<p>High strength, architectural precast concrete</p>	<p>Varying shapes and sizes. Panel sizes limited by weight (concrete is inherently heavy) and ease of transportation. Back of lorry/shipping container approx. W2.3m x H2.3 x L12m</p>	<p>Standardised prefabricated panels can be fitted together in different configurations. Precast cladding provided in a variety of finishes. Power-floated finish can be painted to provide durable interiors</p>	<p>Houses up to 3 storeys, but there is structural capacity for multiple storeys</p>	<p>Resilient housing system with good fire and flood resistance and thermal and acoustic performance. Lends itself to bespoke, custom-build projects</p>
<p>Large aircrete blocks</p> 	<p>Prefabricated structural 2D wall elements</p>	<p>Storey-height aircrete (lightweight aerated concrete) panels with thin (3mm) joints, using cement-based, quick-set adhesive mortar. Panels can be cut on site to accommodate design details</p>	<p>Manufactured to the design storey height of a house with a width of 600mm and a thickness of 100mm</p>	<p>Familiar traditional house construction using prefabricated components, namely large internal wall leaf blocks. Brickwork/ external finishes, insulation and internal finishes installed on site</p>	<p>Houses up to 2 storeys with room in the roof. Three storeys may also be considered subject to an engineering appraisal</p>	<p>Fast build method. Blocks are joined using Thin-Joint Mortar providing an extremely airtight finish. Combines offsite construction cost benefits with familiarity of masonry</p>
<p>ICF (Insulating concrete formwork)</p> 	<p>2D structural walls made from prefabricated insulating permanent formwork and cast-in-situ concrete</p>	<p>Hollow lightweight blocks made of polystyrene (EPS or XPS) insulation that lock together to provide formwork into which mass concrete is cast-in-situ. Formwork remains in place as thermal insulation, completely wrapping the structure</p>	<p>Various widths. Wider blocks achieve lower U-values/better thermal performance. Identical blocks with tongue and groove edges interlink in a modular grid. The component's normal core is 140mm, thicker cores are available</p>	<p>Standardised range of prefabricated insulating formwork components. Cast-in-situ concrete. The exterior of the building can be clad in any finish and internally is either dry lined or plastered, all installed on site</p>	<p>Houses up to 3 storeys. Flexible system providing many design possibilities. Variety of shapes and components permitting different building forms. Option to incorporate steel reinforcement for basement and multi-storey projects</p>	<p>Quick to assemble. Reduces need for skilled tradespeople (onsite training is required). Excellent insulation and airtightness performance and inherently low level of cold bridging. Fire retardant factory-applied to insulation</p>



# Timber: Introduction



Industrialised log building by Christoph & Unmack Company 1907–1940

**Origins:**  
Early 20th century

Prefabricated huts for shipment to the colonies, mail-order houses and mobile homes for dam workers



Swedish-made prefabricated timber houses at Abbots Langley, Hertfordshire, 1945

**Applications:**  
1940s and 1950s

Imported Swedish prefabs and American and Swedish house factories developed coincidentally with different outcomes



Oxley Woods prefabricated timber frame sustainable housing development, Milton Keynes, 2007

**Innovations:**  
2000s and 2010s

Government-backed, mass factory-produced housing. Pilots suffered from coordination, design and assembly issues



Hanham Hall eco village structural insulated panel system (SIPS) construction, Bristol, 2015

**Future:**  
2020s

Cross-laminated timber and structural insulated panel systems (SIPS). Fire safety concerns for multi-storey construction

# Timber: Introduction



Detail of stained-glass at The Guildhall, Londonderry/Derry (1887) annotated: 'Framed Houses sent from London 1609'. In the 17th century reconstruction of the city was funded by the London Guilds

Timber is perhaps the oldest of all construction materials. In Britain, archaeologists have uncovered timber-framed homes from more than 10,000 years ago. It would be hard to argue that timber construction is 'non-traditional' but the potential for timber frame structures to be prepared or pre-assembled and then transported has long been recognised. A stained-glass window in The Guildhall, Londonderry/Derry (1887) is annotated: 'Framed Houses sent from London 1609'. Other examples include: Henry Manning's Portable Colonial Cottage for Emigrants, Isambard Kingdom Brunel's Renkioi Hospital (see the steel chapter) and Boulton & Paul's (B&P) prefabricated buildings. From 1864 B&P manufactured an extensive range of buildings, described in catalogues, which were sent all over the British Isles and former Empire.

Joining and fixing techniques for timber steadily evolved over centuries and the survival of Elizabethan buildings is a testament to the longevity and durability of native hardwoods. However, timber technology, particularly during the 20th century, evolved to make use of softwoods in prefabricated elements that could be manufactured without labour-intensive traditional jointing. Trussed structures can now achieve long spans with short sections of timber jointed with plate connectors. From the late 17th century, softwoods imported from the Baltic and later North America (countries with greater areas of forests) increasingly replaced indigenous slow-growing hardwoods.

After the Second World War there was a period of materials shortage but from the 1950s onwards the timber industry secured a growing share of the domestic housebuilding market, backed by the development and innovation of the Timber Research and Development Association (TRADA). In the early 1980s a television documentary exposed decay in timber frame new builds, damaging the emerging timber housebuilding industry. The steady re-emergence of timber since then has been stimulated by new manufacturing techniques presenting new opportunities for prefabrication. Glue- or cross-laminated timber, SIPS (structural insulated panel systems) and modular timber frame have come to the fore. However, following the Grenfell Tower fire, there have been renewed concerns about using structural timber at height, even for mid-rise buildings.

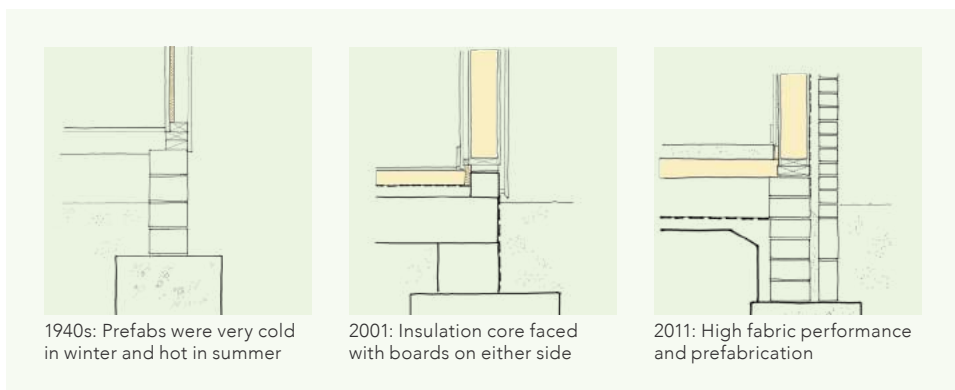

1940s: Prefabs were very cold in winter and hot in summer

2001: Insulation core faced with boards on either side

2011: High fabric performance and prefabrication



# Origins: Early 20th century

Although there are historical examples of timber structures being exported from England, for example the Manning Portable Colonial Cottage, large-scale prefabrication of wooden houses was mainly developed abroad, particularly in the United States and Germany.

Sears Modern Homes were catalogue and kit houses, with more than 400 home types, sold across America primarily through mail order by retailer Sears, Roebuck and Co. Chicago-based Sears sold over 70,000 homes from 1908 to 1940.

In 1907 a sophisticated technical development of log building in Niesky, Saxony, Germany made the Christoph & Unmack Company (C&U) the world's leading producer of prefabricated wooden houses. German modernist architect Konrad Wachsmann was linked with and promoted C&U from 1925, designing the director's house in Niesky in 1929. Through Wachsmann many skills developed at C&U were transferred to North America.

## Features:

- ✓ Ease of shipping and construction
- ✓ Convincingly robust log buildings
- ✓ Precise factory fabrication
- ✓ Temporary mobile houses

## Drivers of demand:

- Basic shelters for New World settlers
- Forested countries with lots of timber
- Virgin territory
- Time-limited accommodation for dam builders

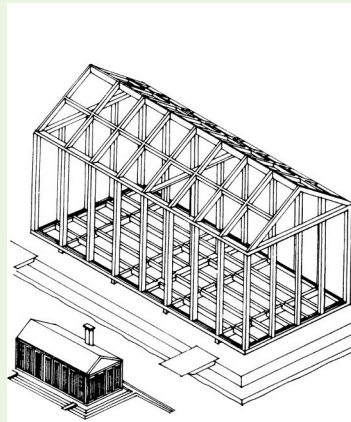

Manning Portable Colonial Cottage for Emigrants 1833–1840

### Manning portable colonial cottage

Henry John Manning, a London carpenter and builder, set out to create a cottage for his son who was emigrating to Australia around 1830. Small, well-made wooden houses, built in sections in England and packed especially for export, protected a few fortunate and prepared settlers. Many others suffered severely from bad weather and theft.

Manning's system offered ease of construction. It was standardised with panels that fitted between grooved posts, as well as floor plates, triangulated roof trusses and wood panel cladding. The entire building could go together without cutting or nails, feasible for unskilled emigrants with limited tools available. Components were easily shipped: 'none of the pieces are heavier than a man or boy could easily carry for several miles'. The cottage proved popular, and was shipped to rapidly expanding British colonies throughout the 19th century.



Christoph & Unmack Assembly Hall, Niesky, Saxony, Germany. Houses were assembled and disassembled before they were sent to their destinations

### Christoph & Unmack log building

C&U produced industrialised log buildings in Niesky, Saxony, Germany from 1907 to 1940. Around 100 dwellings still exist in Niesky.

The commercial success resulted from developing a barrack system to produce substantial houses. The houses were built from precisely prefabricated timber elements with thin walls of only 7cm thick logs plus interior cladding. Logs were connected by both an exact fitting groove and wooden dowels. Rain water was kept from the façade by overhanging roofs and lifting the entrance level by at least 70cm. Foundations were in brick often with granite cladding. Convincingly firm houses were constructed from a low quantity of material, compared to brickwork, and at low cost.



## Origins: Early 20th century



Municipally built terraced houses on Margaretavägen in Enskede, Stockholm, 1910

### Stockholm owner-built small houses

The first garden city in Sweden, Gamla Enskede in Stockholm, was started in 1908. It aped the architectural design of Letchworth and Hampstead Garden Suburb.

A Stockholm innovation was the city's promotion of owner-built 'small houses', or cottages, through land provision, mortgages and practical assistance, recognising that families with low incomes could not afford to live in garden cities. The programme, which started on a trial basis in 1927 in Enskede and Bromma, another suburb set out on garden city principles, developed standardised house types, provided owner-builders with drawings and instruction, and delivered materials cut to size or in prefabricated building components. By 1940 around 4,000 houses had been completed. The houses were mostly built identically in long series and were of solid wood plank construction.



Construction of experimental trailer houses for Tennessee Valley Authority workers in western North Carolina

### Tennessee Valley Authority housing

The TVA oversaw dam building in the Tennessee Valley, an area almost the size of England. New forms of housing were designed for workers to house them near a place of work with no existing community, which also changed location every three to six years as dams were completed.

Starting from the mobile house idea, the TVA produced a prefabricated timber house that required little labour to erect on site. Houses were built in large sections, each of a size that would permit safe transportation by highway. Much of the plumbing, wiring and fixtures were factory-installed and house-sections were also pre-painted. While there was a prefabricated house industry in America before the TVA project, centralised control of housing for a region was not the norm.

The Tennessee Valley Authority (TVA) was set up in 1933. It was one of the earliest of Franklin D. Roosevelt's 'New Deal's, substantial infrastructure projects that received US Government funding in the 1930s. Permanent as well as temporary, portable and demountable houses were factory produced. The design of the permanent houses was based on an interesting concept: they were 'perfectible' – let to workers without internal linings to be finished off and upgraded later. However, it was the TVA's various demountable plywood prefabricated houses that caught the eye of the architectural press and influenced the visiting British Burt Committee.

Wachsmann escaped to America in 1941. There he had a leading role in the massive development of prefabrication that accompanied the Second World War and the years of reconstruction that followed. In partnership with Walter Gropius he developed the Packaged House System and formed the General Panel Corporation.

Like Manning's cottages, The Packaged House System enabled walls and floors to be locked together without screws or nails, with proprietary 'universal joint' connectors. The inventors became so obsessed with perfecting the technology and the dream of a universal system that they lost focus of market changes. The final product was too late to benefit from subsidies through the American Government's post-war building programme.

## Applications: 1940s and 1950s

The Burt Committee, established in 1942, was charged with finding ways of rebuilding Britain's housing stock. A delegation sent to America witnessed the efficiency of 'The Packaged House System' and the Tennessee Valley Authority's modern prefabricated houses for dam workers. They reported back with recommendations to develop prefabricated homes. The Tarran and Uniseco prefabs demonstrated at the Tate exhibition in 1944 used timber frames. However, timber was in short supply. As a result the Government imported a number of Swedish Baltic pine prefabricated homes.

In the 1950s the Timber Development Association (TDA) developed a prototype prefabricated roof truss with toothed plate connectors. TDA trusses were positioned 1.8 to 2.4m apart with traditional rafters and ceiling joists between. As timber technology developed, today's prefabricated roof trusses evolved with the efficient use of small pieces of timber in a composite structure.

### Features:

- ✓ Imported Swedish timber prefabs
- ✓ Universal panels in unlimited configurations
- ✓ Highly automated factory fabrication
- ✓ Precise tolerances

### Drivers of demand:

- Burt Committee's overseas investigations
- Wartime development of prefabrication
- Shortage of timber in the UK



Builders, supervised by Swedish foremen, work to complete the first of six Swedish-made prefabricated timber houses, at Abbots Langley, Hertfordshire, 1945



AB Elementhus factory, Mockfjärd, Dalarna, Sweden, as it appeared in 1952

### Imported Swedish prefab houses

The wartime Burt Committee, the design committee set up in 1942 to investigate the housing shortage, also visited Sweden to view prefabricated timber houses. This resulted in a government programme to import flat packed sectional timber Swedish prefabs to England and Scotland between 1945 and 1946. Swedish homes were distributed in small number to mainly rural areas. Accounts would suggest that around 5,000 prefabs were imported to England and Scotland, fewer than the 30,000 originally authorised. This number was in addition to the approximately 150,000 prefabs erected under the main 1944 Temporary Housing Programme, as the Swedish scheme was administered separately. Though their Norse styling was well liked surprisingly few were actually procured.

The houses are recognisable by their pitched roofs and vertical timber cladding. The timber frame construction sat on a brick underbuilding with concrete foundations and between solid brick party walls supporting masonry chimneys. Storey-height timber framed wall panels were clad internally and externally with vertical timber boarding and included half an inch of fibreboard insulation. The ground floor was suspended timber.

# Applications: 1940s and 1950s

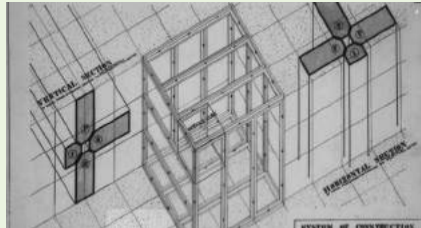

Packaged House System, 1942–1952. Drawing showing interchangeability of panels



AB Elementhus factory: industrialised construction



Elementhus' traditional form disguised its radical method of production

## The Packaged House System

This modular system was developed from 1941 by German émigrés Wachsmann and Gropius. The project was neither fully executed nor an economic success.

The system is known for its ingenious 'universal joint', allowing two-, three- and four- way connections between ten types of panels, used for exterior walls, partitions, floors, ceilings and roofs. The house system is simple and architecturally modest: single storey with a rectangular plan. What is interesting, compared with other room-scale sectional prefabs of the time, is that the system components provided unlimited ways of enclosing space. Houses could be adapted to various site and climatic conditions and to the taste of the owner. Less celebrated is the panel itself. A commercial agreement with Celotex Corporation produced multi-layered plywood panels with an insulating core, which was ahead of its time.

## Elementhus Swedish house factory

At the same time as Gropius and Wachsmann were working in California, Lennart Bergvall and Eric Dahlberg were also attempting to move the production of houses into a factory in Sweden. They invented and patented the Elementhus system, which used timber in elegantly engineered and economical ways. They built a highly automated, expensive factory in Mockfjärd, which began production in 1952. Over the next 25 years it produced approximately 18,000 houses (about 2.75 houses a day). The homes cost less to build and were more economical to operate than standard houses of the time. Many still make up part of the architectural heritage of working-class Swedish towns.<sup>9</sup>

## Elementhus: External wall

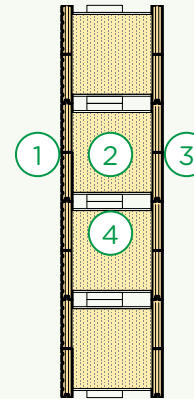

1. Grooved exterior face to prevent surface movement
2. 20 x 20cm plywood box girder
3. Tongue and groove and dowel joints with compressed cardboard strips to achieve airtightness
4. Voids filled with wood shavings and sawdust – by-products of the box girder machining process – automatically collected, blown in and compacted

## In detail 1952

- ✓ Unique fabrication methods
- ✓ Continuous 20 x 20cm hollow beams form both wall and floor panels
- ✓ Void automatically filled with machining by-products providing thermal insulation
- ✓ +/- 0.2mm tolerances

## Elementhus: Technical observations

The key innovation was a hollow plywood 20 x 20cm box beam used both as a structural outer wall or floor, produced by novel machines as a continuous box. Internal walls were built identically but half the width. The voids in the beams used for the outer wall were filled with compressed wood shavings and sawdust providing thermal insulation. These were the by-products of the box beam manufacture that were automatically collected, installed and compacted. The material economy and manufacture of pre-insulated walls was a real departure from anything done before. All surfaces were made of dimensionally stable 20 mm thick cross laminated, three ply spruce panels. The houses were built to extraordinarily precise tolerances, even by today's standards, of +/- 0.2 mm.

The exterior of the panels was grooved to prevent movement and looked similar to Swedish traditional vertical timber cladding. The traditional style of the houses, which also had pitched roofs, disguised their innovative factory production and high performance. This ordinariness led to commercial success but also resulted in the technological advances being largely ignored.



# Innovations: 2000s

The fascination with prefabricated timber has never diminished, particularly in countries where timber remains the first-choice material for domestic construction. Ranging from the sophisticated Swedish Elementhus and German Huf Haus (1960s), to Walter Segal's low-tech self-build homes (1980s).

A 1983 television documentary made by World in Action exposed defects in system-built timber houses. The issues were later found to be caused by poor site practices and not widespread, but the damage to the UK timber-frame housing market was profound. However, timber use in Scotland has always held a strong market share (around 80–90%) and since the mid 1990s the timber industry has been re-establishing itself in the rest of the UK. Details evolved to ensure that gaps behind cladding were maintained and ventilated; to prevent condensation in cold roofs; and to accommodate shrinkage. Most of the Design for Manufacture (2005) pilot sites used timber frame or timber structural insulated panel systems (SIPS).

## Features:

- ✓ Houses could be bought from department stores
- ✓ Mass factory-produced housing
- ✓ Low £60,000 cost
- ! Risk of rot if not adequately protected from water ingress

## Drivers of demand:

- Timber-producing countries
- 1983 documentary exposing timber frame decay
- 2005 Design for Manufacture competition



In the early 1960s Huf Haus sold prefab houses produced in Westerwald directly at the Kaufhof department stores



SIPS (structural insulated panel systems) Kingspan TEK building system



Timber cassette roof at Derwenthorpe sustainable community, York, 2013

## Kingspan TEK building system

This utilises 142 or 172mm thick high-performance structural insulated panels, SIPS, with fibre-free rigid urethane insulation core sandwiched between two layers of oriented strand board (OSB). SIPS are used to construct walls and roofs and intermediate floors, when supported by I-beams or open web joists. U-values of 0.2 and 0.16 W/m<sup>2</sup>K can be improved with additional internal insulation and the proprietary insulated spline jointing system can create a very airtight structure. These features make the system suitable for stringent performance criteria, such as the Passive House Standard.

## Smartroof roof panel system

Pre-insulated, panellised timber cassette for room-in-the-roof designs, which can span up to 5.6m in width. Panels can span gable to gable or eaves to ridge with a timber box girder truss or steel beam at the ridge for wider houses. Where roof panels can span gable to gable, there is no requirement for intrusive internal beams, allowing flexible design and use of the roof space.

Typical panel construction achieves U-values from 0.16 to 0.2 W/m<sup>2</sup>K but better fabric performance can be achieved with thicker construction. The roof cassette includes internal OSB on vapour control layer, timber studs with, typically 200mm thick, insulation quilt and airspace between, breather membrane, factory-fitted counter battens providing 25mm ventilation. Internal plasterboard and skim and external roofing felt, battens and tile covering by follow-on trades.

# Innovations: 2000s



Oxley Woods 145-home sustainable housing development, Milton Keynes, 2007



Oxley Woods panellised timber frame: complete wall panels and floor cassettes

### Design for Manufacture competition

This 2005 government-backed competition challenged consortia of contractors and designers to build homes for £60,000. It stimulated great interest and aimed to revolutionise housebuilding. However, the lessons learned have not been widely implemented.

A review of lessons learned published in 2010 concluded there were coordination, design and assembly issues on all of the pilot sites. Design development overlapped with site operations causing component substitutions, site amendments and unexpected delays. The original concept designs were not followed through during construction processes leading to misinterpretation of environmental objectives and construction details. The interface between traditional trades, the footings and ground slab for instance, led to amendments and site alteration of the prefabricated structures.<sup>10</sup>

### Oxley Woods, Milton Keynes

Oxley Woods stood out as the most radical among the winners of the DfM competition. The 122-home development was constructed from prefabricated timber frames clad with colourful panels. It won the 2008 RIBA Manser Medal 'house of the year' award down to its 'thorough-going attempt at innovation within the all-too risk adverse conventional housebuilders market'.

However, just seven years after completion issues with damp and water ingress were reported. Substantial remedial works included the addition of traditional copings to the vulnerable roof parapets and verges.

### Oxley Woods: External wall/roof

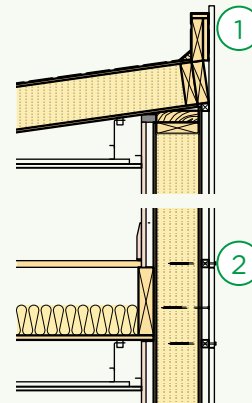

1. Cladding panel projects beyond roof kerb to create a visually clean verge
2. Risk of cold bridges at each panel joint

### In detail 2007

- ✓ Factory-made timber frame panels with recycled paper insulation
- ✓ Low-energy ventilation system with 'eco-hat'
- ✓ Striking modern aesthetic
- ! Eschews traditional details
- ! Copings retrofitted to prevent leaks

### Oxley Woods: Technical observations

The brochure for Oxley Woods says: 'radical thinking was needed to meet the £60,000 construction target' and the delivery team 'started with a blank sheet of paper, setting aside hundreds' of years of housebuilding preconceptions'.<sup>11</sup> When completed the design was lauded for delivering the DfM competition objectives, of producing high quality homes using modern construction technology at competitive costs, and also creating a striking modern aesthetic and addressing environmental concerns.

However, eschewing traditional methods raised the risk of untried methods. In 2014, following resident complaints, reports emerged of widespread damp issues in several homes, with homes suffering from loose/detached cladding, missing damp-proof membranes, rotting timber structure and battens, leaking copings (allowing water ingress into wall cavities) and glazing failures. A report highlighted both poor detailing and poor construction.

# Future: 2020s

The steady re-emergence of timber-based systems has been stimulated by new manufacturing techniques: composites of timber and insulation, SIPS, and large format load bearing panels of cross-laminated timber (CLT) presenting new opportunities for prefabrication. Timber’s potential to lock up or ‘sequester’ carbon dioxide means that it is now being promoted as one of the most environmentally appropriate building materials.

SIPS achieve high levels of airtightness and good insulation, but the panels must be protected adequately from the elements with appropriate detailing. As with most prefabricated systems an inadequate detail is likely to be repeated many times (see NHBC Foundation report NF10, which reported on systemic panel failures in Canada).

Timber frame has also developed increasing panel depth and insulation thickness. Engineered C-studs, made with timber flanges and particle board web, create panels that are conceptually closer to Elementhus than traditional timber frame.

## Features:

- ✓ Custom build homes at scale
- ✓ High performance using conventional timber frame
- ✓ SIPS (structural insulated panel systems)

## Drivers of demand:

- 2007 government eco-towns and carbon challenge
- Deliver quality homes faster with less impact on local residents and the environment



L&G Modular Homes factory in Leeds



Swan’s Beechwood West, Basildon, 2019, first phase includes 30 modular homes



NW Bicester Eco-Town, Oxfordshire, 2015, phase one uses Sigma® II Build System

### Sigma® II build system

Stewart Milne’s Sigma® II build system provides robust and effective wall panels, floor and roof cassettes to achieve high fabric energy efficiency standards. The design uses conventional materials in a more innovative way to reduce thermal bridging and provide built-in airtightness detailing and pre-fitted seals. Panels and cassettes are fully insulated, wrapped and air sealed giving the potential to air test immediately after erection. Windows and doors, fire protection and service penetrations can be factory-fitted.

### Swan NU Build modular housing

Swan Housing Association has taken an innovative approach to building more sustainable, high-quality and affordable homes, faster. In 2017 Swan and in-house development company NU Living opened ‘NU Build’ house factory where cross-laminated timber (CLT) modules are precision engineered, windows and doors are fitted, then kitchens, bathrooms, fixtures and fittings are all installed before the modules are transported to site. However, in order to achieve level access, timber ground floors are installed below ground level creating vulnerability at thresholds. This is a recurring challenge with volumetric construction (see also Murray Grove in the steel section).



# Future: 2020s



Hanham Hall, Bristol. All living spaces face south and have high ceilings and large windows



Hanham Hall deep roof overhangs, balconies and shutters help avoid overheating in summer



Hanham Hall large balconies create connections to the communal gardens and countryside

## Hanham Hall Eco-Village, Bristol

Hanham Hall, 7km from the centre of Bristol by architect-developer team HTA Architects and Barratt Developments, completed in 2015, is one of the Carbon Challenge schemes. The challenge of how to build a zero-carbon house was initiated in 2007 by English Partnerships and administered by the Homes and Communities Agency (now Homes England). The development provides 187 innovative homes for sale and rent, ranging from one-bed apartments to five-bed houses. The aim was not just about meeting codes but also building a sustainable community where people want to build their lives.

The houses meet the former Code for Sustainable Homes (CfSH) Level 5, offsetting all of the energy needed for space heating, hot water, lighting and ventilation (known as 'regulated emissions') on site. BSRIA (Building Services Research and Information Association) assessed the performance of the properties in-use for energy and water consumption for three years, construction quality, indoor environment and collected occupants' opinions on their new homes.

Overall, respondents reported that bills were 'much lower' compared to bills in their previous homes. Carbon dioxide levels monitored in ten sample properties indicated 'good ventilation rates' for all the different design types. Thermal conditions within the sample properties showed 'comfortable temperatures' maintained throughout the year with 'no overheating'.

## Hanham Hall SIPS: Ground floor

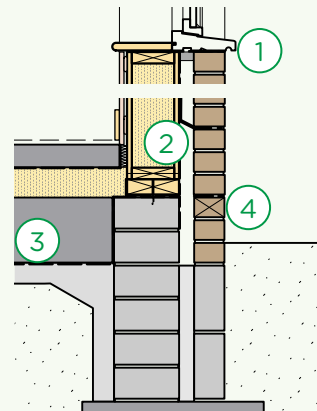

1. Continuous DPC under sill and window board and insulated cavity closer
2. Prefabricated 142mm thick timber SIPS and 50mm cavity
3. Continuous DPM radon barrier
4. Open perpend to ventilate and drain cavity

## In detail 2015

- ✓ 142mm SIPS
- ✓ Traditional ground floor construction
- ✓ Brickwork supported on foundation and restrained by SIPS
- ✓ U-values of 0.2 W/m<sup>2</sup>K can be improved with additional internal insulation

## Hanham Hall SIPS: Technical observations

The houses were constructed using Kingspan TEK building system 142mm thick timber SIPS (see page 33) with glue-laminated timber beams over openings and voids. Single roof panels span the full widths of the houses. The advantages of SIPS are exploited to provide high ceilings in living rooms. The SIPS used also had an integrated cement fibre board, providing a substrate for the final external render finish.

The homes combine stack and cross ventilation, large openings, deep roof overhangs, balconies and shutters to avoid overheating. The extensive external timber shading and balconies to the south facing façades were installed on site.

# Timber: Summary

## Timber frame benefits:

- ✓ Long history of building use – expertise has developed for processing, manufacture and assembly of factory-made components, usually in a ‘closed loop’ environment where all the material is put to use
- ✓ Natural material that is readily replenished and contributes to carbon absorption during growth and storage in completed buildings (known as ‘sequestered’ carbon)
- ✓ Timber can be sourced locally and has potentially low embodied energy
- ✓ Engineered products (beams, roof trusses, wall and floor panels) can use smaller sections or lengths of timber, offcuts and other by-products from processing
- ✓ Established technical resources. Standardised details and design guidance for ‘traditional’ timber frame and hybrid structures

## Timber frame technical considerations:

- ! Fire protection. Limitations on use in tall buildings
- ! Vulnerability to weather especially during construction, exposed panels with no cladding or protection for instance. Ventilation needs to be provided behind cladding and sheet materials
- ! Vulnerability at ground floor. Resolved by following traditional ground floor details
- ! Dimensionally less stable than steel and concrete. Specific construction details are needed to allow for shrinkage and differential movement in timber frame, though not necessarily a problem for composites panels such as CLT





The long history of preparing or pre-assembling and then shipping timber frame is perhaps unsurprising. Timber is lightweight and easy to transport and, as probably the oldest construction material, knowledge of joints and fixings have been developed over centuries.

Forested countries in the Baltic and in North America with a wood economy have driven the development of the uses of softwoods. Christoph & Unmack Company, based in Saxony in Germany, industrialised and developed traditions of log building, pre-assembling houses in huge production halls before disassembling them and shipping houses worldwide. Tennessee Valley Authority set out to design mobile houses to house workers on three- to six-year dam building programmes. Amongst other innovations they pioneered demountable sectional volumetric timber houses, which inspired the British post-war Temporary Housing Programme and prefabs.

Financed by Swedish industry, the Elementhus house factory, which operated from 1952 to 1977, was technically very advanced. A sophisticated and expensive factory was established in Mockfjärd, Sweden with unique, automated processes – a plywood box beam (continuously produced and automatically packed with insulation) was fitted together to form walls and floors. However, Elementhus’ traditional appearance made the radical method of production invisible. Calls to cooperate with architects in the 1950s were ignored and history has largely forgotten this ambitious and successful attempt to industrialise the production of houses.

Softwoods are nowadays bonded or formed into composite components, glue-laminated beams and plywood or particle board panels. SIPS (structural insulated panel systems) combining timber and insulation, and CLT (cross-laminated timber) structural panels present new opportunities for panellised and volumetric prefabrication. As the operational energy required for new houses has reduced with more energy efficient designs, previously overlooked embodied energy is coming into focus. Timber from sustainably managed forests is being specified as a unique material that has the ability to lock up or ‘sequester’ carbon dioxide absorbed while the tree was growing. However, the government’s ban on combustible materials in external walls of more than 18m in height following the Grenfell Tower fire is leading even timber proponents to move away from CLT for apartment buildings.

# Timber: Summary

	Description	Key materials	Dimensions	Prefabrication/ labour-saving techniques	Building types and heights	Summary
<p>Laminated timber</p> 	<p>Prefabricated structural 2D wall/floor/roof panels</p>	<p>Cross-laminated timber (CLT) is manufactured by glueing boards/battens crosswise in several layers. Large master panels are processed into smaller panels with window and door cut-outs</p>	<p>CLT panels up to 320mm thickness. Panels that are small enough to be transported to site. Back of a lorry/ shipping container is approximately W2.3m x H2.3m x L12m</p>	<p>Factory-produced, precision engineered, bespoke structural timber components. Provides an attractive appearance when left exposed internally</p>	<p>Used mainly for low-rise buildings up to six storeys. However, building high-rises in wood is becoming increasingly widespread. An 18-storey tower in Norway is currently the world's tallest timber building</p>	<p>As a renewable material solid timber construction reduces the carbon footprint of the buildings themselves. The use of timber for high-rises is controversial because of fire safety and progressive collapse concerns</p>
<p>SIPS (structural insulated panel systems)</p> 	<p>Prefabricated structural 2D wall/floor/roof panels</p>	<p>Panels consist of a high-performance rigid urethane insulation core sandwiched between two structural facings, typically oriented strand board (OSB)</p>	<p>140mm or 170mm deep panels depending on required thermal performance. Panel width 1.2m and lengths up to 7.5m</p>	<p>Offsite fabrication of bespoke panels. The exterior of the building can be clad in any finish and internally is either dry lined or plastered, all installed on site</p>	<p>Buildings up to four storeys in height</p>	<p>SIPS use less timber than timber frame. They are strong but lightweight making them easier and quicker to assemble on site. Limited cold bridging due to the continuity of the rigid insulation</p>
<p>Timber frame panels</p> 	<p>Prefabricated structural 2D wall/floor/roof panels</p>	<p>Closed timber stud framework panel pre-insulated and air sealed with service cavity and vapour control layer. Optional factory-fitting of external doors and windows and internal linings</p>	<p>Conventional 89mm or 140mm open panel depth. Panel sizes limited by ease of transportation. Back of a lorry/shipping container is approximately W2.3m x H2.3m x L12m. Brick coordinating wall panel heights</p>	<p>High level of prefabrication. Precision-engineered bespoke systems with consistent detailing. Brickwork/ external finishes fitted on site</p>	<p>For many years timber frame houses have been built to a maximum height of three storeys. However, four storeys or more is no longer unusual, and flats are now being constructed up to six or seven storeys across the UK</p>	<p>Consistently high standard. Fabric first 'fit and forget' energy efficiency measures. Timber itself is a natural carbon sink. A typical 4-bed detached home can be erected and made wind and watertight in just five days</p>
<p>Timber frame modules</p> 	<p>Prefabricated structural 3D complete rooms/ open-sided parts of rooms that are combined to make larger spaces</p>	<p>Modules manufactured from standard timber components. Entire module covered in a waterproof membrane</p>	<p>Module sizes limited by ease of transportation. Back of a lorry/ shipping container is approximately W2.3m x H2.3m x L12m. 4.3m wide x 18.3m long is possible by road with police notice</p>	<p>Fully fitted-out prefabricated units complete with bathroom, kitchen, flooring and interior finishes. External finishes fitted on site</p>	<p>Typically achieves the same height as timber frame panels, however, in hybrid construction taller buildings are being developed.</p>	<p>Volumetric technology provides high quality, energy efficient accommodation that can be built faster than if traditional methods were used. Finished structure is also demountable</p>



# Conclusion

All previous periods of development of non-traditional techniques and government stimulated investment have been followed by a return to traditional techniques. There is no single reason for this phenomenon, except that the problem of mass production always applies – make a mistake once and you make it many times. Failure is both ubiquitous and expensive to remedy.

Considerable research and development delivered nearly 450,000 ‘permanent’ non-traditional homes in the decade following the Second World War. However, the ingenuity of new production techniques and speed of construction were offset by reduced longevity and a typically austere look. In practice, the homes did not prove any cheaper to build. When subsidy was withdrawn in 1953 many manufacturers found the housing industry not sufficiently profitable and thereafter non-traditional construction lost ground.

The nearest Britain came to extensive non-traditional housing output was in the 1960s. Government-promoted factory-built housing delivered on quantity providing numerous homes. However, much less emphasis was placed on quality, especially, how housing at scale would respond to the character of specific places and how it would be integrated into the wider urban fabric and infrastructure. Regardless of how homes are built established good practice principles of neighbourhood planning, housing design and construction detailing should be followed. The promise of savings in the initial cost of building offered by prefabrication have also historically not materialised, perhaps as a result of the housing not being built at sufficient scale.

However, as shown in this guide, there were also extraordinary pioneering systems (Renkioi Hospital, Easiform and Wimpey No-Fines, Elementhus, etc.) as well as many redeeming innovations in non-traditional housing of the past. We must learn from these features as well as eliminating the common mistakes in order to do better this time. Promising systems made from light

steel, precast concrete, laminated timber and combinations of insulation and timber or concrete (both precast and cast-in-situ) have all been developed out of the early experiments, wider applications and specific innovations of the last century. The failure of the Packaged House System teaches us that a focus on starting from scratch and production engineering can be a diversion from the established principles of good design and learning lessons of past systems.

Modern methods of construction alone do not guarantee fabrication quality. Design underpins everything and investment in design at the early stages of a project can mitigate the risks of offsite construction. Complete and viable detailed drawings and specification of all components, beyond what is required in conventional construction, is essential before manufacture begins. Although prefabrication reduces time on site, care is still required for site operations that cannot be transferred to a factory. Indeed, where traditional construction interfaces with precise factory-assembled components (at the junction of the external walls and ground floor, for instance) it must be built to tighter tolerances than usual. Quality assurance checks by a third party are key. Checks must take place throughout before products leave the factory, once they are installed on site and on the remaining site operations.

In conclusion, there is no shortcut when commissioning and designing offsite construction systems. Early investment in design, appropriate choice of system and oversight of onsite operations is essential to deliver high-performing, long-lasting and good-looking homes that meet the reasonable expectations of their occupants. If the lessons of the past are learned – basic good practice construction detailing is followed; a standard template is used but homes do not appear monotonous and are responsive to their site; and systems build upon and employ existing prefabricated building components – factory-made homes could help to unlock the UK’s housing crisis and contribute to tackling the climate emergency.

# Conclusion

Important lessons for anyone designing or commissioning offsite construction:

## Investment in design:

- Design should be based on established good practice principles – construction detailing, building physics (heat loss, ventilation, etc.) and town planning – regardless of how homes are to be constructed
- It can be better to standardise components rather than house designs
- Rigorous detailed design, beyond what is required for conventional construction, resolving construction details and specifying all components, known as ‘early design freeze’, is essential before manufacture can commence
- Early investment in research and design may be beyond the reach of small, emerging manufacturers
- A Quality Management System audited by a third party is needed as a minimum

## Choice and design of system:

- Choose the most appropriate construction solution for site constraints (topography, access and context) building shape and planning requirements
- Understand and work with the characteristics and the limitations of different materials and technologies
- Test material assemblies as a complete system (for performance and durability as well as manufacturing operations)
- Prototype and test to investigate performance over wide ranging and seasonal variations (including extreme weather effects of climate change) and for the expected life of products
- Build in realistic tolerances to allow systems to be effectively and efficiently assembled

## Site operations:

- Manufacturer assurances and third-party warranties does not remove the need for site supervision and checks
- Consider sequence of assembly and allow for visual inspection of key construction details. For instance, inspection of safety-critical fire barriers

- in voids between modules needs to be considered at design stage
- Build groundworks and/or podiums to tighter tolerances to readily accept precisely engineered modules or panels

## Suitability of different approaches

There is no modern method of construction or material that is suitable for all sites and all building types. Choices must be made between gradually evolved, tried and tested traditional techniques and numerous innovative systems, taking into account both the general benefits of offsite construction and inherent characteristics depending on the material used. However, it is difficult for those procuring and designing buildings to make objective comparisons because the virtues of one material are often promoted to the exclusion of all others.

The suitability of different construction approaches (panellised, volumetric, traditional etc.) will depend on many factors. However, there are some recognisable affinities between the particular approaches and common site constraints as well as project types or tenures.

Volumetric and to a certain extent panellised approaches are best suited to flat development sites. Particularly with volumetric a large crane is required which needs a stable, level base. If the ground level is sloping retaining walls and tanking will be required, which cannot be constructed out of lightweight (steel and timber) systems, and all of the panels would have to be different shapes, negating the benefits of mass production.

In student housing one of the main pressures on a project is to hand over a completed scheme (with no defects) for the start of academic term deadline. Choosing a volumetric solution can help to de-risk the potential consequences of a site delay. Volumetric construction is very suitable for the repeated room types and high level of internal services. The overlapping of many trades in a small space (most rooms are approx. 14sqm) can be more easily managed in a factory environment.

## Endnotes

1. Minister of Health, Aneurin Bevan, informed an audience in Birmingham. Reported in *Architects' Journal* 102 (1945) p. 253
2. Proposed by John St. Loe Strachey (editor of *The Spectator* newspaper 1887–1925), the 1905 Cheap Cottages Exhibition aimed to provide homes that could be rented for amounts agricultural workers could afford, while gaining publicity for the nascent first garden city.
3. Clinker is the stony residue from burned coal or from a furnace and was used in place of the gravel or crushed brick large aggregate in normal concrete as it was readily available.
4. The 1934 Modern Homes Exhibition at Gidea Park, Romford in the outer London Borough of Havering was notable for its one contemporary design, 64 Heath Drive by Francis Skinner and Tecton. An earlier exhibition in 1911 of 159 properties by 100 architects/establishment of a garden suburb failed to live up to its initial promise for various reasons: the abandonment of the original layouts and the scheme to the east of the golf course; the intervention of the First World War; the construction of Eastern Avenue arterial road in 1926, which cut off the northern part of the proposed development; and the failure to complete the intended shopping centre north of the station, which would have been a valuable focus for the suburb. Gidea Hall, which had been an important element in the design of the first phase, was demolished in 1930, see Gidea Park Conservation Area Appraisal (London Borough of Havering, 2006) p. 16.
5. No-fines is a lightweight type of concrete without sand which does not separate and exerts less pressure when liquid, meaning formwork can be lighter and pour heights greater. It can also be compacted simply by tamping with rods (rather than needing concrete vibrators). These unusual properties reduced the need for skilled labourers.
6. The 2016 Zero Carbon Homes target was abandoned in 2015.
7. 'MFC' or 'MFC Housing' is a non-traditional precast concrete house type by the manufacturers F C Precast Concrete Ltd and W Moss & Sons Ltd, see Harrison, Harry, Mullin, Stephen, Reeves, Barry and Stevens, Alan, *Non-traditional houses: Identifying non-traditional houses in the UK 1918–1975* (Bre Press, 2004) pp. 382–383
8. Nottingham MFC houses are being re-clad externally following the Energiesprong approach. Pioneered in the Netherlands, this upgrades a home with new outside walls and windows, a solar roof, and a state-of-the-art heating system, all in a matter of days while residents stay in place. The ultra-low energy retrofit will prolong the life of these well-liked homes for another 30 years at least. Prefabricated storey-height timber panels are used for the over-cladding. The panels arrive on site complete with insulation, double-glazed windows and a durable board finish.
9. Elementhus demonstrated similar intellectual rigour to the well-documented Packaged House but, backed by Swedish industrial giants, was a commercial success. However, the traditional-looking houses and Bergvall and Dalhberg's calls for cooperation were ignored by other architects. Bergvall retired in 1977 and the story has been forgotten by architectural history.
10. Extensive monitoring by The Homes and Communities Agency (HCA) found coordination, design and assembly issues but also showed an improved safety record and savings on access and speed of completion for all pilot sites. See, Homes and Communities Agency, *Designed for Manufacture: The challenge to build a quality home for £60k*, Lessons Learnt 2, March 2010.
11. Refer to publication: Taylor Wimpey, *Oxley Woods Brochure* [http://www.oxleywoods.com/Oxley\\_Woods\\_Lo\\_Res\\_We\\_1\\_.pdf](http://www.oxleywoods.com/Oxley_Woods_Lo_Res_We_1_.pdf)

## Image credits

- © Studio Partington: front cover, all 'in detail' drawings, pp. 12 bottom, 14 bottom left (a derivative of Metropolitan Workshop detail), 17 bottom and 36 bottom right
- © Garden City Collection (Letchworth City Heritage Foundation): pp. 2 numbers 1 and 6, 6 left, 9 top, 18 left and 20 bottom
- © Historic England Archive: pp. 2 numbers 2 and 7, 4, 6 middle left, 10 bottom, 11 (both images), 18 middle left, 21 top (both images), 22 top and 23 (both images)
- Murray Grove by Cartwright Pickard © Martin Charles: pp. 2 number 3, 6 middle right, 12 top (both images), 13 (both images) and 17 middle
- © Simon Kennedy: pp. 2 number 4 and 14 top right
- © OSCO Homes <https://www.oscohomes.com/>: pp. 2 number 5, 6 right and 14 bottom right
- © William Lacey Group: pp. 2 number 8, 18 middle right and 25 bottom right
- © Thorp Precast: pp. 2 number 9, 18 right and 27 bottom (both images)
- © Photo Deutsches Museum, Munich, Archives, photo number 19305: pp. 2 number 10, 30 left and 32 bottom
- © Ron Ockenden/AP/Shutterstock: pp. 2 number 11, 30 middle left and 34 top
- © Richard Bryant / Arcaid Images / Alamy Stock Photo, Image ID: CZMA2X: pp. 2 number 12, 30 middle right and 37 top
- © HTA Design LLP: pp. 2 number 13, 30 right and 39 (all images)
- © Everett Collection Historical / Alamy Stock Photo, Image ID: CWAPXE: p. 7
- © IWM Q 1402: p. 8 top
- © Architectural Press Archive / RIBA Collections: pp. 8 bottom and 21 bottom
- © 'Silver End, Essex - home of prefab windows!' by Jane Hearn is licensed under CC BY 4.0 / Cropped: p. 9 bottom left
- © M&N / Alamy Stock Photo, Image ID: DYMJTR: p. 9 bottom right
- © 'AIROH prefab. St Fagans National History Museum, Cardiff. 21 April 2017' by Prefab Museum is licensed under CC BY 4.0 / Cropped: p. 10 top
- © Metropolitan Workshop 2017: p. 14 top left
- © WElink Homes 2020: pp. 15 top and 17 top
- © Project Etopia: p. 15 bottom
- © FP Collection / Alamy Stock Photo, Image ID: D49522: p. 19
- © Courtesy of Liverpool Record Office, Liverpool Libraries (352 PSP/111/775/4): p. 20 top
- © Edward Miller / Stringer / Hulton Archive / Getty Images, editorial #: 81107796: p. 22 bottom
- © 'Ronan Point Collapse, Canning Town' by Derek Voller is licensed under CC BY-SA 2.0: p. 24 top left
- © Constructed by Creagh Concrete: p. 24 top right
- © 'Nottingham, UK, first pilot net zero retrofit, Melius Homes, Nottingham City Homes, 2019' by Tracey Whitefoot is licensed under CC BY 2.0: p. 24 bottom
- © Arthur Bland: p. 25 top (both images)
- © BecoWallform: pp. 25 bottom left and 29 bottom
- © FP McCann: pp. 26 top and bottom left and 29 top
- © Mace Group: p. 26 bottom right
- © Tim Crocker: p. 27 top
- © Hexxhome: p. 29 middle top
- © H+H: p. 29 middle bottom
- © 'Stained glass at the Guildhall, Derry/Londonderry' by David G Thomas is licensed under CC BY 4.0 / Cropped: p. 31
- © 'The Manning Portable Colonial Cottage (1833)', <http://quonset-hut.blogspot.com/2012/12/the-manning-portable-colonial-cottage.html>: p. 32 top (both images)
- © Stockholms stadsarkiv, SE/SSA/0566B/Kommunstyrelsen/Stadsfullmäktandlingar Bihang 5 1910, photographer unknown: p. 33 top
- © Library of Congress, Prints & Photographs Division, FSA/OWI Collection, [LC-DIG-fsa-8e09031]: p. 33 bottom
- © ElementhusAB.com under CC by 4.0: p. 34 bottom
- Harvard Art Museums / Busch-Reisinger Museum, Gift of Walter Gropius © Artists Rights Society (ARS), New York, NY, Accession Number: BRGA.97.130, 'Packaged House' System, 1942–1952: Duplicate of BRGA.97.52, Photo: President and Fellows of Harvard College: p. 35 top
- © Nordiska museet 'AB Elementhus i Mockfjärd, Dalarna' by Erik Liljeroth is licensed under CC BY-NC-ND 4.0 / Cropped: p. 35 middle
- Sundahl, Sune / ArkDes: p. 35 bottom
- © HUF HAUS: p. 36 top
- © Kingspan / TEK Building System: pp. 36 bottom left and 41 top middle
- © Andrew Butters / Alamy Stock Photo, Image ID: AA5DRG: pp. 37 bottom and 41 bottom middle
- © Legal & General Modular Homes: pp. 38 top left and 41 bottom
- © Beechwood Village by Pollard Thomas Edwards for Swan / NU Living: p. 38 right
- © Tim Gainey / Alamy Stock Photo, Image ID: JAC90K: p. 38 bottom
- © Kilian O'Sullivan-VIEW / Alamy Stock Photo, Image ID: G1F0AF: p. 41 top



## Key sources and further reading

All websites accessed 18 September 2020

- '107 years Huf Haus', Huf Haus, <https://www.huf-haus.com/en-uk/huf-timeline/>
- '158 Wilbury Road, Letchworth, Hertfordshire', Historic England, <https://historicengland.org.uk/services-skills-education/educational-images/158-wilbury-road-leitchworth-8595>
- '1905 Cheap Cottages Exhibition', Garden City Collection, <http://www.gardencitycollection.com/themes/1905-cheap-cottages-exhibition>
- '201 & 203, York Avenue', Historic England, <https://historicengland.org.uk/listing/the-list/list-entry/1392610>
- '64 Heath Drive', Historic England, <https://historicengland.org.uk/listing/the-list/list-entry/1257402>
- '9, 11, Ellers Lane', Historic England, <https://historicengland.org.uk/listing/the-list/list-entry/1392257>
- AHMM, *Raines Court Information Pack*, [https://www.ahmm.co.uk/assets/lib/2019/09/12/Raines%20Court%202010\\_LR-compressed.pdf](https://www.ahmm.co.uk/assets/lib/2019/09/12/Raines%20Court%202010_LR-compressed.pdf)
- Airey, Jack and Wales, Sir Robin, *Revitalising Key Worker Housing* (London: Policy Exchange, 2019) <https://policyexchange.org.uk/wp-content/uploads/2019/11/Revitalising-Key-Worker-Housing.pdf>
- 'An Easiform House Built for the British Empire Exhibition, Wembley, London', Historic England, <https://historicengland.org.uk/services-skills-education/educational-images/an-easiform-house-built-for-the-british-empire-exhibition-wembley-london-12047>
- 'Boulton & Paul's Prefabricated Buildings', Norfolk Historic Buildings Group, [http://www.nhbg.org.uk/Featured-Building-\(1\).aspx](http://www.nhbg.org.uk/Featured-Building-(1).aspx)
- 'Building Eldon Street Tenements in Liverpool: Pictures from plans to completion', Yo! Liverpool, 10 April 2008, <http://www.yoliverpool.com/forum/showthread.php?151280-Building-Eldon-Street-Tenements-in-Liverpool-Pictures-from-plans-to-completion>
- 'Construction Web Site 2020–2021', University of the West of England, Bristol, <https://fetres.uwe.ac.uk/erbe/web/>
- Cousins, Stephen, 'Landmark home aims to be first to meet BRE's new MMC standard', *RIBA Journal*, 4 October 2019, <https://www.ribaj.com/products/project-etopia-home-set-for-uk-first-mmc-rating-bre-innovation-park-stephen-cousins>
- 'Crosswall', The Concrete Centre, <https://www.concretecentre.com/Building-Solutions/Walls/Crosswall.aspx>
- 'Customised Homes from Swan's NU Living', Offsite Hub, <https://www.offsitehub.co.uk/industry-news/news/customised-homes-from-swans-nu-living/>
- Davies, Colin, *The Prefabricated Home* (London: Reaktion Books, 2005)
- Designed for Manufacture: The challenge to build a quality home for £60k: Lessons Learnt 2 (London: Homes and Communities Agency, 2010)
- Draper, Karel L., 'Wartime Huts', Cambridge Department of Architecture, 2017, <https://www.arct.cam.ac.uk/research/history-theory/building-histories/completed-phd-research-1/wartime-huts>
- 'Easiform Housing, Patchway, Bristol', Historic England, <https://historicengland.org.uk/services-skills-education/educational-images/easiform-housing-patchway-11431>
- 'East Village No. 8', Mace Group, <https://www.macegroup.com/projects/east-village-no8>
- 'Eldon Street, 1964', Streets of Liverpool, 31 May 2010, <https://streetsofliverpool.co.uk/eldon-street-1964/>
- Factory Made Housing – A solution for London?* (London: New London Architecture, 2018) <https://nla.london/insights/factory-made-housing-a-solution-for-london>
- 'Garden Halls', Maccreanor Lavington, <https://www.maccreanorlavington.com/work/detail/garden-halls/>
- Gardiner, Joey, 'Swan Latest Modular Firm to Ditch CLT for High-Rise Apartments', *Building*, 16 January 2020, <https://www.building.co.uk/news/swan-latest-modular-firm-to-ditch-clt-for-high-rise-apartments/5103739.article>
- Gorgolewski, M. T., P. J. Grubb and R. M. Lawson, *SCI P302: Modular Construction using Light Steel Framing: Design of Residential Buildings* (Ascot: The Steel Construction Institute, 2001) [https://www.steelconstruction.info/images/2/2f/SCI\\_P302.pdf](https://www.steelconstruction.info/images/2/2f/SCI_P302.pdf)
- Grimberg, Klaus, 'Konrad Wachsmann was a pioneer in industrial construction and a highly regarded architecture professor in the US', *The German Times*, July 2019, <http://www.german-times.com/konrad-wachsmann-was-a-pioneer-in-industrial-construction-and-a-highly-regarded-architecture-professor-in-the-us/>
- Hall, Thomas, *Stockholm: The Making of a Metropolis* (Abingdon: Routledge, 2009)
- Hannah, Michelle and Nick Hunter, *NF82: Modern methods of construction: Who's doing what?* (Milton Keynes: NHBC Foundation, 2018) <https://www.nhbcfoundation.org/publication/modern-methods-of-construction-whos-doing-what/>
- Harrison, Harry, Stephen Mullin, Barry Reeves and Alan Stevens, *Non-traditional houses: Identifying non-traditional houses in the UK 1918–75* (Watford: BRE Bookshop, 2004)
- Hayhow, David, 'Winters' Tale', 28 August 2011, <https://irp-cdn.multiscreensite.com/cca0d26a/files/uploaded/Chewton%20Mendip%20Review%20by%20David%20Hayhow.pdf>
- Hedges, Scott, 'Elementhus: Sweden's ultra modern & totally forgotten, awesome, factory-built house', A Medium Corporation, <https://medium.com/@scotthedges/elementhus-swedens-ultra-modern-totally-forgotten-awesome-factory-built-house-899d0c96687d>
- Historic England, 'Prefabulous!', Google Arts and Culture, <https://artsandculture.google.com/exhibit/prefabulous-historic-england/IQLyNUChXjFSIA?hl=en-GB>
- 'History', Crittall, <https://www.crittall-windows.co.uk/about/history/>
- 'History of Galvanising', Galvanisers Association, <https://www.galvanizing.org.uk/hot-dip-galvanizing/history-of-galvanizing/>
- 'History of Silver End', Silver End Parish Council, <https://silverendparishcouncil.gov.uk/history-of-silver-end/>
- Hoggett, Peter, *The Arup Journal*, Vol. 16, No. 2, July 1981 (London: Ove Arup Partnership, 1981) [https://www.arup.com/media/arup/files/publications/t/the\\_arup\\_journal\\_issue\\_2\\_1981.pdf](https://www.arup.com/media/arup/files/publications/t/the_arup_journal_issue_2_1981.pdf)
- Imperiale, Alicia, Temple University, 'An American Wartime Dream: The Packaged House System of Konrad Wachsmann and Walter Gropius', 2012 ACSA Fall Conference: OFFSITE, 39–41, <https://www.acsa-arch.org/proceedings/Fall%20Conference%20Proceedings/ACSA.FALL.12/ACSA.FALL.12.8.pdf>
- 'In Suburbia: Cottage exhibitions', Heritage Calling: A Historic England Blog, 25 January 2018, <https://heritagecalling.com/2018/01/25/in-suburbia-cottage-exhibitions/>
- 'Insulating Concrete Formwork (ICF)', The Concrete Centre, <https://www.concretecentre.com/Building-Solutions/Walls/insulating-concrete-formwork.aspx>
- Letchworth Conservation Area: 18 December 2001* (Letchworth Garden City: North Hertfordshire District Council, 2001) [https://www.north-herts.gov.uk/sites/northherts-cms/files/letchworth\\_conservation\\_area\\_appraisal.pdf](https://www.north-herts.gov.uk/sites/northherts-cms/files/letchworth_conservation_area_appraisal.pdf)
- Levitt Bernstein, *Offsite Design Meets Manufacture*, [https://www.levittbernstein.co.uk/site/assets/files/2793/offsite\\_design\\_meets\\_manufacture.pdf](https://www.levittbernstein.co.uk/site/assets/files/2793/offsite_design_meets_manufacture.pdf)
- 'Mapleton Crescent', RIBA, <https://www.architecture.com/awards-and-competitions-landing-page/awards/riba-regional-awards/riba-london-award-winners/2019/mapleton-crescent>
- Mark, Laura, 'What Went Wrong at Oxley Woods?', *Architects' Journal*, 15 May 2014, <https://www.architectsjournal.co.uk/news/what-went-wrong-at-oxley-woods/8662623.article>
- McGuinness, John, University of West London, The use of light-weight steel sections etc. in low status housing in England, <http://131.111.147.69/CHS-Conf/Papers/13.0%20Opp.157-170McGuinness%20formatted%20by%20Yang.pdf>
- Miller, Mervyn, *English Garden Cities: An introduction* (Swindon: English Heritage, 2010) <https://historicengland.org.uk/images-books/publications/english-garden-cities-introduction/english-garden-cities/>
- Modern Methods of Construction: Introducing the MMC definition framework* (London: Ministry of Housing, Communities & Local Government, 2019) [http://www.cast-consultancy.com/wp-content/uploads/2019/03/MMC-I-Pad-base\\_GOVUK-FINAL\\_SECURE.pdf](http://www.cast-consultancy.com/wp-content/uploads/2019/03/MMC-I-Pad-base_GOVUK-FINAL_SECURE.pdf)
- Moore, Rowan, 'Mapleton Crescent: the London high-rise factory-built in Bedfordshire', *The Guardian*, 20 May 2018, <https://www.theguardian.com/artanddesign/2018/may/20/mapleton-crescent-wandsworth-london-high-rise-built-bedfordshire-prefab>
- Morby, Aaron, 'Mace Takes Jump Factory System to Next Level', *Construction Enquirer*, <https://www.constructionenquirer.com/2019/12/05/mace-takes-jump-factory-system-to-next-level/>
- 'Murray Grove', Cartwright Pickard, <https://www.cartwrightpickard.com/housing/murray-grove/>
- 'My Dad Told me About Them: TDA roof', LABC, 18 January 2017, <https://www.labc.co.uk/news/my-dad-told-me-about-them-tda-roof-trusses>
- Nelsson, Richard, 'The Collapse of Ronan Point, 1968 – in pictures', *The Guardian*, 16 May 2018, <https://www.theguardian.com/society/from-the-archive-blog/gallery/2018/may/16/ronan-point-tower-collapse-may-1968>
- Pawley, Martin, 'Konrad Wachsmann: the greatest architect of the twentieth century', *Architects' Journal*, 2 December 1999, <https://www.architectsjournal.co.uk/home/konrad-wachsmann-the-greatest-architect-of-the-twentieth-century/775551.article>
- Peabody Design Guide* (London: Peabody, 2018) [https://www.peabody.org.uk/media/12988/peabody-design-guide\\_complete\\_low-res-web-min.pdf](https://www.peabody.org.uk/media/12988/peabody-design-guide_complete_low-res-web-min.pdf)
- 'Project Etopia completes modular eco home', *PCB Today*, 21 August 2019, <https://www.pcbtoday.co.uk/news/modular-construction-news/project-etopia-modular-eco-home/61968/>
- Ross, Keith, *Non-traditional housing in the UK: A Brief Review* (London: Council of Mortgage Lenders, 2002) <https://nanopdf.com/download/non-traditional-housing-in-the-uk.pdf>
- Sadoux, Stéphane, 'In Praise of Cheapness and Innovation', The International Garden Cities Institute, <https://www.gardencitiesinstitute.com/think-piece/in-praise-of-cheapness-and-innovation>
- Seager, Ashley, 'The Two-Bed Thermal Envelope', *The Guardian*, 16 August 2009, <https://www.theguardian.com/business/2009/aug/16/zero-carbon-housing>
- 'Sewell Nissen Hut', Chiltern Open Air Museum, <https://www.coam.org.uk/museum-buckinghamshire/historic-buildings/sewell-nissen-hut/>
- Sisson, Patrick, 'How Sears Kit Homes Changed Housing: These mail-order dwellings democratized homebuying, one kit at a time', *Curbed*, 16 October 2018, <https://www.curbed.com/2018/10/16/17984616/sears-catalog-home-kit-mail-order-prefab-housing>
- Smith, Adam, 'Gamla Enskede', <https://www.herrse/2015/08/gamla-enskede-sveriges-forstadradsstad/>
- 'St Hildas', Osco Homes, <https://www.oscohomes.com/developments/st-hildas/>
- 'Swan Housing Association – NU Living', *Construction & Civil Engineering*, Issue 158, <https://www.ccemagazine.com/2018/12/13/swan-housing-association-nu-living/>
- Taylor Wimpey and Rogers Stirk Harbour + Partners, *Oxley Woods*, [http://www.oxleywoods.com/Oxley\\_Woods\\_Lo\\_Res\\_We\\_1\\_.pdf](http://www.oxleywoods.com/Oxley_Woods_Lo_Res_We_1_.pdf)
- 'The Manning Portable Colonial Cottage (1833)', Quonset Hut Blog, 10 December 2012, <http://quonset-hut.blogspot.com/2012/12/the-manning-portable-colonial-cottage.html>
- The Paul Drury Partnership, *Gidea Park Conservation Area: Character appraisal and management proposals* (London Borough of Havering) <https://www3.havering.gov.uk/Documents/Planning/Conservation-areas/gidea-park-ca-appraisal.pdf>
- The Prefab Museum Archive, <https://www.prefabmuseum.uk>
- Tomlow, Jos, 'Industrialized log building by the Christoph & Unmack Company in Saxony (1907–1940)', in *Proceedings of the First International Congress on Construction History, Madrid, 20th–24th January 2003*, ed. S. Huerta (Madrid: Instituto Juan de Herrera, 2003) [http://www.sedhc.es/biblioteca/actas/CIHC1\\_186\\_Tomlow%20J.pdf](http://www.sedhc.es/biblioteca/actas/CIHC1_186_Tomlow%20J.pdf)
- Tse, Peter, 'Hanham Hall – BSRIA survey – occupant levels of satisfaction – high', BSRIA, May 2018, <https://www.bsria.com/uk/news/article/hanham-hall-bsria-survey-occupant-levels-of-satisfaction-high/>
- Vale, Brenda, *Prefabs: The History of the UK Temporary Housing Programme* (Abingdon: Routledge, 1995)
- Way, Andrew, 'Benefits of light steel framing', *PCB Today*, 9 May 2019, <https://www.pcbtoday.co.uk/news/planning-construction-news/light-steel-framing/56740/>
- Wimpey No-Fines Concrete', The Concrete Society, <http://www.concrete.org.uk/fingertips-nuggets.asp?cmd=display&id=904>