

MatSci 571: Molecules on Surfaces

Prof. K.W. Hipps
N116B Fulmer Hall
5-3033

hipps@wsu.edu

Spring 2014
www.wsu.edu/~hipps/M571.htm

Molecules on Surfaces

- How we get them there.

Deposition methods for ordered molecular films

Vapor Deposition

Langmuir-Blodgett films

Self-Assembly from Solution and Vapor

- Scanning Probe Microscopy and Spectroscopy

Vapor Deposition

- Basic Vacuum Technology
 - Viscous versus ballistic (molecular) flow.
 - When is the pressure low enough?
 - Deposition methods (vapor sources).
- Types of Adsorption
 - Physisorption and chemisorption
- Nucleation and Growth of Thin Films
 - Frank-van der Merwe (layer-by-layer)
 - Vollmer-Weber (island)
 - Stranski-Krastanov (layer + island)

Viscous versus ballistic flow.

Assume ideal gas: $PV = nRT = NkT$

$P(\text{atm})$, $V(\text{liter})$, $n(\text{moles})$, $R(\text{L-atm/mole-K})$, $T(\text{K})$

$P(\text{Pa})$, $V(\text{m}^3)$, $N(\text{molecules})$, $k(\text{J/molecule-K})$, $T(\text{K})$

$1 \text{ atm} = 1,013 \text{ mbar} = 1.013 \times 10^5 \text{ Pa} = 760 \text{ torr}$

The 'Mean Free Path' (λ) is given by:

$\lambda(P) = kT/[P\pi d^2]$ where all quantities are in mks units

$\lambda_c(p) = 100kT/[0.133 p\pi d^2]$: p in millitorr and λ_c in cm

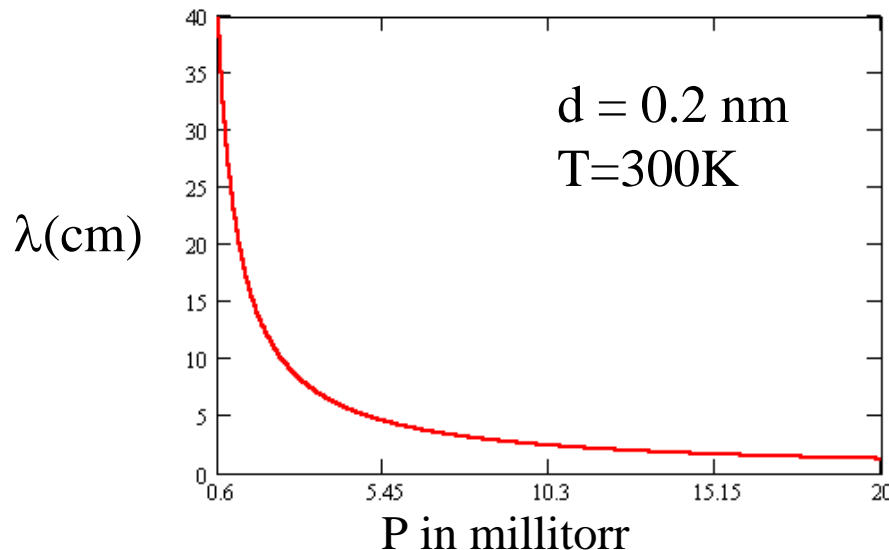

Viscous, Knudsen, and Ballistic Flow

If D is the diameter of a pipe:

- Viscous flow: $\lambda \ll D$

Water in a pipe. The intermolecular interactions are much more important than the interactions with the container.

$$P \geq 50 \text{ milli Torr} = 7 \text{ Pa} = 5 \times 10^{-2} \text{ Torr}$$

- Knudsen Flow $\lambda \approx D$

Intermediate state. About as many intermolecular collisions as collisions with the walls

- Ballistic Flow $\lambda \gg D$

Bullets bouncing off walls. Negligible intermolecular interactions. Primary interactions are with the container.

$$P \leq 0.5 \text{ milli Torr} = 0.07 \text{ Pa} = 5 \times 10^{-4} \text{ Torr}$$

Impingement Rate

- The number of molecules per second striking a unit area is given by:

$$J = \frac{N_A P}{\sqrt{2\pi MRT}} \qquad J_c = \frac{N_A P 10^{-4}}{\sqrt{2\pi MRT}}$$

where J_c is molecules/cm²-s

Since there are roughly 10^{15} atoms/cm² on a typical metal surface, $J_c/10^{15}$ is the frequency with which the entire surface experiences collisions from the gas phase. $10^{15}/J_c$ is the time required for one complete surface encounter.

P (torr)	$10^{15}/J_c(P)$ seconds	$10^{15}/J_c(P)$ hours
10^{-3} (1 millitorr)	2×10^{-3}	---
10^{-5}	0.3	---
10^{-7}	26.	0.007
10^{-9}	2,600	0.73
10^{-10}	26,000	7.3

When is the pressure low enough?

- The number of molecules adsorbing on 1cm^2 solid surface per second will be: $A = S J_c(P)$, where S is the 'sticking coefficient' and $S \leq 1.0$
- For a sticking coefficient of 0.2, we only have about 2 minutes before a surface is completely contaminated at 10^{-7} torr (HV = high vacuum). At 10^{-10} torr (UHV = ultrahigh vacuum), we have about 36 hours!
- In the 10^{-7} pressure range, most of the residual gas is water. In the 10^{-10} range, it is H_2 and CO . For an inert surface (like Au) $S_{\text{H}_2\text{O}/\text{Au}} \ll 1$. Thus, a freshly deposited Au surface might last for an hour or so. For a catalytic surface like Pt, $S_{\text{CO}/\text{Pt}} \approx 0.7$ and we must have UHV **and** freshly cleaned surfaces.

Deposition methods

- Chemical Vapor Deposition (CVD)
- Ion beam and ion beam assisted deposition
- RF and DC sputtering
- Laser ablation deposition
- Electron beam induced deposition
- Thermal deposition
 - Knudsen cell
 - open boats and filaments
 - baffled sources

One form of CVD deposition system

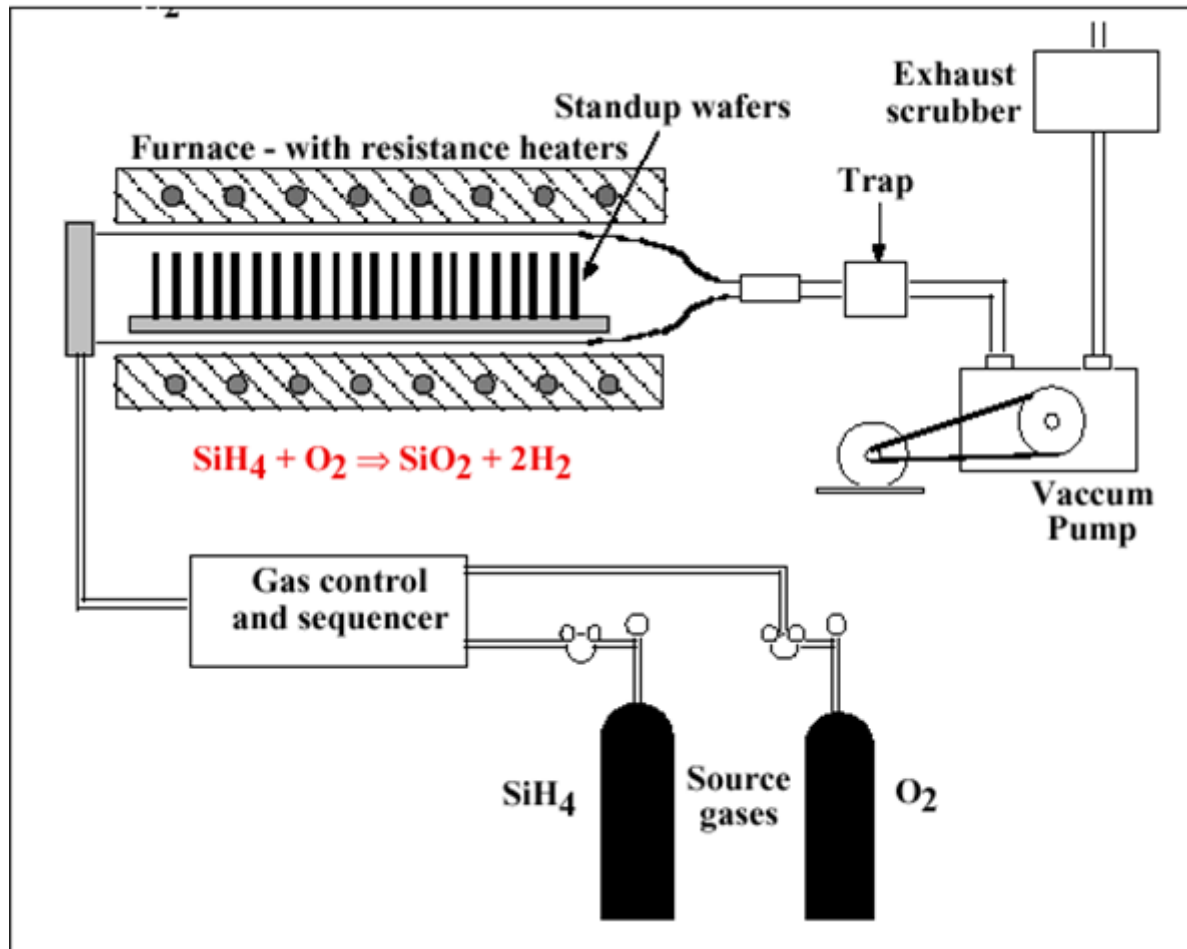

Ion beam deposition modes....

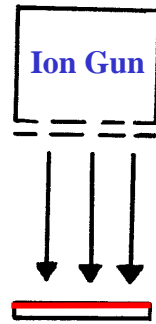

DIRECT ION BEAM DEPOSITION

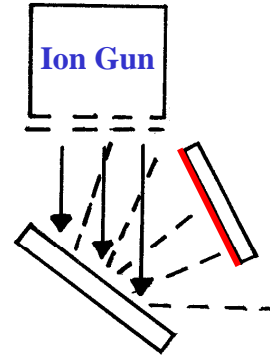

ION BEAM SPUTTER DEPOSITION

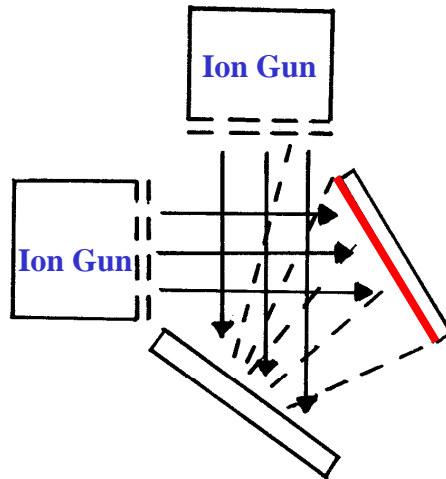

DUAL ION BEAM DEPOSITION

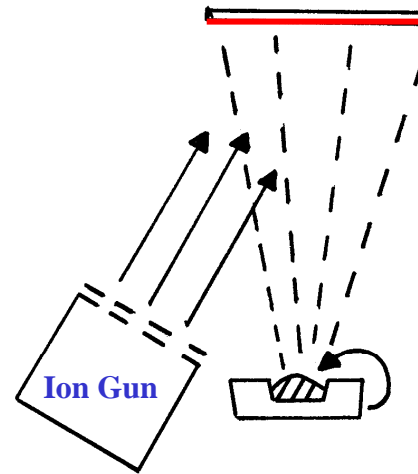

ION BEAM ASSISTED EVAPORATION

e-beam or thermal primary deposition

Electron Beam Heated Evaporation Source

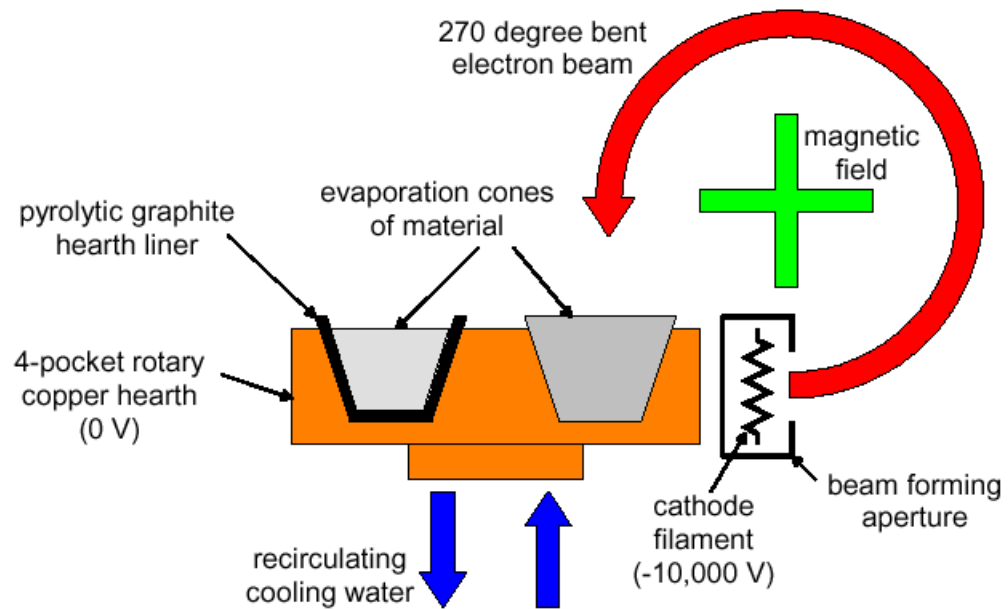

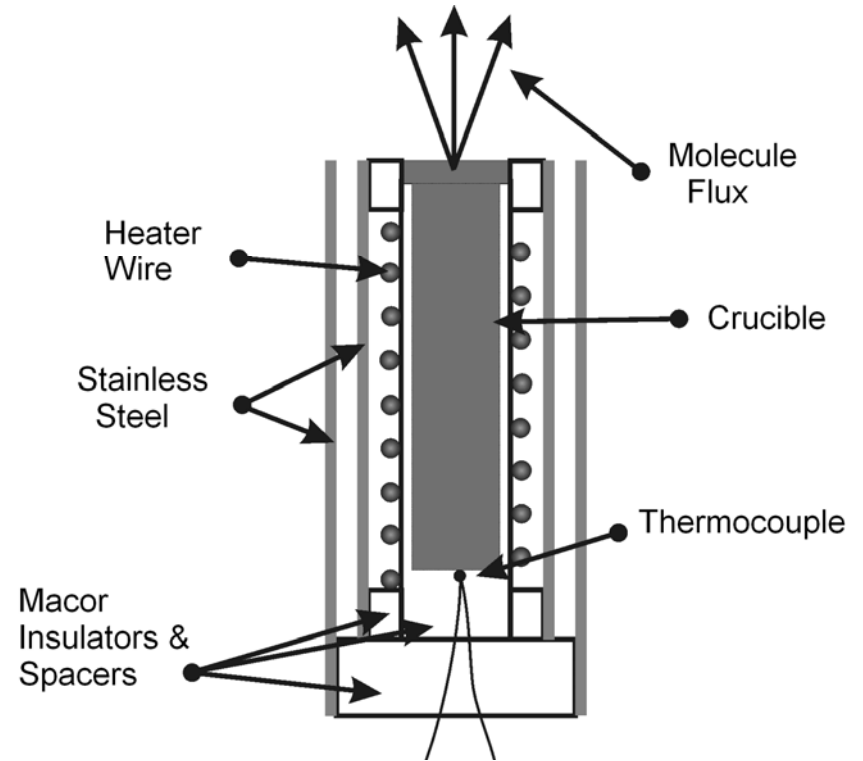
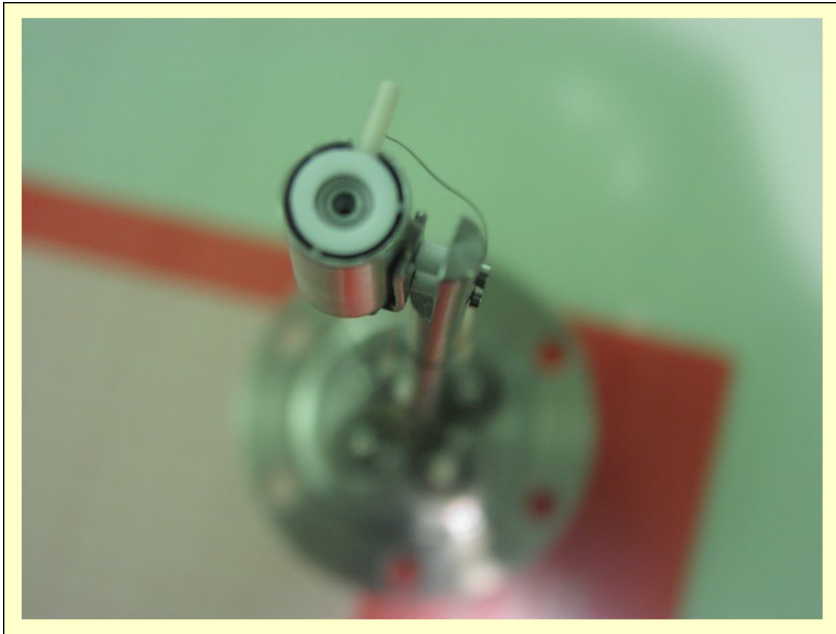

A home made Knudsen Cell for depositing organic molecules designed and built by Marcus Lackinger. Working temperatures to about 800 C.

Resistance Heated Evaporation Sources



wire hairpin



foil dimple boat



wire helix



alumina coated foil dimple boat



foil trough



wire basket



chromium coated tungsten rod

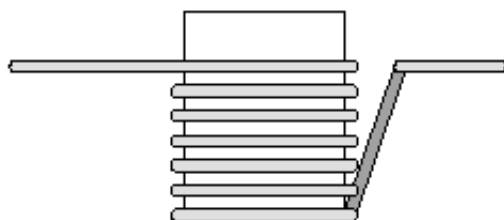

alumina crucible with wire basket

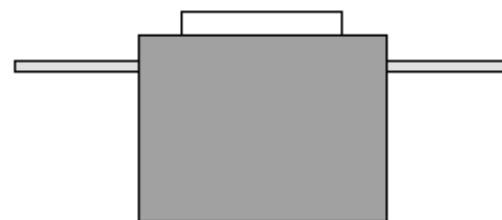

alumina crucible in tantalum box

Baffled Box Source

Compound goes here...

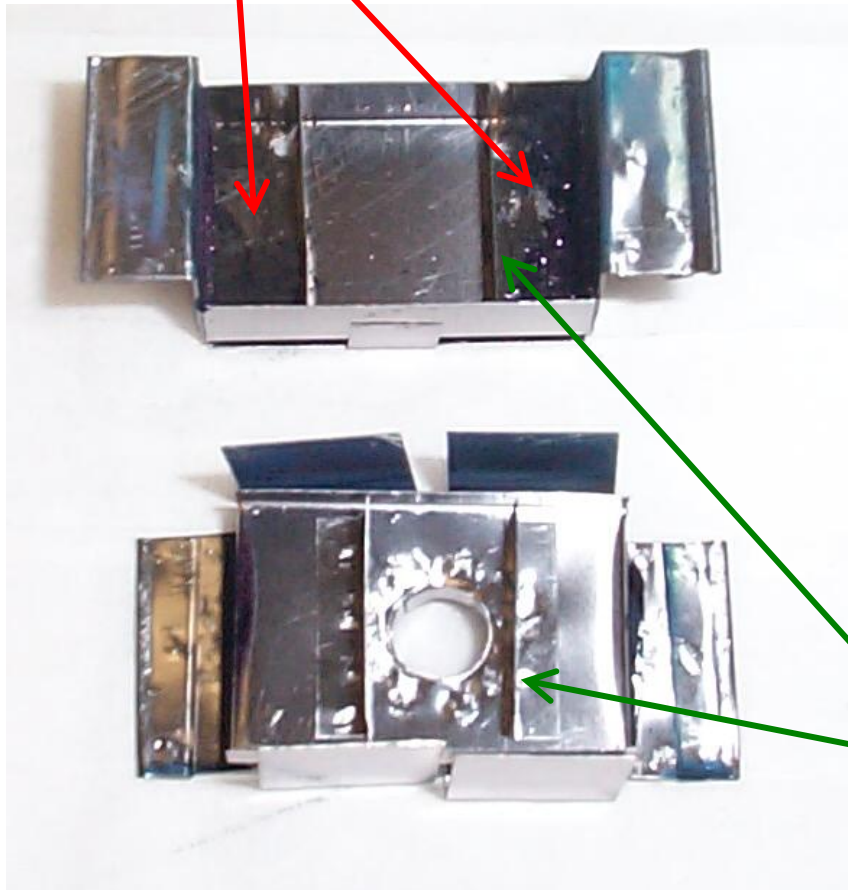

And out through the chimney.

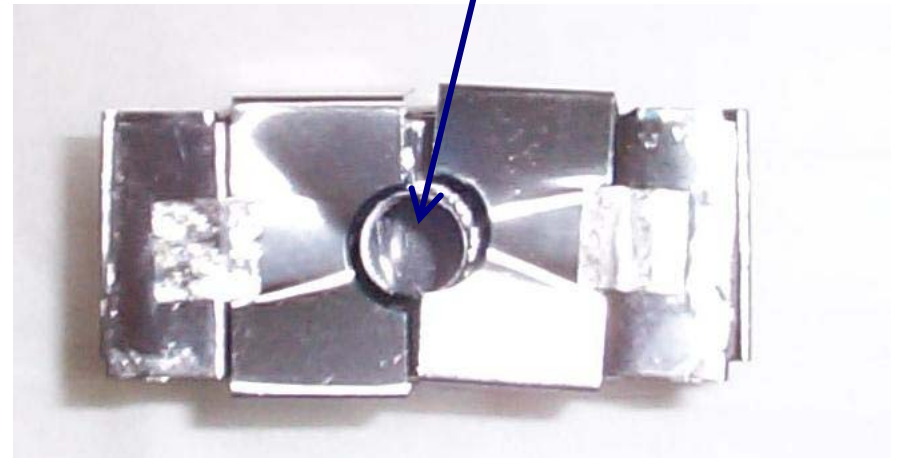

Vapor travels over and around the double baffle...

Equilibrium Vapor Pressure

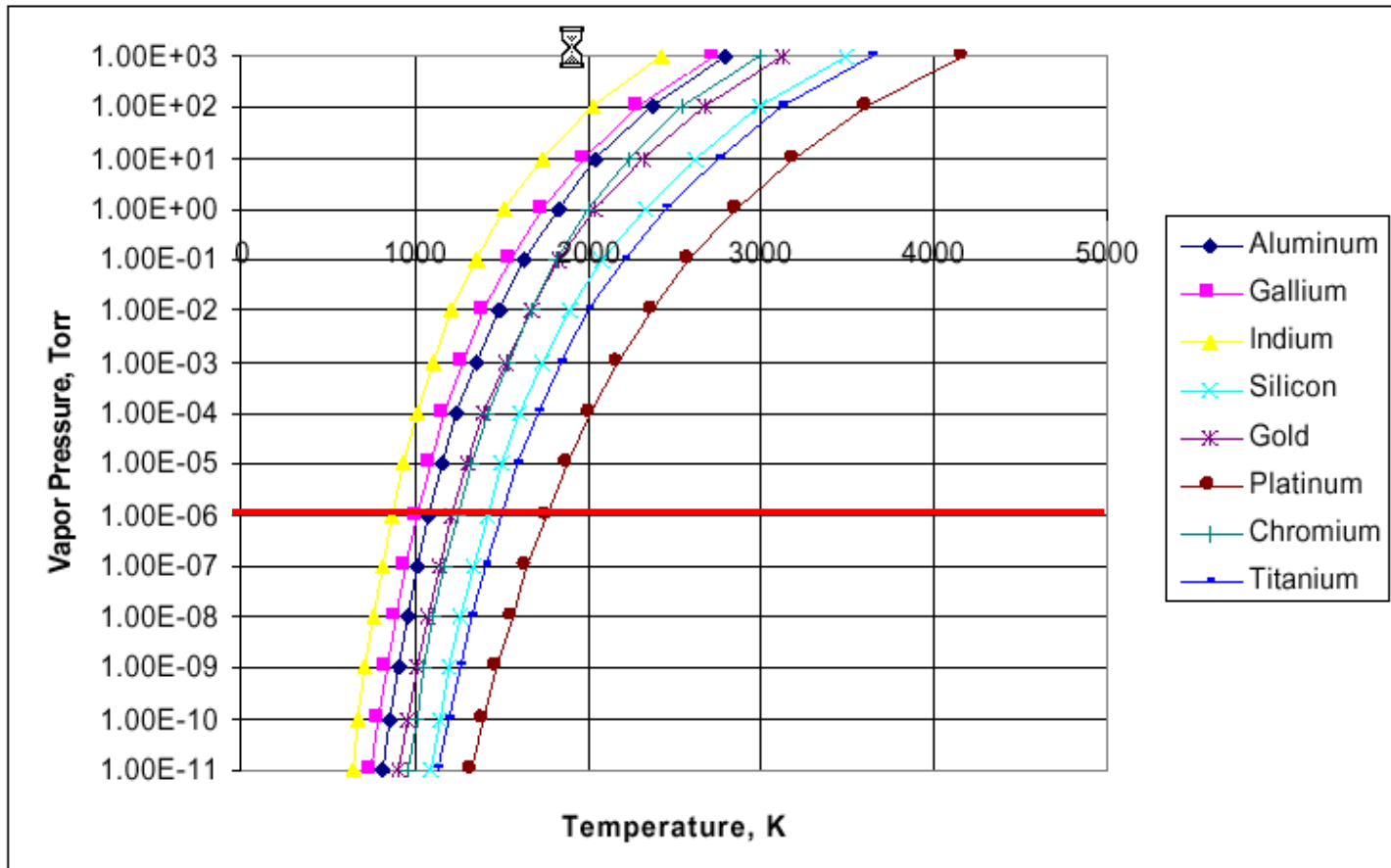

10^{-6} torr of vapor pressure ≈ 0.1 nm/s deposition rate

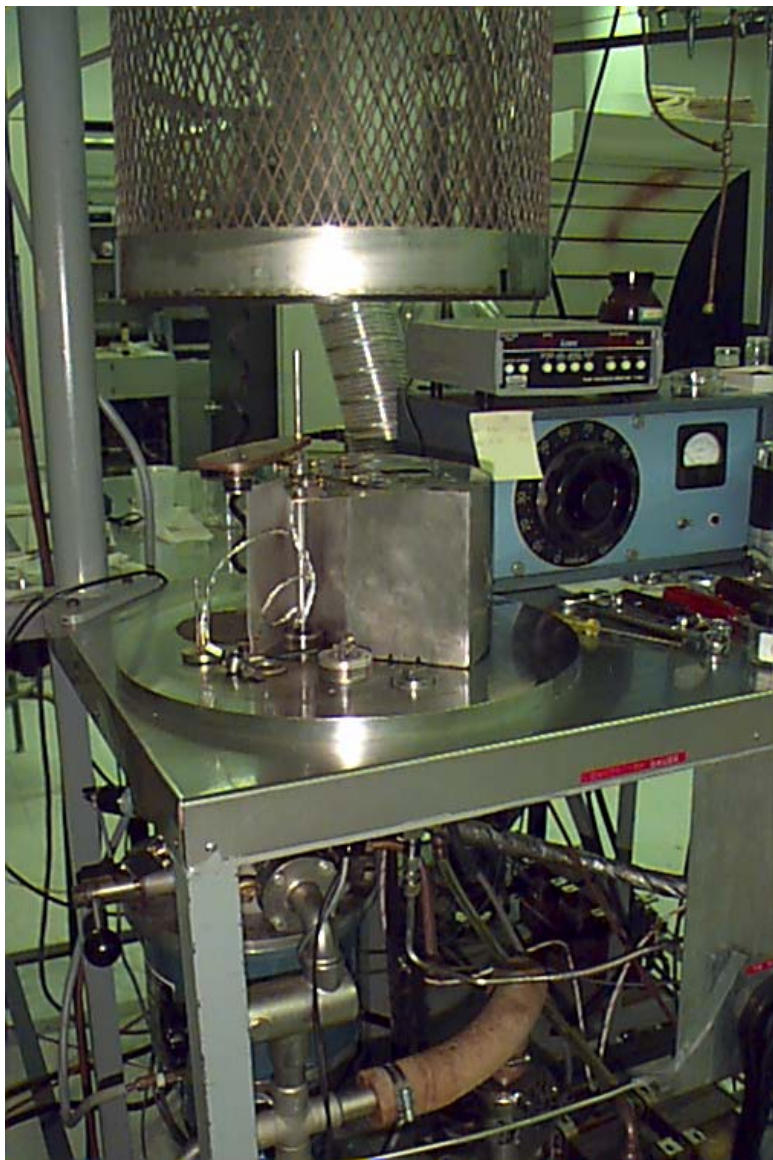

Typical High Vacuum (HV) deposition system

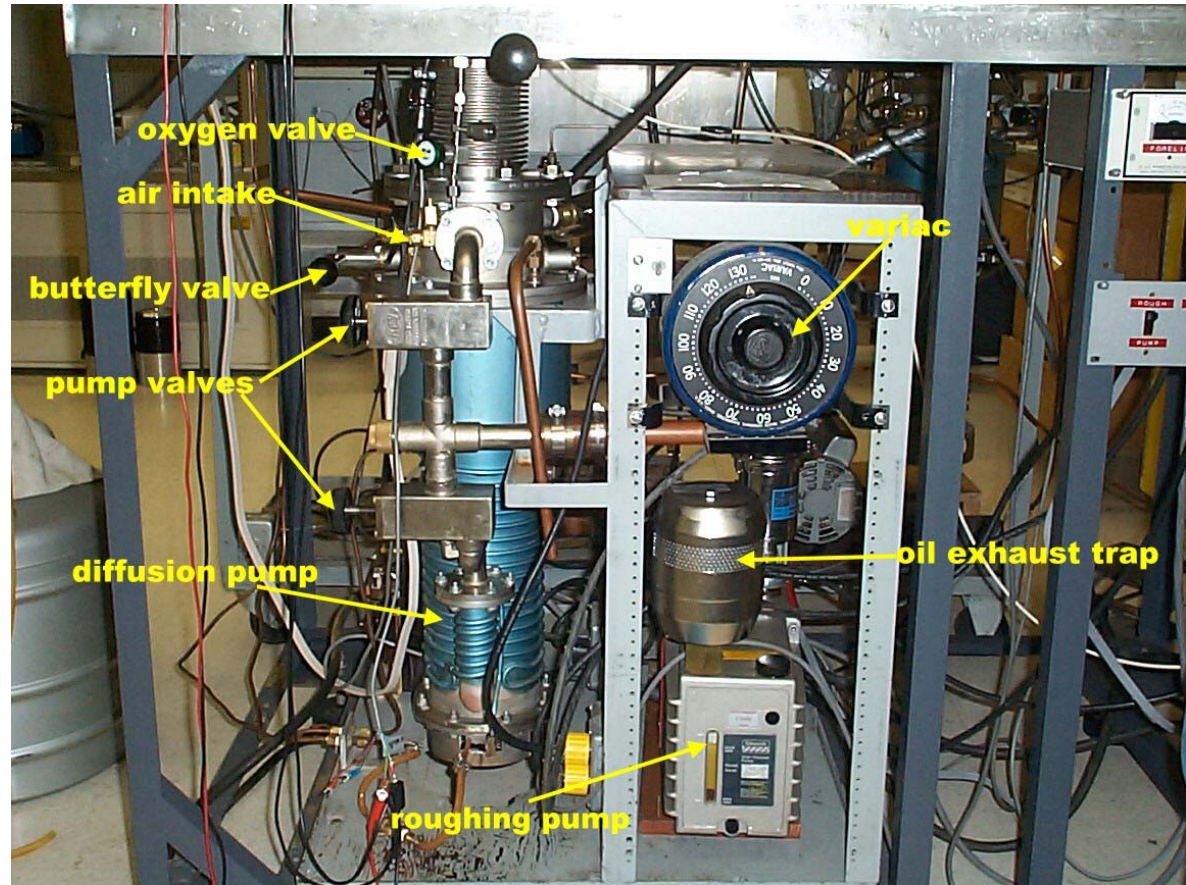

Vacuum Pumping: Viscous versus Ballistic Flow

In order to achieve high or ultra high vacuum requires a transition from pressures where flow is viscous to pressures where flow is ballistic. This requires very different approaches. In the viscous flow regime ($P \geq 0.05$ torr), a conventional pump is used. Once the pressure drops into the ballistic flow region, such pumps are ineffective and those designed for compression just up to Knudsen flow pressures are used in conjunction with a viscous flow pump.

One speaks of 'backing' or 'roughing' the high vacuum (HV), or ultra-high vacuum (UHV) pump.

In order to achieve UHV conditions, one must account for the porosity and permeability of metals.

Pump-down Pressure vs Time for a Typical Unbaked Stainless Steel Chamber

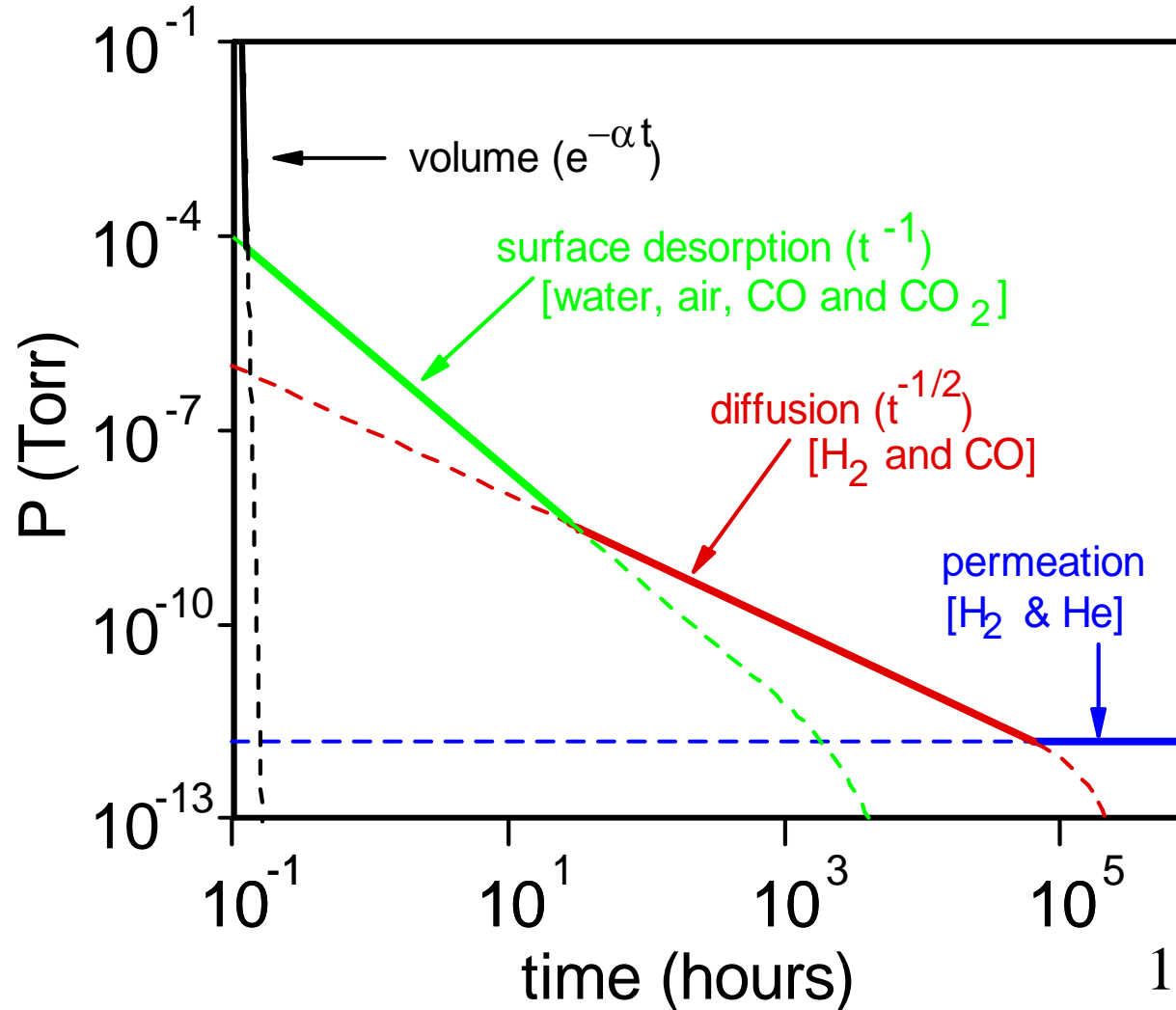

- The ultimate pressure of a particular system is achieved when the pumping rate just equals the rate of gas evolution.
- A recently opened system requires a very long time (or a very large pump) to achieve reasonable vacuum levels.

What are the units for outgassing?

- q = total flux of gas molecules
- = $\text{Pa}\cdot\text{m}^3/(\text{s}\cdot\text{m}^2)$
- = W/m^2
- = $nRT/\text{s}\cdot\text{m}^2$ = energy flow per unit area
- q is proportional to mass flow if the temperature is constant

UHV? *Bake it out!!*

The net outgassing rate (Torr-L/cm²-s or W/m²) is given by q , where $q \approx q_0 e^{-E/2kT}$. Thus, q depends exponentially on temperature. If the chamber is first heated under vacuum and then cooled, we can “cook out and off” much of the gas load.

Outgassing rates of 316L Stainless Steel after different processing operations. (Nuvolene, <i>J. Vac. Sci. Technol.</i> , 1977, 14, 210.)				
Treatment	Outgassing rate (10 ⁻¹⁰ W/m ²)			
	H ₂	H ₂ O	CO	CO ₂
Pumped under vacuum for 75 hours	893	573	87	13
Baked for 50 h @ 150 C under vacuum	387	17	6	0.4
Baked for 40 h @ 300 C under vacuum	83	0.7	2.2	0.01
20 h in pure O ₂ @ 2 Torr and 400C followed by a 20 h vacuum bakeout at 150 C.	6	3.2	0.4	<0.01

Pumps for Vacuum Systems

- High Vacuum

2-stage pumping required

Generally no bake-out

Roughing pump backing:

- *diffusion pump*
- *turbo pump*
- *cryopump*

10^{-5} to 10^{-8} torr

- Ultra-High Vacuum

3-stage pumping required

Bake-out is essential

Roughing pump backing:

- *turbo pump*
- *cryopump*

*Ion pump operating alone
after bake-out*

10^{-9} to 10^{-11} torr

Diffusion Pump

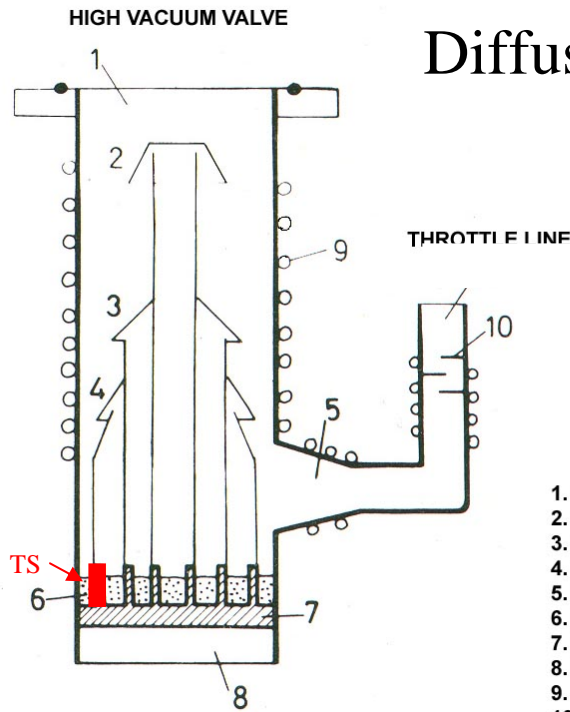

- 1. PUMP INLET
- 2. FIRST STAGE
- 3. SECOND STAGE
- 4. THIRD STAGE
- 5. EJECTOR
- 6. PUMP FLUID (OIL)
- 7. FRACTIONATING BOILER
- 8. HEATER
- 9. WATER COOLING COIL
- 10. BAFFLE
- 11. BACKING LINE

- + Inexpensive and durable.
- Oil vapor contamination

Turbomolecular Pump

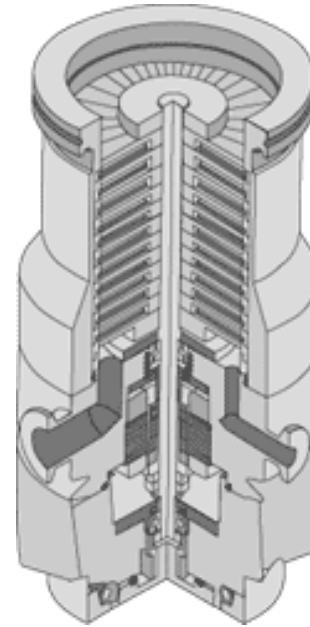

SNECMA Type

+ Very clean.

- Expensive & poor durability

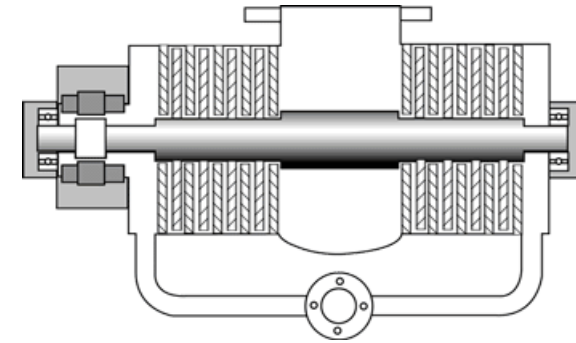

Pfeiffer Type

Ion Pump

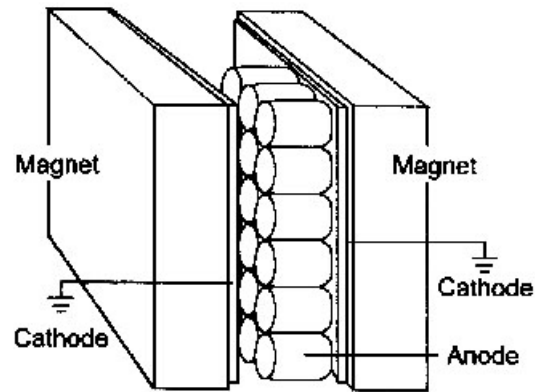

The pump is started by applying high voltage between the tube shaped anode and the cathode of the ion pump. Electrons are accelerated toward the positive anode and are forced to follow a spiral path in the tube shaped anode because of the magnetic field. This has the effect of sweeping out more space and increasing the probability that an electron will collide with a gas molecule. The positive ions that are formed in the collisions strike the chemically active titanium cathode "getter" plate. The ions combine with the cathode material and eject more cathode material which ends up on the surface of the anode. This constantly replenished the film of chemically active cathode material on the anodes which combines with active gas molecules and effectively pumps them from the system. This process of removing chemically active gasses such as Nitrogen, Oxygen, and Hydrogen is called "gettering".

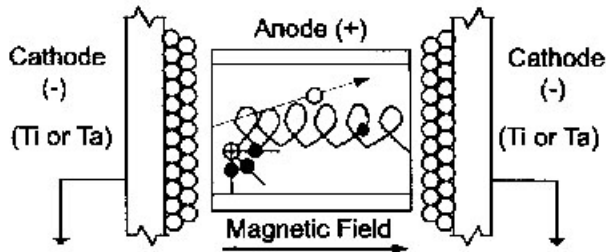

Inert gasses are handled a little differently. They are buried in the pump surfaces. This happens when they are ionized and hurled into the cathode. They penetrate a few layers and bury themselves in the cathode lattice structure. They can be re-emitted when other ions strike the surface so they tend to collect where there is little of this "sputtering" going on.

Essential Accessories

- **RGA:** Residual gas analyzer: *How clean is your system and what are you depositing?*
- **Quartz crystal thin film monitor:** *How fast is your film growing and how thick is it?*
- **Shutters and shields:** *Control where the vaporized material goes.*
- **Gauging:** *Bayard-Alpert for UHV, thermocouple for backing pressure,...*
- **Sample heating, cooling, and temperature control:** *Its hard to in a vacuum!*

Vapor Deposition

- Basic Vacuum Technology
 - Viscous versus ballistic flow.
 - When is the pressure low enough?
 - Deposition methods (vapor sources).
- **Types of Adsorption**
 - Physisorption and chemisorption**
- **Nucleation and Growth of Thin Films**
 - Frank-van der Merwe (layer-by-layer)**
 - Vollmer-Weber (island)**
 - Stranski-Krastanov (layer + island)**

Physisorption: Electronic structure of adsorbate is only weakly perturbed by the surface. Think Van der Waals and dipole-dipole attractions.

Chemisorption: A bond is formed between adsorbate and surface. Significant charge transfer occurs between adsorbate and surface. Think covalent or ionic bond.

Parameter	Chemisorption	Physisorption
Adsorption Enthalpy	40 kJ to 800 kJ per mole	Depends on molecular mass and polarizability. 5-40 kJ/mole for <i>small</i> molecules.
Nature of Adsorption	Often dissociative and/or irreversible	Molecular and reversible
Adsorption Temperature Range	Unlimited. A given molecule may have a narrow range	At or below the sublimation temperature.
Saturation Uptake	\leq one monolayer	Multilayer adsorption
Dependence on crystal plane of a given solid.	Strong dependence	Little or no dependence

Modes of Thin Film Growth

(1) Volmer-Weber: (island growth):

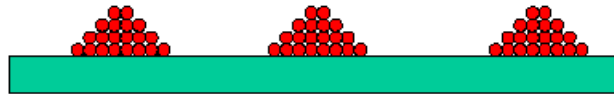

M. Volmer and A. Weber, *Z. Phys. Chem.* **119**, p. 277 (1926).

(2) Frank-Van der Merwe: (layer growth; ideal epitaxy):



F. C. Frank and J. H. Van der Merwe, *Proc. R. Soc. London, Ser. A* **198**, p. 205 (1949).

(3) Stranski-Krastanov: (layers + islands):



J. N. Stranski and L. Krastanov, *Ber. Akad. Wiss. Wien* **146**, p. 797 (1938).

Typical low coverage image of an organometallic on Au(111)

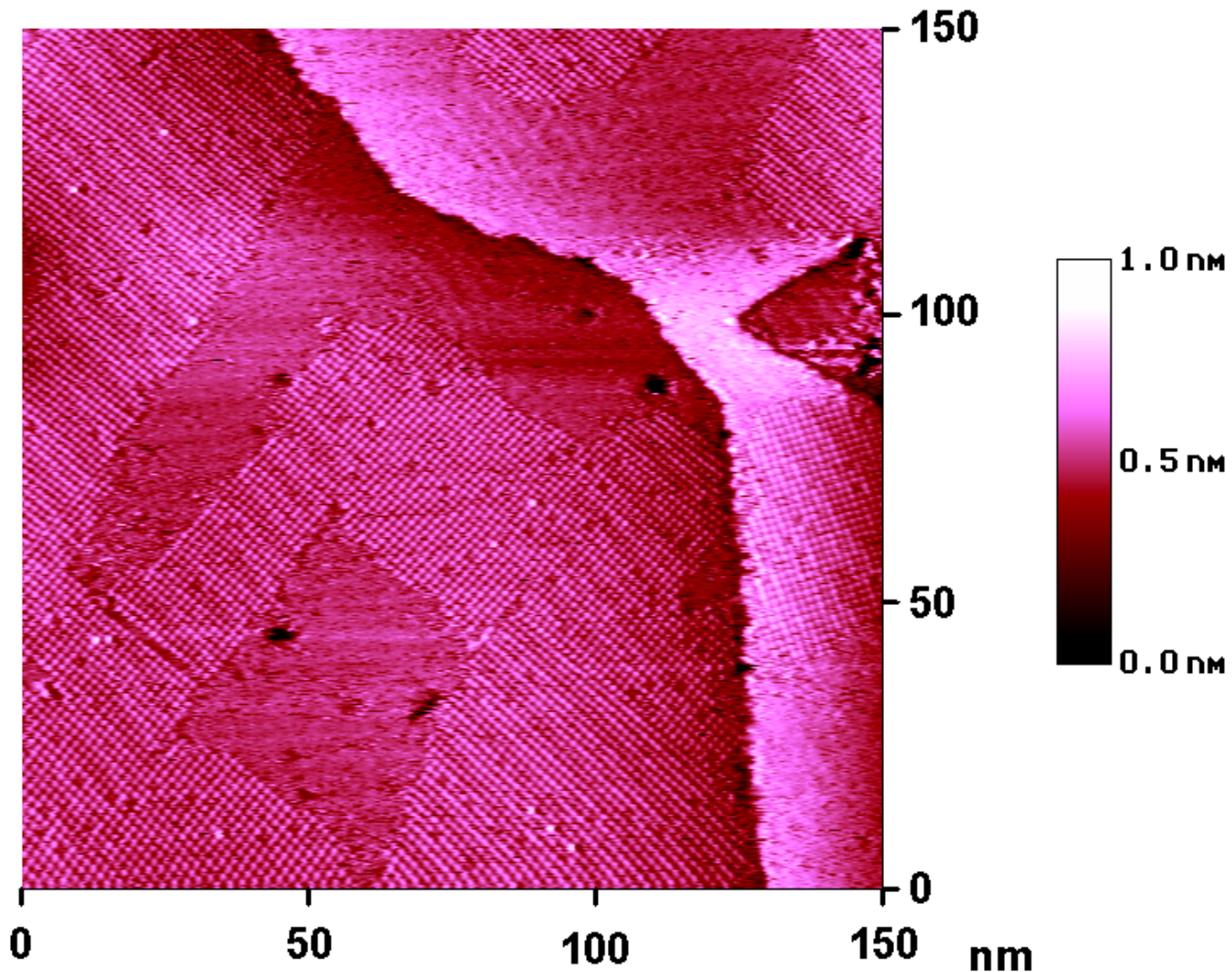

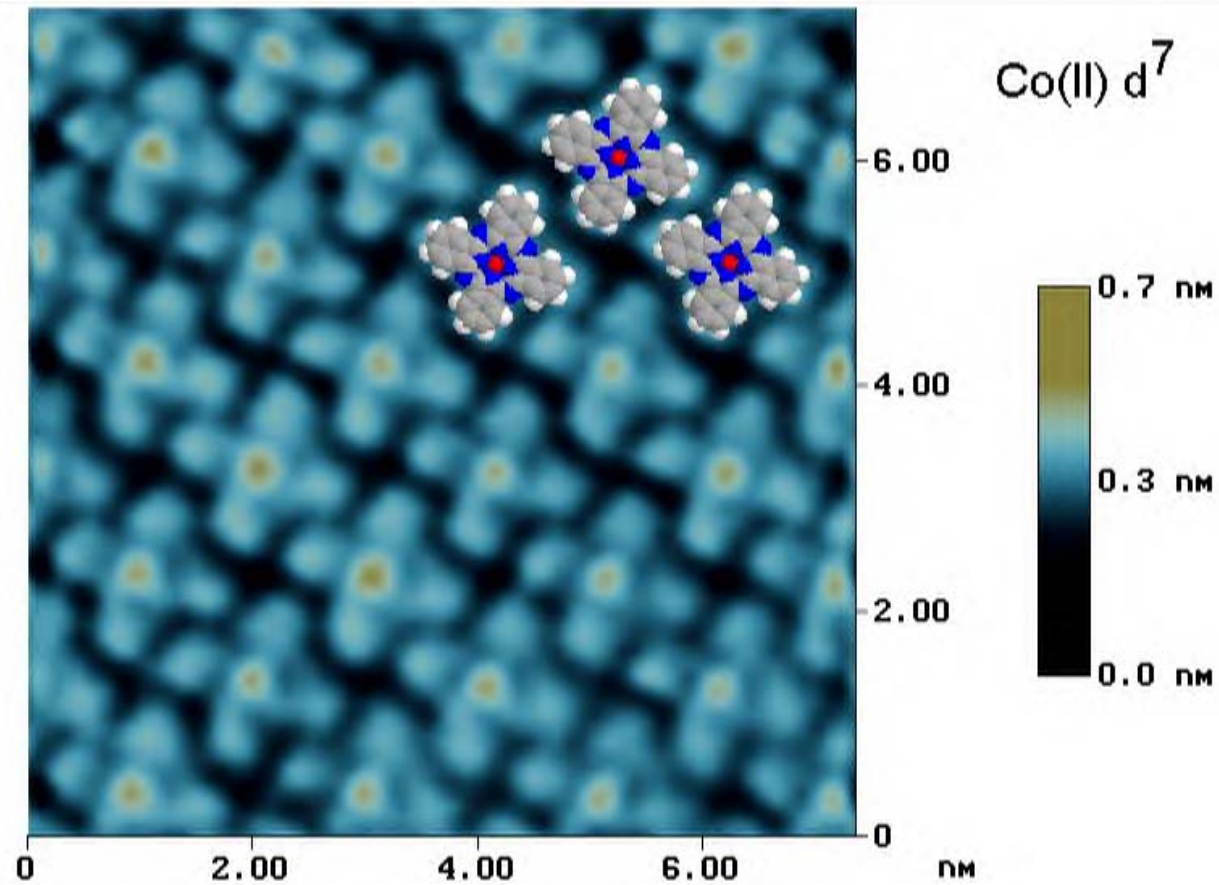

A monolayer of cobalt(II)phthalocyanine on Au(111)

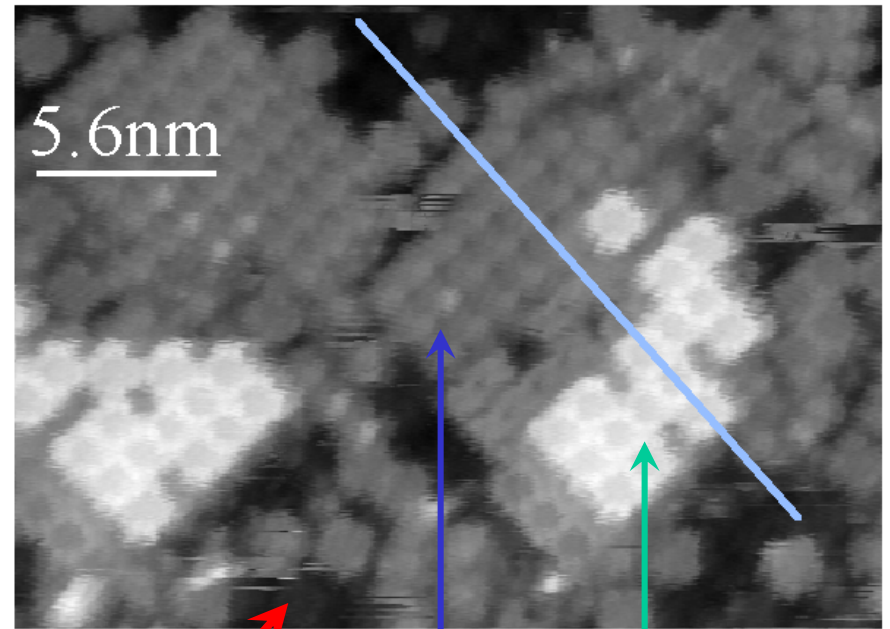
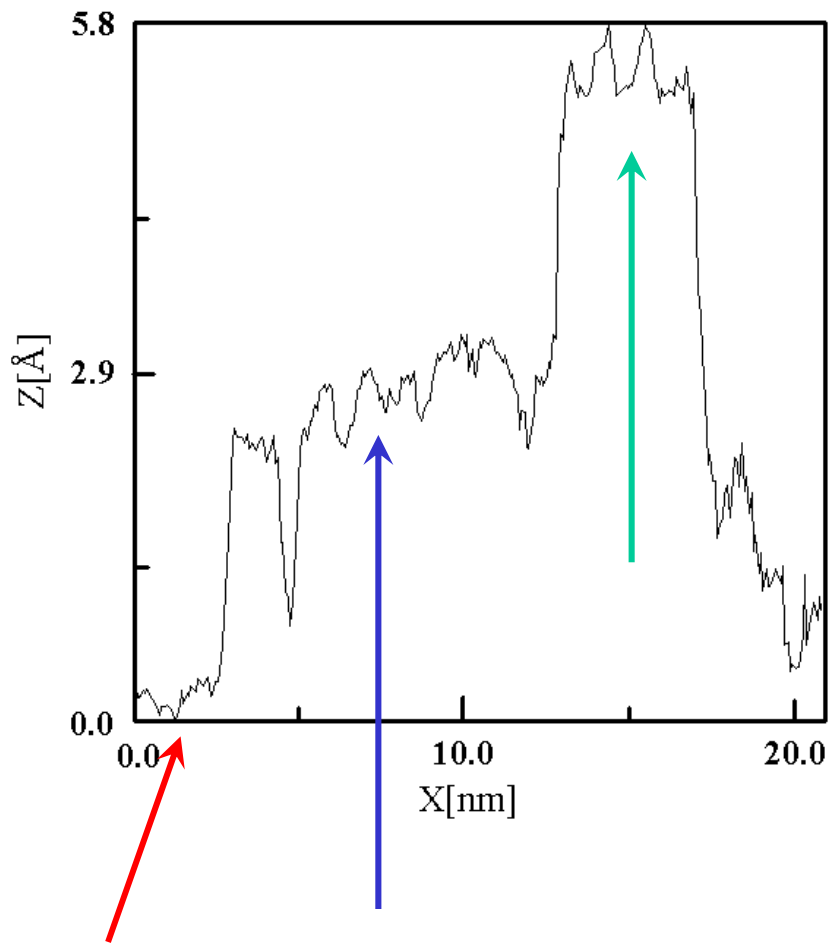

monolayer

2nd layer

3rd layer

Multilayer coverage (~ 1.6 monolayer) of MPC on Au(111)

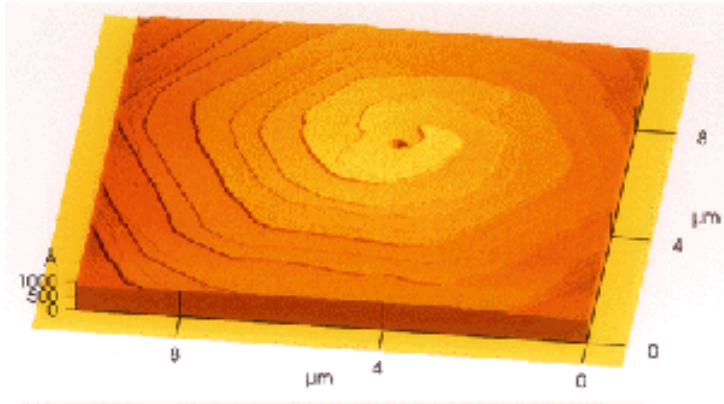

Spiral growth step of SiC surface formed by layer growth (Frank-Van der Merwe)

Island growth of Fe clusters (Volmer-Weber)

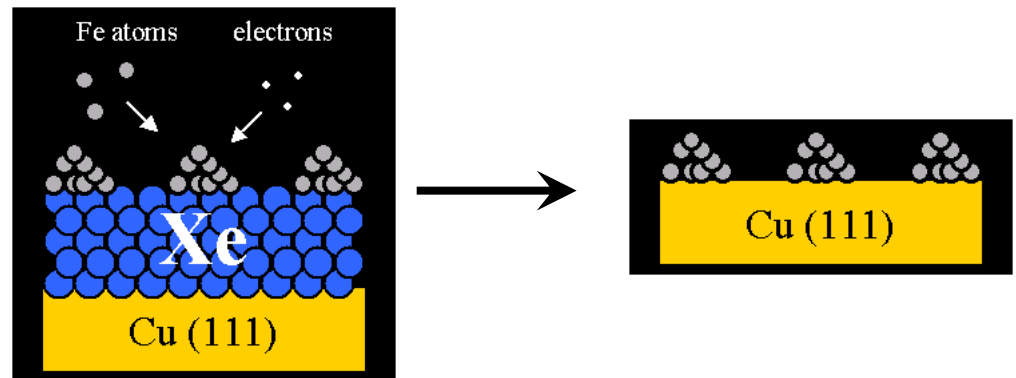

The buffer layer method, described by Weaver et al., is useful in growing quantum dots.

Self-Assembled Surface Structures

- Pressure Assisted Organized Films:
Langmuir-Blodgett films
- Self-Assembled Chemisorbed Monolayers
- Vertical Self-Assembly with Lateral Disorder
- Self-Assembled Physisorbed Monolayers
 - a) van der Waals (only) lateral interactions*
 - b) Supramolecular Structure - non-covalent interactions*
- Structure Identification through Scanning Probe Imaging and Spectroscopy.

Langmuir-Blodgett (LB) Films

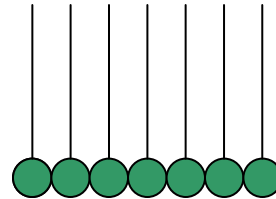

Topics:

- **Introduction to LB films**
- **Making LB Films**
- **Selected Examples of LB Films**

Langmuir-Blodgett Film: a mechanically assembled monomolecular array of (usually amphiphilic) molecules on an aqueous subphase (typically). Once the molecules become compressed to the desired organization, the resulting monolayer film can be transferred onto a solid substrate.

An amphiphilic molecule possesses one end that is hydrophilic and the other that is hydrophobic.

History of LB Films

- 1800 BC** Babylonians: foretell future by spreading oil on water.
- 1757 AD** Ben Franklin: oil on water dampens surface waves. Stirrs scientific interest in surface spreading on water.
- 1891 AD** Agnes Pockels: designs a trough with barriers for the manipulation of oil films on water; measures the first pressure - area isotherm.
- 1899 AD** Lord Rayleigh: uses Pockels' method to determine the size one of olive oil molecule (~ 1 nm thick).
- 1915 AD** Irving Langmuir: demonstrates that fatty acids form an ordered array on water.
- 1916 AD** Katharine Blodgett: deposits fatty acid films on solid supports; measures optical properties of films.
- 1938 AD** V. J. Schaefer: deposits LB films by horizontal lifting.

A low density layer of molecules is formed on water through solvent evaporation

1

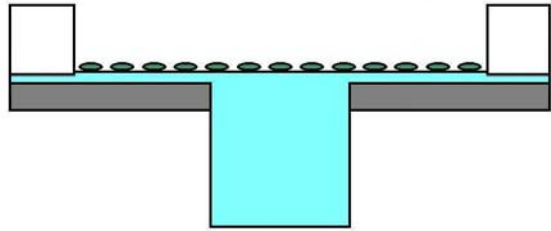

The movable barriers are brought together decreasing the area per molecule until a dense ordered monolayer is formed

2

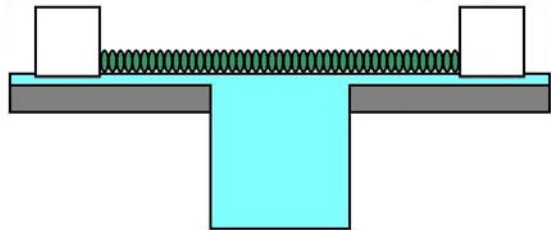

In the common Blodgett method, a substrate is moved through the LB film vertically to pick up the film. The area is simultaneously reduced to keep the film density constant.

3

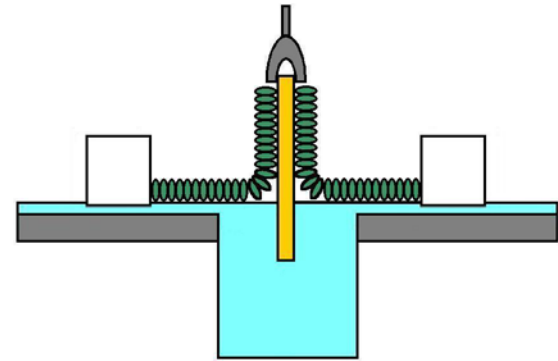

Clean Water

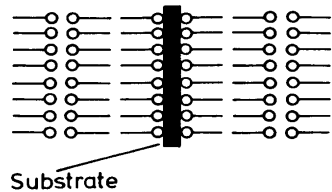
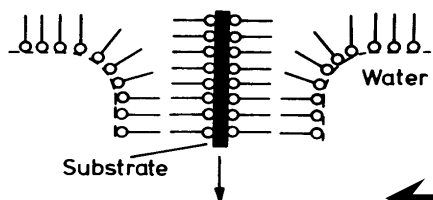
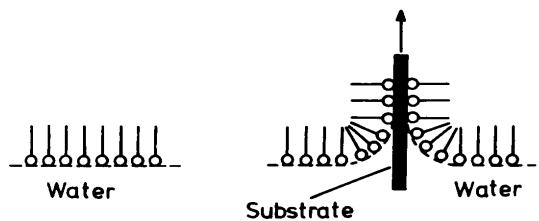
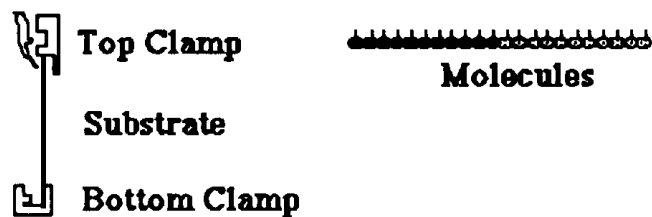
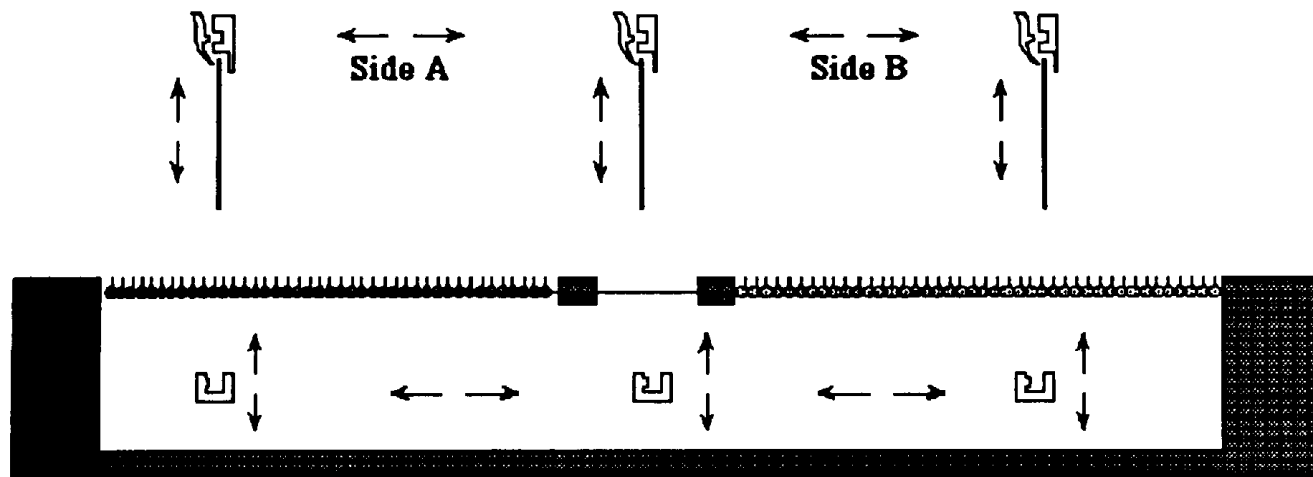

Y-type deposition

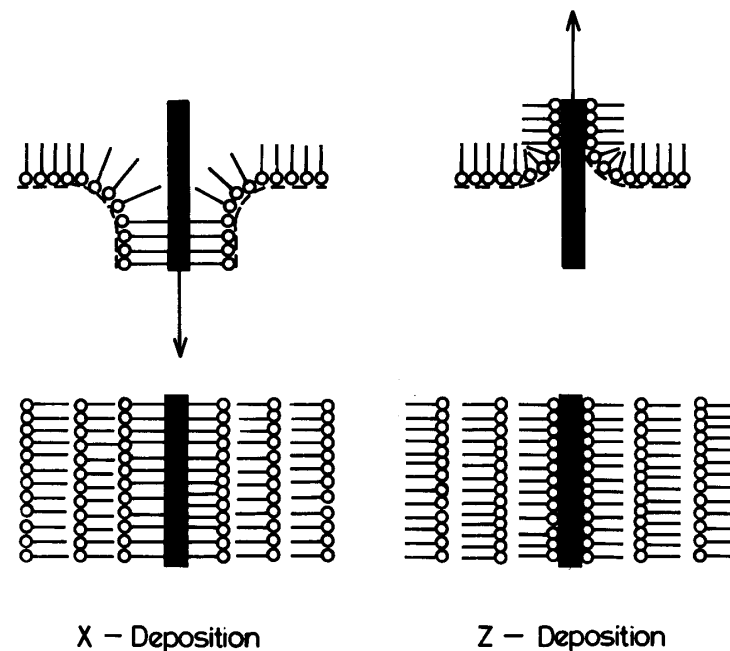

X - Deposition

Z - Deposition

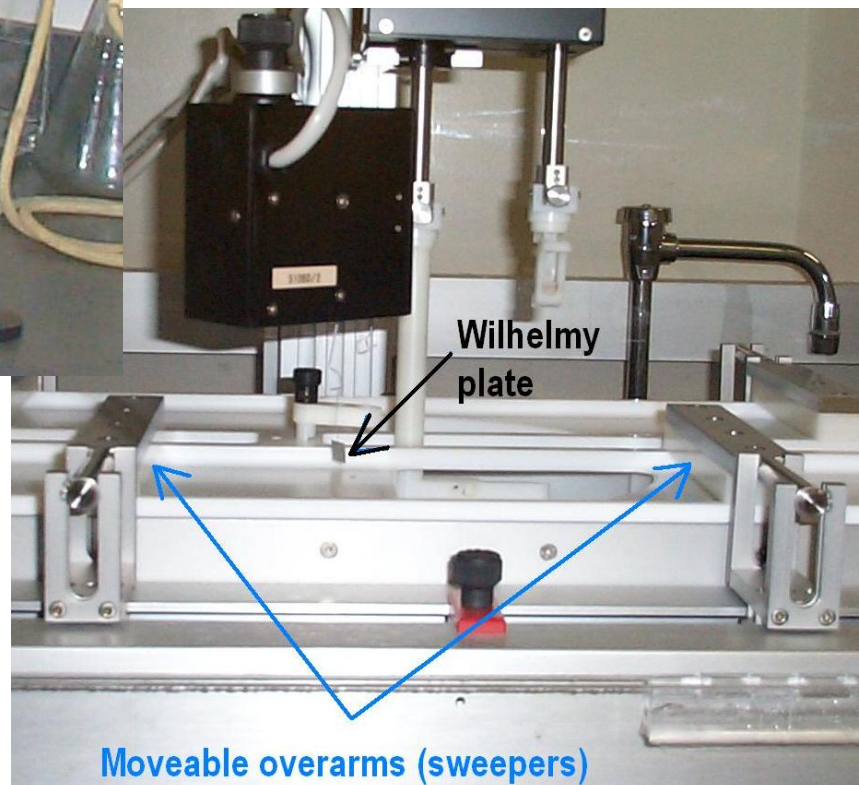

Surface (or Spreading) Pressure

The force per unit length exerted by the film on the walls is just the difference in surface tensions of the film covered surface and of the pure substrate (water).

$$F_{\text{ext}} = \Pi = \gamma - \gamma_s$$

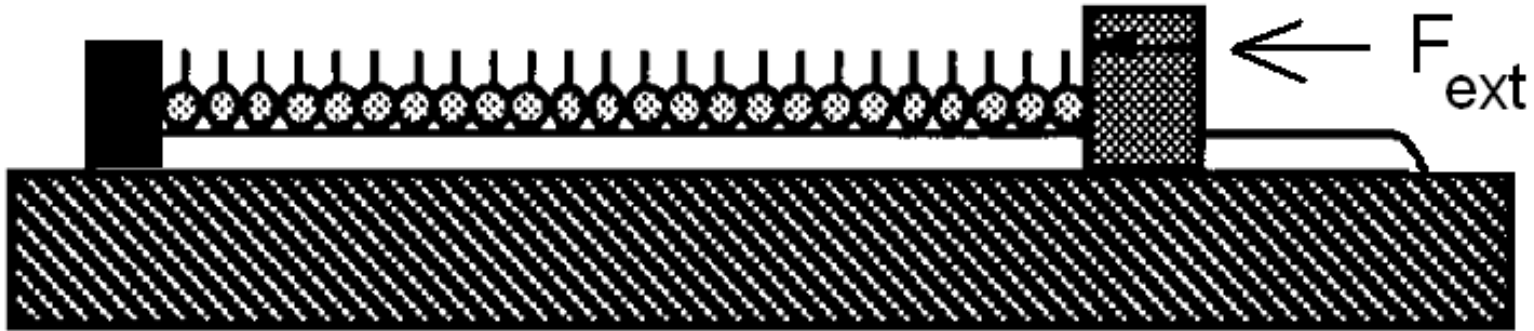

Surface pressure/area isotherm for Stearic Acid at 22°C

Surface Pressure
(mN/m)

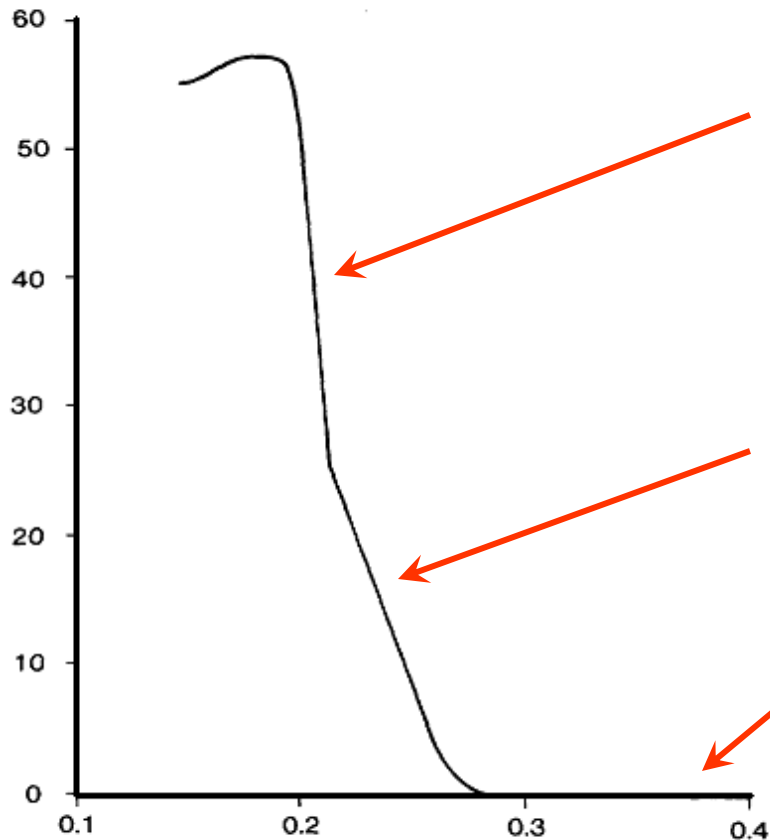

“solid” phase

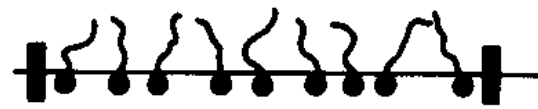

“liquid” phase

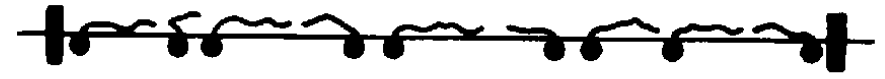

“gas” phase

Area/molecule (nm⁻²)

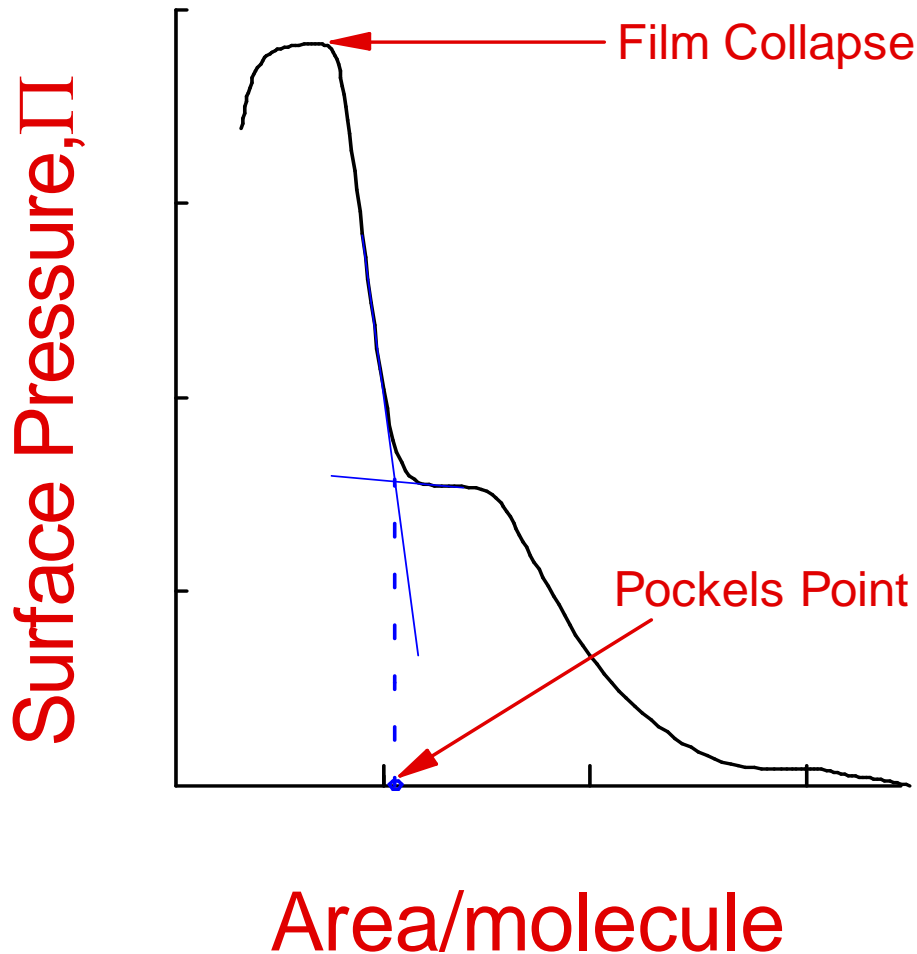

The effective cross sectional area per molecule in the ordered phase is given by the Pockels Point, A_P .

For liquids, the effective height, h , is given by

$$h = m/\rho A_P$$

where ρ is the density of the bulk liquid and m is the mass of liquid spread on water.

Examples of Molecular Types Known to Form LB Films

- fatty acids ($C_nH_{2n+1}COOH$; $n > 12$)
- heterocyclic compounds and dyes with long aliphatic chains.
- functionalized porphyrins and phthalocyanines
- alkane chains with polar end groups
- lipids
- non-amphiphilic compounds mixed with fatty acids

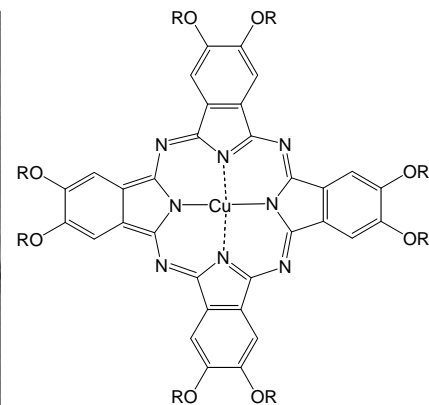
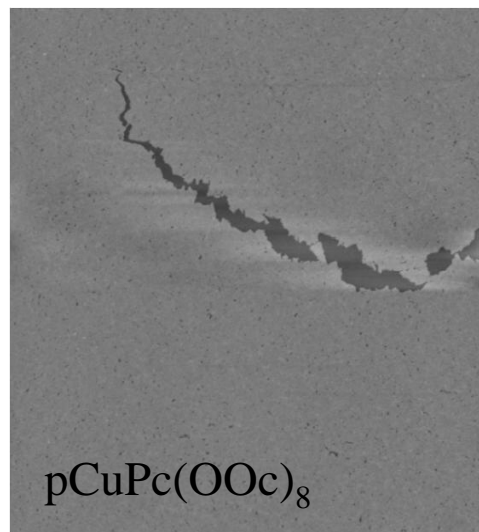
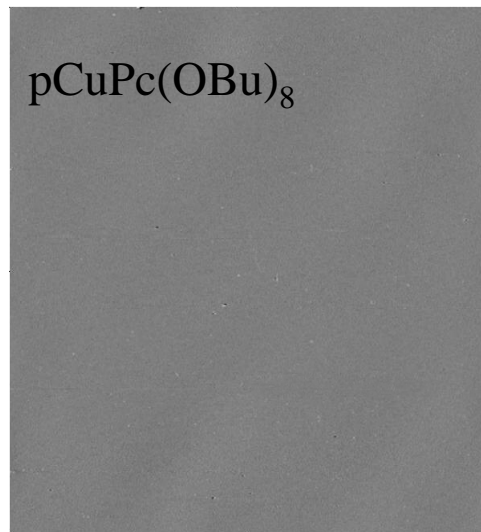

$pCuPc(OR)_8$

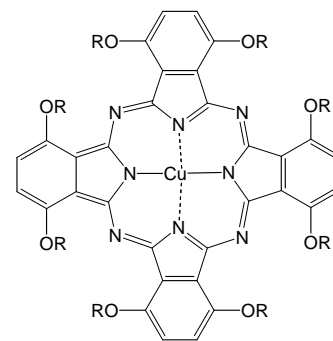
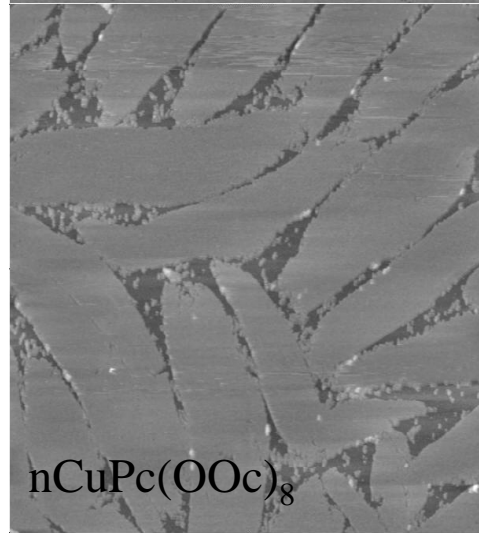
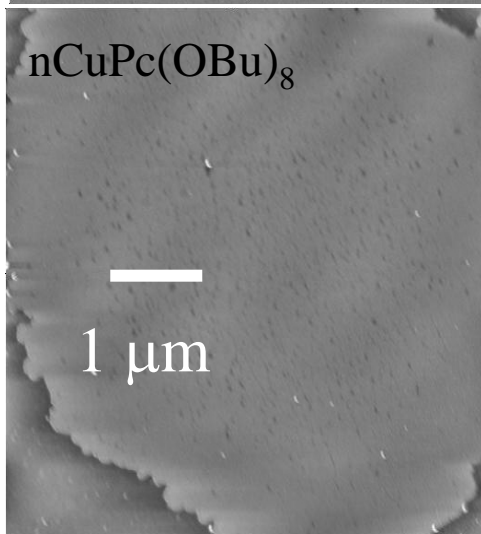

$nCuPc(OR)_8$

Effect of peripheral substituents on single monolayer film quality.

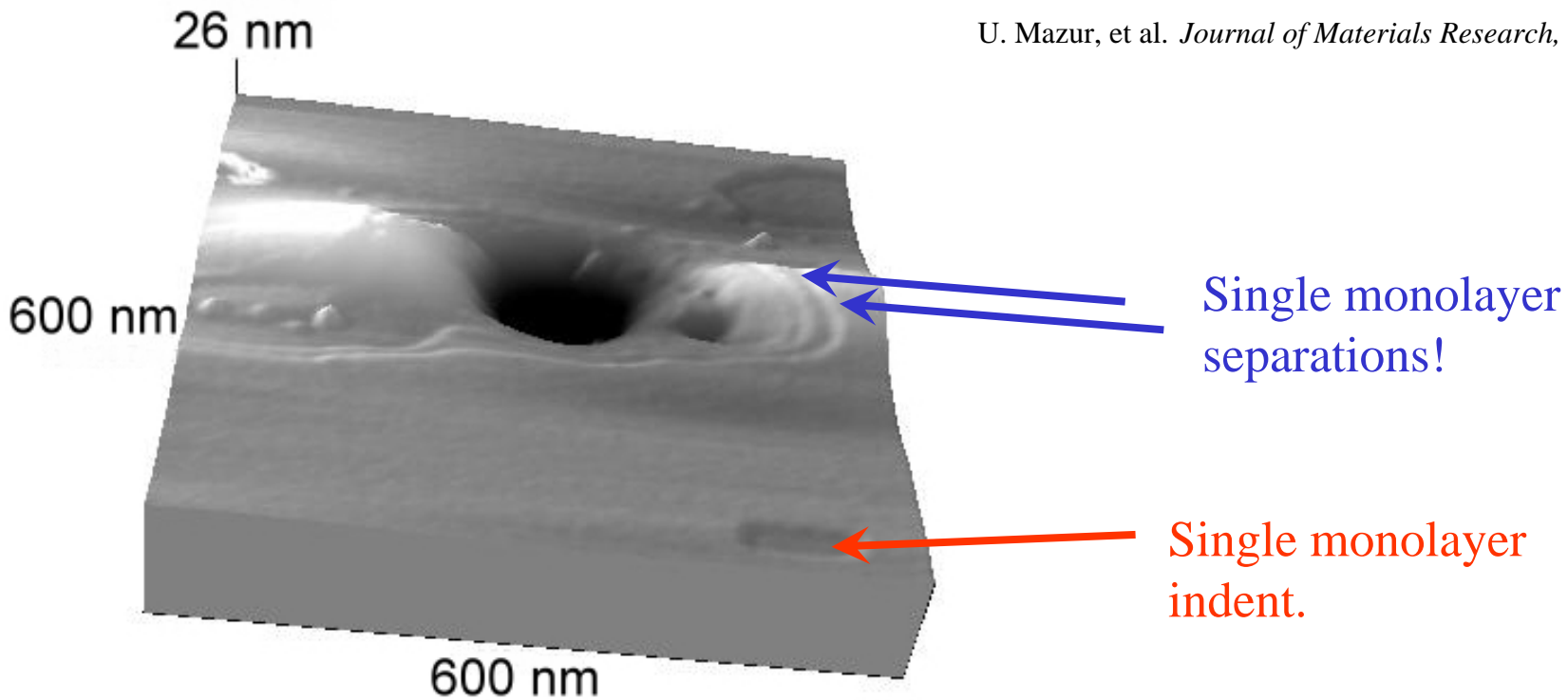

Mechanical Properties of 10 monolayer CuPc based LB films and selected materials.

Material	Young's modulus (GPa)	Hardness (GPa)
pCuPc(OBu)₈/W (nanoindenter)	83	0.60
pCuPc(OBu) ₈ /mica (AFM)	110	
pCuPc(OOc) ₈ /W (nanoindenter)	71	0.60
nCuPc(OOc) ₈ /W (nanoindenter)	63	0.52

Copper*	130	0.6
Aluminum* +	70	0.4 (film on Si)
Magnesium*	45	0.3

Polyethylene	3	0.1
--------------	---	-----

*<http://environmentalchemistry.com/yogi/periodic/>; + Oring, "Materials Science of Thin Films", 2002

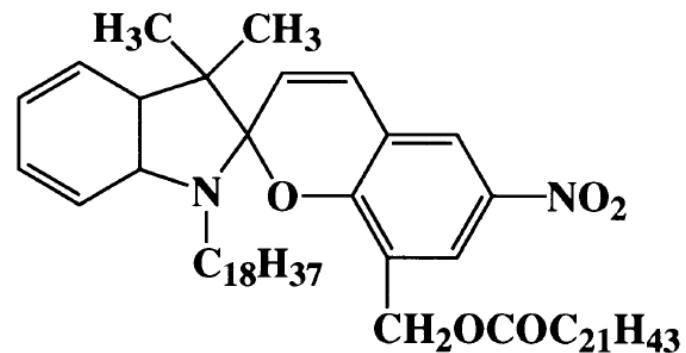
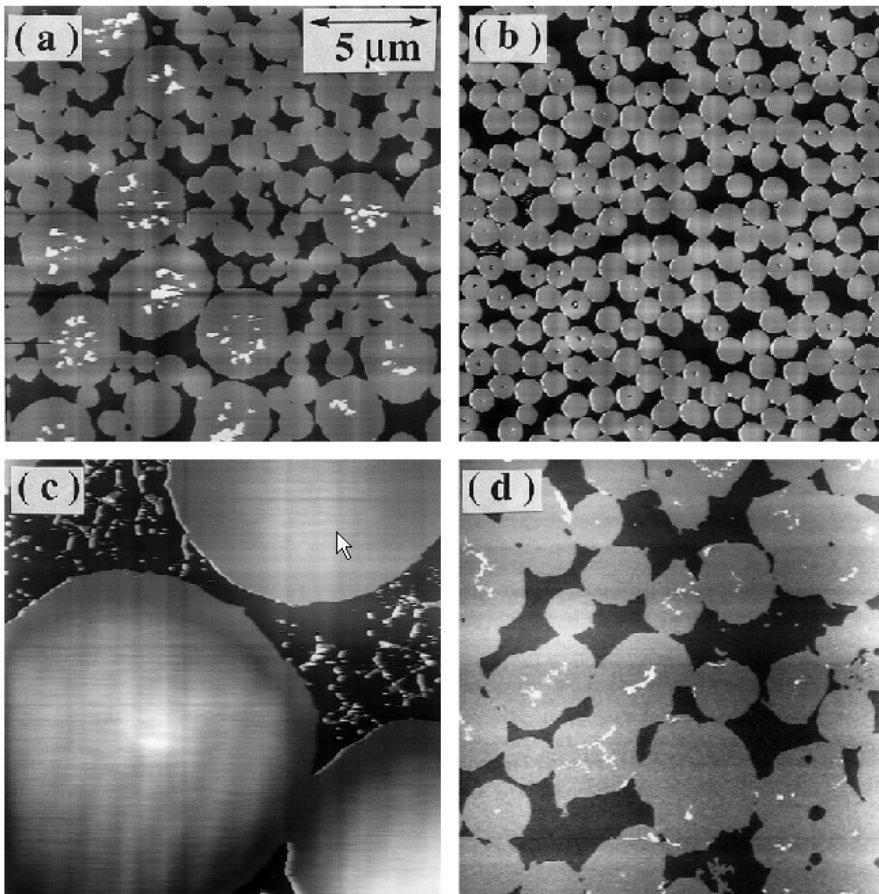

AFM image of a
single monolayer on
mica.

Part in Fig.	Solvent	Concentration (mM)	Subphase temp (°C)
(a)	CHCl ₃	0.1	17
(b)	CHCl ₃	1.0	17
(c)	CHCl ₃	0.1	29
(d)	toluene	0.1	17

Self-Assembled Surface Structures

- Pressure Assisted Organized Films:
Langmuir-Blodgett films
- Self-Assembled Chemisorbed Monolayers
- Vertical Self-Assembly with Lateral Disorder
- Self-Assembled Physisorbed Monolayers
 - a) van der Waals (only) lateral interactions*
 - b) Supramolecular Structure - non-covalent interactions*
- Structure Identification through Scanning Probe Imaging and Spectroscopy.

Self-Assembled Films

Self-assembly has become one of the holy grails of nanotechnology, and scientists in numerous labs are working to transform it into an effective nano-engineering tool.

In some sense, self-assembly is nothing new: biology does it all the time. Moreover, "supramolecular" chemistry has been studied for decades, showing how molecules can team up to form new non-covalent structures. The concept of self-assembly largely grew out of chemists' attempts to make molecules that aggregated spontaneously into specific configurations, in the same way biological molecules form complex cell membranes.

A Self Assembled Monolayer (SAM) is an ordered molecular assembly formed by the spontaneous adsorption of a molecular species. This adsorption might take place from vapor, liquid, or from solution depending on the adsorbate and the surface. Although the field is not limited to long chain molecules (we will see lots of other types), functionalized long chain hydrocarbons are most frequently used as the building blocks of these supramolecular thin film structures.

Thus, a typical SAM is formed from long chain organic molecules with a reactive group at one end that can undergo a specific chemical reaction with a substrate.

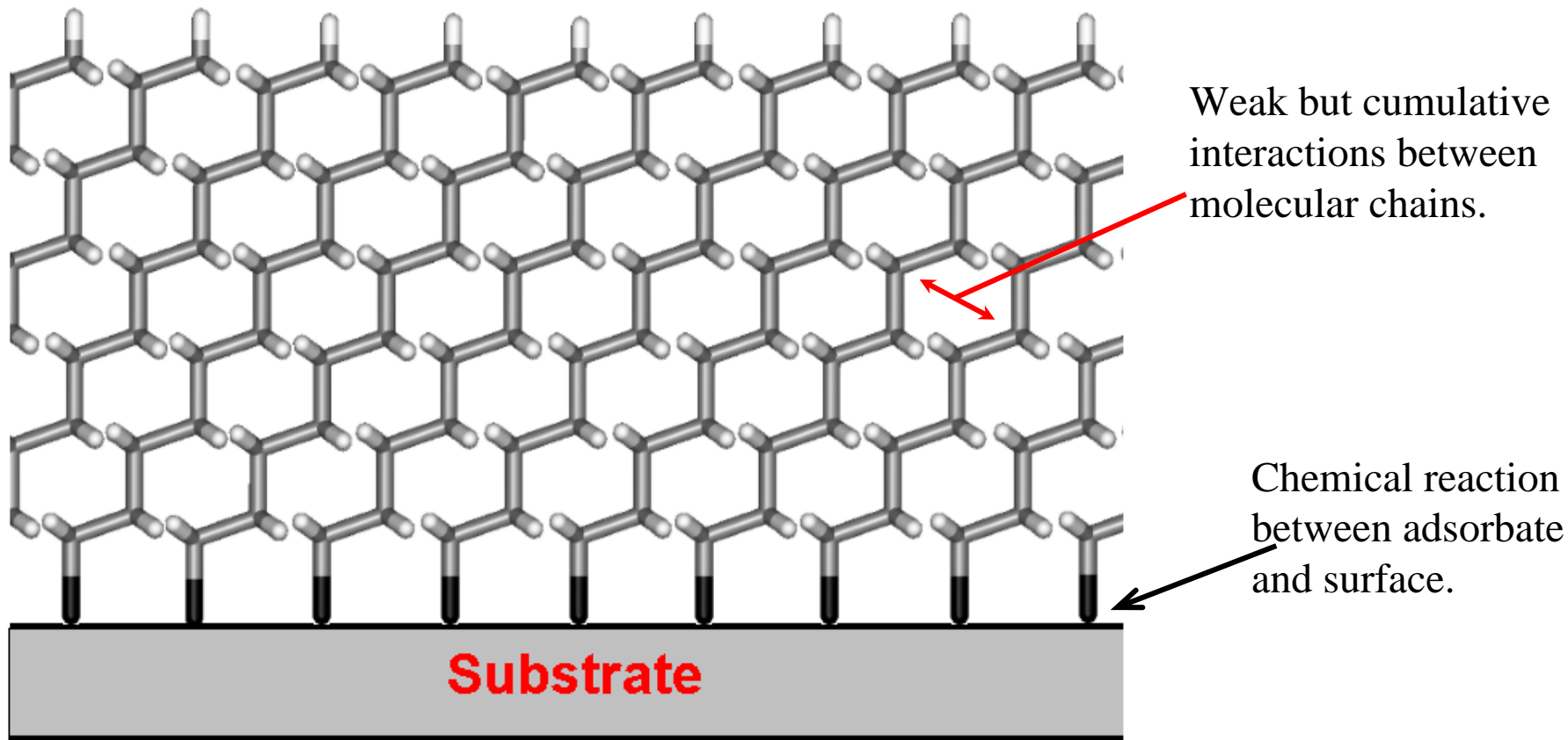

The driving forces for the spontaneous formation of many (but not all) SAMs include chemical bond formation of molecules with the surface and intermolecular interactions.

Organic-thiol SAMs

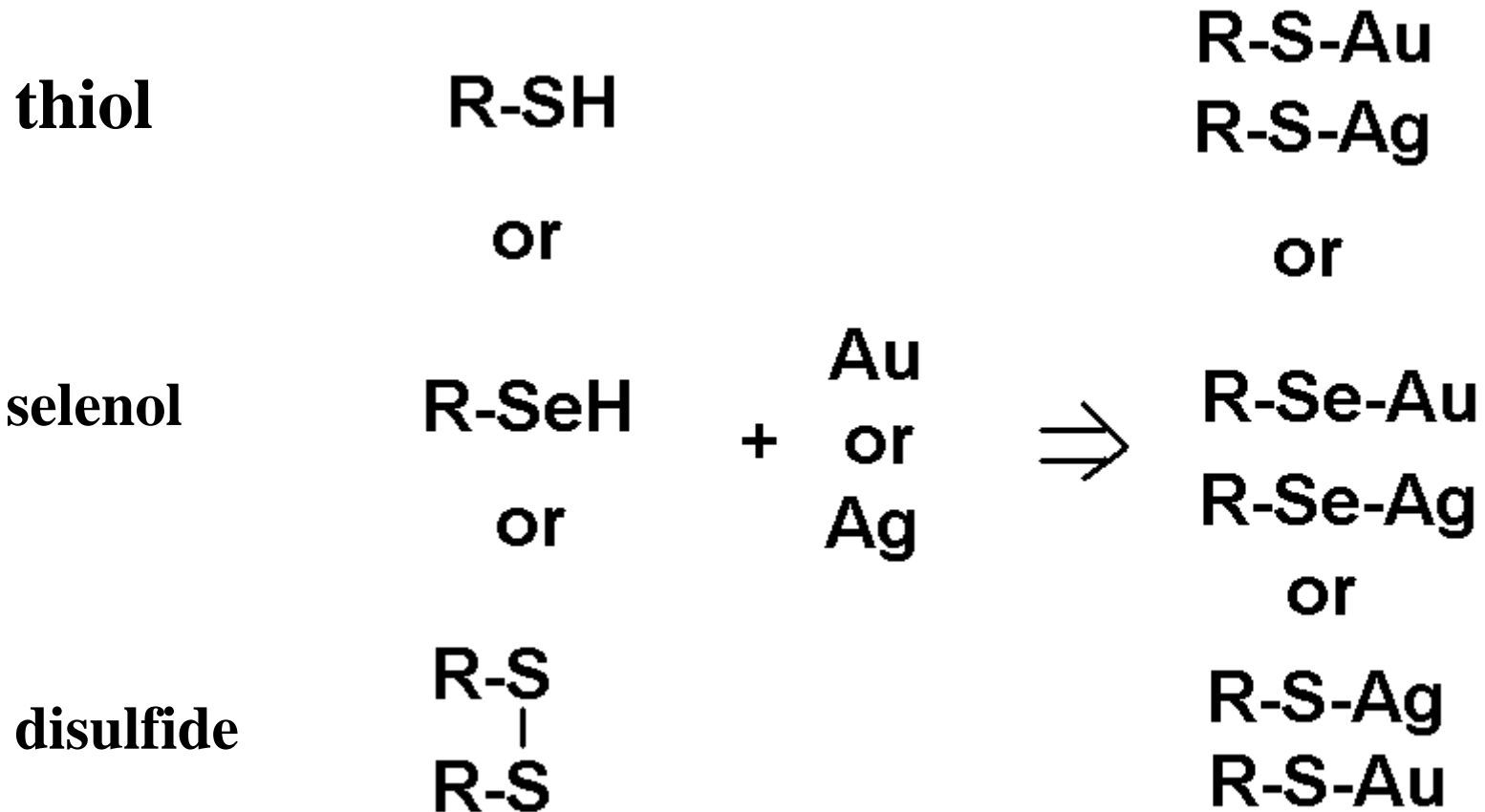

Typical Alkyl-Thiol SAM Formation

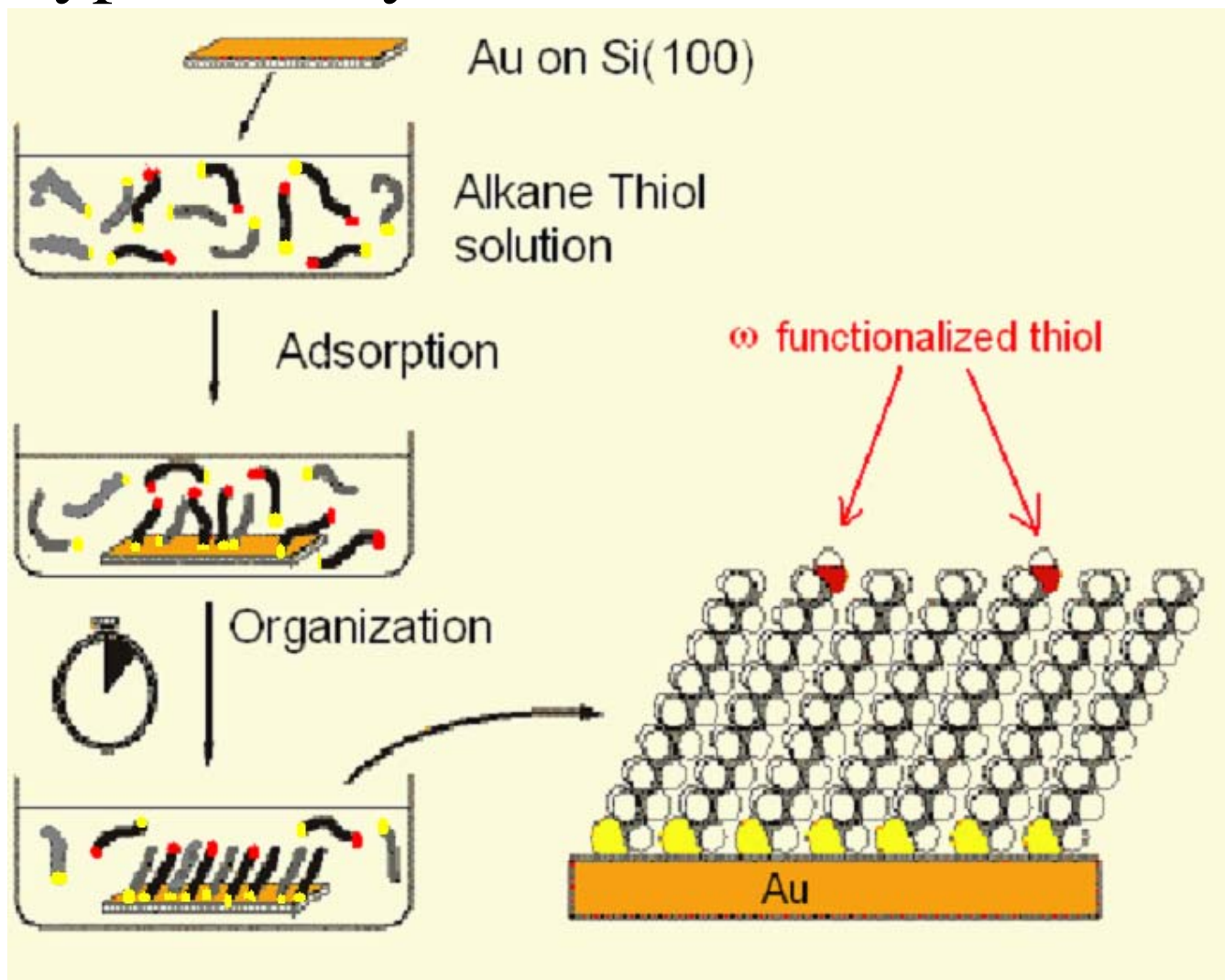

The terminal alkane end can be easily functionalized in order to provide a designed surface chemistry. (At a few sites, or all of them)

SAMs can also be formed on oxides!

$\text{CH}_3(\text{CH}_2)_n\text{CO}_2\text{H}$ Adsorbed on Oxide Surfaces

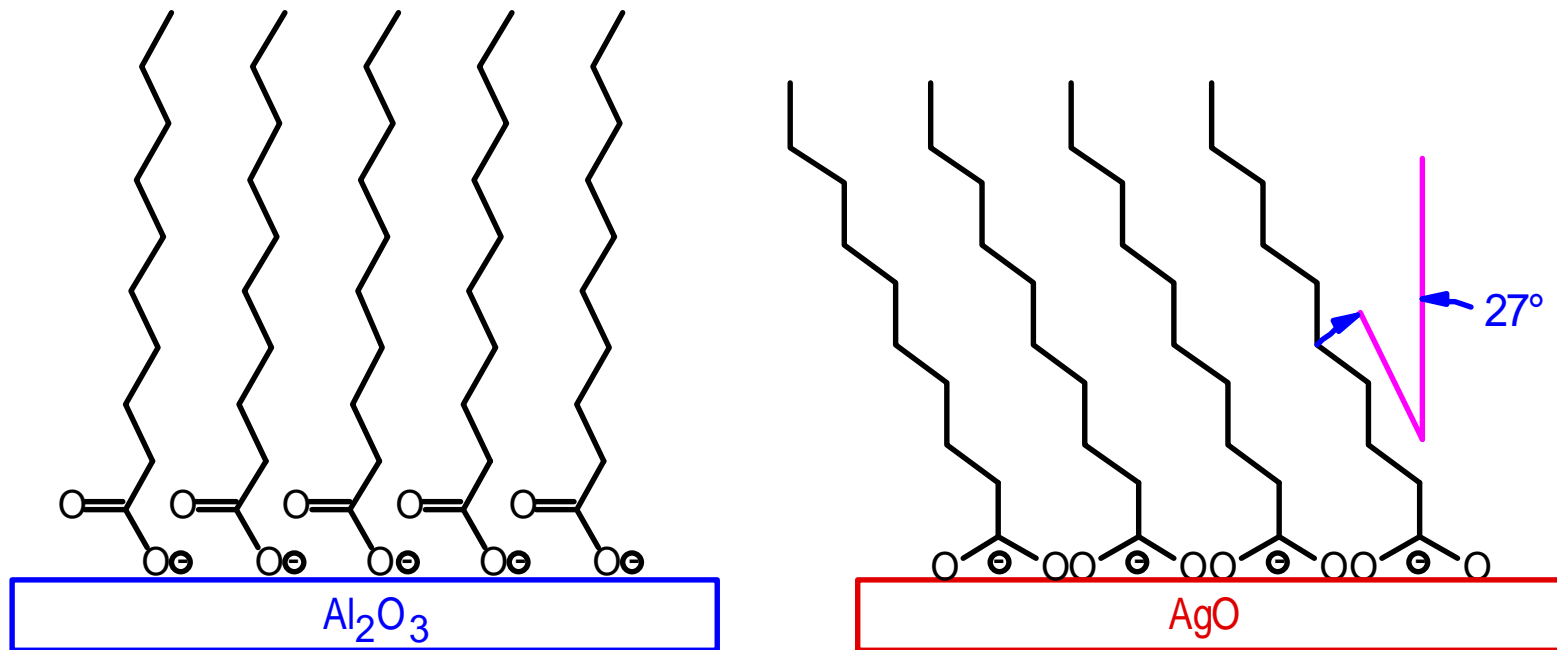

Surface acid-base reaction with elimination of water.

Silanes are also very active in forming SAMs on oxide surfaces. Like alkyl-thiols, they can be terminally functionalized and used as-is for specific chemistry or can become the base for a multi-layer SAM. They can be adsorbed from liquid or vapor but form only partially ordered layers

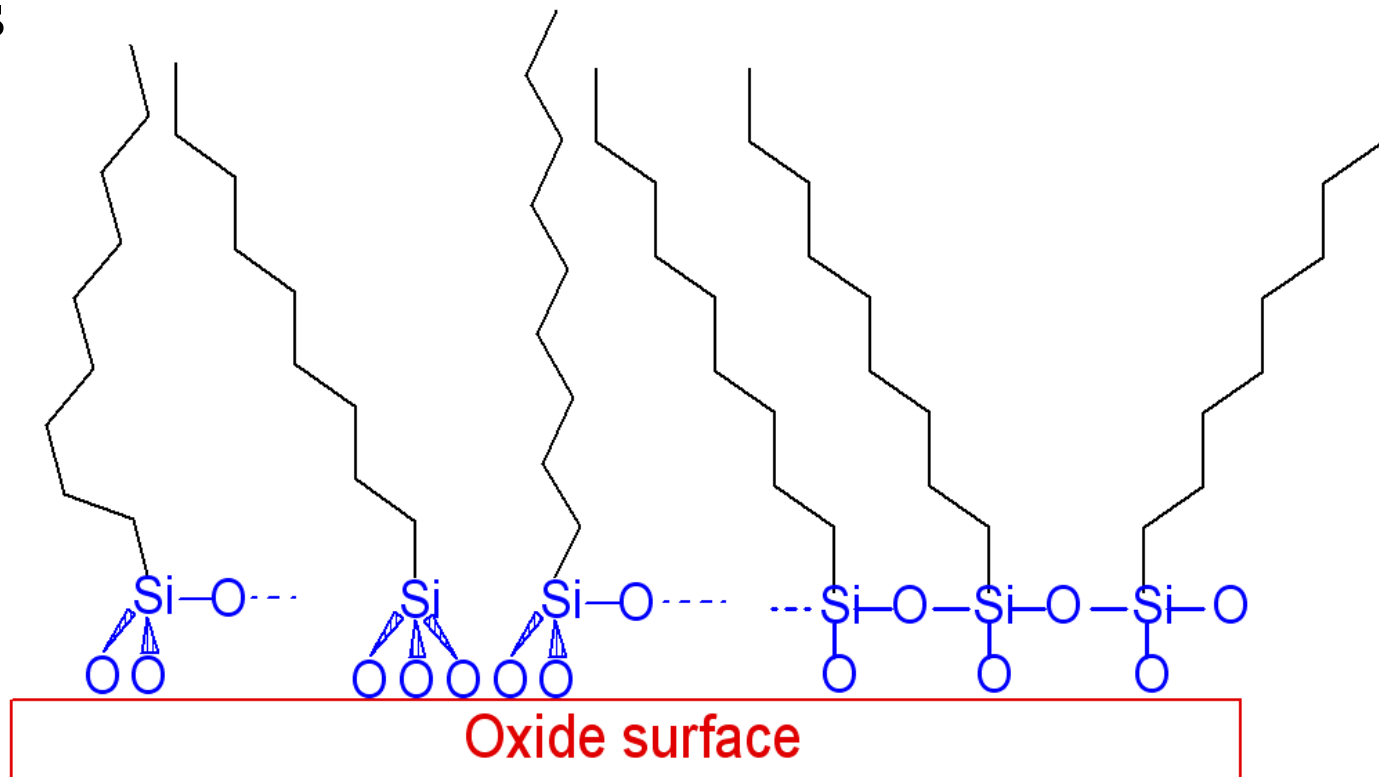

Self-Assembled Surface Structures

- Pressure Assisted Organized Films:
Langmuir-Blodgett films
- Self-Assembled Chemisorbed Monolayers
- Vertical Self-Assembly with Lateral Disorder
- Self-Assembled Physisorbed Monolayers
 - a) van der Waals (only) lateral interactions*
 - b) Supramolecular Structure - non-covalent interactions*
- Structure Identification through Scanning Probe Imaging and Spectroscopy.

Vertical Self-Assembly of Polyions

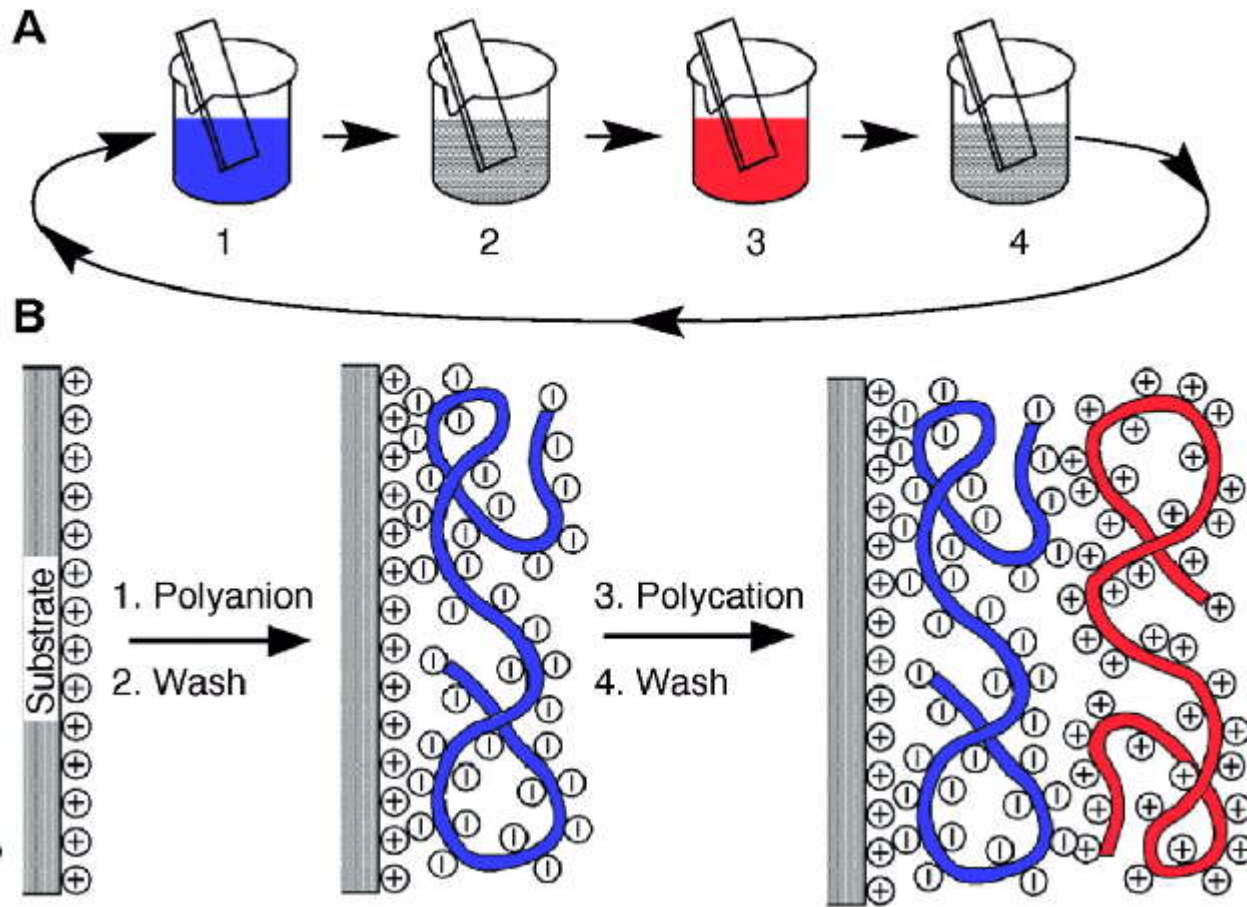

Positive poly-ethylene-imine (PEI) layer on a negatively charged polystyrene-sulfonate (PSS) film (on glass) [*Thin Solid Films* 210 - 211 (1992) 831]

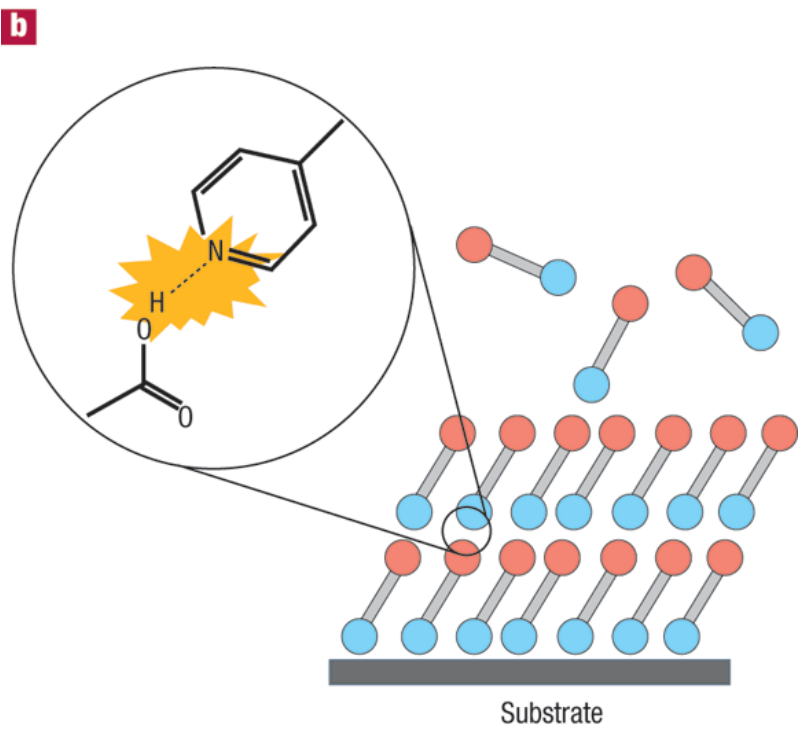
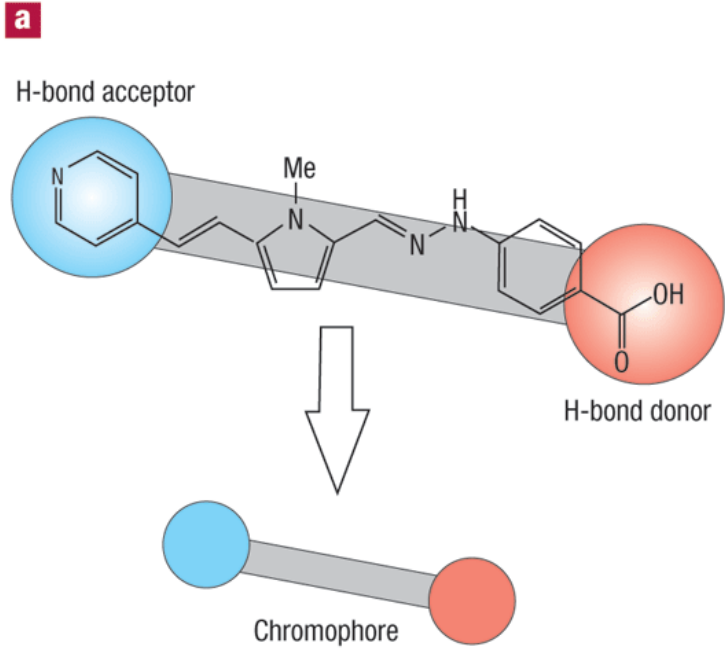

Self-assembly of nonlinear optical molecules into acentric films. The nonlinear optical molecules are end-capped by a hydrogen-bond acceptor group (pyridine) at one end and a hydrogen-bond donor (carboxylic acid) at the other end. Through hydrogen bonding, these molecules self-assemble into head-to-tail geometries.

Nature Materials (2004) 3, 841-843
Nature Materials (2004) 3, 910-917

Contact-mode AFM images of self-organized acentric films. Topographs refer to scan areas of $5 \times 5 \mu\text{m}^2$ on a silicon substrate for films of thickness: a, 400 nm (r.m.s. = 0.37 nm) and b, 1,470 nm (r.m.s. = 8.68 nm).

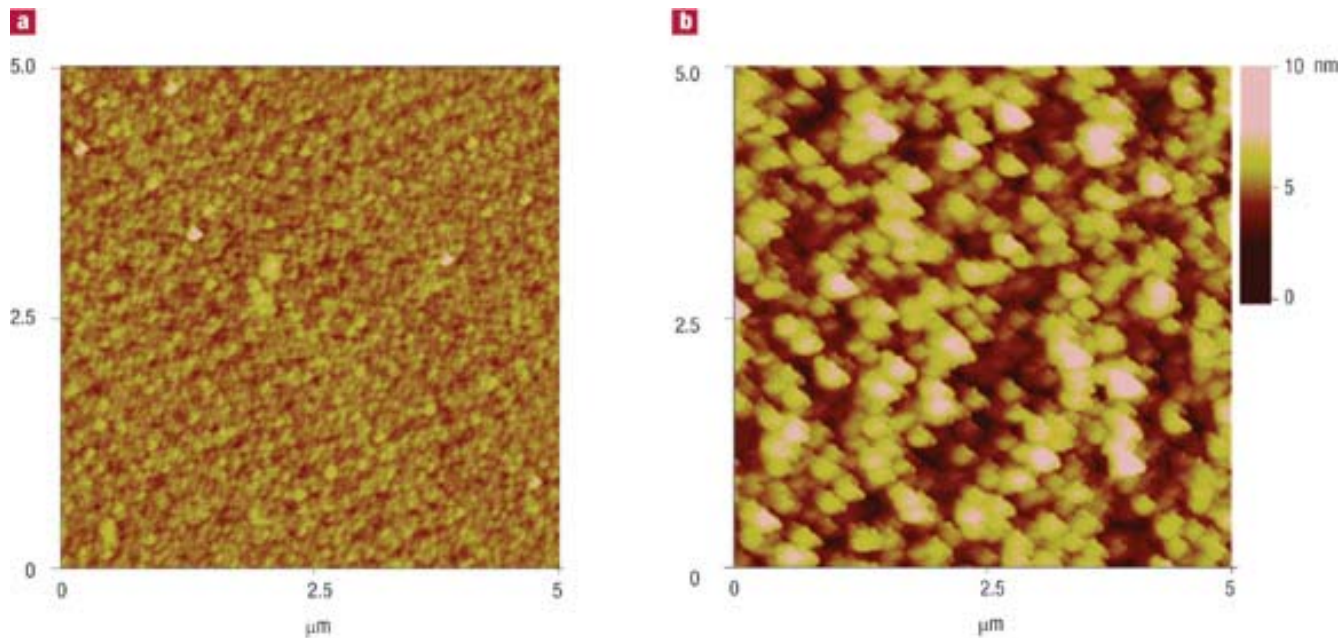

These films are much rougher than the idealized picture used to describe their formation.

Self-Assembled Surface Structures

- Pressure Assisted Organized Films:
Langmuir-Blodgett films
- Self-Assembled Chemisorbed Monolayers
- Vertical Self-Assembly with Lateral Disorder
- Self-Assembled Physisorbed Monolayers
 - a) van der Waals (only) lateral interactions*
 - b) Supramolecular Structure - non-covalent interactions*
- Structure Identification through Scanning Probe Imaging and Spectroscopy.

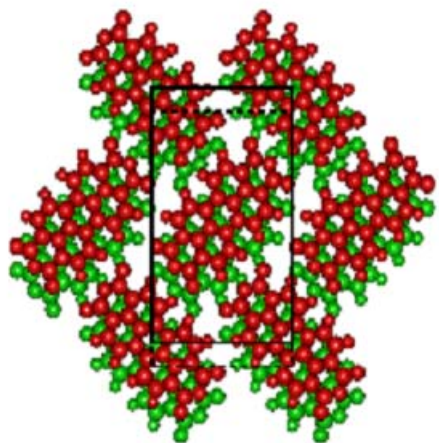

Xray structure of (102)
plane of α -PTCDA

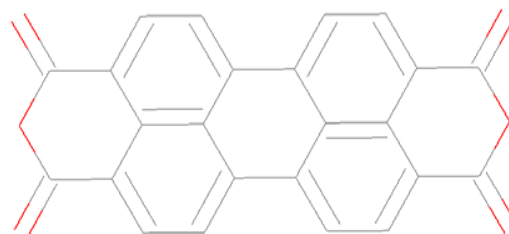
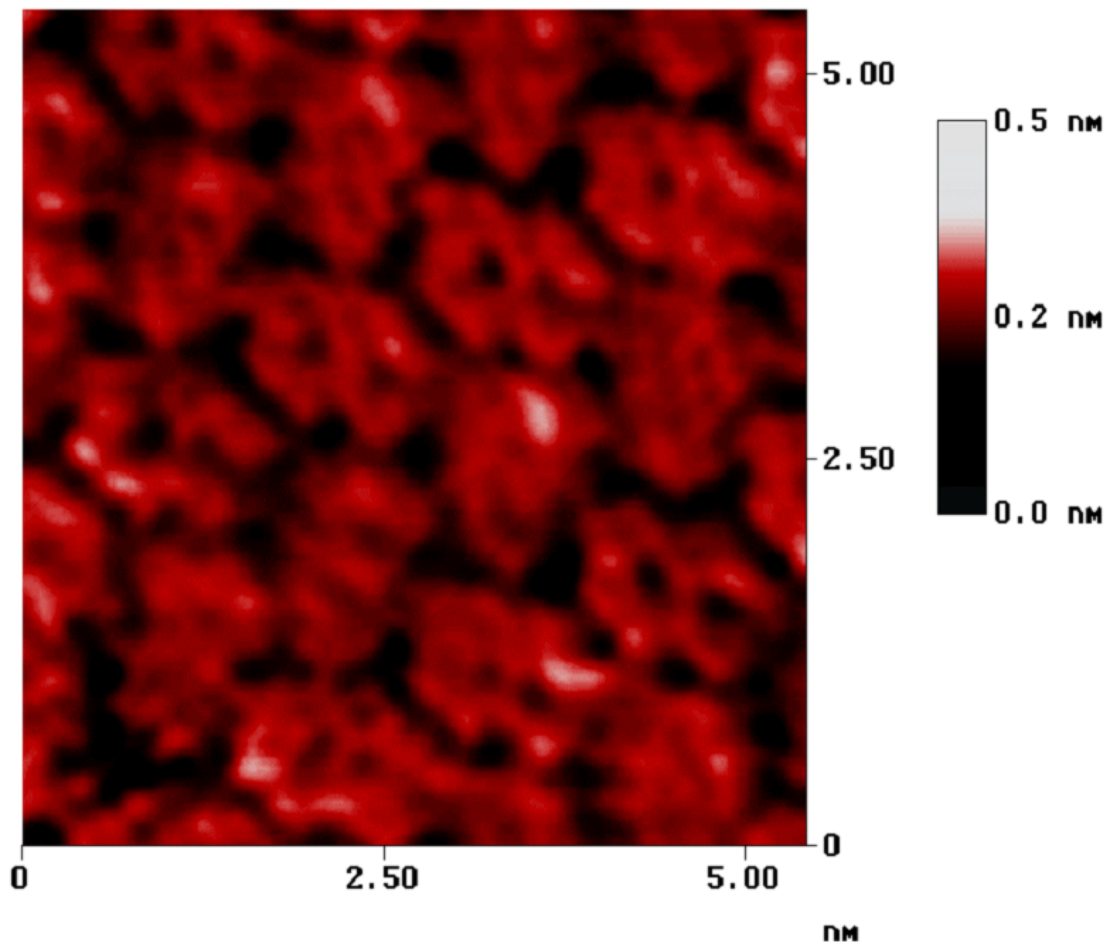

PTCDA on Graphite at 300 K in Air

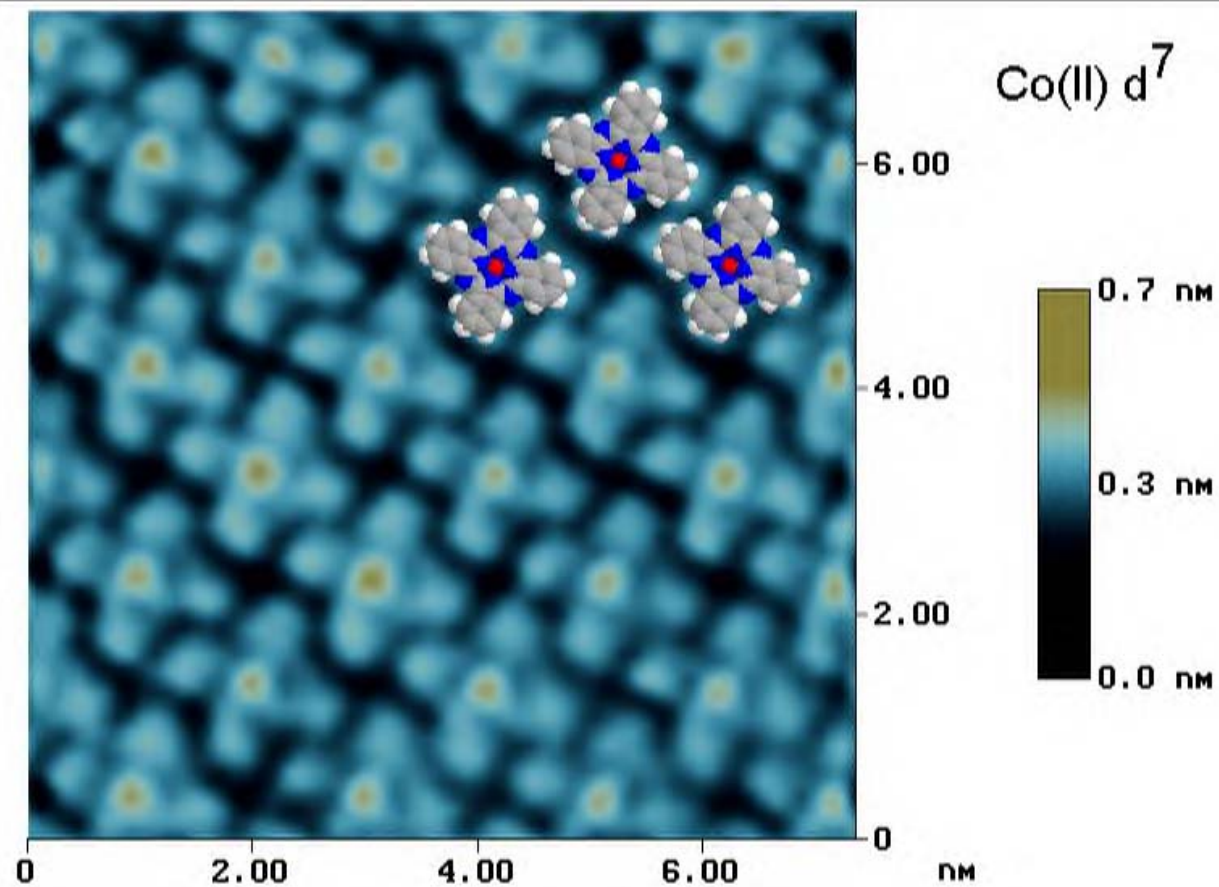

A monolayer of cobalt(II)phthalocyanine on Au(111):

Supramolecular Chemistry

- Molecules as building blocks. Supramolecular chemistry is chemistry that uses molecules rather than atoms as building blocks.
- In molecular chemistry, covalent and ionic bonds are used to assemble atoms into molecules. In the supramolecular case, supramolecular assemblies are held together by are weaker noncovalent interactions, such as hydrogen bonding, polar attractions, π - π stacking, van der Waals forces, and hydrophilic–hydrophobic interactions.
- Traditional chemistry \sim 1nm; Supramolecular chemistry \gg 1 nm (can be macroscopic).
- Supramolecular chemistry is essential for biology (life) and holds the key for bottom up formation of nanostructures and the creation of new materials.

Covalent Bonding and H bonding in the Structure of Deoxyribonucleic Acid (DNA)

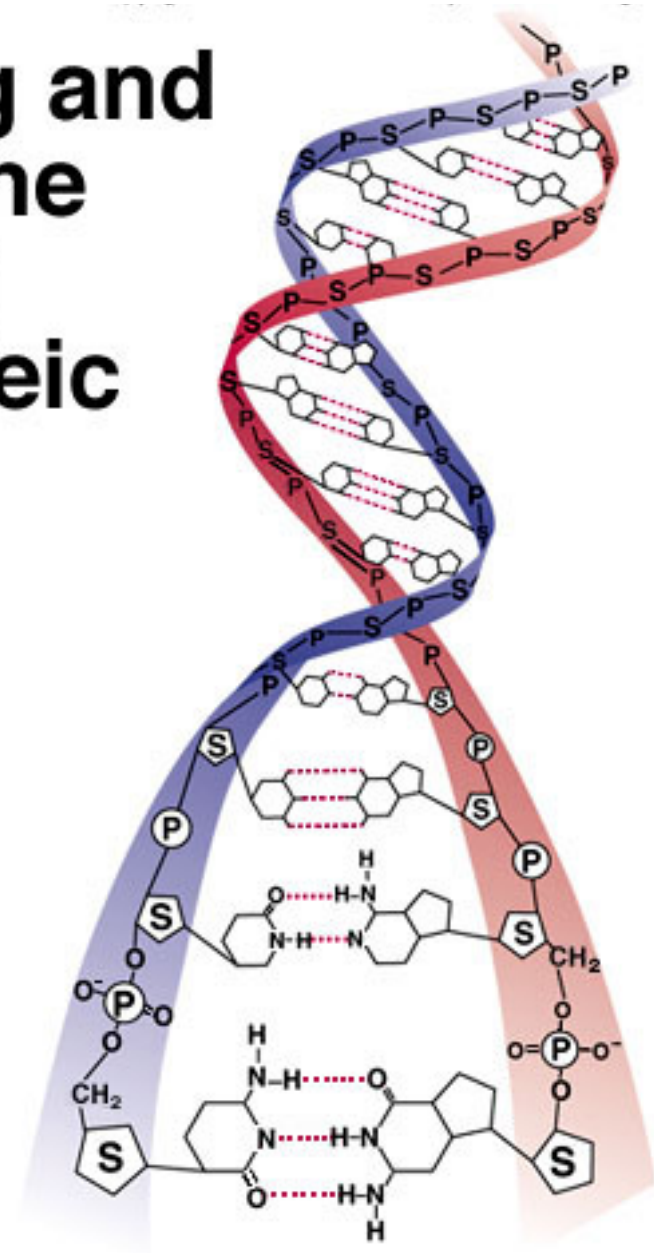

Nature is the Premier
Supramolecular
Chemist

Supramolecular design

3D hydrogen bonding

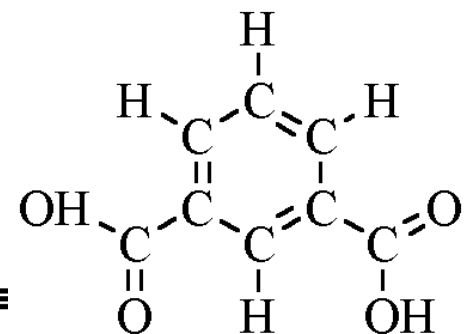
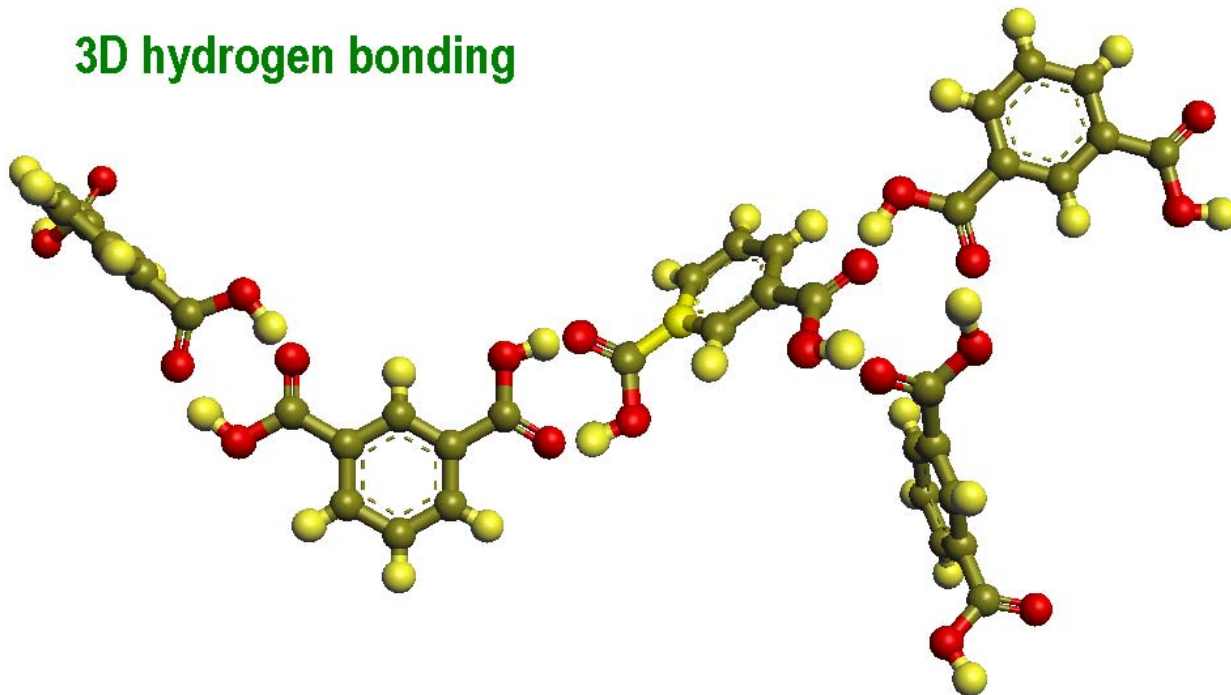

isophthalic acid

2D hydrogen bonding

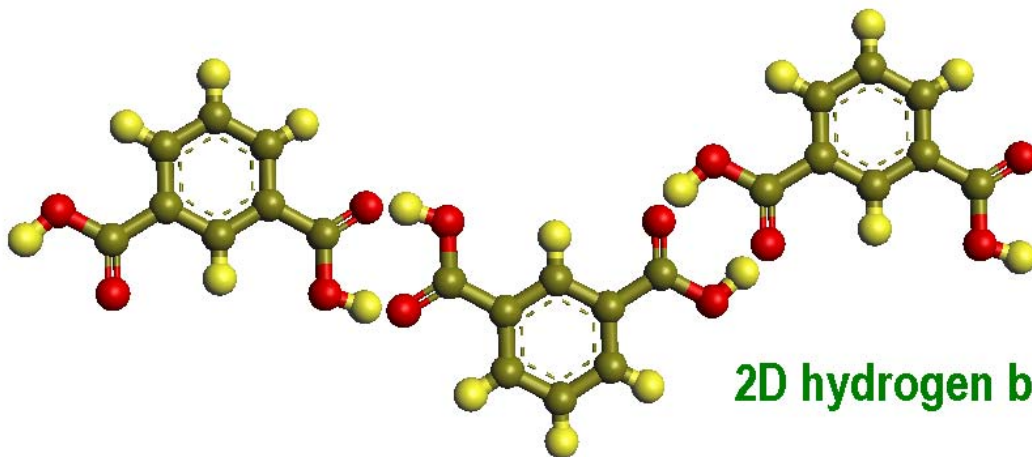

2D supramolecular architecture

- Use the idea of *weak interactions* producing designed structures borrowed from 3D.
- Dramatically enhance design control by removing a degree of freedom through *physisorption* on a support.
- Use a conducting support so that there is *image charge stabilization* of adsorbed species.
- This can work both from *solution and UHV* -- chemistry in a beaker or a deposition system.
- A key element for the development of self-assembling (bottom up) *nano-structured films*.

Image Charges at Conductor Surfaces

The parallel electric field at the surface of a conductor must vanish. Thus, the electric field lines at a metal surface are normal to the surface. One way to get the correct field solution without the work of solving Poisson's equation, is to use the image charge model:

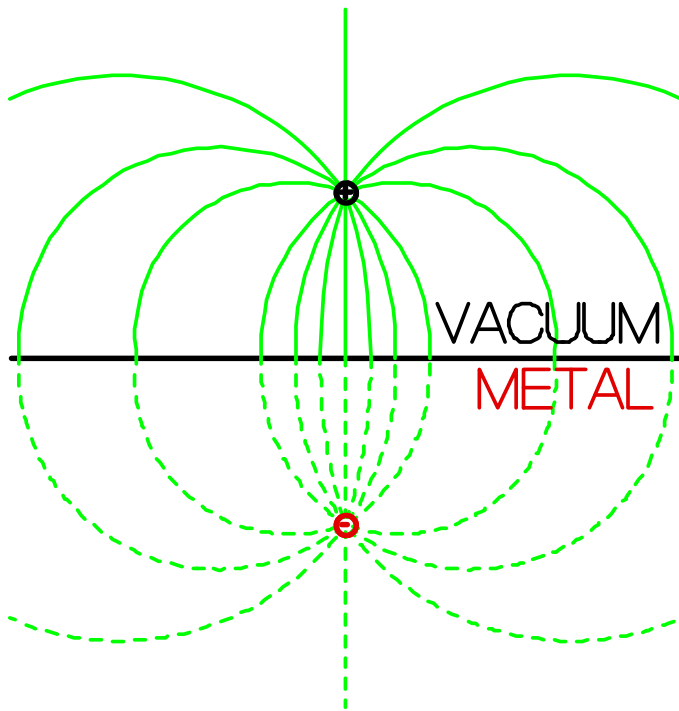

Thus, a dipole moment or partial charge on a molecule produces an opposite one across the conductor surface. These opposing dipoles or charges lead to attraction between the adsorbate and the surface. Even when the molecule is uncharged and has no permanent dipole moment!

Supramolecular Chemistry
{ Self-assembly } at the solid-
vapor interface.

Sample Preparation

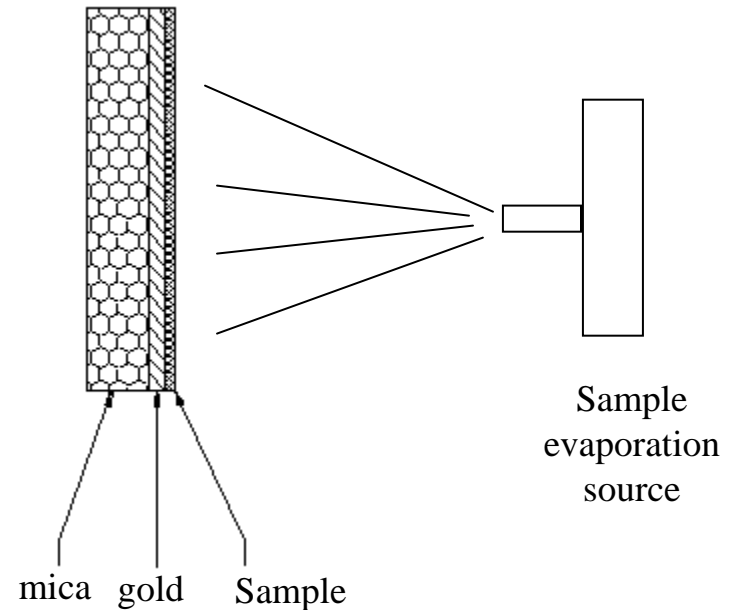
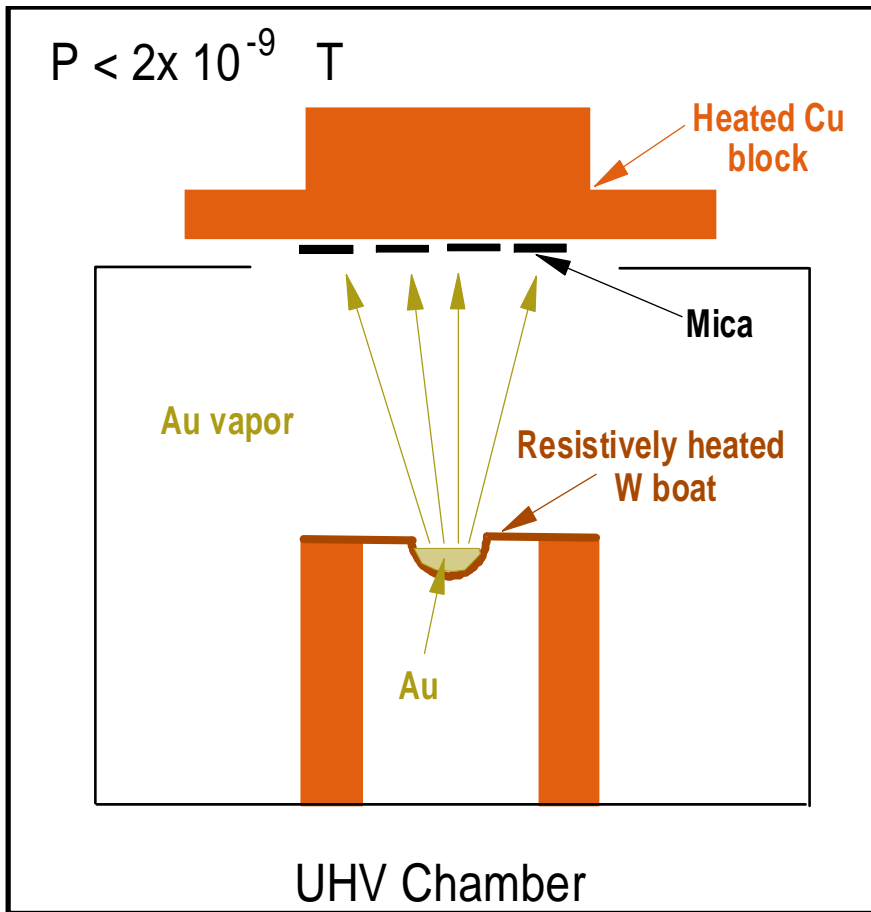

1. Gold is vapor deposited onto an atomically flat mica surface. The deposition rate is carefully controlled.

2. Single molecular samples are vapor deposited in the STM chamber onto the Au(111) surface. Typically, less than one monolayer is deposited

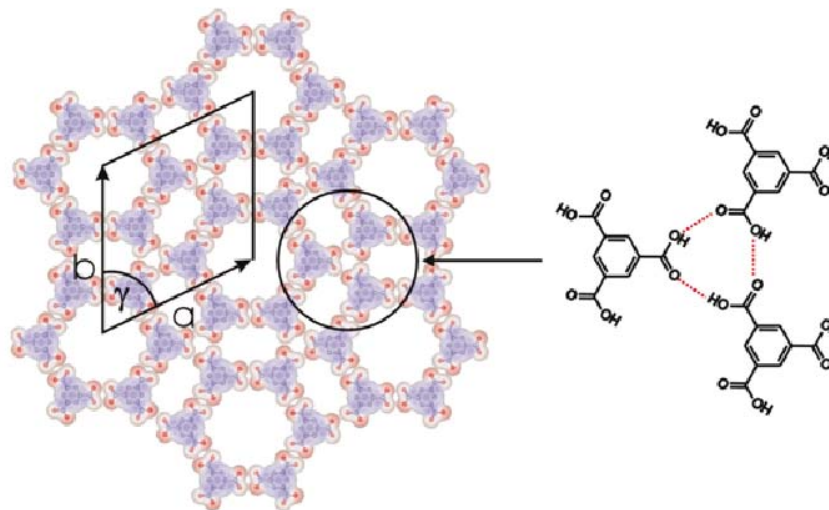
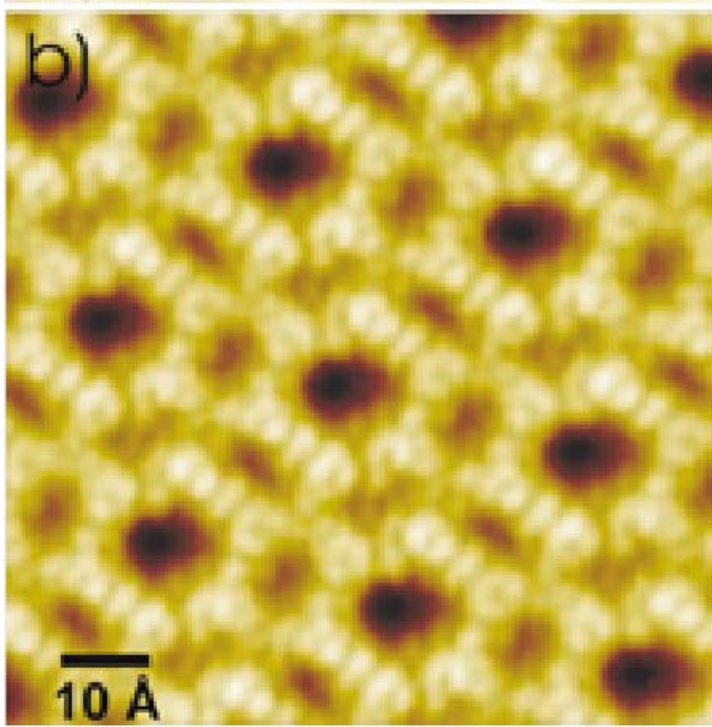
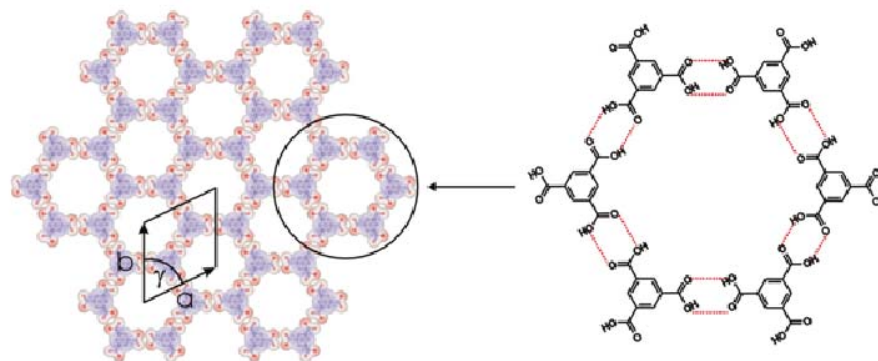
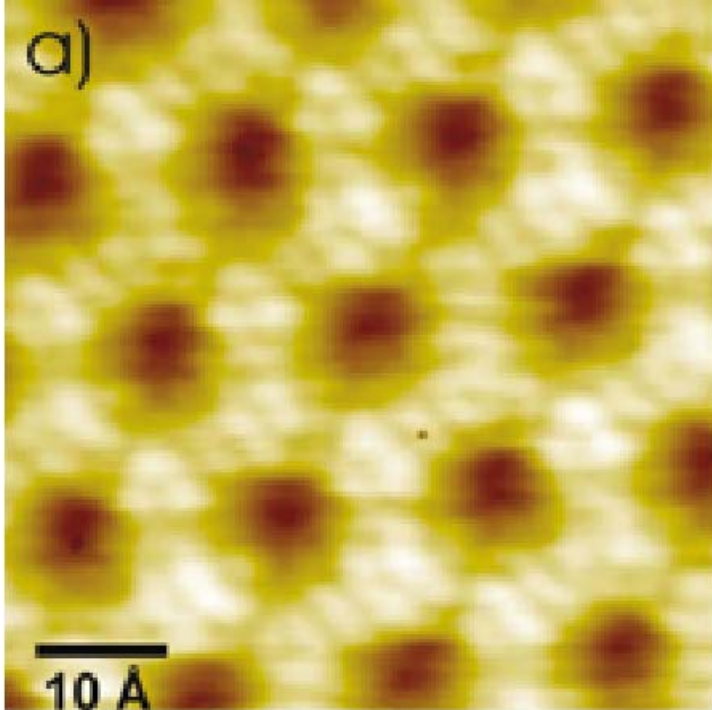

Griessl et al., *Single Mol.* 3 (2002) 25

from UHV on graphite

Design a bimolecular 2D self-assembled structure from the vapor

- Use organic semiconductors to make the material interesting.
- F...H interactions should be the basis for a good synthon
- Need thermally stable compounds that can be vapor deposited.
- Very low vapor pressure (at room T) materials best so they stick to the substrate by physisorption.
- Molecule-substrate interaction must NOT result in covalent bond.
- Molecule-molecule interaction must NOT result in covalent bond.
- Substrate should be a metal to maximize non-covalent interactions.
- Use Scanning Tunneling Microscopy (STM) to characterize these interface structures.
- Need to label the components somehow so we can tell them apart.

The Molecules of Choice

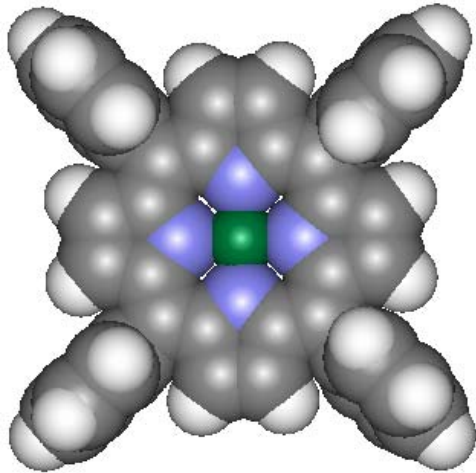

Ni(II) tetraphenylporphyrin

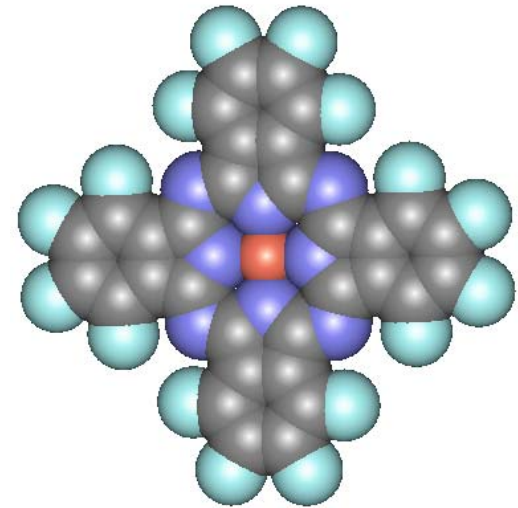

Co(II) perfluoro-phthalocyanine

Use Au(111) as the substrate

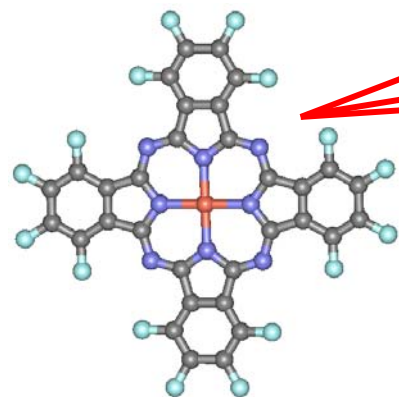
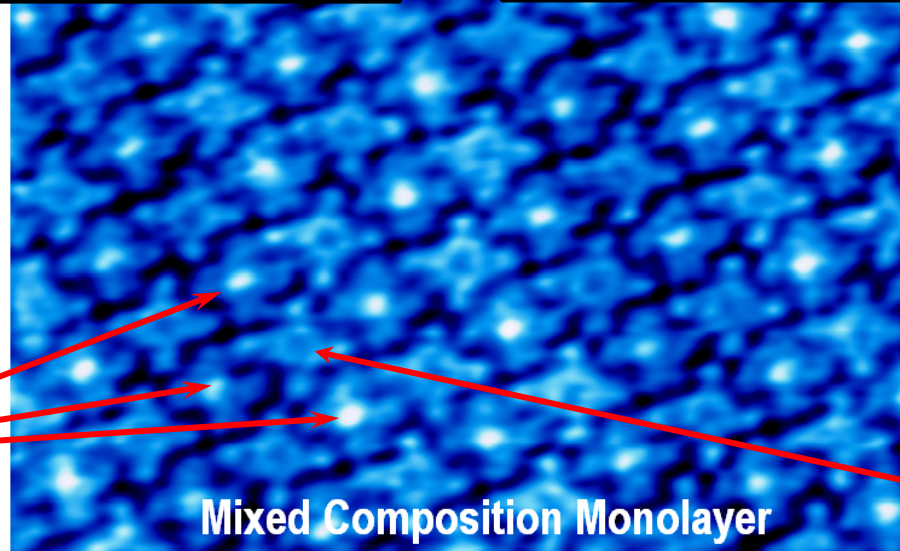
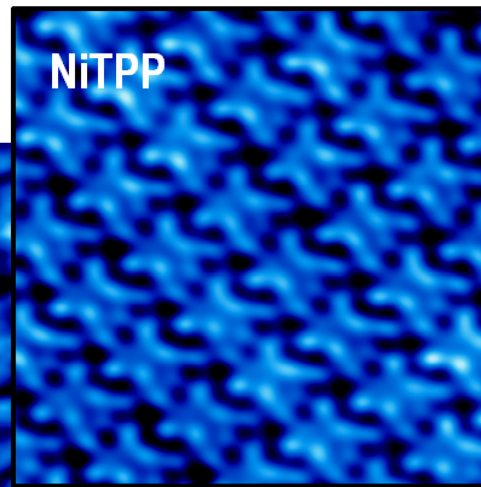
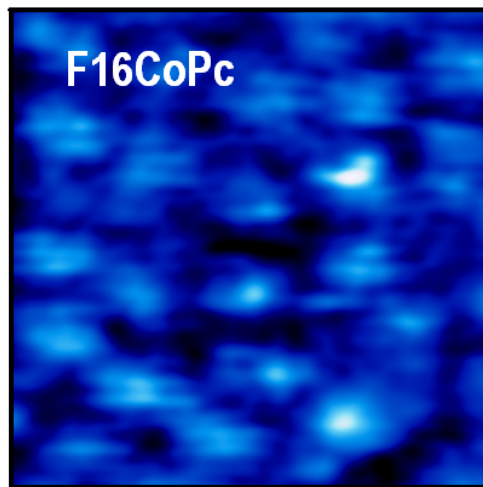

F16CoPc

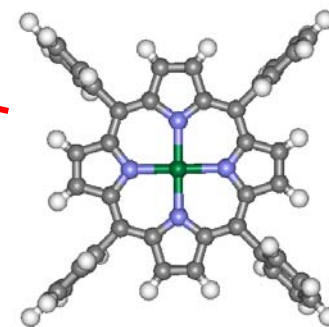

NiTPP

Hipps et al. J. Am. Chem. Soc. 124 (2002) 2126.

-0.40V & 0.10 nA

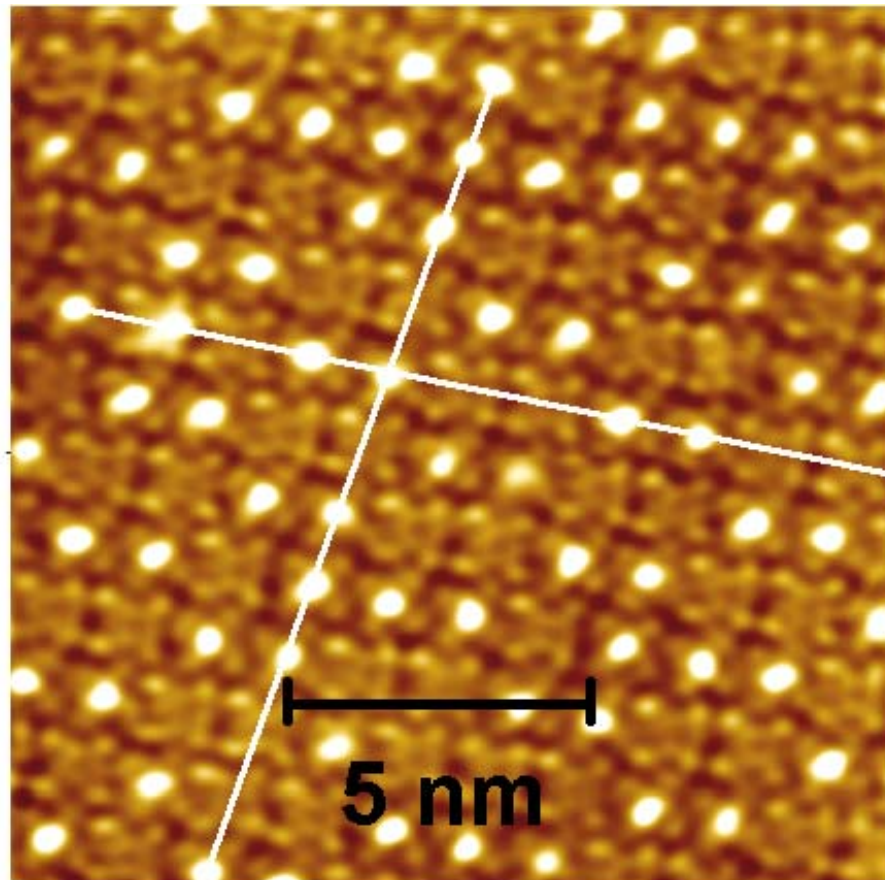

CoPc:NiTPP (1:2) [7:5]

-0.40V & 0.30 nA

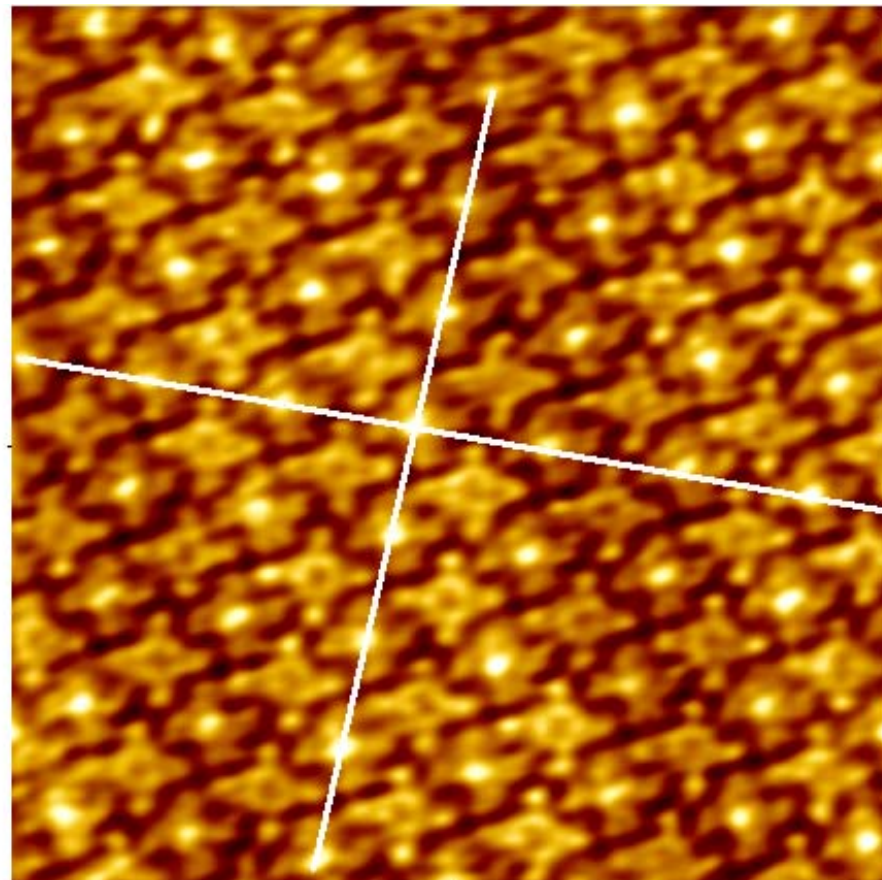

F₁₆CoPc:NiTPP (1:2)

Self-assembly at the solid-
solution interface.

Van der Waals interactions in the plane can produce self-assembling films for physisorbed systems.

Tetradecanol
[CH₃(CH₂)₁₃OH] on
Graphite

Claypool et al., *J. Phys. Chem. B* 101
(1997) 5978

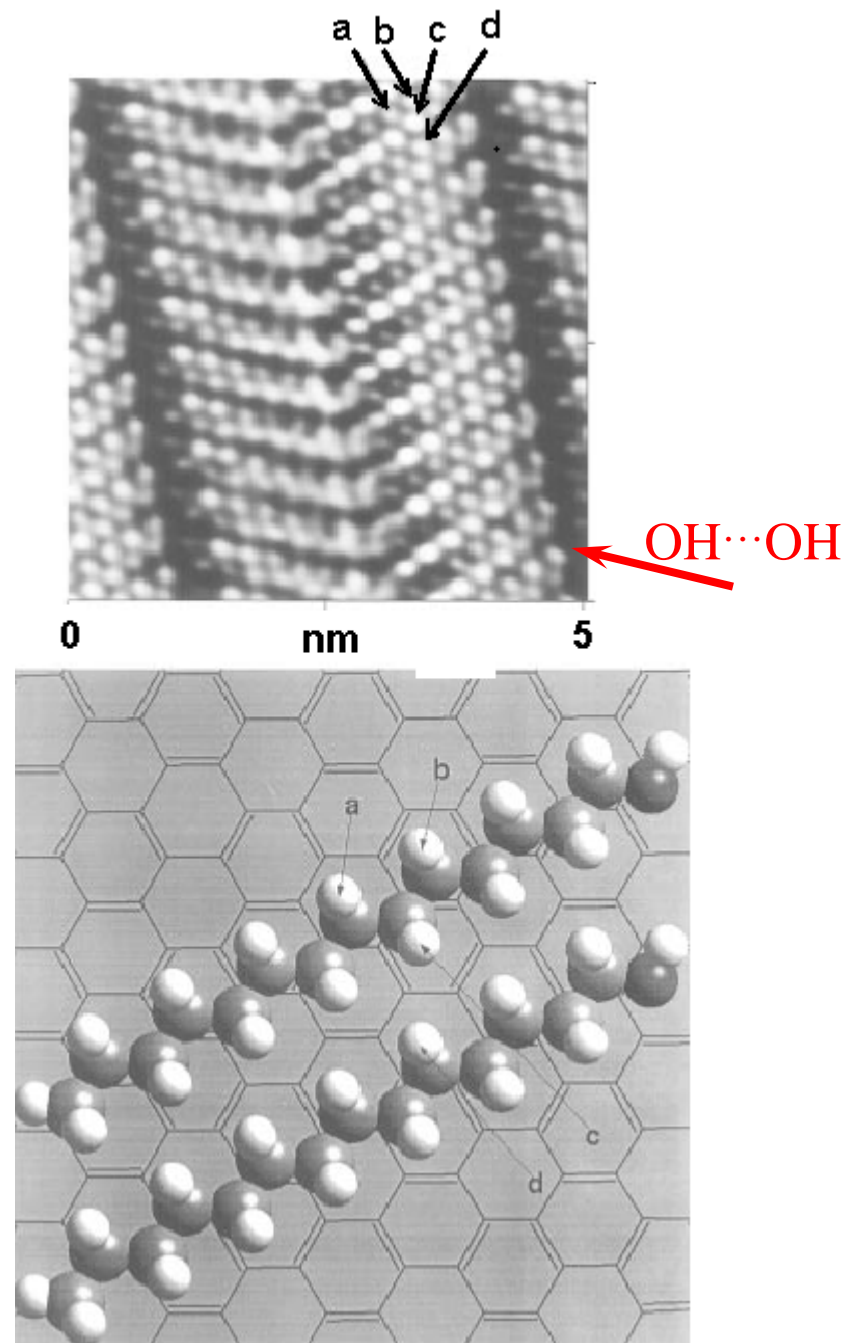

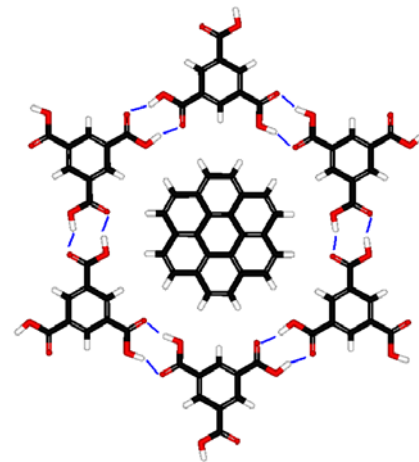
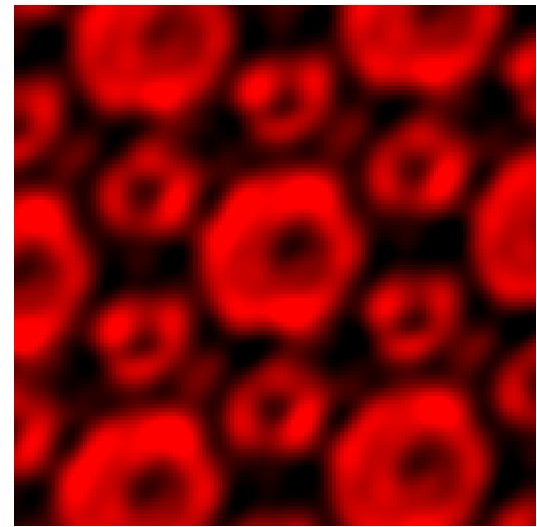
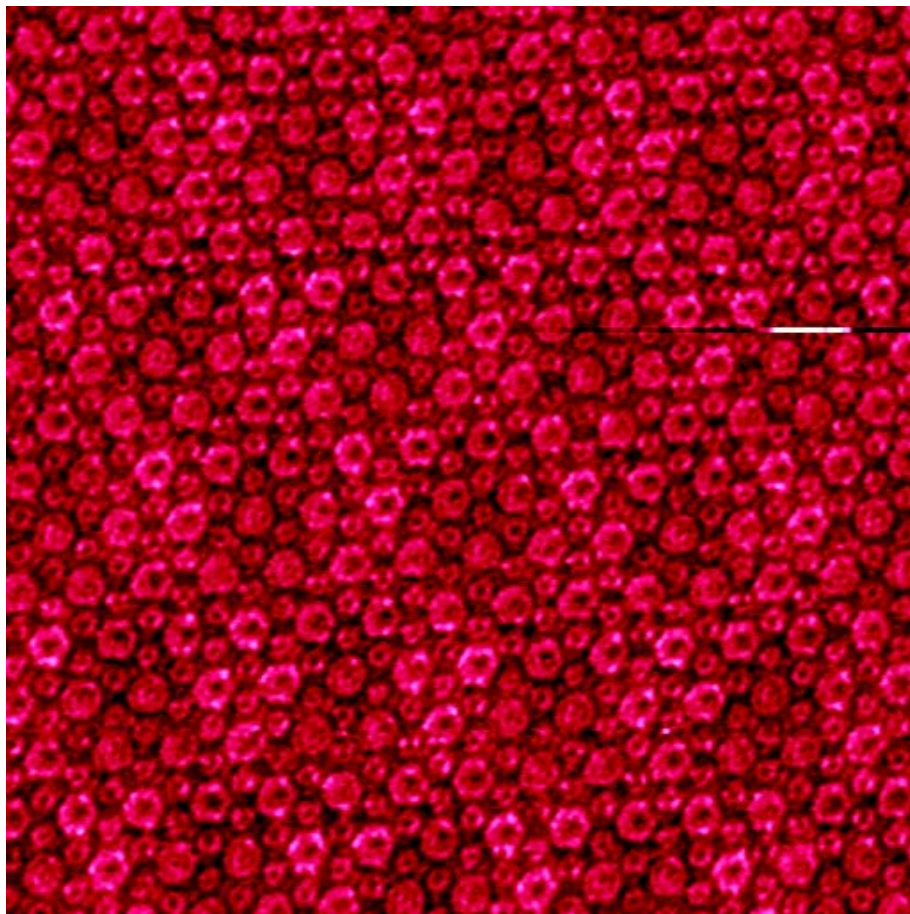

25x25 nm constant current STM image of the interface between **graphite** and a solution of TMA, coronene, and heptanoic acid. The insert is a correlation average.

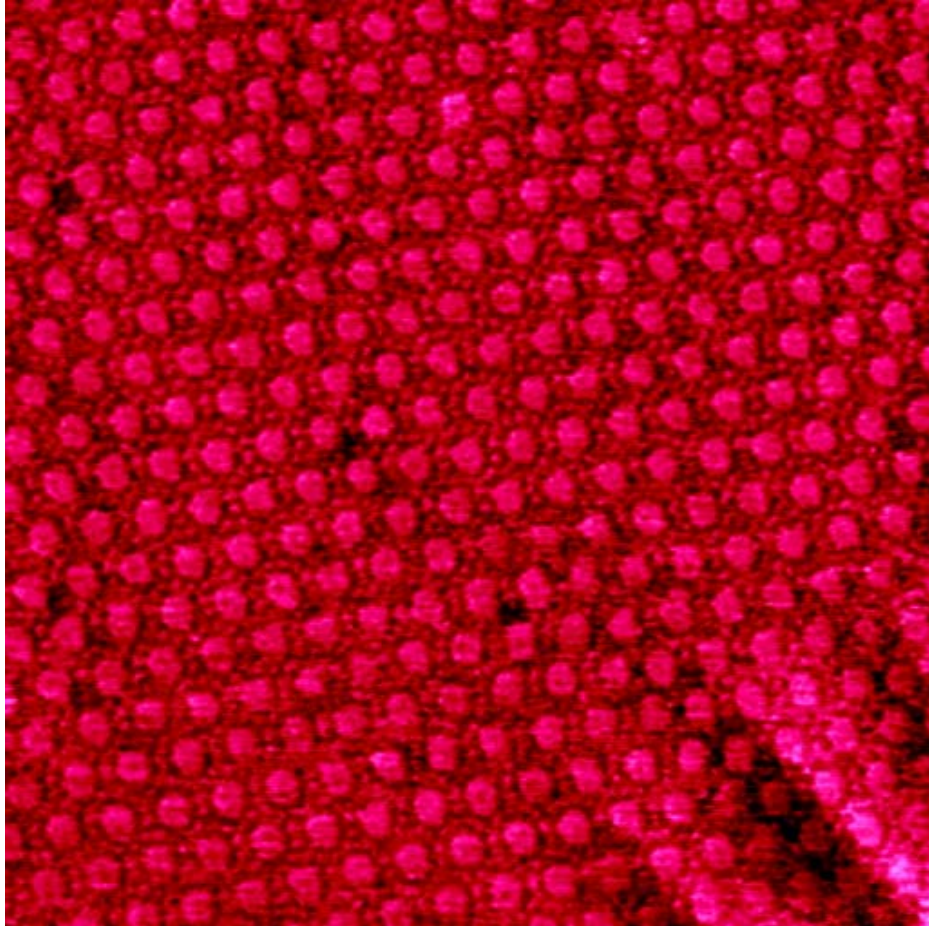

25x25 nm STM image of the interface between Au(111) and a solution of coronene in heptanoic acid. 700 pA and -600 mV sample bias

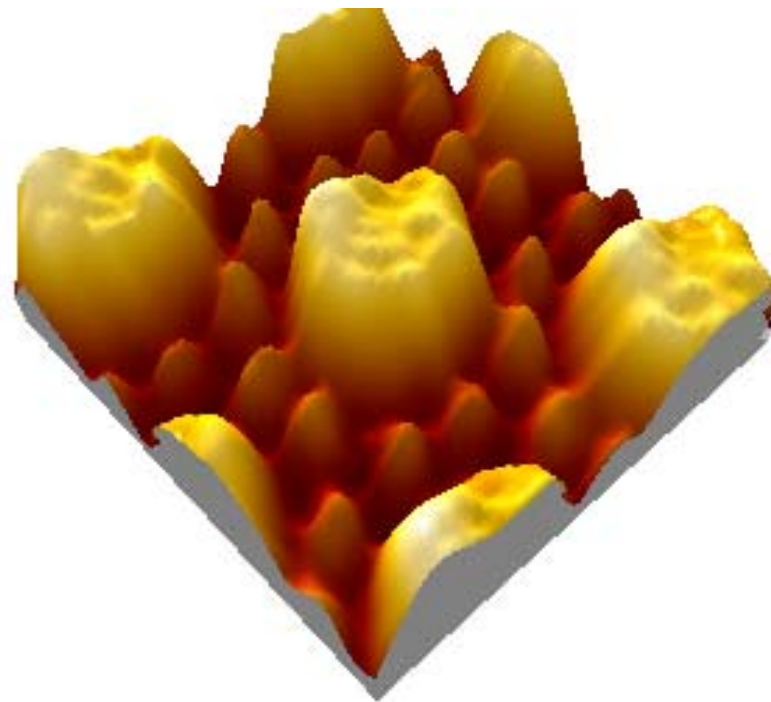

3D view of a correlation average STM image. Z range is about 0.3 nm

Supramolecular Structures of Coronene and Alkane Acids at the Au(111) - Solution interface: A Scanning Tunneling Microscopy Study. Brett Gyarfas, Bryan Wiggins, Monica Zosel, and K. W. Hipps. *Langmuir*; 2004; ASAP Article; DOI: 10.1021/la047726j.

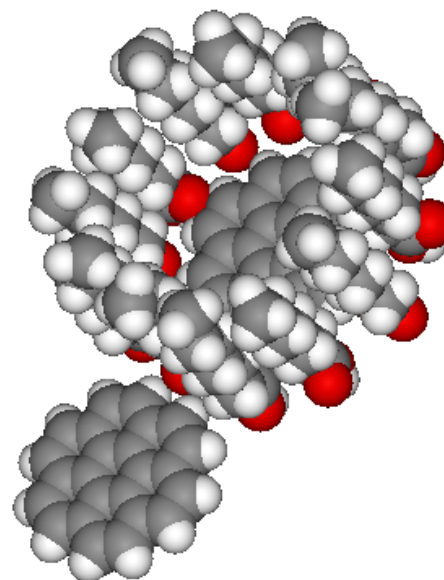
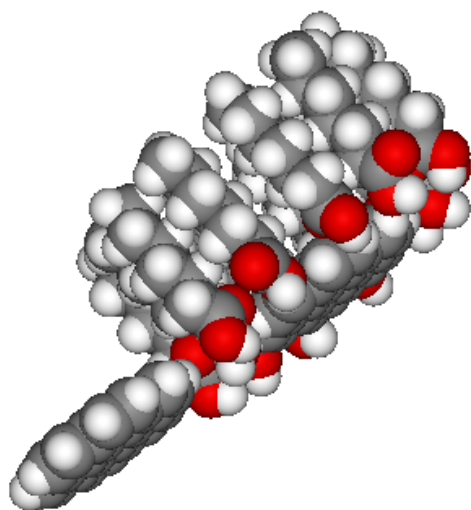
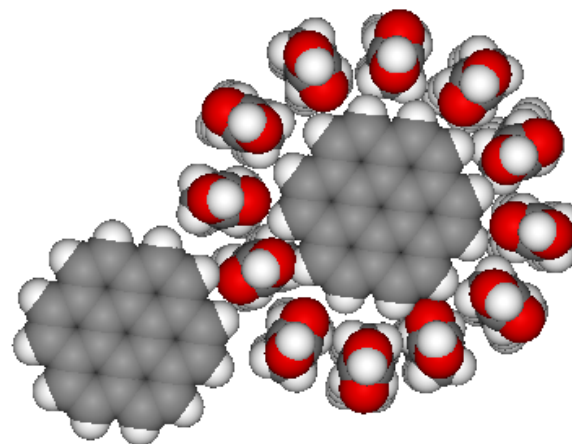
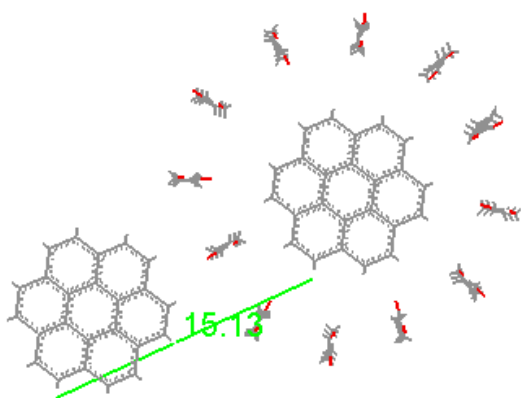

CPK models of heptanoic acid and coronene

Self-Assembled Surface Structures

- Pressure Assisted Organized Films:
Langmuir-Blodgett films
- Self-Assembled Chemisorbed Monolayers
- Vertical Self-Assembly with Lateral Disorder
- Self-Assembled Physisorbed Monolayers
 - a) van der Waals (only) lateral interactions*
 - b) Supramolecular Structure - non-covalent interactions*
- Structure Identification through Scanning Probe Imaging and Spectroscopy.

Scanning Probe Microscopy (SPM)

Scanning Tunneling Microscopy (STM)

Scanning Tunneling Spectroscopy (STS)
Orbital Mediated Tunneling Spectroscopy (OMTS)
Inelastic Electron Tunneling Spectroscopy (IETS)

Scanning (or Atomic) Force Microscopy (SFM or AFM)

Contact Mode
Tapping Mode (intermittent contact)
Nanomechanical Properties
Magnetic Force
Chemical Force
Scanning Kelvin Probe
MORE.....

Near Field Scanning Optical Microscopy (NSOM)

Scanning Thermal Microscopy (SThM)

Computer: drives x,y scan; saves data; generates images.

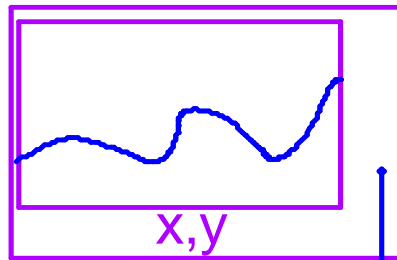

Fine Position & Scanning are usually performed with one or more piezo-electric elements.

Coarse Approach

Feedback System: holds interaction between tip and surface constant.

Feedback Control

Error
Signal

Interaction Sensing

Fine Position

Tip

Tip-Surface Interaction

Surface

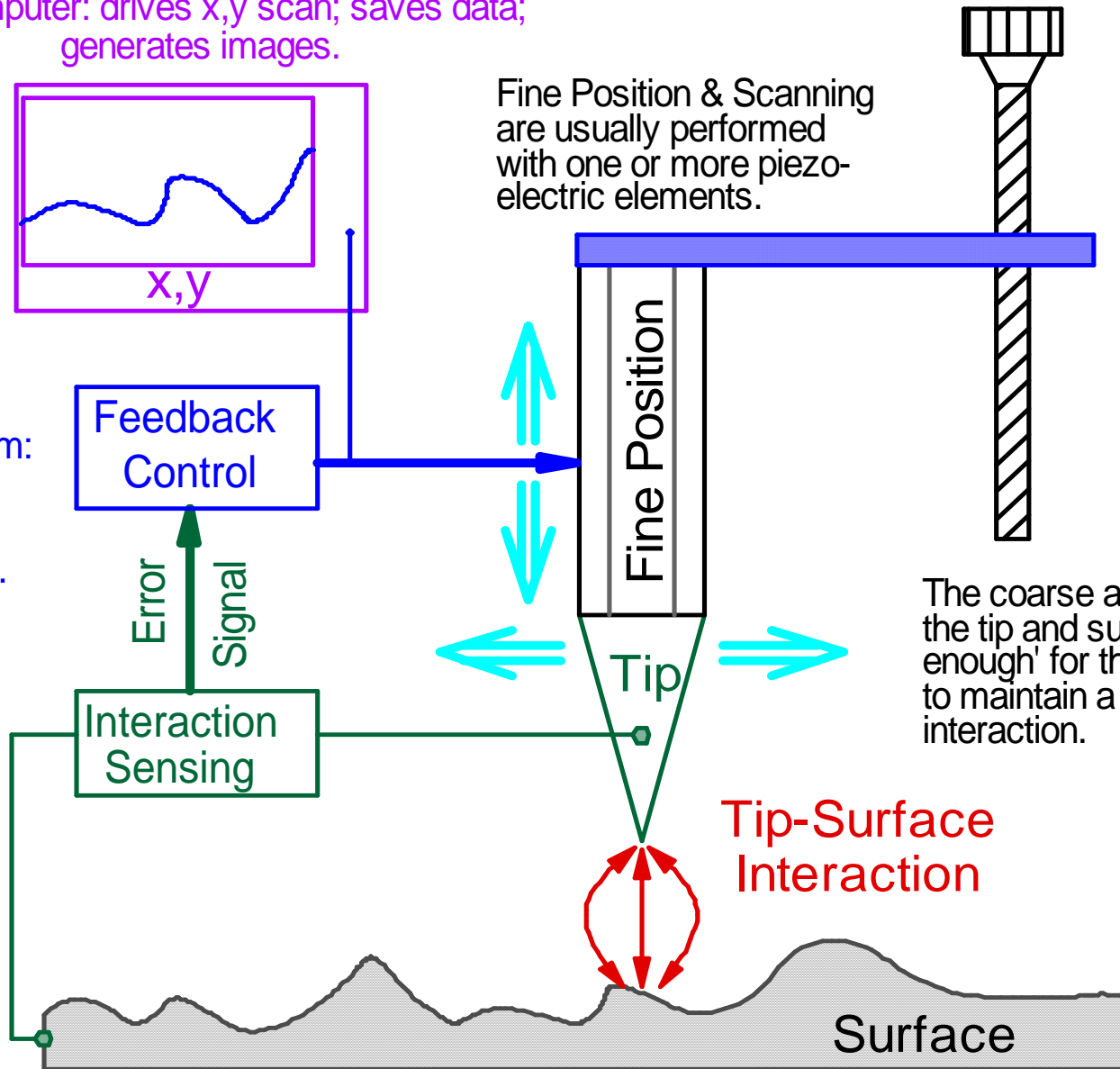

Scanned Sample SPM

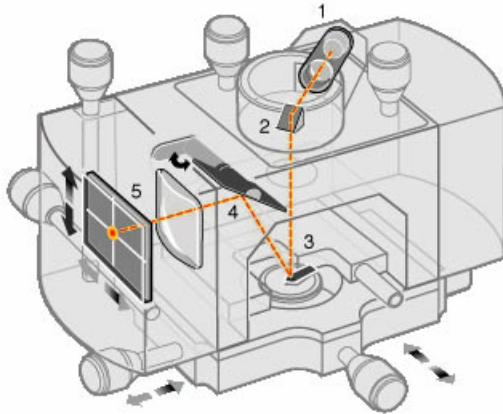

Labels:

1. Laser
2. Mirror
3. Cantilever
4. Tilt mirror
5. Photodetector

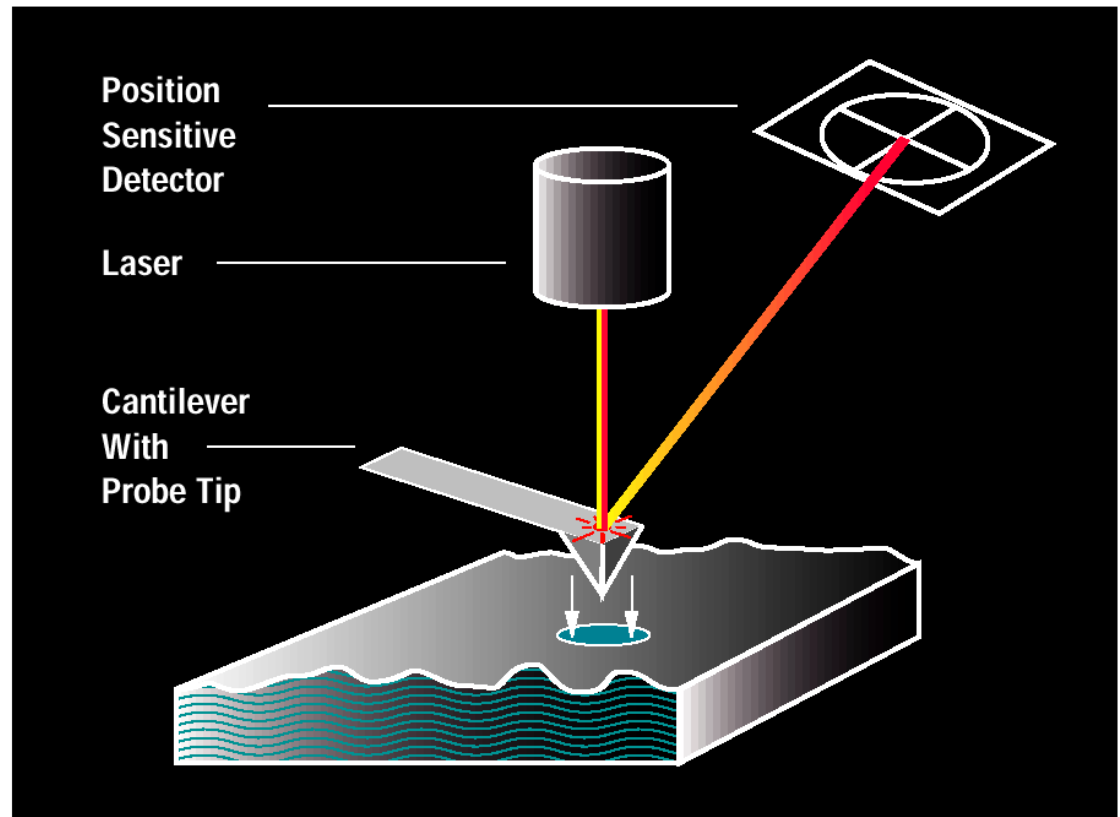

Force sensing cantilever with optical lever detection

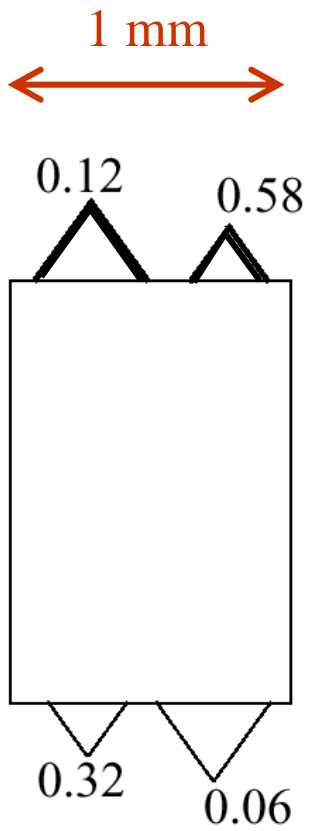

Four Si_3N_4 cantilevers on a single glass chip. Force constants in Newtons/m. Side Wall angles = 35° .

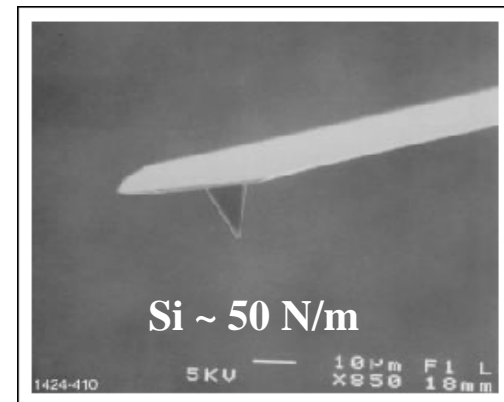
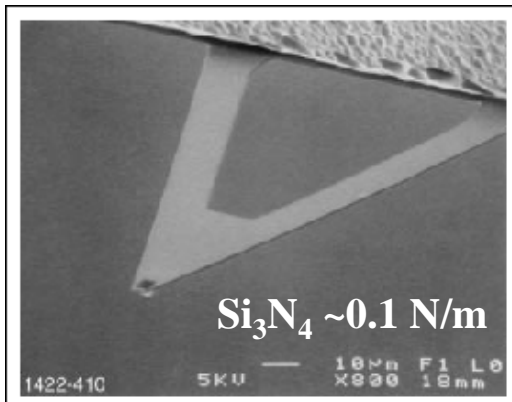
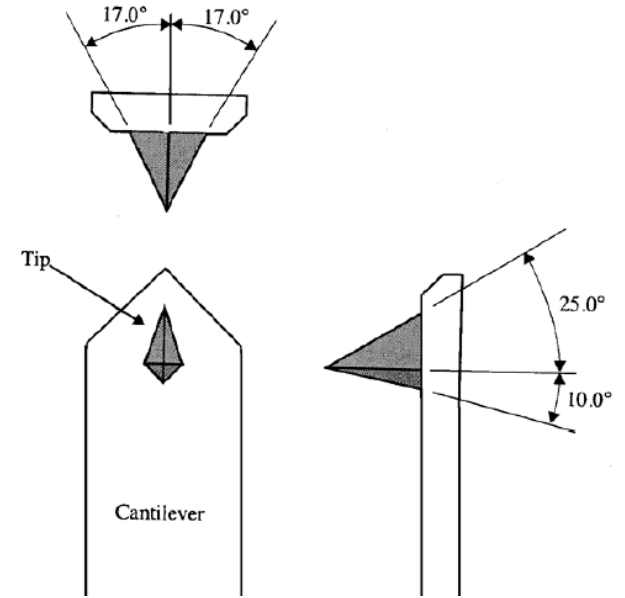

Force Calibration Plot

← Extending
→ Retracting

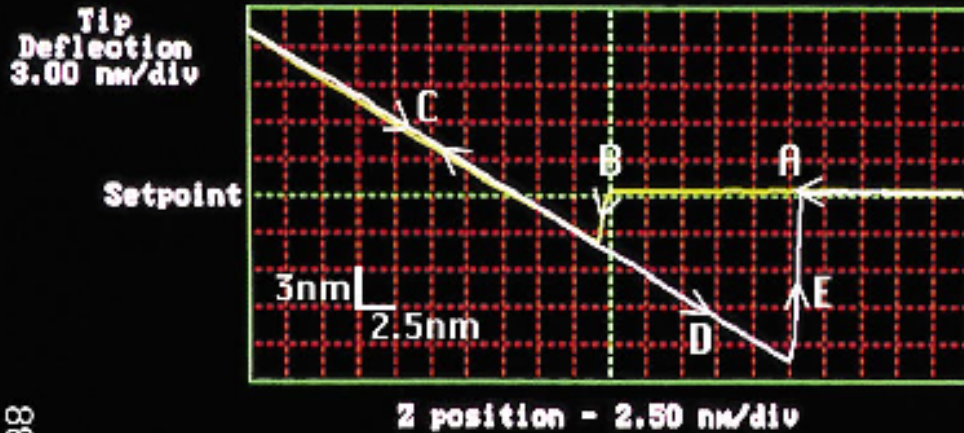

1438

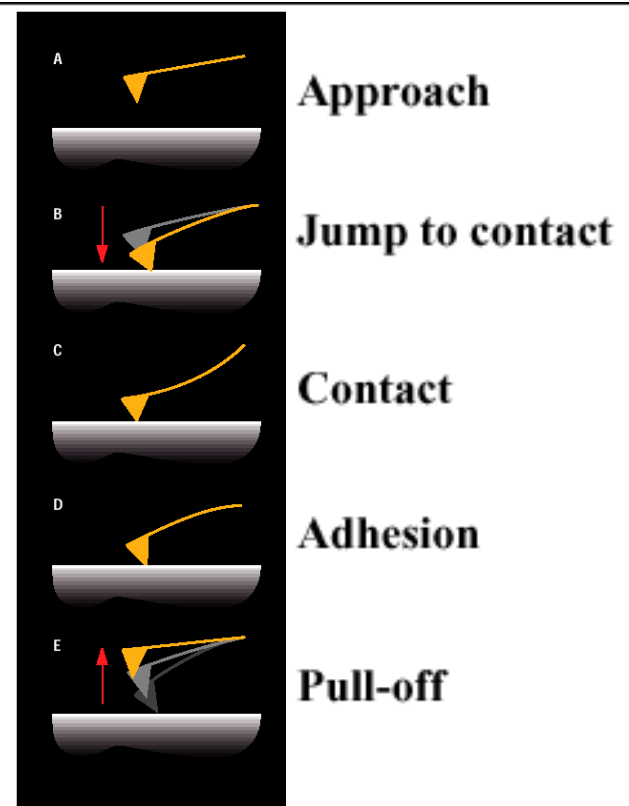

Tip-Sample interaction and resulting force curve

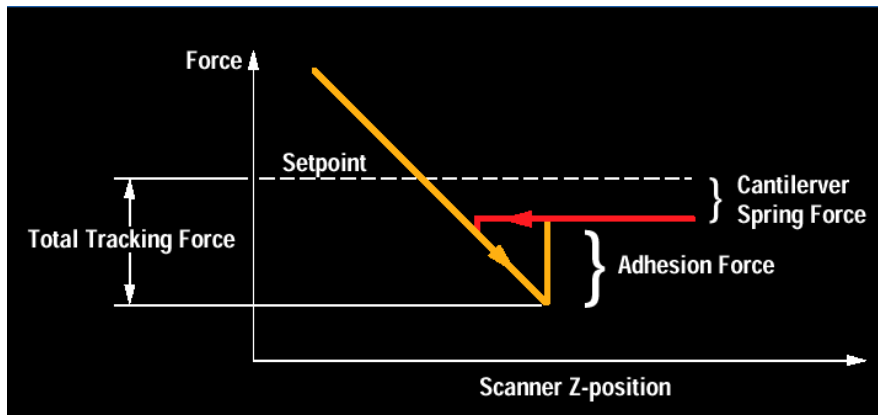

$$F = -k\Delta x$$

a 1 nm deflection is:

$$0.05 \text{ N/m} \times 1 \text{ nm} = 0.05 \text{ nN}$$

OR

$$100. \text{ N/m} \times 1 \text{ nm} = 100. \text{ nN}$$

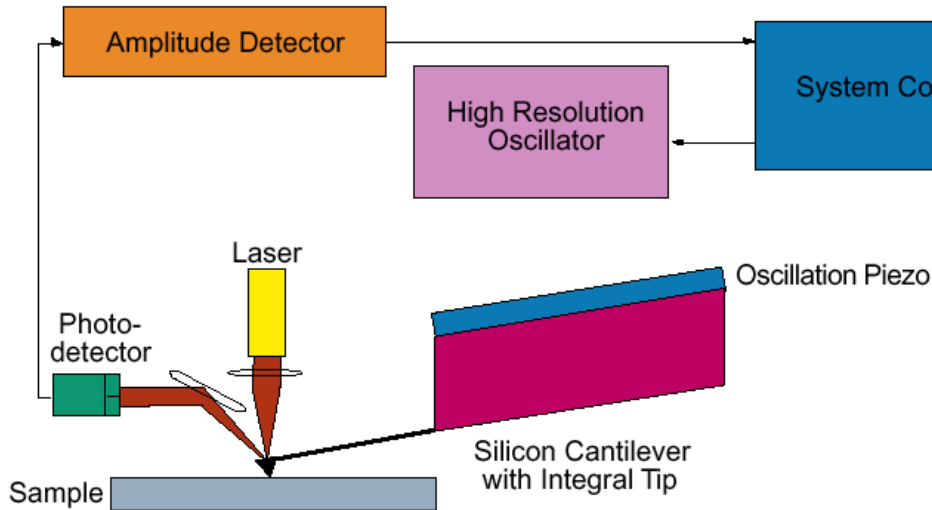
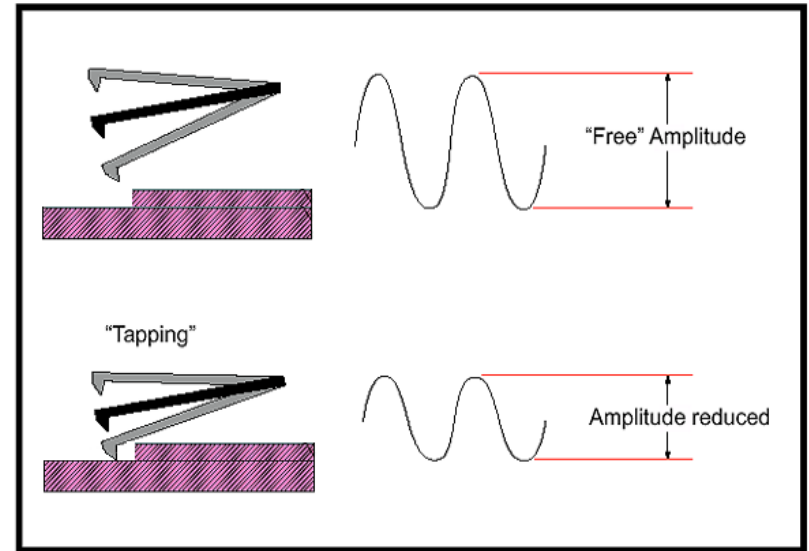
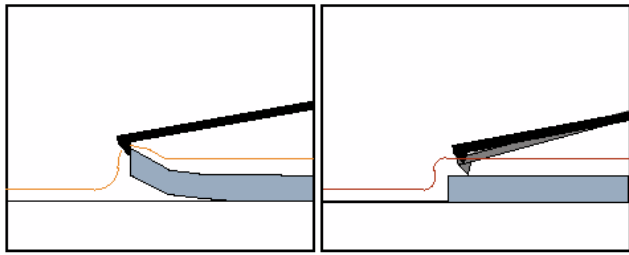

Intermittent Contact (Tapping Mode) AFM

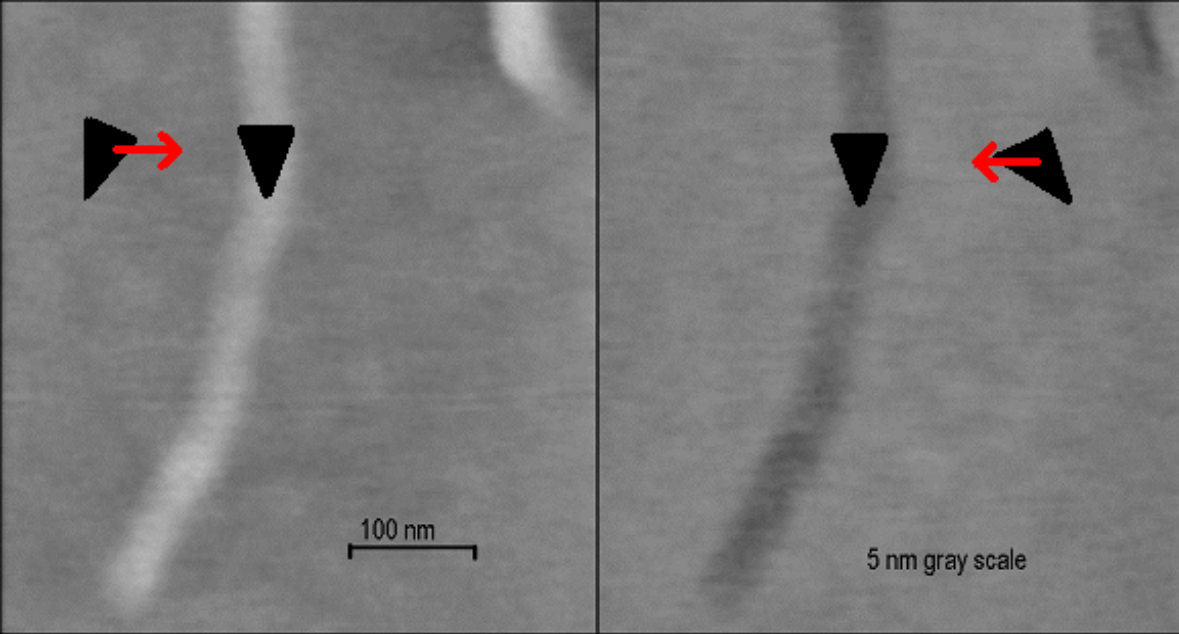

Contact Mode: Trace

Contact Mode: Retrace

In contact mode, the frictional force changes that occur as the tip moves from the ‘sticky’ mica surface to a ‘greasy’ virus surface cause the cantilever to change tilt angle. This change in tilt angle couples with the vertical deflection signal and a *false height* is observed. *Changing scan angle will change the apparent heights.*

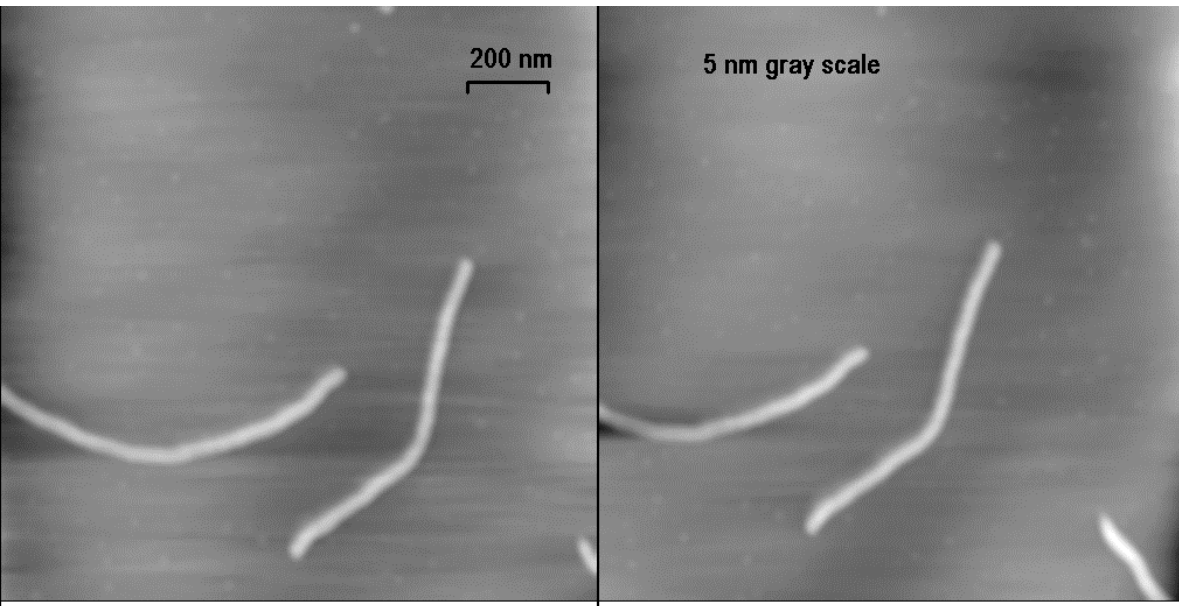

Tapping Mode: Trace

Tapping Mode: Retrace

Since there are almost no frictional forces associated with intermittent contact (tapping) mode, the direction of scan is irrelevant and the same height is observed independent of scan direction. *How real the height is depends on the differential hardness of the surfaces.*

$$F_{Tip} = 4/3 E^* (R_{Tip})^{1/2} (i)^{3/2} + F_{adh}$$

Derjaguin, Muller, and Toporov (DMT) model

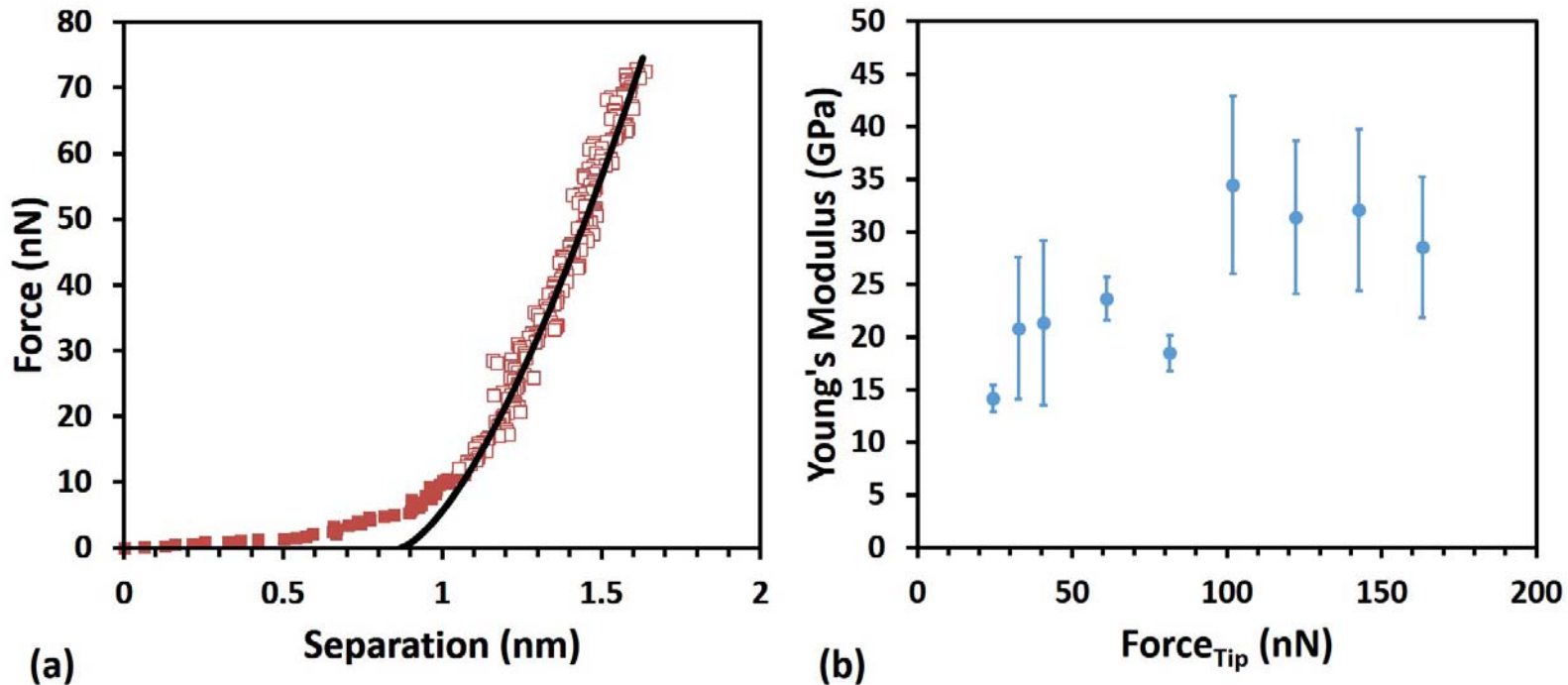

FIG X5. Young's modulus determination and results on highly ordered pyrolytic graphite (HOPG). (a) Retract curve of an example ramp on HOPG with zero separation set at the point of maximum adhesion, s_m (DMT model). 1 Hz ramp, 750 mV trigger threshold, 200 nm ramp size, 2048 pts per line, 32 degree x-rotate. The red squares show the retract curve. The red boxes show the top 80 percent fit region. The black line shows the DMT fitted curve. (b) Young's modulus values on HOPG as a function of maximum tip force (F_{Tip}).

Scanning Probe Microscopy (SPM)

Scanning Tunneling Microscopy (STM)

Scanning Tunneling Spectroscopy (STS)
Orbital Mediated Tunneling Spectroscopy (OMTS)
Inelastic Electron Tunneling Spectroscopy (IETS)

Scanning (or Atomic) Force Microscopy (SFM or AFM)

Contact Mode
Tapping Mode (intermittent contact)
Lateral Force
Magnetic Force
Chemical Force
Scanning Kelvin Probe
MORE.....

Near Field Scanning Optical Microscopy (NSOM)

Scanning Thermal Microscopy (SThM)

Computer: drives x,y scan; saves data; generates images.

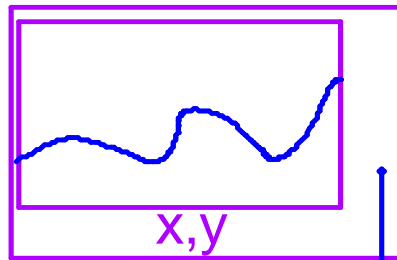

Fine Position & Scanning are usually performed with one or more piezo-electric elements.

Coarse Approach

Feedback System: holds interaction between tip and surface constant.

Feedback Control

Error
Signal

Interaction Sensing

Fine Position

Tip

Tip-Surface Interaction

Surface

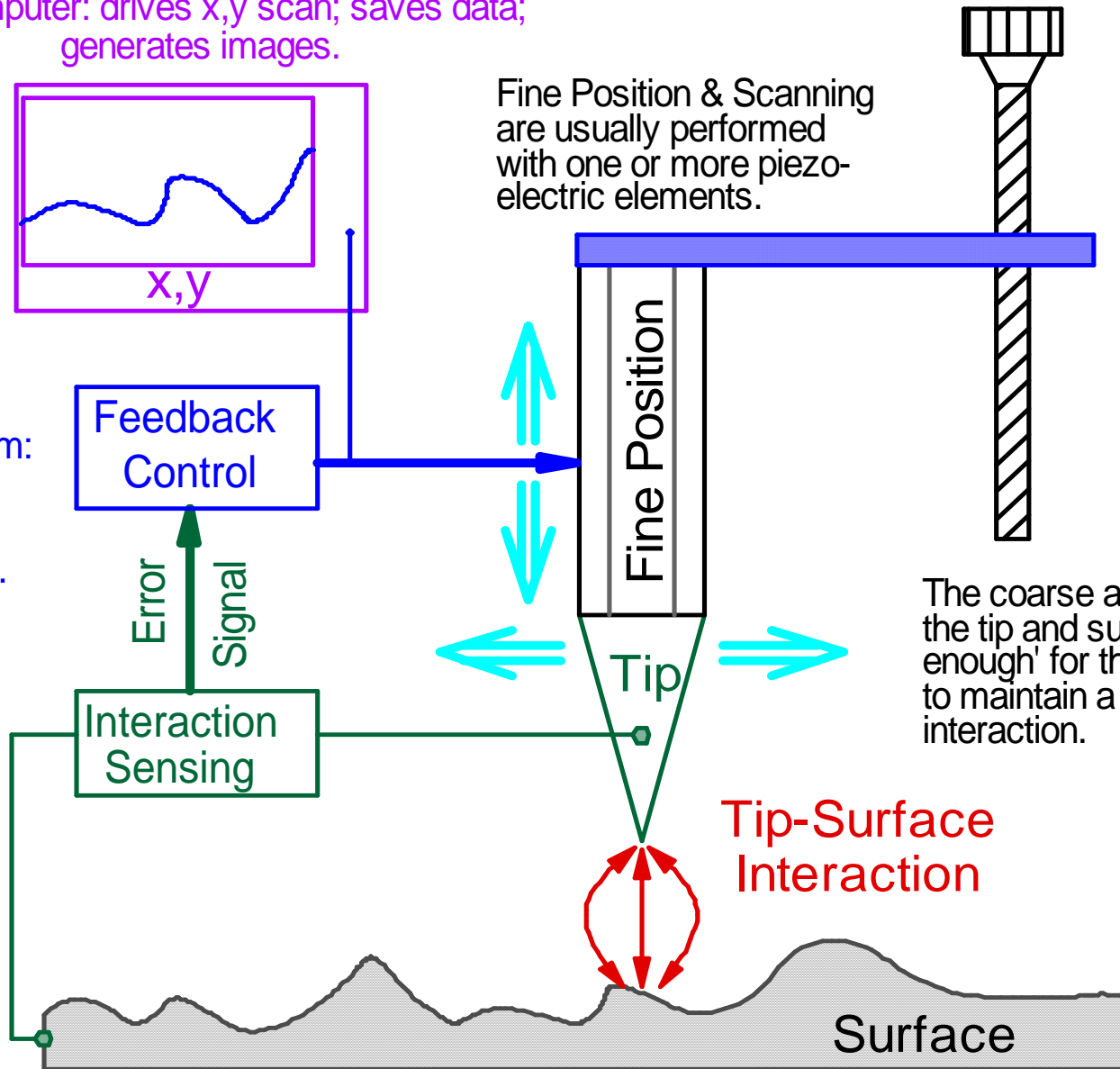

Electron Tunneling: Our Probe of the Nano-World

or

*We use a non-classical
phenomena to probe a non-
classical world*

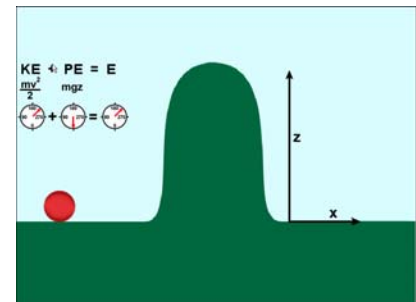

Tunneling in an M-I-M' Diode and an STM

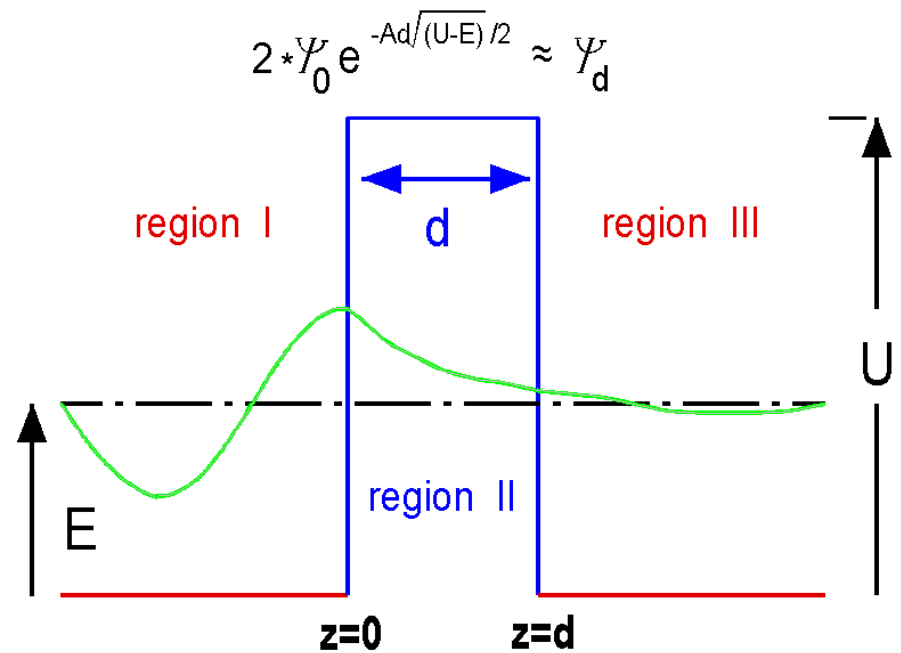
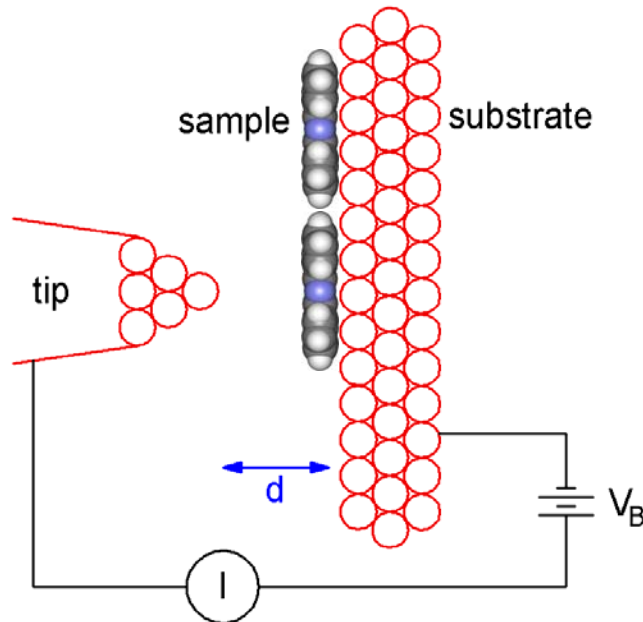
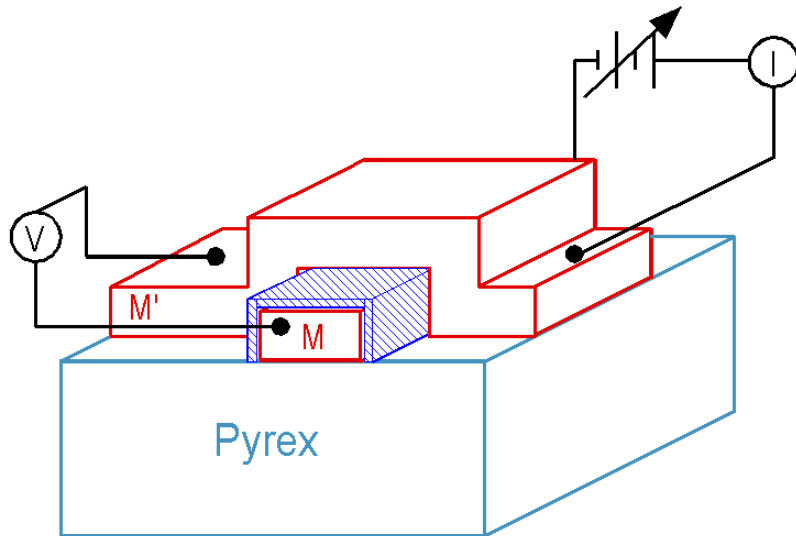

$$I = cV \exp[-Ad(U-E)^{1/2}]$$

$$A = 1.02 \text{ eV}^{1/2}/\text{Angstrom}$$

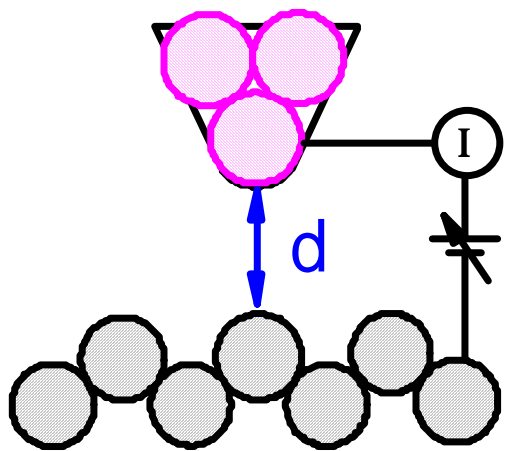

$$I \sim CV \exp(-d \sqrt{\Phi})$$

D in Angstroms
and Φ in eV

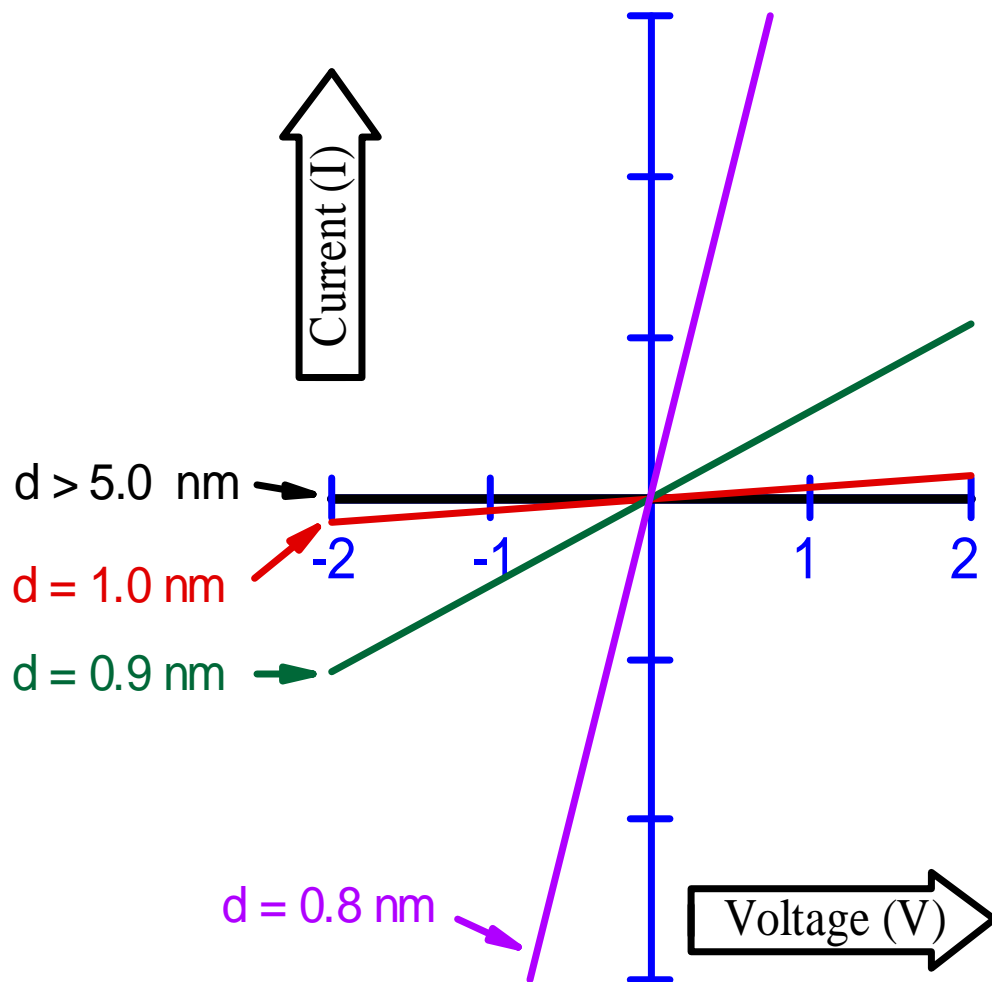

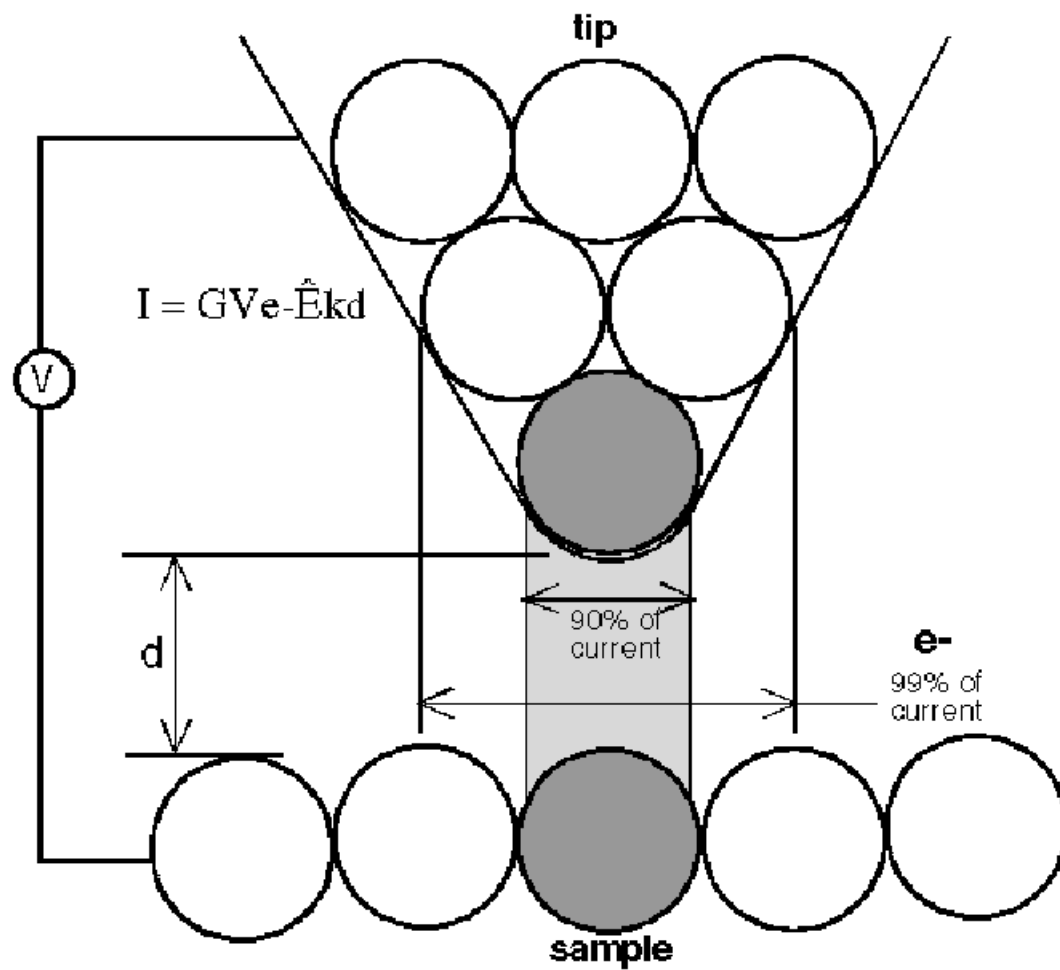

I'm Mr. Feedback

Constant Current Imaging



STM Capable of Imaging and Spectroscopy

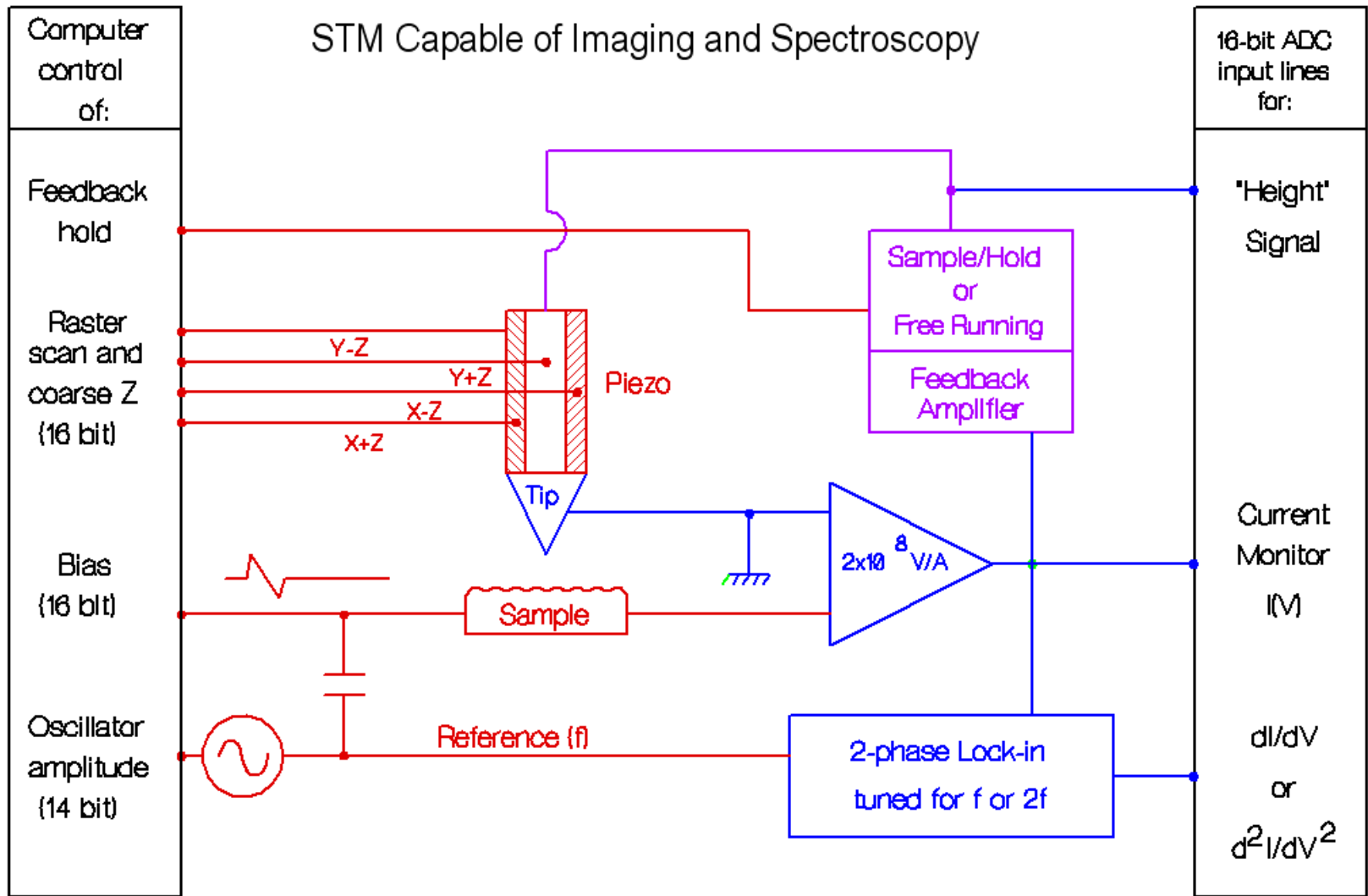

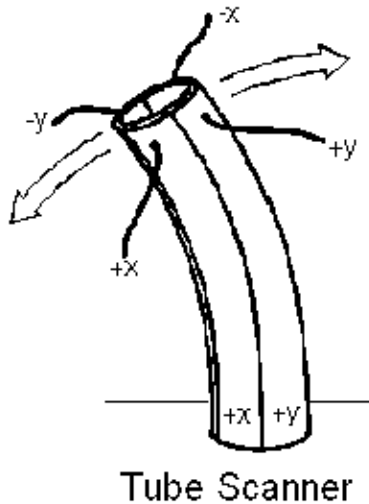

Applying opposite signed voltages on $+X$ and $-X$ quadrants relative to ground (inner tube) results in deflections along X .

Applying opposite signed voltages on $+Y$ and $-Y$ quadrants relative to ground (inner tube) results in deflections along Y .

Applying the same voltage on all four outer quadrants relative to the inner conductor results in Z motion.

(Feedback ON)
CONSTANT CURRENT MODE

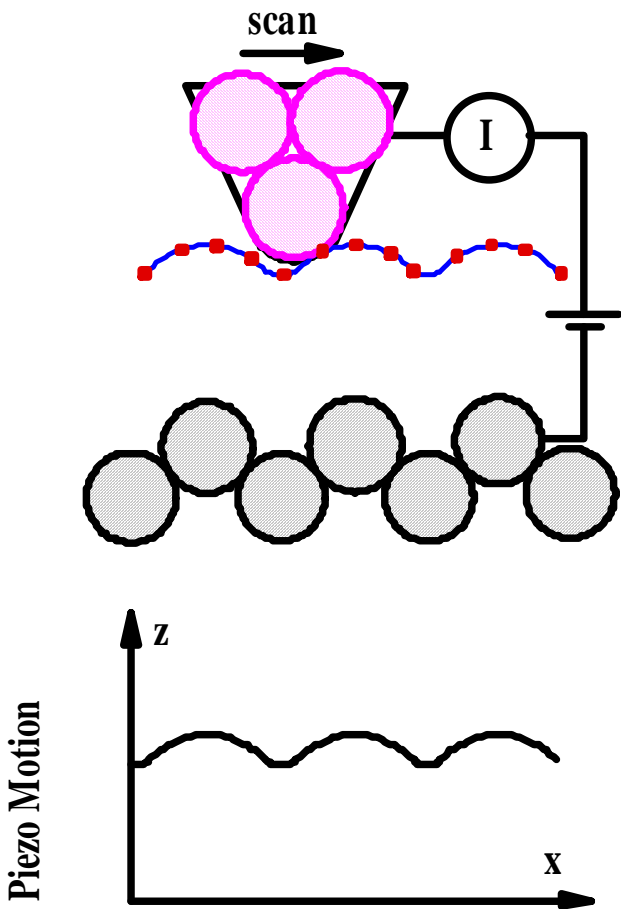

$$I \sim CV \exp(-d/\sqrt{\Phi})$$

Raster Scan

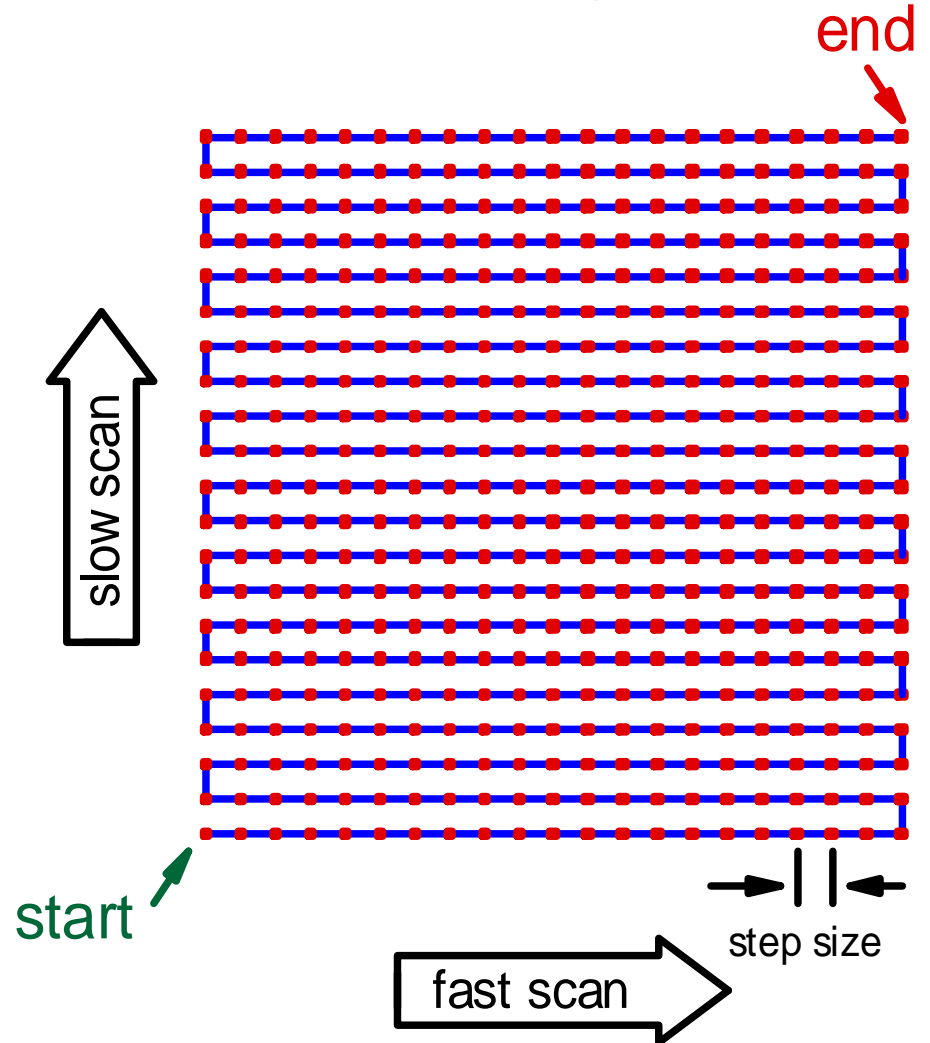

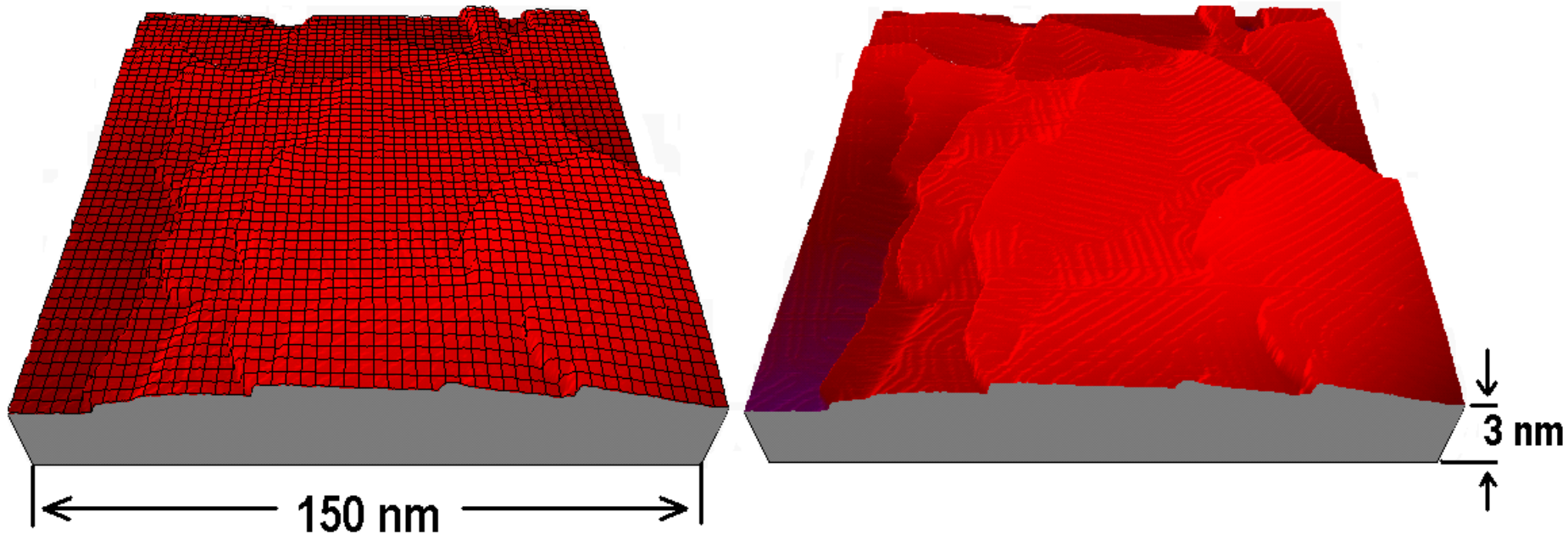

"Low resolution" STM image of the Au(111) surface



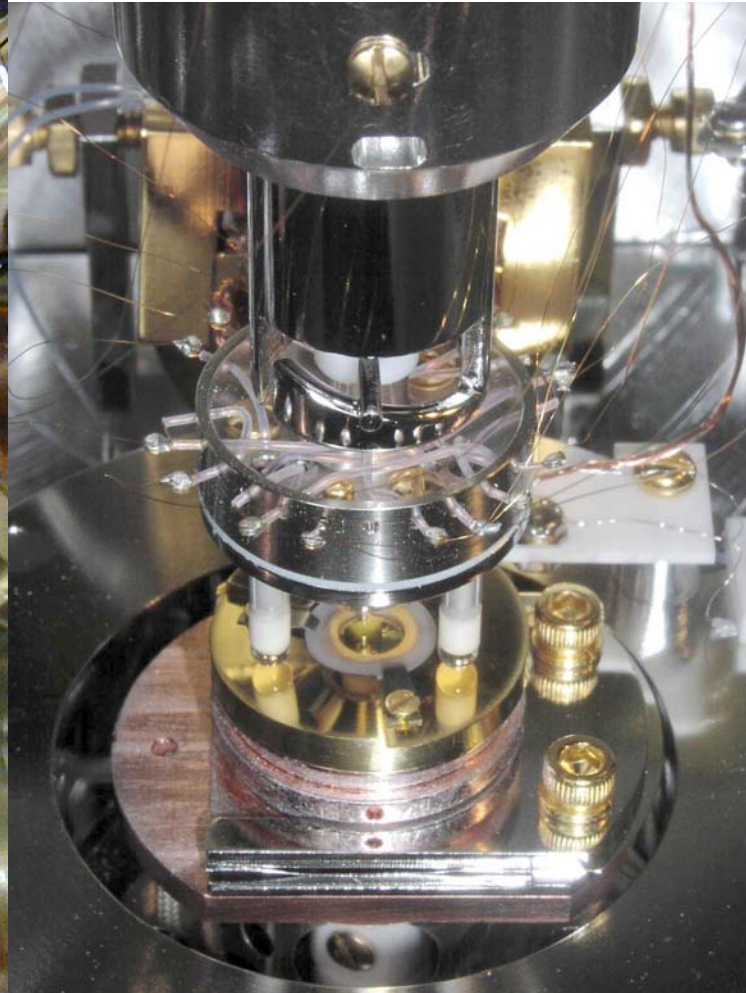
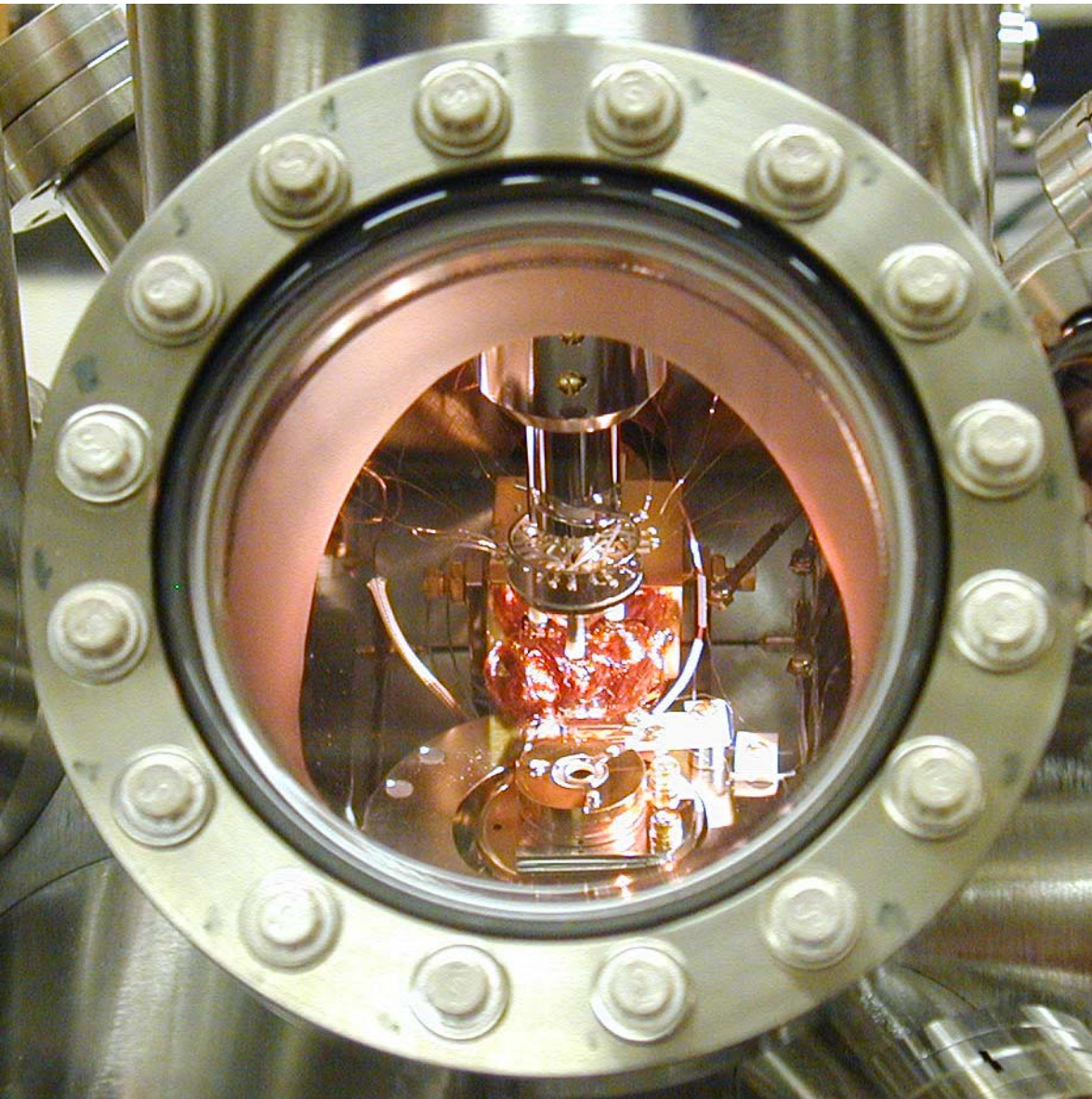

*Top View of the
variable temperature
STM chamber*

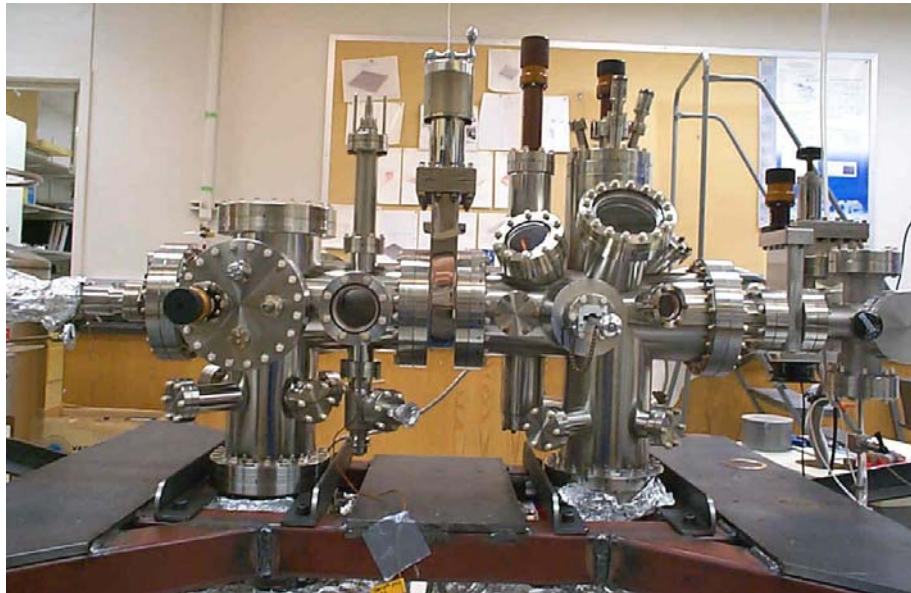
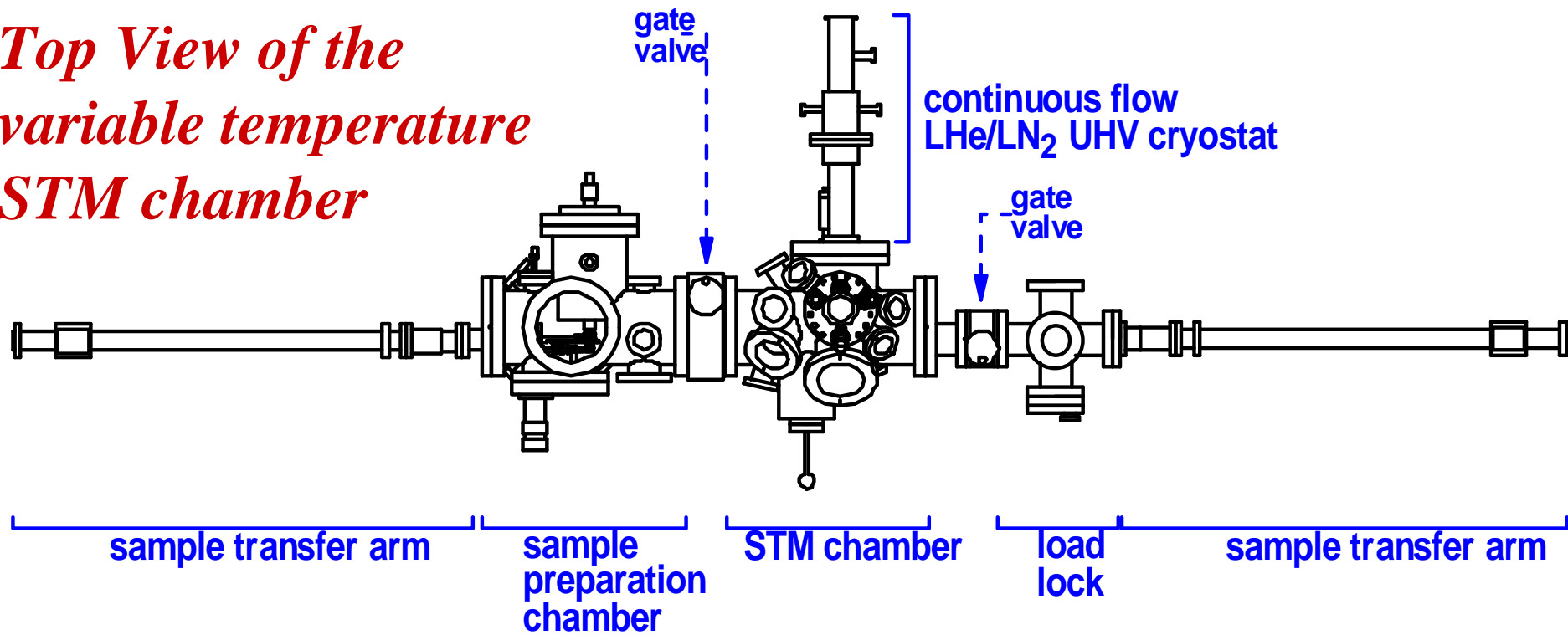

Side View

Sample Preparation

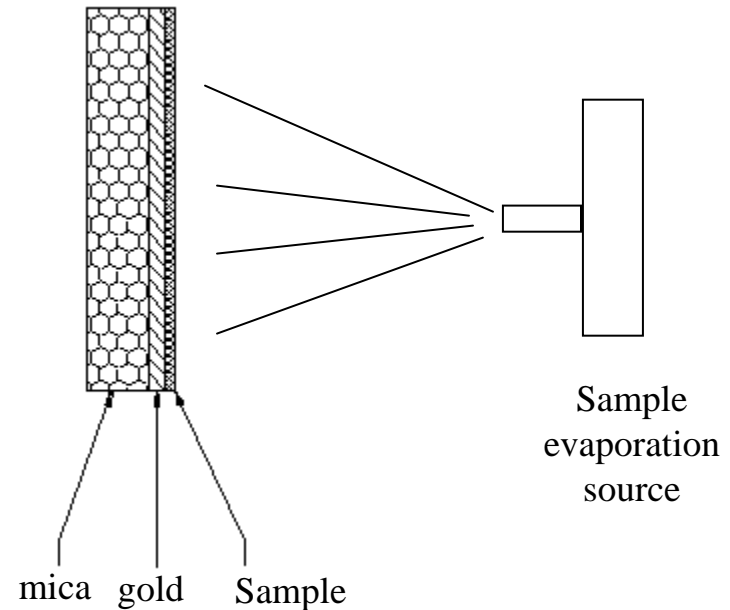
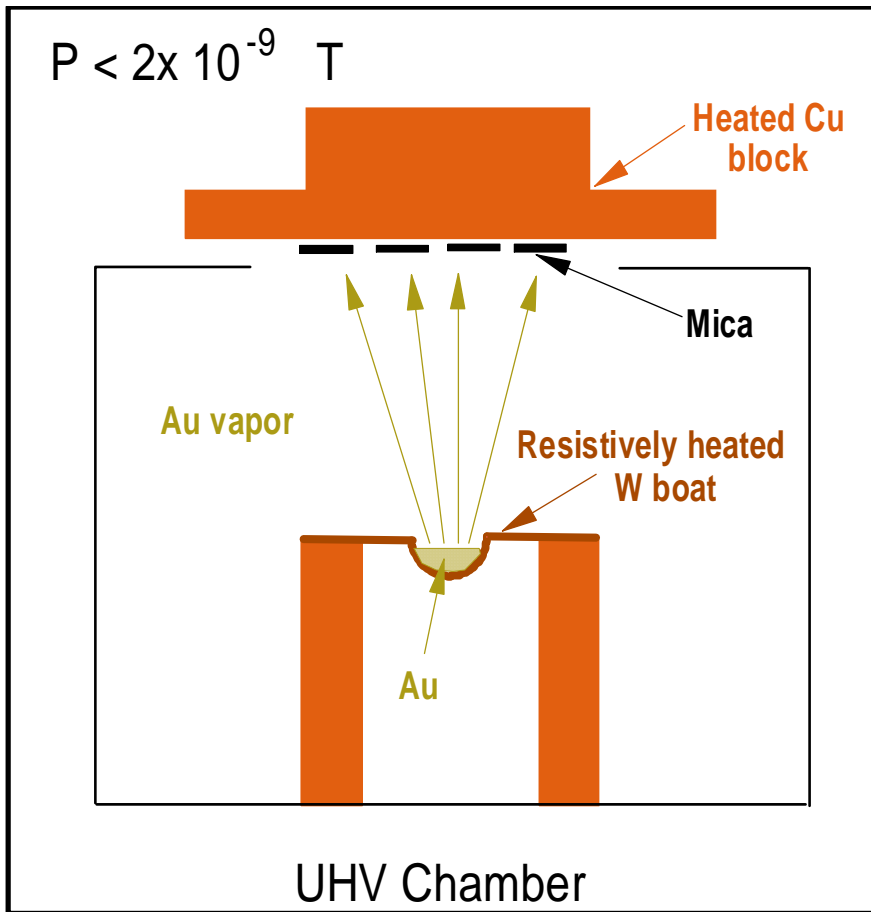

1. Gold is vapor deposited onto an atomically flat mica surface. The deposition rate is carefully controlled.

2. Single molecular samples are vapor deposited in the STM chamber onto the Au(111) surface. Typically, less than one monolayer is deposited

Au(111) : Vapor Deposited on Mica

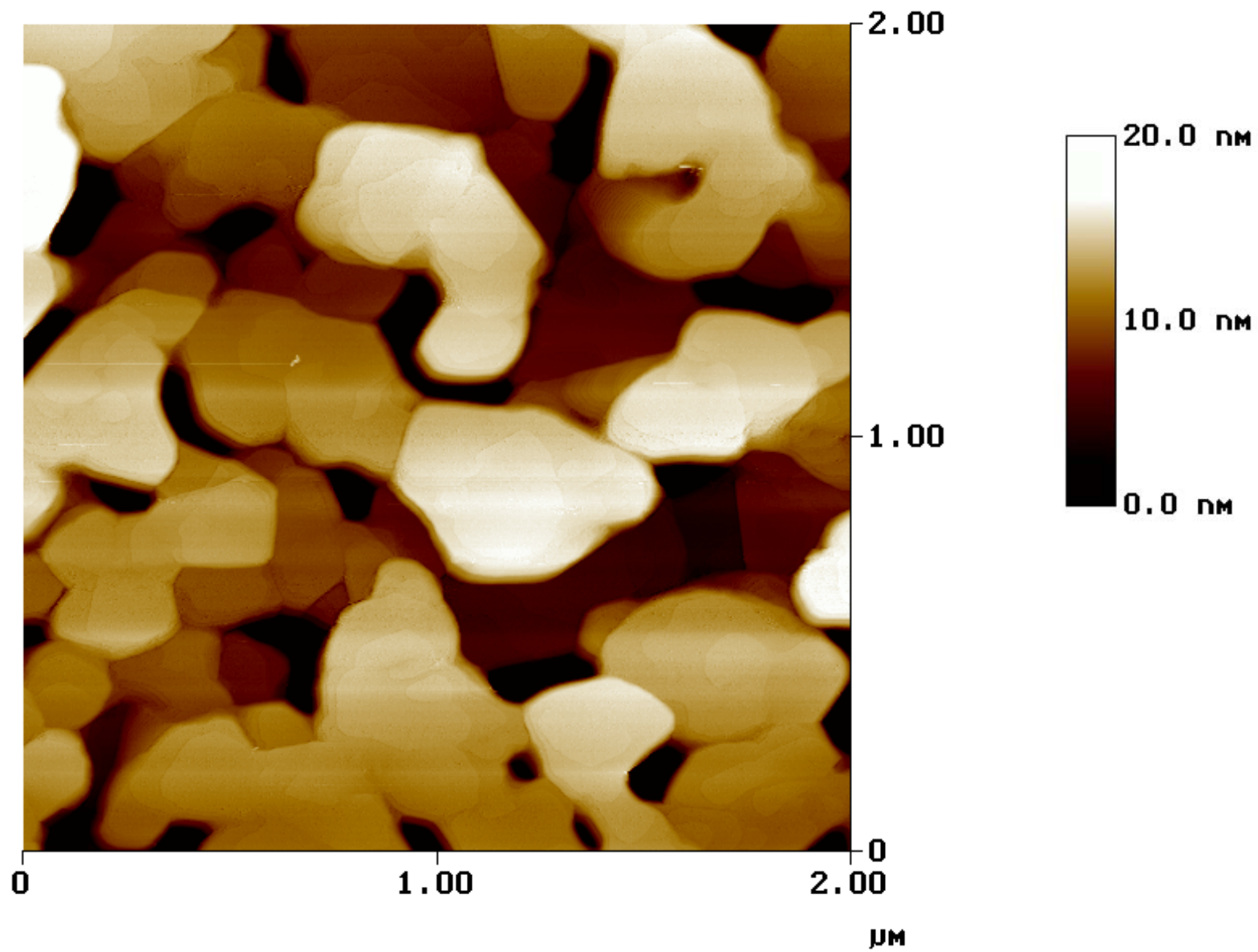

Reconstruction of the Au(111) surface

Height Image

800 mV, 280 pA, 294 K

Derivative Image

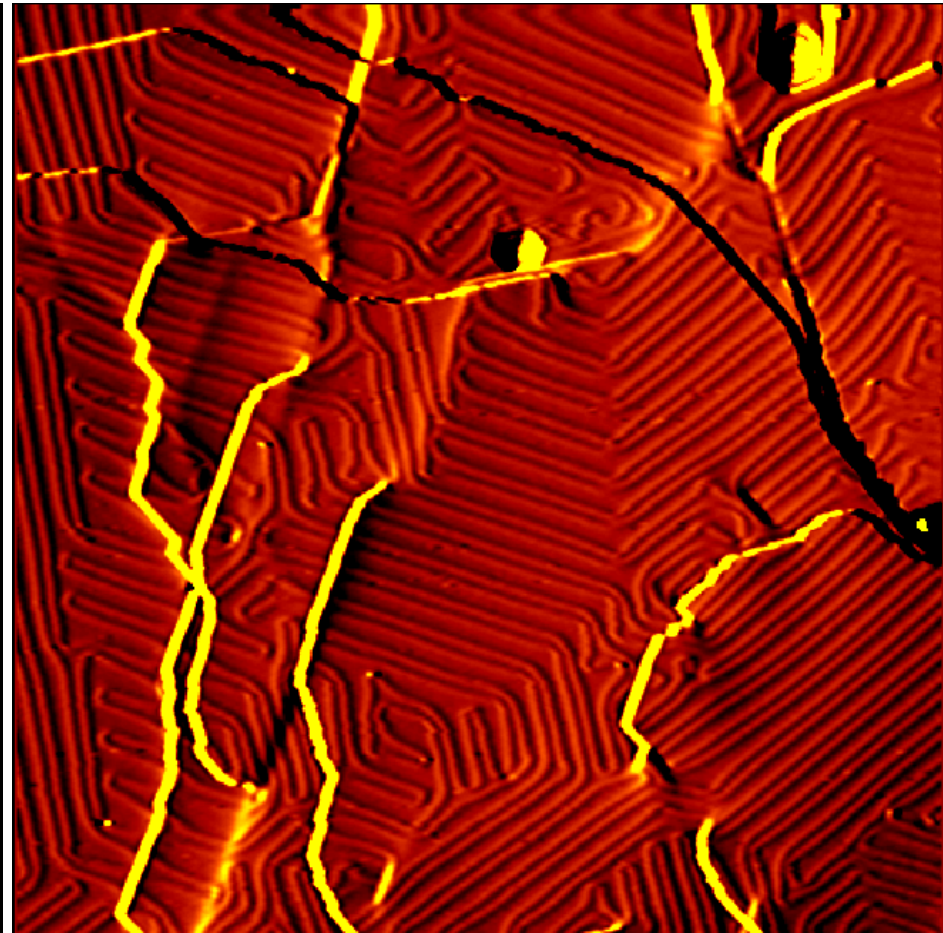
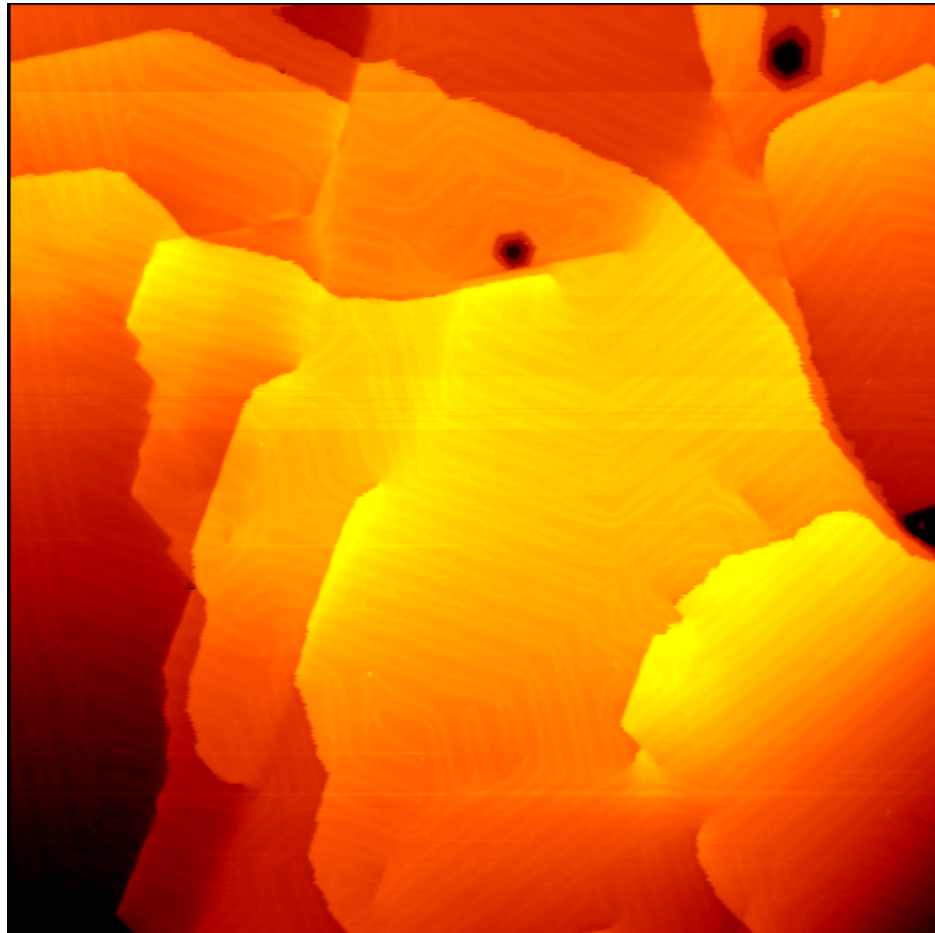

153 nm

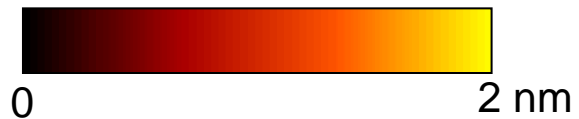

0

2 nm

Atomic Resolution on Au(111)/Mica

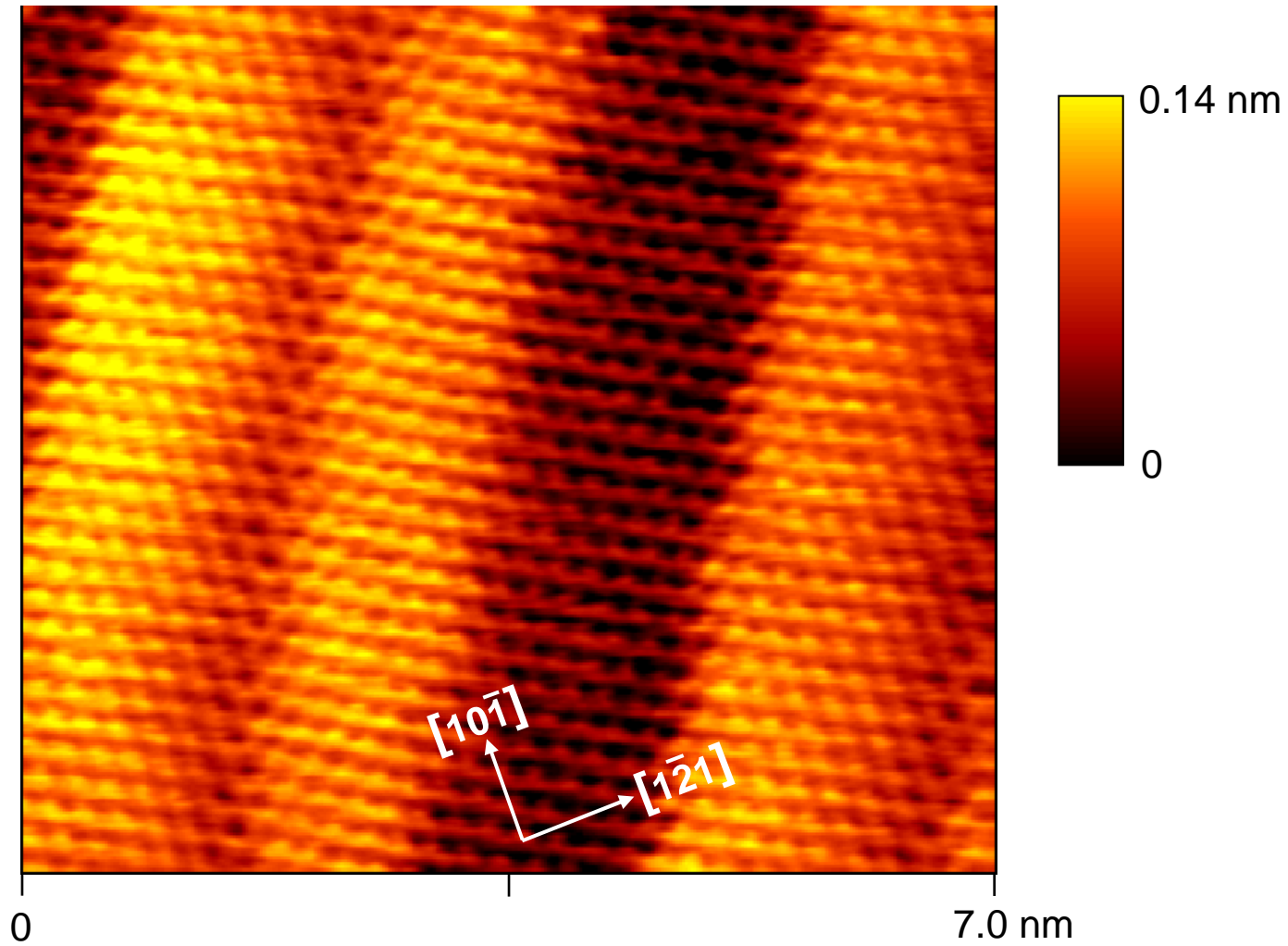

25 mV, 2 nA, 294 K

Organometallics

- **Why do we care?**

Intensely colored

(Dyes, photochemistry, non-linear optics)

Extraordinary thermal and chemical stability

(Deposited like inorganics, resist atmospheric attack and aging)

Ubiquitous in biology

(Understanding porphyrin-like structures is highly desirable)

Exciting electronic properties

(Both p-type and n-type semiconductors: *OLEDs, Transistors, Sensors*)

How do we do it?

Conventional spectroscopy, a few hundred billion at a time.

(XPS, UPS, UV-Vis, FT-IR, Raman, electrochemistry)

Tunneling spectroscopy and microscopy, *one molecule* at a time.

(Orbital mediated tunneling spectroscopy)

(Scanning tunneling microscopy)

Make them by thermal deposition, self-assembly, LB methods

Top and Side Views of a Metal Phthalocyanine (MPc)

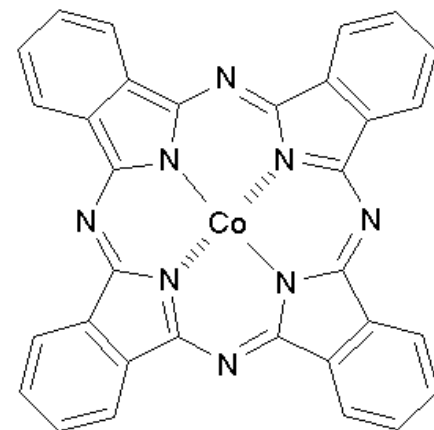
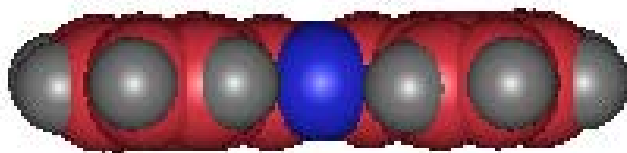
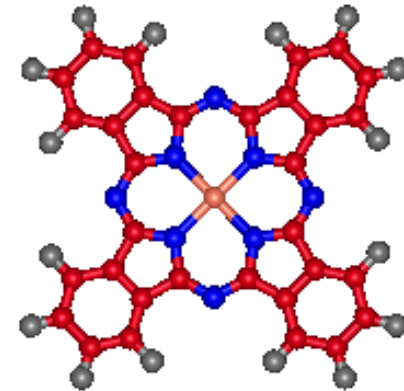
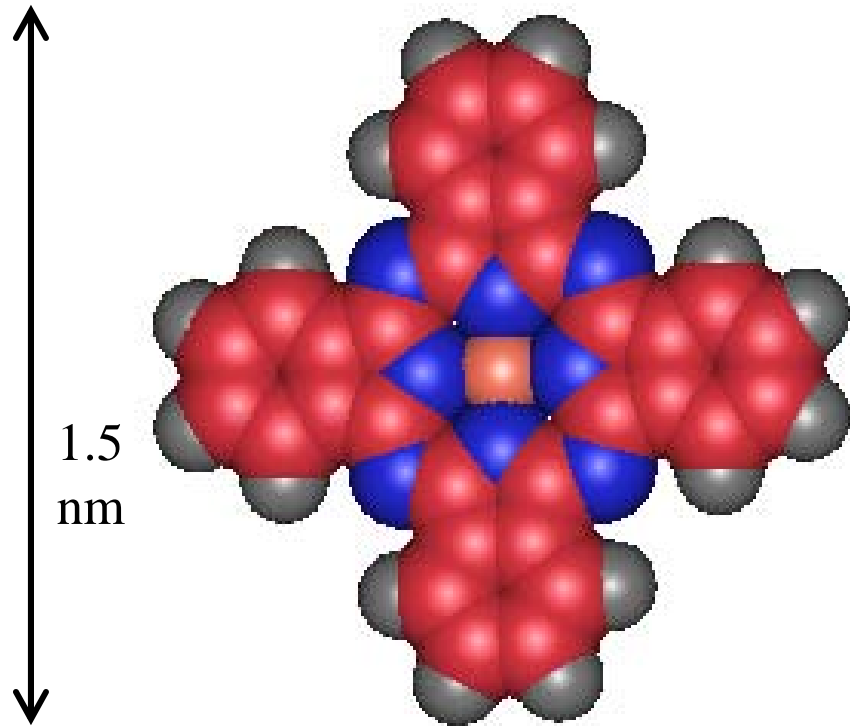

Typical low coverage image of an organometallic on Au(111)

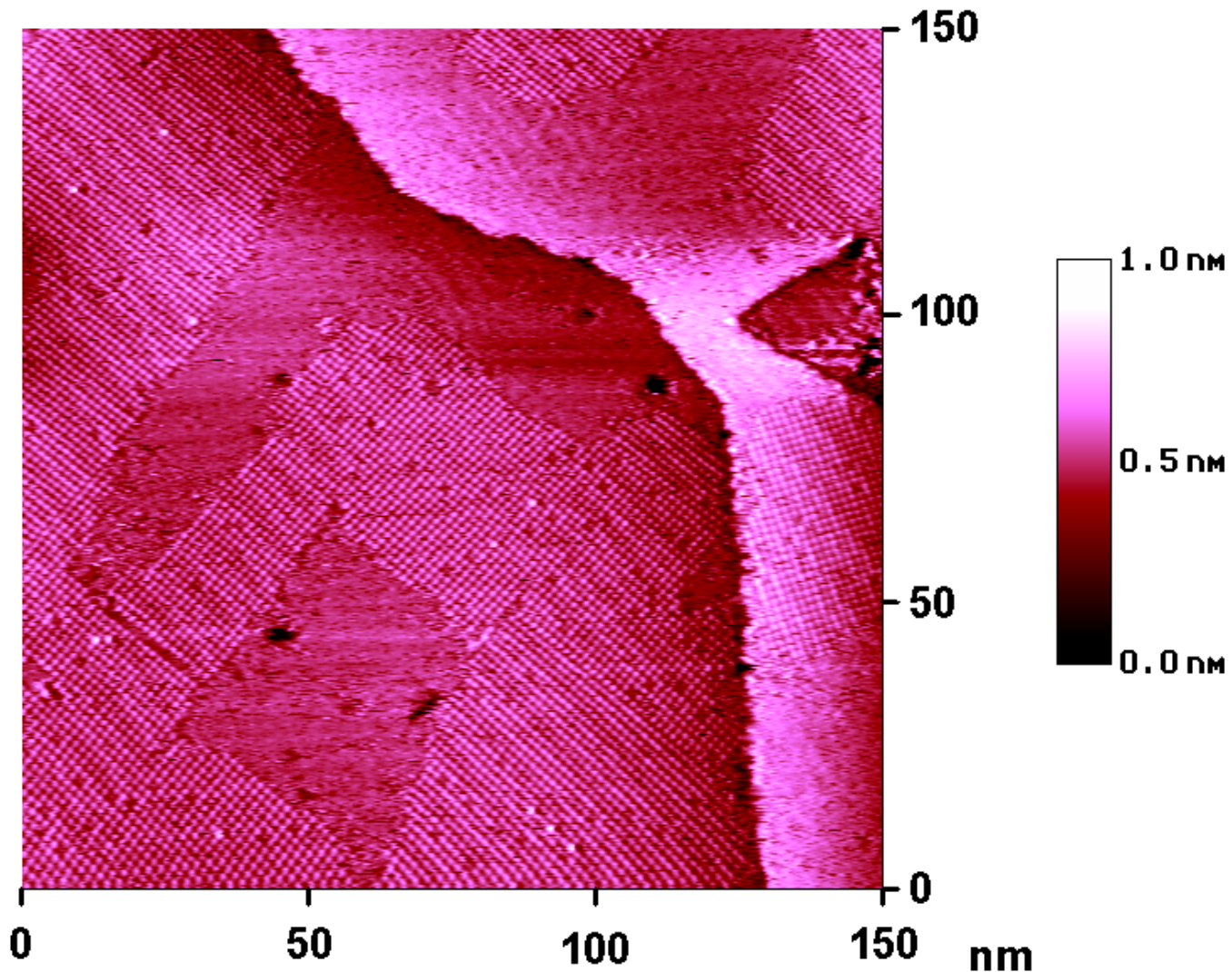

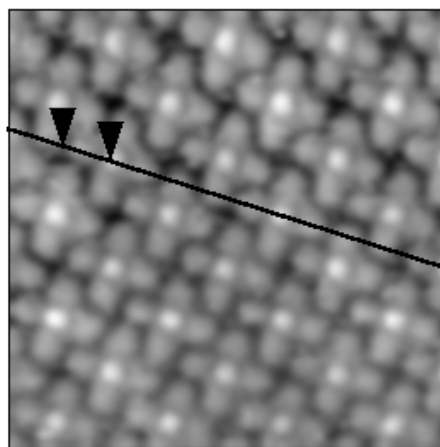
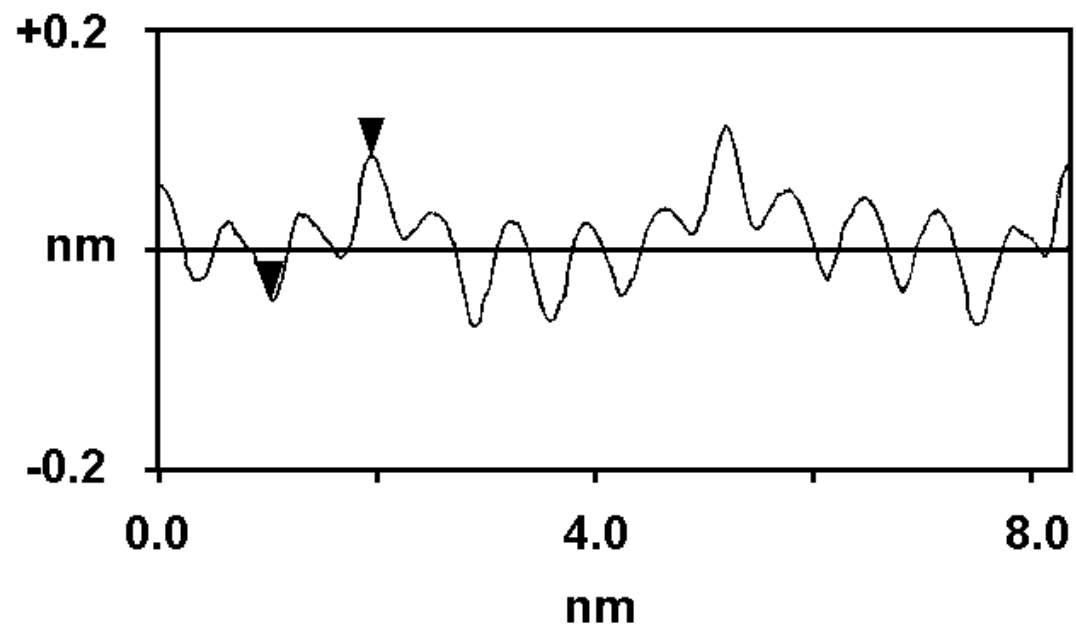

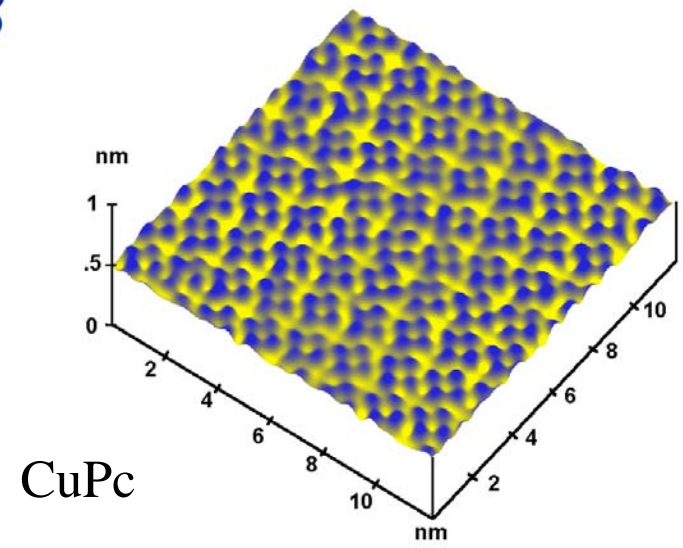
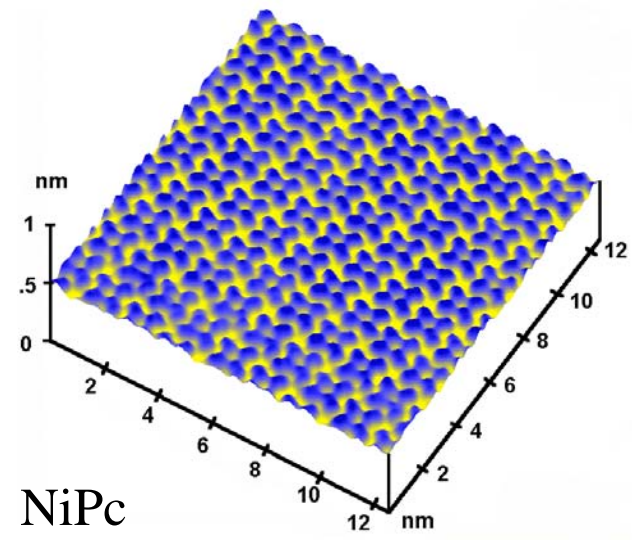
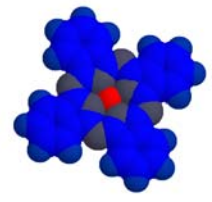
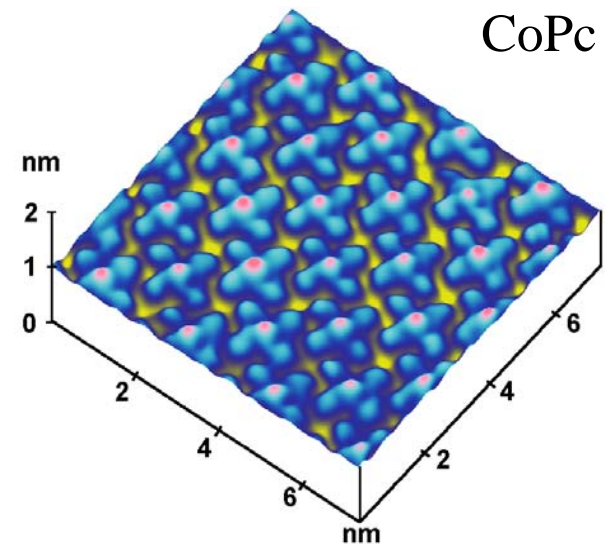
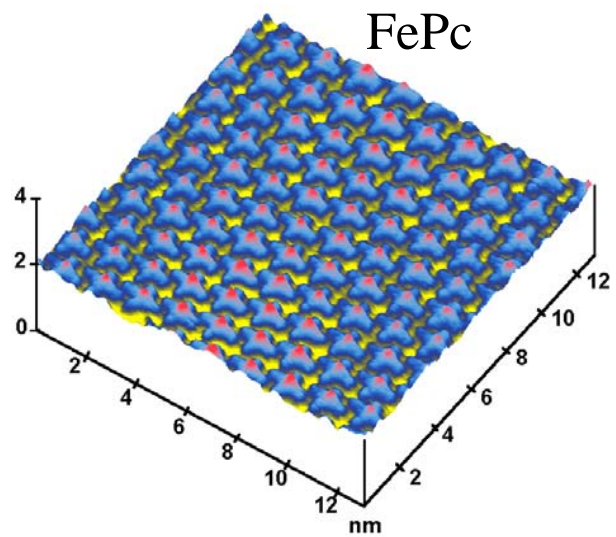

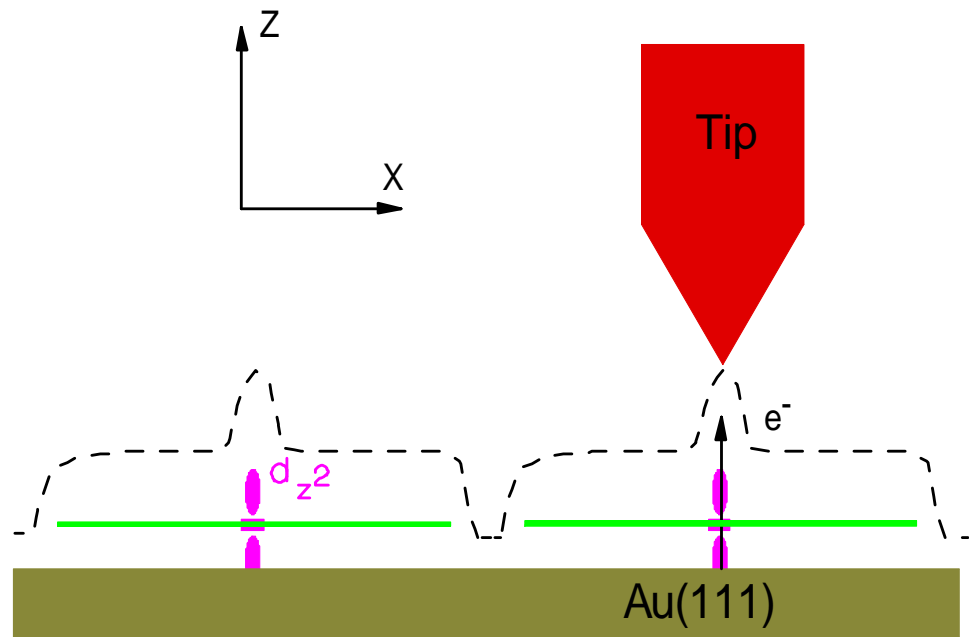
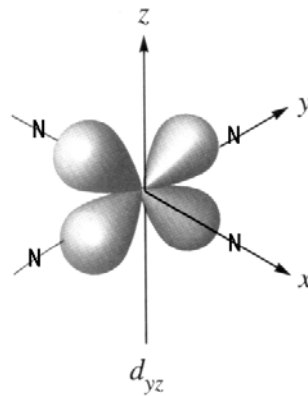
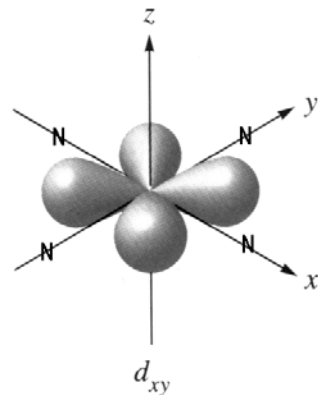
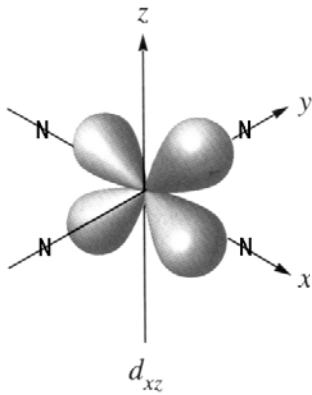
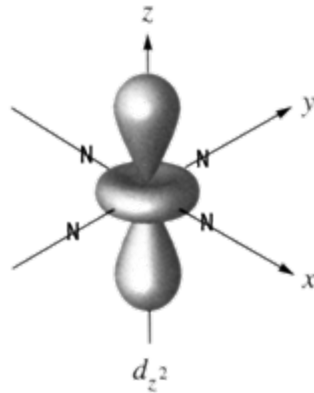
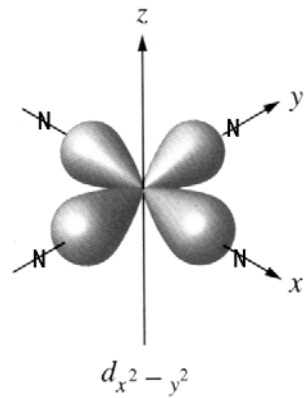

The occupancy of *metal* d orbitals defines the conductivity at the center of the molecule.

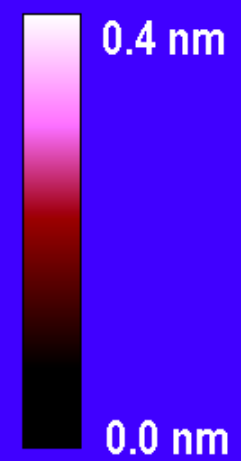
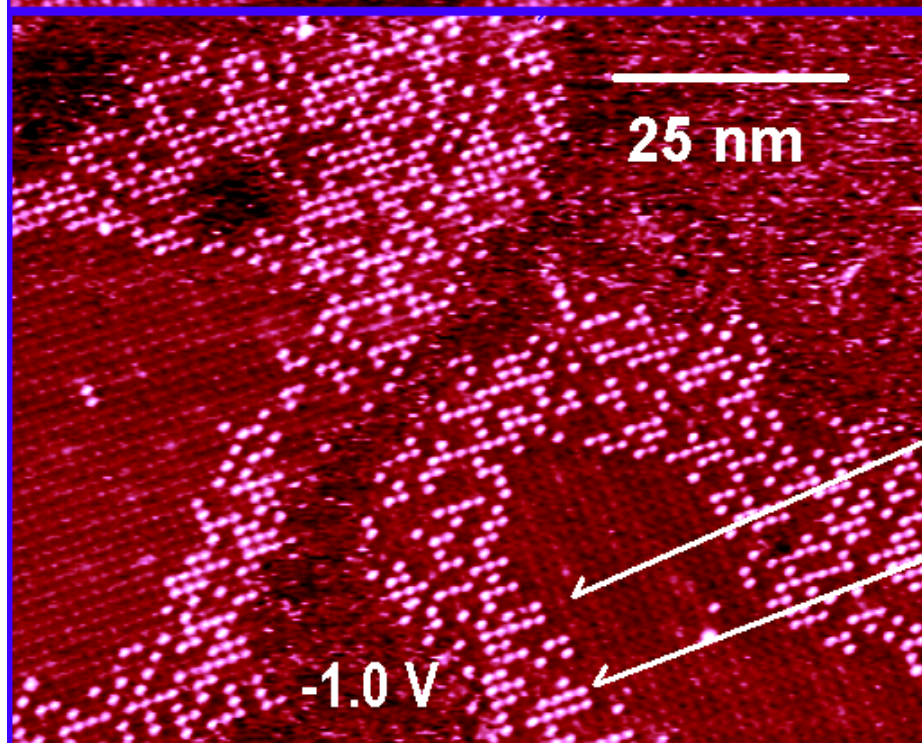
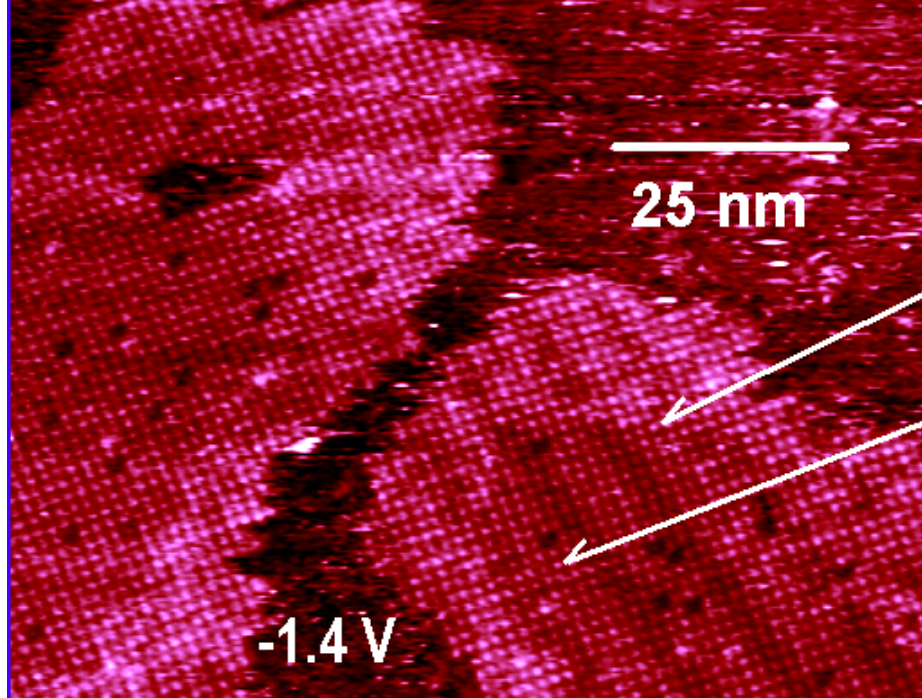

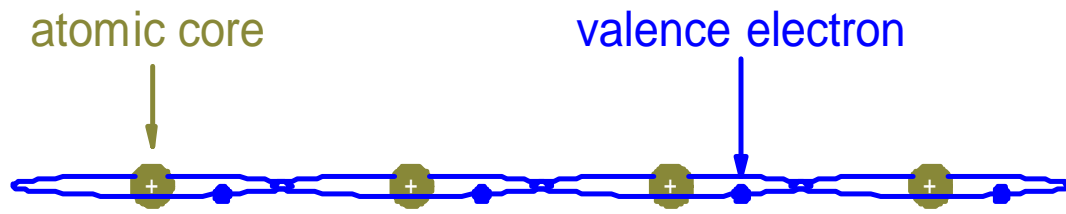

Spatial Picture

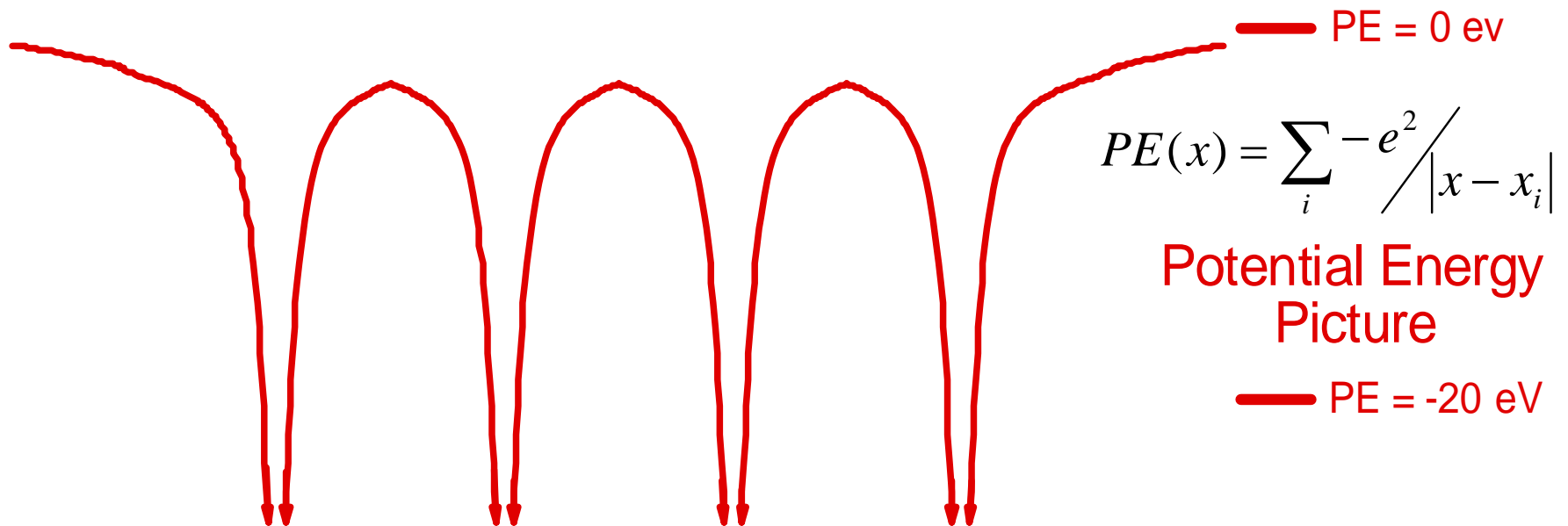

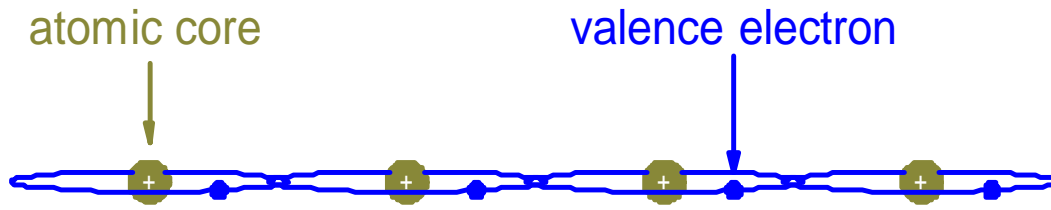

Spatial Picture

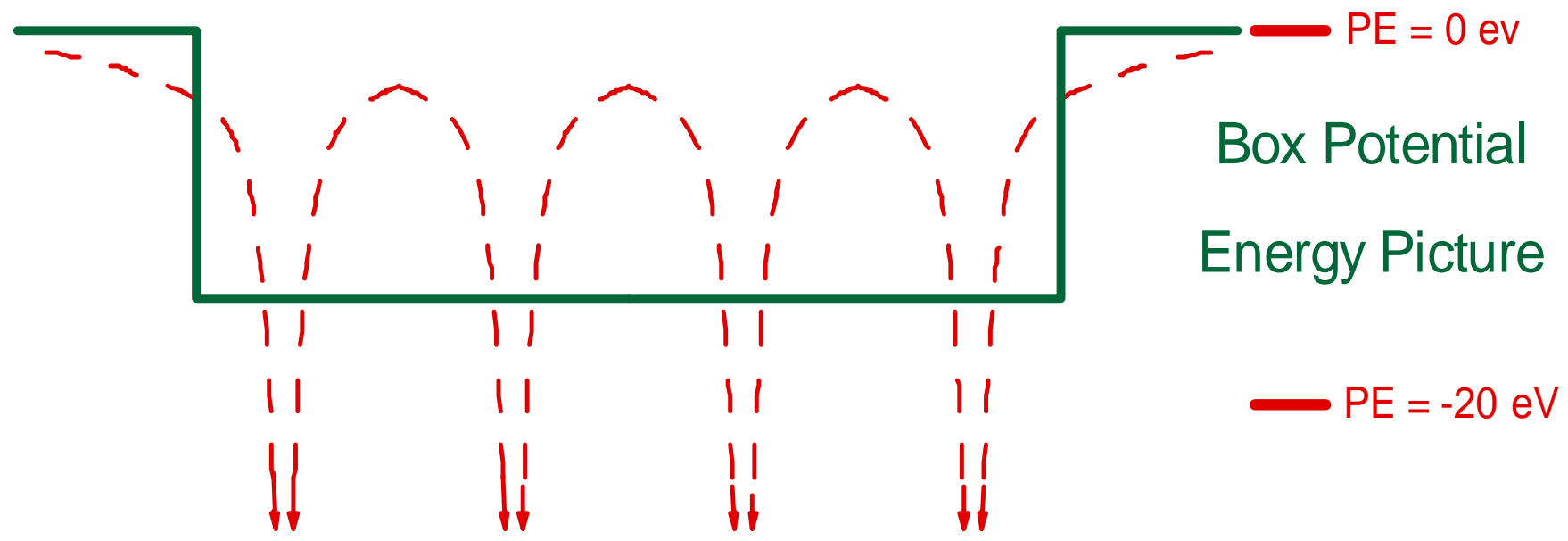

N nuclei with 1 valence electron each, require ...
N electrons in the box!

HOWEVER: Electrons are quantum mechanical beasts, so

- 1) Only certain energies (states) are possible
- 2) At most, 2 electrons can be in each state

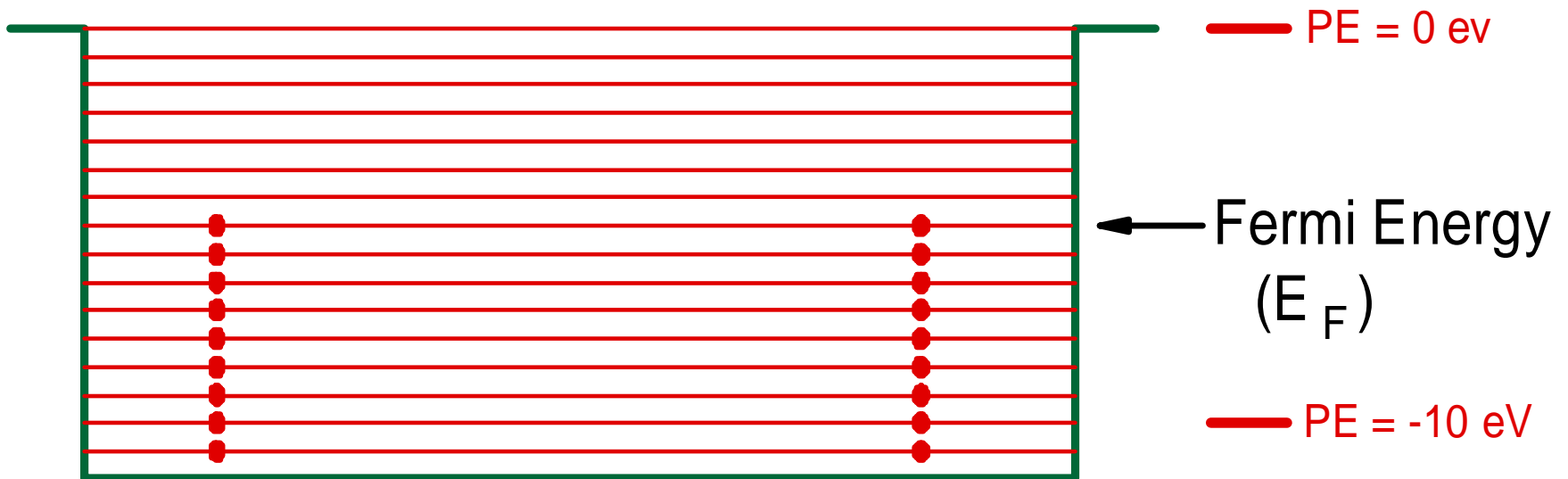

"Electrons in a Box" Energy Picture for a Metal

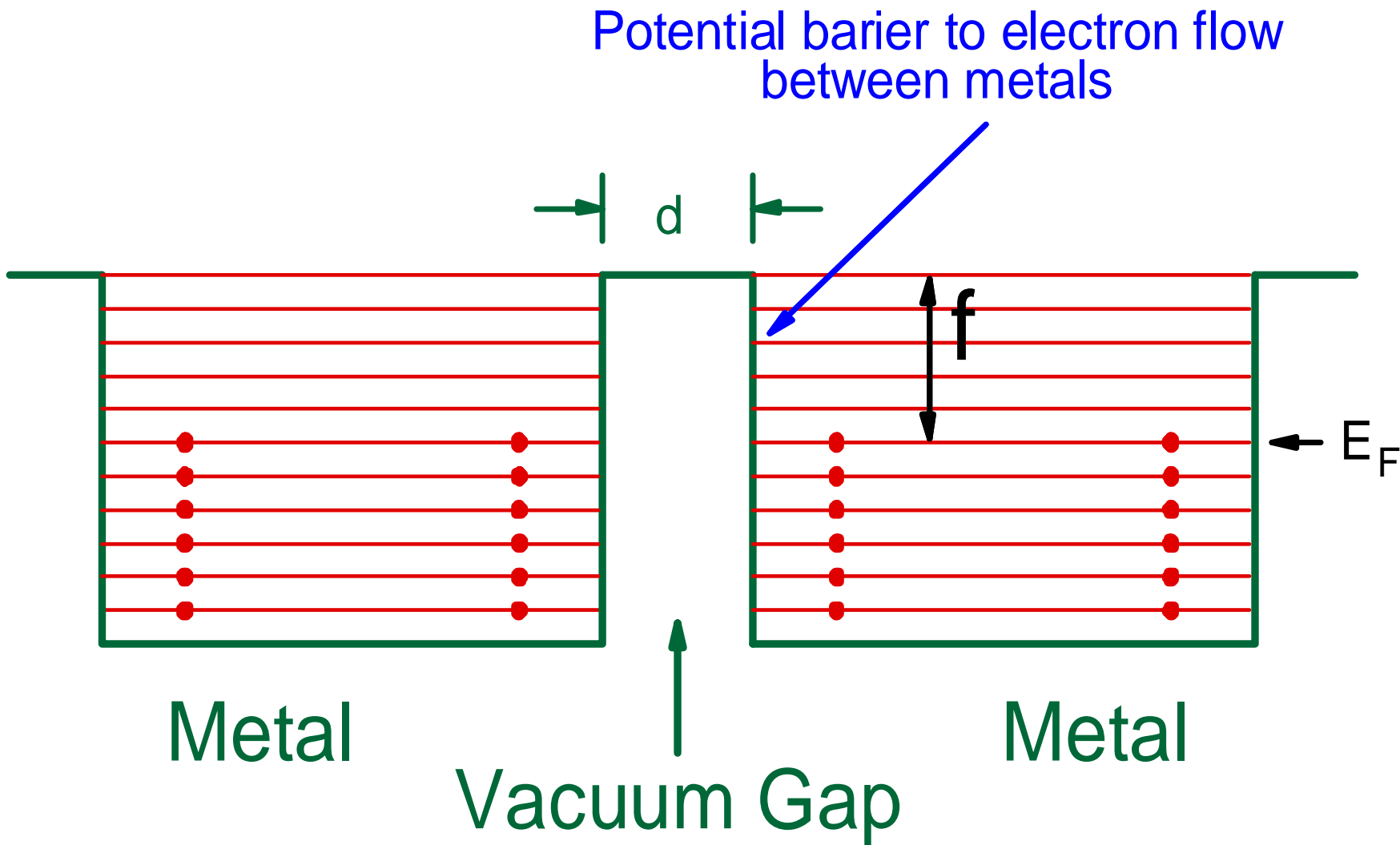

Non-resonant tunneling

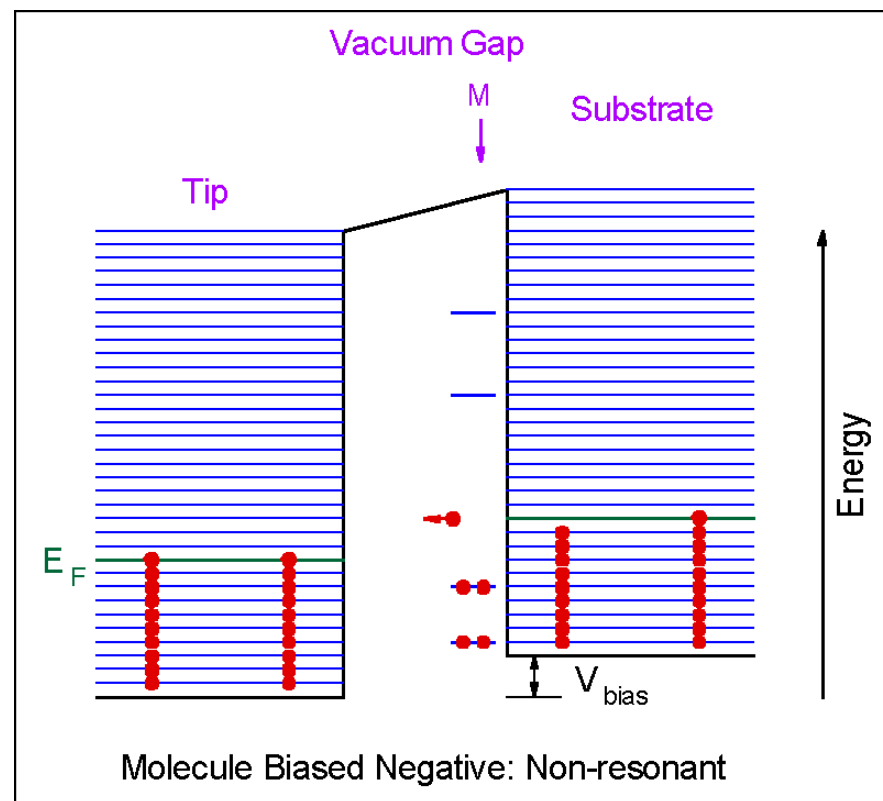
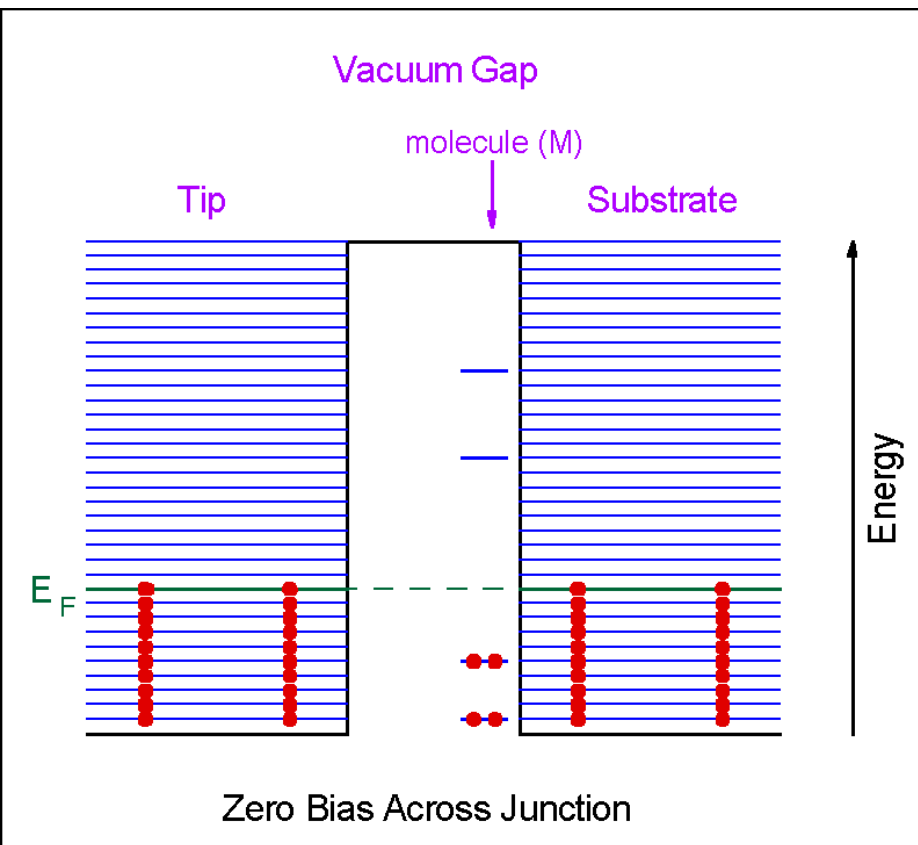

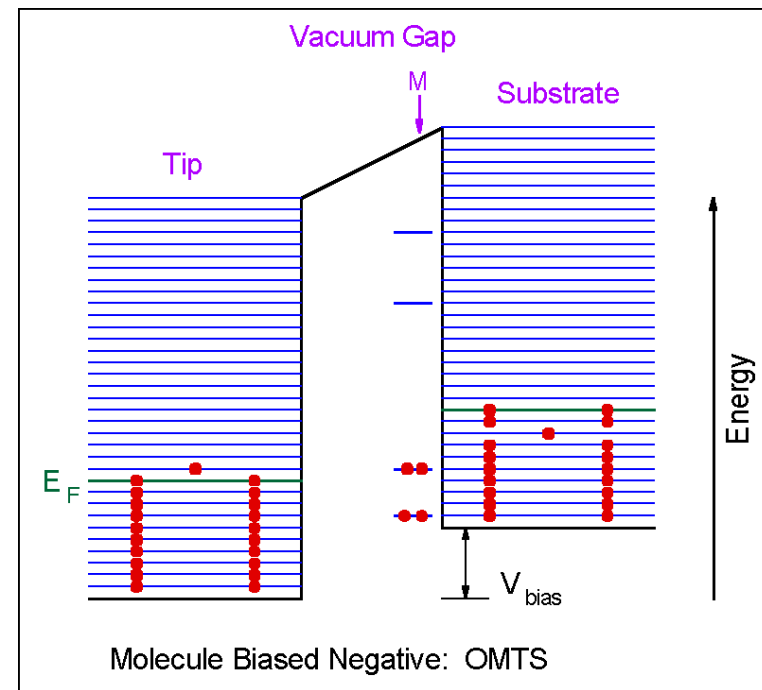
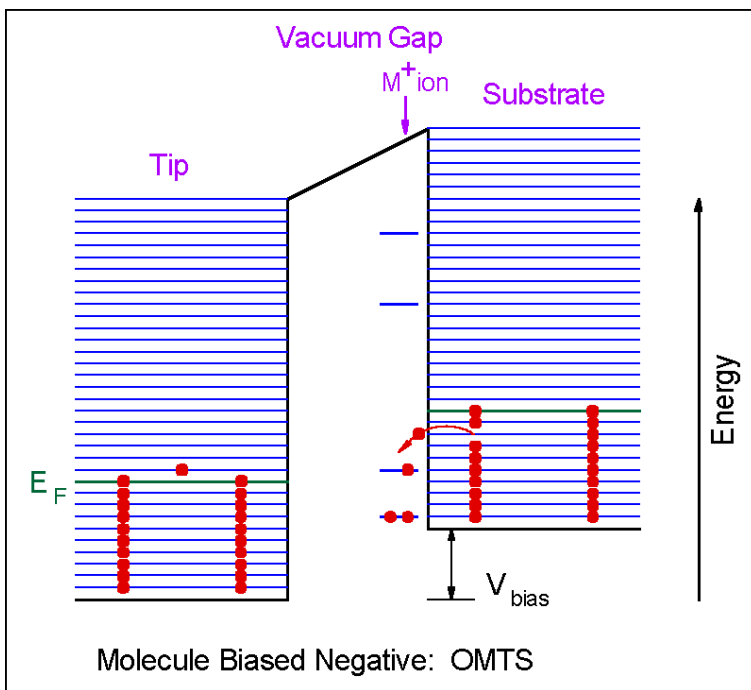
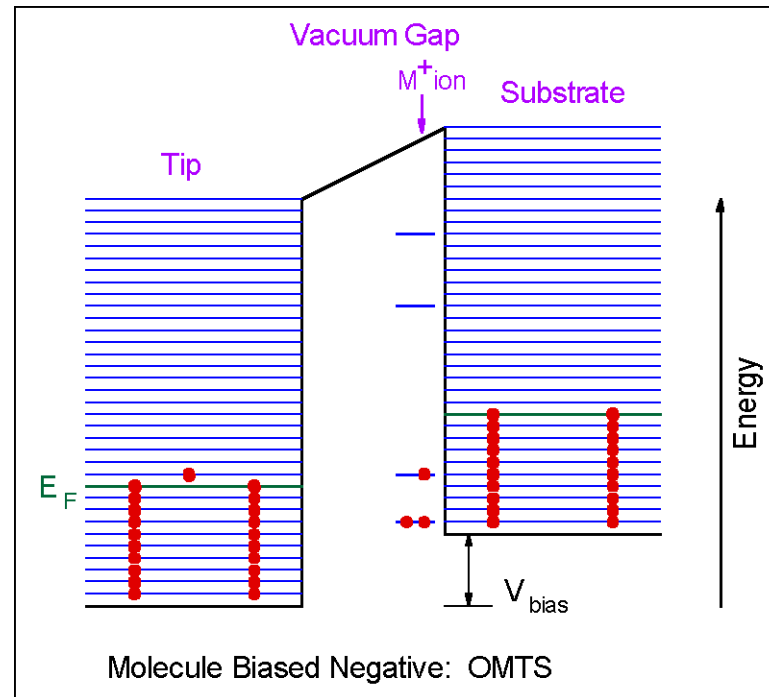
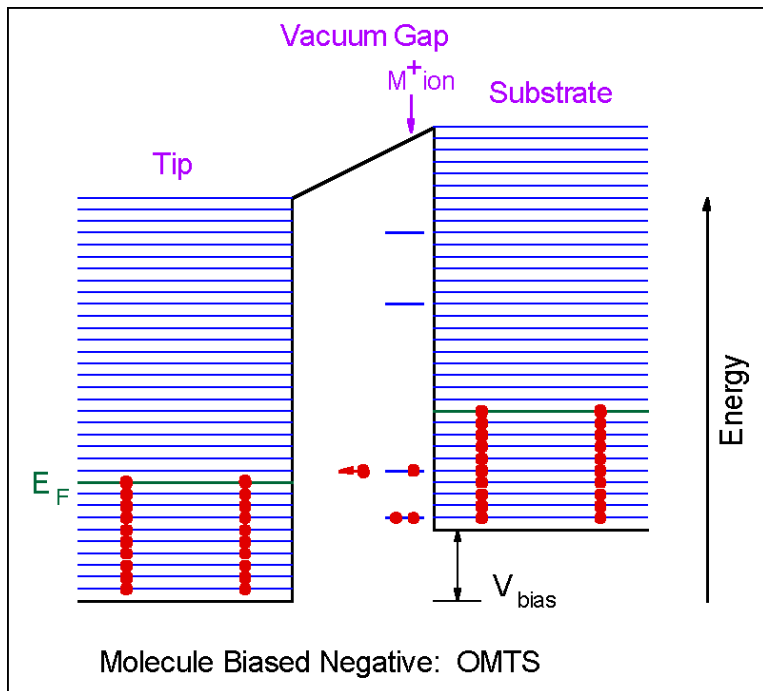

Transient Ion Production

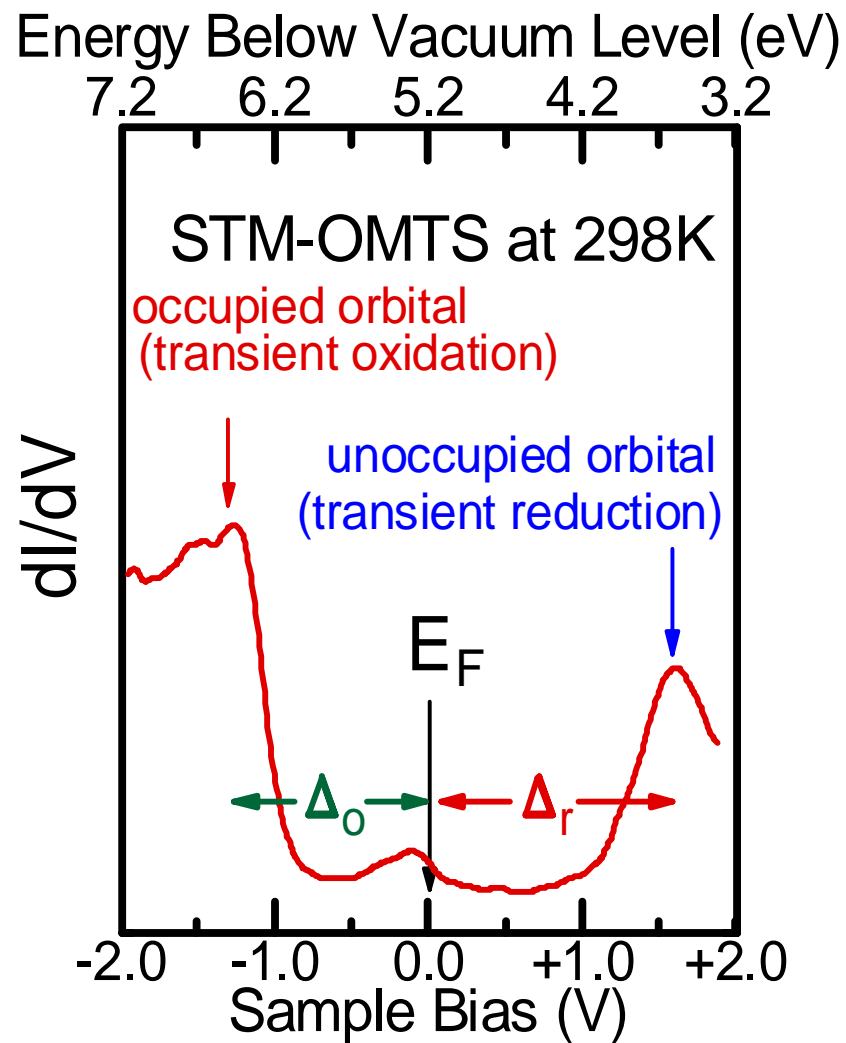
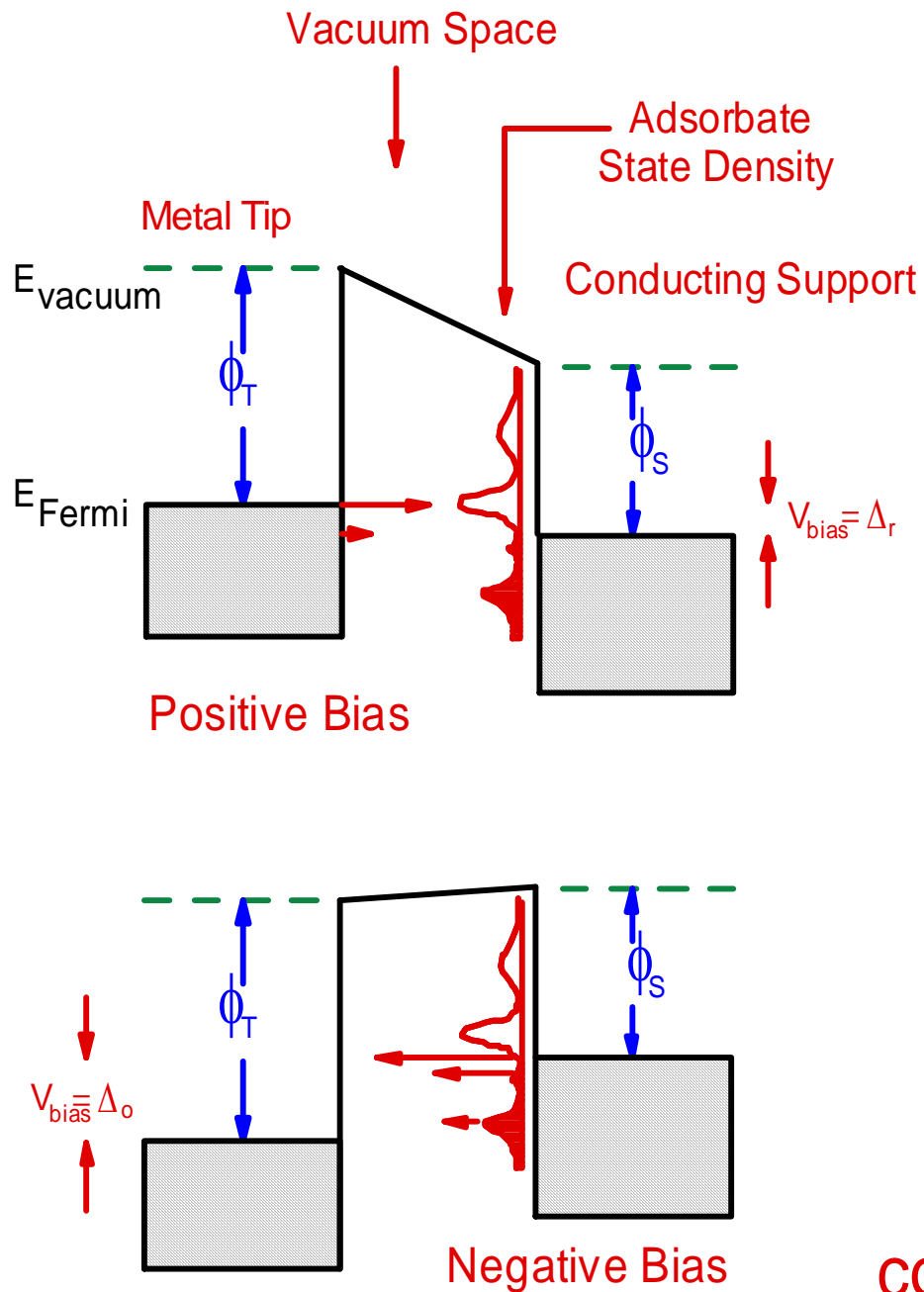

cobalt(II) tetraphenylporphyrin

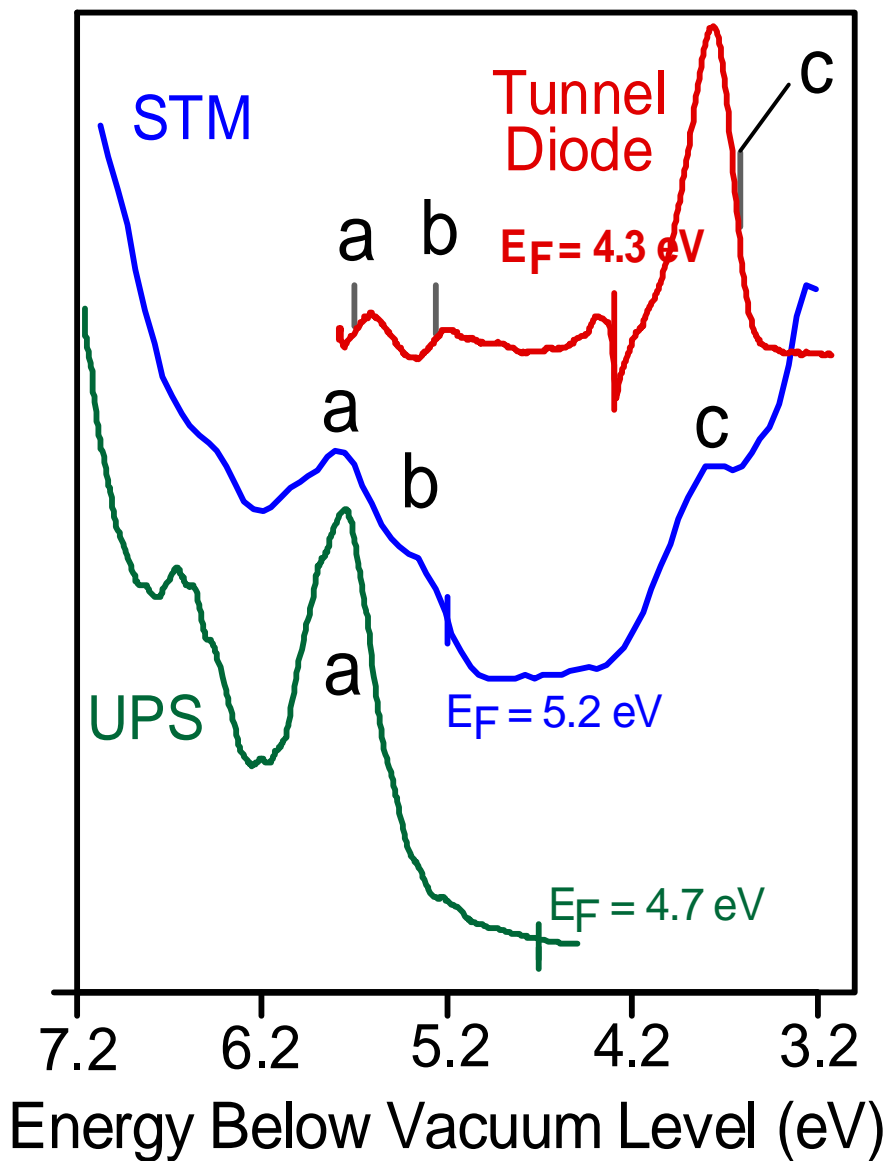

Assignments:

- a) $\text{Pc}^{-2} \Rightarrow \text{Pc}^{-1}$
(π ionization)
- b) $\text{Co}^{+2} \Rightarrow \text{Co}^{+3}$
(d_{z^2} ionization)
- c) $\text{Pc}^{-2} \Rightarrow \text{Pc}^{-3}$
(π^* affinity level)

OMTS from 1 molecule
Occupied and unoccupied

UPS from 10^{10} molecules
Occupied only

There are both ELASTIC and INELASTIC tunneling processes that can lead to spectroscopic information

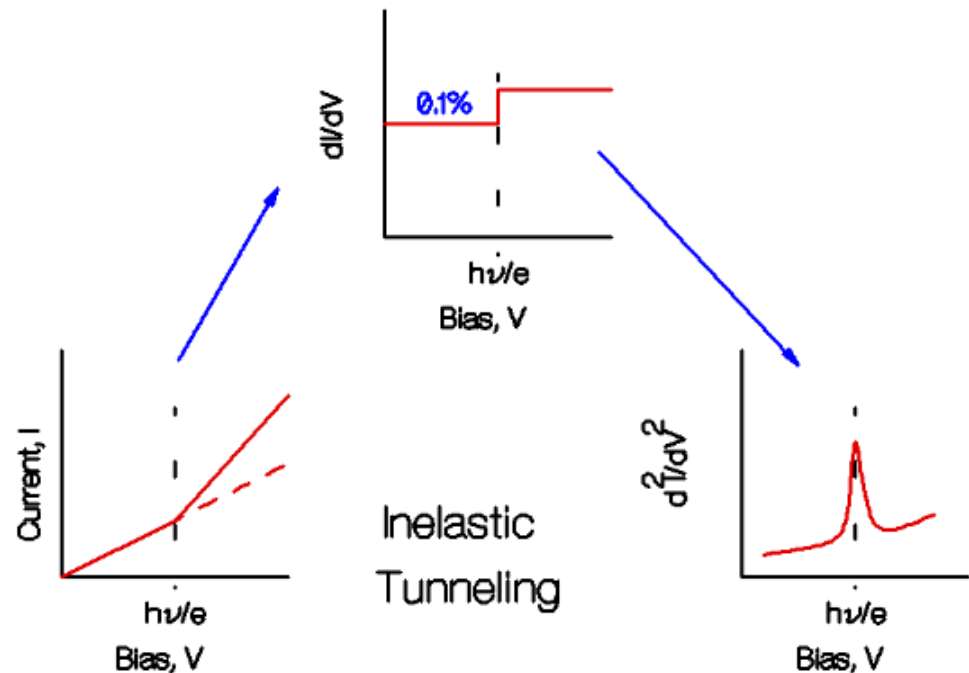
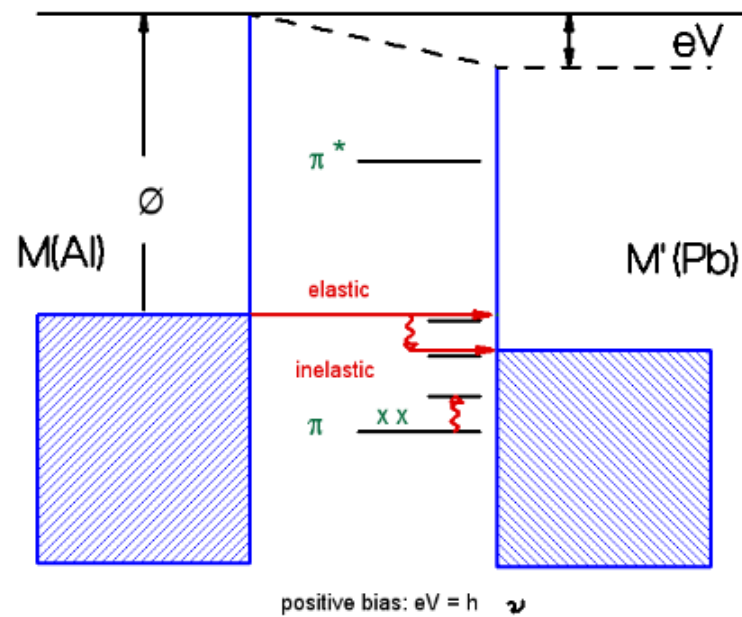

IETS transitions give peaks in $(d^2I/dV^2)/(dI/dV)$ while **OMTS** transitions give peaks in dI/dV

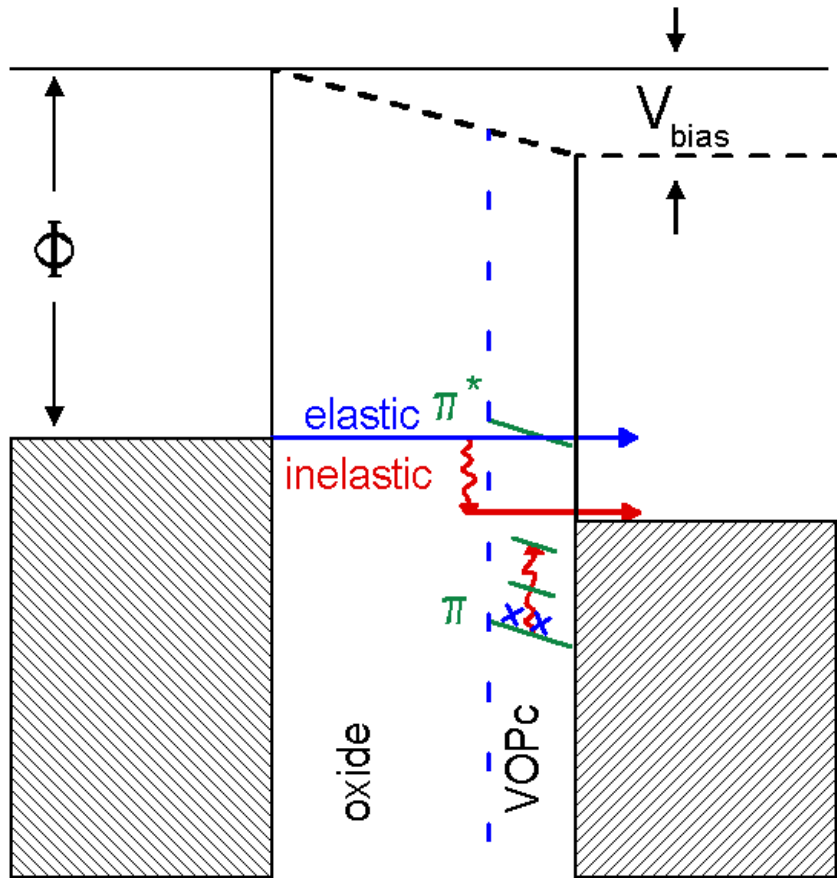

Model of tunneling process.

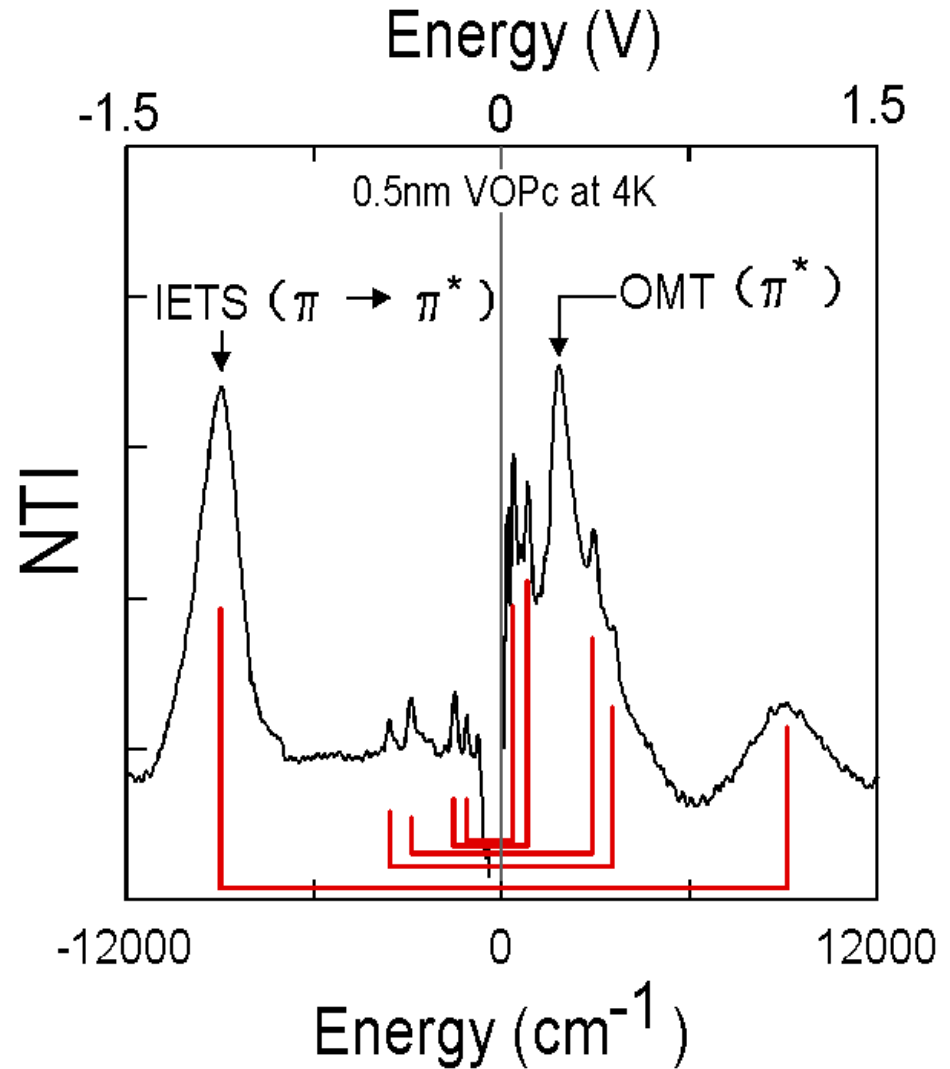

Tunneling spectrum of VOPc from a tunnel diode

Comparison of a **low** resolution vibrational IETS spectrum taken in a tunnel diode at 4K with conventional IR and Raman spectra.

You can easily resolve bands that are 50 cm^{-1} (6 meV) apart, such as the pair near 600 cm^{-1} .

