



UNIVERSITY OF LEEDS

This is a repository copy of *Monitoring of water quality in a shrimp farm using a FANET*.

White Rose Research Online URL for this paper:

<http://eprints.whiterose.ac.uk/158015/>

Version: Accepted Version

---

**Article:**

Orozco-Lugo, AG, McLernon, DC [orcid.org/0000-0002-5163-1975](https://orcid.org/0000-0002-5163-1975), Lara, M et al. (9 more authors) (2020) Monitoring of water quality in a shrimp farm using a FANET. Internet of Things. 100170. ISSN 2542-6605

<https://doi.org/10.1016/j.iot.2020.100170>

---

© 2020, Elsevier B.V. This manuscript version is made available under the CC-BY-NC-ND 4.0 license <http://creativecommons.org/licenses/by-nc-nd/4.0/>.

**Reuse**

This article is distributed under the terms of the Creative Commons Attribution-NonCommercial-NoDerivs (CC BY-NC-ND) licence. This licence only allows you to download this work and share it with others as long as you credit the authors, but you can't change the article in any way or use it commercially. More information and the full terms of the licence here: <https://creativecommons.org/licenses/>

**Takedown**

If you consider content in White Rose Research Online to be in breach of UK law, please notify us by emailing [eprints@whiterose.ac.uk](mailto:eprints@whiterose.ac.uk) including the URL of the record and the reason for the withdrawal request.



[eprints@whiterose.ac.uk](mailto:eprints@whiterose.ac.uk)  
<https://eprints.whiterose.ac.uk/>

## MONITORING OF WATER QUALITY IN A SHRIMP FARM USING A FANET

**Keywords:** Water Quality Monitoring, Smart Farming, FANET's, WSN.

**Abstract:** This paper develops an architecture for flying ad-hoc networks (FANETs) to enable monitoring of water quality in a shrimp farm. Firstly, the key monitoring parameters for the characterization of water quality are highlighted and their desired operational ranges are summarized. These parameters directly influence shrimp survival and healthy growth. Based on the considered sensing modality, a reference architecture for implementing a cost-effective FANET based mobile sensing platform is developed. The controlled mobility of the platform is harnessed to increase the spatial monitoring resolution without the need for extensive infrastructure deployment. The proposed solution will be offered to shrimp farmers in the Mexican state of Colima once the laboratory trials are concluded.

### 1. Introduction

Shrimp farming is an important economic activity in many countries, especially in those that possess coastal zones near the tropics and equator [1]. An adequate management of these farms results in economic growth for the nearby communities, since employment is generated in the areas of production, processing, marketing, transport and other related services [2]. To guarantee both shrimp growth and farm profit, water quality control of ponds must be exercised. A necessary step to achieve such control is to carry out a periodic monitoring of the water quality parameters [3, 4]. The growth and survivability of the shrimp is directly related to the physicochemical and five-day biochemical parameters of the water pond [1, 5], and so the maintenance of a healthy reservoir is of fundamental importance.

Monitoring of water quality in shrimp farms is nowadays mainly carried out through manual processes. For example, in some shrimp farms located in the state of Colima, México, the process is performed by a handheld multiparameter measuring device such as the one described in [6]. In small farms, those that have a small number of ponds and span a few hectares of land, the measurements are collected by a person that walks from pond to pond or measurement site to measurement site. At every site, measurements are written down in a notebook for posterior analysis. In large farms, those that span tens or hundreds of hectares, the collection of measurements by a walking person is a prohibitive task. Instead, a motorcycle is often provided to the person, this way speeding up the measurement process while at the same time making the task viable but still extremely demanding.

An alternative to the traditional and time-consuming manual monitoring process is found in the concept of smart farming [7]. This represents a new paradigm in the way agriculture or aquaculture will be carried out in the future. It relies on the use of recent technological developments, in particular on the internet of things (IoT) and on wireless sensor networks (WSNs), to acquire real time monitoring capabilities. The possibility to sense several parameters in real time promises the farmer the opportunity to perform information-based decisions. This will result in the best utilization of resources to increase the productivity of the farm and even the possibility to efficiently control its operation in real time.

The backbone of a smart farm is an ad-hoc network of sensor nodes. This type of communication network possesses no fixed infrastructure and each of its nodes could potentially be free to move within the bounds of the network coverage area [8]. With the advent of unmanned aerial aircraft (UAA) and unmanned aerial vehicles (UAVs), the creation of communication networks where the

communication nodes are positioned on board either UAAs or UAVs has become a possibility. This way, the new concepts of unmanned aerial systems (UASs) [9] or more recently that of flying ad-hoc networks (FANETs) [10], [11] have recently appeared. In a FANET, the UAVs form a mesh network, and communication can take place via multiple hops [11].

The manual monitoring process described before is intrinsically prone to errors due to the repetitiveness of the task; however, it has the advantage of being cheap. Some of the farmers in the state of Colima, México, claim that unless an economically competitive solution exists, they will continue with the manual measuring process. They are fully aware of its disadvantages, but an expensive alternative is just not a viable option. So, let us now analyse whether a smart farm solution can be found that improves upon the manual methodology while, at the same time, provides an economically competitive solution.

One possible implementation might be to employ a WSN. In this approach, a wireless sensor for each parameter of water quality would be installed at each measurement site. This way, measurements can be collected online and sent to the monitoring centre. Data analysis can be carried out by a computer program and, provided the network has actuators, automatic control actions can be taken. This solution eliminates the many inconveniences of the manual methodology, but unless the number of measurement sites is small, the cost will be high. This is because sensors are expensive, and so requiring one sensor for each parameter per site is just not affordable.

Fortunately, a better solution exists, and this is the one that we will propose in this paper. Our proposal consists on the deployment of a FANET, where the sensors will be mounted on one or more drones. Each drone can be programmed with the specific task of following a predetermined trajectory (via GPS) to reach a series of sites. Once the drone gets to a given site, it will land on water, perform the measurements, and fly to the next site. Data can be transmitted as soon as it is obtained. The number of drones can be determined after considering aspects such as the number of sites to sample, the lifetime of their batteries, the time required to perform the measurement task, and the cost. Note that this solution avoids the deployment of many costly sensors, and instead employs a greatly reduced number of sensors proportional to the number of drones. It could be argued that a drone could be more expensive than one sensor; that is indeed true, but a few traditional stationary sensors would quickly outweigh the cost of the single drone or drones. So, this solution is indeed economically viable and represents an interesting application of FANET technology.

Now this paper is organized as follows. Section 2 deals with different aspects concerning the management of a shrimp farm, making special emphasis on the role of water quality in the process. Section 3 describes the wireless sensor technology that we have developed so far, and the proposed FANET-enabled solution is also given in this section. Section 4 introduces the information system architecture that allows us to collect, analyse and display the results of the measurements. Finally, section 5 finishes with our conclusions.

## **2. Shrimp Farming Management**

To succeed in achieving a healthy and sizable production in shrimp culture, water quality management is a matter of the utmost importance. Pond preparation in agreement with good practices is vital in reducing the possibilities of resorting to emergency correcting actions [12]. However, during the culture period itself, variable conditions make it nonetheless necessary to take corrective actions to keep water quality within an acceptable range. For this purpose, water

quality is regularly monitored to have renewed information that allows operators or automatic equipment to react to unfavourable water conditions.

Good quality inlet water is fundamental to shrimp wellbeing; good quality outlet water is necessary to conform to regulations designed to protect the environment. Besides, it is essential to monitor the water characteristics of the ponds to ensure adequate conditions for the shrimp growth. Monitoring of the inlet and outlet water can be done via stationary or nonstationary sensors. However, monitoring many measuring sites in ponds with stationary sensors might be very expensive, and it is here that sensor drones will have a chance, as the cost analysis provided in section 3.4 will elucidate.

## 2.1 Water Quality Characterization and Monitoring

To maintain the water quality of the farm, the parameters that must be contemplated for monitoring and controlling the water conditions need to include physicochemical and biochemical properties [3]. In this paper, only four of the most critical parameters are considered: dissolved oxygen, pH, salinity and temperature. Table 1 lists these parameters and their optimal ranges of operation [13].

**Table 1**

Main water quality parameters and their optimal ranges of operation

Water Parameters	Normal Level
Dissolved Oxygen (mg/L)	>5
pH	6.5 – 9.5
Salinity (ppt)	15 – 23
Temperature (°C)	20 – 30

On the other hand, to prevent water pollution, the wastewater from the shrimp farm must be managed in a safe way according to local regulations. A common characterization of water quality is given by the water quality index as will be explained later.

The number of samples required on a given period for each monitored parameter is related to its importance in the process. Critical parameters need to be sampled several times during the day since the survival of the shrimps depends upon them. For example, low concentrations of dissolved oxygen for a prolonged length of time could be very critical for the shrimp, as they could cause several diseases and be the reason for slow growth. In the case of the pH parameter, if it is below the value of 4, the shrimp might suffer acid death. On the contrary, if it is above 11, the shrimp might face alkaline death [13]. The salinity is another critical parameter for the survival of shrimp, since high salinity levels cause reduction in the levels of dissolved oxygen. As for the temperature, low and high temperature values away from the suggested values in table 1 also yield a low survival rate [14].

These parameters need to be sampled in both the morning and afternoon because extreme values are normally presented during these times of the day. It is highly recommended to follow a protocol that guarantees the measurement of the parameters with calibrated equipment, at the same time of the day and at the same place, preferably at the zone where the shrimps are found in the pond. Also, it is recommended to have a schedule for measuring the selected parameters. A possible sample schedule for the considered parameters is shown in table 2 [15].

**Table 2**

Measurement time schedule

Water Parameter	First Measurement (hrs.)	Second Measurement (hrs.)
Dissolved Oxygen	06:30 - 08:30	13:00 - 16:00
pH	06:30 - 08:30	13:00 - 16:00
Salinity	06:30 - 08:30	13:00 - 15:30
Temperature	06:30 - 08:30	13:00 - 15:30

## 2.2 Sensors for Water Monitoring

### 2.2.1 Dissolved Oxygen Sensor

There are two methods to measure dissolved oxygen: optical or amperometric [16]. The optical sensors determine the dissolved oxygen based on the fluorescence and the duration of the fluorescence generated by an emitter light. The higher the oxygen concentration, the shorter the fluorescence duration. Amperometric sensors are based on electrochemical reactions. In this case, a galvanized dissolved oxygen (DO) probe can be used. For example, one such probe manufactured by Atlas Scientific consists of a teflon membrane, an anode bathed in electrolyte and a cathode. The oxygen molecules pass through the Teflon sensing membrane at a constant speed. Once the molecules have crossed through the sensing membrane, they produce a small voltage between the anode and the cathode. If there is no oxygen, the voltage difference will be 0 mV. As oxygen increases, the voltage output in the probe will increase [17] [18]. This type of DO probe is passive, and it generates a voltage from 0 mV to 40 mV depending on the oxygen saturation in the Teflon sensing membrane. The measuring range of the probe is 0 to 100 mg / L with an accuracy of  $\pm 0.05$  mg / L. An image of the probe is shown in Fig. 1 [17].



Fig. 1. DO probe model ENV-40-DO [17].

### 2.2.2 pH Sensor

The pH measurement requires a tool sensitive to the hydrogen ions, which define the pH value. This tool is a pH sensitive electrode. The measurement of this electrode alone does not provide enough information to determine the pH value and it is necessary to use a second electrode not sensitive to pH. The latter supplies the reference signal for the pH-sensitive electrode. The difference of both sensors determines the pH value of the measured solution.

The selection of the pH sensor should consider the chemical composition of the sensor, the operating temperature, the process pressure, the measurement interval as well as the type of sensor electrode connection [19].

Atlas Scientific manufactures a pH probe that measures the activity of hydrogen ions in water. At the tip of the probe there is a glass membrane that allows the hydrogen ions to dissolve in the outer glass layer while the larger ions remain in the solution. This difference in hydrogen ion

concentration creates a small current that is proportional to the concentration of hydrogen ions [18], [20].

This type of pH probe is passive, and it generates a current that can be predicted from the following equation (Nernst Equation [20]):

$$E = E^0 + \frac{RT}{F} \ln(\alpha_{H^+}) = E^0 - \frac{2.303 RT}{F} pH$$

where  $E$  is the measured potential in volts,  $E^0$  is the cell potential at standard-state conditions in volts (standard potential at  $\alpha_{H^+} = 1$ ),  $R$  is the ideal gas constant (8.314 J/mol-K),  $T$  is the temperature in Kelvin degrees and  $F$  is the Faraday constant (96485.3365 C mol<sup>-1</sup>). The measuring range of the probe is from 0 to 14 with an accuracy of  $\pm 0.0002$ . An image of the probe used is shown in Fig. 2 [19], [20].



Fig. 1. pH probe model ENV-40-pH.

### 2.2.3 Salinity Sensor

Salinity is the amount of salt dissolved in water. As the conductivity and salinity are related, the salinity sensors determine the conductivity of a liquid in order to measure its salinity. There are two types of salinity sensors:

A. Conductive sensors [21], [18]. They measure the ability of a solution to conduct electric current between two electrodes. The current flows in the solution through the transport of ions. An increase in the concentration of ions causes high values of conductivity.

B. Inductive sensors [22], [18]. They use two coils next to each other, which are encapsulated in a ceramic or plastic structure. A time varying magnetic field is generated in the transmitter coil, which induces a voltage in the liquid that charges the ions. This generates an alternating current, which is detected in the receiver coil. The intensity of the current depends on the free ions in the liquid.

Atlas Scientific manufactures an E.C. (Electrical conductivity) probe, which measures the electrical conductivity in water. This is then a conductive sensor type of probe. Inside the probe, two electrodes are placed opposite each other, and an alternating current voltage is applied, which causes the cations to move to the negatively charged electrode, while the anions move to the positively charged electrode. The freer electrolyte the liquid contains, the greater the electrical conductivity [23].

This type of conductivity probe is very simple. The measuring range of the probe is from 5 to 200,000  $\mu\text{S}/\text{cm}$  with an accuracy of  $\pm 0.2\%$ . An image of the probe is shown in Fig. 3 [23].



Fig. 2. E.C. probe model ENV-40-EC-K1.0.

### 2.2.4 Temperature Sensor

The temperature can be defined as the amount of heat energy of an object or system. The calorific energy is related to the vibration, friction and oscillation of particles within a molecule.

Temperature sensors detect the change of a physical parameter, such as the resistance or the voltage that is a function of the change in temperature [24], [18]. There are two types of temperature sensors:

By contact: The sensor is in contact with the medium or object to be sensed.

No contact: The sensor captures the radiant energy of the heat source.

In the case of temperature monitoring for shrimp farms, the sensors commonly used are contact sensors. Atlas Scientific manufactures a PT-1000 model probe. This is a resistive type thermometer, where PT means that the material used is platinum and 1000 is the resistance measured at 0°C in ohms. As temperature changes platinum resistance will change. The formula that gives temperature as a function of the change in resistance is [11]:

$$T = -\frac{\sqrt{(-0.00232(R) + 17.59246) - 3.908}}{0.00116}$$

where  $T$  is the temperature in degrees Celsius and  $R$  is the measured resistance of the probe. The measuring range of the probe is -200°C to 850°C. An image of the probe is shown in Fig. 4 [25].



**Fig. 3.** Temperature probe model PT-1000.

### 2.3 Water Quality Control

Water conditions in ponds are very important in the farming process and should be controlled, since their deterioration can provoke shrimp diseases, decreased growth and lower survival rate. Control of the process can be done manually by the operators or it can be automated. During the culture period, the most important parameters for the quality of the water in the ponds are monitored and kept within acceptable ranges to avoid damage to the culture. As stated before, the parameters we consider here are dissolved oxygen, pH, salinity and temperature.

If the levels of dissolved oxygen are low, aerators could be used [26]. Paddle wheel aerators are preferred over air injectors, but the former are not recommended for pond depths greater than 1.2 meters. The paddle wheel aerators are made from an electric motor connected to a set of paddles. The paddles rotate and produce a water spray that is saturated with oxygen. At the same time the rotation action results in a circulation of water, and this way the oxygenated water of the surface is exchanged with the water at the bottom. Fig. 5 shows a paddle wheel aerator (left), in operation (right).



**Fig. 5.** (left) Paddle wheel aerator. (right) Paddle wheel aerator in operation. Taken from Sagar Aquaculture equipment catalogue.

An alternative to the paddle wheel aerators is to exchange the water in the ponds [12]. Before doing this, the water conditions of the influent must be checked to ensure they are better than those of the recipient pond. In any case, the measurements taken must be of a preventive nature to avoid the dissolved oxygen decreasing to a critical condition [26]. Both methods consume a great deal of energy, and their utilization should be carefully evaluated.

When the pH is low (<7), sediments or organic matter can be removed to help decrease the concentration of CO<sub>2</sub> which, in turn, increases the pH value [27]. Alternatively, lime or slaked lime can be spread around the pond [12]. But, if the pH is high (>8.3), it can be reduced with the use of sugar or with the utilization of probiotics to promote microbial decomposition with a resulting increased production of CO<sub>2</sub> [28].

Low levels of salinity can be raised with the use of saltwater. When salinity goes up, for example during dry hot seasons, the water lost by evaporation must be replaced. Using fresh water is not a recommended practice because of excessive cost and the negative impact on the nearby community that urgently needs that water [26]. Water exchanges of 10 to 15 % per day are adequate to maintain good salinity levels, even if only sea water is used for the exchange [12]. During hot seasons, the temperature can also be controlled by means of a standard cooling cabinet [29], [30]. During cold seasons, the temperature can be increased using solar heaters [31, 32]. In super-intensive cultures, temperature is kept under control in closed greenhouses [33]. Frequent monitoring of the main parameters that influence water quality enables a swift response to changing conditions. Dissolved oxygen is the single most important parameter in aquaculture [12], and techniques to increase its level are energy intensive. Another advantage of continuous monitoring is that it allows saving of precious energy by activating aerators or pumps only when strictly necessary, thus generating large savings in the farming process.

## **2.4 Data Management**

The automatic permanent monitoring of the shrimp farming process produces a vast amount of information, which is stored, organized and analyzed by the application. This information is used to trace the conditions in each part of the process to identify deviations and implement preventive action during the next culture cycles, thus reducing costs and increasing production. Also, statistical data is generated to report to executives and to competent authorities [26]. In order to reflect the overall condition of the water in the ponds in a simple and easy to understand form, a water quality index is habitually used.

### **2.4.1 Water Quality Index (WQI)**



Water quality is a function of a set of physical, chemical and biological parameters. One way to describe the quality of water is by listing the concentration of the parameters in the water sample. The number of parameters considered depends on the needs and the budget of the farm. This approach makes it difficult to compare the quality of water samples from different sources. The water quality index (WQI) aims to solve this problem by assigning a numerical value to water quality. This value serves as a global indicator of the combination and concentration of the different water parameters. Besides, the WQI helps in decision making, reporting, development of standards and procedures, trend analysis and research.

The development of the water quality index consists of four steps [34]: 1) parameter selection; 2) transformation of the different units to a common scale; these units are known as sub-indices; 3) allocation of weights to each parameter; and 4) aggregation of sub-indices. The general process to obtain the water quality index is as shown in Fig. 6. The set of selected parameters to be included in the computation of the WQI is denoted by  $(P_1, P_2, \dots, P_n)$ . In our case  $n=4$ , and  $P_1$ =temperature,  $P_2$ =dissolved oxygen,  $P_3$ =pH and  $P_4$ =salinity. From each parameter, we obtain its respective sub-index  $S_i$ , which is calculated through a function  $S_i = f(P_i)$  that converts all parameters to a common scale. This function can be linear, non-linear, linear by parts or non-linear by parts. The water quality index is the result of the combination of all  $S_i, \{i = 1, 2, \dots, n\}$ . The aggregation may consist of an operation of addition, multiplication, establishment, enhancement or logical function. The allocation of weights is done at this stage.

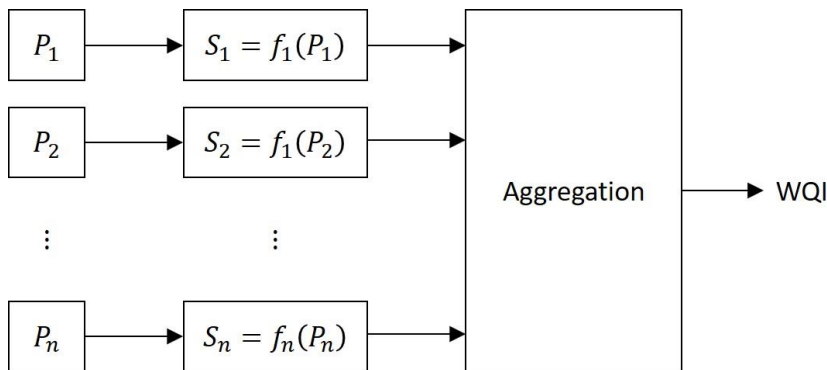

**Fig. 6.** Process for obtaining the water quality index (WQI).

The development of a water quality index has a strong component of subjectivity due to the criteria used in each step. The selection of parameters and the assignment of weights suffer from this to a greater extent. Subjectivity can be reduced through the consent of many experts [35]. In this process, much attention, experience and knowledge are needed to ensure that the most representative parameters are included in the water quality index.

To increase objectivity and deal with uncertainty and insufficiency of the parameters, different methods have been proposed to compute the water quality index. These are classified into three categories: a) Statistical, b) Probabilistic or stochastic, and c) Based on fuzzy logic. The indexes based on statistical methods determine the importance of each parameter according to their statistics and the correlation they have with other parameters [36-40]. This reduces subjectivity; however, it has the disadvantage of being complex and difficult to apply. The probabilistic or stochastic methods consider that each parameter is a random variable  $x$ . The probability density function of the random variable,  $f(x)$ , is itself an indicator of the water quality conditions [36, 41, 42]. Consequently, the parameters that characterize  $f(x)$  are measures of water quality. The indexes of this type try to determine the probable quality of the water over time. The water quality indices based on fuzzy logic are built upon the concepts of fuzzy set theory. Here, a set of

parameters is mapped to a set of outputs using fuzzy logic [1, 43-47]. Fuzzy logic translates statements from natural language into a mathematical formalism and can adequately deal with the subjective nature of the environmental effects and the uncertainties and inaccuracies in data or knowledge.

We now give a very simplified example (based on [1]) of the use of fuzzy logic to obtain the WQI, where the steps in the process of Fig. 6 are explained. The selected parameters  $P_1$  and  $P_2$  in this example are temperature ( $T$ ) and dissolved oxygen ( $DO$ ), and the computation of the WQI is based on the following two rules.

**Rule 1:** If  $T$  is normal and  $DO$  is normal, then WQI is excellent.

**Rule 2:** If  $T$  is normal and  $DO$  is low, then WQI is good.

Let us assume that the measurements obtained are  $T = 23^\circ\text{C}$  and  $DO = 6.3 \text{ mg/L}$ . The following step is to get the sub-indices, which convert these values to a common scale, usually between 0 and 1. In crisp logic, if the temperature, for instance, is the range considered normal, the statement “ $T$  is normal” is given a value of 1; otherwise, the value 0 is given. In fuzzy logic, on the other hand, the statement “ $T$  is normal” is given a value between 0 and 1 that reflects how much the temperature belongs to the level considered normal. This is done through the so-called membership function  $\mu_{T-n}(x)$  (where “ $n$ ” refers to “normal”) as the one shown in Fig. 7. (left). Similar membership functions must be defined for each statement that appears in the given rules. These are shown in Fig. 7 (right) for the statements “ $DO$  is low” and “ $DO$  is normal”, and in Fig. 8 for the statements “WQI is good” and “WQI is excellent”. Rules and membership functions are built with the help of experts. In practice, several parameters and many more rules must be considered.

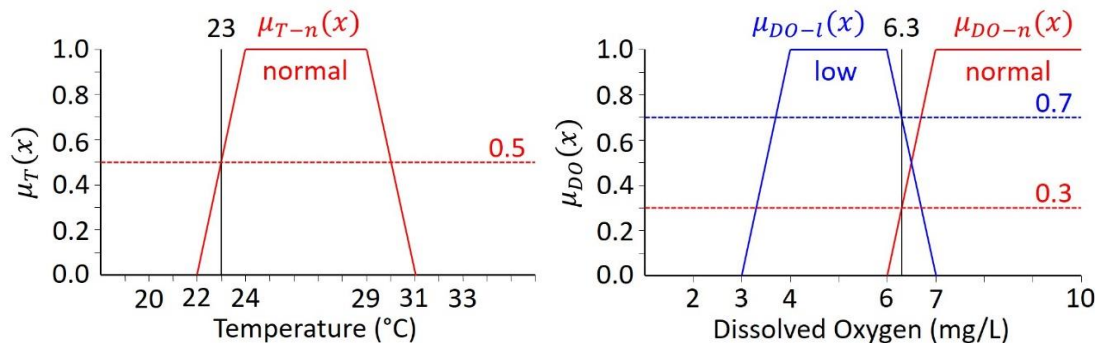

**Fig. 7.** (left) Membership function for “ $T$  is normal”. (right) Membership functions for “ $DO$  is low” and “ $DO$  is normal”.

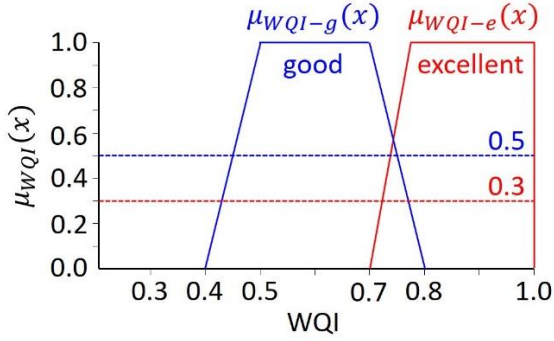

**Fig. 8.** Membership functions for “WQI is good” and “WQI is excellent”.

To compute the degree of validity of the premises in Rules 1 and 2 ( $PR_1$  and  $PR_2$ ), we use the following definition of the fuzzy AND operator:  $\mu_{A \cap B}(x) = \min\{\mu_A(x), \mu_B(x)\}$ . Thus

$$\mu_{PR_1}(x) = \min\{\mu_{T-n}(23), \mu_{DO-n}(6.3)\} = \min\{0.5, 0.3\} = 0.3,$$

$$\mu_{PR_2}(x) = \min\{\mu_{T-n}(23), \mu_{DO-l}(6.3)\} = \min\{0.5, 0.7\} = 0.5.$$

The degree of truth of the rules is then evaluated using the WQI membership functions and the MIN operator as the definition of fuzzy implication [43]. Thus

$$\mu_{R_1}(x) = \min\{\mu_{PR_1}(x), \mu_{WQI-e}(x)\} = \min\{0.3, \mu_{WQI-e}(x)\},$$

$$\mu_{R_2}(x) = \min\{\mu_{PR_2}(x), \mu_{WQI-g}(x)\} = \min\{0.5, \mu_{WQI-g}(x)\}.$$

These are shown in Fig. 9 (left). The operation of aggregation of these results is achieved through the MAX operator, and it is shown in Fig. 9 (right),

$$\mu_{out}(x) = \max\{\mu_{R_1}(x), \mu_{R_2}(x)\}.$$

Other definitions are possible for the fuzzy AND operator and the fuzzy implication; aggregation is almost always carried out through the MAX operator [43].

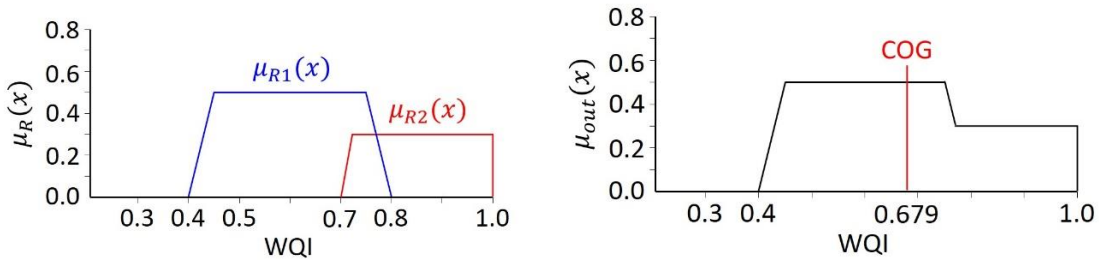

**Fig. 9.** (left) Fuzzy implication of Rules 1 and 2. (right) Aggregation operation.

Finally, a single value of WQI must be obtained from the aggregation function. This is called defuzzification and it is commonly done by computing the center of gravity (COG) of  $\mu_{out}(x)$ .

$$WQI = \frac{\int x \mu_{out}(x) dx}{\int \mu_{out}(x) dx} = 0.679$$

### 3. Proposed Water Quality Monitoring Approach

#### 3.1 WSN vs FANET

Taking into account the elements presented in the previous sections, it is now possible to introduce an abstract formulation of the monitoring problem in a shrimp farm. Let us first assume that, after careful evaluation, it has been determined that a total of  $N$  positions need to be sensed and that at every sensing point, the monitoring of  $K$  different parameters is required.

Furthermore, the measurements must be transmitted, stored and processed at the control room. There is more than one way to achieve the objective and two distinct approaches are detailed next.

A conventional wireless sensor network represents one possible solution. In this case, every wireless sensing device (WSD) possesses its own communication and sensing capabilities. The monitoring system would then be composed of  $NK$  WSD's plus one radio node, which acts as an access point for the computer in the control room. If the number of sites ( $N$ ) and the number of parameters ( $K$ ) are small or manageable, a WSN represents a viable solution. However, for a fixed value of  $K$  (in our case  $K=4$ ), if the number ( $N$ ) of monitoring sites is large, the deployment cost of a fully-fledged WSN could easily become prohibitive. In this case a better approach is to rely on a FANET instead of on a WSN, as explained next.

To reduce the number of components of the system when  $N$  is large, a FANET can be considered that employs  $M$  drones equipped with a complete set of  $K$  sensors each. If the farm's area is large, it will be necessary to install a number ( $L$ ) of fixed network nodes on the ground that will act as a backbone for the FANET. This way, the total number of radios is reduced from  $N+1$  to  $M+L+1$  (here we consider that  $L+M \ll N$ ) and the total number of sensors is reduced from  $NK$  to  $MK$ . Depending on the scenario, the reduction could indeed be considerable. In section 3.4 a cost analysis is presented that elucidates the amount of savings that could be obtained.

The next section describes the characteristics of the sensor and communication components that are at our disposal. They provide the building stones for the practical implementation of the solution approach put forward in the previous paragraph.

#### 3.2 Technological Achievements

In 2018, CINVESTAV-IPN, the University of Leeds and TTR México, participated in a project supported by the British Council's Newton Fund under grant number 275835. The project had the objective of developing sensing technology to monitor water quality, especially for water treatment plants [48]. When the project started, TTR already possessed a wireless mesh networking system based on the IEEE 802.15.4 standard, and although their system included some sensing capability, it did not have sensors for water quality monitoring. This way the project focused specifically on the design and development of this type of sensors. Fig. 10 shows one of the developed sensors. The sensor portrayed in the figure measures pH and is composed of the processing unit and the probe. The core can communicate via an RS-485 bus and performs all the firmware functions required to carry out the measurement process.



**Fig. 10.** pH sensor.

TTR sensing technology, plus its enhancement provided by the Newton funded project mentioned before, is designed to provide flexibility and robustness in the design of wireless sensor networks [49]. The hardware architecture of TTR's radios is illustrated in Fig. 11. Depending on the function of the radio some communication ports could be inactive, as will become clear later.

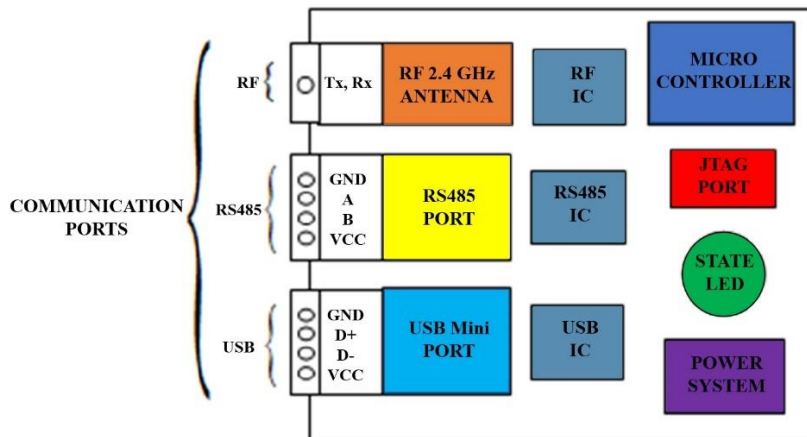

**Fig. 11.** Hardware architecture of TTR's radios.

Fig. 12 shows several components of the aforementioned wireless sensing technology, including the water quality monitoring sensors. The operation of the different components portrayed in Fig. 12 is described in what follows. Let us begin with the hub radio. This component communicates to the central controller (a personal computer) via an USB port. The hub radio allows the controller to interact with the sensors and actuators via the communication network facilities. The USB port also provides the required energy for the hub to operate. The second component that will be

described is the router radio. Router radios serve to form a backbone for the network. They are installed at fixed locations and provide coverage for the whole area. They are normally powered via a power unit. This unit converts the AC line voltage into DC voltage, which can be directly supplied to the router radio. The third component is the sensor radio. Sensor radios have sensors and possibly actuators connected to them via an RS-485 bus. Energy can be supplied to them by using power units similar to those employed in the case of router radios or by means of batteries when they are mounted on board the drones.

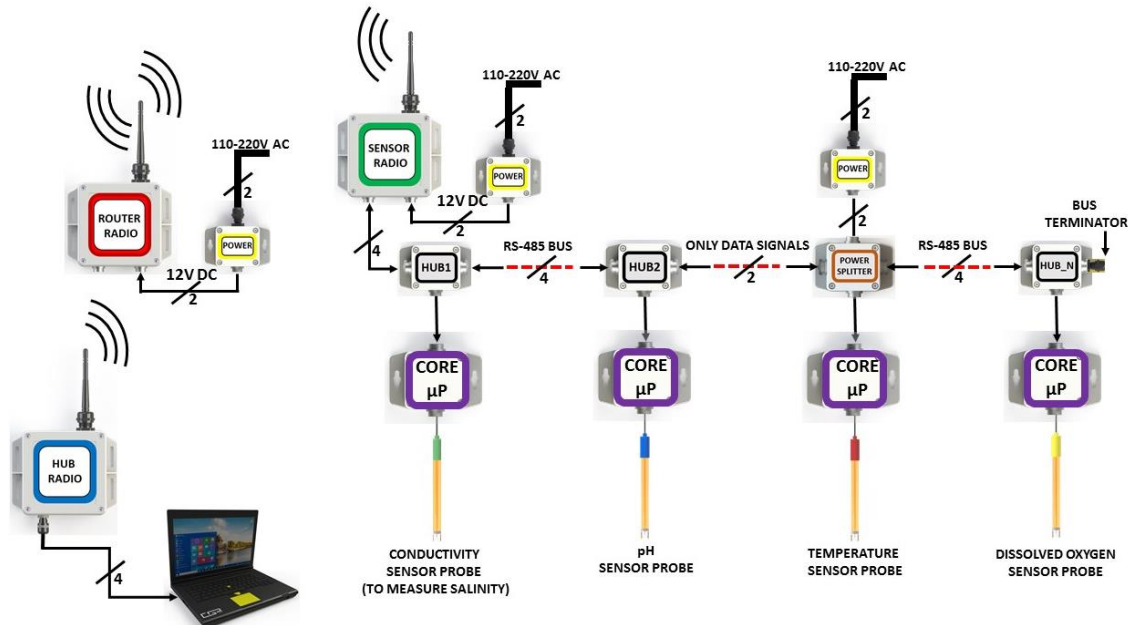
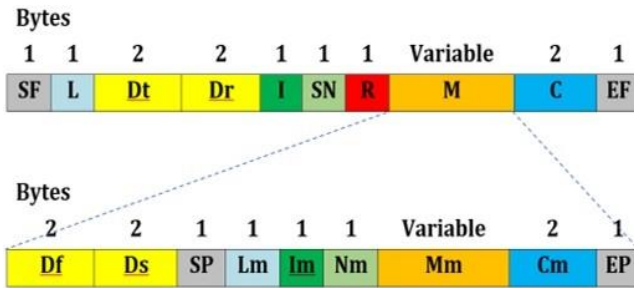

Fig. 12. Components of the existent wireless sensing technology.

Fig. 13 presents the frame format that the central controller must follow in order to communicate with the different radios and sensors in the system. The fields have the following definitions and uses. The **SF** and **EF** fields serve to signal the start and the end of a frame. The byte **L** indicates the frame length, excluding the **SF** and **EF** bytes. The **Dt** and **Dr** fields respectively carry the transmitter and receiver addresses. The byte **I** stands for the instruction or command. **SN** carries the sequence number of the frame generated by the transmitter. The byte **R** is reserved but could be used by certain instructions. The **M** field contains the data of the frame. It is a variable length field and, depending on the value of the **I** field, it can be present or not. That is, some commands are accompanied by an **M** field while others are not. The field **C** incorporates the bytes resulting from the cyclic redundancy check of the whole frame, excluding the frame delimiters. The data field **M** is itself formatted as follows. The **Ds** and **Dd** fields respectively carry the source and destination addresses. In a typical monitoring scenario, the source could be the central controller and the destination could be one of the sensors. It is important to highlight the difference between the **Dt** and **Dr** fields and the **Ds** and **Dd** fields. The former are used in a point to point link while the later make end to end communication possible. The bytes **SP** and **EP** are the packet delimiters. The bytes **Lm**, **Im** and **Nm** respectively carry the packet length, instruction and the end to end sequence number. The field **Mm** contains the actual data to be delivered to the destination. Finally, the field **Cm** incorporates the bytes resulting from the cyclic redundancy check of the packet.



**Fig. 13.** Frame format of TTR's wireless sensing networks.

Fig. 14 below shows a typical message exchange, obtained with the logic analyzer exhibited in Fig. 15, between a sensor radio and a generic temperature sensor that obeys the frame format introduced before. First the radio sends a message, using a universal asynchronous receiver transmitter (UART) interface, to a temperature sensor. The message was produced by the radio as a result of a request made by the central controller. This message is printed in red at the bottom left of the figure. The sensor replies with an acknowledgement message, indicating that the data (normally a measurement request) has been received. This reply is printed in orange on the line above and to the right of the first message. After the unavoidable processing time, the sensor emits its response (the other orange colored message shown at the upper right) that carries the requested measurement. Finally, the radio acknowledges the transmission from the sensor by responding with the red colored message at the bottom right. The packet received from the sensor can now be forwarded, from the sensor radio to the central controller, using the network facilities.



**Fig. 14.** RS-485 bus message exchange.



**Fig. 15.** Photograph of the logic analyser connected to the RS-485 bus.

Fig. 16 shows a close up of the acknowledge message sent by the sensor radio in Fig. 15. The hexadecimal values of the bytes that compose the packet can be directly observed. This is possible because the logic analyser possesses the capability of decoding the serial transmission. It can be observed in the figure that the frame delimiters have values **SF**=0xFE and **EF**=0xEF. The frame length is **L**=0x0A (**L**=10 bytes excluding the delimiters). The transmitter (sensor radio) address is **Dt**=0x3081 while the receiver (sensor) address is **Dr**=0xD200. The radio address can also be seen in Fig. 12. The instruction is **I**=0xFC which corresponds to an acknowledge command. The sequence number is **SN**=0x97 while the reserved field is **R**=0x01 and indicates that the packet was successfully received. There is no **M** field and finally **C**=0x39B4.



**Fig. 16.** The acknowledgement message sent by the sensor radio.

The technology exhibited in Fig. 12 has been installed on a water treatment plant in the state of Jalisco, México. One important feature is that a sensor radio can have any kind of sensor connected to it. There is not a specific connection port for sensors that other brands have. This is because all sensors are designed as smart sensors, e.g., they communicate with the sensor radio through a RS-485 communication bus and use the proprietary transfer protocol whose frames were described above. All the hardware is ready to be installed outdoors thanks to the IP65 compliance of the enclosures. The monitoring system was also offered to the shrimp farmers, but as was stated before, they commented that they will be interested in using it, but provided the cost is acceptable. Because the number of sensors required by a typical shrimp farm is much larger than that required by a water treatment plant, the solution portrayed in Fig. 12 is not feasible for a shrimp farm. However, provided UAVs are added, the WSN that appears in Fig. 12 can be transformed into a full-fledged FANET plus the addition of a few router radios acting as a backbone to guarantee coverage. This way the resulting system might be viable for a shrimp farming application, as will be explained in the following section.

### 3.3 Proposed System

A diagram that shows the most important components of a shrimp farm is given in Fig. 17. As explained in [50], the first stage of the farming process is that of nurturing the larvae inside the larval rearing tanks. In these tanks, dissolved oxygen is maintained with the help of aeration pumps. When the larva grows and becomes post-larva, it is transferred from the larval rearing tanks to the intensive ponds, where it is nurtured until it becomes a subadult and is ready for harvesting. In the intensive ponds, paddle wheel aerators are employed to increase dissolved oxygen concentration when necessary.

In Fig. 17, a radio node is placed on each of the  $M$  drones. Other  $L$  router radios are placed on the ground forming a backbone. The router radios are included in the network with the main purpose of guaranteeing coverage within the whole farm. The drones (UAVs) are equipped with one monitoring sensor per water quality parameter, that is,  $K=4$  sensors in our case.



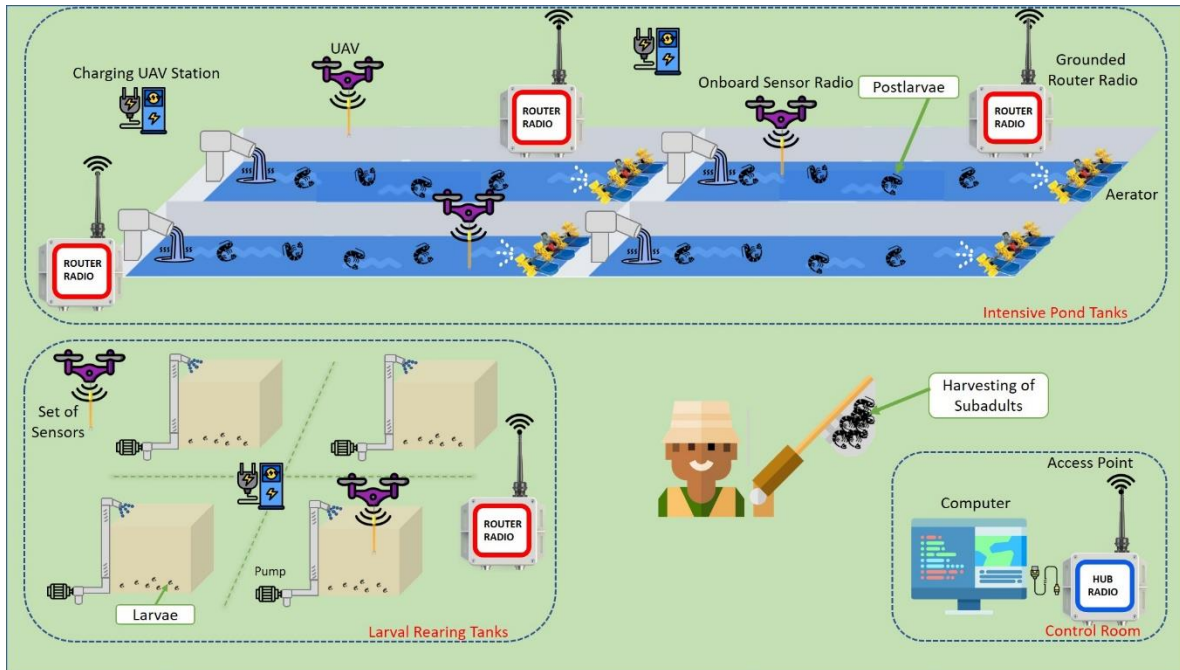

**Fig. 17.** The proposed FANET approach to water quality monitoring in shrimp farming.

The operation of the monitoring system is as follows. Organization of the tasks that the UAVs must perform to obtain the measurements is configured in the control room. Monitoring is also carried out in this room, where alarms can be triggered if the water quality is out of range. A computer is in the control room. It runs a special program, described in the following section, to organize the drones, collect the measurements, analyse the resulting data, and finally perform some action or prepare a report. Some possible actions could be triggering alarms or switching aeration pumps or aerator paddle wheels on and off. This computer connects to the FANET and the backbone through the hub radio labelled “Access Point” in the figure. The diagram also includes some charging stations for the UAVs. These stations are important because the lifetime of the batteries that power the UAVs is limited, and recharging them, preferably in an automatic way, is mandatory.

To summarize, the benefits of the use of FANETs in shrimp farms come from the salient features of ad-hoc networks. The self-configuring properties of the FANETs produce flexibility and adaptive capabilities. The FANET is an ad-hoc network composed of mobile wireless nodes (UAVs). On one hand the mobile capabilities of UAVs will bring benefits and savings, avoiding the massive deployment of expensive sensors. On the other hand, the network connectivity will be supported by the fixed wireless nodes, increasing the coverage and providing robustness to the system; the routing protocol might provide multiple routes to a single destination when the number of fixed and mobile nodes is increased. Such redundancy in the number of nodes could be dimensioned considering the propagation conditions of the terrain and other impairments to the radio signals. The control room consists of a gateway or access point to backbone and FANET. This gateway is used by the information system to communicate with the rest of the nodes of the network, perform tasks such as the retrieval of data from the sensors and the delivery of commands to actuators.

### 3.4 Cost Analysis

Besides the innovation and technological advantage of TTR's technology, there is another advantage; the cost of TTR's technology. A straightforward implementation, via the WSN approach, would consist of the installation of a sensor radio in each tank or pond along with the four required sensors: temperature, dissolved oxygen, pH factor and salinity. Therefore, if there are  $N$  monitoring points needing  $K$  sensors each, the total number of sensors is  $NK$  as stated in a previous section. Considering that the prices of the sensors are around \$250 dollars each, the cost of the sensing equipment for different farm sizes can be estimated. For example, a very small farm where  $N=5$  will need 20 sensors and that makes a total of \$5,000 plus the cost of  $N=6$  sensor radios (5 for the sensing locations plus 1 for the control room) at \$500 per radio results in \$3,000 giving a grand total of \$8,000. However, a big farm can easily have  $N = 100$ , and this implies  $NK = 400$  sensors with a total cost of \$100,000 plus 100 radio sensors which will give a grand total of \$150,000. On the other hand, with the proposed FANET complemented by a small backbone, the cost can be greatly reduced when  $N=100$  since only the UAVs are equipped with the four sensors. For example, considering that  $L=10$  radios are employed to form the backbone of the network and  $M=5$  UAVs with four sensors each, only 20 sensors are needed and the total cost will be \$5,000 for the radios plus \$5,000 for the sensors plus \$25,000 for the drones (at around \$5,000 per drone) resulting in a grand total of \$35,000. This represents a considerable saving.

#### 4. Information System

In order to produce automatic remote monitoring and control of the shrimp farm, several technologies must be integrated. In this endeavour, a combination of a sensor-FANET-ad-doc wireless network, database engines, web servers and clients would let the users on remote smartphones/computers obtain information from sensors. The system offers an innovative IoT application that would exhibit its great potential as an emerging technological solution. An overview of a possible suggested model for the system we propose is shown in Fig. 18.

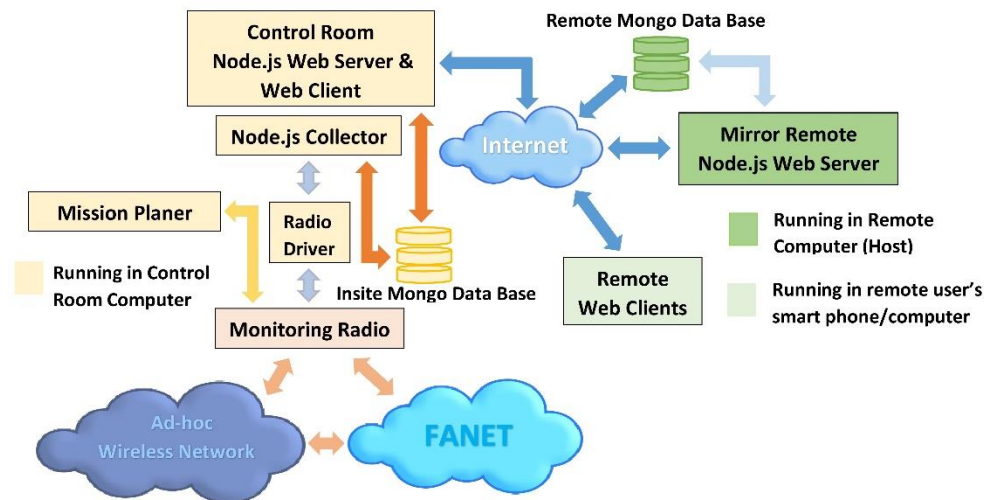

**Fig. 18.** Proposed model for the automatic remote monitoring and control system.

The above components are geographically distributed as follows:

- 1.- An in-site Information System;
- 2.- A remote mirror database and web server (Hosting);

### 3.- Remote monitoring display devices (smartphones/computers).

As mentioned earlier in section 3, the FANET and the ad-doc wireless network, which form part of the information system, provide the local monitoring and control of the processes of the farm. The information system gives automatic features; this means to retrieve and store data automatically in the local database or execute control actions. This could be possible by the utilization of the information provided by the user in the setup process through the web client. The collector program implements all the tasks needed to send queries to the involved devices. This information is communicated to the sensor network using a protocol implemented in the radio driver. The mission planner is used to set up the AUV's, the missions to be executed by them and the places where the samples must be taken. The remote mirror database is periodically updated with the data stored in the local database; the same information is shared remotely to the hosting web server and the web clients used for smartphones and computers.

#### 4.1 Service Oriented Architecture of the Information System

The information system is structured in a service-oriented architecture with four layers: sensing, network, service and interface layers [51].

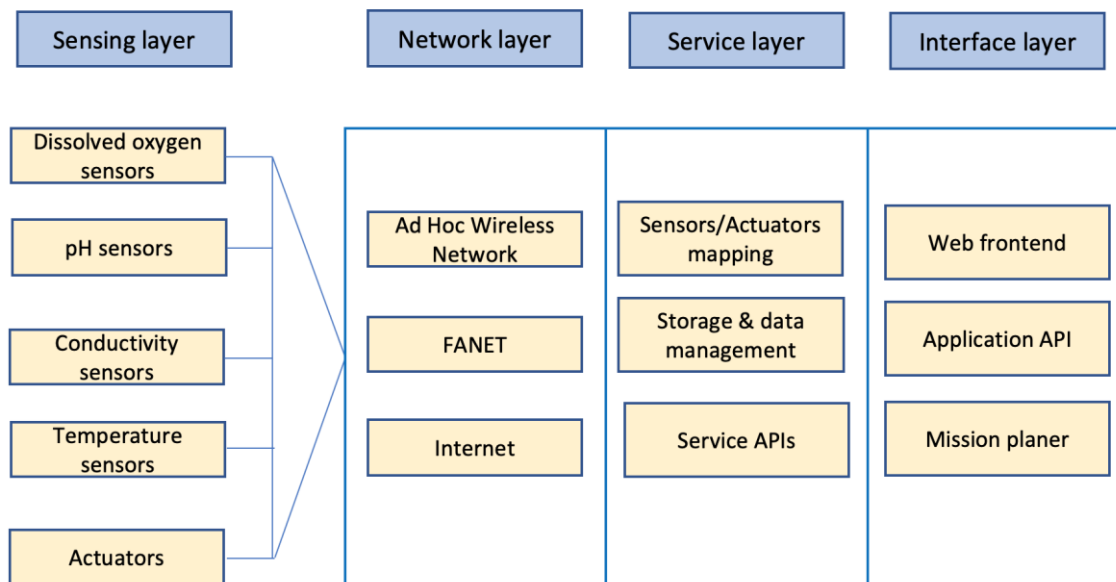

**Fig. 19.** Service Oriented Architecture of the Information System.

As is shown in the Fig. 19, the sensing layer contains the dissolved oxygen, pH, conductivity and temperature sensors; this layer also includes the actuators required for switching on/off the aeration pumps. All these components send and receive information through the network layer, particularly the first link of the communication chain is formed by the ad-doc wireless network and FANET, which retrieve data generated by the sensors and deliver commands to the actuators in the system. The network layer transports information to remote and local clients and servers connected to Internet; therefore, an application-level gateway is typically used for the interconnection between the Internet and the sensor network. The service layer manages the devices, provides a full mapping of them and associates the corresponding functions for each sensor and actuator with predefined services; for instance, it recognises the type of sensor and

builds an abstract object with its attributes and service methods. It offers storage and processing of data and an API for the interaction with the interface layer. Finally, the interface layer serves the graphical user interfaces (GUIs) as those available in the web clients and the mission planner, it processes and delivers data in a proper format for the GUIs, which render information using graphical components like charts, maps and graphs. The interface layer allows the integration of more applications through an API, which allows interaction with the system using a high-level abstraction interface.

## 4.2 Graphical User Interfaces (GUIs)

There are two types of GUIs in the proposed system:

- 1.- Web clients;
- 2.- The mission planner.

### 4.2.1 Web clients

The control room and the remote web clients could allow to set up the monitoring and control features of the process and display the acquired sensor's information in real-time. The web clients should control the access to the setup procedures and must define attributes for each user. The system settings can be configured by using these GUIs. For instance, parameters of the fixed and mobile nodes must be specified, such as nodes IDs, sensors IDs, and actuators IDs. Another feature is to display the sensor information in real-time; for fulfilling all these requirements, we use web technologies implemented with node.js [52], which is a well-known JavaScript runtime environment.

#### 4.2.1.1 Automatic and Manual Controls

The control room web client offers setup and control functionalities. An automatic mechanism for controlling actuators such as pumps and aerators could be configured by an operator. For instance, a reactive action such as switching on a pump could be the consequence of certain parameters attaining a value outside an established range.

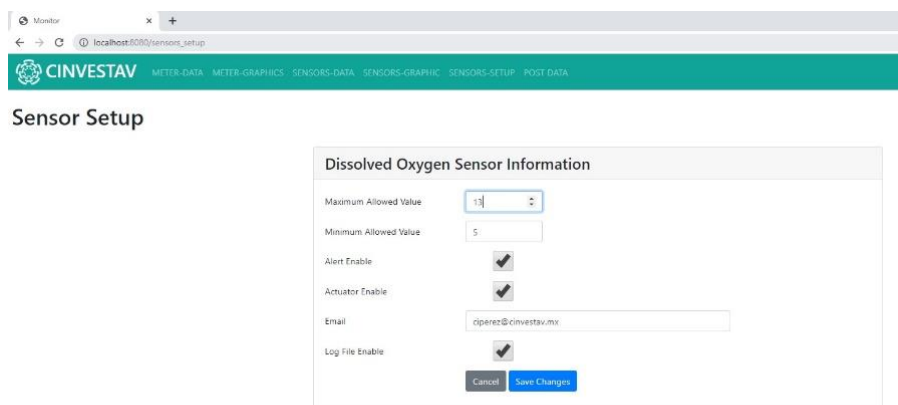

Fig. 20. Example of a sensor alarm setup.

As an example, in Fig. 20, it is shown several required alarm options for a dissolved oxygen sensor to execute notifications and control tasks. These are the maximum and minimum allowed values, enable/disable an actuator, the alert and the log file generation, and the email address for delivering notifications.

### 4.2.1.2 Sensor Data Visualisation

When the user selects this option, the room or remote web client is used for displaying the data collected from the set of sensors deployed in the shrimp farm. An example of real-time data acquisition is shown in Fig. 21. This is a screen capture of a personal computer browser; it exhibits real data obtained from the temperature, dissolved oxygen, and pH sensors, which is shown using graphical components. Such data is obtained from a database; and can also be displayed in a table format, as depicted in Fig. 22.

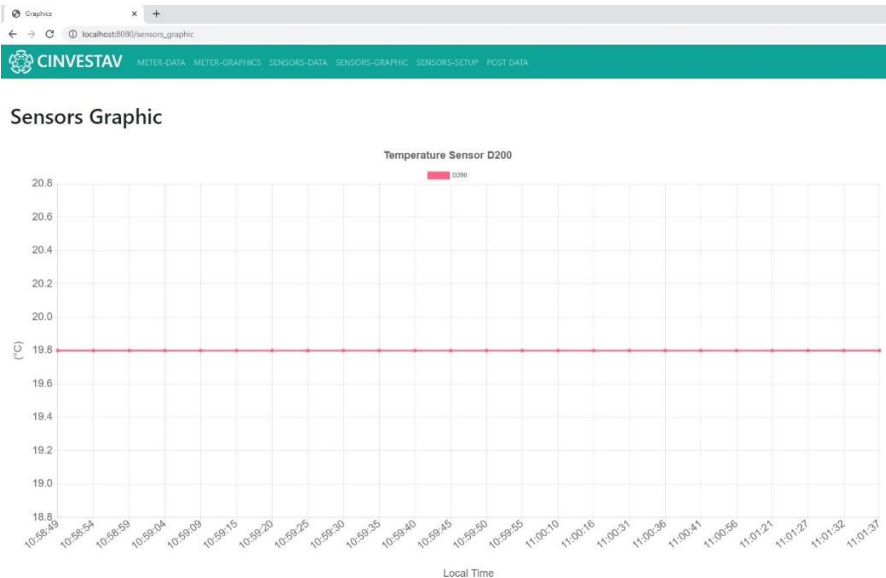

Fig. 21. (a)

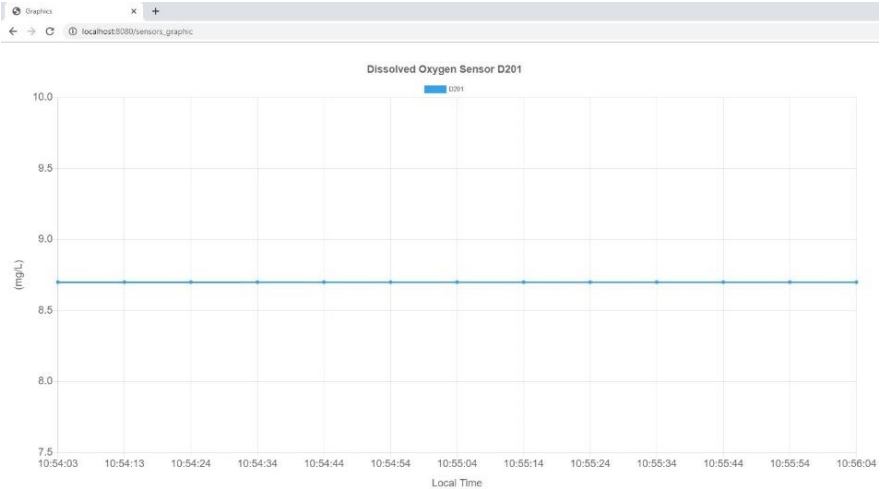
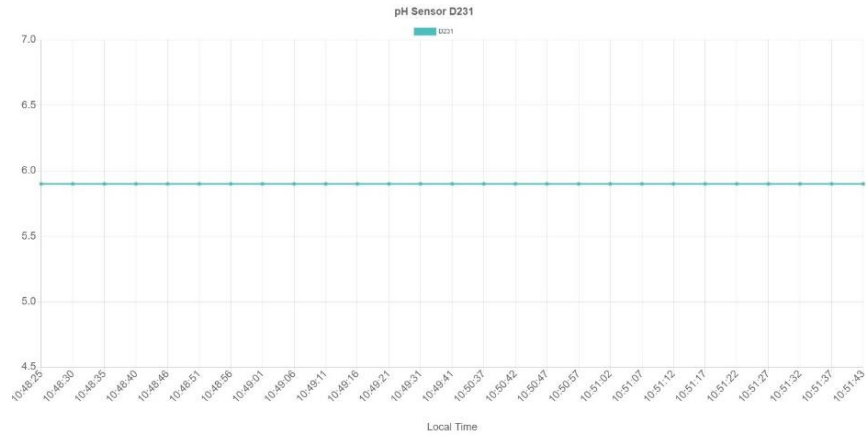

Fig. 21. (b)



**Fig. 21. (c)**

**Fig. 21.** Automatic remote real time monitoring of: a) Temperature, b) Dissolved oxygen and c) pH sensors.

The screenshot shows a web browser window with the URL localhost:8080/sensors. The page title is 'Sensors Data'. Below the title is a table with the following data:

Temperature Sensor	Date	Local Time	Value (°C)
D200	2019-12-20	11:00:41	19.8
D200	2019-12-20	11:00:56	19.8
D200	2019-12-20	11:01:21	19.8
D200	2019-12-20	11:01:27	19.8
D200	2019-12-20	11:01:32	19.8
D200	2019-12-20	11:01:37	19.8
D200	2019-12-20	11:01:46	19.8
D200	2019-12-20	11:01:51	19.8
D200	2019-12-20	11:01:56	19.8
D200	2019-12-20	11:02:01	19.8
D200	2019-12-20	11:02:07	19.8
D200	2019-12-20	11:02:12	19.8

**Fig. 22. (a)**

The screenshot shows a web browser window with the URL localhost:8080/sensors. The page title is 'Sensors Data'. Below the title is a table with the following data:

Dissolved Oxygen Sensor	Date	Local Time	Value (mg/L)
D201	2019-12-20	10:56:15	8.7
D201	2019-12-20	10:56:25	8.7
D201	2019-12-20	10:56:35	8.7
D201	2019-12-20	10:56:45	8.7
D201	2019-12-20	10:56:55	8.7
D201	2019-12-20	10:57:05	8.7
D201	2019-12-20	10:57:15	8.7
D201	2019-12-20	10:57:25	8.7
D201	2019-12-20	10:57:35	8.7
D201	2019-12-20	10:57:45	8.7
D201	2019-12-20	10:57:56	8.7
D201	2019-12-20	10:58:06	8.7
D201	2019-12-20	10:58:16	8.7
D201	2019-12-20	10:58:26	8.7

**Fig. 22. (b)**

pH Sensor	Date	Local Time	Value
D231	2019-12-20	10:51:17	5.9
D231	2019-12-20	10:51:22	5.9
D231	2019-12-20	10:51:27	5.9
D231	2019-12-20	10:51:32	5.9
D231	2019-12-20	10:51:37	5.9
D231	2019-12-20	10:51:43	5.9
D231	2019-12-20	10:51:48	5.9
D231	2019-12-20	10:51:53	5.9
D231	2019-12-20	10:51:58	5.9
D231	2019-12-20	10:52:03	5.9
D231	2019-12-20	10:52:08	5.9
D231	2019-12-20	10:52:13	5.9

**Fig. 22. (c)**

**Fig. 22.** Screen capture of an automatic remote real time monitoring of: a) Temperature, b) Dissolved oxygen and c) pH sensors (same data of the previous graphics) shown in a table format.

#### 4.2.2 UAV Settings and Mission Planner

There is a GUI to control the paths an UAV needs to follow, which are known as missions. By using the GUI, it could be possible to set the points where the UAV must perch to acquire the measurements. These application programs can connect to geographical web-based services such as Google maps to directly take the latitude and longitude coordinates of the UAV position. In Fig. 23, we show a snapshot of an application program to set up the mission of the UAV. This GUI, known as Mission Planner (Arduopilot), shows a shrimp farm located on the coast of Mexico. Thus, the information with the selection of the measurement locations on the map and the tasks to be carried out can be communicated to the UAV by USB communication. So, the operator can perform the required calibration and set the values of the parameters required for the UAV to achieve a controlled flight. The mission of the UAV will initiate when the control room web client sends a start command to be interpreted by the flight controller of the UAV.

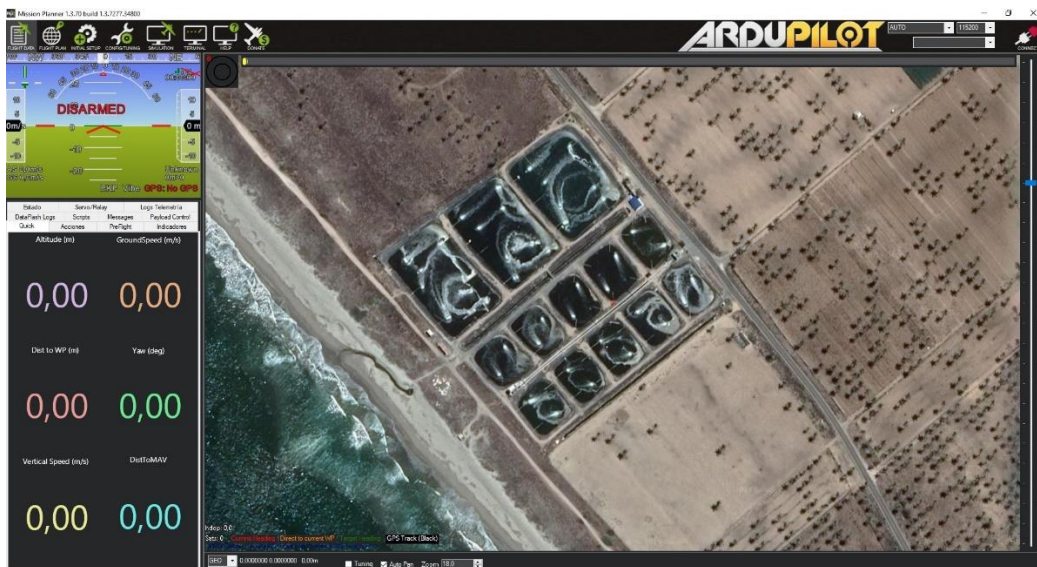

**Fig. 23.** An image of the mission planner software GUI by ArduPilot Dev Team Copyright, to setup mission and AUV.

## 5. Conclusions

This paper starts by outlining the reasons why we need to perform water quality monitoring for shrimp farming. The most important parameters that influence shrimp survival and healthy growth are highlighted, and the mechanisms to maintain these parameters within allowable ranges are also described. To carry out the monitoring process, a smart farming approach based on a FANET is pursued. The main obstacle for the adoption of non-FANET technology, according to some farmers located in the Mexican State of Colima, is the cost of the system. Therefore, a wireless sensor network composed of fixed nodes was deemed to be infeasible because, in this case, the number of sensors to be deployed is proportional to the number of monitoring sites. Since the number of sites can be quite large and the sensors are not very cheap, the resulting cost could be prohibitive, as was discussed in section 3.4. On the other hand, if UAVs are employed, and equipped with the necessary sensors and communication capabilities, a FANET can be constructed that can perform the required task with a significantly lower cost. The reduction in cost comes about because every single UAV can monitor a large number of sites, thus reducing the number of required sensors to a quantity proportional to the number of UAVs - a significant financial reduction.

## Acknowledgments

This work was supported by a grant from the UK Research England Global Research Challenges Fund administered through the University of Leeds.

Author Carlos Mex-Perera is supported by Asociación Mexicana de Cultura, A. C.

## References

- [1] J. Carbajal, L. Sanchez, Classification based on fuzzy interference systems for artificial habitat quality in shrimp farming, Seventh Mexican International Conference on Artificial Intelligence (2008) 388-392.
- [2] N. Ferreira, C. Bonetti, W. Seiffert, Hydrological and water quality indices as management tools in marine shrimp culture, *Aquaculture* 318 (2011) 425-433.
- [3] K. Adnan, N. Yusuf, H. Maamor, F. Rashid, S. Ismail, R.Thriumani , A. Zakaria, L. Kamarudin, A. Shakaff, M. Jaafar, M. Ahmad, Water quality classification and monitoring using E-nose and E-tongue in aquaculture farming, International Conference on Electronic Design (ICED) (2014) 343-346.
- [4] J. Carbajal Hernández, L. Sánchez Fernandez, O. Pogrebnyak, Assesment and prediction of water quality in shrimp culture using signal processing techniques, *Aquaculture International* 19 (2011) 1083-1104.
- [5] I. D. Oviedo, C. Altamirano, M. Millan, N. Arreaga, V. Sanchez Padilla, Development of a prototype of an automatic system for shrimp farming using telecontrol as a viable proposal for small producers, European Conference on Electrical Engineering and Computer Science (2017) 477-483.
- [6] HI 9828, Multiparameter Meter with GPS, Instruction Manual, Hanna Instruments.
- [7] K.L. Krishna, O. Silver, W. F. Malende, K. Anuradha Internet of Things Application for Implementation of Smart Agriculture System, *IEEE, I-SMAC* (2017) 54-59.



- [8] G. Samara, Wafaa AH Al-Salihy, R. Sures, Security analysis of vehicular adhoc networks (VANET). Network Applications Protocols and Services (NETAPPS) Second International Conference on Network Applications, Protocols and Services (2010).
- [9] E. W. Frew, T. X. Brown, Airborne Communication Networks for Small Unmanned Aircraft Systems, Proceeding of the IEEE, Vol. 96, No. 12, (2008) 2008-2027.
- [10] J. Wang, C. Jiang, Z. Han, Y. Ren, R. G. Maunder, L. Hanzo, "Taking drones to the next level: Cooperative distributed unmanned-aerial-vehicular networks for small and mini drones", IEEE Vehicular Technology Magazine (2017) 73-82.
- [11] I. Bekmezci, O. K. Sahingoz, and S. Temel, "Flying ad-hoc networks (FANETs): A survey," *Ad Hoc Networks*, vol. 11, no. 3, pp. 1254–1270, May 2013.
- [12] C. E. Boyd, Management practices to reduce the impact environment of shrimp cultivation, Department of Fisheries and Allied Aquacultures Auburn University (2001) 267-295.
- [13] J. J. Carbajal-Hernández, L. P. Sánchez-Fernández, J. A. Carrasco-Ochoa, J. F. Martínez-Trinidad, Immediate water quality assessment in shrimp culture using fuzzy inference systems, *Expert Systems with Applications* 39 (2012) 10571–10582.
- [14] J. Ponce-Palafox, C. A. Martinez-Palacios, L. G. Ross, The effects of salinity and temperature on the growth and survival rates of juvenile white shrimp, *Penaeus vannamei*, Boone, 193 1, *Aquaculture* 157 Elsevier (1997) 107-115.
- [15] J. R. Villalón, Manual Práctico para la Producción Comercial Semintensiva de Camarón Marino, Texas A&M University, Sea Grant Program, 1994.
- [16] A guide to oxygen measurement, Theory and Practice of Oxygen Applications, METLER TOLEDO.
- [17] ENV-40-DC, Dissolved Oxygen Probe, Datasheet Manual, AtlasScientific Environmental Robotics, 2019.
- [18] Posudin, Yuriy, *Methods of Measuring Environmental Parameters*, Wiley, 2014.
- [19] A guide to pH measurement, Theory and Practice of pH Applications, METLER TOLEDO.
- [20] ENV-40-pH, pH Probe, Datasheet Manual, AtlasScientific Environmental Robotics, 2019.
- [21] Technical information, Condumax CLS16 and CLS16D. Endress+Hauser.
- [22] Technical information, Condumax CLS54D Endress+Hauser.
- [23] ENV-40-EC-K1.0, Conductivity Probe K 1.0, AtlasScientific Environmental Robotics, 2019.
- [24] Jon S. Wilson, Editor, *Sensor Technology Handbook*, Newnes, 2004.
- [25] PT-1000, Temperature Probe, AtlasScientific Environmental Robotics, 2019.
- [26] J. Cuellar-Anjel, C. Lara, V. Morales, A. de García, O. García Suárez, Manual of the best management practices for the white shrimp *Penaeus vannamei* farming, Regional International Organization of Agricultural Health OIRSA (2010) 1-132.
- [27] C.E Boyd, C.S Tucker, *Pond aquaculture water quality management*, Kluwer Academic Publishers, Boston, EEUU, 1998.
- [28] W. A. Wurts, R. M. Durborow, Interactions of pH , carbon dioxide, alkalinity and hardness in fish ponds, Southern Regional Aquaculture Center (1992) 1-4.
- [29] Lucy Towers , 23 November 2013, "An Overview of Heating and Cooling Process Water in Land-based Aquaculture", Recovered 18 December 2019, <https://thefishsite.com/articles/an-overview-of-heating-and-cooling-process-water-in-landbased-aquaculture>
- [30] James Wyban, William A. Walsh , David M Godin, *Temperature effects on growth , feeding rate and feed conversion of the Pacific White shrimp (Penaeus vannamei)*, *Aquaculture* 138 (1995) 267-279.
- [31] J. Wyban, W. A. Walsh, D. M. Godin, Temperature effects on growth, feeding rate and feed conversion of the Pacific white shrimp (*Penaeus vannamei*), *Aquaculture* 138 (1995) 267-279.

- [32] Content Provider, Freshwater Shrimp Farming - Managing Water Quality & Disease, Worldwide Aquaculture (2014).
- [33] FAO, *Penaeus vannamei*, in cultured aquatic species fact sheets (2009).
- [34] T. Abbasi, S. Abbasi, Water quality indices, Elsevier Ed., 2012.
- [35] S.A Abbasi, D.S. Arya, Environmental Impact Assessment, Discovery Publishing House ed., New Delhi, 2000.
- [36] H. Shoji, T. Yomamoto, T. Nakamura, Factor analysis on stream pollution of the Yodo river system. Air and Water Int. Poll. J. 10 (1996) 291-299.
- [37] R.D. Harkin, An objective water quality index, Journal of the Water Pollution Control Federation 46 (1974) 588-591.
- [38] J.M. Landwehr, A statistical view of a class of water quality indices, Water Resources Research 15 (2) (1979) 460-468.
- [39] Y. Qian, K.W. Migliaccio, Y. Wan, Y. Li, Surface water quality evaluation using multivariate methods and a new water quality index in the Indian River Lagoon, Florida. Water Resources Research. 43 (2007) 10.1029.
- [40] J.E. Sedeno-Díaz, E. López-López, Water quality in the Río Lerma, Mexico: an overview of the last quarter of the twentieth century, Water Resources Management 21 (10) (2007) 1797-1812.
- [41] E. Beamonte, J.D. Bermúdez, A. Casino, E. Veres, A global stochastic index for water quality: the case of the river Turia in Spain, Journal of Agricultural, Biological, and Environmental Statistics 10 (4) (2005) 424-439.
- [42] E.B. Cordoba, A.C. Martínez, E.V. Ferrer, Water quality indicators: comparison of a probabilistic index and a general quality index. The case of the Confederación Hidrográfica del Júcar (Spain), Ecological Indicators 10 (5) (2010), 1049-1054.
- [43] G.J. Klir, B. Yuan, Fuzzy Sets and Fuzzy Logic: Theory and Applications, Prentice-Hall International ed., Upper Saddle River, NJ. (1995).
- [44] N.B. Chang, H.W. Chen, S.K. Ning, Identification of river water quality using the fuzzy synthetic evaluation approach, Journal of Environmental Management 63 (3) (2001) 293-305.
- [45] Y. Icaza, Fuzzy evaluation of water quality classification, Ecological Indicators 7 (3) (2007) 710-718.
- [46] A. Lermontov, L. Yokoyama, M. Lermontov, (M.A.S.) Machado, River quality analysis using fuzzy water quality index: Ribeira do Iguape river watershed, Brazil Ecological Indicators 9 (6) (2009) 1188-1197.
- [47] H.V. Safavi, Prediction of river water quality by adaptive neuro fuzzy inference system (ANFIS), Journal of environmental studies 36 (53) (2010) 1-10.
- [48] <http://www.waterquality.ttr.com.mx>, 2019.
- [49] <http://www.ttr.com.mx/>, 2019.
- [50] Cultured aquatic species information programme. *Penaeus vannamei*. Cultures aquatic species information programme. Text by Briggs, M. In: FAO Fisheries and Aquaculture Department. Rome (2006).
- [51] Da Xu L, He W, Li S. Internet of things in industries: A survey. IEEE Transactions on Industrial Informatics. 10 (4) (2014) 2233-2243.
- [52] R. Satapathy, L. Prasanna, Performance Comparison and Evaluation Of Node.js And Traditional Web Server (IIS), 2017 International Conference on Algorithms, Methodology, Models and Applications (ICAMMAET), IEEE, Chennai India, 2017.