

Motionless Mixers

Gas Dispersion Systems

Channel and Duct Mixers

Non Ragging Mixers

Mixing Technology with proven benefits

Statiflo is a world leader in motionless mixing technology. We are constantly expanding the limits of motionless mixing technology to create innovative products including the most efficient static mixers currently available.

• Statiflo Motionless Mixers

offer many key benefits for combining miscible and immiscible liquids, liquids with gases and gas blending. They are efficient and economical, delivering precise, predetermined results in laminar and turbulent flow mixing, blending, dispersion and emulsion formation, laminar flow heat exchange, mass transfer, and as an inline reactor promoting 'plug flow'.

- Statiflo Motionless Mixers are maintenance free devices. Installation and operating costs are minimised. As well as direct operating savings, Statiflo Motionless Mixers deliver a high level of mixing efficiency, therefore the consumption of dosed chemicals and formation of by-products can be dramatically reduced. No straight pipe lengths upstream or downstream of the mixer are required. This means inline sampling can be performed immediately after the mixer – allowing any necessary adjustments to be made as quickly as possible – minimising potential product waste.
- Statiflo Motionless Mixers are installed in thousands of process plants worldwide, providing the highest standards of mixing efficiency, reliability and economy.

Key benefits include:

- Highly efficient mixing
- No moving parts for maintenance-free operation
- Energy saving, as no direct power is required
- No need for tanks
- Ease of installation
- Minimal space requirement with no upstream or downstream pipe lengths requirements
- Available in all sizes
- Available in a wide range of materials
- Custom designed for each application
- Available worldwide through our Statiflo offices and representative network

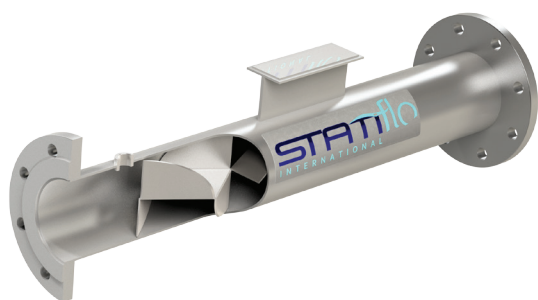

Series 100

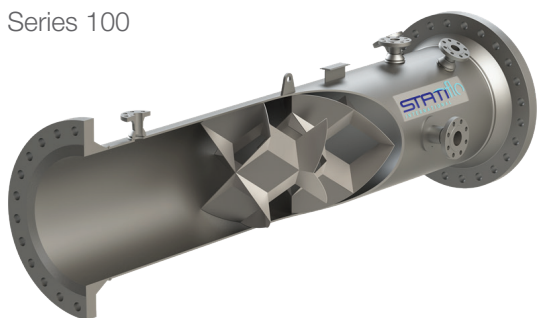

Series 150

Series 100/150

General purpose designs in steel/exotic alloys, with fixed or removable elements available with heating/cooling jackets and injectors/sample bosses.

Industry	Typical Applications	Process
Food	Pasteurisation of raw cocoa mass	Steam/pulp plug-flow mixing
Petrochemical	Methanol stripping of gas condensate	Immiscible liquid solvent extraction
Oil and gas	Glycol gas drying	Liquid/gas mixing
Pulp and paper	Consistency control	Water/stock mixing

Series 200

Sanitary designs in polished stainless steel with removable elements with food/ pharmaceutical finish. Designed for CIP, available with IDF, RJT, DIN and ferrule end connections. Injectors and heating/cooling jackets also available.

Industry	Typical Applications	Process
Food	Yogurt/fruit blending	Solid/gel mixing
Brewing	Aeration of wort	Gas/liquid mixing
Pharmaceutical	pH control of fermentation broth	Liquid/pulp mixing
Soft drinks	Carbonation of drinks	Gas dispersion

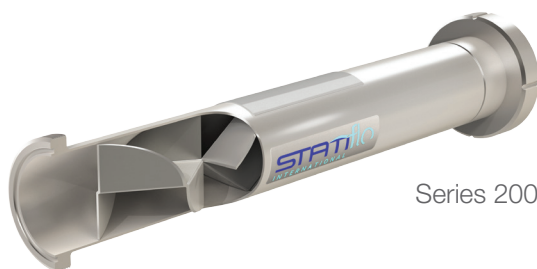

Series 200

Series 300

Corrosion resistant design with removable elements in solid PTFE, carbon/ stainless steel housing, fully PTFE lined, available with PTFE/PFA injectors.

Industry	Typical Applications	Process
CPI	Corrosive high temperature loop reactors	Gas/liquid mixing
Water treatment	Concentrated acid dilution	Liquid/liquid mixing
Petrochemical	Acid solvent stripping	Immiscible liquid mixing
Chemical	Acid mixer reactors	Liquid/liquid mixing

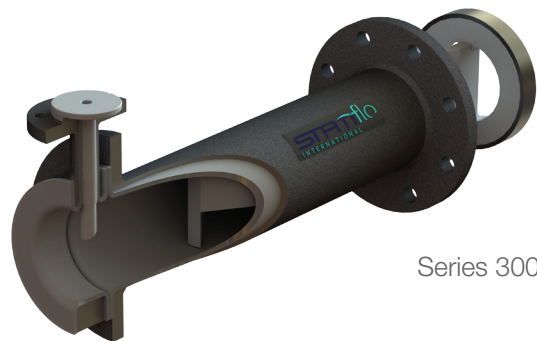

Series 300

Series 400

uPVC, cPVC, PP and HDPE designs for cost-effective corrosion resistant duties, fixed elements in housings available with flanged or threaded ends and complete with injectors/sample points.

Industry	Typical Applications	Process
Water treatment	Coagulation/flocculation	High/low viscosity liquid mixing
Wastewater	pH control/flocculation	High viscosity sludge mixing
Swimming pool	Ozonation/disinfection	Gas/liquid mixing
CPI	Acidic pH control duties	Low viscosity liquid mixing

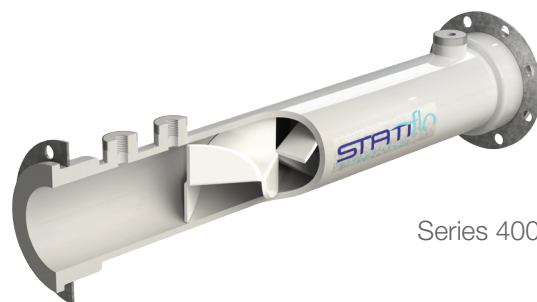

Series 400

Series 500/550

Large diameter (>10") designs in corrosion resistant GRP/FRP fixed elements, flanged designs available with injectors/sample points.

Industry	Typical Applications	Process
Desalination	Dosing pre-treatment and remineralisation additives	Liquid/liquid mixing
Wastewater	Flocculation/coagulation	High/low viscosity mixing
Water treatment	Fluoridation of drinking water	Liquid/liquid mixing
CPI	Dosing strong and weak acids	Liquid/liquid mixing

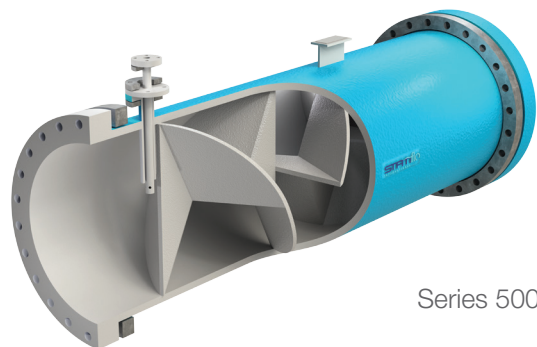

Series 500

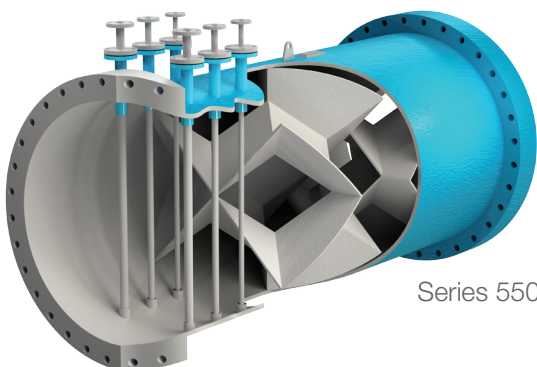

Series 550

Motionless Mixers

Statiflo has developed a range of mixing elements designs to suit a wide variety of duties in all industries. As a world leader in static and motionless mixing technology, Statiflo is constantly researching to improve efficiency and economy—engineering for optimum solutions.

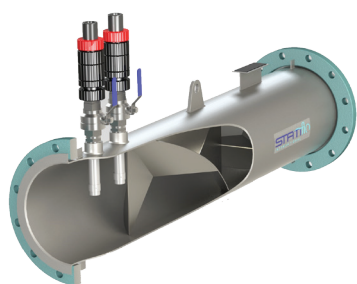

Series 600

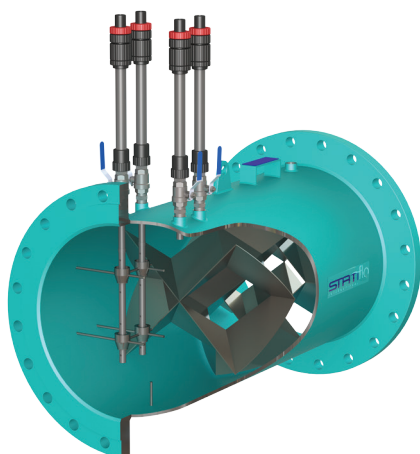

Series 650

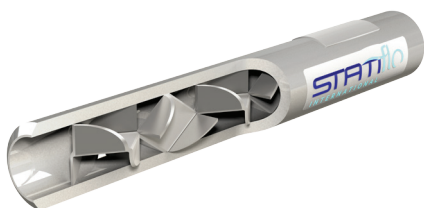

Series 700

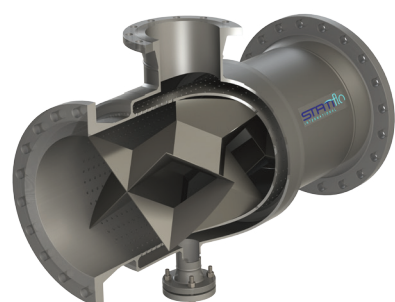

Series 850

Series 600/650

Large diameter general purpose designs in epoxy coated carbon steel/stainless steel, with fixed elements, flange/plain ended, injection lances/sample points.

Industry	Typical Applications	Process
Water treatment	Disinfection control	Liquid/liquid mixing
Wastewater	pH control/flocculation	High/low viscosity mixing
Desalination	Recarbonation/ chlorination pH control	Gas/liquid mixing Liquid/liquid mixing
Water treatment	Ozonation/oxidation	Gas/liquid mixing

Series 700

Precision machined mixers with high surface finish, edge sealed elements, for high temperatures and pressures, polymer processing, thermal homogenising, and melt extrusion.

Industry	Typical Applications	Process
Man-made fibers	Thermal homogenisation Polymer modifiers	High viscosity liquid mixing
Polymer manufacturing	ABS/SAN/LLDPE reaction	High viscous laminar flow mixing
Food	Solids addition/starch cooking	High viscous plug-flow mixing

Series 800/850

Direct steam heater mixers in steel/exotic alloys, with fixed elements and flanged end connections.

Industry	Typical Applications	Process
Oil and gas	Steam desuperheating	Liquid/gas mixing
Petrochemical	Direct steam acid heating	Gas/liquid mixing
CPI	Water/steam heating	Gas/liquid mixing
Food/ Pharmaceutical	Live steam pasteurisation	Gas/liquid mixing

'S' Type Mixers

A range of standard design static mixers, pre-manufactured with flanged ends and one injection boss. Three or four elements can be supplied, depending on the flow regime. Available in both uPVC and stainless steel materials of construction.



'S' Type Mixers

DesalMixer (DSM)

The very latest techniques for design and modelling have been used to develop the Statiflo DesalMixer (DSM) for turbulent flow dosing and blending applications in the pre-treatment and post-treatment stages of water treatment in desalination processes.

The Statiflo DSM has been independently tested for pressure drop and mixture quality (measured by coefficient of variation — CoV) by BHR Group, world leaders in fluid engineering, research and consultancy. Mixers have been tested at industry realistic fluid velocities and additive ratios, and have consistently demonstrated the ability to produce mixture qualities exceeding industry standard.

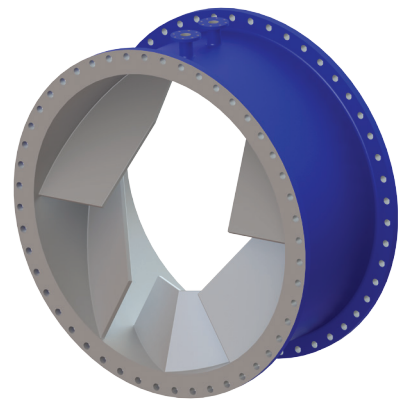

DSM

Custody Transfer (CT) Mixers

It is of the utmost importance that seller and customer both know exactly the water content of the oil they are purchasing or selling. This can often be very difficult because the best sampling systems in the world can only provide accurate data if they are taking a representative sample.

Statiflo's market-leading dual leading edge designs consistently achieve a C1/C2 ratio above 0.9, in accordance with ISO3171 and API 8.2 standards, indicating a good degree of mixing therefore meaning the water is adequately dispersed within the oil and a representative sample can be taken at the mixer discharge for water in oil analysis.

Statiflo has extensive experience in providing mixers for Custody Transfer and Fiscal Measurement applications, meeting the stringent requirements of ISO3171 and API 8.2 standards.

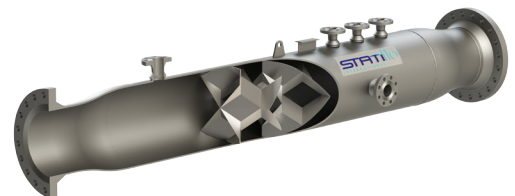

Custody Transfer Mixer

Chemical Injection Lances

Statiflo offers chemical injection/dosing lances which are designed specifically for your application. Statiflo's special lance design ensures the introduction of additive at the specific locations within the main line to optimise mixture quality and the performance of your static mixer.

Standard materials of construction are uPVC, 316 stainless steel or Hastelloy C-276 for corrosive applications. Low and high pressure versions are available, complete with isolation ball valve, allowing safe removal for servicing without shutting down the line.

Make your mixing system complete by adding the Statiflo chemical injection lances your application requires.



STL-LP Injection Lance

The innovative Gas Dispersion System: custom designed, engineered and built.

A concept for simultaneous mixing and mass transfer exclusively designed and built by the leaders in motionless mixing systems.

Statiflo Gas Dispersion Systems (GDS)

are custom engineered and built to meet customer specific performance requirements. The main components are:

- **Main line mixer/contactor**
- **Sidestream equipment, including:**
 - Pre-disperser static mixer
 - Gas eductor (if gas is at low pressure)
 - Centrifugal pump, operating at constant flow rate.
 - Sample points, valves, instrumentation, interconnecting pipework and stand-by equipment, as required.

The sidestream gas/liquid dispersing equipment can be compactly side mounted directly on the contactor mixer or alternatively floor/skid mounted.

Typical applications for the Statiflo GDS include ozonation, aeration and carbonation.



GDS installed at customer site

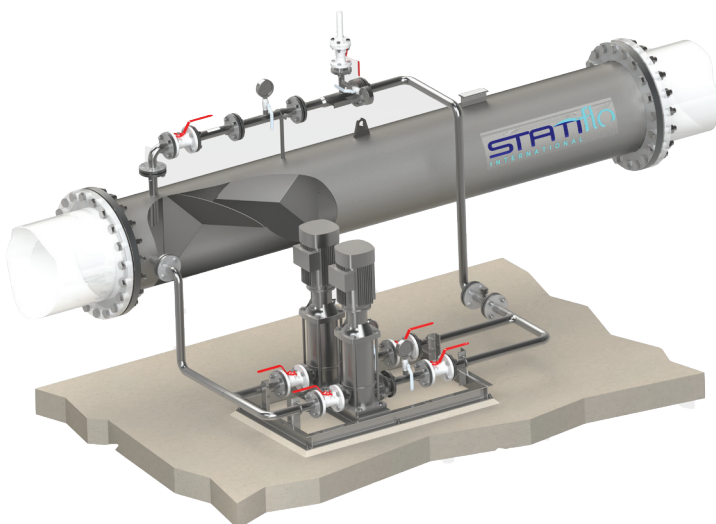
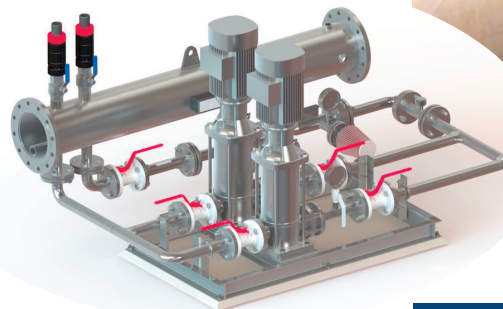

Key benefits include:

- High mass transfer efficiency
- Low capital cost
- Low pressure drop
- Gas bubbles generated independently of liquid velocity in contactor
- Low energy consumption
- High turndown capability
- Compact design
- No moving parts except for centrifugal pump
- Minimal maintenance requirement
- Simple to operate — no special training required

Channel (STMC) and Duct (STMD) Mixers

Statflo's channel and duct mixers have revolutionised the design and operation of water and wastewater treatment plants.

Complete mixing in the channel is possible, achieving a low CoV, over a wide range of flowrates. With head losses of just a few millimetres feasible, gravity flow is an option, eliminating the expense of pumping, saving not just capital costs, but ongoing maintenance and energy costs too.



Channel Mixers installed on site at a UK Water Treatment works

Typical applications:

- Raw water blending
- pH control
- Rapid coagulation/dosing
- Polyelectrolyte dosing
- Chlorination/dechlorination
- Residence time control

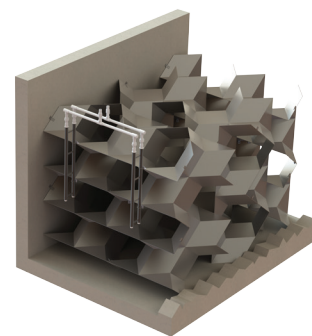

Statflo Channel Mixers can be installed in new treatment works or easily retrofitted into existing installations because of the extremely low headloss.

The modular design concept, based on the STMC mixing element, allows wide variations in aspect ratio (height/width) suitable for square or nearly square channel sections, narrow deep channels and wide shallow channels. We have even designed Channel Mixers for circular collectors around clarifiers for pH adjustment prior to chlorination.

Independent trials have established that the STMC concept is the most efficient of all known commercially available static mixers, making it ideal for chemical dosing as a fundamental component of process control. It is indispensable before flow splits to ensure equal chemical distribution and balanced performance of parallel trains of treatment operations.

Non-Ragging (NR) Pipe Mixer

High performance non-ragging static mixer for difficult sludge and wastewater applications, specifically developed for flows with a high content of rags and/or highly fibrous material.

The unique mixing elements design provides:

- Free flow design gives excellent resistance to blocking and ragging
- High mixing performance with $CoV < 0.05$ and consistent mixture quality
- Low pressure drop
- Easy to clean with excellent free draining capability
- uPVC/Stainless steel construction
- Wide range of diameters available
- Custom designed for each application
- Injection nozzles easily incorporated



Typical clogging of competitor's mixer after less than 5 hours

Statiflo NR Sludge mixer after 90 hours operation

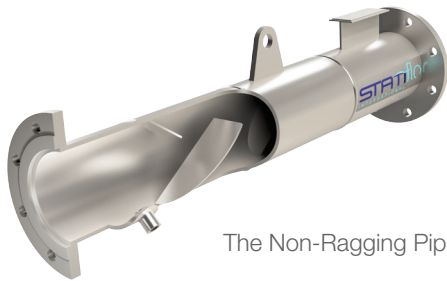

The Non-Ragging Pipe Mixer

Typical applications:

- Sludge blending
- Sludge thickening
- Coagulant/Poly blending
- Ferric dosing for phosphorus removal
- Chemical dosing of raw sewage
- Products with fibres, e.g. Paperstock.

Non-Ragging Channel (NRC) Mixer

NRC's unique variable geometry custom designed for the widest range of wastewater velocities and channel depths found on a typical wastewater treatment plant.

The unique design provides many features:

- Variable angle control vanes tuned to optimise performance within tight headloss constraints
- Subsurface fixed vanes to aid mixing at low depth
- Adaptable design for a wide range of channel sizes, aspect ratios, water depths and flow rates
- No direct power requirements for mixing
- Available with automatic (power required) or manual (no power required) control vane options
- Accessible integrated sparger for chemical injection
- Designed for easy installation into open channel
- Custom designed for each application

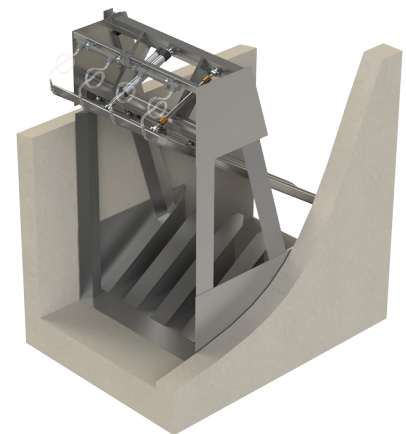

The Non-Ragging Channel (NRC) Mixer

Key benefits include:

- Significant chemical savings
- Reduced BOD load
- Reduced Fe concentration in final effluent/sludge
- Substantial cost savings
- Improved primary sedimentation tank performance
- Higher sludge concentrations
- Reduced or eliminated channel staining

Static Mixer Sizing Questionnaire

Reference	
Date	
Item	
Quantity	
Initials	

Process Data				
COMPONENT	MAIN FLOW	ADDITIVE 1	ADDITIVE 2	MIXTURE
Fluid Name				
Physical State				
Flowrate				
Viscosity, cP				
Density, kg/m ³				
Pressure, barg				
Temperature, °C				
Miscible System				
Interfacial Tension, dynes/cm - immiscible systems only				
Is the maximum Coefficient of Variation (CoV) of 0.05 required at the mixer discharge or 3-5 diameters downstream?			<input type="checkbox"/> Mixer Discharge <input type="checkbox"/> 3-5 Diameters Downstream	
Alternative CoV required (Please Specify)				

Mechanical Data				
Pipe Diameter, mm				
Alternative Pipe Diameter, mm (if any)				
Maximum Pressure drop, bar				
Removable Elements?	Yes/No			
Injection Point(s)*	Yes/No*			
Sample Point(s)*	Yes/No*			
Sanitary Finish (Food/Pharmaceutical Applications)	Yes/No			
End Connections/Specification				
Housing Schedule				
Materials of Construction	<input type="checkbox"/> 316L Stainless Steel	<input type="checkbox"/> Carbon Steel	<input type="checkbox"/> Polyethylene	<input type="checkbox"/> GRP
	<input type="checkbox"/> 304 Stainless Steel	<input type="checkbox"/> PTFE Lined Pipe	<input type="checkbox"/> Polypropylene	<input type="checkbox"/> uPVC
	Other (Please Specify)			
Design Code				
Operating/Design Temperature, °C				
Operating/Design Pressure, barg				
Heating/Cooling Jacket	Yes/No			
Special Painting				
Tests/NDE				
Other Data				

Brief Process Description with Flowsheet (if applicable)

* If injection and/or sample point(s) are required please sketch number, size and location.

Please return completed questionnaire to your local representative or Statiflo office



info@lennotech.com Tel. +31-152-610-900
www.lennotech.com Fax. +31-152-616-289

Gas Dispersion System (GDS) Sizing Questionnaire

Reference	
Date	
Item	
Quantity	
Initials	

Process Data

COMPONENT	1	2
Fluid Name		Ozone/oxygen/air/other*
Total Flowrate (min / norm / max)		
No of contactor lines		
Flowrate per train (min / norm / max)		
		or dose, ppm
Density, kg/m ³		
Viscosity, cP	1	0.02
Pressure, barg		
Temperature, °C		

* please delete or specify

Mechanical Data

Contactors / Pipe Diameter, mm	
Max allowable pressure drop across Contactor, bar	
Flange specification	
Housing Schedule	
Materials of Construction	
Operating Temperature, °C	
Operating Pressure, barg	

Brief process description / flow diagram

Special requirements

Please return completed questionnaire to your local representative or Statiflo office

Channel Mixer Sizing Questionnaire

Reference	
Date	
Item	
Quantity	
Initials	

Process Data

COMPONENT	1	2	3	MIXTURE
Fluid Name				
Physical State				
Flowrate, (min / norm / max)				
Viscosity, cP				
Density, kg/m ³				
Temperature, °C				

Mixture Quality:

Required Coefficient of Variation (CoV) Sampling?	Yes/No	at Mixer discharge or at at Mixer discharge or at	
---	--------	--	--

* A CoV of 0.05 or less at the mixer discharge is suitable for most dosing applications.

Mechanical Data

Channel Width, mm	
Water Depth, mm (min / norm / max)	
Channel Height, mm	
Max Allowable Headloss, (mm water)	Yes/No
Injector(s)	Duty only / Duty and standby
Materials of Construction	

Brief Process Description with Flowsheet (if applicable)

*If injection and / or sample point(s) are required please sktch number, size and location.

Please return completed questionnaire to your local representative or Statiflo office

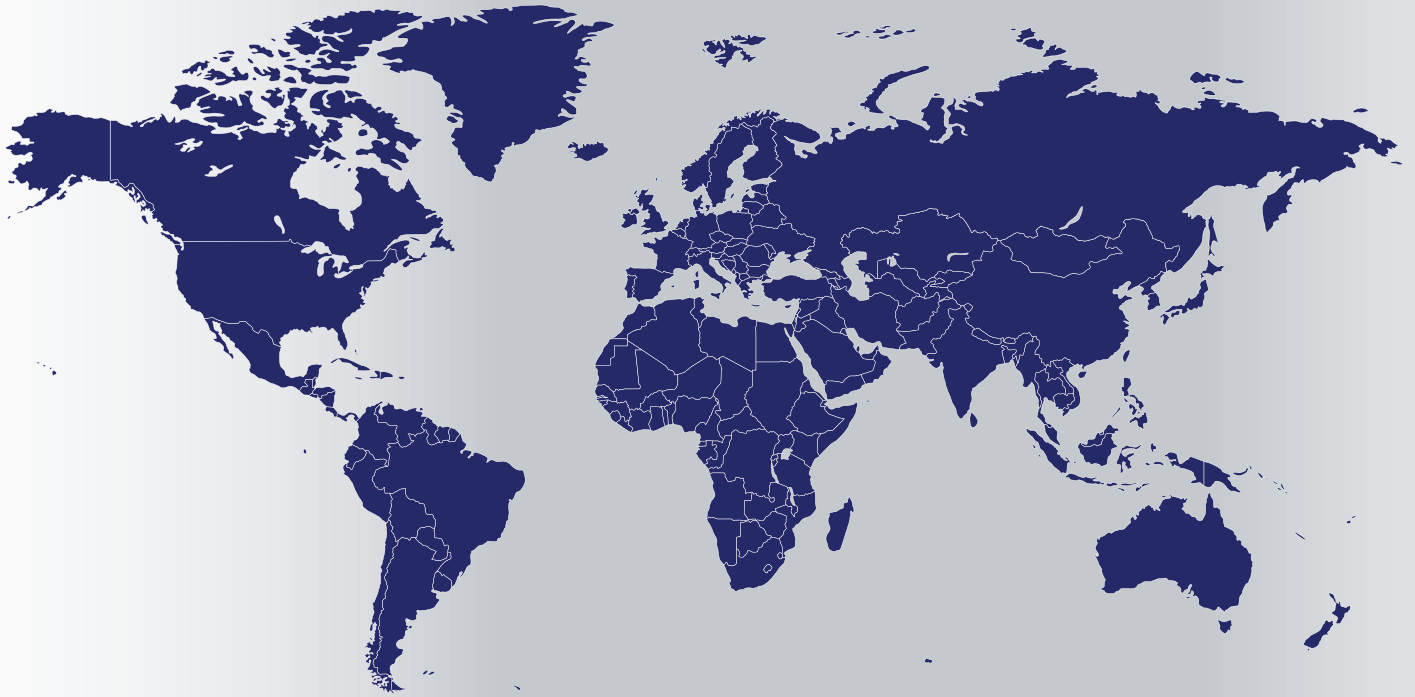

Statiflo is the only international mixer specialist able to offer true global expertise. We have over 2,000 customers in more than 70 countries, in all process industries – endorsing our primary position in this field.

STATIFLO
Dynamic Leaders in Static Mixing

LENNTECH
WATER TREATMENT SOLUTIONS

info@lennotech.com Tel. +31-152-610-900
www.lennotech.com Fax. +31-152-616-289