

MICHIGAN STATE POLICE

COMMUNICATIONS SECTION • MOBILE OFFICE UNIT

MOTOROLA APX 6500 & 7500

Mobile Radio Guide

(Rev. 04/2015)



MSP COMMUNICATIONS • 7050 HARRIS DRIVE • LANSING, MI 48913

(517) 284-3000 (SECTION MAIN)

TABLE of CONTENTS

SECTION	PAGE
MSP Communications Regional Sergeants	2
Motorola APX Mobile Radio Overview	3
APX 6500/7500 Nomenclature-05 CONTROL HEAD	4
APX 6500/7500 Nomenclature-03 CONTROL HEAD	5
On / Off	7
Volume Control	
Menu Select Keys	8
Home Button	
4-Way Navigation Button	
Scan On/Off	9
Mode Knob / Buttons	
LED Indicator	10
Emergency Button	
One-Dot & Two-Dot Button (03 Control Head Only)	11
F Zone & DIRECT/REPEATER modes	
Answering a Private Call	12
Display-05 Control Head	13
Display-03 Control Head	14
Changing the Zone & Talkgroup	15
Making a Private Call or Page	16
Building a Scan List & Scanning	17
Scanning with the APX 7500	18
Encryption & Radio Info	19
Tones You May Hear	20
MSP Communications Section Main Contact Information	21

MSP REGIONAL COMMUNICATIONS SERGEANTS

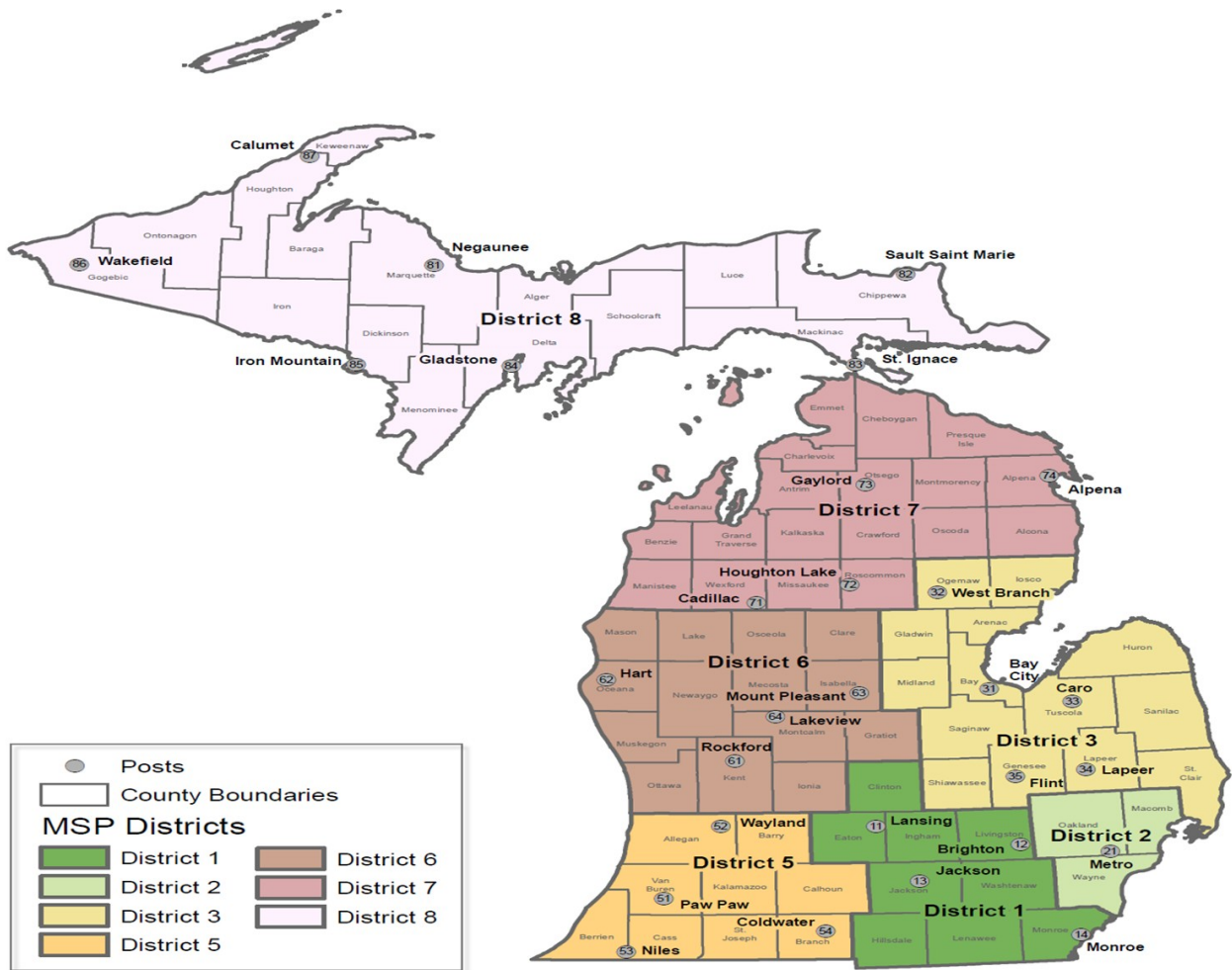

NAME	DISTRICT	TELEPHONE	EMAIL ADDRESS
Sgt. Jim Leece <i>Lansing*</i>	Acting Unit Cmdr.	(517) 898-0325	LeeceJ@michigan.gov
Sgt. Mike Brown <i>West Branch</i>	2nd & 3rd Districts	(989) 390-7455	BrownM13@michigan.gov
Sgt. Orville Theaker <i>Lansing</i>	5th & 6th Districts	(269) 953-6099	TheakerO@michigan.gov
Sgt. Scott Schlehuber <i>Gaylord</i>	7th & 8th Districts	(517) 282-7298	SchlehuberS@michigan.gov

*The 1st District is covered by either Sgt. Mike Brown or Sgt. Orville Theaker. Contact MSP Communications for assistance.

This guide was produced by the Michigan State Police Communications Section, Mobile Office Unit. This document may contain material whose use has not been specifically authorized by the manufacturer but is considered Fair Use for the purposes of not-for-profit education and training, per section 107 of the U.S. Copyright Law. Motorola is a registered trademark of Motorola Trademark Holdings, LLC. All Rights Reserved.

MOTOROLA APX MOBILE RADIO OVERVIEW



The Motorola APX mobile radios described in the guide operate on **Michigan's Public Safety Communications System**, often called the **MPSCS**. The MPSCS, a trunked 800 MHz digital system, enables all users across a wide-variety of disciplines and agencies to communicate together throughout or even across the entire state. Currently, nearly 1,600 different agencies encompassing nearly 70,000

individual radios use the MPSCS on a daily basis for their work; in fact, the MPSCS is one of the largest 800 MHz systems in the world today. These agencies include police departments, fire departments, EMS, public works or road commissions, federal agencies, hospitals, various state agencies, and the MSP. The purpose of this guide is not to instruct the reader on the system itself, but to explain what the various features of the radios are that used by our personnel on a daily or frequent basis.

MSP primarily fields two types of APX mobile radios: the APX 6500 and the APX 7500. As mentioned, each of these radios operates on the MPSCS. However, the APX 7500 is also capable of operating in a dual-band capacity (e.g., the radio can use both the MPSCS or a conventional system such as VHF). Typically, the APX 7500 may be deployed to a post that has a centralized dispatch system still operating in a conventional radio band such as VHF. By using an APX 7500, those personnel can communicate on both the state system and the local system without the need to have two separate mobile radios.

The largest difference the field may encounter are with the types of "heads" the APX mobile radios use. The mobile radio *itself*, meaning the actual hardware involved in transmitting and receiving, is usually located in the trunk or other out-of-the-way space of the vehicle. The "head" is what type of accessory is attached *inside* of the vehicle that field personnel use to control the radio and talk. **The two types of heads MSP primarily fields are the "05" head, which is the typical control panel and attached microphone found in a patrol car, and the "03" head which is the integrated control/microphone found in undercover, specialty, or detective vehicles (the "03" head may be referred to as a "DB" head for this reason).**

As both radios are from the same APX family, and are programmed to MSP specifications, the various features described throughout this guide apply to both radios regardless of whether it is a 6500 or 7500; most sections will have diagrams representing the 05 control head and the 03 control head. Regardless of the control head used, the APX portable radios are programmable, just like a computer can be. *The various buttons, knobs, and switches on the radios can be programmed by the technician to do just about anything.* As a result, although one agency may have an APX mobile radio, and another agency has the exact same model radio, they may operate slightly differently. This guide encompasses radios maintained by the MSP.

APX 6500 / 7500 Nomenclature

05 CONTROL HEAD (STANDARD MICROPHONE):

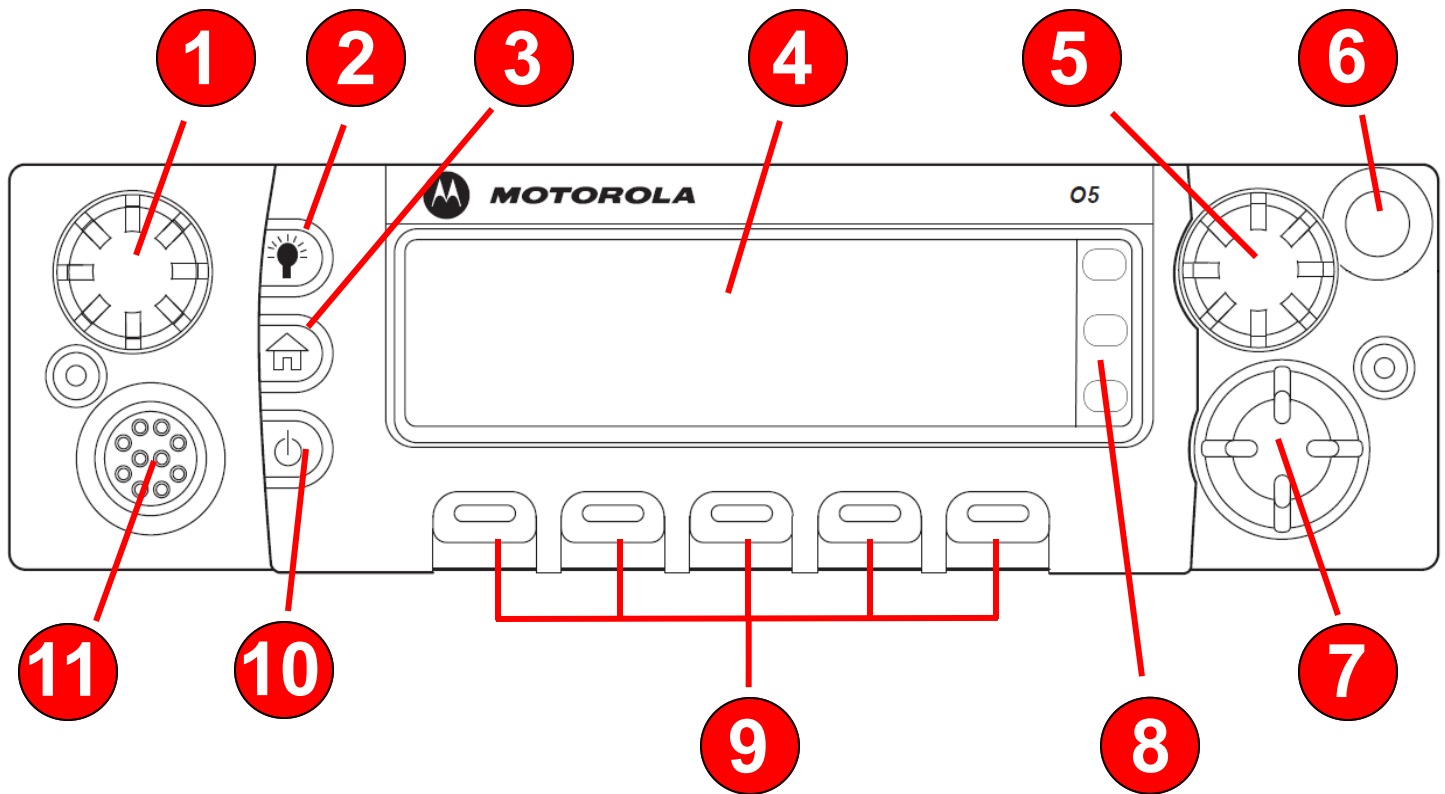

NUMBER	DESCRIPTION	NUMBER	DESCRIPTION
1	Volume	7	Navigation Button
2	Illumination / Backlight	8	LED Indicators
3	Home Button	9	Menu Select Buttons
4	Display Screen	10	On / Off Button
5	Mode Knob	11	Microphone Connector
6	Emergency Button		

APX 6500 / 7500 Nomenclature

03 CONTROL HEAD (DB MICROPHONE):

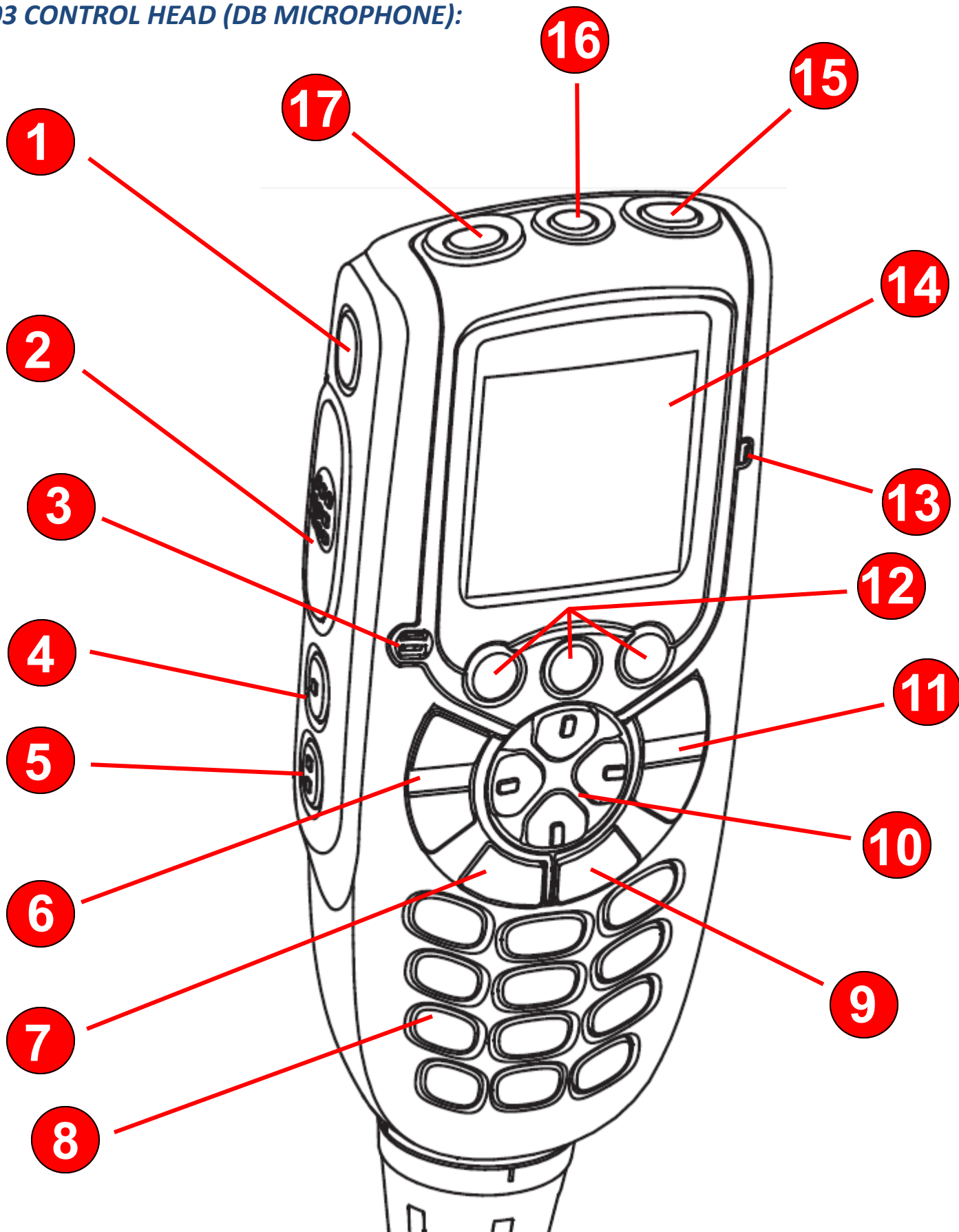

APX 6500/7500 03 "DB" HEAD Nomenclature

<i>NUMBER</i>	<i>DESCRIPTION</i>	<i>NUMBER</i>	<i>DESCRIPTION</i>
1	Answer Private Call	10	4-Way Navigation Button
2	Push-to-Talk (PTT)	11	Mode Control
3	Microphone	12	Menu Select Buttons
4	One-Dot Button	13	Multi-Color LED
5	Two-Dot Button	14	Main Display
6	Volume Control	15	Encryption On/Off
7	Home Button	16	Emergency Button
8	Keypad (some models)	17	On/Off Button
9	Computer Icon / "Future Use"		

USING THE APX MOBILE RADIO—BASICS

ON / OFF:

03 HEAD:

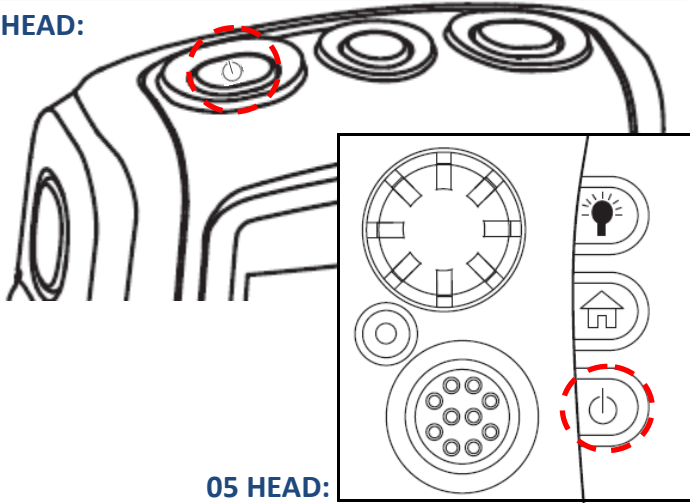

05 HEAD:

The APX mobile radio is typically installed so that it will automatically power up and complete its self-test sequence when you turn on the vehicle.

If you need to power your radio up or turn it off, *press and hold* the power button located on the control head of the radio (*shown at left*).

Once the radio has been powered up, the display may show the mobile radio's model number as it performs a self-test. In addition, the LEDs may cycle through their color sequence (red, yellow, green). Once it is through the self-test it will automatically affiliate with a tower. The radio will remember the talkgroup it was last tuned to prior to being powered down and will attempt to affiliate with this talkgroup.

VOLUME CONTROL:

03 HEAD:

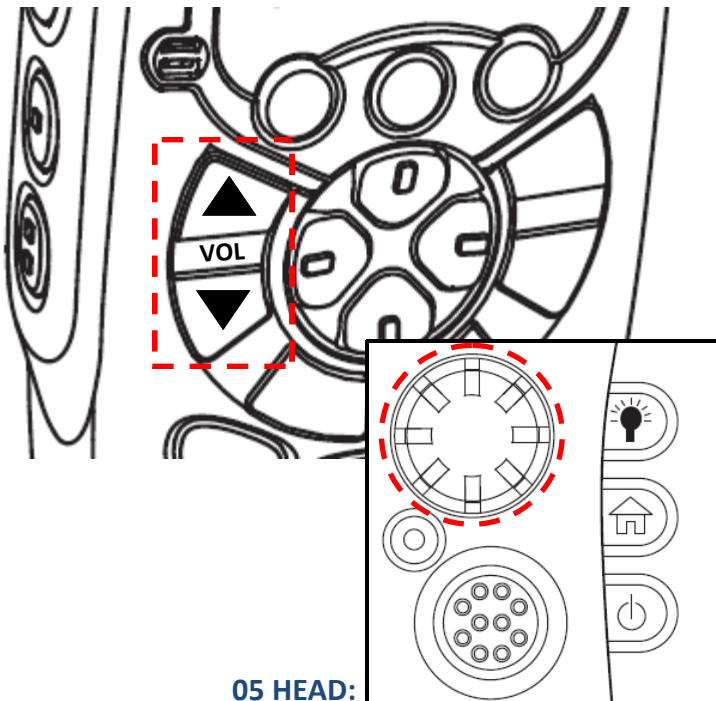

05 HEAD:

To control the volume on the **05 control head**, rotate the *large volume knob* located on the radio's left side near the microphone connection. Turn it *clockwise* to increase the volume; *counter-clockwise* to decrease.

To adjust the volume on the **03 control head**, use the up or down arrows on the *volume control keys* located toward the center of the control head.

The radio will not tone as you increase or decrease the volume on the 05 head. On the 03 head, the radio will tone as you increase or decrease the volume.

USING THE APX MOBILE RADIO—BASICS

MENU SELECT, HOME, AND 4-WAY NAVIGATION BUTTONS:

05 HEAD:

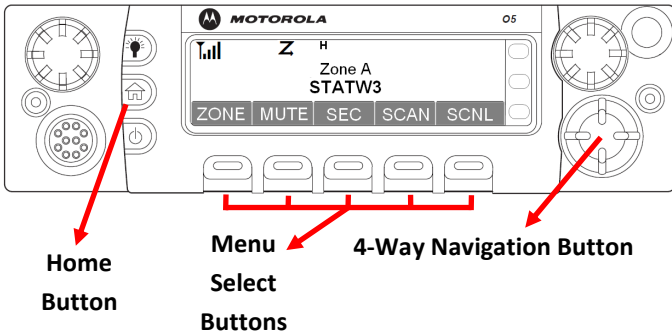

On the **05 control head**, there are a series of five buttons located immediately beneath the display screen; there are three such buttons on the **03 control head**.

These buttons are called the *menu select buttons* and correspond to the menu option the screen above them is showing. For instance, in the example on the left pressing the far left button would bring up the zone menu.

Adjacent to the display on the **05 head** is another series of buttons. The center button with the small house on it is called the *home button*. Pressing this button acts like an escape button on a computer. If you are lost deep in a menu, or have no idea how to get back to your home talkgroup, a long press on the *home button* will take you back to your home talkgroup. A short press on the *home button* is an easy way to acknowledge a page, as well.

The large button indicated is the *4-way navigation button*. This button allows you to navigate through the various menus on the radio.

To the right of the *4-way navigation button* on the **03 head** is the *future use/computer button*. This button has no current use on all MSP radios and most other radios on the MPSCS.

03 HEAD:

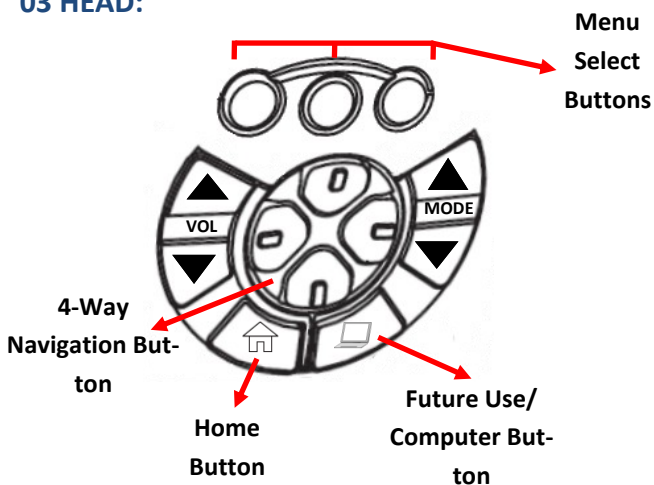

KEYPAD (03 HEAD ONLY):

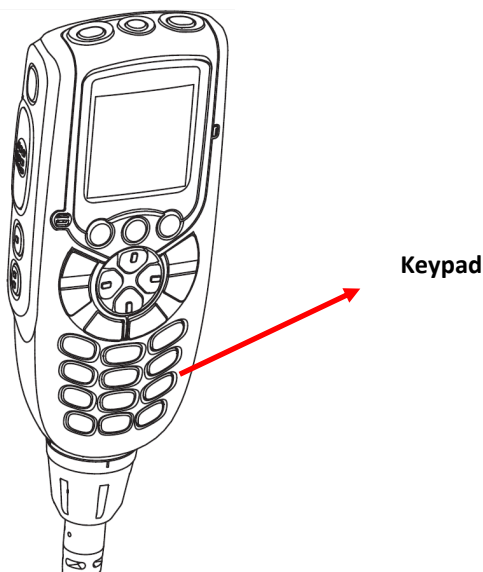

The keypad shown to the left is found on certain **03 control heads** for the APX 6500 / 7500 mobile radio.

This alphanumeric keypad, which appears nearly identical to the keypad found on a telephone, allows the user to private call or page any radio on the MPSCS by typing in the receiving radio's unique radio ID number.

In the MSP, mobile radios with a keypad 03 head are typically issued only to command and certain specialty units.

While the keypad allows the user private call or page any radio, models lacking the keypad are still able to receive private calls and pages; in addition, there are ways these radios can send them as well.

USING THE APX MOBILE RADIO—BASICS

SCAN ON/OFF:

05 HEAD:

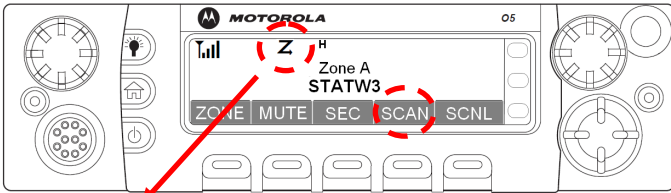

To turn scanning on using the **05 control head**, use the *4-way navigation button* to scroll the menu over until “SCAN” appears on the menu bar. To enable scan, press the corresponding *menu select button*. When enabled, the screen should display “SCAN ON” momentarily and the symbol at left should appear on the display screen.

03 HEAD:

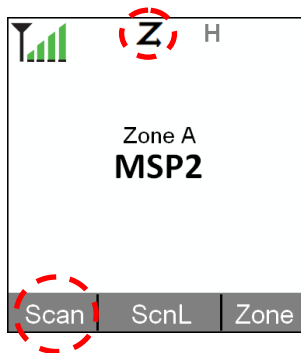

To enable scanning on the **03 control head**, use the *4-way navigation button* to scroll the menu over until “SCAN” appears on the menu bar. To enable scan, press the corresponding menu select button or the *one-dot button*. When enabled, the screen should display “SCAN ON” momentarily and the symbol at left should appear on the display screen.

On some radios if no scan list is programmed for either the **05 control head** or the **03 control head**, the radio may tone and the screen will display “Empty List.”

See page 16 for information on how to program your scan list.

MODE KNOB / BUTTONS:

05 HEAD:

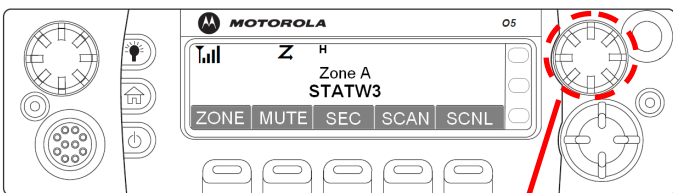

MODE KNOB

The large, free-rotating knob on upper right side of the **05 control head** is called the **mode knob** or “selector.” It primarily functions to change back-and-forth between talkgroups within a particular zone. As you rotate the knob, the screen will display what talkgroup you have tuned to.

03 HEAD:

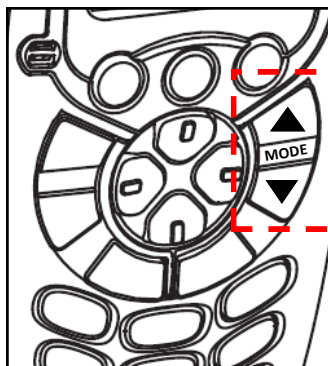

MODE
SELECT
BUTTONS

On the **03 control head**, the mode buttons are located below the display screen. They are composed of a *mode-up arrow* and a *mode-down arrow* (Δ or ∇). The mode buttons on a 03 control head function in the same manner as the mode knob on a 05 control head.

USING THE APX MOBILE RADIO—BASICS

LED INDICATOR:

05 HEAD:

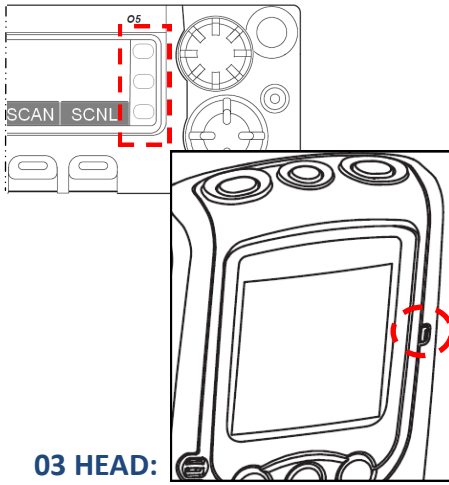

On the **05 control head**, adjacent to the display, are a series of three separate LED indicators. On the **03 control head**, there is a small multi-color LED located adjacent to the display

COLOR	MEANING
Solid Red	Radio is transmitting
Blinking Red	Radio has failed its self-test
Solid Yellow	Talkgroup is busy (someone else is transmitting)
Blinking Yellow	Radio is receiving an encrypted transmission
Solid Green	Radio is powering up
Blinking Green	Radio is receiving a private call or page

EMERGENCY BUTTON:

05 HEAD:

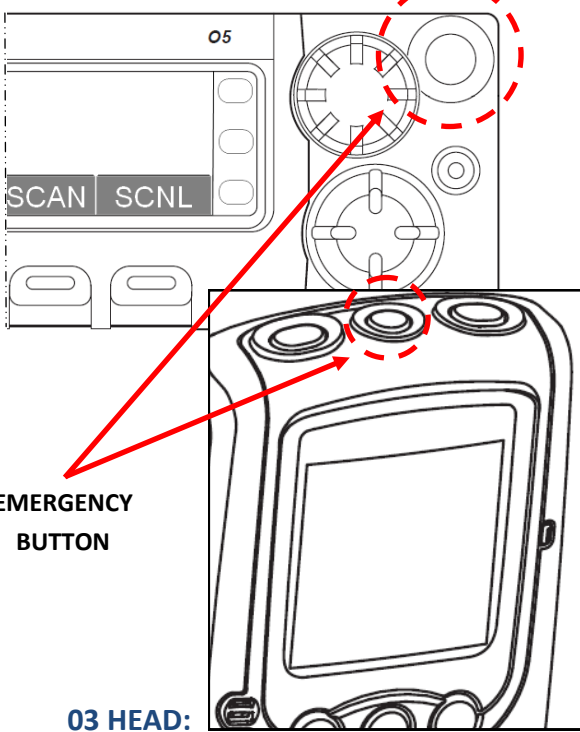

On radios that have the necessary equipment on the dispatch side, the large orange button on the **05 control head** is programmed as the **emergency button**. On the **03 control head**, it is located on top of the microphone and functions in the same way.

Pressing this button *a single time* activates an emergency alert. *Pressing the PTT after pressing the emergency button* elevates the emergency alert to an emergency call. This allows you to override other users of the talkgroup and transmit if someone is talking on it. All other users are aware you have activated an emergency call as their radios will send off tones and their radio display will change colors and show your radio ID number.

To cancel an emergency alert or call, press and hold the emergency button until you hear a solid tone. It may take a few seconds for the system to clear the emergency status.

If activated unintentionally, do not cycle through the various talkgroups as this will set off an emergency status on all the talkgroups you turn to; turning off the radio also will not clear the emergency status. Always contact your dispatcher to advise of an accidental activation.

USING THE APX MOBILE RADIO—BASICS

ONE-DOT BUTTON & TWO-DOT BUTTON:

03 HEAD ONLY:

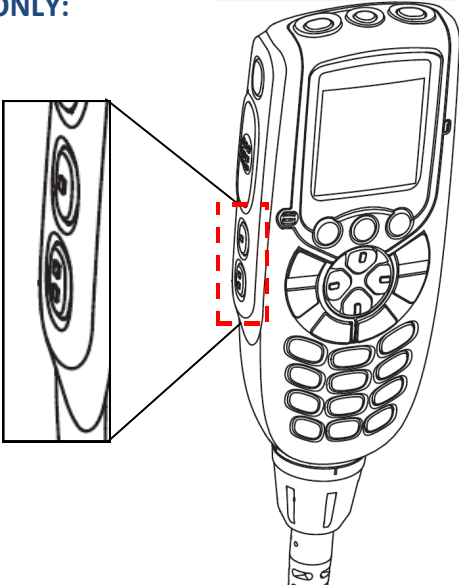

On the side of the **03 control head**, immediately below the PTT, there are two small buttons. The **05 control head** has no such buttons.

The top button as a single raised dot and is referred to as the **one-dot button**. The lower button has two raised dots and is called the **two-dot button**.

On the **03 control head** programmed to MSP specifications, the **one-dot button** is programmed to turn the scanning feature of the mobile radio on or off; the **two-dot button** is normally inactive. However, if you are in the F Zone (analog), a press of the **two-dot button** will select either direct or repeater mode (see below).

DIRECT / REPEATER MODE:

05 HEAD (REPEATER MODE):

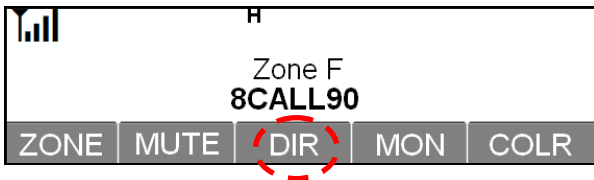

05 HEAD (DIRECT MODE):

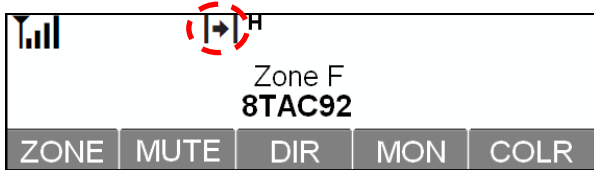

This symbol on your display for either the 03 Control Head or 05 Control Head indicates DIRECT MODE. No symbol indicates REPEATER MODE.



Within Zone F are several analog channels that you may find yourself using: 8CALL90, 8TAC91, 8TAC92, 8TAC93, and 8TAC94. These take the place of the old “I-CALL” or “I-TAC” channels you may have heard about.

In order to use 8CALL90 to reach an MSP Regional Communications Center, *the radio must be in repeater mode*. If you see the symbol for direct (|→|) on your screen you are in direct mode. On the **05 control head**, you must change to repeater mode by pressing the *menu select key* corresponding to “DIR.” The display will tell you “REPEATER MODE” and “DIRECT MODE” as you cycle back and forth by pressing the “DIR” menu select key. The example at left is in the correct (repeater) mode to use 8CALL90 as the direct symbol is absent from the display. Use the **two-dot button** on the **03 control head** to cycle back and forth between direct and repeater modes.

To use 8TAC91, 8TAC92, 8TAC93, and 8TAC94 the radio must be in direct mode. Use the same method as above for the **05 or 03 control head**; you know you are in direct mode when the direct symbol appears on your display.

Many radios have now been programmed so you don’t have to put the radio into repeater or direct mode; these radios have channels labeled 8CALL90, 8CALL90D, 8TAC91, 8TAC91D, and so forth. *The D stands for DIRECT; no D means repeater mode.*

USING THE APX MOBILE RADIO—BASICS

PRIVATE CALL ANSWER:

05 HEAD:

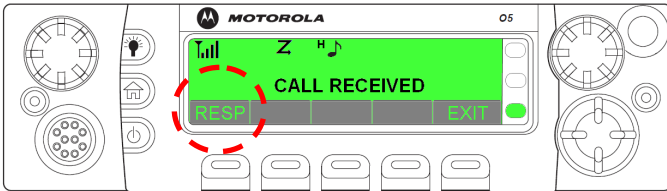

On the side of the **03 control head** is a large purple button sometimes referred to as the *Barney button*. On MSP radios and many radios on the MPSCS, this button is programmed to answer private calls on your APX mobile radio. The **05 control head** lacks a *Barney button* and private calls must be answered using the display screen and the appropriate *menu select key (shown)*.

When you receive a private call the **05 control head** will tone and the display will turn green; the display will alternate between showing your current talkgroup, “*CALL RECEIVED*,” and the calling radio’s radio ID number. At this point, simply pressing the PTT and speaking *will not* enter you into the private call; everyone else will hear you.

03 HEAD:

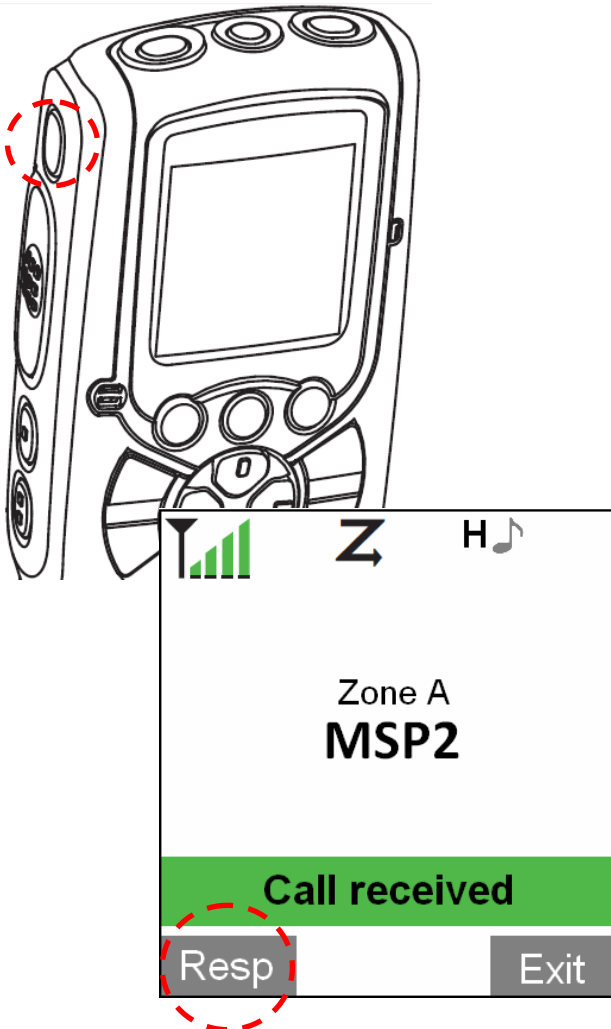

When you receive a private call the **03 control head** will tone and the display will alternate between “*Call received*” and the calling radio’s radio ID number (*shown*). At this point, simply pressing the PTT and speaking *will not* enter you into the private call; everyone else will hear you.

When you receive a private call on your mobile radio, you must first depress the Barney button on the 03 control head; on the 05 control head you must press the menu select key under “RESP” in the menu bar (shown). The 03 head also has an option for pressing the appropriate menu select key for “RESP;” this functions the same as pressing the *Barney button*.

Pressing the *Barney button* or “*RESP*” is akin to picking up the handset on a telephone when you receive a phone call. Once the *Barney button* is pushed, then you may depress the PTT and will be in a private call with whomever was trying to reach you. *The Barney button only needs to be pressed once when you first receive the private call, and only needs to be pressed by the call’s recipient.* To continue in the private call after first pressing the *Barney button* simply use your PTT.

USING THE MOBILE RADIO—MAIN DISPLAY (05 HEAD)

05 CONTROL HEAD DISPLAY:

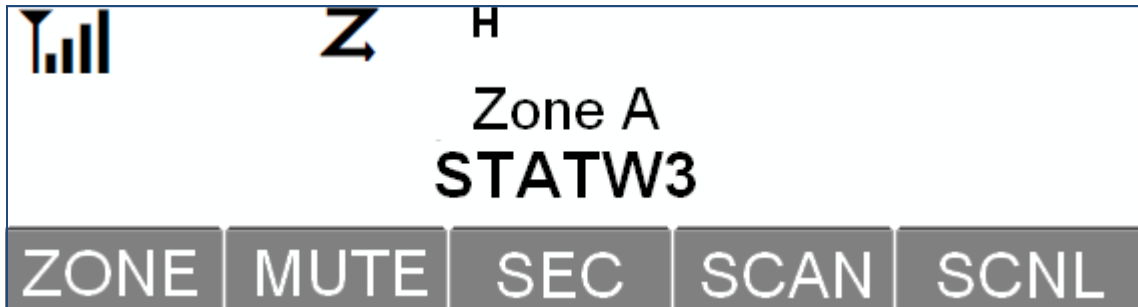

The APX 6500/7500 **05 control head** has a large monochromatic LCD display on the front of the radio; it is capable of displaying various backlight colors, however (see below). The main display is how the radio shows you, at a glance, how your radio is operating and setup. *The example above only shows some of the more commonly seen icons; however, there are additional icons which may appear and these are indicated in the following list.*

At the top left of the screen is a signal strength indicator. This functions much as the “signal bars” you may have on your cell phone screen. Moving to the right we see a number of small icons arrayed at the top of the screen. In this example, we see that we have a scan list populated and the radio is actively scanning talkgroups within our scan list.

Adjacent to the scan icon we see a small H. The radios are set by default to “High Power,” thus this icon will constantly remain on your screen. Moving towards the center of the display, we can see that the radio is currently set to Zone A and is tuned to talkgroup STATW3 within that zone. At the very bottom of the display we can see various menu options that can be accessed by pressing the corresponding *menu select button*. We can change the menu options at the bottom of the display by using the *4-way navigation button* to scroll between the various choices.

MAIN DISPLAY ICONS / BACKLIGHT COLOR:

ICON	DESCRIPTION	ICON	DESCRIPTION
	Displays the RSSI. The more bars, the stronger the signal.		If displayed in the F Zone, the radio is in direct mode. If absent in the F Zone, the radio is in repeater mode.
	The radio is transmitting.		Radio is set to high power by default; cannot be changed.
	Solid: Encryption is turned on. Blinking: The radio is receiving an encrypted transmission.		Absent: GPS feature disabled. Solid: GPS feature available. Blinking: Seeking GPS signal.
	A scan list is populated and the radio is currently scanning.		On: IP packet data on. Off: IP packet data off.
	You are tuned to a talkgroup in your scan list that is currently broadcasting.		Private call or page received.

It is possible to change the backlight color on the **05 control head**.

To do so, use the *4-way navigation button* to scroll the menu bar over until “COLR” appears. Press the appropriate *menu select key*.

The standard colors are amber, red, green, or orange. You also have the ability to create up to five custom colors using “My Color” option. Choose “EDIT” while in a “My Color” menu and use the *mode knob* to change the various colors to a shade of your choosing. Press “SAVE” once it is to your liking.

USING THE MOBILE RADIO—MAIN DISPLAY (03 HEAD)

03 CONTROL HEAD DISPLAY:

The APX 6500/7500 **03 control head** has a large color LCD display on the front of the microphone. The display is how the radio shows you, at a glance, how your radio is operating and setup. *The example to the right only shows some of the more commonly seen icons; however, there are additional icons which may appear and these are indicated in the following list.*

At the top left of the screen is a signal strength indicator. This functions much as the “signal bars” you may have on your cell phone screen. Moving to the right we see a number of small icons arrayed at the top of the screen. In this example, we see that we have a scan list populated and the radio is actively scanning talkgroups within our scan list.

Adjacent to the scan icon we see a small H. The radios are set by default to “High Power,” thus this icon will constantly remain on your screen. Moving towards the center of the display, we can see that the radio is currently set to Zone A and is tuned to talkgroup STATW3 within that zone. At the very bottom of the display we can see various menu options that can be accessed by pressing the corresponding *menu select button*. We can change the menu options at the bottom of the display by using the *4-way navigation button* to scroll between the various choices.

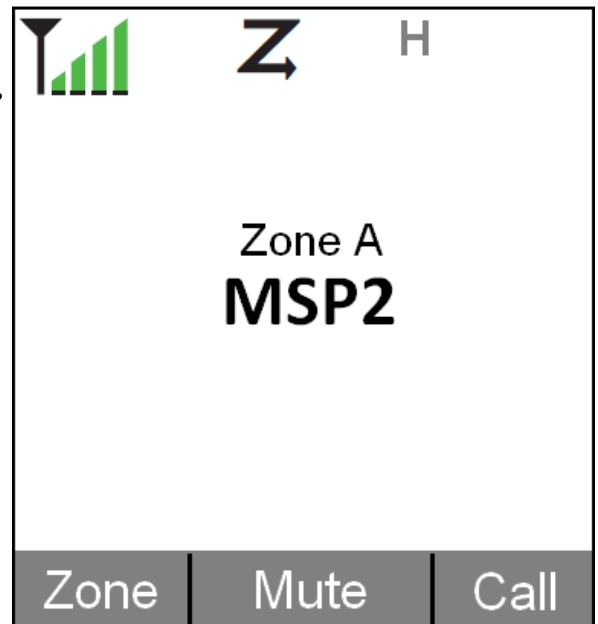

DISPLAY ICONS:

ICON	DESCRIPTION	ICON	DESCRIPTION
	Displays the RSSI. The more bars, the stronger the signal.		If displayed in the F Zone, the radio is in direct mode. If absent in the F Zone, the radio is in repeater mode.
	The radio is transmitting.		Radio is set to high power by default; cannot be changed.
	Solid: Encryption is turned on. Blinking: The radio is receiving an encrypted transmission.		Absent: GPS feature disabled. Solid: GPS feature available. Blinking: Seeking GPS signal.
	A scan list is populated and the radio is currently scanning.		On: IP packet data on. Off: IP packet data off.
	You are tuned to a talkgroup in your scan list that is currently broadcasting.		Private call or page received.

USING THE MOBILE RADIO—ZONES & TALKGROUPS

CHANGING THE ZONE & TALKGROUP:

05 HEAD:

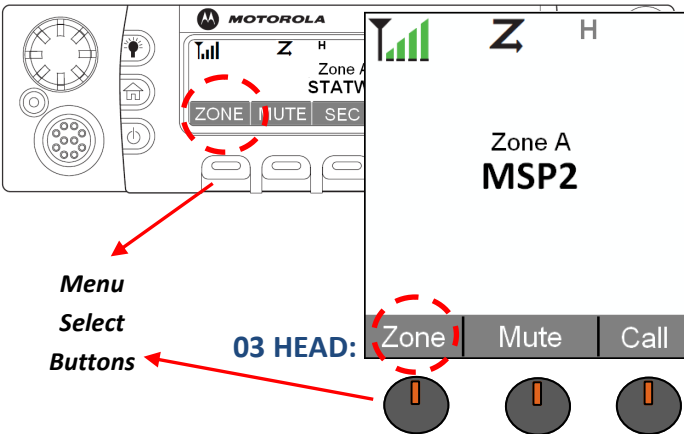

To change the zone on either the **05 control head** or the **03 control head**, look at the display. If the word “Zone” does not appear in the menu selections on the bottom of the display, use the *4-way navigation button* to scroll over until it appears.

Once the word “Zone” appears in the menu, press the corresponding *menu select button* directly underneath of where it appears on the display. In the examples to the left, the zone menu is accessed by pressing the far left *menu select button*.

05 HEAD:

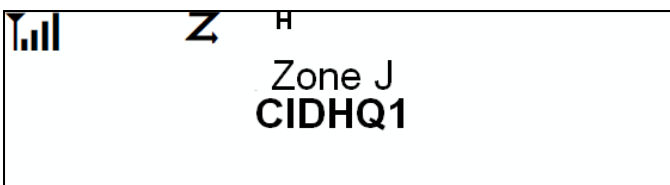

Once the zone menu is accessed on either the **05 or 03 control head**, the display should appear similar to the examples to the left. The currently selected zone will be flashing on your display. To scroll through the various zones, use the left and right arrows on the *4-way navigation button*. Once you locate the zone you wish to use, short press the *home button* to lock in your chosen zone.

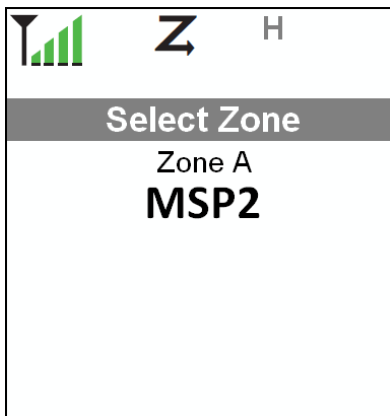

For example, if I need to use a talkgroup located within Zone A of my radio, I would move the navigation button until Zone A appeared on my screen. Once Zone A appears, I would short press the *home button* to lock in my zone choice. This selects Zone A, and you will automatically exit the zone selection menu. The radio’s main display screen is then shown.

03 HEAD:

05 HEAD:

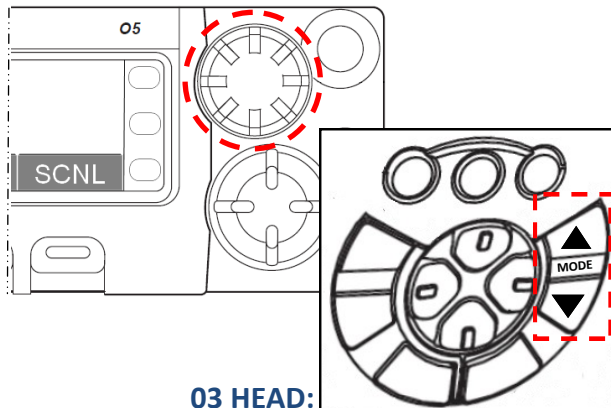

Once you have selected the zone you want, rotate the *mode knob* on the **05 control head** to locate the talkgroup you wish to tune to. On the **03 control head**, use the Δ or ∇ *mode keys* to locate the talkgroup you wish to tune to.

Each zone is capable of holding up to 16 talkgroups. While many zones will contain the full amount, some will not.

If your display reads “Unprogrammed” and the radio begins to tone, simply change the *mode knob* or *mode key* until you begin to see talkgroups.

USING THE MOBILE RADIO—PRIVATE CALLS & PAGES

MAKING A PRIVATE CALL / PAGE:

05 HEAD:

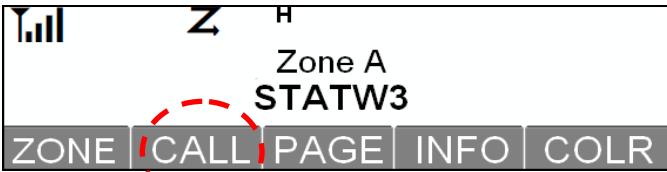

03 HEAD:

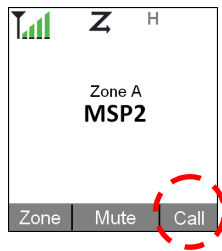

The APX 6500/7500 mobile radio is capable of making private calls or pages even if it lacks the keypad found on certain 03 control heads. The manner for making either a private call or page is the same; for this example we will use a private call.

For either the **05 control head** or the **03 control head**, use the *4-way navigation button* to scroll over until you see “Call” on the menu and press the *menu select button* below it.

05 HEAD:

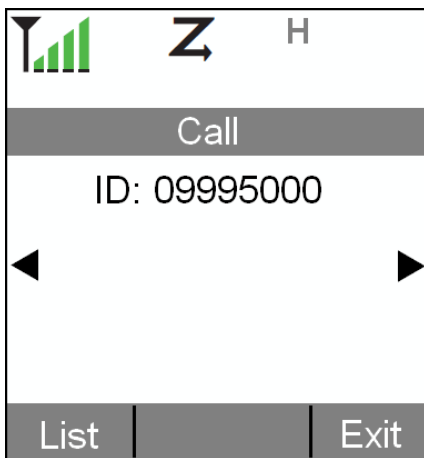
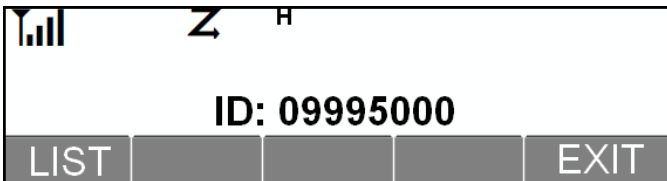

03 HEAD:

Once in the call screen on the **05 control head** or the **03 control head**, the first option available is “ID.” *This is not your radio ID number; the “ID” is the last radio ID that private called or paged your radio.* To locate your radio’s ID number, press the left arrow on the *4-way navigation button*. The screen will now display “MY ID:” and your radio ID number will then be shown.

Many mobile radios in MSP also have one or more radio ID numbers hard-programmed into their memory. This enables radios lacking a keypad the ability to private call or page other radios even though the recipient radio may not have ever called or paged it. Press “LIST” to see the hard-programmed numbers.

To make the private call or page, select the radio you want to reach out to and press the PTT.

05 HEAD:

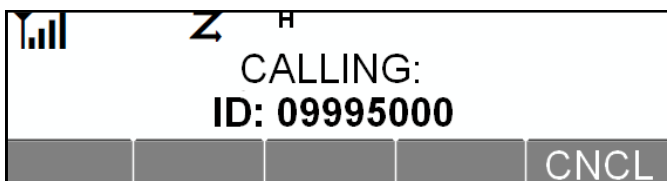

03 HEAD:

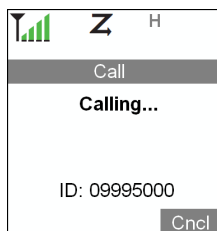

Your radio will begin to make a sound similar to a ringing telephone and the screen will display “Calling...” along with the recipient’s radio ID number.

Once the recipient has entered the private call, communicate using the PTT as you would for a normal radio conversation.

If the recipient does not answer, the private call or page will not be completed. The display will indicate “No answer/acknowledgement.” Select “Ok” and you will exit the private call/page menu.

USING THE MOBILE RADIO—SCAN LIST & SCANNING

BUILDING A SCAN LIST & SCANNING:

05 HEAD:

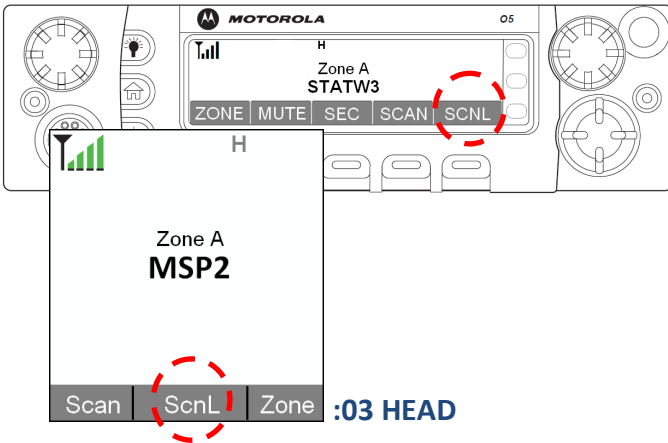

The APX 6500/7500 mobile radio is capable of scanning other talkgroups in addition to the talkgroup your radio is tuned to. In order for the radio to scan, it requires you build a scan list. While it is possible to select a number of additional talkgroups, it is recommended that you not scan more than three in addition to your home talkgroup as the constant radio traffic can potentially become distracting.

Use the *4-way navigation button* to scroll the menu bar until you see "ScnL." This is shorthand for "Scan List." Select "ScnL" using the appropriate *menu select button*.

05 HEAD:

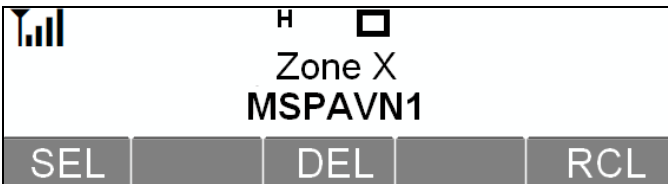

Once in the scan screen you can see three options on the bottom of the display: "Sel" is select, "Del" is delete, and "Rcl" is recall. If you select "Rcl," this will display talkgroups that have already been programmed into your list; each press brings up another scanned talkgroup. If you wish to delete one from your list, select "Del." If there is not an existing scan list, the radio will tone.

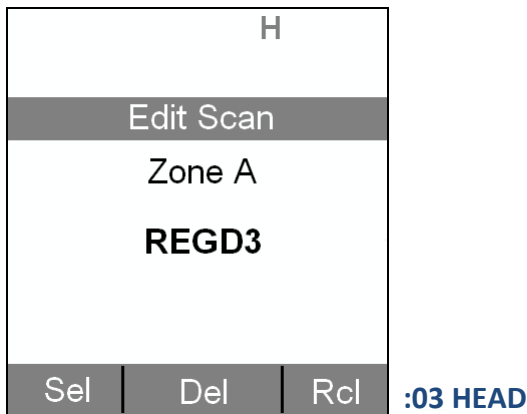

To navigate between zones using the **05 or 03 control head**, press either the left or right arrow key on the *4-way navigation button*. Once you reach the zone you are looking for, press the *home button* to lock in your choice (**05 control head only**).

Once you are within your chosen zone use the mode knob on the **05 control head** to select your talkgroup; use the left or right arrow keys on the **03 control head**. To add this talkgroup to your scan list, press "Sel."

05 HEAD:

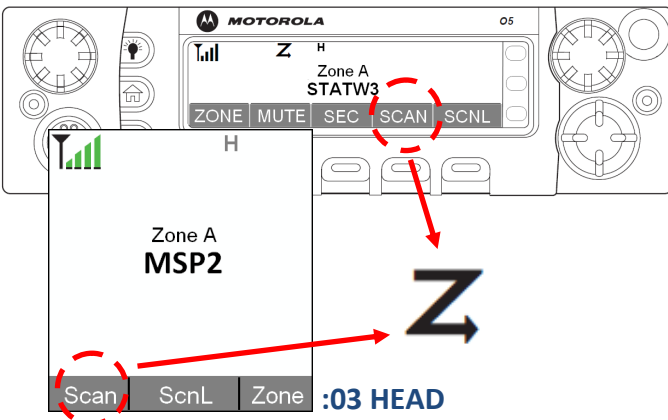

Once your scan list is built to your liking, use the appropriate *menu select key* to chose "SCAN" in order to turn scanning on or off.

If scan is active, the icon shown to the left will appear on the top of the radio's display.

There are a variety of factors that impact scanning for users of the MPSCS. Essentially, if you are affiliated with tower and no one else affiliated with that tower has selected *your scanned* talkgroup as *their primary* talkgroup, you will not hear it on scan.

USING THE MOBILE RADIO—SCAN LIST & SCANNING

SCANNING WITH THE APX 7500:

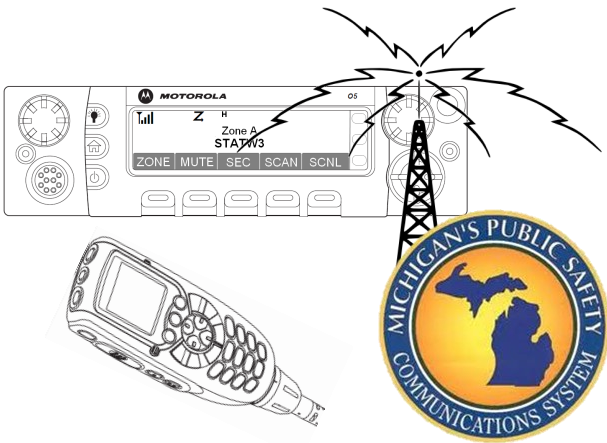

The APX 7500 is capable of transmitting and receiving using either the MPSCS 800 MHz system or a conventional (non-800 MHz) radio system such as VHF.

In the MSP, APX 7500's are typically deployed to those worksites that are operating in an area where a local dispatch center or centers are not on the MPSCS. Some specialty team vehicles also use the APX 7500.

Using the APX 7500 in these areas can eliminate the need for two separate mobile radios (one for each system).

05 HEAD:

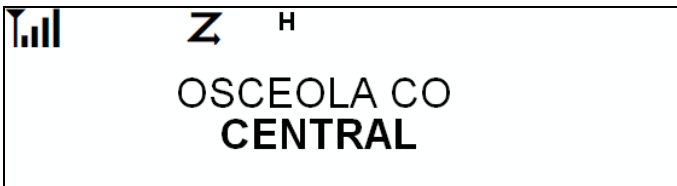

Setting up a scan list on the APX 7500 is done in the same manner as on the APX 6500.

The conventional frequencies are located in the same "Zone" menu as the MPSCS zones (*shown at left*).

It is important to know that cross-band scanning is not available on the APX 7500; meaning, you cannot scan both an MPSCS 800 MHz talkgroup and a conventional talkgroup at the same time.

For instance, I could scan STATW6 and REGD6 on MPSCS, or CENTRAL and JAIL on the Osceola County analog VHF system. I could not, however, scan both REGD6 and Osceola CENTRAL simultaneously.

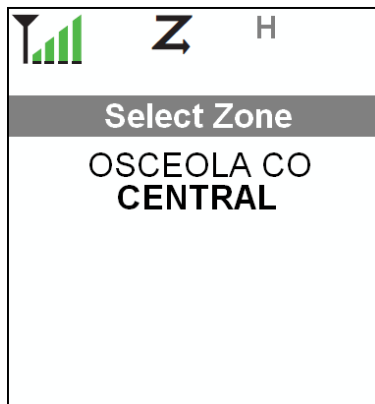

03 HEAD:

05 HEAD:

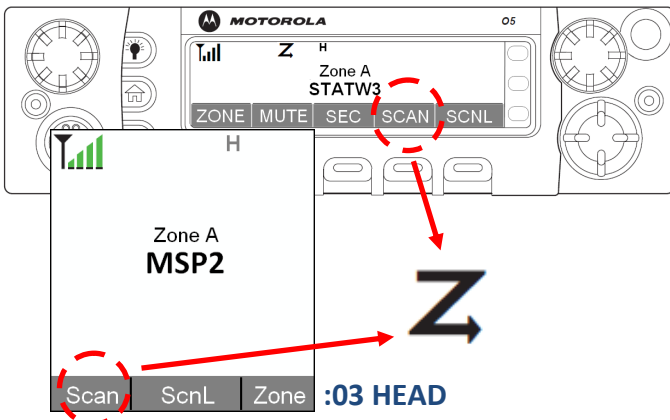

Once your scan list is built to your liking, use the appropriate *menu select key* to chose "SCAN" in order to turn scanning on or off.

If scan is active, the icon shown to the left will appear on the top of the radio's display.

There are a variety of factors that impact scanning for users of the MPSCS. Essentially, if you are affiliated with tower and no one else affiliated with that tower has selected *your scanned* talkgroup as *their primary* talkgroup, you will not hear it on scan.

USING THE MOBILE RADIO—GENERAL FEATURES

ENCRYPTION & RADIO INFO:

05 HEAD:



03 HEAD:

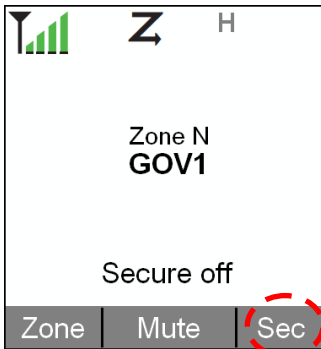

The APX 6500/7500 allows the operator to use encryption when running a sensitive operation. For encryption to work, the user *must* have the following: 1) an encryptable talkgroup; 2) an encryption-capable radio with the proper keys; 3) encryption activated.

On the **05** or **03** control head, you must typically be in an encryptable talkgroup in order to turn encryption on or off. Press the corresponding menu select key for “SEC” and the radio will briefly display the encryption key once activated; if activated the encryption symbol appears on the display as shown to the left. To turn off, press “SEC” again and the display will read “SECURE OFF” as shown on the **03** head to the left.

If you don't see the  symbol on your display, you are not transmitting encrypted.

05 HEAD:

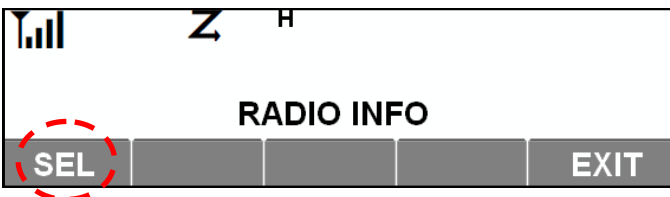

03 HEAD:

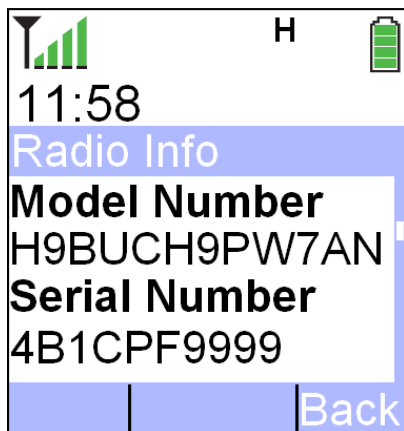

Selecting “Info” from the menu bar on the **05** or **03** head brings up information regarding the radio itself.

Within the information menu, the first option you can select is “Radio Info” as shown on the **03** head to the left. When selected, this provides certain technical information about the radio, most of which is useful only to radio techs. However, if you press the right or left arrow on the 4-way navigation button you will soon come to a section that will provide you with either the model or serial number of the radio, eliminating the need to locate the information on the radio itself.

The second option available on the main info menu screen is “IP Info.” This provides technical information to the radio techs.

The third option, “Control Map,” has a listing of the function each button, knob, or selector performs on your radio. As the APX 6500/7500 is highly programmable by the end-user, this section could be useful if a department has several APX radios with differing programming between them. MSP radios are typically programmed to be the same across the department; sometimes small differences may exist, however, so it is important to learn how your particular radio operates.

USING THE APX PORTABLE RADIO—TONES & SOUNDS

SOME OF THE TONES YOU MAY HEAR:

The APX 6000/7000 portable radios use various tones or sounds to keep you informed of how the radio is operating and if there is a problem. Some you will hear everyday (such as the channel grant), and some you may never hear (such as the system busy tone). *Many of these tones are accompanied by a message on the main display screen.*

STONE	DESCRIPTION
Channel Grant / Talk Permit <i>Quick chirping sound (dah dah dit)</i>	Your transmission can proceed and will be broadcast. You must wait until the channel grant sound is finished.
Bonk <i>Long, medium tone (boooooooooonk)</i>	You can't talk. Someone may be using the talkgroup you wish to use. Wait until they are finished. This tone is not the same as system busy.
System Busy <i>Quick series of tones (like a fast telephone busy)</i>	All Intellirepeaters on the tower are busy and there is no open pathway for communication. Continue pressing the PTT for up to four seconds as the system has you "in line" to talk.
Ringling <i>Fast telephone ringing</i>	You are private calling another radio and awaiting their acceptance of the call.
Battery Critical <i>Two short, high-pitched beeps</i>	Battery is critically low. Replace your battery.
Site Trunking <i>Two short, increasing tone beeps</i>	Tower is in site trunking.
Emergency Alert/Call <i>Four high-pitched beeps</i>	You have initiated an emergency alert/call.
Emergency Received <i>Alternating high and low pitched tones</i>	Someone else has initiated an emergency alert/call.
Time-Out Warning <i>Quick beep while you are transmitting</i>	You have transmitted for 55 seconds. The system will time you out at 60 seconds.
Time-Out <i>Long, medium tone</i>	System has timed you out. Key your PTT to continue transmitting.
Private Call Received <i>Two short, high-pitched beeps</i>	You have received a private call.
Page Received <i>Four short, high-pitched beeps</i>	You have received a page.

If you need assistance with radio training, radio equipment, batteries, or peripherals and are an MSP member, please contact the unit directly or the communications sergeant assigned to your area. Contact information is available on the MSP Intranet under the eApps & Tech Support Contact section.

MSP COMMUNICATIONS

7050 Harris Drive

Lansing, MI 48913

(517) 284-3000 (Section Main)



“A PROUD tradition of SERVICE through EXCELLENCE, INTEGRITY, and COURTESY”