

Mowing and Trimming Safety

For the Landscaping and
Horticultural Services Industry

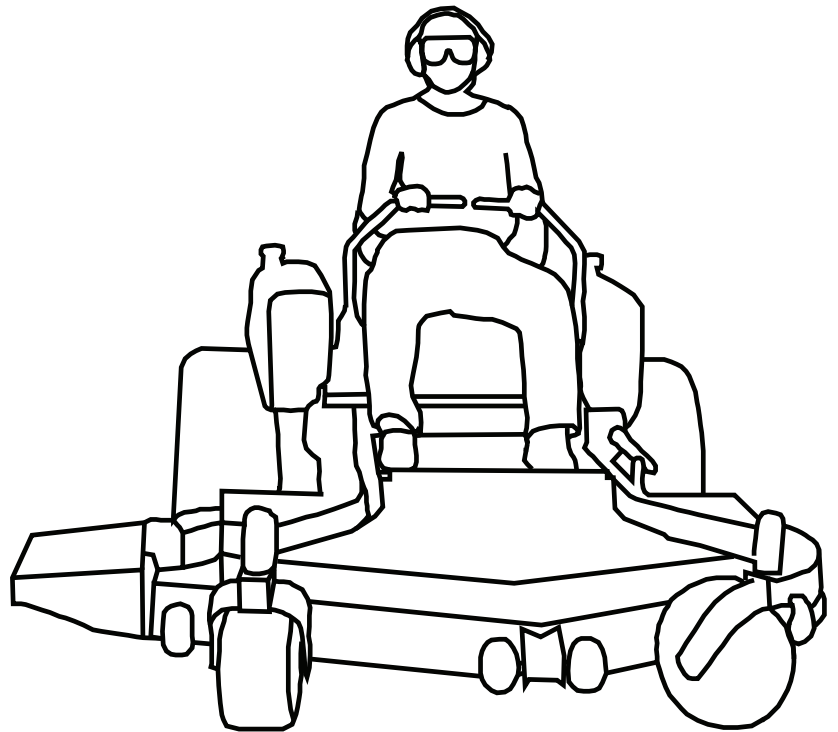

KSTATE
Kansas State University®
Research and Extension

*Knowledge
for Life*

Mowing and Trimming Safety

Contents

Introduction What's Inside?	3
Lesson 1 Take Control of Your Own Safety	4
Lesson 2 Prepare for Safe Operation	9
Lesson 3 Preventing Rollover Accidents	15
Lesson 4 Avoid Being Caught in Moving Parts	18
Lesson 5 Other Common Dangers	22
Lesson 6 Environmental Hazards	27
Conclusion	34
Quiz Yourself Solutions	37

Written by:

Sara Lind, Information specialist

Mitch Ricketts, Coordinator, Health, Safety and Environmental Quality, K-State Research and Extension

Disclaimer

This material was produced under grant number 46G3-HT04 and revised and updated under grant number SH-19503-09-60-F-20 from the Occupational Safety and Health Administration, U.S. Department of Labor. It does not necessarily reflect the views or policies of the U.S. Department of Labor, nor does mention of trade names, commercial products, or organizations imply endorsement by the U.S. government.

This booklet was produced by K-State Research and Extension, Kansas State University, Manhattan, Kansas.

The information in this publication has been compiled from a variety of sources believed to be reliable and to represent the best current opinion on the subject. However, neither K-State Research and Extension nor its authors guarantee accuracy or completeness of any information contained in this publication, and neither K-State Research and Extension or its authors shall be responsible for any errors, omissions, or damages arising out of the use of this information. Additional safety measures may be required under particular circumstances.

What's Inside?

This booklet teaches important safety practices to follow when mowing. You may use a wide range of equipment including:

- ▶ agricultural mowers
- ▶ riding lawn mowers
- ▶ walk behind mowers
- ▶ string trimmers
- ▶ brush trimmers

Safety tips, along with real accident reports, have been combined to give you a better understanding of the risks associated with this type of work.

Use this booklet in conjunction with hands-on safety training and the equipment operator's manual.

Lesson 1

Objectives

1. Name the most common types of serious accidents involving mowers and trimmers.
2. Interpret the meaning of common warning signs and labels.
3. Identify appropriate protective equipment.

Take Control of Your Own Safety

Greatest Dangers

Failure to observe safety precautions when operating mowing equipment can result in serious injury or death. The most common types of serious accidents are:

1. Rollovers

Agricultural mowers and riding lawn mowers can overturn, causing injury and death.

Accident Report

Operator Crushed by Riding Mower

Summary of OSHA Accident Inspection 107975153

A worker was operating a riding mower on a hill. He was mowing too fast and made a sharp turn, causing the mower to tip over. The mower landed on top of him, crushing his rib cage, puncturing his lungs and killing him.



Never make sharp turns at high speeds, especially on a hill.

2. Being Caught in Moving Parts

Serious injury or death can result from being caught in mowing equipment's moving parts.

Accident Report

Employee Loses Finger While Lifting Mower

Summary of OSHA Accident Inspection 119815108

An employee was operating a riding mower in a parking lot. The mower slipped off the curb. Without shutting off the engine, the employee and a coworker tried to lift the mower. One of the employees put his hand under the front of the mower and lost three fingers at the first knuckle.



Never put hands or feet under a running mower. Always shut off the mower and disconnect the spark plug before servicing or reaching under the mower deck.

Help Yourself

Safe work habits are important. Here are three actions you can take to be safe on the job site.

1. Learn All You Can.

To prevent accidents with mowers and trimmers, read and follow directions in the equipment operator's manual. Pay attention to safety instructions in the manual and to warning labels you see on the equipment. If you have questions, stop and ask your supervisor before you continue.

2. Concentrate on Working Safely.

Sometimes you may be tempted to take risky shortcuts. Remember that an accident can leave you permanently injured or cut your life short. For your safety and the safety of those around you, do not take unnecessary risks. No deadline is so pressing you can't take the time to do your work safely.

3. Additional Precautions.

Do not operate machinery if you are tired or have taken drugs or alcohol. If you are on medication, discuss with your doctor or pharmacist if you are capable of safely operating machinery.



Safety Messages and Signs

Manufacturers put important safety messages on mowing equipment and in the operator's manual. It is critical to read, understand and follow all safety messages.

The triangle shape is the symbol for caution. The exclamation mark in the center means *Pay Attention*. In some instances, the triangle-shaped sign will show a picture. Other times, words explain why the sign is used.

Many safety messages use the words *Caution*, *Warning* and *Danger* to get your attention. Following are safety messages and their meanings. Each of these signs will have a written message, and perhaps a picture, about an unsafe condition.

CAUTION means you need to be careful. Follow the directions on the sign or you could get hurt.

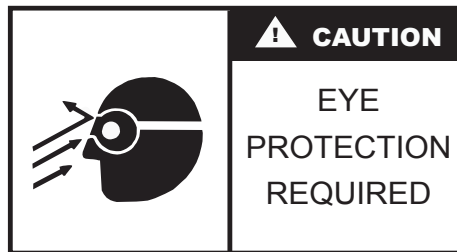

WARNING is more serious and means you need to follow the directions on the sign or you could be badly hurt or killed.

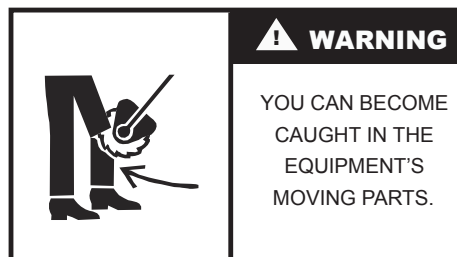

DANGER is the most serious safety message. If you don't follow the directions, you will be seriously injured or killed.



Images displayed in the caution, warning and danger boxes have been recreated from images taken with permission from ASAE S441.3, FEB1999 (R2005), Safety Signs.

Protective Equipment

Certain equipment is necessary to protect your body from materials ejected from the mowing equipment and from being caught in moving parts. When operating mowing equipment you should wear the following.

Close-fitting clothes and no jewelry

Loose shirt sleeves, pant legs or jewelry can catch in the equipment's moving parts, resulting in injury; therefore, close-fitting clothes should be worn. Pull back long hair.

Long pants and sturdy, non-slip boots

Wear long pants, and sturdy, non-slip boots to protect your legs and feet from objects that are thrown from the mower. Never wear sandals, which expose your feet, or tennis shoes, which can easily be severed if caught under the mower deck or in the trimmer's cutting swath.

Safety glasses and a face shield

Safety glasses should be worn at all times unless operating equipment with an enclosed cab. A face shield should be used, in addition to safety glasses, when operating a string/brush trimmer and other times when your face could be hit by debris.

Accident Report

Employee's Eye Cut by Flying Debris

Summary of OSHA Accident Inspection 119806867

An employee was mowing grass with a tractor, but was not wearing safety glasses. He looked back and a piece of metal was thrown from the mower and punctured his right eye. He lost all vision in that eye.



Always wear eye protection when operating all mowing equipment.

Hearing protection

Over time, you will lose your hearing if you are exposed to loud noises without protection.

Two common types of hearing protection are muffs and plugs. Ear muffs should seal around your ears to properly muffle loud noises. Reusable ear plugs should be washed with warm, soapy water after each use in order to prevent infection. Disposable ear plugs should be discarded after each use.

When to Wear Hearing Protection

OSHA Standard 1910.95 (i) (l) requires hearing protection to be worn when sound levels exceed certain limits (generally, a daily average of 85 or 90 decibels, depending on the circumstances). These levels can be measured with a sound level meter. A hearing conservation program requiring hearing tests and other precautions may also be necessary. Check with the equipment operator's manual, as well as your supervisor, for suggestions on hearing protection for each piece of equipment as well as instructions on how to wear it properly.

Hearing Protection Rules of Thumb

Hearing protection may be needed if:

- ▶ You have to raise your voice significantly to be heard by someone three feet away.
- ▶ After leaving a noisy area, your ears feel plugged or you hear a mild ringing or whooshing noise that goes away after an hour or two.
- ▶ When you start your car in the morning, the radio is so loud from the evening before that you have to turn it down.



Quiz Yourself

Circle the correct answer.

Answers can be found on page 37.

1. What are the two most commonly reported causes of serious injury and death from operating mowers and trimmers?
 - a. Rollovers and being caught in moving parts.
 - b. Heat stroke and lightning strike.
 - c. Carbon monoxide poisoning and burns.

Select the correct answer for the following sentences from the list below.

- a. Danger
 - b. Safety glasses
 - c. Alcohol
 - d. Caution
2. The triangle shape is the symbol for _____.
 3. _____ should always be worn when operating mowing equipment.
 4. Never operate any type of equipment under the influence of _____ or drugs.
 5. _____ is the most serious safety message.

Circle the correct answer.

6. When operating mowing equipment, it is important to wear clothes that are _____.
 - a. Expensive
 - b. Close-fitting
 - c. Ironed
7. Wear _____ to protect your feet when mowing and trimming.
 - a. Sandals
 - b. Tennis shoes
 - c. Sturdy boots

Prepare for Safe Operation

Pre-Start Inspection

Safety starts before the engine. A thorough inspection of the mower or trimmer is important before beginning work each day. Use the checklist on the next page as a guide for daily, visual inspections. Alert your supervisor if you find anything wrong during your daily pre-start inspection.

Belts

Check for loose or damaged belts. Loose belts can slip, causing friction and a possibly a fire. Belts can also break and be flung from the mower. Tighten loose belts and replace belts if any ply separation or cracks are visible.

Blade

Make sure the blade is secure, balanced and covered to prevent injury. Report bent, cracked or worn blades to your supervisor. Protect your hands with heavy-duty gloves when inspecting blades.

Fluid Leaks

Fluid leaks can be a fire hazard as well as cause break-downs. Report signs of leaking fluid to your supervisor immediately.

Accumulated Grass or Grease

Check the mower deck and chute for accumulations of grass clippings, leaves, grease and other debris. Debris build-up on moving parts is a fire hazard and can cause break-downs.

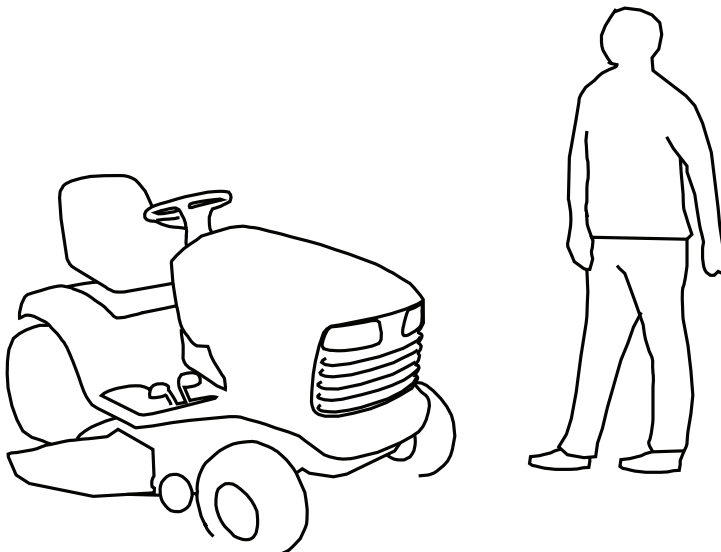

Lesson 2

Objectives

1. Indicate mower parts to be inspected before operation.
2. Identify steps to prepare the area for safe mowing.
3. Recognize safe start up and shut down procedures.

Pre-Start Checklist

Belts

- Secured?
- Not cracked or separated?

Blade

- Secure and balanced?
- Sharpened?
- Free of excessive wear?

Fluid Leaks

- No sign of fluid leaks?

Accumulated Grass or Grease

- Mower, deck and chute free of debris?

Guards

- All guards in place?
- No sign of damaged guards?

Tires

- Proper inflation?
- No visible damage?
- Lug bolts tight?

Attachments (if applicable)

- Mounted and secured properly?

String/Brush Trimmer

- String/blade attached properly?
- String/blade shield in place and secured?

Protective Clothing and Equipment, as Needed

- Long pants
- Sturdy, non-slip boots
- No loose clothing or jewelry
- Hearing protection
- Eye protection
- Face protection

Missing or Damaged Guards

Guards and shields protect you from moving parts. Check the operator's manual for the location of guards and safety shields on the equipment you are using.

When Operating an Agricultural Mower

Ensure there is a shield covering the power take-off (PTO) to keep you from being entangled in the rotating shaft. Also, if your equipment has any belts or pulleys, make sure the guards are in place and secured.

When Operating a Riding Mower

Ensure that the discharge chute's guard is in place to deflect debris and cover the mower's blade. Also, if your equipment has any belts or pulleys, make sure the guards are in place and secured. Also, check that the operator presence control is working properly. The control shuts the mower off automatically when weight is lifted off of the seat.

When Operating a Walk Behind Mower

Ensure the operator presence control is working properly. The engine should shut off automatically when the handle is released. There should be a rear guard installed to protect your feet, as well as a discharge chute on the side of the mower that deflects debris and covers the mower's blade.

Operator Presence Control

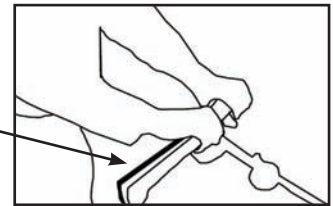

Tires

Check tire pressure and look for signs of damage. Make sure lug bolts are tight to keep the wheel from slipping off.

Attachments (if applicable)

Make sure attachments are mounted and fastened correctly.

String/Brush Trimmer

Ensure the shield covering the string/blade is in place and secured.

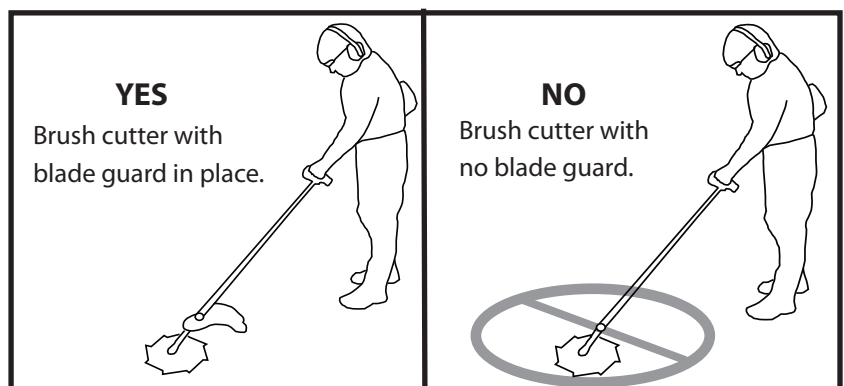

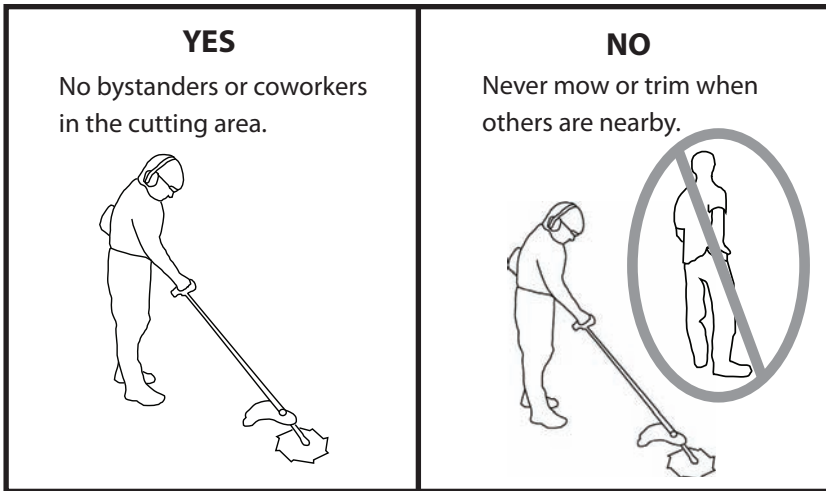

Prepare Mowing Area

Prepare the mowing area before beginning to ensure a safe working environment for yourself and others.

Remove Debris

Walk the area to be mowed. Pick up debris such as rocks, sticks, bottles, cans, wires, etc. Debris picked up by a mower or trimmer can be thrown from the machine at speeds as high as 200 m.p.h. or cause the equipment to jam or malfunction.

Be Aware of Surroundings

While scanning the area for debris, locate other potential hazards such as ditches, drop-offs or embankments.

Be aware at all times of the location of coworkers. Keep all others out of the area while you are mowing or trimming.

Make sure that the chute of the mower is pointed away from people, animals, buildings and traffic.

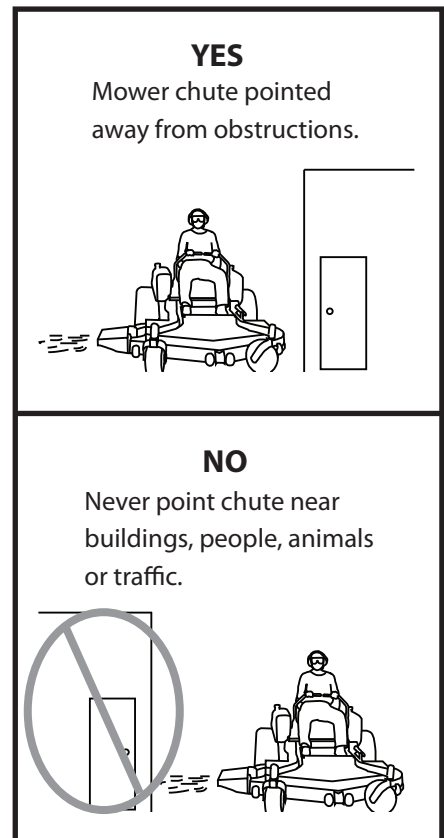

Accident Report

Operator Struck in Eye by Rock

Summary of OSHA Accident Inspection 119964930

An employee was operating a string trimmer near a coworker. The trimmer caught a rock and threw it at the coworker, striking him in the eye. The coworker was hospitalized for two days.



Always be aware of the location of coworkers and wear appropriate eye protection.

Safe Start Up and Shut Down

Start Up Safety Procedures

1. Make sure all attachments are disengaged.
2. Shift into neutral before starting the engine.
 - ▶ Always start string/brush trimmers on the ground.
 - ▶ Start riding equipment from the operator's seat only.
 - ▶ Keep hands and feet away from the blade area when starting walk behind mowers.

Safe Shut Down Procedures

1. Disengage the blade and other attachments.
2. Lower the attachments to the ground.
3. Shift the controls into neutral.
4. Set the parking brake.
5. Turn off the engine.
6. Remove the key (if applicable).

Accident Report

Employee Crushed When Runover by Tractor

Summary of OSHA Accident Inspection 123560880

An employee, jump-starting his tractor mower with another battery, connected the cables. The tractor was in gear, started and ran over the employee, crushing him to death.



Always shift the gear to neutral before shutting down equipment. Refer to the operator's manual for jump-starting instructions.

Safe Fueling Procedures

Gasoline and other fuels are flammable. Follow safe fueling procedures to help reduce the risk of fuel ignition.

- ▶ Always shut off the engine and wait at least 5 minutes for the engine to cool before refueling.
- ▶ Use only approved fuel containers and store in a well ventilated area, away from direct sunlight.
- ▶ Never smoke or have an open flame near fuel.
- ▶ Touch the fuel nozzle to the machine before removing the fuel cap to prevent a static spark from igniting the fuel.
- ▶ Use a funnel or a non-spill nozzle when fueling to reduce spillage.
- ▶ Keep the nozzle or funnel in contact with the fuel tank while filling.
- ▶ Wipe up all spills immediately, before starting the engine.
- ▶ Never clean your hands with gasoline. Use a nonflammable solvent instead.

Accident Report

Employee Burned When Gas Ignites

Summary of OSHA Accident Inspection 002841710

The operator of a riding mower attempted to refuel the mower he had been using. As he was filling the gas tank, some gasoline ignited as it spilled onto the hot motor. The employee suffered first degree burns to his face and forearms.



Always shut off engine and wait at least 5 minutes for it to cool before fueling.

Carbon Monoxide

Carbon monoxide (CO) is a colorless, odorless, tasteless gas that can poison and kill. Symptoms of CO poisoning include headache, nausea, weakness, dizziness, and the loss of consciousness. To avoid CO poisoning, operate all equipment outdoors. If you must work indoors, make sure there is adequate ventilation to prevent exposure to CO.

Accident Report

Employee Dies of CO Poisoning

Summary of OSHA Accident Inspection 123812240

An employee was working on a lawn tractor with the engine running inside a garage. He was overcome by carbon monoxide and died.



Make sure there is adequate ventilation when equipment is run inside a building.

To Properly Fill Fuel Containers:

1. Set the container on the ground.
2. Touch the nozzle to the container before removing the container lid.
3. Keep the nozzle in contact with the container while filling.
4. Don't fill to the brim. Leave room for expansion. Portable containers and gas tanks should be filled $\frac{3}{4}$ full.
5. To reduce the chance of static sparks, do not fill containers in the bed of a pickup or in a car.

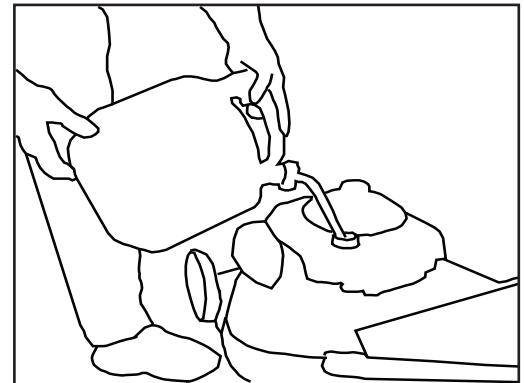

Quiz Yourself

Circle the correct answer.

Answers can be found on page 38.

1. Loose belts, fluid leaks and accumulated grass and grease can be _____ hazards.
 - a. Water
 - b. Wind
 - c. Fire
2. Check the _____ for the location of shields and guards on your equipment.
 - a. Operator's manual
 - b. Local newspaper
 - c. OSHA Web site
3. Which illustration shows how to correctly mow beside buildings?

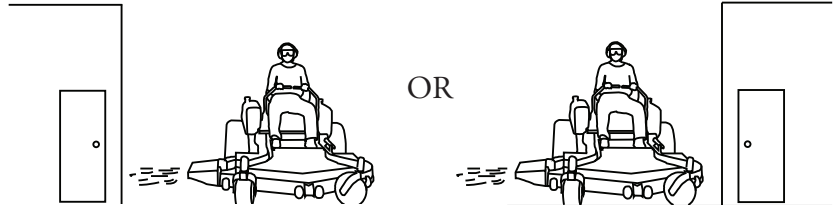

4. To keep children and unauthorized people from starting the machine, always remove the _____ from riding equipment.
 - a. Lights
 - b. Key
 - c. Belts
5. The gas tank should be filled after the engine has cooled for at least _____ minute(s).
 - a. 1
 - b. 3
 - c. 5

Preventing Rollover Accidents

Avoiding Rollovers

When a mower becomes unstable or out of balance, it can roll over. A human's reaction time is too slow to stop a rollover once it starts. Look over the area before you mow, noting all land elevation changes. Once you have assessed the area to be mowed, observe the following precautions to avoid rollover accidents.

Do not mow near drop-offs, ditches, embankments or steep slopes.

The wheels on your mower and attachments can drop off or slide over the edge, causing the mower to roll over. Use a string trimmer to cut grass in these locations.

Do not operate tractors and mowers on steep hills. Refer to the operator's manual for the maximum slope allowed for your equipment.

Accident Report

Employee Crushed When Tractor Overturned

Summary of OSHA Accident Inspection 103039624

An employee started up a steep hill to mow around a storage building. The tractor overturned and rolled over the employee, crushing him to death.



Know the maximum slope on which your equipment can safely be operated.

Lesson 3

Objectives

1. Recognize safe operating procedures to prevent a rollover accident.
2. Identify issues of concern when mowing on slopes.

Don't be Confused!

Agricultural Tractor/Riding Mower

Mow Up and Down Slopes



Walk Behind Mower

Mow Across Slopes

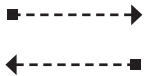

Avoid sudden moves.

Abrupt starts, stops and sharp turns can make the equipment rollover.

Slow down when turning and make wide, gradual turns, especially when mowing on slopes.

Turning quickly and sharply can cause the mower to overturn. When mowing on slopes, don't turn unless you have to. If turning is required, turn slowly and downhill.

Riding Lawn Mowers/Agricultural Tractors

Mow up and down slopes, not across. Your mower can become unbalanced and overturn on slopes, if you do not drive in the correct direction. Mowing up and down slopes can help prevent a side rollover.

Keep the heavy end uphill to avoid a rollover. Refer to your operator's manual to determine which end is heavier.

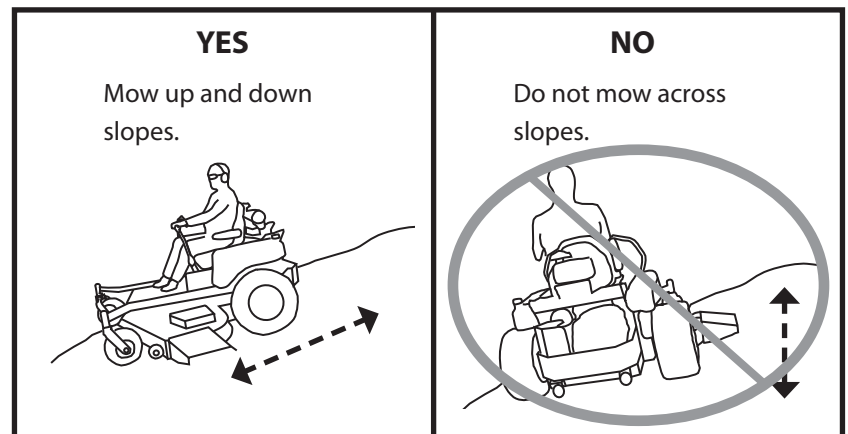

Walk Behind Mowers

Mow across slopes, not up and down, to keep you from sliding underneath the mower.

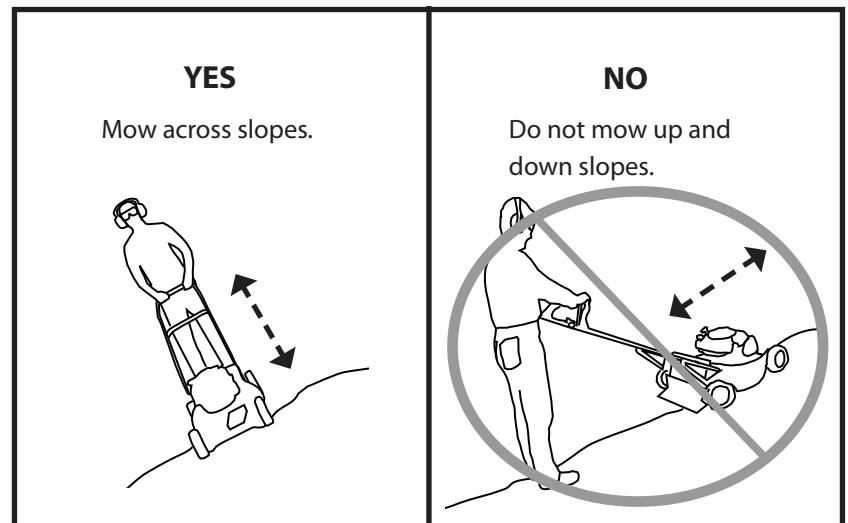

Quiz Yourself

Circle the correct answer.

Answers can be found on page 39.

1. A _____ should be used to cut grass in areas where a mower cannot go such as ditches, drop-offs or embankments.

- a. Pair of scissors
- b. String trimmer
- c. Tractor with attachments

2. When using an agricultural tractor or riding lawn mower on slopes, which picture correctly illustrates the direction to mow?

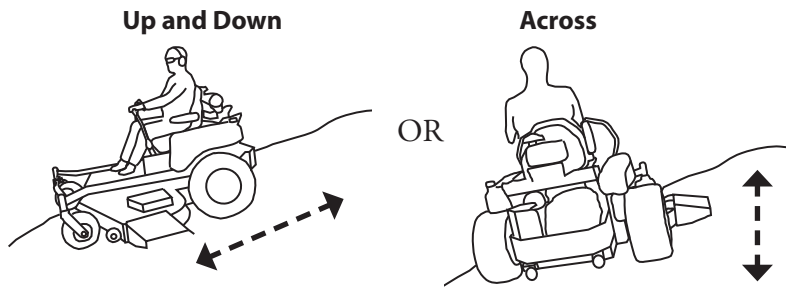

3. When using a walk behind mower on slopes, which picture correctly illustrates the direction to mow?

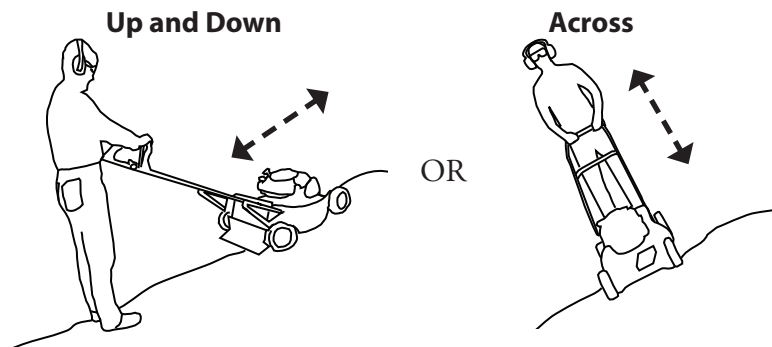

4. When turning, slow down and make wide, _____ turns.

- a. Sharp
- b. Gradual
- c. Narrow

5. Keep the _____ end of a riding mower or tractor uphill to help avoid rear rollover.

- a. Light
- b. Heavy
- c. Shiny

Lesson 4

Objectives

1. Recognize safe operating procedures to avoid being caught in moving parts.
2. Identify hazards associated with equipment parts.

Avoid Being Caught in Moving Parts

Don't Get Caught in Moving Parts

Observe these precautions to prevent being caught in the equipment's moving parts.

1. Keep both hands and feet on the equipment at all times (if applicable).

Never reach around or beneath a running mower or trimmer.

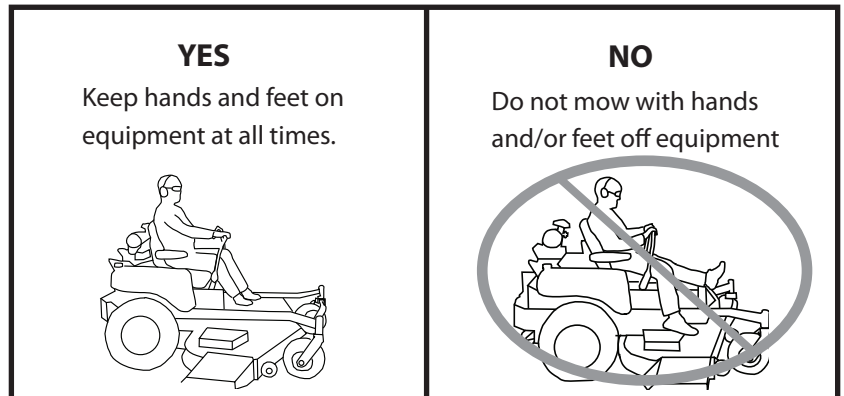

2. Never use a mower or trimmer without all shields and guards in place.

Shields and guards protect you from being caught in moving parts and should always be in place and undamaged when operating mowers and trimmers.

Accident Report

Operator's Eye Cut by Flying Glass

Summary of OSHA Accident Inspection 104395389

An employee was operating a walk behind mower in a ditch. The blade's rear guard was bent up at the bottom, leaving a 2-inch section exposed. The employee was backing the mower out of the ditch when he was struck in the right eye with a piece of glass.



Never operate a mower or trimmer with a damaged guard. Always wear eye protection.

3. Never add blades or chains not recommended by the manufacturer.

A blade or chain not specifically designed for the equipment can seriously injure or kill you. Refer to the operator's manual for recommended attachments.

4. Shut off the engine before picking up debris or unlogging the chute.

If the mower becomes clogged, turn the engine off and disconnect the spark plug wire before attempting to clear debris from the discharge chute. String trimmers should also be turned off before removing debris.

Accident Report

Operator's Finger Amputated in Blade While Clearing Grass Clippings

Summary of OSHA Accident Inspection 119960714

An employee tried to clear grass clippings from the discharge chute of a riding lawn mower. He reached in with his right hand while the mower was running and the blades engaged. The employee lost two of his fingers.



Shut off the mower and remove the spark plug wire before clearing debris from the chute.

Accident Report

Employee's Fingers Amputated While Clearing Debris from Beside Mower

Summary of OSHA Accident Inspection 112004809

An employee was mowing grass when he reached down to pick up a piece of telephone wire from the ground beside the lawn mower. The blade caught the wire and pulled his left hand under the machine, amputating his index finger and the tip of his middle finger.



Inspect the area and remove any debris before mowing.

5. Never work on the equipment while it is running.

Turn off the engine, disconnect the spark plug wire (or unplug if electrical) and allow moving parts to stop before unclogging, adjusting, changing blades or working on equipment. This procedure should also be followed if you hit an object or if the equipment vibrates unusually.

Accident Report

Employee's Killed After Dismounting Running Tractor

Summary of OSHA Accident Inspection 109574764

An employee was dismounting a tractor mower with the motor still running. He hit the shifter and the tractor went into forward gear. He was run over by the mower and killed.



Never dismount from running equipment.

YES

Turn off the engine and disconnect the spark plug wire before attempting to clear debris from mowing equipment.

NO

Do not reach in to unlog while engine is running.

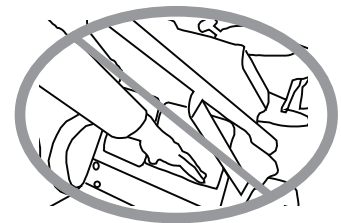

YES

Turn off the engine and disconnect the spark plug wire before adjusting or working on mowing equipment.

NO

Never work on running equipment.

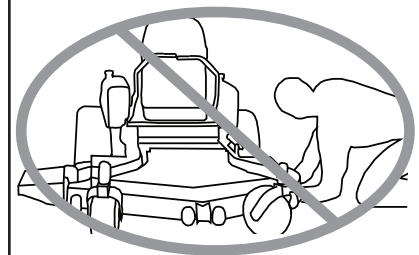

6. Be cautious on wet grass.

Slips on wet grass can cause you to fall into the equipment's moving parts. Also, wet grass can cause riding mowers and agricultural tractors to slide or skid, throwing you off.

Accident Report

Operator Cut by Mower Blade

Summary of OSHA Accident Inspection 125582973

An employee was operating a riding mower without the blade guard in place. He dismounted the mower in order to move a picnic table in his path. The employee slipped on the wet grass and slid into the exposed rotating blade. He sustained a fractured right ankle, partial amputation of his left foot along with severe and extensive cuts.



***Never operate a mower without all guards in place.
Never dismount a running mower.***

7. Always push the mower, never pull, to keep from pulling the mower over your feet.

Never lift the mower up. Push the mower forward to turn so that you do not pull the equipment over your feet.

Accident Report

Employee's Toes Severed While Turning Mower

Summary of OSHA Accident Inspection 119869220

An employee, operating a walk behind mower, encountered a wall. He lifted the front wheels in the air in order to turn. After turning, he put the front wheels back down, on top of his right foot. His five toes were severed when they entered the rotating blade area.



Never lift the mower up to complete a turn.

Quiz Yourself

Circle the correct answer.

Answers can be found on page 40.

1. When mowing, _____ grass can be a hazard to operators of all types of equipment.
 - a. Cut
 - b. Short
 - c. Wet

2. Only blades recommended by the _____ should be added to mowing equipment.
 - a. Manufacturer
 - b. Custodian
 - c. Operator

3. Before performing maintenance or unclogging debris from the mower's chute, turn off the engine and _____.
 - a. Let the air out of the tires
 - b. Disconnect the spark plug wire
 - c. Remove the steering wheel

Lesson 5

Objectives

1. Identify steps to avoid being run over.
2. Become aware of hitching and unhitching procedures.
3. List precautions to avoid hitting obstacles.
4. Recognize how to prevent objects from being thrown during equipment operation.
5. Evaluate how to safely operate equipment in and around traffic.
6. Become aware of electrical hazards.

Other Common Dangers

Runovers

You can be injured or killed if you are run over by mowing equipment. Protect yourself by following these steps to avoid runovers.

- ▶ Always start riding equipment from the operator's seat. Do not start riding equipment while standing beside it.
- ▶ Never carry extra passengers, including children, on a riding mower.
- ▶ Never leave running equipment unattended. Always follow proper shut-down procedures.
- ▶ Watch for traffic and pedestrians when crossing or working near roads, driveways, parking lots, building corners, shrubs, trees and other blind spots. People, animals and traffic move quickly and may not realize they are in the path of danger. Be aware of your surroundings at all times.

Hitching, Unhitching Attachments

Use the following steps to avoid serious injury or death when hitching and unhitching attachments to an agricultural tractor.

- ▶ Hitch towed loads to the drawbar only.
- ▶ Never raise, lower or otherwise alter the drawbar. Hitching higher than the drawbar can cause a rear rollover.
- ▶ Refer to the operator's manual for instructions on hitching attachments with hydraulics, a 3-point hitch or PTO shaft.
- ▶ Ensure all safety guards are in place and undamaged.
- ▶ Unhitch attachments on level ground only.
- ▶ Keep others out of the area between the tractor and the attachment or implement.

Obstacles

You can be seriously injured or killed if you run into obstacles while mowing. Follow these precautions to avoid obstacles.

- ▶ Always be looking ahead for obstacles.
- ▶ Watch for trees, buildings, overhangs and other obstructions.
- ▶ Allow enough room to safely pass between obstructions. Be careful not to get too close.
- ▶ Check overhead clearance before passing beneath branches, awnings and other obstructions.

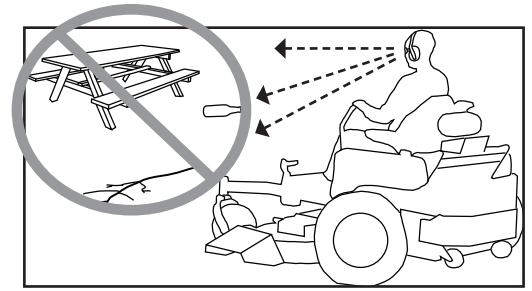

Always be looking ahead for obstacles!

Accident Report

Operator Crushed When Wedged Between Tractor and Tree Trunk

Summary of OSHA Accident Inspection 106490485

An employee was backing a tractor mower between some trees. Unable to stop in time, the tractor became wedged under a partially fallen tree trunk. The employee was crushed against the tractor's steering wheel and killed.



Watch for obstacles when backing up.

Accident Report

Operator Killed When Run Over by Brush Hog

Summary of OSHA Accident Inspection 112399985

An employee was operating a tractor with an attached brush hog at a speed of 6-8 mph. When he tried to pass between two trees, the right rear tire of the tractor struck one of the trees. The impact threw the employee off the tractor. He was run over by the brush hog and killed.



Allow plenty of room when passing between obstacles.

Accident Report

Operator Severs Fingers When Mower Slides on Wet Grass

Summary of OSHA Accident Inspection 112046834

An employee was operating a riding mower on grass that was wet from rain the previous day. He was mowing near a tree on a slight incline, with his right hand resting on the gas tank. As he got closer to the tree, the mower slid and hit the tree in the same spot where he was touching the gas tank. Three of his fingers were severed. One was unable to be reattached.



Never mow on wet grass and always keep hands on the steering wheel of an agricultural tractor or riding mower.

When Hauling on a Trailer

Check the operator's manual for instructions before hauling the mowing equipment on a trailer. Be sure to observe these precautions:

- ▶ Keep bystanders at a safe distance.
- ▶ Select a level surface.
- ▶ Block the rear wheels of the transport vehicle.
- ▶ Attach appropriate ramps to the transport vehicle.
- ▶ Back the mower up the ramp. Drive forward down the ramp.
- ▶ Chain and block the mowing equipment so it won't move during transport.

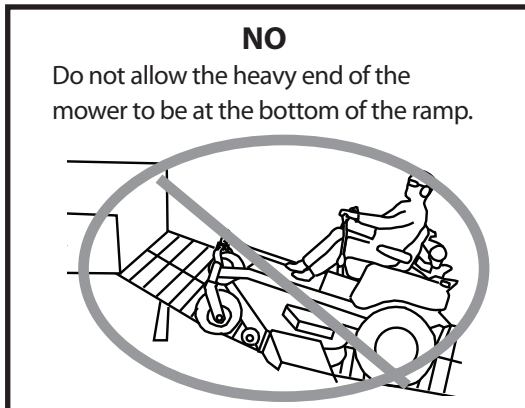
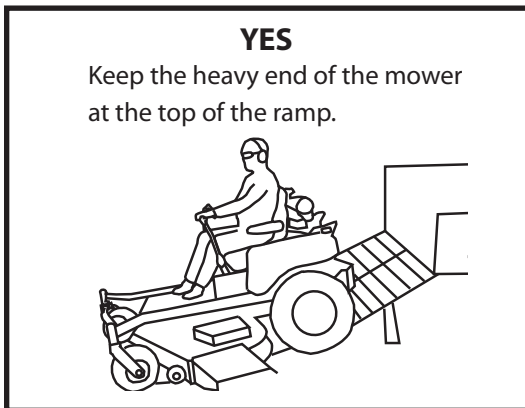

Accident Report

Employee Injured When Mower Overturned on Tailgate

Summary of OSHA Accident Inspection 125956334
An employee was driving a riding mower up a ramp to store it in a trailer. The hinge on the tailgate broke and the mower overturned. The employee was hospitalized with back injuries.



Ensure that any ramp used is securely attached to the loading vehicle.

Thrown Objects

Objects thrown from mowing equipment can cause severe injury. Follow these steps to protect yourself and others.

1. Clear the work area before you begin. Pick up sticks, bottles, rocks, wires and other debris before you begin.
2. Keep children and bystanders away from the area.
3. Wear long pants to protect your legs from debris.
4. Safety glasses should be worn at all times unless you are inside an enclosed cab.
5. Safety glasses and a face shield should be worn when operating string and brush trimmers.
6. Shut off equipment when crossing a sidewalk, driveway or road.

Traffic

Mowers are not made for street or highway travel. To be safe, load mowers and other equipment onto a trailer and pull them to the job site. When the mower must be moved short distances on a public roadway, keep the following safety tips in mind.

- ▶ Observe all traffic signals, signs and rules.
- ▶ Mount a Slow Moving Vehicle (SMV) emblem on the back to indicate the mower is moving at a speed less than 25 mph.
- ▶ Use caution at intersections. Allow fast moving vehicles to go first. Make sure you have enough time to get through safely, without interrupting traffic flow.
- ▶ Use a flagger and highly visible warning cones to alert oncoming traffic when working near a public roadway. Place flaggers and cones far enough ahead of the work site so drivers have time to slow down.
- ▶ The equipment operator and the flagger should wear highly visible, reflective clothing.
- ▶ Do not stand in the road to trim grass or brush. Stand away from the road and watch for traffic.
- ▶ Do not park the mower on a public roadway. It creates a hazard for you and motorists. Park away from the road on a level surface if the mower must be left at a job site.

Electrical Safety

Follow these precautions to keep you from being electrocuted while working with electric tools.

- ▶ Never cut off the ground pin (bottom prong) of a three-prong plug to fit in a two-prong outlet.
- ▶ Do not use electric equipment when grass is damp or wet.
- ▶ Keep ladders away from power lines.
- ▶ Use tools that are double insulated.
- ▶ Do not carry any tool by its cord.
- ▶ Ensure extension cords are in good condition and always use a cord labeled for outdoor use.
- ▶ Do not run over extension cords with equipment.
- ▶ Make sure electric tools are unplugged before working on, unclogging, or adjusting the equipment.
- ▶ Unplug all equipment immediately after use.
- ▶ When unplugging a tool or piece of equipment, do not yank the cord.
- ▶ Battery powered tools are much safer than electrical tools.

Using Ground-Fault Circuit Interrupters (GFCIs)

A GFCI is an electrical outlet that protects you from being electrocuted if an electrical tool or appliance malfunctions. The GFCI has a sensor and a microchip that can tell if electricity is going to the wrong place, such as through your body. When the GFCI senses a problem, it shuts off the electricity in about one-fortieth of a second, which is fast enough to save your life.

If a GFCI outlet is not available, a portable GFCI extension cord can be used.

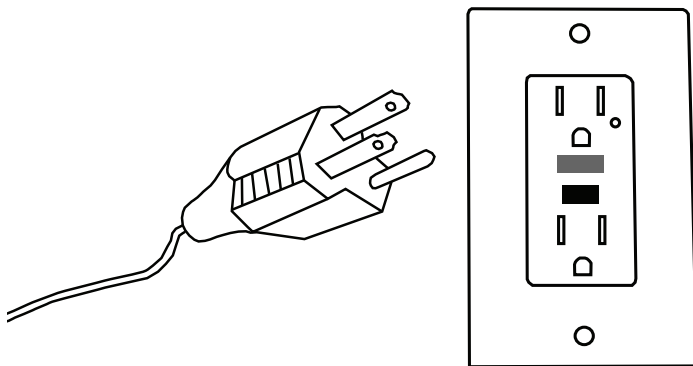

Quiz Yourself

Circle the correct answer.

Answers can be found on page 40.

1. Riding equipment should always be started from _____.
 - a. Beside the mower
 - b. The operator's seat
 - c. Wherever's easiest

2. When mowing, always be looking _____.
 - a. At the sky
 - b. Ahead for obstacles
 - c. At my feet

3. To move a mower to a site 3 miles away, it is better to _____.
 - a. Drive the mower there
 - b. Load it on a trailer and haul it there
 - c. Buy a new mower at the other site

4. When loading a mower onto a trailer, _____ the rear wheels of the transport vehicle.
 - a. Take off
 - b. Spin
 - c. Block

5. Do not use electric tools when the grass is _____.
 - a. Freshly cut
 - b. Fertilized
 - c. Damp or wet

Environmental Hazards

Treating Cuts and Burns

Minor cuts and burns can be treated on-site with minimal complications. If you or a coworker sustains major cuts or burns, get professional medical help immediately.

Treating Minor Cuts

- ▶ Clean the area thoroughly.
- ▶ Remove any debris from the wound.
- ▶ Apply pressure to the wound using gauze or a clean, absorbent cloth until the bleeding stops.
- ▶ Apply an antibiotic ointment and cover with a bandage or clean gauze.
- ▶ Allow the wound to heal and keep dirt from creating infection by changing the bandage or gauze frequently.
- ▶ Get medical help immediately if the cut is severe or if bleeding does not stop in response to direct pressure.

Treating Minor Burns

- ▶ Cool the burn by placing it under cool running water or in a container of cool water for at least 15 minutes. If the skin is broken, do not place under water, instead, seek medical attention immediately.
- ▶ Cover the area with gauze or a clean cloth.
- ▶ Allow the burn to heal and keep dirt from creating infection by changing the gauze frequently.
- ▶ If blisters occur, do not break them. Cover with gauze and allow to break on their own.
- ▶ Get medical help if the burn is serious or if burns cover large areas of the body or occur on the face or genitals.

First Aid Kit Contents

The following is a list of minimum requirements for workplace first aid kits as outlined by ANSI Standard Z308.1-2003*.

- ▶ absorbent compress
- ▶ adhesive bandages
- ▶ adhesive tape
- ▶ individual-use antiseptic applications
- ▶ individual-use burn treatment applications
- ▶ latex-free medical exam gloves
- ▶ sterile pads
- ▶ triangular bandage

*ANSI Z308.1-2003 is published by the International Safety Equipment Association, Arlington, VA, www.safetyequipment.org. Used with permission.

Lesson 6

Objectives

1. Identify environmental hazards.
2. Recognize treatment and first aid for exposure to environmental hazards.

Heat Exhaustion Symptoms

Heat exhaustion is a serious illness and needs to be treated immediately before a heat stroke occurs. If you or a coworker experience any of the following symptoms, cool off immediately and drink plenty of water.

- ◆ Dizziness
- ◆ Lightheadedness
- ◆ Headache
- ◆ Feeling weak, fatigued
- ◆ Easily Irritated
- ◆ Clammy and moist skin
- ◆ Pale or flushed skin

Heat Stroke Symptoms

Heat stroke is a medical emergency that can become fatal. If anyone experiences the following symptoms of heat stroke, call 911 immediately.

- ◆ Hot, dry, red skin (not sweaty)
- ◆ Disorientation
- ◆ Confusion
- ◆ Body temperature greater than 105° F
- ◆ Convulsions
- ◆ Unconsciousness

Heat Stress

You can become seriously ill or die if proper precautions are not taken while working in high temperatures and humidity. Heat can reduce physical performance, as well as mental alertness, causing more accidents.

Heat illness starts at heat exhaustion, and if not treated properly, leads to heat stroke. Take action immediately if you notice anyone with the symptoms found in the sidebar at the left of this page.

Avoid Heat Related Illnesses

It is important to drink plenty of fluids and keep cool while working outside.

- ▶ Drink water often throughout the day; don't wait until you're thirsty to get a drink. At least a quart of water per hour is recommended.
- ▶ Stay away from soda, coffee, tea and alcoholic drinks that dehydrate the body.
- ▶ Avoid large meals before working in the heat.
- ▶ Some prescriptions can make you more susceptible to heat illnesses. Check with your doctor or pharmacist to see if any medicine you are taking could affect you while working in the heat.
- ▶ Wear light-weight fabric, such as cotton, to help keep your body cool.
- ▶ Plan to do the heaviest work at the coolest part of the day. This is usually between 6 a.m. and 10 a.m.
- ▶ Take frequent, short breaks in shaded areas to cool down.
- ▶ Do not take salt tablets, unless recommended by your doctor. Most people receive enough salt in their diet to account for the salt that is lost through sweating.

Heat Facts

- ▶ You are more likely to suffer from a heat related illness on humid days.
- ▶ If you are not used to working in the heat, you are more likely to suffer from a heat related illness. It can take your body anywhere from 5 days to 2 weeks to be acclimated to working in the heat. It is recommended that you start out by working half of the normal time and workload on the first day and then build up to a complete day by the end of the week.
- ▶ You are more vulnerable to heat illness if you have suffered in the past.
- ▶ During the course of the day, you can produce as much as 2 or 3 gallons of sweat. Replenish this fluid by drinking liquids so that you do not suffer from a heat related illness.

Accident Report

Dehydrated Employee Dies After Working in Heat

Summary of OSHA Accident Inspection 115237216

An employee was cutting lawns with a gas-powered mower in temperatures from 75° to 85° F. He had been working all day and told his employer that he felt tired. The employee was instructed to go rest in the company truck. When a coworker went to check on him, the employee was having convulsions. He was rushed to the hospital in an ambulance where his temperature was measured at 111° F. At the hospital, the employee had a seizure and died. The cause of death was reported as dehydration and heat stress.



**Remember to keep yourself hydrated
when working outside.**

Sun Exposure

Prolonged exposure to sunlight causes skin cancer, cataracts and other serious illnesses.

- ▶ Choose a sunscreen that is marked broad-spectrum. This will protect you from both UVA and UVB rays. Ensure the Sun Protection Factor (SPF) is at least 15.
- ▶ Wear a hat or sun visor, sunglasses, and lightweight long-sleeve shirts and pants on sunny days to help control body temperature and block the sun.

Heat Illness Treatment Tips

- ◆ If someone feels overheated, move them into a cooler, preferably air conditioned area. Watch the person, and seek medical attention if needed.
- ◆ Fan the person to increase cooling.
- ◆ Have the person drink plenty of fluids.
- ◆ If the person goes into convulsions or shows symptoms of heat stroke, soak his or her clothes with cool water and call for help immediately.

Cold-Induced Injury or Illness Treatment Tips

- ◆ Move the person out of the cold and into an area that is warm and dry.
- ◆ Remove wet and tight clothing and cover the person with a blanket.
- ◆ Never rub the affected area. This will cause further skin and tissue damage.
- ◆ Seek medical attention immediately.

Cold Induced Injuries and Illnesses

Prolonged exposure to freezing temperatures can result in cold-induced injuries and illnesses that can seriously injure or kill you.

Cold temperatures reduce mental alertness and cause fatigue and exhaustion that can lead to accidents.

Frostbite

Frostbite occurs when parts of the body become so cold that the skin and tissue freezes. Frostbite normally occurs on ears, nose, fingers, hands, toes and feet or other parts of the body that are left uncovered in below-freezing temperatures. Frostbitten skin becomes numb and turns a pale white color.

Hypothermia

Hypothermia occurs when a person's body temperature drops to or below 95° F. Common symptoms include bluish-colored skin, uncontrollable shivering and drowsiness or fatigue.

Avoid Cold-Induced Injuries and Illnesses

- ▶ Layer clothing when working in cold temperatures; you can easily take off layers if you are too warm.
- ▶ Wear a hat and gloves.
- ▶ Keep muscles warm and loose by moving as much as possible.
- ▶ Take frequent, short breaks in warm areas.
- ▶ Perform work at the warmest part of the day, typically in the afternoon.
- ▶ Never work alone.

Insect Stings

Insect stings can be treated without medical attention unless the person suffers an allergic reaction.

The first step to treating an insect sting is to remove the stinger. This can be done by using a straight edge to scrape off the stinger or by using tweezers to pull it out. If you use tweezers to remove the stinger, use extreme caution to not puncture the protruding venom sac.

After the stinger has been removed, a cold pack can be used during the first 24 hours to suppress pain and swelling. Following the first 24 hours, heat should be applied if pain or swelling persist.

Those with severe allergies to insect stings should consult a physician about carrying a prescription medical kit. The kit contains medicine and instructions to be used if the person is stung. If the kit is used, the victim still must receive medical attention. Call for help or take them to the nearest hospital.

Snake Bites

If you are bitten by a snake, seek medical attention immediately and try to describe the size and color of the snake to the doctor. This can help the doctor determine whether or not the snake was poisonous.

Never cut, suck or apply cold packs to snake bites.

Mammals

Be aware of animals such as squirrels or bats that may be in trees or bushes and startle you during work. Also, be cautious of animals such as rats, skunks and raccoons that could be rabid.

Poison Ivy, Oak and Sumac

- ▶ Wash the affected area and all clothing and tools that may have touched the plant.
- ▶ Avoid scratching the area if possible, to prevent infection.
- ▶ Hot and cold compresses can be used to suppress itching.
- ▶ Consult a doctor if the rash is on the face, inside the mouth or covers a large portion of the body.

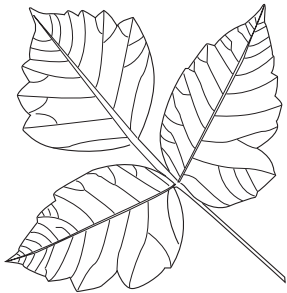

Poison Ivy

Leaves are usually found in clusters of three.

Lightning Facts

- ⚡ A person that is struck by lightning **DOES NOT** retain an electric charge that can shock you.
- ⚡ Lightning can spread as far as 60 feet after striking the ground.
- ⚡ Lightning can travel at speeds of 100,000 mph.
- ⚡ The temperature of a bolt of lightning can be as high as 50,000° F.
- ⚡ Lightning **CAN** strike the same place twice.

Lightning Precautions

Lightning strikes injure and kill hundreds of people each year. Follow these precautions to help keep you safe when the weather turns bad.

- ▶ As soon as you hear thunder, shut off and put away equipment and move indoors. When you are able to hear thunder, you can be struck by lightning. Lightning can strike even when it's not raining.
- ▶ The cab of an enclosed vehicle provides some protection from lightning but a sturdy building provides the best protection.
- ▶ Listen to the radio for weather updates and storm warnings.

If You Can't Take Cover Inside

- ▶ Get to a low space. Lightning strikes the tallest objects.
- ▶ Crouch down on the balls of your feet. Place your hands on your knees and lower your head between your knees.
- ▶ Minimize contact with the ground.
- ▶ Do not lie flat on the ground. This will make you a larger target.

Keep Away From ...

- ▶ Large, lone trees and towers, fences, telephone poles and power lines.
- ▶ Rivers, lakes, pools and other bodies of water.
- ▶ Metal objects, tools, equipment, wire fences and umbrellas.

If Someone is Struck by Lightning

- ▶ Call 911.
- ▶ Check to see if they're breathing. Rescue breathing or CPR may be required.
- ▶ Check for burns on their body.
- ▶ Move the victim inside, out of the storm.
- ▶ **Note: Most lightning-strike victims survive with immediate treatment and rescue breathing or CPR.**

Accident Report

New Employee Killed When Struck by Lightning

Summary of OSHA Accident Inspection 101558112

A new employee continued mowing when a light rain started. Lightning struck a nearby tree and killed the employee just two hours after he had started his new job.



If you see any signs of lightning or a thunderstorm, stop what you're doing and get inside.

Quiz Yourself

Circle the correct answer.

Answers can be found on page 41.

1. Stop a cut from bleeding by applying _____.
 - a. Ice
 - b. Ointment
 - c. Direct pressure
2. Dizziness, lightheadedness, headache and fatigue are all symptoms of _____.
 - a. Sore thumb
 - b. Lightning strike
 - c. Heat exhaustion
3. It is important to take frequent, short _____ when working outside.
 - a. Phone calls
 - b. Breaks
 - c. Strides
4. To keep hydrated when working outside, drink _____.
 - a. Water frequently throughout the day.
 - b. Only when thirsty.
 - c. Soda at lunchtime.
5. Lightning strikes the _____ objects.
 - a. Tallest
 - b. Widest
 - c. Shortest

Select the correct answer for the following sentences from the list below.

- a. Immediately
 - b. Stinger
 - c. Wash
 - d. Frostbitten
 - e. Lower
6. Never rub a body part that has been _____.
 7. The first step to treating an insect sting is to remove the _____.
 8. If you contact poison ivy, oak or sumac, _____ the affected area as well as all clothing and tools.
 9. Hypothermia occurs when body temperature drops to 95° or _____.
 10. If a person with a known allergy to insects is stung, call for help _____.

Conclusion

Developing safe work habits before, during and after machinery operation, helps you avoid accidents on the job.

You have been presented with checklists, safety tips and exercises designed to help you avoid the most commonly reported causes of mower and trimmer operation injuries and deaths, as well as other important safety precautions to consider. Use this information to keep your work experience safe.

Quiz Yourself

Circle the correct answer.

Answers can be found on pages 42 and 43.

1. The two most commonly reported causes of serious injury and death involving mowing equipment are _____.
 - a. Rollovers and being caught in moving parts
 - b. Carbon monoxide poisoning and lightning strikes
 - c. Cuts and burns

2. A pre-start inspection should be performed _____.
 - a. Once each week
 - b. At the start of each work day
 - c. Whenever the weather is nice

3. When operating a riding mower on a hill, mow _____ slopes.
 - a. Up and down
 - b. Across

4. When operating a walk behind mower on a hill, mow _____ slopes.
 - a. Up and down
 - b. Across

5. To avoid _____, only add blades recommended by the manufacturer.
 - a. Running into obstacles
 - b. Spinning in circles
 - c. Being caught in moving parts

Quiz continued on next page...

6. Always _____ obstacles and debris.
 - a. Trying to ignore
 - b. Look ahead for
 - c. Mowing over

7. Riding mowers are NOT made for _____.
 - a. Mowing grass
 - b. Highway travel

8. Never carry an electric tool by its _____.
 - a. Cord
 - b. Handle

9. Heat related illnesses are very _____ and should not be ignored.
 - a. Beneficial
 - b. Serious
 - c. Exciting

10. If working indoors with running equipment, make sure there is adequate _____ to prevent carbon monoxide exposure.
 - a. Lighting
 - b. Fuel
 - c. Ventilation

Quiz Yourself

Solutions

Lesson 1

Circle the correct answer.

1. What are the two most commonly reported causes serious of injury and death from operating mowers and trimmers?

- a. Rollovers and being caught in moving parts
- b. Heat stroke and lightning strikes
- c. Carbon monoxide poisoning and burns

Select the correct answer for the following sentences from the list below.

- a. Danger
- b. Safety glasses
- c. Alcohol
- d. Caution

2. The triangle shape is the symbol for **d** .

3. **b** should always be worn when operating mowing equipment.

4. Never operate any type of equipment under the influence of **c** or drugs.

5. **a** is the most serious safety message.

Circle the correct answer.

6. When operating mowing equipment, it is important that my clothes are _____.

- a. Expensive
- b. Close-fitting
- c. Ironed

7. To protect my feet when mowing, I should wear _____.

- a. Sandals
- b. Tennis shoes
- c. Sturdy boots

Lesson 2

Circle the correct answer.

1. Loose belts, fluid leaks and accumulated grass and grease can be _____ hazards.

- a. Water
- b. Wind
- c. Fire

2. Check the _____ _____ for the location of shields and guards on your equipment.

- a. Operator's manual
- b. Local newspaper
- c. OSHA Web site

3. Which illustration shows how to correctly mow beside buildings?

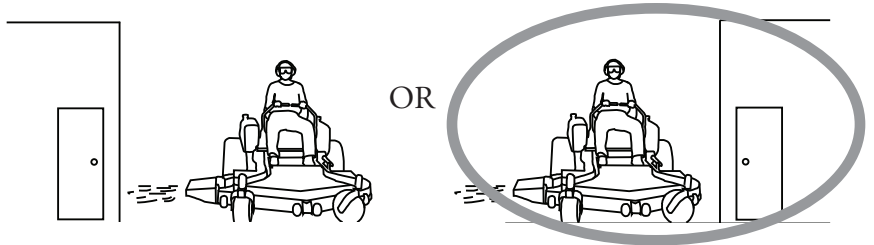

4. In order to follow proper shut-down procedures, always remove the _____ from riding equipment.

- a. Lights
- b. Key
- c. Belts

5. The gas tank should be filled after the engine has cooled for at least _____ minute(s).

- a. 1
- b. 3
- c. 5

Lesson 3

Circle the correct answer.

1. A _____ should be used to cut grass areas where a mower cannot go such as ditches, drop-offs or embankments.
- a. Pair of scissors
 - b. String trimmer
 - c. Tractor with attachments

2. When using an agricultural tractor or riding lawn mower on slopes, which pictures correctly illustrates the direction to mow?

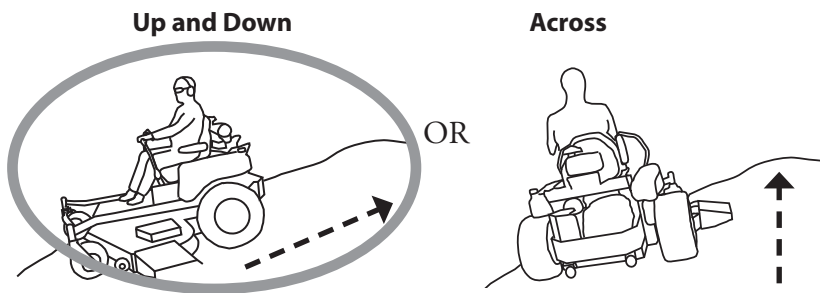

3. When using a walk behind mower on slopes, which picture correctly illustrates which direction to mow?

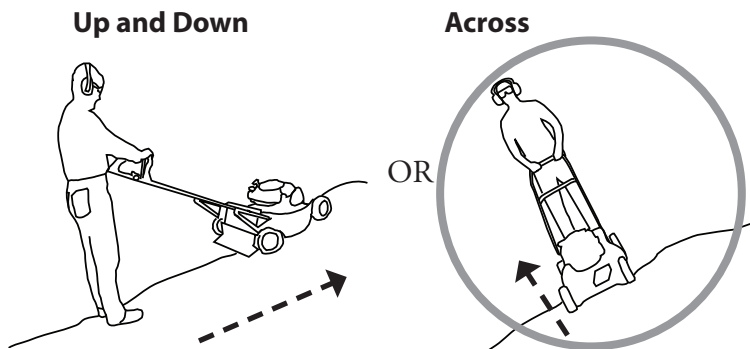

4. When turning, slow down and make wide, _____ turns.
- a. Sharp
 - b. Gradual
 - c. Narrow

5. Keep the _____ end of a riding mower or tractor uphill to help avoid rear rollover.
- a. Light
 - b. Heavy
 - c. Shiny

Lesson 4

Circle the correct answer.

1. When mowing, _____ grass can be a hazard to operators of all types of equipment.
 - a. Cut
 - b. Short
 - c. Wet
2. Only blades recommended by the _____ should be added to mowing equipment.
 - a. Manufacturer
 - b. Custodian
 - c. Operator
3. Before performing maintenance or unclogging debris from the mower's chute, turn off the engine and _____.
 - a. Let the air out of the tires
 - b. Disconnect the spark plug wire
 - c. Remove the steering wheel

Lesson 5

Circle the correct answer.

1. Riding equipment should always be started from _____.
 - a. Beside the mower
 - b. The operator's seat
 - c. Wherever's easiest
2. When mowing, always be looking _____.
 - a. At the sky
 - b. Ahead for obstacles
 - c. At my feet
3. To move a mower to a site 3 miles away, it is better to _____.
 - a. Drive the mower there
 - b. Load it on a trailer and haul it there
 - c. Buy a new mower at the other site
4. When loading a mower onto a trailer, _____ the rear wheels of the transport vehicle.
 - a. Take off
 - b. Spin
 - c. Block
5. Do not use electric tools when the grass is _____.
 - a. Freshly cut
 - b. Fertilized
 - c. Damp or wet

Lesson 6

Circle the correct answer.

1. Stop a cut from bleeding by applying _____.
 - a. Ice
 - b. Ointment
 - c. Direct pressure
2. Dizziness, lightheadedness, headache and fatigue are all symptoms of _____.
 - a. Lightning strike
 - b. Heat exhaustion
3. It is important to take frequent, short _____ when working outside.
 - a. Phone calls
 - b. Breaks
 - c. Strides
4. To keep hydrated when working outside, drink _____.
 - a. Water frequently throughout the day.
 - b. Only when thirsty.
 - c. Soda at lunchtime.
5. Lightning strikes the _____ objects.
 - a. Tallest
 - b. Widest
 - c. Shortest

Select the correct answer for the following sentences from the list below.

- | | |
|----------------|----------------|
| a. Immediately | d. Frostbitten |
| b. Stinger | e. Lower |
| c. Wash | |

6. Never rub a body part that has been **d**.
7. The first step to treating an insect sting is to remove the **b**.
8. If you contact poison ivy, oak or sumac, **c** the affected area as well as all clothing and tools.
9. Hypothermia occurs when body temperature drops to 95° or **e**.
10. If a person with a known allergy to insects is stung, call for help **a**.

Conclusion

Circle the correct answer.

1. The two most commonly reported causes of serious injury and death involving mowing equipment are _____.
 a. Rollovers and being caught in moving parts
b. Carbon monoxide poisoning and lightning strikes
c. Cuts and burns
2. A pre-start inspection should be performed _____.
a. Once each week
 b. At the start of each work day
c. Whenever the weather is nice
3. When operating a riding mower on a hill, I mow _____ slopes.
 a. Up and down
b. Across
4. When operating a walk behind mower on a hill, I mow _____ slopes.
a. Up and down
 b. Across
5. To avoid _____, only add blades recommended by the manufacturer.
a. Running into obstacles
b. Spinning in circles
 c. Being caught in moving parts

Quiz continued on next page...

6. Always _____ obstacles and debris.
- a. Trying to ignore
 - b. Look ahead for
 - c. Mowing over
7. Riding mowers are NOT made for _____.
- a. Mowing grass
 - b. Highway travel
8. Never carry an electric tool by its _____.
- a. Cord
 - b. Handle
9. Heat related illnesses are very _____ and should not be ignored.
- a. Beneficial
 - b. Serious
 - c. Exciting
10. If working indoors with running equipment, make sure there is adequate _____ to prevent carbon monoxide exposure.
- a. Lighting
 - b. Fuel
 - c. Ventilation

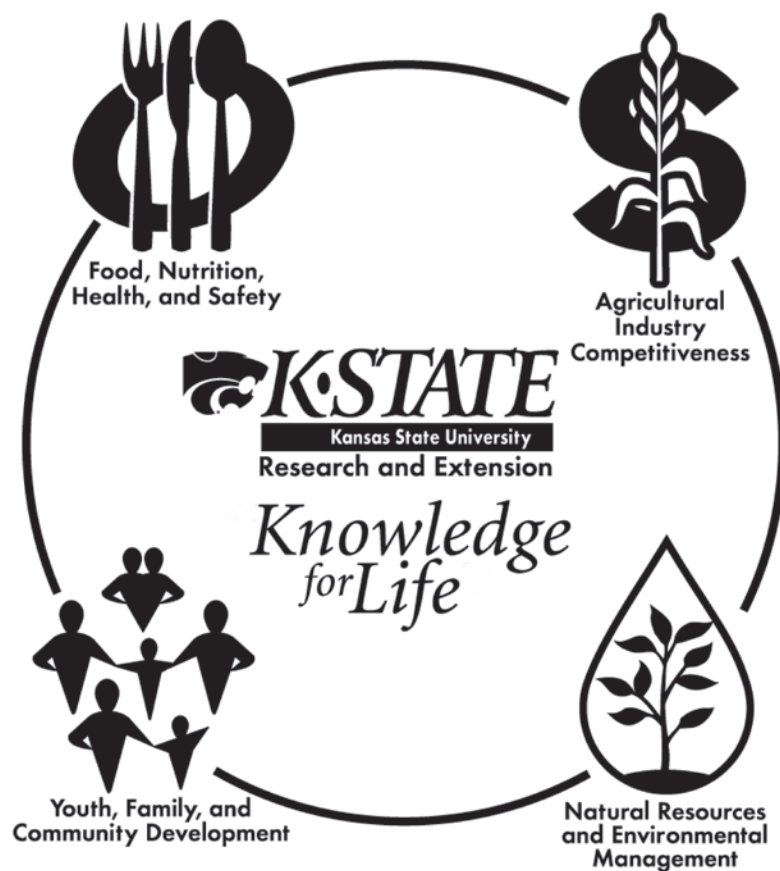

This publication is produced by K-State Research and Extension, Manhattan, Kansas, www.ksre.ksu.edu

Brand names appearing in this publication are for product identification purposes only. No endorsement is intended, nor is criticism implied of similar products not mentioned. Publications are reviewed or revised annually by appropriate faculty to reflect current research and practice. Date shown is that of publication or last revision.

**Kansas State University Agricultural Experiment Station
and Cooperative Extension Service**

MF 2714 rev.

October 2009

K-State Research and Extension is an equal opportunity provider and employer. Issued in furtherance of Cooperative Extension Work, Acts of May 8 and June 30, 1914, as amended. Kansas State University, County Extension Councils, Extension Districts, and United States Department of Agriculture Cooperating, Fred A. Cholick, Director.