

MPH150

USER MANUAL



Instruction

Thanks for purchasing and using vision tester.

Before using our instrument, please read this manual carefully. We sincerely hope that it will provide you with enough information.

Providing products with more refined quality, complete function and characteristics to customers is our target. We regret any inconvenience caused by not notifying you the differences of products from those advertised on promotional and packaging materials resulted by product performance enhancement. Meanwhile we reserve the right of constantly updating products and materials.

If there is any problem during use, please contact authorized distributor.

Your satisfaction is the cornerstone of our progress!

Index

| | |
|---|----|
| 1. Introduction | 4 |
| 1.2 Characteristics | 4 |
| 1.3 Working Environment | 4 |
| 1.4 Main technical indexes | 5 |
| 1.5 Name plate and indications | 6 |
| 1.6 Safety Notice | 7 |
| 2. Configuration | 8 |
| 2.1 Parts | 8 |
| 3. Assembly | 11 |
| 3.1 Attaching Instrument to Ophthalmic Stand | 11 |
| 3.2 Attaching Near Point Rod, Near Point Card and Card Holder | 11 |
| 3.3 Attaching face shield | 12 |
| 4. Operation Procedures | 12 |
| 4.1 Spherical Lens | 12 |
| 4.2 Cylinder Lens | 13 |
| 4.3 Auxiliary Lens | 14 |
| 4.4 Cross Cylindrical Lens | 15 |
| 4.5 Rotary Prism | 16 |
| 4.6 Corneal Aligning Device | 17 |
| 4.7 Near Point Card | 21 |
| 4.8 Examination Procedures | 22 |
| 5. Maintenance | 33 |
| 5.1 Daily Care | 33 |
| 5.2 Checking and Servicing Procedure | 33 |
| 6. Before Requesting Service-Troubleshooting Guide | 33 |
| 7. Transportation and Storage | 34 |
| 7.1 Transportation | 34 |
| 7.2 Storage | 34 |
| 8. Optional Accessories - Cylinder Lens | 34 |

1. Introduction

1.1 Uses

This instrument is applicable with stand and projection for precision measurement of visual functions such as myopia, hyperopia, astigmatism, visual acuity balance, phoria, stereoscopic vision and visual acuity amalgamation.

1.2 Characteristics

- Unique design of butterfly-shape appearance.
- Capable of checking up all-sided visual functions, accurate and comfortable in measurement.
- Exquisite manufacturing technique, with comfortable feel.
- High quality plated-film used in all optic lenses.
- Technology and design patents

1.3 Working Environment

- The instrument should be installed and worked under such environment:
- Temperature: 20°C to 30°C
- Humidity: 35% to 75% (No condensation)
- Environmental pressure: 70kPa to 106kPa
- lean indoor place
- direct strong light
- No vibration and collision

1.4 Main technical indexes

- 1.4.1 Spherical Lens Range of measurement: $-19.00D \sim +16.75D$
Step length: 0.25D (being 0.12D when 0.12D auxiliary lens is used)
- 1.4.2 Cylindrical Lens Range of measurement: $0 \sim -6.00D$ (being $0 \sim -8.00D$ when additional lens is used)
Step: 0.25D (being 0.12D when additional lens is used)
- 1.4.3 Axis of Cylindrical Lens: Range of measurement: $0 \sim 180^\circ$
Step: 5°
- 1.4.4 Cross Cylindrical Lens: $\pm 0.25D$
- 1.4.5 Rotary Prism: Range of measurement: $0 \sim 20\Delta$
Step: 1Δ
- 1.4.6 Prism basal angle: Range of measurement: $0 \sim 180^\circ$
Step: 5°
- 1.4.7 Pupil Distance: Range : 50mm \sim 70mm
Step: 1mm
- 1.4.8 Aggregated Adjustment: ∞ , 380mm (when PD=64 mm)
- 1.4.9 Adjustment of Forehead Rest: 16 mm
- 1.4.10 vertex distance: 13.75 mm
- 1.4.11 Overall Dimensions: 35mm(Length) \times 320mm(Width) \times 90mm(Height)
- 1.4.12 Weight: 4.5kg

1.5 Name plate and indications

Name plate and indications are stucked on the instrument to arise end-users' notice.

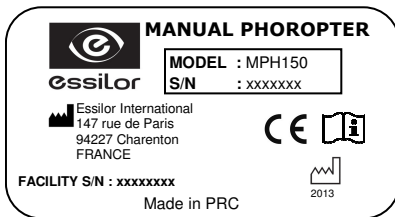

| | |
|-----|--|
| | Notice, Operation Manual must be referred SN: before operation |
| | Manufacturing date |
| | Manufacturer |
| | Comply to European regulations concerned |
| | Authorized European representative |
| SN. | Product serial number |

In case the name plate is not stucked well or the characters become unclear to recognize, please contact authorized distributors.

1.6 Safety Notice

- When taking the vision tester, one should hold mounting handle (Fig.1) at upper part of the instrument or carry left and right ends of the instrument by both hands (Fig.2).

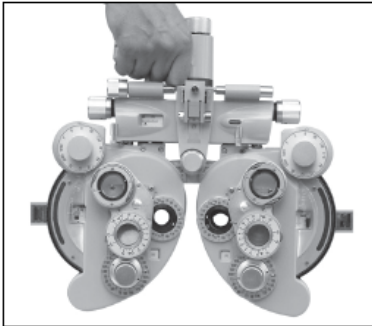

Fig.1

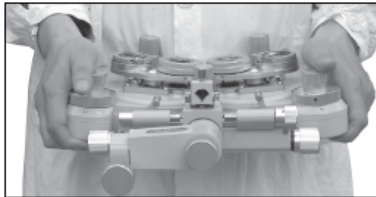
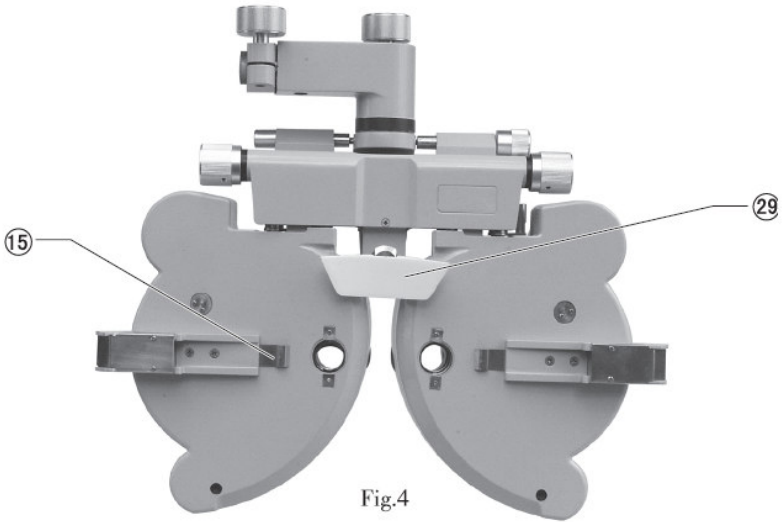
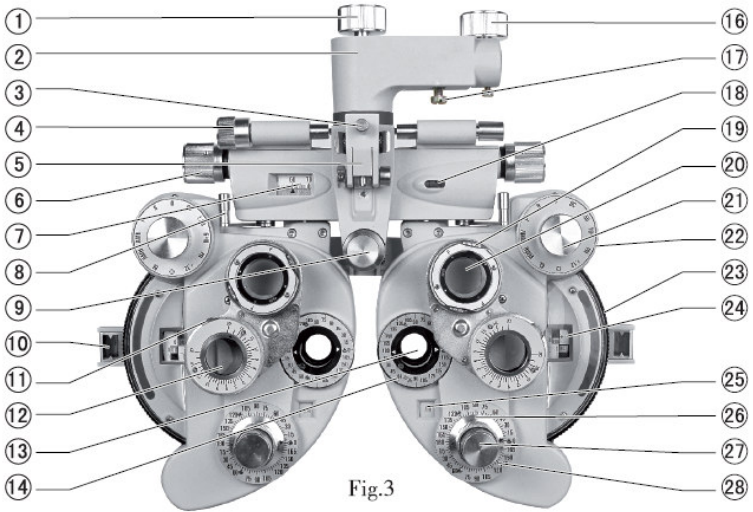

Fig.2

- Do not set the instrument with face down or exert pressure onto surface of lens, and do not touch lens by hand.
- The instrument shall not be put in a damp and dusty room.
- All moving parts can be turned in dual-direction. However, care must be taken to do it, and do not turn it beyond the limit position so as to avoid damage to the device.
- The plastic part (Forehead Rest and spirit level , etc.) that can be scrubbed shall be swabbed down using cotton cloth, and do not use cleaning liquid or other chemicals.
- Vision tester belongs to precision instrument, so do not dismantle it at random.

2.Configuration

2.1 Parts



1. Rotation Adjustment Knob: used to adjust direction of instrument's main body
2. Mounting Handle : used to install the instrument onto eye-optometry table
3. Clamping Screw : used to fix near-point rod
4. Leveling Adjusting Knob: used to adjust level position of the instrument
5. Near Point Rod Holder: used to attach near-point testing mark rod to hanger frame
6. Pupil Distance Knob : used to adjust pupil distance
7. Pupil Distance Scale: used to display pupil distance
8. Vergence : used to adjust corner of device's left and right disks
9. Forehead Rest Knob : used to adjust patient's forehead position
10. Corneal Aligning Aperture : used to display position of patient's cornea vertex
11. Prism Rotation Knob : used to adjust prism power
12. Rotary Prism : used to test phoria or binocular balance
13. Examination Aperture for test, with various lenses set here.
14. Cylindrical Lens Axis Scale : used to indicate cylindrical lens axis angle
15. Face shield chip : fix face shield
16. Fixing Hand-wheel : used to fix instrument to ophthalmic stand
17. Tightening Screw : used to fix instrument to ophthalmic stand, and stored in accessory box
18. Spirit Level : used to indicate level direction
19. Rotation Knob : used to adjust astigmatic axis of cross cylindrical lens
20. Cross Cylindrical Lens : used to precisely check astigmatic power and axis
21. Auxiliary Lens Knob : used for various visual acuity tests
22. Strong Spherical Power Knob : used to adjust big spherical lens power, step:3.00D
23. Weak Spherical Power Dial : used to adjust small spherical lens power, step:0.25D
24. Spherical Power Scale : used to display spherical lens power
25. Cylindrical Power Scale : used to display cylindrical lens power

26. Cylindrical Lens Axis Knob : used to adjust cylindrical lens axis
27. Cylindrical Lens Knob : used to set cylindrical lens to examination aperture
28. Cylindrical Lens Axis Scale : used to display angle of cylindrical lens axis
29. Forehead Rest : Patient's forehead rests here.
30. Instruction Manual
31. Near Point Rod : Card holder is attached to position of near point measuring on this rod.
32. Near Point Card : Including near point sight mark
33. Card Holder : used to attach near point card
34. Dust Cover : Use dust cover to cover instrument when it is not in use to protect it from dust.
35. Accessories Box : used to store the standard accessories
36. Face shield :Left and right face shield's, one each, are installed on position where instrument and patient's nose contact.
37. Balloon with Brush : used to clean lens
38. Additional Lens : used to change testing range and precision



Fig.5

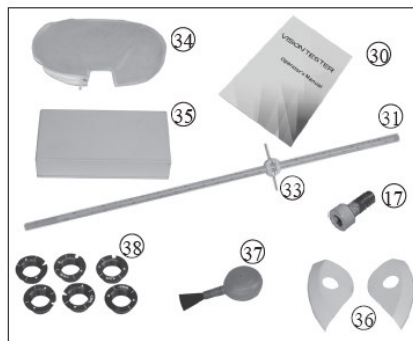

Fig.6

3.Assembly

3.1 Attaching Instrument to Ophthalmic Stand

a/ When assembly is conducted, first insert the mounting rod extending from the ophthalmic stand to hole of mounting handle 2, and fix it with fixing hand-wheel 16. Then tighten tightening screw 17 under mounting handle 2. Tightening screw 17 is stored in standard accessories box 35.

b/Turn leveling adjusting knob 4 until air bubble is located at middle position of spirit-level bubble 18. Loosen rotation adjustment knob 1 to turn the instrument to the required direction.

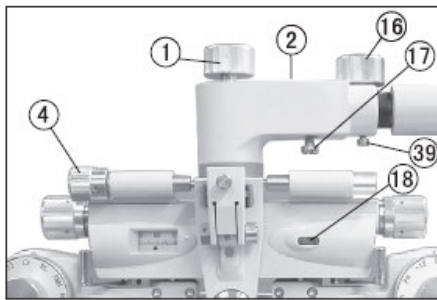

Fig.7

*Notice

Fastening screw 39 (placed in accessories box) can be used to better fasten vision tester when it is not matching with the vision tester holding arm.

3.2 Attaching Near Point Rod, Near Point Card and Card Holder

First insert card holder 33 into near point rod 31, and slide it to a proper position. Then attach near point card 32 to an open aperture of card holder 33 (Fig.8). Afterwards, attach near point rod 31 onto near point rod holder 5, and fix clamping screw 3. When near point rod 31 is not used, raise it upwards (Fig.9).

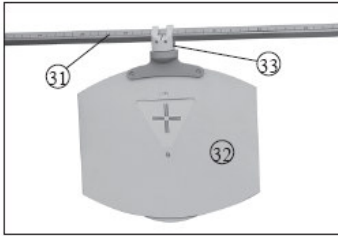

Fig.8

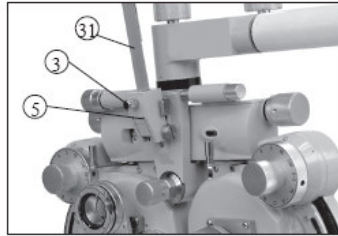

Fig.9

3.3 Attaching face shield

Attach face shield 36 so that face shield clip 15 catches it. Then align face shield aperture with examination aperture 13 (Fig.10).

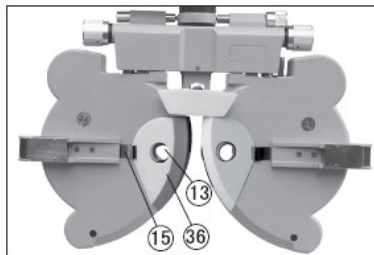

Fig.10

4 Operation Procedures

4.1 Spherical Lens

To show the spherical power only (shortened as "S"), turn auxiliary lens knob 21 to O position, then turn cylindrical lens knob 27 until "00" is shown on cylindrical power scale 25 . Then turn weak spherical power dial 23, value S is displayed in spherical power scale 24, within range from -19.00D~+16.75D, increasing or decreasing progressively in 0.25D (Fig.11).

To obtain required diopter setting quickly, use strong spherical power knob 22, then value S increases or decreases progressively in 3.00D diopter steps (Fig.12).

Note: Although several figures will appear on the scale, only three or four digit numbers have meaning. For example, if '075' is shown, it should be read as '0.75D', and if '1150' is shown, it should be read as '11.50D'.

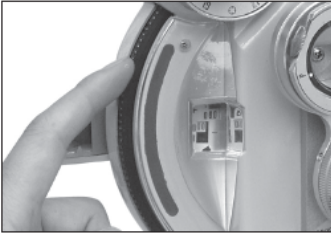

Fig.11

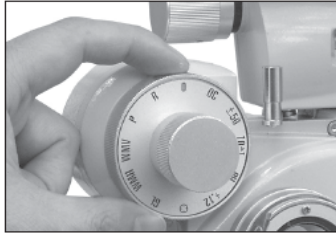

Fig.12

4.2Cylinder Lens

By turning cylindrical lens knob 27, the cylindrical power is shown on cylindrical power scale 25, with range from 0.00D to 6.00D, and increases or decreases progressively in 0.25D steps (Fig.13). By turning cylinder lens axis knob 26, the axis angle of cylinder lens is shown on cylinder lens axis scale 28, with range of 0~180°; step: 5° (Fig.14)

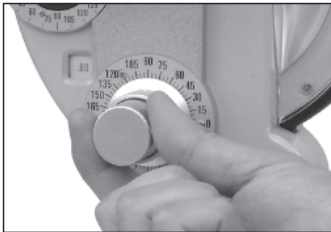

Fig.13

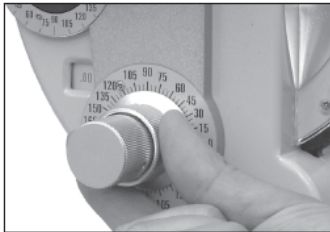

Fig.14

4.3 Auxiliary Lens

Turn auxiliary lens knob 21, the required symbol is to be set at 12 o'clock position. Then Corresponding referenced lens will appear in the examination aperture 13 (Fig.15 and Fig.16).

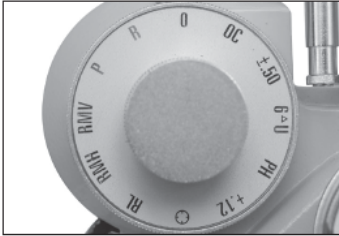

Fig.15



Fig.16

The meaning of each mark.

- O Open aperture
- OC Shelter from aperture
- ±.50 Cross cylinder lens, with horizontal plus +axis. Used for presbyopia test
- 6ΔU 6 diopter base up prism, used for horizontal phoria test
- PH A 1mm diameter pinhole is provided, used to determine reason of poor vision (due to refractive abnormality or their reasons)
- +.12 +0.12D spherical lens, and spherical power can be set by 0.12D
- ⊕ Cross piece
- ⊕ Red color-filter lens
- RMH Red Maddox rod lens, set horizontally
- RMV Red Maddox rod lens, set vertically
- P Polaroid filter, used for polarizing testing of stereoscopic vision
- Andbinocular balance of stereoscopic vision
- R Retinoscopic lens; +1.50D spherical lens (67cm)
- 10ΔI 10 diopter base in prism, used for vertical phoria test
- GL Green color-filter lens
- WMH White Maddox rod lens, set horizontally
- WMV White Maddox rod lens, set vertically



Fig.17

To change direction of cross cylinder lens and polaroid filter, first remove the retaining ring and rear cover glass using screwdriver. Rotate the auxiliary lens knob 21 until auxiliary lens is properly indexed and in alignment with examination aperture 13 . By slightly turning the auxiliary lens knob 21 in both directions, a screw and washer can be seen above and below the lens. Removing these two screws, auxiliary lens can be then removed. By reversing above procedure, reposition of lens is possible to ensure it is placed in a proper position (Fig.17).

4.4 Cross Cylindrical Lens

It is used for precise determination of cylinder power and axis. Turn cross cylindrical lens to the front of examination aperture. The letter“P” at its front sustenance face stands for the power, and hand-wheel direction stands for axis. When red dot aligns with “P” it indicates minus $-0.25D$ cylindrical lens. When white dot aligns with “P” it indicates plus $+0.25D$ cylindrical lens.

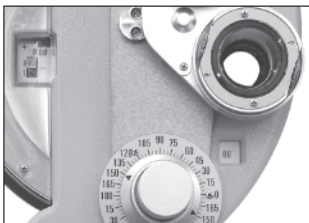

Fig.18



Fig.19

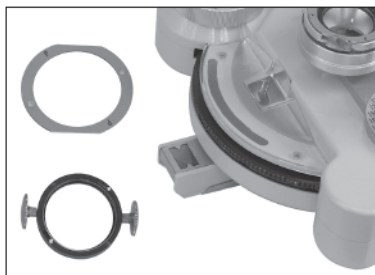

Fig.20

4.5 Rotary Prism

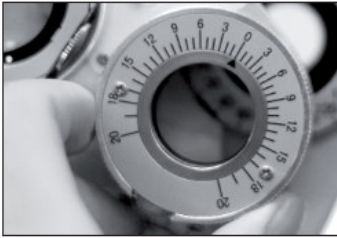

Fig.21

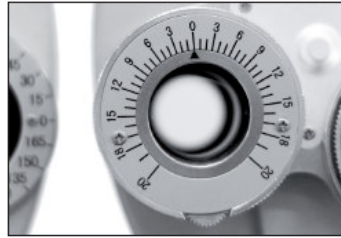

Fig.22

Turn rotary prism 12 by holding its base to set it on the examination aperture. Turn prism rotation knob 11 until the required prism power is set. What the black triangle arrow indicates is the current prism power. For example, prism power indicated in Fig.22 is 0, that in Fig.23 means base in 3 Δ prism power, and that in Fig.24 means base up 3 Δ prism power.

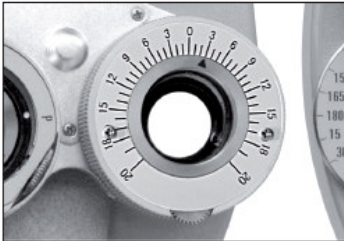

Fig.23

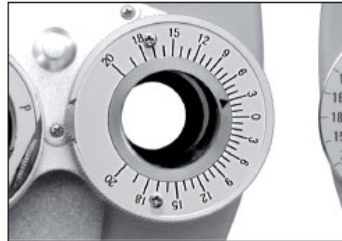

Fig.24

4.6 Corneal Aligning Device

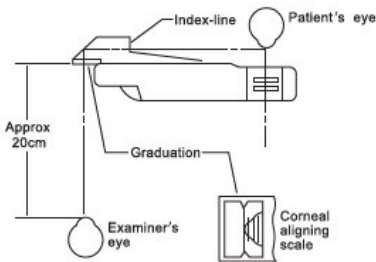

Fig.25

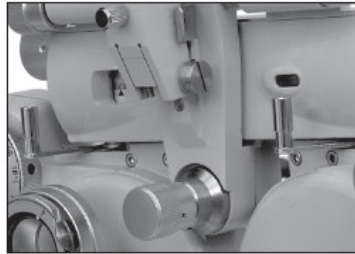

Fig.26

Turn forehead rest knob i to adjust position of forehead rest 9. After setting patient's forehead closely on forehead rest 29, look through the corneal aligning aperture 10 from around 20cm away. Look at the apex of the patient's cornea (Fig.25) after the examination aperture's pointer acme of corneal aligning aperture 10 aligns with the longer line on the scale. The longer line in the aperture means the measuring distance is 13.75mm, which is the standard spectacle wearing distance. Three shorter lines are provided by 2mm equal distance away from the longer line. If apex of the cornea of testee is positioned on second shorter line from the longer line, the lens power should be the value measured when spectacle is placed at 17.75mm away from apex of the cornea (standard value 13.75mm + correction value of second shorter line 4mm =17.75mm). If the actual spectacle wearing distance is different from the standard value (13.75mm), correction should be made according to Table 1 and Table 2.

Example 1 Assume that data of S +8.00D is obtained when the apex of the cornea positioned at the second shortest line from the longest line, meaning that it is 4mm away from the standard wearing distance. When referring to the correction factor in Table 1, it is known that the applied correction factor is +0.26D for +8.00D diopter and 4mm distance. Therefore, the actual diopter of a patient who wears 13.75 distance standard spectacle is $(+8.00D) + (+0.26D)=8.26D$. The correction value changes by 0.25 D or 0.12D.

Example 2 Assume that the apex of cornea is between the second and third shortest lines from the longest line (5mm from the standard line), the obtained data is S-11.50D. It is known when referring the correction factor in Table 2 that for -11.50D and 5mm distance, the correction value should be $(0.57+0.68)/2= 0.62$ D. Thus the actual diopter of a patient who wears 13.75 distance standard spectacle is $(-11.50) + (+0.62)= -10.88$ D.

Example 3 When the cornea apex is on the third shortest line from the longest one, the obtained value is -14.00D: It is known when referring to correction factor in table 2 that for -14.00D and 6mm distance, the correction value should be 1.08D. So the actual diopter of a patient who wears 13.75 distance standard spectacle is $(-14.00)+(1.08)= -12.92$ D.

If more accurate measurement is required, please calculate it according to following formula.

$$D'=D\pm\frac{LD^2}{1000-LD}$$

D: Measured power

D': Corrected power

L: Difference between measured distance and wearing distance(mm)

Correction Table 1 (When Correction Value of Measured Power is in Plus (+) Region)

| D \ L | 1 | 2 | 3 | 4 | 5 | 6 | 7 | 8 | 9 | 10 |
|--------------|----------|----------|----------|----------|----------|----------|----------|----------|----------|-----------|
| +1.00 | .001 | .002 | .003 | .004 | .005 | .006 | .007 | .008 | .009 | .01 |
| +2.00 | .004 | .008 | .01 | .02 | .02 | .02 | .03 | .03 | .04 | .04 |
| +3.00 | .009 | .02 | .03 | .04 | .05 | .06 | .06 | .07 | .08 | .09 |
| +4.00 | .02 | .03 | .05 | .07 | .08 | .10 | .12 | .13 | .15 | .17 |
| +5.00 | .03 | .05 | .08 | .10 | .13 | .15 | .18 | .21 | .24 | .26 |
| +6.00 | .04 | .07 | .11 | .15 | .19 | .22 | .26 | .30 | .34 | .38 |
| +7.00 | .05 | .10 | .15 | .20 | .25 | .31 | .36 | .42 | .47 | .53 |
| +8.00 | .06 | .13 | .20 | .26 | .33 | .40 | .47 | .55 | .62 | .70 |
| +9.00 | .08 | .16 | .25 | .34 | .42 | .51 | .61 | .70 | .79 | .89 |
| +10.00 | .10 | .20 | .31 | .42 | .53 | .64 | .75 | .87 | .99 | 1.11 |
| +11.00 | .12 | .25 | .38 | .51 | .64 | .78 | .92 | 1.06 | 1.21 | 1.36 |
| +12.00 | .15 | .30 | .45 | .61 | .77 | .93 | 1.10 | 1.27 | 1.45 | 1.64 |
| +13.00 | .17 | .35 | .53 | .71 | .90 | 1.10 | 1.30 | 1.51 | 1.72 | 1.94 |
| +14.00 | .20 | .40 | .61 | .83 | 1.05 | 1.28 | 1.52 | 1.77 | 2.02 | 2.28 |
| +15.00 | .23 | .46 | .71 | .96 | 1.22 | 1.48 | 1.76 | 2.05 | 2.34 | 2.65 |
| +16.00 | .26 | .53 | .83 | 1.09 | 1.39 | 1.70 | 2.02 | 2.35 | 2.69 | 3.05 |
| +17.00 | .29 | .60 | .91 | 1.24 | 1.58 | 1.93 | 2.30 | 2.68 | 3.07 | 3.48 |
| +18.00 | .33 | .67 | 1.03 | 1.40 | 1.78 | 2.18 | 2.59 | 3.03 | 3.48 | 3.95 |
| +19.00 | .37 | .75 | 1.15 | 1.56 | 1.99 | 2.44 | 2.91 | 3.41 | 3.92 | 4.46 |
| +20.00 | .41 | .83 | 1.28 | 1.74 | 2.22 | 2.73 | 3.26 | 3.81 | 4.39 | 5.00 |

Correction Table 2 (When Correction Value of Measured Power is in Minus (-) Region)

| D \ L | 1 | 2 | 3 | 4 | 5 | 6 | 7 | 8 | 9 | 10 |
|--------|------|------|------|------|------|------|------|------|------|------|
| -1.00 | .001 | .002 | .003 | .004 | .005 | .006 | .007 | .008 | .009 | .01 |
| -2.00 | .004 | .008 | .01 | .02 | .02 | .02 | .03 | .03 | .04 | .04 |
| -3.00 | .009 | .02 | .03 | .04 | .04 | .05 | .06 | .07 | .08 | .09 |
| -4.00 | .02 | .03 | .05 | .06 | .08 | .09 | .11 | .12 | .14 | .15 |
| -5.00 | .02 | .05 | .07 | .10 | .12 | .15 | .17 | .19 | .22 | .24 |
| -6.00 | .04 | .07 | .11 | .14 | .17 | .21 | .24 | .27 | .31 | .34 |
| -7.00 | .05 | .10 | .14 | .19 | .24 | .28 | .33 | .37 | .41 | .46 |
| -8.00 | .06 | .13 | .19 | .25 | .31 | .37 | .42 | .48 | .54 | .59 |
| -9.00 | .08 | .16 | .24 | .31 | .39 | .46 | .53 | .60 | .67 | .74 |
| -10.00 | .10 | .20 | .29 | .38 | .48 | .57 | .65 | .74 | .83 | .91 |
| -11.00 | .12 | .24 | .35 | .46 | .57 | .68 | .79 | .89 | .99 | 1.09 |
| -12.00 | .14 | .28 | .42 | .55 | .68 | .81 | .93 | 1.05 | 1.17 | 1.29 |
| -13.00 | .17 | .33 | .49 | .64 | .79 | .94 | 1.08 | 1.22 | 1.36 | 1.50 |
| -14.00 | .19 | .38 | .56 | .74 | .92 | 1.08 | 1.25 | 1.41 | 1.57 | 1.72 |
| -15.00 | .22 | .44 | .65 | .85 | 1.05 | 1.24 | 1.43 | 1.61 | 1.78 | 1.96 |
| -16.00 | .25 | .50 | .73 | .96 | 1.19 | 1.40 | 1.61 | 1.82 | 2.01 | 2.21 |
| -17.00 | .28 | .56 | .82 | 1.08 | 1.33 | 1.57 | 1.81 | 2.04 | 2.26 | 2.47 |
| -18.00 | .32 | .63 | .92 | 1.21 | 1.49 | 1.75 | 2.01 | 2.27 | 2.51 | 2.75 |
| -19.00 | .35 | .70 | 1.02 | 1.34 | 1.65 | 1.94 | 2.23 | 2.51 | 2.77 | 3.03 |
| -20.00 | .39 | .77 | 1.13 | 1.48 | 1.82 | 2.14 | 2.46 | 2.76 | 3.05 | 3.33 |

4.7 Near Point Card

If the lens is multifocal, it is required to measure lens diopter at near distance. Then near point rod 31, card holder 33 and near point card 32 can be used. Lower near point rod 31, keeping rod horizontal is the correct setting for measurement (Fig.27)

Near point distance from 15cm to 70cm (i.e. about 6 inches to 28 inches), and lens diopter from +8D to +1.5D are provided. The value indicated at tail of card holder 33 is just the value to the card from apex of the cornea (Fig.28). Select the required sight mark on the near point card. Turn the rotating portion along the card center by the finger until the required value appears in the sight window.

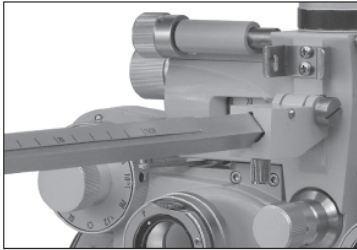

Fig.27

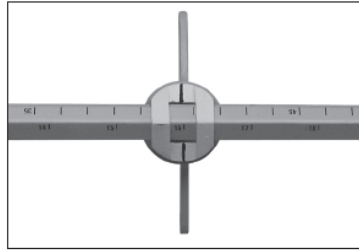

Fig.28

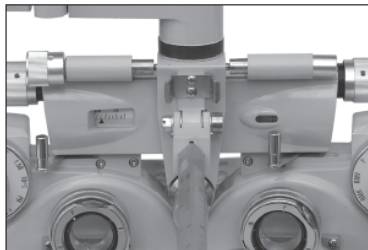

Fig.29

Then turn vergence lever 8 inward to move the instrument so that main axis of lens faces to 380mm. Now near point testing can be carried out (Fig.29).

4.8 Examination Procedures

Following is an example of examination. Before examination, patient's visual acuity should be determined.

Example: Testee, 35 years old, who wears spectacles.

First, use lensmeter to measure the spectacles he is wearing, with following results:

| | |
|----|----------------------|
| PD | 63mm |
| R | -1.00DS/-0.50DC 90° |
| L | -1.25DS/-0.50DC 180° |

Examining results show pupil distance of Testee is 63mm; spherical power of his right eye is -1.00D, with astigmatic power of -0.50D, and axis 90°; spherical power of his left eye is -1.25D, with astigmatic power of -0.50D, and axis 180°.

With these spectacles worn in examination, visual acuity of Testee's left and right eyes is all 0.7(20/30). Then use a comprehensive optometry meter to precisely measure diopter power of Testee's left and right eyes at present.

4.8.1 Installing Instrument

- (1) Attach the near point rod 31 downwards to near point rod holder 5 (Fig.9).
- (2) Set the spherical lens power (value S) and cylinder lens power (value C) to zero.
- (3) Before examination, first set pupil distance. Turn pupil distance knob 6, so that pupil distance of Testee is shown in pupil distance scale 7.
- (4) Move the instrument so that the instrument's side shown in Fig.4 is facing to Testee. Now place forehead of Testee on the forehead rest 29.
- (5) Turn leveling adjusting knob 4 while observing air bubble until the air bubble moves to middle of the water bubble.
- (6) Determine the distance between vertex of cornea and the instrument.
- (7) To measure right eye first, turn auxiliary lens knob to set O for right eye, and OC for left eye.

4.8.2 Examination Using "Fogging Method"

- (1) Add 3.00D to the estimated S value for right eye. Then power of his spectacle is -1.00D, namely, $(-1.00) + (+3.00) = +2.00D$.
- (2) In this condition, Testee is unable to clearly see the projected chart. Gradually add minus power. In example of Testee, reduce S value gradually by turning weak spherical power dial 23 : 2.00→1.75→1.5→0.5 until it shows -1.00 D.

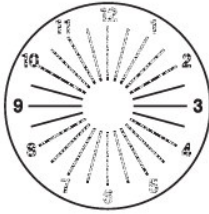

Fig.30

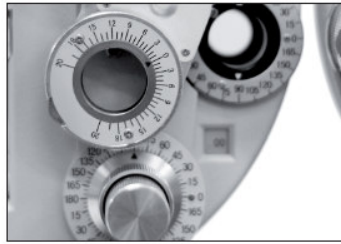

Fig.31

(3) Project the astigmatic chart while asking Testee if he can see it. If Testee says he can see it as shown in Fig.30, turn the cylindrical lens axis knob 26 to 90° from the darkest line he has seen (see Fig.31). If Testee says all lines are equally bright, it means no astigmatism is existent. Then procedures (3) and (4) in 4.8.2 and procedure 4.8.2 are not required.

(4) Turn cylindrical lens knob 27 to change C value, $.00 \rightarrow .25 \rightarrow .50$ so every line is seen equally. When it is turned to -0.50 , the chart is as shown as Fig.32.

(5) Change S by $0.25D$ steps by turning weak spherical power dial 23 so that the visual acuity becomes from 1.2 to 1.5. Record the changed value of the visual acuity.

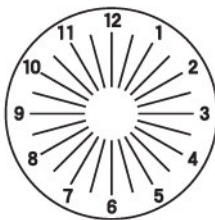

Fig.32

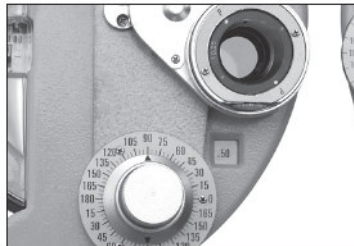

Fig.33

For myopia, spectacles with least power should be selected, and for presbyopia, spectacles with largest power should be selected. To correct Testee's vision to that of 1.5, his spectacle power may be -1.75 , -2.00 or -2.25 , and then -1.75 should be selected. Now examination is almost completed, however, more precise measurement is required.

4.8.3 Precise Refining Cylinder Axis and Power

(1) Set cross cylindrical lens 20 in front of Testee 's right eye and, turning rotation

knob 19 axially, to align it with axial direction of cylindrical lens (see Fig.33).

(2) Project the cross cylinder dot chart as shown in Fig.34. Turn rotation knob 19 with finger to rotate cross cylindrical lens 20. Then ask Testee to compare the two images he sees before and after turning the cross cylindrical lens. Stop at the better side. For example, if what Testee sees is clearest as shown in Fig.35 of cross cylindrical lens, turn cylindrical lens axis knob 26 to move axis of cross cylindrical lens by 5° in direction of red dot, so that position of cylindrical lens axis scale 28 is positioned at 95° .

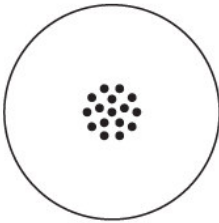

Fig.34

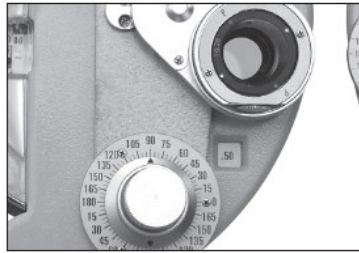

Fig.35

(3) Turn the lens again to make a comparison. If what Testee sees is the most clearest as shown in Fig.37, move cross cylindrical lens axially towards red dot by 5° , enabling it to become 100° .

(4) Turn the lens again. If Testee cannot report any difference, precise examining cylinder axis is completed (with astigmatic axis of 100°).

(5) Now to conduct precise measurement of cylinder power (C), and turn letter P to original axis (see Fig.37).

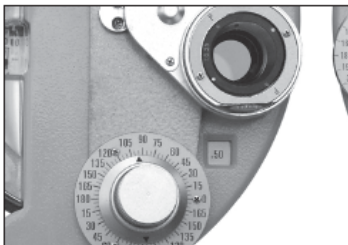

Fig.36

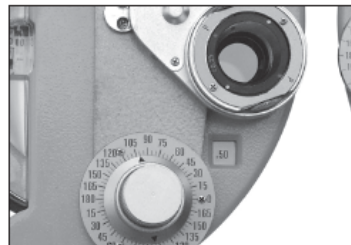

Fig.37

(6) Use cross cylinder dot chart shown in Fig.34 with same procedure as described in (2). Now ask Testee to compare the charts he sees. The result is shown as Fig.38. If Testee sees the clearest chart when red dot matches with letter P (as shown in Fig.38), it means Testee's diopter has increased by 0.25D (now Testee's diopter power is 24

0.75D).

(7) Turn the lens again to make a comparison. If the chart as shown in Fig.39 is the clearest, the diopter power should be decreased by 0.25D because white dot is positioned at P. If the red dot is positioned at P, it means diopter power is increased by 0.25D, thus totally 0.5D is added.

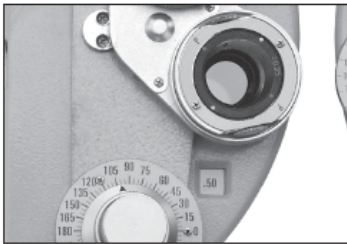

Fig.38

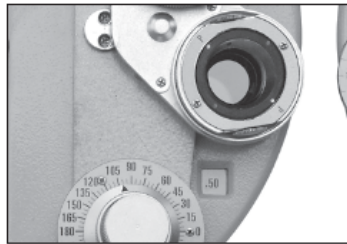

Fig.39

(8) Turn the lens again to verify the finding. If Testee reports that the chart in the setting of Fig.39 is clearest, the correct modified power should be between 0.25D and 0.5D. Hence the accurate power should be -0.62D.

4.8.4 Precise Refining Spherical Power (Red-Green Test)

(1) Use red and green chart to determine precise spherical lens value (see Fig.40). Ask the patient which one is seen clearest, red or green chart. If the green one is seen better, it indicates myopia is increased (hyperopia decreased). The reduce spherical lens value by 0.25D. $-1.75 \rightarrow -1.50$.

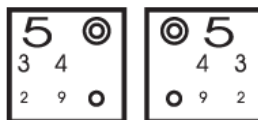

Fig.40

(2) Ask Testee again to affirm which chart is seen clearer, the clearer red stands for decreased myopia (increased hyperopia). Testee's power is 1.62D. Generally, the

weak spherical power dial is used to adjust myopia (and strong spherical power dial is used to adjust hyperopia).

(3) Now right eye examination is completed, with lens power result as follows:
Spherical power 1.50 Cylinder power 0.50 and Axis 100° R -1.50DS/-0.50DC 100°
Then examine the left eye. Turn auxiliary lens knob @1 , to set O for left eye, and OC for right eye. Then use same measuring method to measure left eye.
Testee 's left eye is measured as: L -2.00DS/-0.50DC 170°

4.8.5 Binocular Balance Test

(1) Rotary Prism Method

a. Tests are performed for left and right eyes independently, in which, binocular prism shall be used for both eyes. On the whole, these tests are referred to as the binocular balance test. Set both eyes to O. Use the chart shown in Fig.34 and set prisms as 2Δ U (right eye), and 2Δ D (left eye) (see Fig.41)

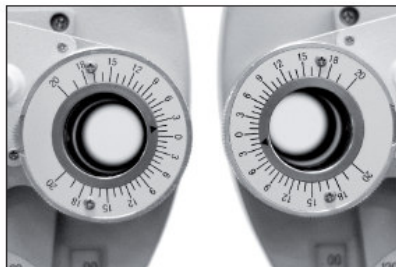

Fig.41

b. Now Testee sees two images of chart, one at upper side and one at lower side. When asked which image is seen clearest, Testee replies the upper one is clearest. Then add +0.25D to spherical lens value of right eye. When the image at lower side is seen clearest, add +0.25D to spherical lens value of left eye, namely, $(-2.00)+(+0.25)=-1.75$ D.

c. Ask Testee again to affirm which one is clearest. When both become similar, it means balance test is completed.

d. Remove the rotary prism. Add spherical lens power of + 1.00D to both eyes. So, Testee's visual acuity should be:

R -0.50DS /-0.50DC A 100°

L -0.75DS /-0.50DC A 170°

e. Now add minimum power of 0.25D to binocular spherical lens value . Gradually change the spherical lens value until he can see 1.2 or 1.5(20/15) visual mark clearly .

He desires to see 1.5 (20/15) clearly, then change spherical lens value as follows:

R -1.50DS /-0.50DC A 100°

L -1.75DS /-0.50DC A 170°

(2) Polarizing filter method

a. Turn auxiliary lens knob 21 to P (both eyes). Project the polarized binocular balance test chart.



Fig.42



Fig.43

b. Now Testee sees two images, one at upper side and one at lower side. When asked which image is seen clearest, Testee replies the upper one is clearer, and he can see upper row of the chart by his right eye, and the lower row by his left eye. If both rows can be seen with equal clarity, it means the balance is good. When both rows are not seen with equal clarity, add +0.25D spherical lens value to one eye with better clarity until both columns are seen with equal clarity.

C. Turn auxiliary lens knob 21 to O (both eyes). Add +1.00D to spherical lens value of both eyes.

d. Gradually reduce spherical lens value by precision of minimum 0.25D until visual acuity for both eyes becomes 1.2 or 1.5.

4.8.6 Measuring Phoria at Far Point

(1) Maddox rod and rotary prism method

a. First conduct horizontal phoria measurement. Proceed according to (1) rotary prism method described in 4.8.5 Binocular Balance Test. Turn auxiliary lens rotation knob 21, and set right eye to RMH (Fig.44). Turn prism rotation knob 11 with its setting 0 on the triangle symbol facing the left eye. Light a small fixation light at the position where the chart is projected. Now Testee's right eye can see a red vertical line (see Fig.45 a), and his left eye can see a light spot (see Fig.45 b). They are probably (a) or (b) of Fig.46. The light spot will also move when prism rotation knob 11 is turned. Then ask the patient to tell when he sees the image shown in Fig.46 b. The test result is shown in Fig.47. The prism rotation scale is shown as 2. The result of $2\Delta I$ (base inward) stands for 2Δ inclination outward.

b. Then measure vertical phoria. As shown in Fig.48, turn auxiliary lens knob 21 and set RMV for the right eye. Turn rotation prism lens 12 to set the left eye at horizontal position. Now Testee can see red horizontal line with the right eye, and the light spot with the left eye. Then using same procedure of a, ask Testee when he can see red line and light spot meet while turning prism lens rotation knob 11. When it is shown as Fig.49, Testee reports they meet, it is 0.5, below 0, indicating left eye is $0.5\Delta D$, called 0.5Δ upward heterophoria.

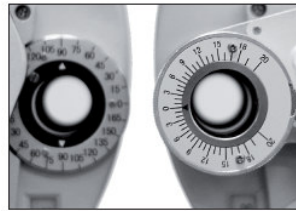
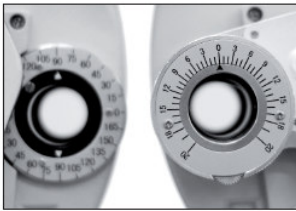

Fig.44

Fig.48

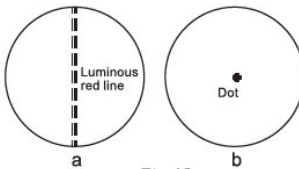

Fig.45



Fig.47

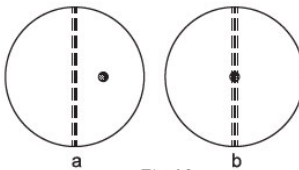

Fig.46

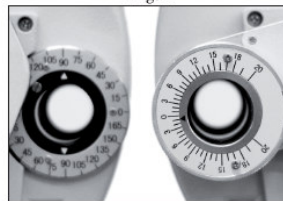

Fig.49

(2) Polarizing Filter Method

- a. Turn auxiliary lens knob 21 to P and project the polarizing chart (Fig.50).
- b. Unless the patient has phoria, four lines seen to the patient will be shown as Fig.50. If the patient has phoria, these four lines will not be in alignment.



Fig.50



Fig.51-a



Fig.51-b

- c. When the vertical lines are seen disposed as shown in Fig.51-a, turn rotation prism 12 of the left eye with 0 scale upward. Then turn prism rotation knob 11 slowly so that the image is shown as Fig.50 (horizontal phoria).
- d. When horizontal lines are seen disposed as shown in Fig.51-b, adjust 0 scale to horizontal position, and then turn prism rotation knob 11 so that the image is as shown in Fig.50 (vertical phoria).
- e. When both vertical and horizontal lines are disposed to have phoria, as shown in Fig.51-c, adjust rotary prism 12 to make scale 0 vertical so that the vertical line is in the middle of horizontal line, as shown in Fig.51-b (horizontal phoria). Afterwards, adjust scale 0 to be horizontal. Turn prism rotation knob 11 so that horizontal lines are in the middle of vertical line, as shown in Fig.51-a (vertical phoria).



Fig.51-c

4.8.7 Arranging Results

Now, examination of Testee is completed. If the results show Testee has severe phoria, the spectacles should be adjusted. If not, the prescription would be:

PD 63mm

R -1.5DS/-0.5DC 100°

L -1.75DS/-0.5DC 170°

4.8.8 Presbyopia Test

This test is provided to those who are more than 45 years old.

- a. First, affirm distance of measurement and put it in the examination aperture. Attach near point rod 31 and near point rod holder 5 to the instrument, then fix them firmly using clamping screw 3 .
- b. Turn auxiliary lens knob 21 to $\pm.50D$ (both eyes).
- c. Use near point card 32 as near point examination of the patient. Ask the patient how about the vertical line and horizontal line he sees. If presbyopia is seen, the horizontal line will be seen clearly, with vertical line being dull (if both lines are seen equally, presbyopia spectacles are unnecessary).
- d. Add 0.25 to both eyes' S simultaneously until horizontal line and vertical line are equally discernible.
- e. Change $\pm.50$ of both eyes to O. Turn the near distance card to show small letters.

Then ask the patient if letters are clear. A proper adjustment is required for S value.

The measurement is complete. Record the results.

4.8.9 Phoria at Near Distance

(1) Horizontal Phoria

If the patient has no presbyopia, set the results of phoria tested at far point in aperture. If the patient has presbyopia, put the results on the near point test. Set the near point card at 40cm, and turn auxiliary lens knob 21 to set the right eye at $6\Delta U$ so that letter rows are fully separated. If the patient has horizontal phoria, it will be shown as Fig.52. Turn rotary prism 12 to the other eye, with 0 scale upward.(see Fig.54) Turn prism rotation knob 11 so that there is no difference between the left and right eyes and, at this time, scale of the rotary prism indicates prism power(see fig.53).

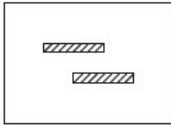

Fig.52

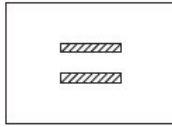

Fig.53

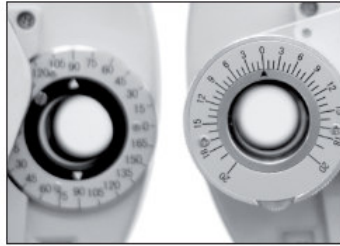

Fig.54

(2) Vertical Phoria

Turn auxiliary lens knob 21 to set the left eye at 10Δ so that letter columns are completely separated. If the patient has vertical phoria, it will be shown as Fig.55. Then turn the rotary prism to the other eye, with scale of 0 horizontal (as shown in Fig.57). Turn prism rotation knob 11 so that there is no difference between the upper and the lower (see Fig.56). Then scale of rotary prism indicates vertical phoria power.

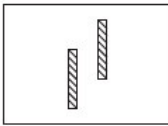

Fig.55

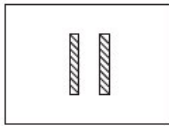

Fig.56

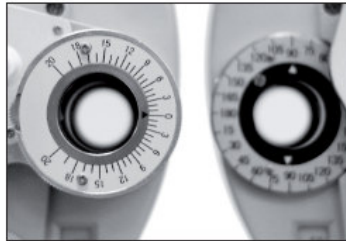

Fig.57

4.8.10 Other Measurements

(1) Vergence (eyeball movement in different direction)

Set rotary prism 12 in front of both eyes, and place 0 setting in uppermost position. To measure adduction of eyeball at far point, turn the prism outward for both eyes simultaneously. When the chart is seen as two images in the vertical direction (the point where double vision first occurs), the reading at this time indicates adduction power. The rotary prism can be used to measure maximum 40Δ only (about 22°). For abduction measurement, turn the prism of both eyes inwards simultaneously. When the object is seen as a double image, record the readings. Maximum range of measurement is 40 Δ. If 10 Δ BI is used on auxiliary lens disk, maximum test value is 50 Δ. Adduction and abduction at near point can be measured when the near point card is fixed to near point rod 31. The method for other measurements is identical.

(2) Vertical Abduction

Set rotary prism 12 in front of both eyes, and place 0 setting in horizontal position. Use the horizontal letters in the visual acuity chart for far point (5m) test, and use near point card to conduct near point test. Turn prism rotation knob 11 and, when horizontal letters are seen as a double image, record the reading, which is patient's vertical abduction power.

4.8.11 Transposition of Prescriptions

In Comprehensive Optometry Device, myopia astigmatic method is used to carry out fogging measurement. However, when hyperopia astigmatism is required sometimes, please use correction results in following formula.

$$XDS/YDC \text{ AZ}^\circ \rightarrow (X+Y)DS/(-Y)DC (Z\pm 90)^\circ$$

S: Add the cylinder lens power to the spherical lens power

C: Convert the index (+-) of cylinder lens power

A: Add 90° when Z is less than 90°; and deduct 90° when Z is larger than 90°.

Example 1:

For +4.00DS/-1.50DC ×155°, changed to

$$S:(+4.00)+(-1.50)= +2.50$$

$$C:(-1.50)= +1.50$$

$$A:155^\circ-90^\circ= 65^\circ$$

So the result is

$$+2.50DS/+1.50DC \times 65^\circ$$

Example 2:

For +1.5DS/+0.75DC ×75°

$$S:(+1.5)+(+0.75)= +2.25$$

$$C:-(+0.75)= -0.75$$

$$A:75^{\circ}+90^{\circ}= 165^{\circ}$$

So the result is:

$$+2.25DS/-0.75DC\times 165^{\circ}$$

5.Maintenance

5.1 Daily Care

- (1) Use dust cover 34 to protect the instrument from dust when it is not in use.
- (2) For long-term storage, keep the instrument in a dry place free of dust.
- (3) When lens becomes dirty, use lens cleaning cloth moistened with a little absolute alcohol to wipe it.
- (4) Before operation. Clean Forehead Rest 29 and nosepiece with medical cotton watted with absolute alcohol.

5.2 Checking and Servicing Procedure

In normal use, no special checking or servicing is necessary. However, when it is used at extremely low temperature, the turning knobs or dials will become heavier than usual because of lubricant used inside, instead of any mechanical reason. When temperatures return to normal, all will be normal.

6 Before Requesting Service-Troubleshooting Guide

If any problem occurs, first check the following items, and follow the suggested instructions . When the trouble cannot be eliminated, please contact us.

- (1) The required lens cannot be set at examination aperture

Is knob turned to correct position?

Is any other lens attached to the patient's examination aperture?

- (2) When vergence lever 8 is adjusted, does any action of corresponding vergence occur?

7. Transportation and Storage

7.1 Transportation

Avoid sunshine, rains, heavy pressure and vibrant movement during transportation. Hold and move instruments lightly during transport and loading. No throw is allowed. During transportation, please keep the instrument well packed in original packing materials.

Heavy hit may cause instrument failure.

Transportation temperature: -10°C to 50°C

Transportation humidity: $\leq 80\%$ (No condensing)

7.2 Storage

Store the instrument in dry, ventilated indoor place without corrosive gases. Details are below:

Storage temperature: 5°C to 40°C

Storage humidity: $\leq 70\%$ (No condensing)

Low dust content environment

No direct sunlight

8 Optional Accessories - Cylinder Lens

Three types of spare lens are optional: -2.00CYL , -0.12CYL and 00CYL .



MPH150

USER GUIDE (MULTILINGUAL)

Essilor Instruments USA

8600 W. Catalpa Avenue, Suite 703

Chicago, IL 60656

Phone: 855.393.4647

Email: info@essilorinstrumentsusa.com

www.essilorinstrumentsusa.com