



# MRP and Forecasting Views in SAP Material Master and MRP Org. Structure

LOG-MD-004

October 7, 2008

# LaGOV

Version 1.01

Updated: 10/02/2008



# Agenda

- Logistics, Ground Rules & Introduction
- Workshop Objectives
- Project Overview/Timeline
- Business Process Review
  - As Is Process Discussions
  - SAP terms glossary
  - Process improvement opportunities
  - SAP concepts & functionality
  - Leading practices
  - Enterprise readiness challenges
- Action Items
- Questions



# Logistics

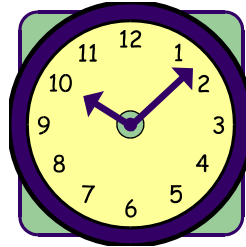

**Before we get started ...**

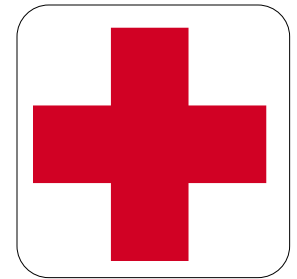



# Ground Rules

- Has everybody signed in?
- Everybody participates – blueprint is not a spectator sport
- Silence means agreement
- Focus is key – please turn off cell phones and close laptops
- Challenge existing processes and mindsets
- Offer suggestions and ideas
- Think Enterprise
- Ask questions at any time
- One person at a time please
- Creativity, cooperation, and compromise





# Introduction

## ■ Roles

- **Process Analyst and Functional Consultant (IBM)** – lead and facilitate the discussions and drive design decisions
- **Documenter (State Employee)** – take detailed notes to support the formal meeting minutes to be sent by the Process Analyst to all participants for review and feedback
- **Team Members (LaGov)** – provide additional support for process discussions, address key integration touch points
- **Subject Matter Experts** – advise team members on the detailed business process and participate in the decisions required to design the future state business process

### ***Round the Room Introductions***

***Name***

***Position***

***Agency***



# Project Phases

## ■ Five Key Phases

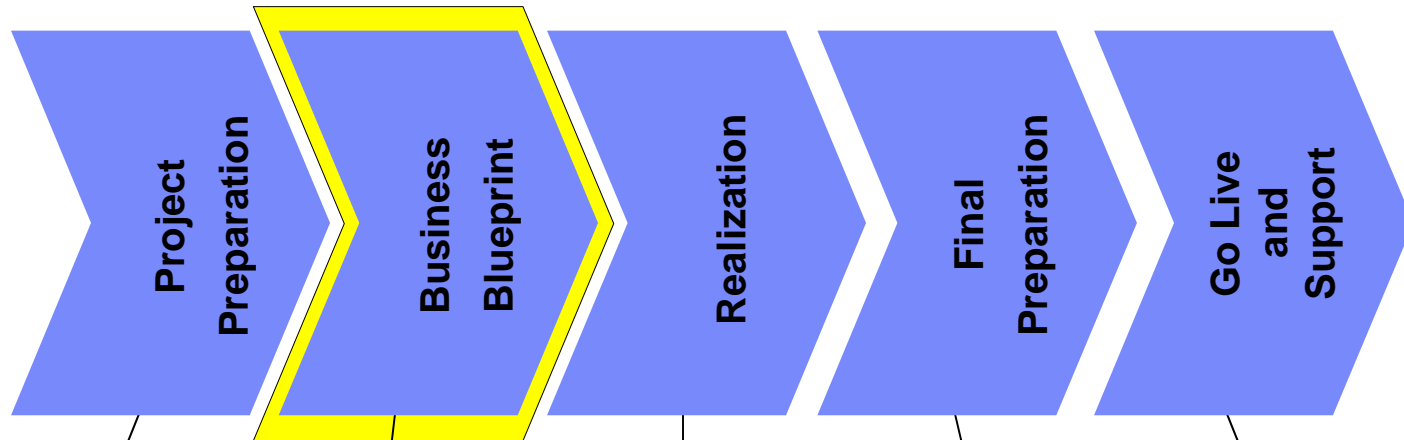

- Strategy & Approach Defined
- Project Team Training

- Development & Unit Testing
- Integration Testing
- End-User Training Materials

- Go-Live Support
- Performance Tuning

- Business Process Definition
- Development Requirements

- User Acceptance
- Technical Testing
- End-User Training
- Conversion



# Tentative Project Timeline

- Tentative implementation dates are planned as follows:

Functionality	Tentative Implementation Date
Budget Prep	October 2009
DOTD	February 2010
Core Modules All Agencies	July 2010
Additional Modules	January 2011

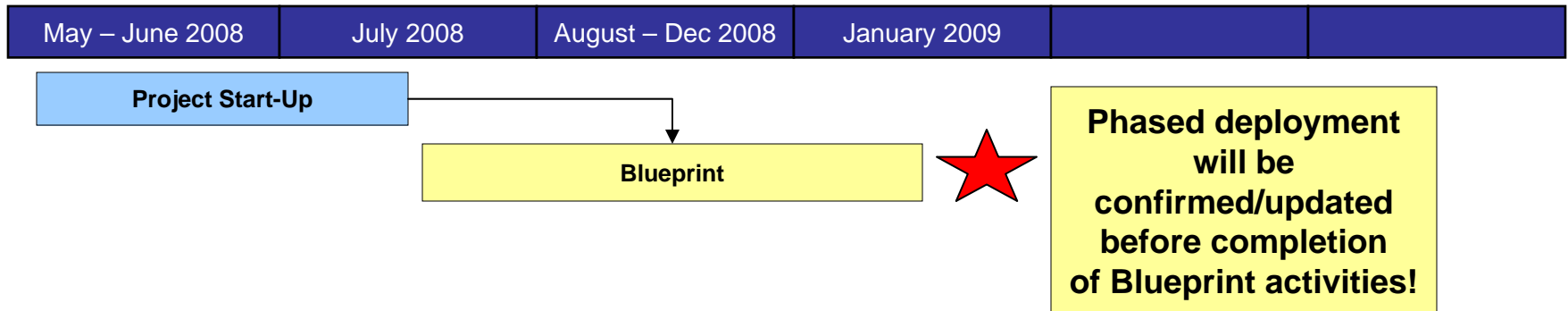



# Blueprint Schedule - Tentative

- Please refer to the handout for the upcoming Blueprint Sessions





# Blueprint Objectives

1. Review and discuss the current or As-Is Business Processes:
  - Which helps to drive out the ***business requirements***
  - As well as the ***integration points*** with other processes
2. Define Master Data
  - Address key integration points
  - Support organizational requirements
  - Consistent and appropriate use of data fields



# Blueprint Objectives

3. Define Future or To-Be Business Processes based on:
  - Best Practices inherent in SAP
  - Intellectual capital from other SAP implementations
  - State business requirements
  
4. Identify Development Requirements:
  - Forms
  - Reports
  - Interfaces
  - Conversions
  - Enhancements
  - Workflow



# Blueprint Objectives

5. Understand and communicate any Organizational Impact / Enterprise Readiness Challenges
6. Gather system Security Authorizations and State-wide Training Requirements



# Today's Workshop Objectives

1. Overview of general Inventory Replenishment and MRP concepts
2. Review and discuss the current or As-Is replenishment processes and logic
3. Define key MRP Material Master data:
  - MRP types
  - Lot sizing
  - Lead time elements
  - MRP controller
  - Organizational levels
4. Review SAP MRP functionality and control data – system demo
5. Review SAP Forecast functionality
6. Determine forecast applicability based on consumption history



# FUTURE CONSIDERATIONS

- MRP/Forecasting Material Master and Org. Elements:
  - MRP types
  - Lot sizing procedures
  - Special procurement keys
  - Lead time elements to be applied
  - Use of MRP Areas or Storage Location MRP
  - Definition and use of MRP Controller
  - Locations where MRP applies
  - Use of statistical forecast
  - Functional development objects required
  - Conversion requirements and logic



# Project Scope

## Systems to be Replaced

---

- **DOTD**
  - PIMS (Purchasing Inventory Management System)
  
- **DPS**
  - VENICE
  
- **WILDLIFE & FISHERIES**
  - PARADOX



# AS-IS Process Flow



09/26/2008

## DEPARTMENT OF PUBLIC SAFETY Inventory Replenishment List

Page 1 of 3

Stock Item	Description	Current Price	Min	Max	On Order	Back Order	Order Method	Order UOM
<b>Site ID: CENTRAL WAREHOUSE (WHSE)</b>								
A0-01-03-007	BINDER, 3-RING, 11 x 8-1/2" X 2" BLACK	\$1.50	60	180	0.0	0.0	O	EA
A0-01-05-016	BOXES, FILE, STORAGE, LETTER SIZE	\$2.77	850	2550	0.0	0.0	O	EA
A0-01-07-015	CALENDAR, DESK PAD, 2008, 22 X 17	\$1.51	100	500	0.0	0.0	O	EA
A0-01-27-029	FOLDER, FILE POCKET, LEGAL SIZE	\$0.45	500	1500	0.0	0.0	O	EA
A0-01-30-001	GLUE STICK, 1/4 oz.	\$0.33	72	216	0.0	0.0	O	EA
A0-01-43-200	LABLES, DYMO LABELWRITER	\$16.34	10	30	0.0	0.0	O	BOX
A0-01-51-001	NUMBERING MACHINE INK PADS, (BLACK)	\$1.99	5	60	0.0	0.0	O	EA
A0-01-53-059	PAD, COLUMNAR GREEN 11x16-3/8, 13-COL.	\$3.74	0	0	0.0	0.0	O	EA
A0-01-72-001	Scissors 8" nickel	\$3.75	75	225	0.0	0.0	O	EA
A0-02-01-008	FLUOR LAMP, 96", F96T12/CW/SS, 15/CASE	\$2.95	28	76	0.0	0.0	O	EA
A0-02-01-010	Fluor. Lamp U shape	\$2.68	38	114	0.0	0.0	O	EA
A0-02-05-005	Incandescent telebinocular bulb	\$0.69	10	30	0.0	0.0	O	EA
A0-03-05-003	Paper 8-1/2"X11"	\$25.70	427	2550	0.0	0.0	O	CS
A0-05-07-011	Cleaner, all purpose, (1 gal. jug)	\$5.25	100	300	0.0	0.0	O	EA
A0-05-07-020	Cleaner, bowl, non-corrosive (32 oz.)	\$1.27	360	1080	0.0	0.0	O	EA
A0-05-15-024	Liners, office can, 15" x 9" x 24"	\$8.50	72	216	0.0	0.0	O	CS
A0-05-17-001	Toilet tissue, regular, 96 / case	\$0.30	16000	48000	0.0	0.0	O	ROLL
A0-05-23-005	Dishwashing liquid	\$0.94	306	918	0.0	0.0	O	EA





# Inventory Replenishment - DPS

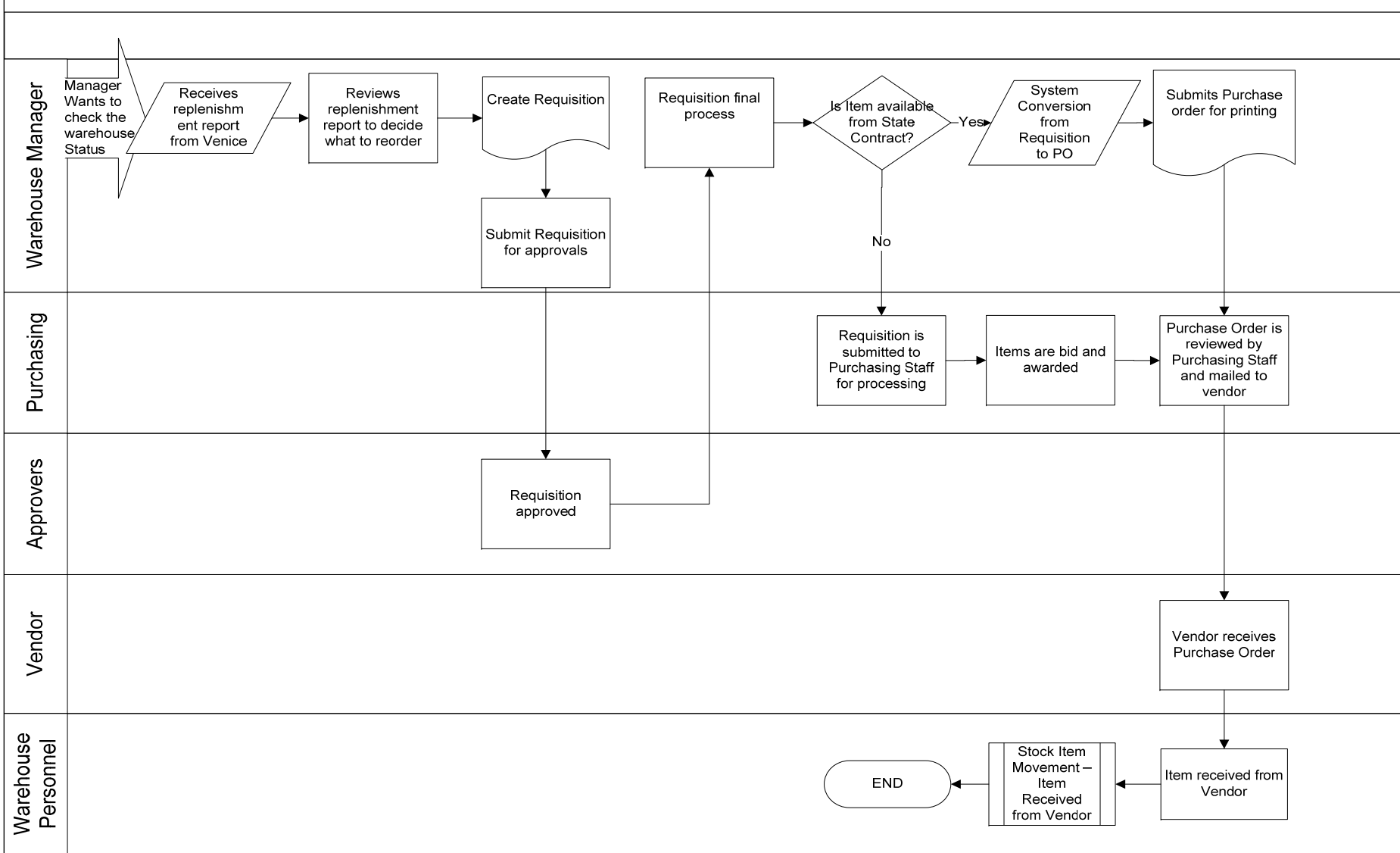



DOTD Warehousing – Ordering Inventory

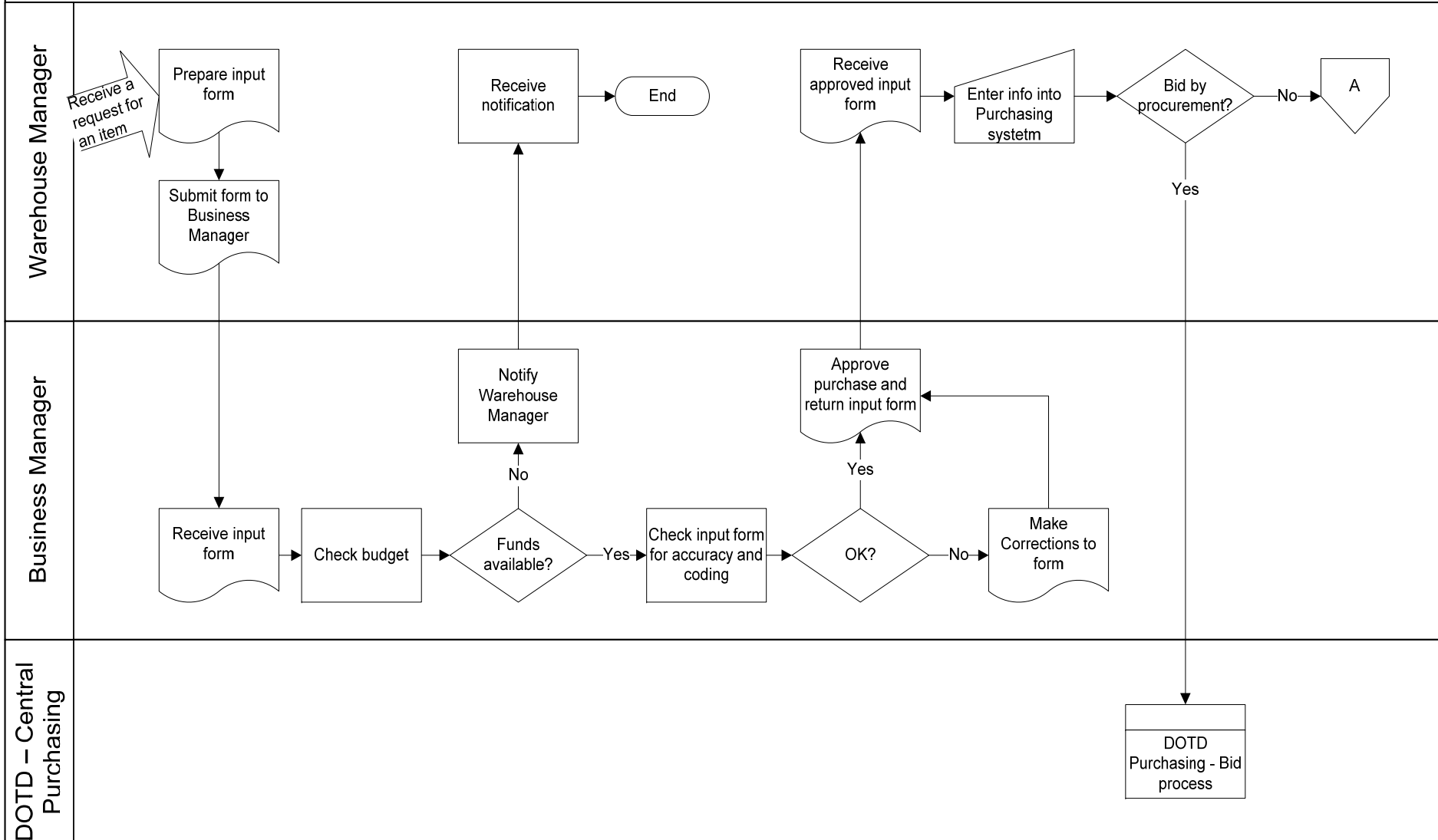



## DOTD Warehousing – Ordering Inventory

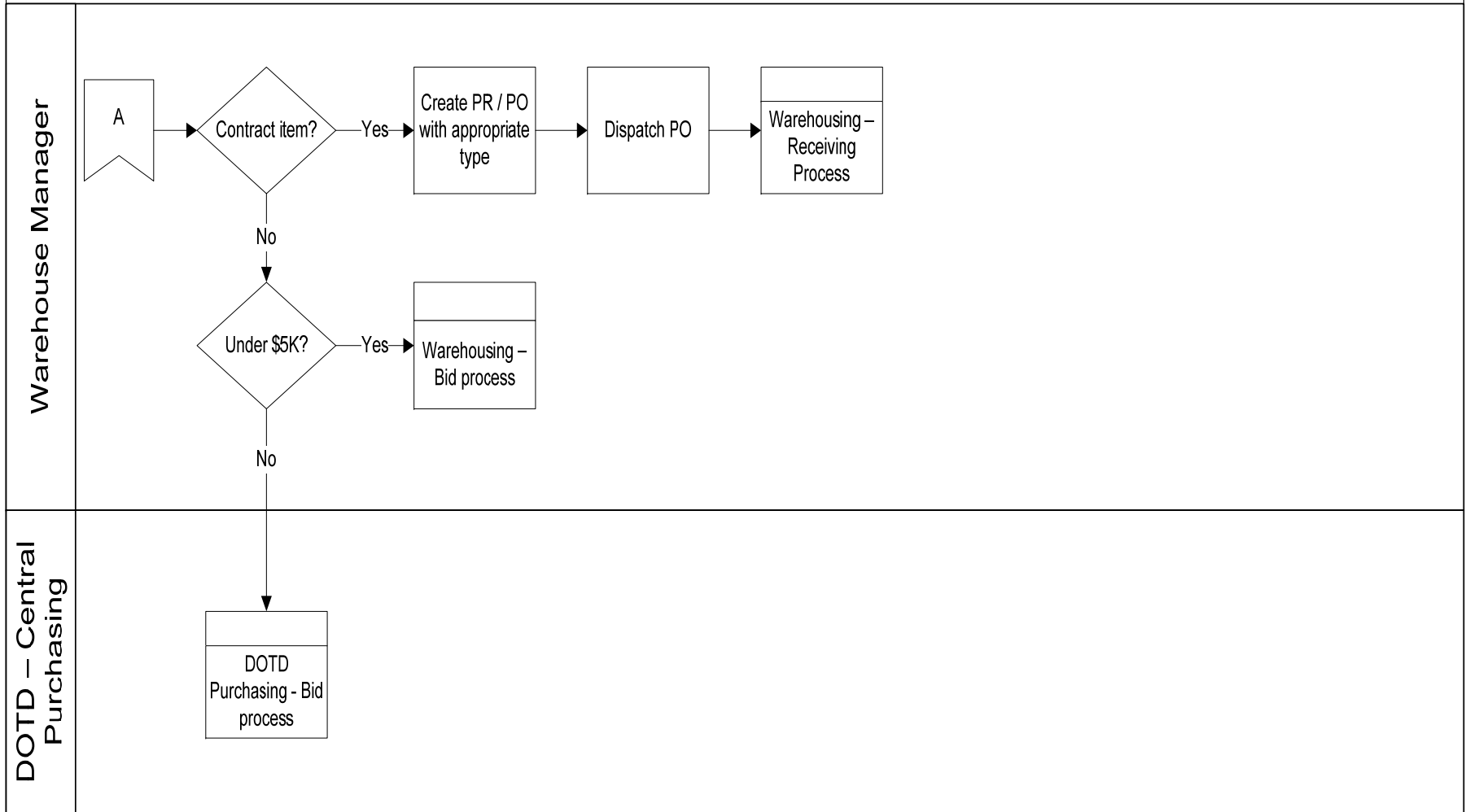



# **Overview of General Inventory Replenishment and MRP Concepts**



# Overview of General MRP Concepts

## Overview of Inventory Control - Purpose of Holding Inventory

Different scheduling techniques can be used with different inputs for demand. The selection of the input will impact the logic used to generate the planning requirements.

Demand inputs can come from:

**Forecast** = The anticipated quantity that will be required at some time in the future (push-based)

**Replenishment** = A quantity that equals the difference between a fixed target inventory level and current inventory (pull-based)

**Make-to-order** = The exact quantity that is needed for orders (pull-based)



# Overview of General MRP Concepts

## Overview of Inventory Control - Purpose of Holding Inventory

Inventory is used as a buffer between uncertain and variable demand and supply.

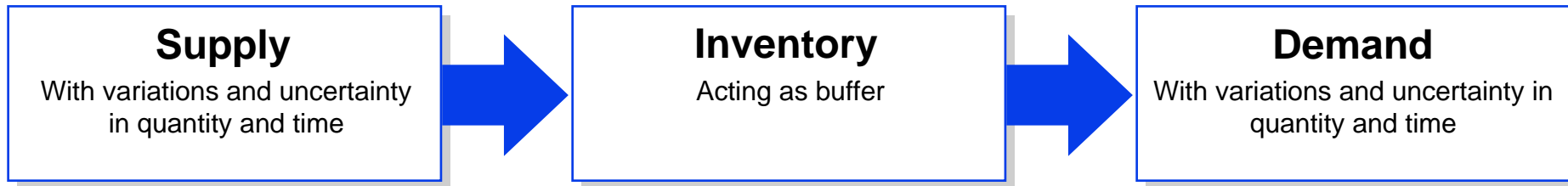

### Inventory Functions

- Decouples operations
- Allows for mismatches between supply and demand rates
- Helps maintain stable business operations when the Supply Chain is unreliable
- Allows for unexpected demands (size or timing)
- Allows for deliveries which are smaller or later than expected
- Maintains service levels to customers



# Overview of General MRP Concepts

## Overview of Inventory Control - Inventory Variation

Would you plan these two products differently?

Product A

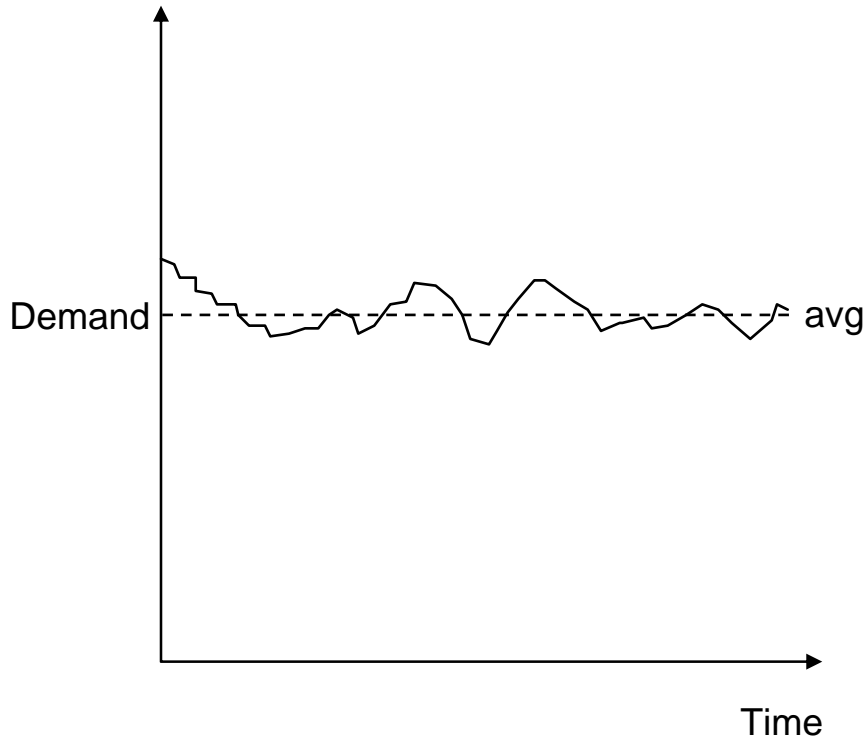

Product B

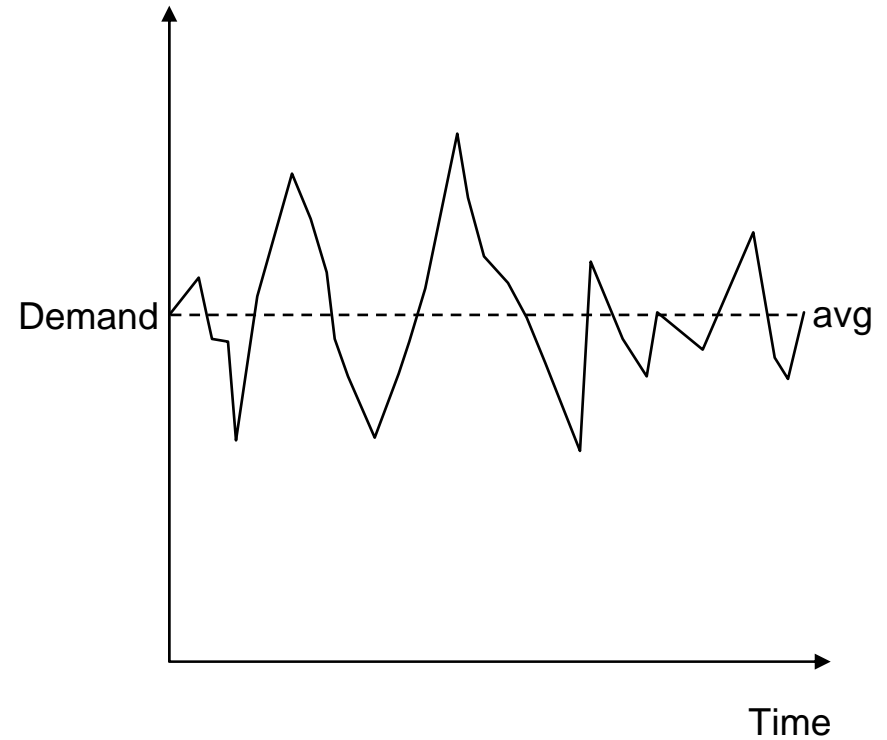



# Overview of General MRP Concepts

## Fixed Quantity System - Constant Demand, Constant Lead-time and Constant Supply

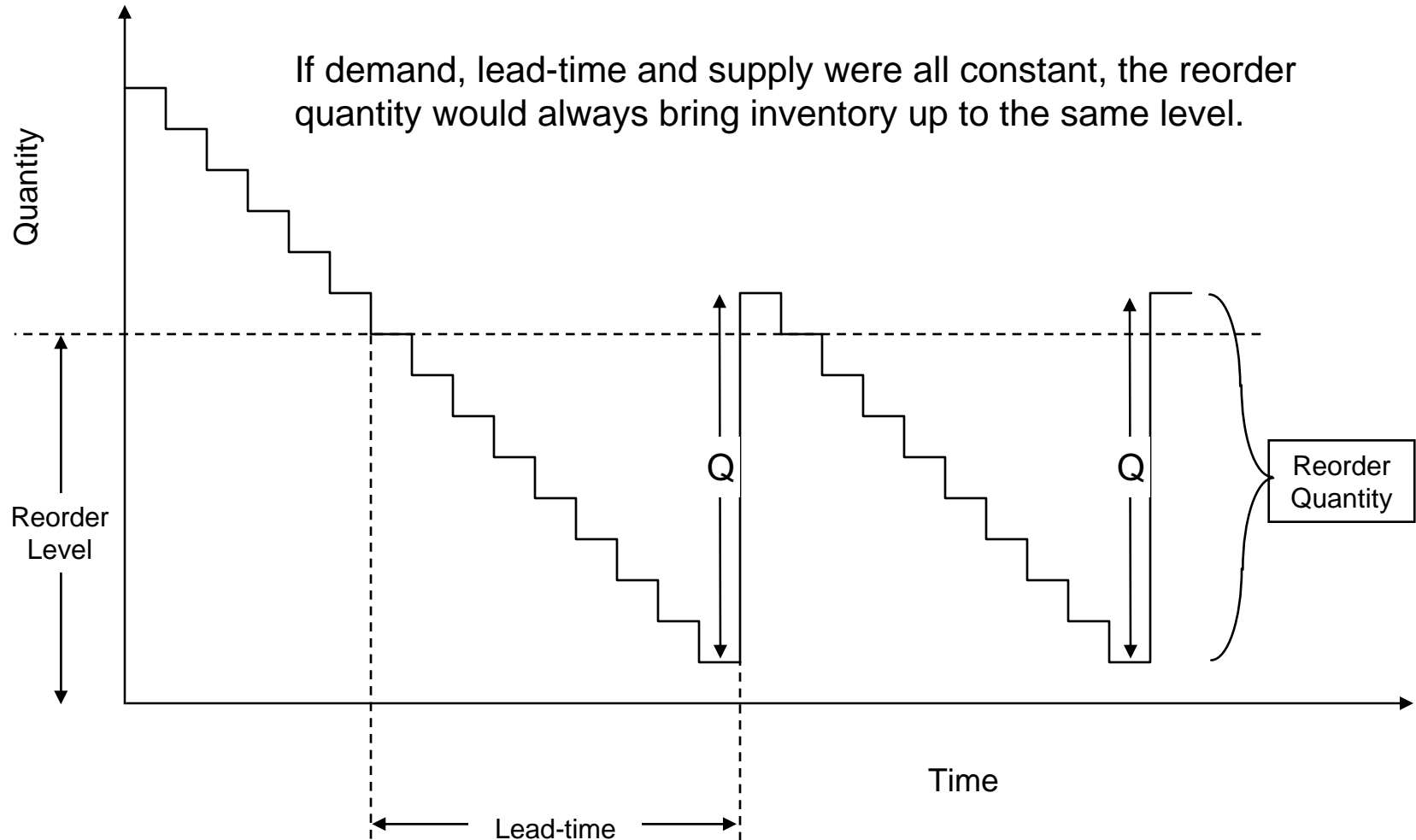





# Overview of General MRP Concepts

## Fixed Quantity System - Uncertain Demand

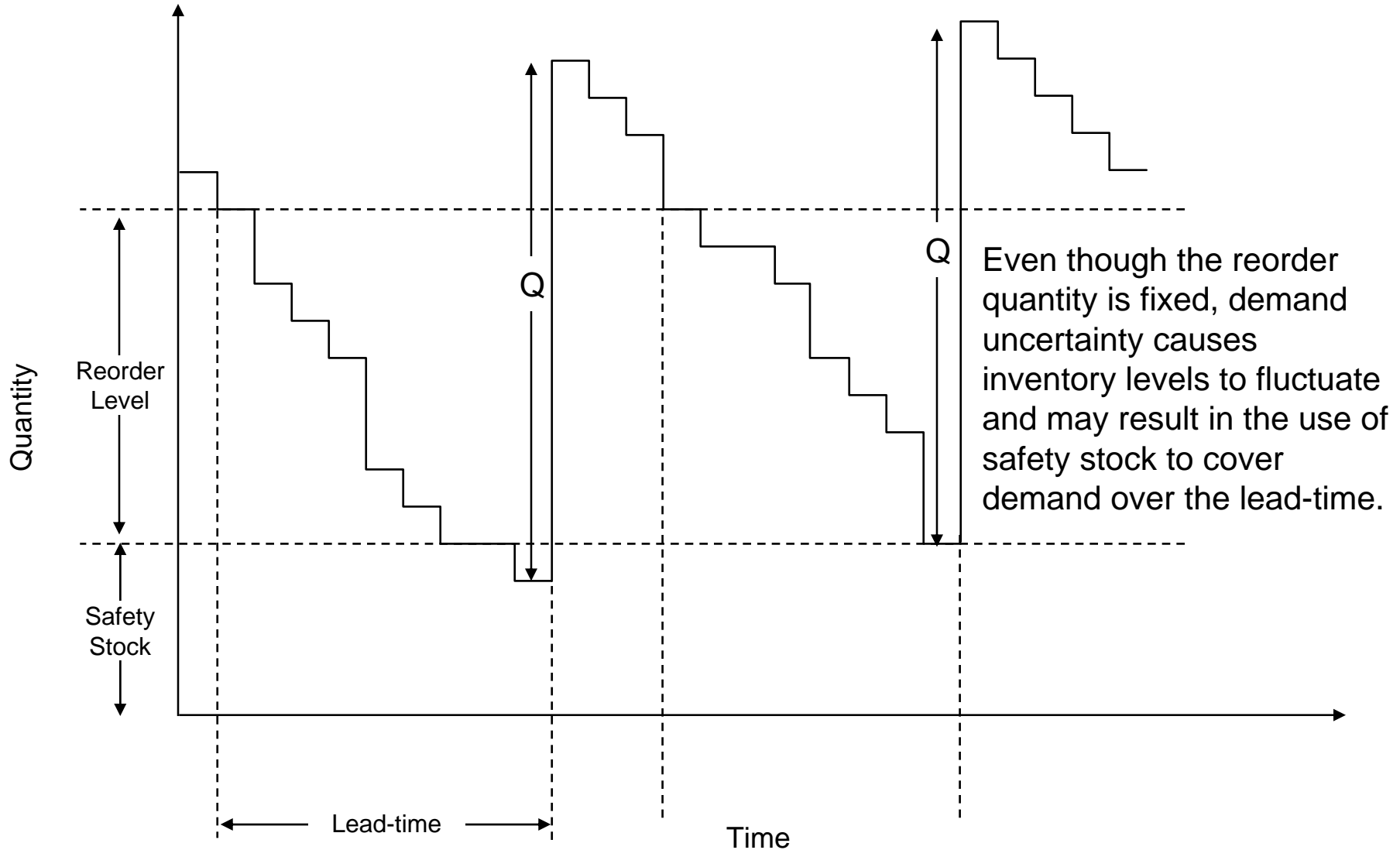



# Overview of General MRP Concepts

## Fixed Quantity System - Uncertain Lead-time

Even though the reorder quantity is fixed, lead-time uncertainty causes inventory levels to fluctuate and may result in the use of safety stock to cover demand over varying lead-time.

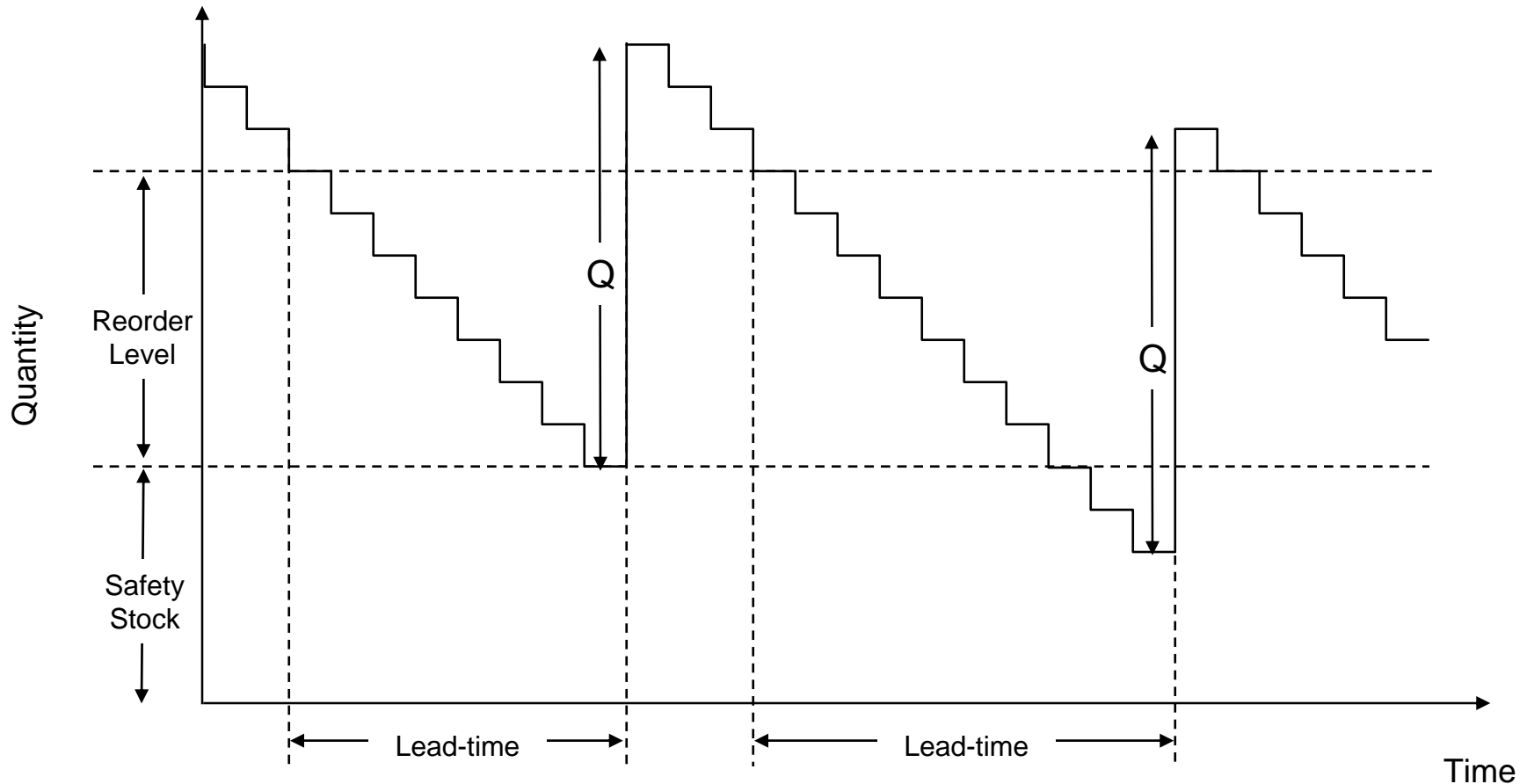



# Overview of General MRP Concepts

## Fixed Quantity System - Uncertain Supply

Even though the reorder quantity is fixed, supply uncertainty causes inventory levels to fluctuate and requires safety stock.

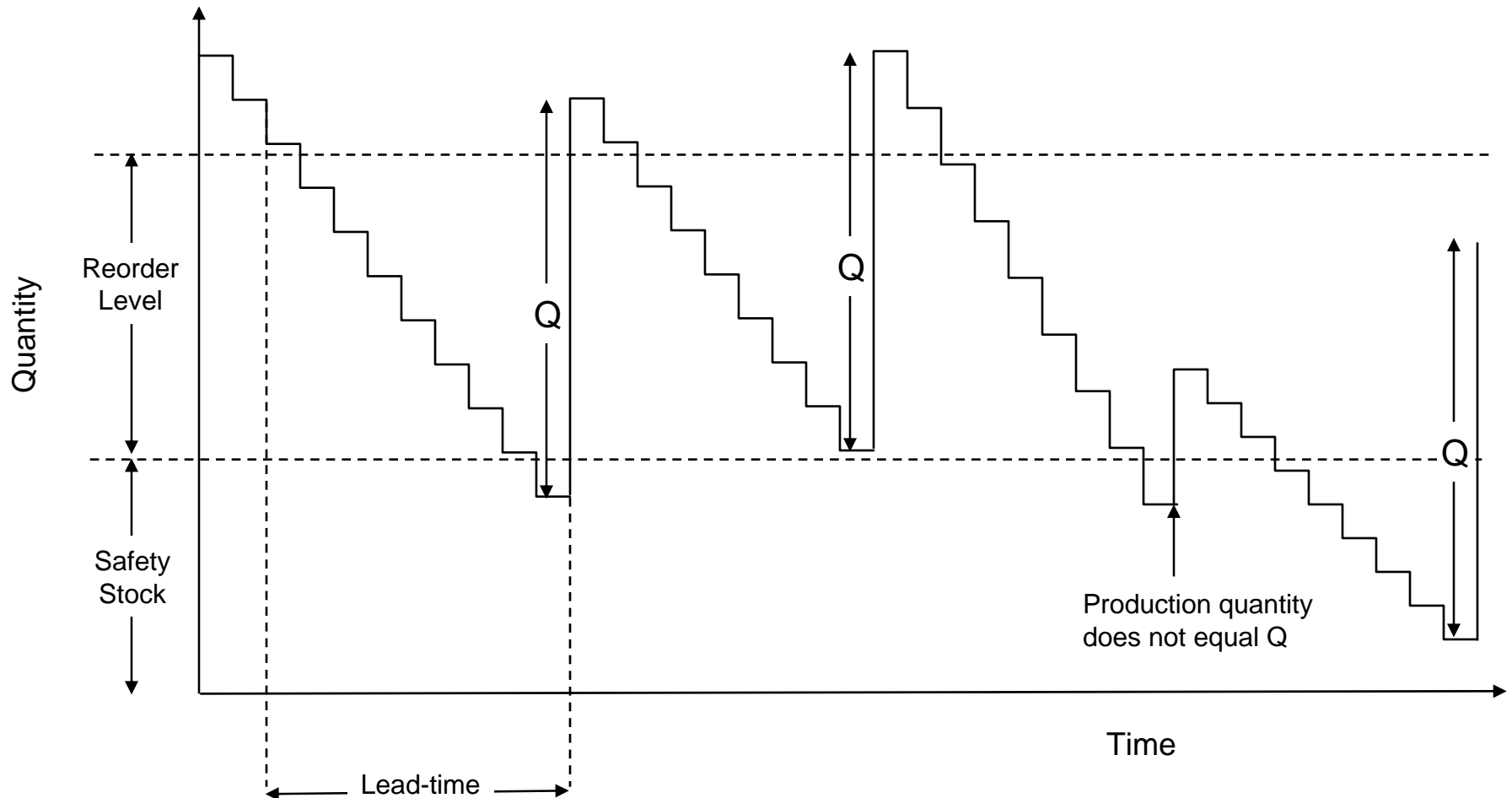



# Overview of General MRP Concepts

## Fixed Quantity System - Uncertain Demand, Lead-time and Supply

The combined effects of uncertain demand, lead-time and supply results in higher safety stock and higher average inventory levels as well as greater inventory variability

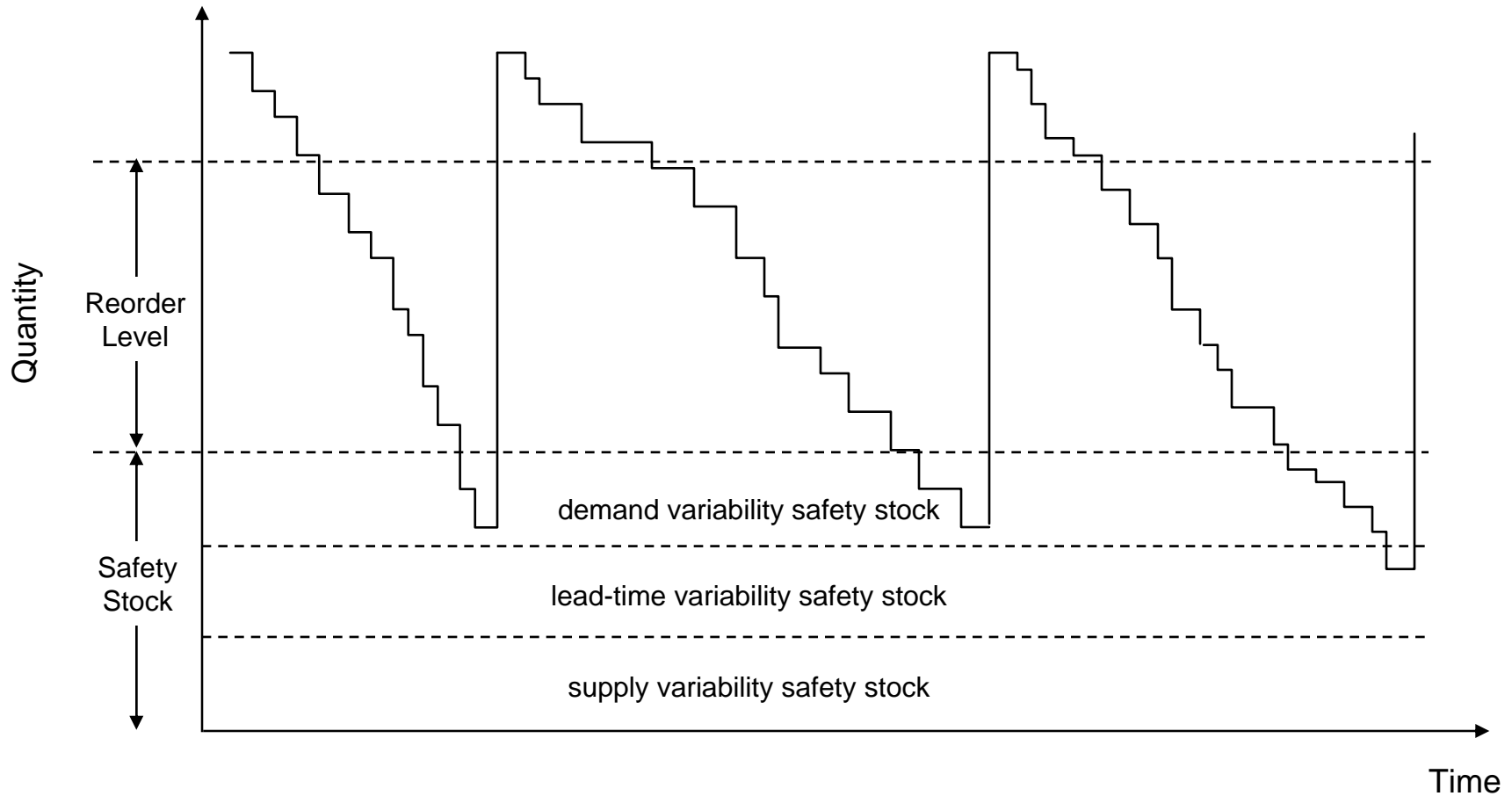



# Overview of General MRP Concepts

## Min / Max System Definition

A Min / Max System is used when individual customer orders can take the stock level well below a reorder level. Instead of using a fixed order quantity and reorder level, the Min / Max system uses a target inventory level (TIL) and reorder level (ROL). When the stock level gets close to the reorder level, a quantity is scheduled to bring inventory back up to the target inventory level. The higher inventories reduce the chance that one order will take inventories below the reorder level.

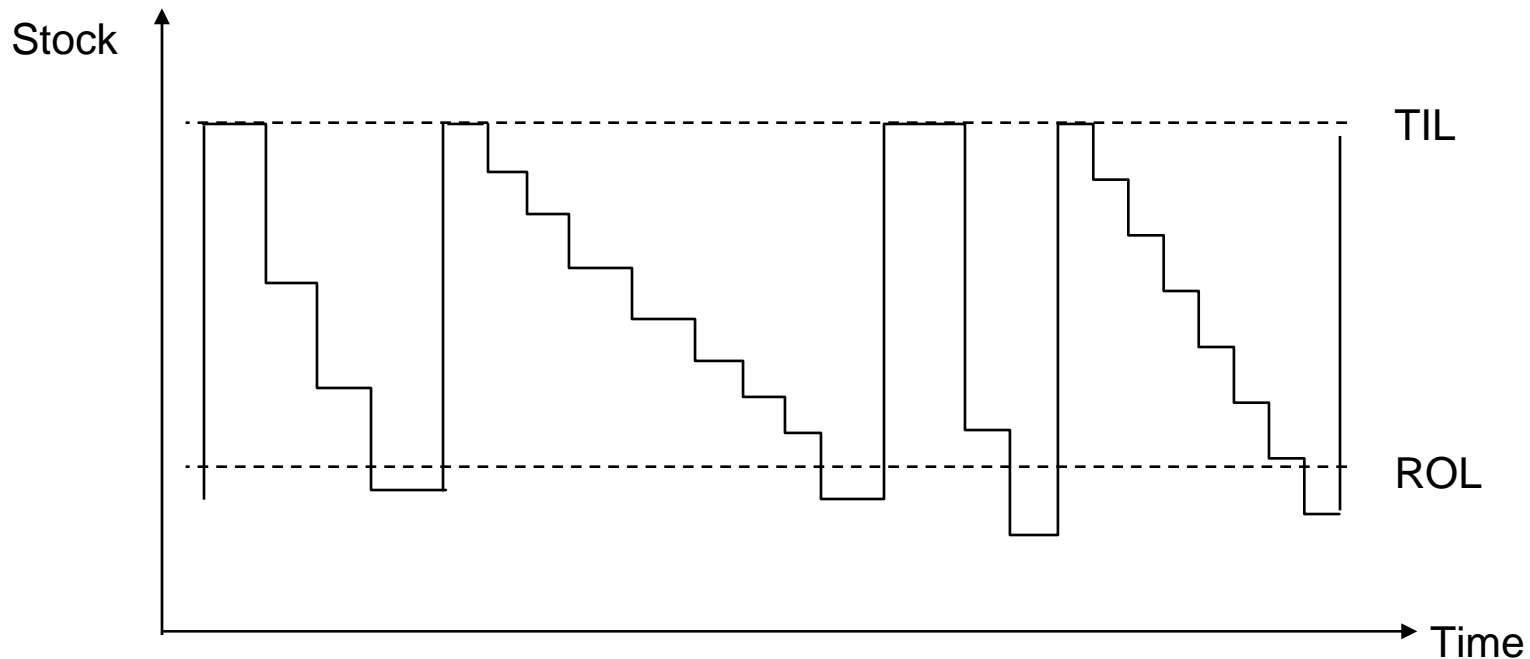



# GLOSSARY



# SAP MRP Glossary

- **MRP** – Material Requirements Planning
- **Plant** – An organizational unit that:
  - Can be a distribution center
  - Can be a manufacturing or maintenance facility
  - Holds inventory separate from other plants
  - Is the default organizational level for MRP
  - Can be set as the valuation level for materials
- **MRP Area** – An organizational unit for which material requirements planning is carried out independently. It is a subdivision of a plant and can have one or more storage locations assigned.
- **Storage Location** – An organization unit that allows the differentiation of material stocks within a plant. From an MRP perspective all storage locations are included in a plant MRP unless:
  - It is excluded from MRP
  - It is set to run storage location MRP – simple reorder point and fixed replenishment quantity only.
- **MRP Controller** – An organizational unit that is assigned to each material in a plant and forms the basis for running MRP reports and managing MRP order proposals.



# SAP MRP Glossary

- **MRP Type** – Controls which procedure is to be used to plan a material and which MRP parameters can be entered when maintaining a material master record.
- **Special procurement type** – Can be used to override the procurement type in the material master or define the procurement type more precisely – for example stock transport order.
- **Lot size** – Controls lot-sizing procedures that serve to calculate the procurement (purchase order) quantities.
- **Reorder point** – When stock falls below this quantity, the system flags the material for requirements planning.
- **Safety stock** – Specifies the quantity whose purpose is to satisfy unexpectedly high demand in the coverage period.
- **Purchasing processing time** – Time required to convert a purchase requisition into a purchase order.
- **Planned delivery time** – Number of calendar days needed to obtain the material or service if it is procured externally.
- **Goods receipt processing time** – Number of workdays required after receiving the material for inspection and placement into storage.
- **Storage location MRP indicator** – An indicator used to either exclude storage locations from material requirements planning at plant level or to plan separately.





# SAP Forecast Glossary

- **Forecast formulas** – System provided formulas for:
  - Forecast models
  - Evaluation of the forecast
  - Calculation of reorder level and safety stock
- **Forecast model** – Indicator that defines on which forecast model the system bases its calculation of future requirements of the material.
- **Period indicator** – Indicator specifying the periods in which the material's consumption values and forecast values are managed such as months, weeks or days.
- **Historical periods** – The number of historical values the system uses for the forecast.
- **Forecast periods** – Number of forecast periods forwards the system creates
- **Periods per season** – Number of periods in a seasonal cycle in statistical forecasting.
- **Initialization periods** – Number of historical values that should be used for initialization of a forecast. It can be fewer than the number of historical periods.
- **Initialization indicator** – Number of calendar days needed to obtain the material or service if it is procured externally.
- **Tracking limit** – Value that specifies the amount by which the forecast value may deviate from the actual value.



# SAP MRP Functionality



# MRP Functionality

## Definition

**Material Requirements Planning (MRP)** is a term for all the actions necessary to create production and procurement plans for materials in a plant.



# MRP Functionality

## Materials Planning Procedures

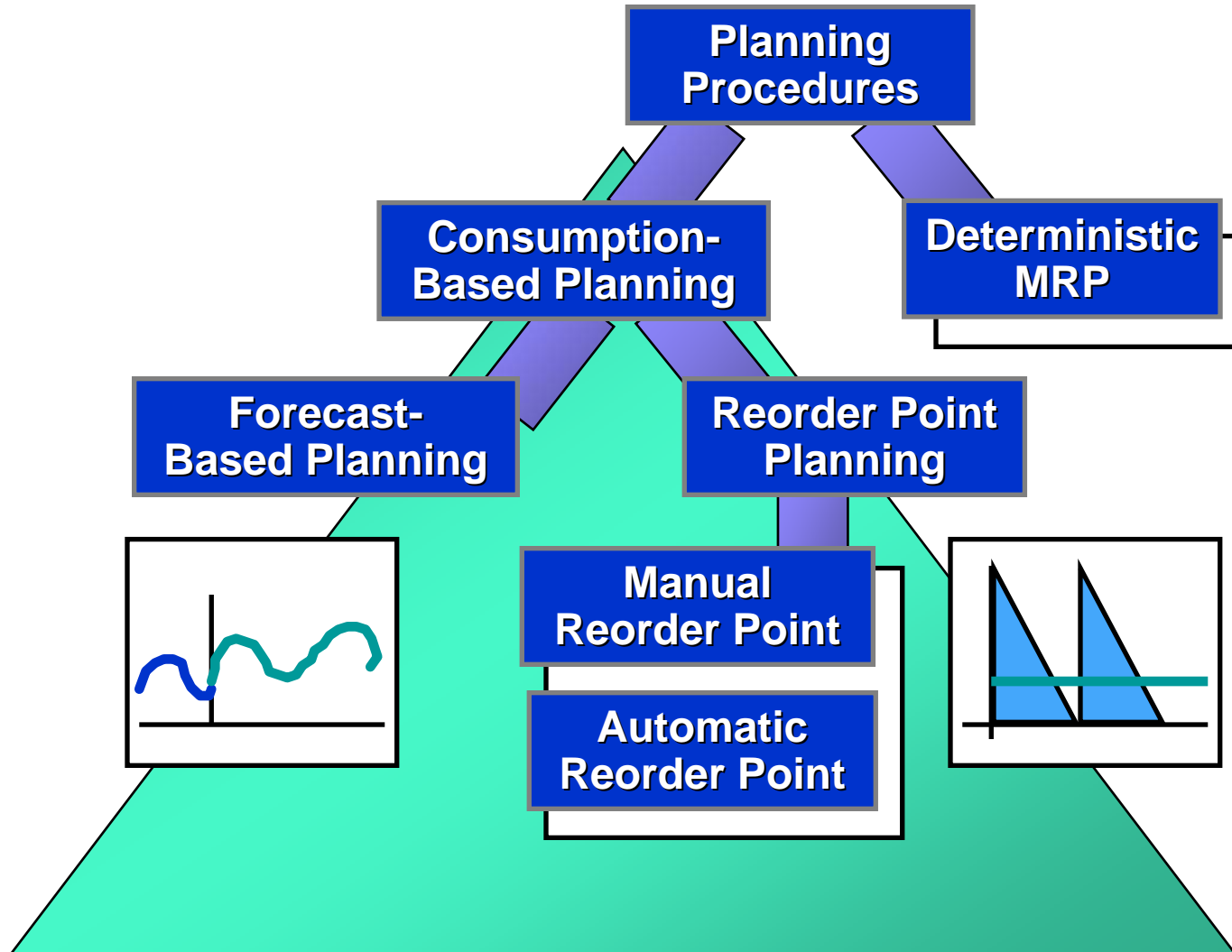



# MRP Functionality

## Consumption-Based MRP and Deterministic MRP Differences

- **Deterministic MRP**

- Using the plan/forecast for the higher level assembly and MRP BOM Explosion
- Using the forecast for unplanned additional requirements

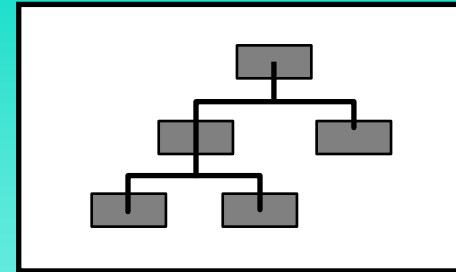

- **Consumption-Based MRP**

- Manual reorder point planning
- Automatic reorder point planning
- Forecast-based planning

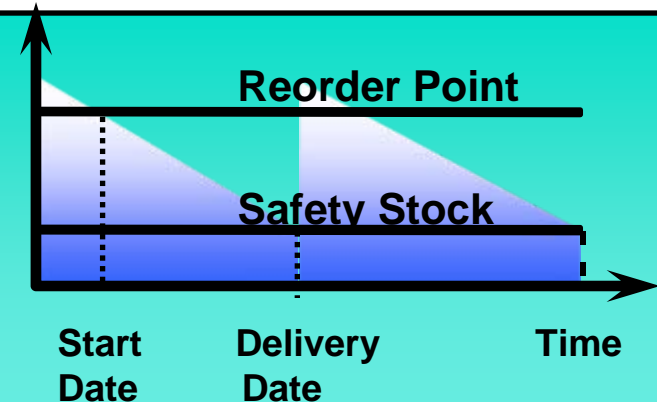

**No Materials Planning**



# MRP Functionality

## Plan Driven MRP

### Plant Stock

- Safety stock
  - + Receipts (purchase orders, firmed procurement proposals, production orders)
  - Requirements quantity (e.g., planned independent and customer requirements, material reservations, forecast requirements for unplanned additional requirements)
- 
- + Available Stock

## Net Requirements Calculation for deterministic MRP

In MRP, requirement quantities are maintained in the system as planned independent requirements, customer requirements, dependent requirements, material reservations as well as forecast requirements. The system checks every requirement and forecast to determine whether they are covered by available warehouse stock or receipts (purchase orders, firmed procurement proposals, production orders and so on).

## Features

Available stock is calculated as follows:

- A shortage occurs when the requirement quantities are greater than expected receipts and stock quantity.
- The system specifies the date of the issue (for example, customer requirement, planned independent requirement, reservation, forecast requirement) as the requirements date.



# MRP Functionality

## Reorder Point Planning

**Plant Stock**

**+ Open order quantity (purchase orders, firmed planned orders, firmed purchase requisitions)**

---

**= Available stock**

### Net Requirements Calculation for Reorder Point Planning

In reorder point planning, the net requirements calculation is only carried out once the stock level has fallen below the reorder level. Issue elements, such as, customer requirements, planned independent requirements, or reservations are displayed and are not included in the net requirements calculation.

### Features

Available warehouse stock is calculated as follows:

- When available warehouse stock falls short of the reorder level then the shortage quantity is the difference between these two
- The system specifies the date of the planning run as the requirements date
- Safety stock is ignored when calculating the shortage quantity. However, if stock should fall below the safety stock level, the MRP controller receives an exception message



# MRP Functionality

## Forecast Driven MRP

### Plant Stock

- Safety Stock

+ Receipts (purchase orders, confirmed purchase orders)

- Requirements quantity (forecast requirements)

---

= Available Stock

## Net Requirements Calculation for Forecast-Based Planning

The basis of forecast-based planning is the forecast of the total requirements. The system only considers the forecast requirement quantities as issues. Other issue elements, such as, customer requirements, planned independent requirements, or reservations are displayed and are not included in the net requirements calculation. The system checks every forecast requirement to determine whether it is covered by available warehouse stock or receipts (purchase orders, firmed procurement proposals).

## Features

Available stock is calculated as follows:

- A shortage occurs when the requirements quantity is greater than expected receipts
- The system specifies the forecast requirements date as the requirements date. In this case, it assumes that forecast requirements are needed at the beginning of the period. This means that the requirements date is the first workday of the respective period.





# MRP Functionality

## Prerequisites for Material Requirements Planning

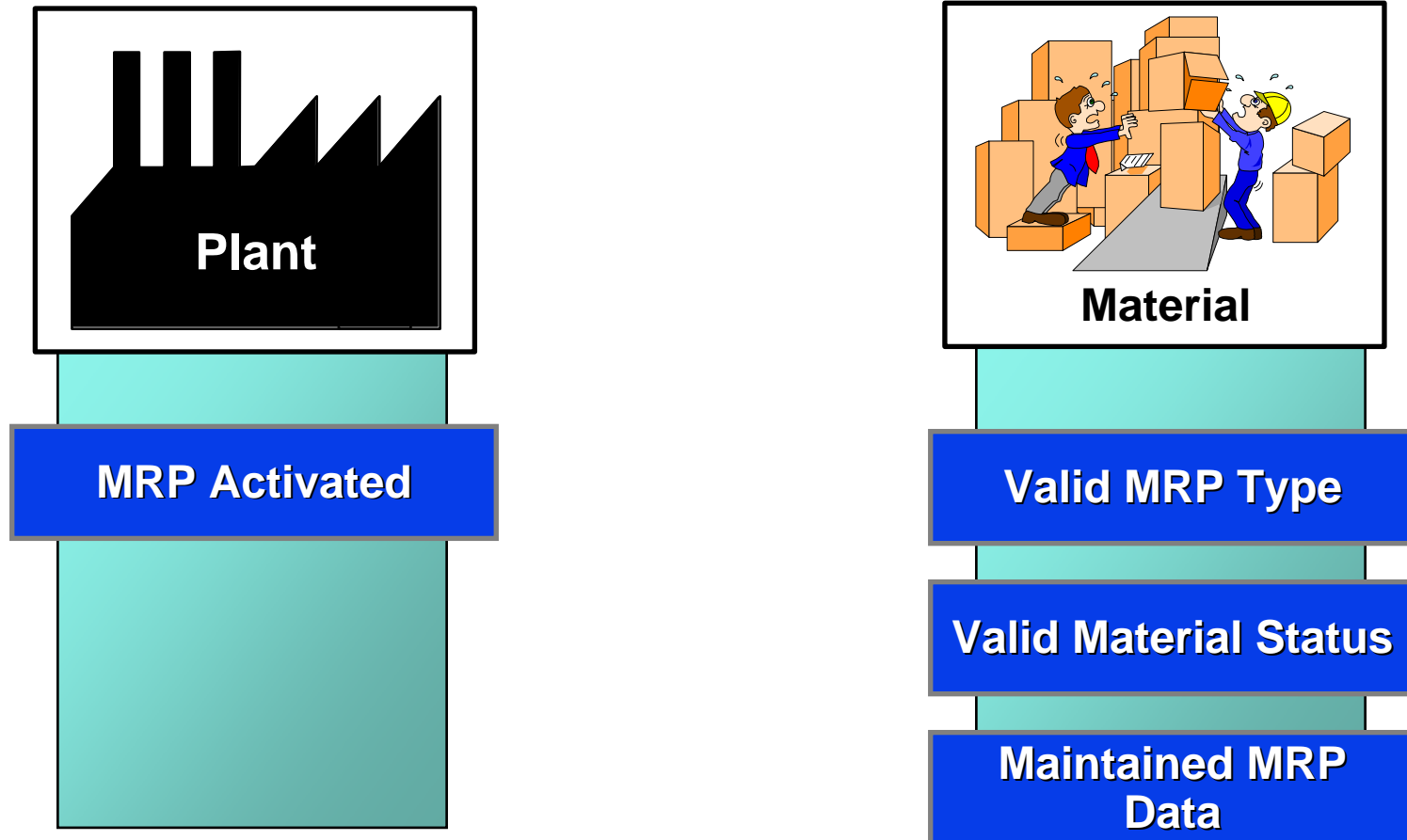



# MRP Functionality

Master Data

Demand/ROP

MRP Process

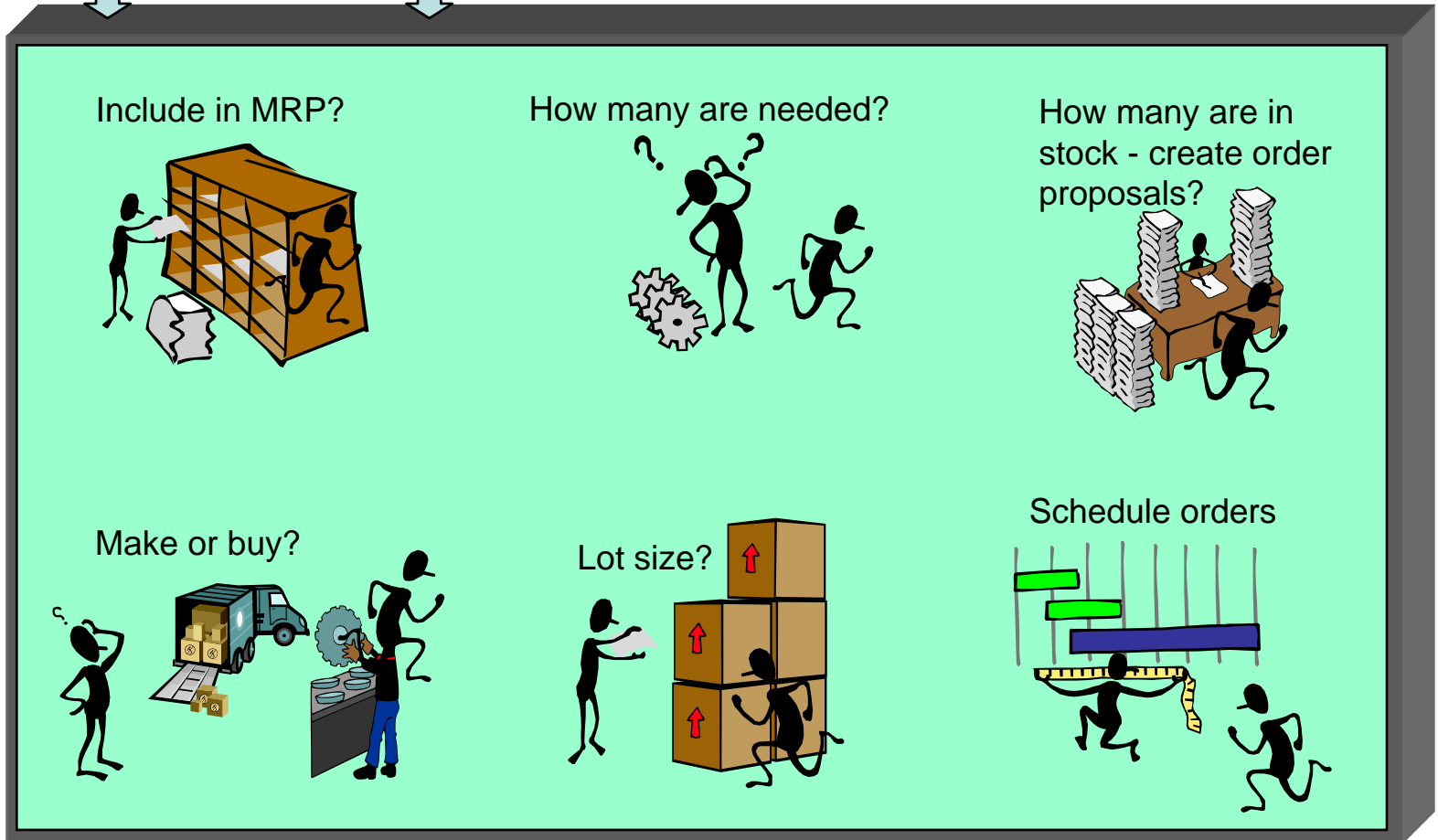

Stock/Requirements List

MRP List



# Key MRP Master Data



# Key MRP Master Data

## MRP Type

- A key that controls the MRP procedure (deterministic MRP or reorder point) to be used for planning a material
- It contains additional control parameters (e.g., for using the forecast for the materials planning and for firming procurement proposals)
- Is plant specific to a material or MRP area



# Key MRP Master Data

## Sample MRP Types

- For Plan Driven Materials:
  - **PD (MRP)** - This setting looks at real-time demand placed on a material to calculate the necessary requirements
- For most consumable materials, there are several options:
  - **VB (Standard Reorder Point Planning)** – You define a reorder point and the system will ONLY check your ACTUAL INVENTORY to determine if you are BELOW this reorder point
  - **VM (Automatic Reorder Point Planning)** – System calculates the safety stock level and reorder point quantity dynamically based on the statistical forecast
  - **V1 (Reorder Point Planning with external requirements)** – You define a reorder point and the system will look at inventory as well as actual firm requirements within lead-time
- For Materials that do not require any planning:
  - **ND (No Planning)** – Example, reusable materials, obsolete materials, etc.



# Key MRP Master Data

## Lot-sizing Procedure

- Is used to calculate the purchase order and production order quantities (lot sizes)
- Are divided into three groups
  - Static
  - Period
  - Optimum



# Key MRP Master Data

## Sample Lot-sizing Procedures

- **EX (Lot-for-Lot)** – looks at actual production lots and generates quantity requirements based on these production schedules
- **FX (Fixed Lot)** – uses a fixed quantity strategy that will always be proposed when a requirement is generated
- **HB (Replenish to Max Stock Level)** – uses a strategy that will look at current stock level and replenish back to a max level – Min/Max
- **TB (Daily lot-size)** – groups requirements by the day
- **WB (Weekly lot-size)** – groups requirements by the week



# Key MRP Master Data

## Special Procurement Keys

- An indicator in the material master record that defines external procurement or in-house production of the material more precisely
- Examples of possible special procurement types are
  - Stock transfer
  - Production in another plant
  - Vendor consignment





# Key MRP Master Data

## Lead Time Elements

- Number of calendar days needed to obtain the material or service
  
- Total lead time has the following elements
  - Purchasing processing time
  - Planned delivery time
  - Goods receipt processing time



# Key MRP Master Data

## MRP Area

- An organizational unit within a plant for which you can carry out material requirements planning separately
- Can include one or several storage locations within a plant
- Can be used to manage inventory items supplied to a subcontractor for assembly activities
- By defining MRP areas, you can carry out MRP specifically for each area
  - **a particular production line**
  - **separate storage locations**
  - **subcontractor stock**



# **MRP ORGANIZATIONAL DATA**



# Key MRP Org Data

Simple MRP functionality is available at the Storage Location level.

## Planning at Plant Level

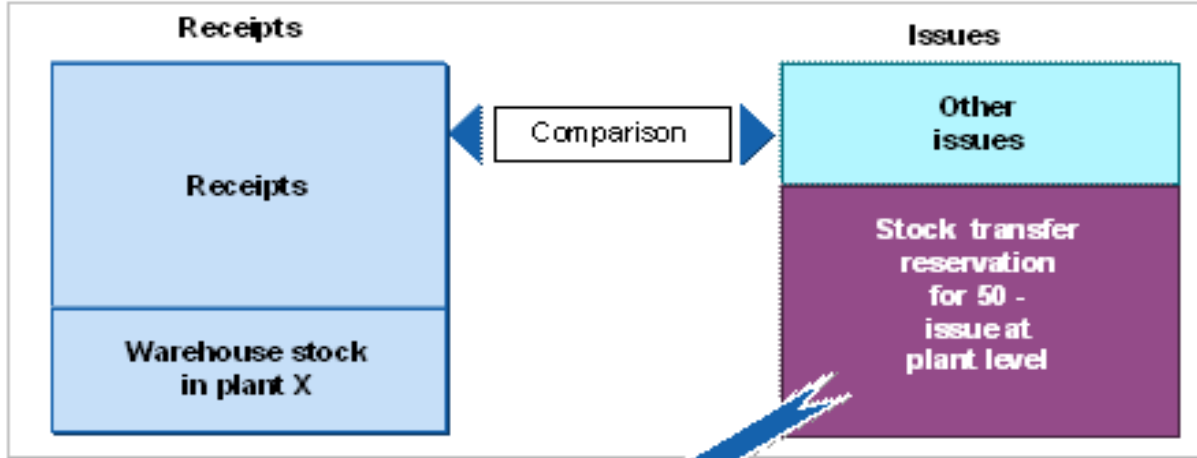

## Planning at Storage Location Level

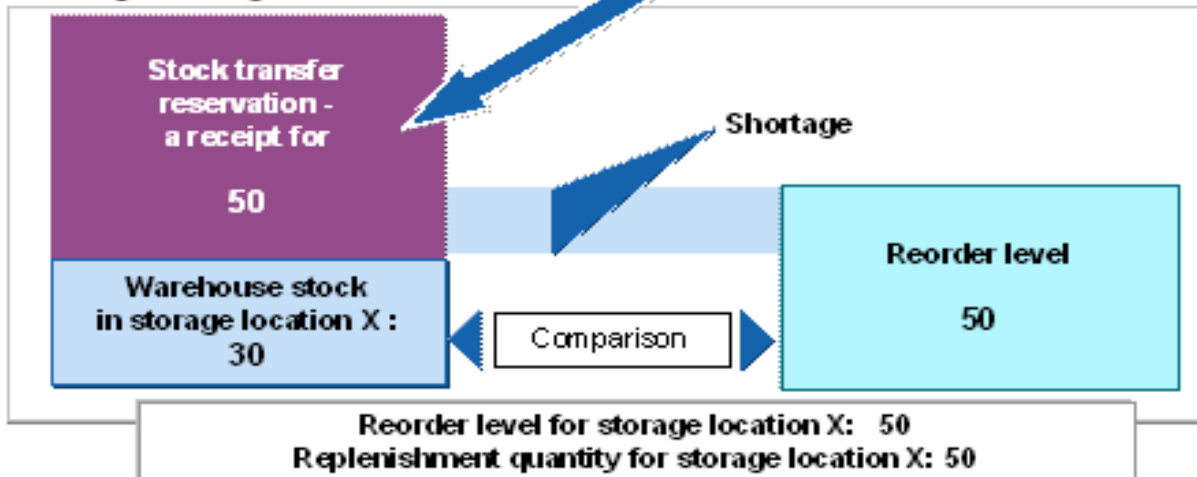

For storage location X, the reorder level was set to 50 pieces.

Since stock at the storage location X (30) has fallen below the reorder level, a stock transfer reservation amounting to the fixed lot size (50) was created.

At the same time, this stock transfer reservation produced an issue at the plant level for the same amount.



# Key MRP Org Data

## Stock Transfer from Plant to MRP Area

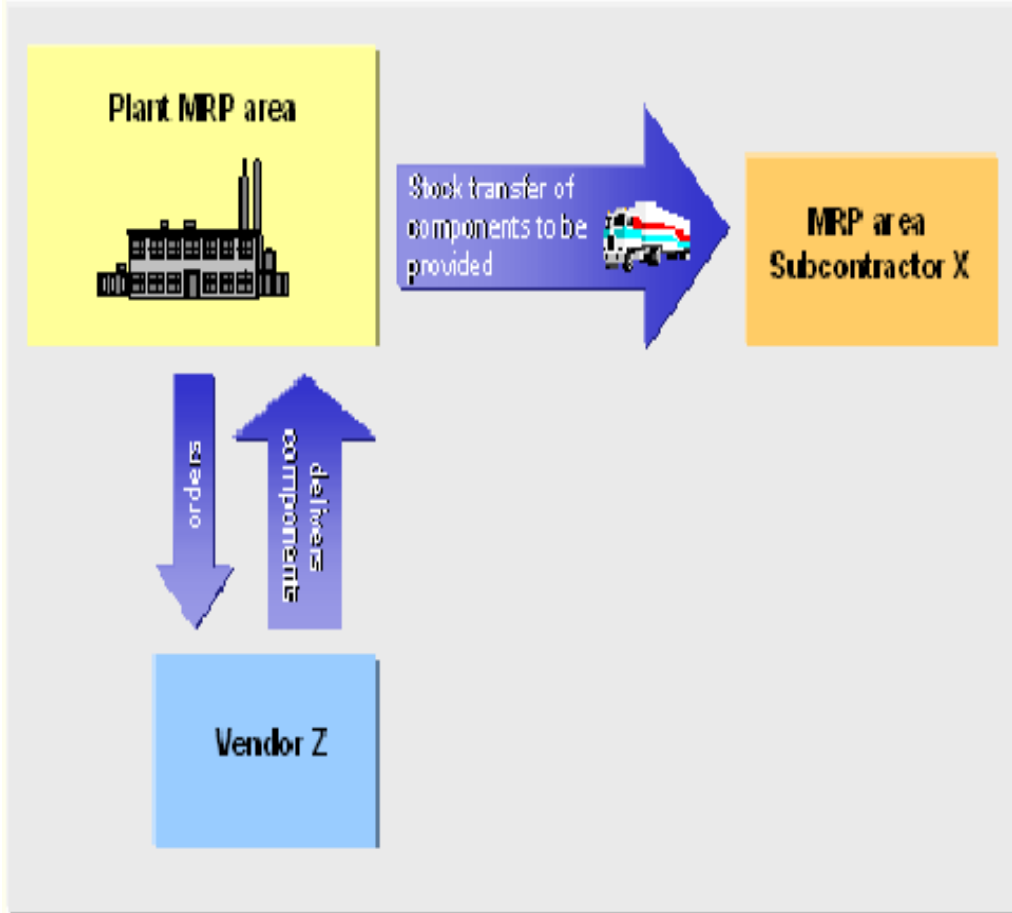

- If you want to plan material requirements for a storage location separately, you can create an MRP area for this storage location. You can then procure materials that are planned for this MRP area using *Stock transfer from plant to MRP area*.
- If you plan components to be provided for a subcontractor using an MRP area of the *subcontractor* type, you can also procure the components to be provided using *Stock transfer from plant to MRP area*.
- ***The process is the same as for Storage Location MRP. However, in contrast to the storage location MRP, you can use all MRP procedures and are not limited to the reorder point planning procedure.***



# Key MRP Org Data

## MRP Controller

- An element assigned to the material master that signifies an individual responsible for the management of the material.
- By assigning different MRP controllers to different materials you can assign the responsibility for managing specific groups of material to specific people. The assignment can typically be aligned with
  - **Group of suppliers**
  - **Commodities**
  - **Geographical locations**

<b>MRP CONTROLLER 1</b>	<b>MRP CONTROLLER 2</b>
<b>Office Supplies</b>	<b>Janitorial</b>
<b>Envelopes</b>	<b>Safety Supplies</b>
<b>Forms</b>	<b>Light Bulbs</b>



# **MRP Locations and Organizational Levels**



# Organizational Levels for MRP

How does the LaGov Org. entities map to MRP organizational levels?

What MRP functionality will be invoked and where?

What LaGov Org. entities will rely on manual inventory replenishment request?

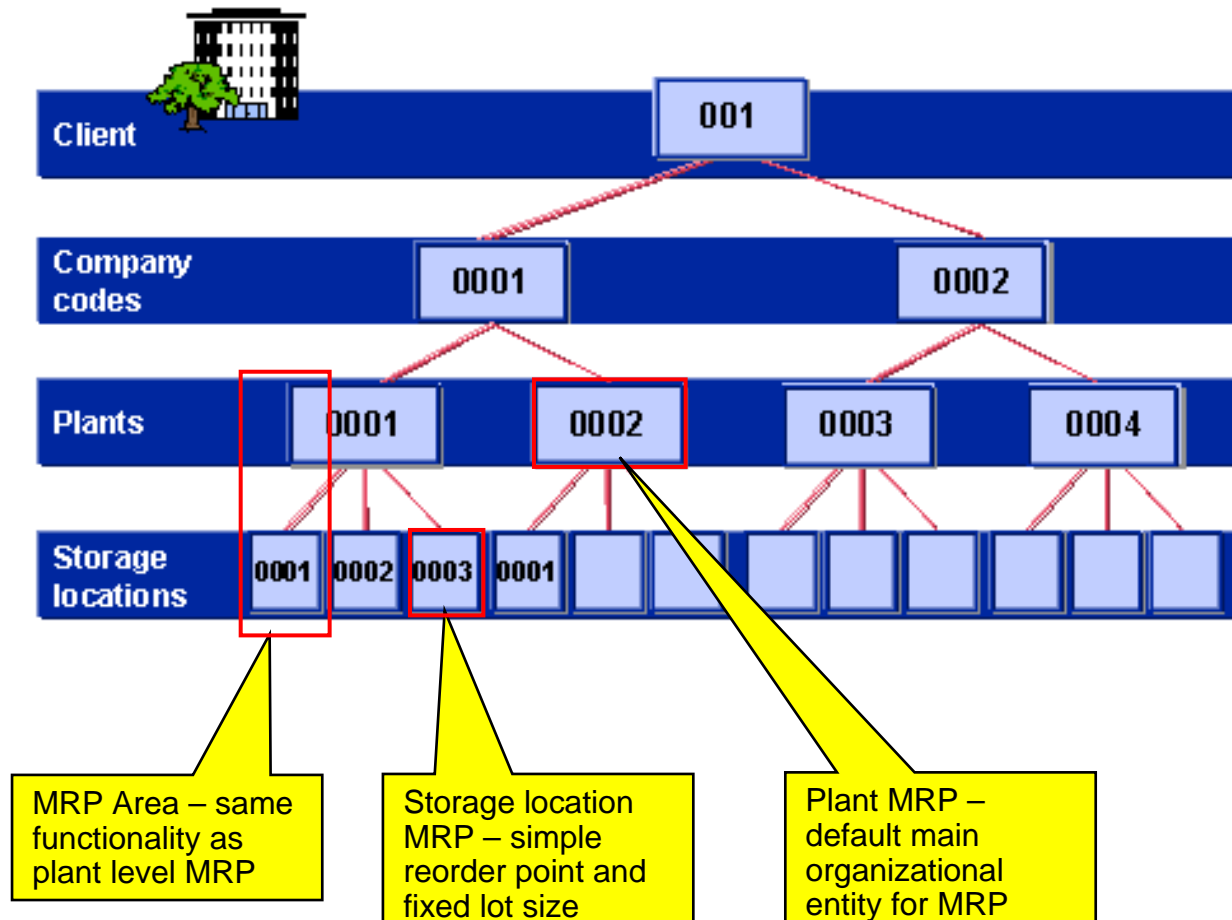





# MRP AREAS

**MRP Areas with associated storage locations.**

- MRP Areas has the same MRP functionality as plants including Min/Max
- MRP Area inventory is by default not visible to the District/Plant level MRP

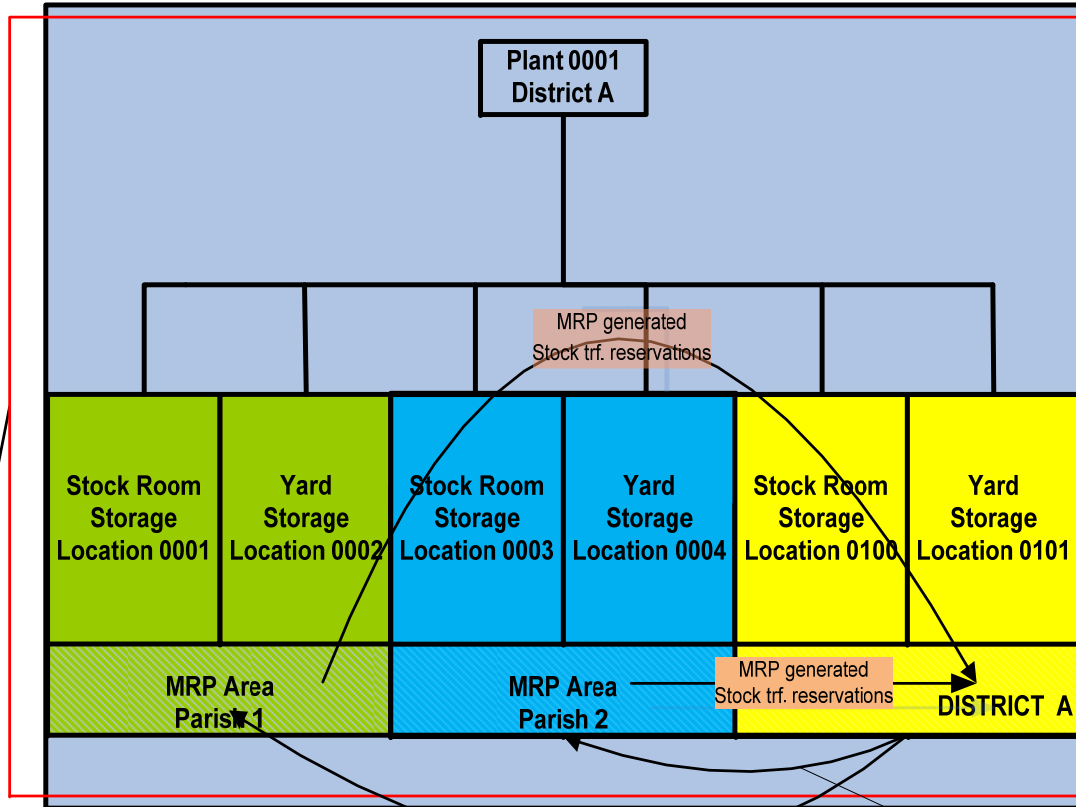

Materials are valued at plant level regardless of Storage Locations or MRP Areas

Stock Transfers will occur with respect to a stock transfer reservation between storage locations that are tied to a plant



# MRP - Storage Location

## Storage location MRP or storage location excluded from MRP

- Storage location MRP does not have full plant MRP functionality – only simple reorder point and fixed replenishment qty
- If no MRP at Parish level the Material/Storage Location have to be excluded from MRP so inventory will not be taken into account at Plant/District level MRP

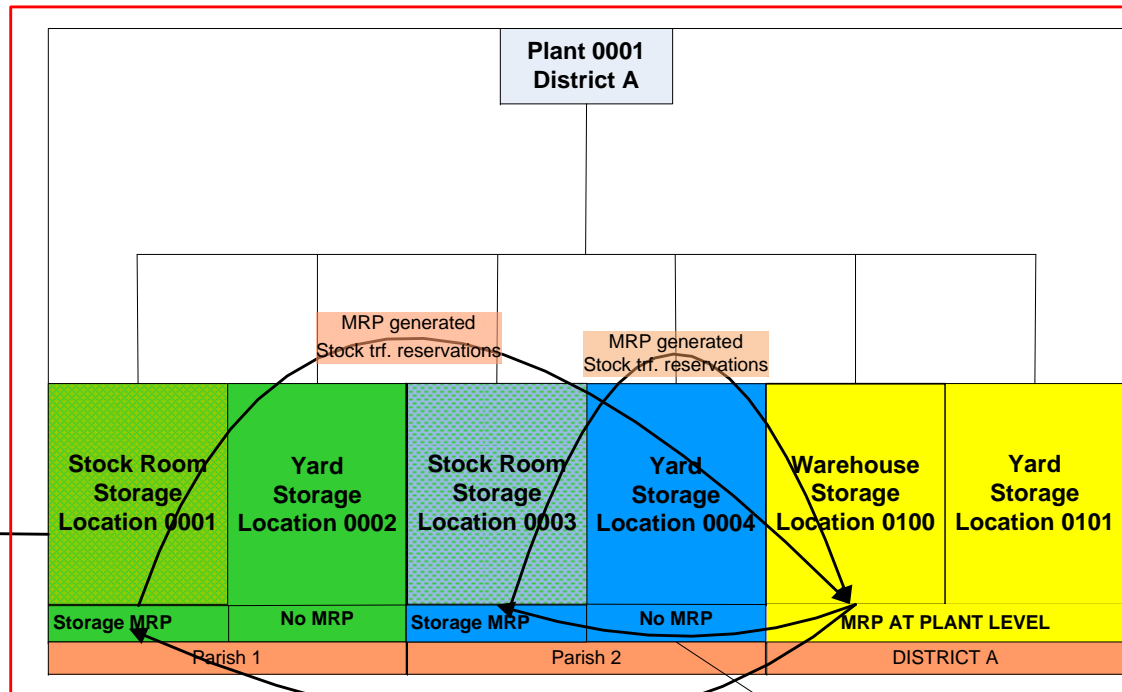

Materials are valued at plant level regardless of Storage Locations or MRP Areas

Stock Transfers will occur with respect to a stock transfer between storage locations that are tied to a plant



# **Key Material Master MRP Fields**



# Key Material Master MRP Fields View 1

The screenshot shows the SAP Material Master MRP fields for material 138. The fields are organized into several sections:

- General Data:** Base Unit of Measure (EA), MRP group, Purchasing Group, ABC Indicator, Plant-sp.matl status, Valid from.
- MRP procedure:** MRP Type (VM), Reorder Point (25), Planning cycle, Planning time fence, MRP Controller (001).
- Lot size data:** Lot size (TB), Daily lot size, Minimum Lot Size, Fixed lot size, Ordering costs, Assembly scrap (%), Rounding Profile, Unit of Measure Grp, Maximum Lot Size, Maximum stock level, Storage costs ind., Takt time, Rounding value (10).

Annotations point to the following fields:

- MRP Type:** VM (Plan driven or Consumption driven)
- Reorder point:** 25 (Can be set manually, Can be calculated by the forecast)
- MRP Controller:** 001 (Key to segregation of MRP reports)
- Lot-size Key:** TB (Fixed lot-size, Min/Max, Period lotsize)
- Max stock level:** 10 (Needed if Min/Max)



# Key Material Master MRP Fields

## View 2

**Special Procurement Key**

- Needed for stock transport orders

**Storage Location for External Procurement**

- Default storage location that defaults into purchase order

**Planned Delivery Time**

- Time from purchase order issuance until it arrives at the receiving dock

**Goods Receipt Processing Time**

- Time from receipt against purchase order until material has been inspected and putaway

**Service Level**

- Parameter in calculation of the safety stock. The higher the service level the higher the safety stock will be.

**Safety Stock**

- Can be set manually
- Can be calculated by the forecast



# Key Material Master MRP Fields View 3

The screenshot displays the SAP Material Master MRP View 3 for Material 138. The interface includes a menu bar (Material, Edit, Goto, Environment, System, Help), a toolbar, and a title bar (Change Material 138 (Trading goods)). The main content area is divided into several sections:

- Forecast Requirements:** Period Indicator (M), Fiscal Year Variant, Splitting Indicator.
- Planning:** Strategy group, Consumption mode, Fwd consumption per., Planning material, Ping conv. factor, Bwd consumption per., Mixed MRP, Planning plant, Planning matl BUnit.
- Availability check:** Availability check (02), Tot. repl. lead time (days), Cross-project.
- Plant-specific configuration:** ConfigurableMaterial, Variant, Planning variant, Configure variant, Configure planning variant.

A text box on the right side of the screen contains the text: "Probably will not need to maintain any fields on this screen".



# Key Material Master MRP Fields View 4

**Storage Location MRP Indicator**

- Included in plant MRP
- Can be excluded from plant MRP
- Can be planned separately

**Special Procurement Key**

- Used only if special procurement type is needed for the storage location

**Replenishment Quantity**

- Similar to fixed lotsize at plant level - only if storage location is planned separately

**Reorder Point**

- Only if storage location is planned separately



# Statistical Forecasting





# Statistical Forecast

## Consumption-Based Planning

### Purpose

The central role of MRP is to monitor stocks and, in particular, to automatically create procurement proposals for purchasing and production (planned orders, purchase requisitions or delivery schedules). This target is achieved by using various materials planning methods which each cover different procedures.

**Consumption-based planning** is based on **past consumption values** and uses the forecast or other statistical procedures to determine future requirements. The procedures in consumption-based planning do not refer to the master production schedule. That is, the net requirements calculation is not triggered either by planned independent requirements or dependent requirement. Instead, it is triggered when stock levels fall below a **predefined reorder point** or by **forecast requirements** calculated using past consumption values.

### Implementation Considerations

Consumption-based planning procedures are simple materials planning procedures which you can use to achieve set targets with relatively little effort. Therefore, these planning procedures are used in areas without in-house production and/or in production plants for **planning both B- and C-parts** and **operating supplies**.

### The prerequisites for implementing consumption-based planning are

- If you use forecast requirements, the consumption pattern should be fairly constant or linear with few irregularities
- Your Inventory Management must function well and should always be up-to-date



# Statistical Forecast

## Principles of First-Order Exponential Smoothing

- The older the time series values, the less important they become for the calculation of the forecast
- The present forecast error is taken into account for the following forecasts

How quickly the forecast reacts to a change in consumption pattern depends on what value you give the smoothing factor. If you set alpha to 0, the new average is equal to the old one and the basic value calculated previously remains; that is, the forecast does not react to current consumption data. If you give alpha the value 1, the new average equals the last consumption value.

The most common values for alpha lie between 0.1 and 0.5. An alpha value of 0.5 weights past consumption values as follows

1st historical value : 50%

2nd historical value : 25%

3rd historical value : 12.5%

4th historical value : 6.25%

and so on.

The weightings of past consumption data can be changed by one single parameter. Therefore, it is relatively easy to respond to changes in the time series.

The constant model of first-order exponential smoothing derived above is applicable to time series that do not have trend-like patterns or seasonal-like variations.



# Statistical Forecast

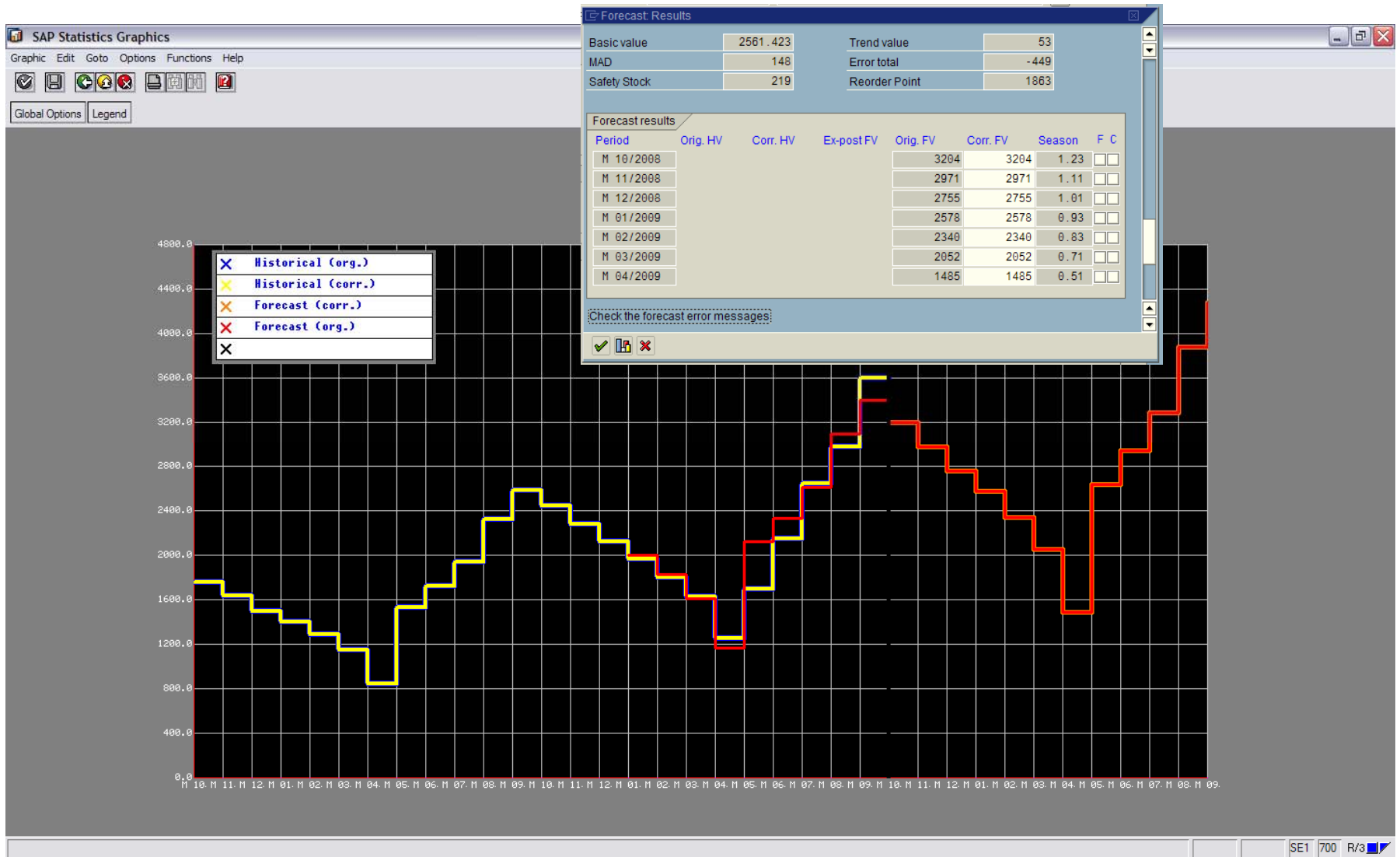



# Key Forecast Master Data

## Forecast Model

- Indicator that defines on which forecast model the system bases its calculation of future requirements of the material
- You can either choose a model manually or have the system test for and determine the model that fits the past consumption best

## Period Indicator

- Indicator specifying the periods in which the material's **consumption values** and **forecast values** are managed
- Typical values would be
  - **Monthly**
  - **Weekly**
  - **Daily**



# Key Forecast Master Data

## Historical Periods

- The number of historical values the system uses for the forecast

## Initialization Periods

- Number of historical values that you want to be used for initialization
- A minimum of 3 values for initialization of a simple constant model are required



# Key Forecast Master Data

## Forecast Periods

- Number of periods for which a forecast should be created

## Periods Per Season

- Number of periods in a seasonal cycle



# Key Forecast Master Data

## Initialization

- Indicator which specifies that the system should initialize a forecast model
- Calculates the parameters that are needed for the model such as basic value, trend value, and seasonal indices

## Model selection

- Indicator used in forecast model selection that specifies whether the system checks the historical values for
  - **Trend only**
  - **Seasonal fluctuations only**
  - **Trend and seasonal fluctuations**



# Key Forecast Master Data

## Optimization Level

- Specifies the increment by which the system optimizes the forecast parameters
- The finer the degree of optimization, the more exact but more time consuming in terms of system resource load

## Tracking Limit

- Value that specifies the amount by which the forecast value may deviate from the actual value
- When a forecast is run, the system compares the tracking limit with the tracking signal, which calculates internally
- This comparison helps you monitor the accuracy of the forecast







# Key Forecast Master Data

## Reorder Point

The reorder level is defined as the sum of the safety stock plus the requirement forecast within the replenishment lead time.

**EXAMPLE:** A forecast was carried out on a monthly basis. A month has 30 days in the case of external procurement.

Safety stock		100
Forecasted Consumption	Qty. issued 1st subsequent mo.	300
	Qty. issued 2nd subsequent mo.	300
	Qty. issued 3rd subsequent mo.	300
Replenishment lead time	40 days	30/30 days (1 mo.) + 10/30 days (1/3 mo.)

Replenishment lead time = 40 days

(An entire monthly requirement (30/30 days) + a part of the following month (10/30 days))

100 (Safety Stock)  
+ 300 (30 days or 1 mo. Supply)  
+ 100 (10 days or 1/3 of 1 mo. Supply)  
= 500 (Reorder level)



# Statistical Forecast

**Forecast model**

- Manually specified or
- Automatic selection

**Period indicator** – most likely monthly buckets.

**Number of historical periods** – 60 is defaulted but system only uses periods with actual values.

**Forecast periods** – number of periods the forecast is going into the future.

**Periods per season** – Number of periods for a seasonal cycle – usually 12 months.

**Initialization** – usually system initialization but can be set to manual as well.

**Tracking limit**– used to determine if the statistical model is still valid.

**Model selection** – test for season and /or trend.

**Optimization** – low/medium/high

**Smoothing factors** – determines how responsive the forecast is to changes in consumption vs forecast

General data			
Base Unit of Measure	EA	Forecast model	J
Last forecast		Period Indicator	M
RefMat: consumption		Fiscal Year Variant	
Date to		RefPlant: consumption	
		Multiplier	

Number of periods required			
Hist. periods	60	Forecast periods	12
Initialization pds	24	Fixed periods	
		Periods per season	12

Control data			
Initialization	X	Tracking limit	4.000
Model selection	A	Selection procedure	1
Optimization level	F	Weighting group	
Alpha factor		Beta factor	
Gamma factor		Delta factor	



# Statistical Forecast

## First-Order Exponential Smoothing

- Exponential smoothing methods are the most widely accepted time series techniques in use today. They were originally called "exponentially weighted moving averages." The basic premise of single exponential smoothing is that the sales values for more recent periods have more impact on the forecast and should therefore be given more weight, while the weights for older periods will decrease at an exponential rate. In addition, because the calculations require more recent sales history, data storage is minimized (or at least reduced) as a result of the minimal historical data required.
- First-order exponential smoothing, also known as single exponential smoothing, uses a smoothing constant (alpha) to which a value between 0 and 1 is assigned. The larger its value (closer to 1), the more weight it assigns to recent sales history. A large alpha (.8) is comparable to using a small number of time periods (n) in a moving average model. A small n allows greater emphasis to be placed on recent periods. Conversely, a small alpha (.1) is similar to using a large number of time periods in the moving average, because the impact of recent data is lessened.
- The strengths of exponential smoothing models are that they:
  - Are reasonably simple to understand and use
  - Provide more weight to recent data periods
  - Do not require much data storage
  - Have fairly good accuracy for short-term forecasts (one to three periods out into the future)
- The weaknesses of exponential smoothing models are that:
  - A great deal of research may be required to find the correct alpha value
  - They are usually weak models to use for medium or long-range forecasting (three periods and beyond)
- Forecasts can be thrown into great error because of large random fluctuations in recent data. Because they rely heavily on past history and on a smoothing factor to predict the future, exponential smoothing models cannot easily predict turning points in recent data. At least one to three periods are usually needed to correct for extreme fluctuations in recent data.



# Statistical Forecast

## Second-Order Exponential Smoothing

- The method of first-order exponential smoothing is theoretically appropriate when the data series contains a horizontal pattern (that is, it does not have a trend). If first-order exponential smoothing is used with a data series that contains a consistent trend, the forecasts will trail behind (lag) that trend. Second-order exponential smoothing, also known as Holt's linear exponential smoothing, avoids this problem by explicitly recognizing and taking into consideration the presence of a trend. It prepares a smoothed estimate of the trend in a data series.



# Questions?

