

MSE Wall Design and Construction Policy Updates

Anne Rearick
Bridge Director, INDOT

Athar Khan
Manager, INDOT Office of
Geotechnical Services

March 7, 2017



Overview

- **Background**
- **Design Memo 17-03**
- **Preconstruction Review**
- **Shop Plan Review**
- **Construction**
- **Materials Inspection**
- **Field Inspection Checklist**
- **Questions**



MSE Wall Problems



Site Drainage



Bulging Panels



Backfill Leakage

MSE Walls

Term “MSE” : Mechanically Stabilized Earth

Types of MSE walls:

- Modular block wall: Typical extensible reinforcement
- Precast concrete panel type of wall: Uses both extensible or inextensible reinforcement

Note: Current Indiana specification only allows inextensible reinforcement with precast concrete panel type of MSE wall.



Typical Section Of MSE Wall

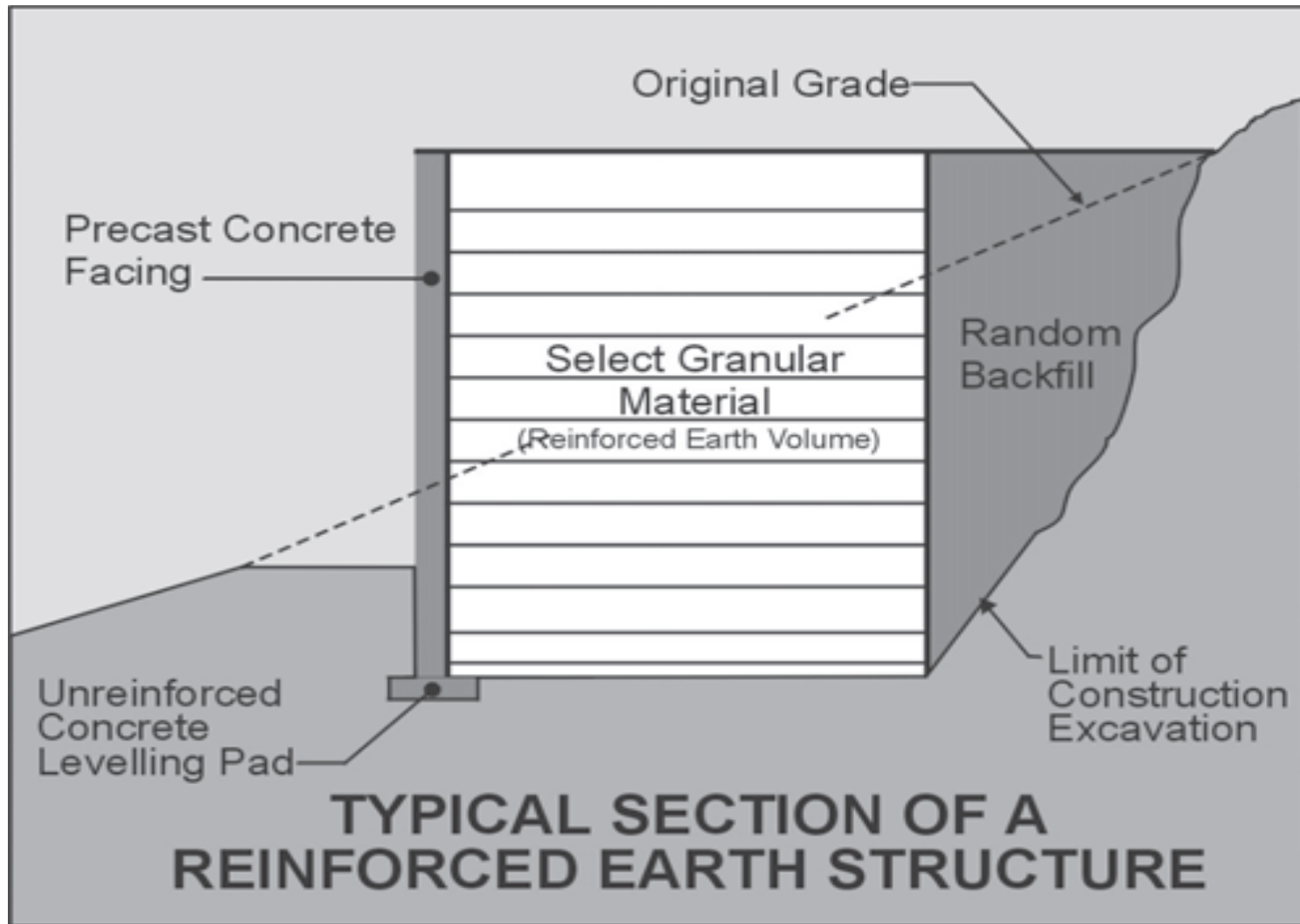

Roles and Responsibilities

Per INDOT Standard Specifications 731.03

- The internal and external stability shall be the responsibility of the contractor.
- The global stability will be the responsibility of the engineer.



MSE Wall

Design Memo 17-03

- Issued March 1, 2017
- Effective Immediately

Covers

- MSE Wall review process
- MSE Wall Suitability
- IDM Revisions
- Plan Requirements



MSE Wall Review Process

Stage of Plan Development (as of the date of the memo)	Review by Geotechnical Services?	When to Submit	Information to Submit
Prior to Stage 1	Yes	Concurrent with Geotechnical Investigation Request	Stage 1 plans, including preliminary wall layout.
After Stage 1 and Before Stage 3	Yes	Immediately	Current plan set or Title Sheet, Plan and Profile, Detail Sheets*
After Stage 3	Yes, where guidance below has not been accounted for in the plans.	Coordinate with Geotechnical Services immediately	As determined during coordination with Geotechnical Services
* Detail sheets include wall layout/geometry, wall section view, known obstructions, known foundation improvement requirements.			



MSE Wall Review Process

- Office of Geotechnical Engineering concurrence is required agreeing that the use of an MSE wall is suitable for projects that have not yet reached Stage 1.
- A second submittal at Stage 3 may be necessary if additional detail is required. This will be noted when the first review is returned.
- Revisions to plans based upon this memo will be expected for projects prior to Stage 3.
- Revisions to plans for projects beyond Stage 3 will be determined on a project to project basis with full coordination.



MSE Wall Suitability

Look for most economical solution

- MSE is often not the best option in cut or limited right of way situations
- Consider all possible alternatives
- Consider facing options
- Consider the effect of wall curvature



MSE Wall Suitability

Site drainage

- Consideration needs to be given to the flow of water on the site
- For walls constructed along a riverbank or in a floodplain the top of the leveling pad shall be at least 1 foot above the ordinary high water elevation. No. 8 stone shall be placed behind the wall instead of structure backfill up to the Q100 high-water elevation.



MSE Wall Suitability

Potential obstructions

- Utilities other than wall drainage
- Floodplain erosion and scour potential
- Potential corrosion of reinforcement due to contaminated ground water or other environmental considerations



MSE Wall IDM Revisions

IDM 402-6.02(02) Structure Sizing – Alignment

- Pile sleeves should be assumed where an end bent is placed behind an MSE wall.
- The minimum distance from the edge of the pile sleeve to the back of the MSE wall panel is 3 ft.



MSE Wall IDM Revisions

IDM 409-2.04(02) Integral End Bent – Design Requirements, 409-3.03 Semi-Integral End Bent, and Figure 409-2G

- Figure 409-2G illustrates the minimum distance from the edge of the pile sleeve to the back of the MSE wall panel and preferred MSE wall configurations at an end bent.



MSE Wall IDM Revisions

NOTE:

Coarse aggregate and 6" end-bent drain pipe are not required to be specified separately for an end bent placed behind an MSE Wall.

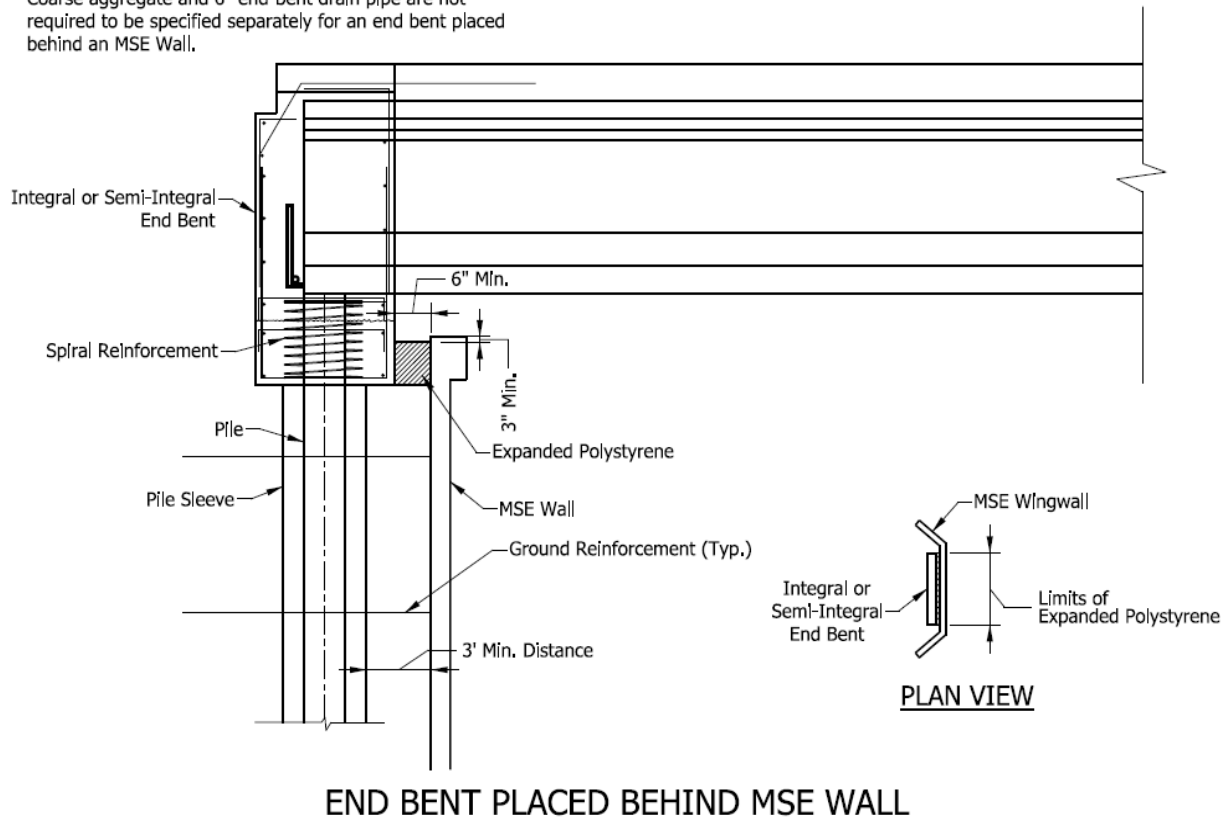
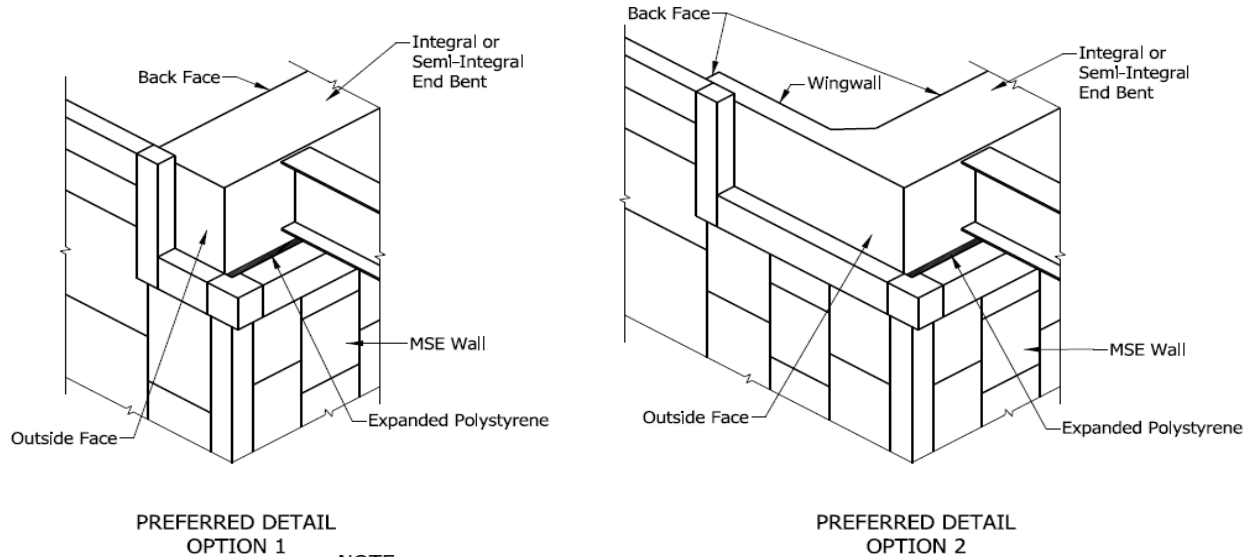

Figure 409-2G
(Sheet 1 of 2)

MSE Wall IDM Revisions



NOTE:

Where an MSE is placed parallel to the bridge approach roadway, it should be placed adjacent the outside face of the end bent or wingwall, but not cast against it. Sufficient clearance is needed to accommodate the thermal movement of the end bent. The MSE wall should not be placed abutting the back face of the end bent or wingwall.

END BENT PLACED BEHIND MSE WALL

Figure 409-2G
(Sheet 2 of 2)

MSE Wall IDM Revisions

IDM 410-5.01(06), Design Criteria

- Where two intersecting walls form an enclosed angle, the angle is to be greater than or equal to 70 degrees.
- Sharp curves should be avoided in the wall layout.
- Utilities should not be placed through the reinforced zone. Where utility placement in the reinforced zone is unavoidable, future access must be provided to the utility without disrupting the reinforcement.



MSE Wall IDM Revisions

IDM 410-5.01(07), Figure 410-5(0)C (New), Information to be Shown on Plans

- Drainage systems are required for all MSE walls. Figure 410-5(0)C illustrates a typical MSE wall cross sections and provides the drainage details to be included on plans.



MSE Wall IDM Revisions

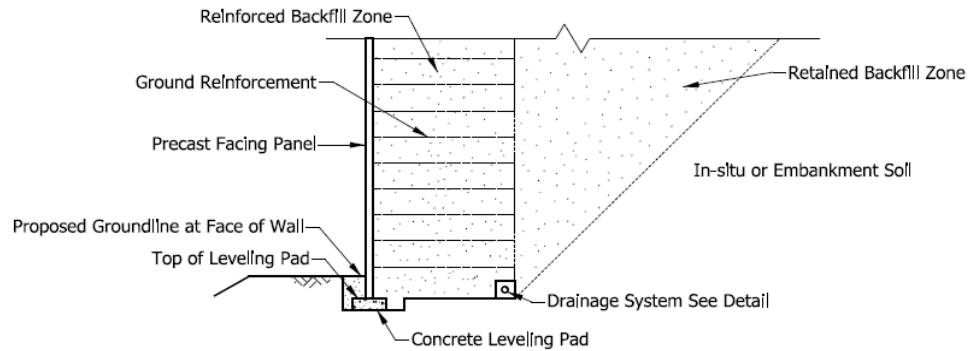

MSE SECTION VIEW

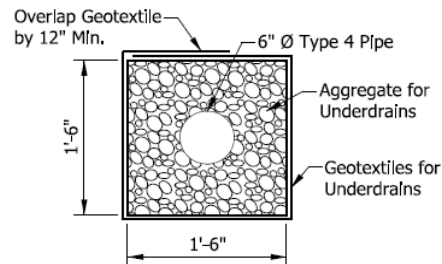

MSE WALL DRAINAGE DETAIL

TYPICAL MSE WALL CROSS SECTION

Figure 410-5(0)C

MSE Wall IDM Revisions

IDM 410-5.01(07), Figure 410-5(0)C (New), Information to be Shown on Plans (Cont.)

- A plan view showing all obstructions and their offset from the back of the MSE wall is required on the MSE Wall Details sheet. Obstructions include but are not limited to, piles, pile sleeves, catch basins, signal or sign foundation, guardrail posts, and culverts.
- Where an obstruction projects through the MSE wall panel, the obstruction should also be shown in an isolated section and elevation view.



MSE Wall IDM Revisions

IDM 410-5.01(07), Figure 410-5(0)C (New), Information to be Shown on Plans (Cont.)

- Modifications to the wall design to avoid obstructions must be shown in the MSE Wall working drawings. Design options for obstructions within the reinforced zone are described in the *AASHTO LRFD Bridge Design Specifications*, section 11.10.10.4.



MSE Wall IDM Revisions

IDM 410-5.01(07), Figure 410-5(0)C (New), Information to be Shown on Plans (Cont.)

- When an end bent is placed behind an MSE wall, expanded polystyrene should be shown for gap between the front face of the end bent and the back of the MSE wall. Do not show Styrofoam or extruded polystyrene.



Plan Requirements

- Show and label all obstructions
 - Plan view shall show the distance from the back of the panel.
 - Elevation view shall show all obstructions that project through a panel.
- Show all the details of ground improvement if specified in the Geotechnical Report
- Consider adding a section view
- Show site drainage



Example Drainage Problems



Preconstruction Review

- The plans and specifications
- The site conditions relevant to construction requirements
- Review of Geotechnical Report
- Material requirements
- Construction Sequences for the specific reinforcement system
- Shop Drawing Submittal & Approval



MSE Wall Shop Plan Review

■ Construction Memo 13-13 Revised (9/15/15)

Shop plans are to be sent to Burgess & Niple at shopplanreview@burgessniple.com. Their office phone number is 317-237-2760. Burgess & Niple will send approved shop plans to the INDOT Division of Bridges for distribution to the District Construction office. The contact for the INDOT Office of Bridge Design is George Snyder at gsnyder@indot.in.gov.

Mechanically Stabilized Earth (MSE) Retaining Walls

Shop plans and design calculations for MSE retaining walls are to be submitted by the contractor or fabricator directly to the designer of record for review and approval. MSE shop plans and design calculations must be stamped by a P.E. Upon receipt, the designer should forward an electronic copy of the shop drawings and design calculations to the INDOT Office of Geotechnical Services. Include the contract number as part of the subject line. The contact for the INDOT Office of Geotechnical Services is Athar Khan at atkhan@indot.in.gov. The INDOT Office of Geotechnical Services will review the design calculations and will provide comments back to the designer for inclusion in the response back to the contractor or fabricator. The designer will continue to provide the final approval of the MSE shop drawings and design calculations. The designer will attach a cover letter and send a copy of approved shop plans to the submitter and to the District Construction office for further distribution.

Sound Barrier Systems

Shop plans and calculations for sound barrier systems are to be submitted by the contractor or fabricator directly to the designer of record for review and approval. The plans and calculations



MSE Wall Shop Plan Review

Construction Memo 13-13 Revised (9/15/15)

- Shop plans and design calculations are to be stamped by a PE and are to be submitted to the designer of record
- The designer of record will forward a copy to the INDOT Office of Geotechnical Engineering
- The Office of Geotechnical Engineering will review and provide comments back to the designer of record
- The designer of record will provide the final approval



MSE Wall Shop Plan Review

Items to be considered

- Adherence to the AASHTO LRFD Design Specifications

- 11.10.1

.... When two intersecting walls form an enclosed angle of 70 degrees or less, the affected portion of the wall shall be designed as an internally tied bin structure with at-rest earth pressure coefficients.

- C11.10.10.4

The max splay of reinforcements is limited to a maximum of 15 degrees



MSE Wall Shop Plan Review

Items to be considered

- Treatment of obstructions
 - 11.10.10.4 addresses obstructions in the reinforced soil zone
 1. If reinforcement is to be partially or fully severed in the location of the obstruction, design the surrounding reinforcement layers to carry the additional load...
 2. Place a structural frame around the obstruction capable of carrying the load from the reinforcements...
 3. If the soil reinforcements consist of discrete strips and depending on the size and location of the obstruction, it may be possible to splay the reinforcements around the obstruction



There are currently 4 INDOT approved MSE wall vendors



Reinforced Earth Company



Sanders Pre-Cast Concrete Systems, Inc.



Sine Wall



Tricon Precast Ltd.

Sine Wave System to use rippled Strip



Each approved reinforcement has unique frictional and tensile capacities

Reinforcement-soil frictional capacity

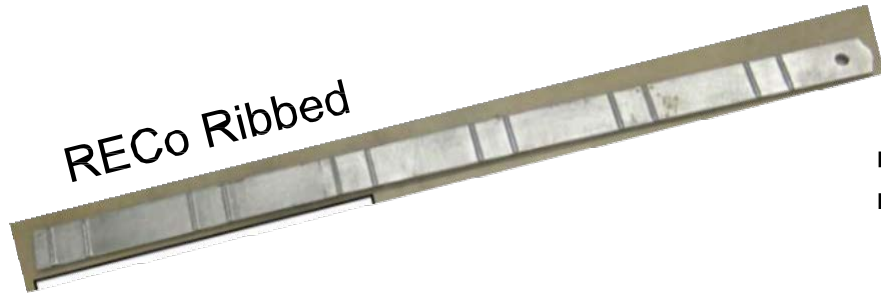

≠

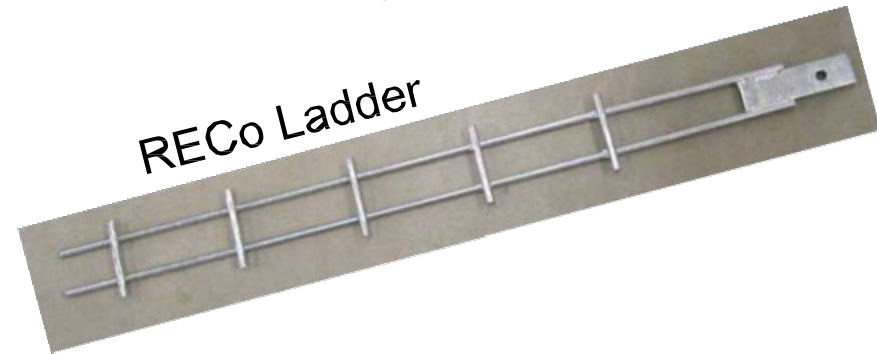

Reinforcement tensile strength



≠



MSE Wall



MSE Wall



Indiana Toll Road Improvement in Gary

MSE Wall



Materials Inspection

Prefabricated

- Precast Concrete Elements
- Reinforcing Elements

Other Materials

- Facing Joint Materials
- Reinforced backfill
- Retained backfill



Improper Panel Storage



Proper Panel Storage



Improper Storage of Reinforcement

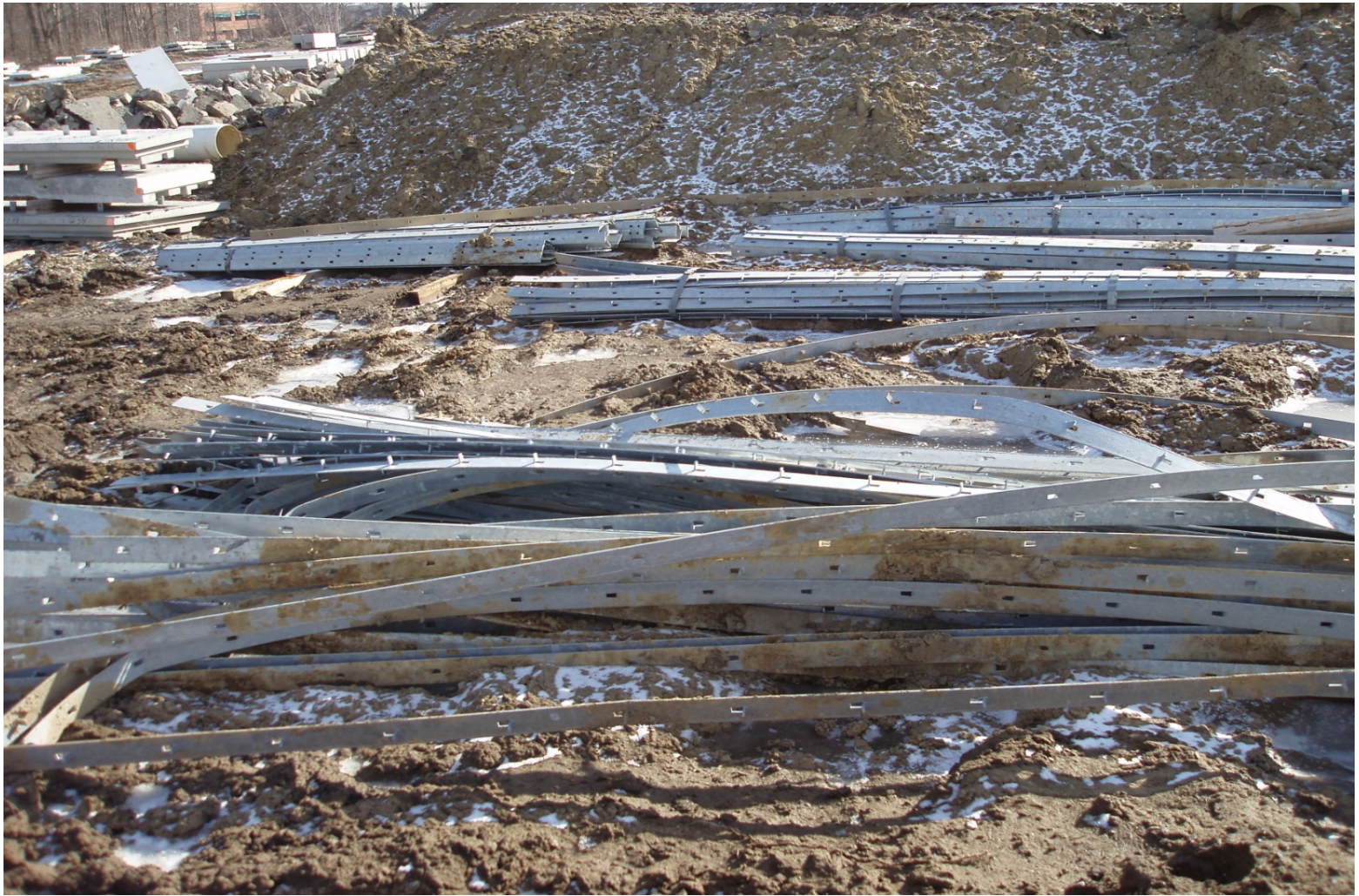

Proper Storage of Reinforcement



Joint Material



Joint Material



Backfill Material

- Type 3 structure backfill within reinforced backfill zone excluding # 30 sand meeting INDOT Specs
- Unit weight shall not be less than 120 pcf unless light weight is specified
- Internal friction angle (ϕ) of 34 degree for structure backfill within reinforced backfill zone
- "B" Borrow or structure backfill within retained backfill zone with Internal friction angle (ϕ) of 30 degree



Construction Control

- **Site Preparation**
- **Leveling Pad**
- **Erection of Facing Elements**
- **Reinforced Fill Placement and Compaction**
- **Placement of Reinforcing Elements**



Site Preparation

- Cut to grade
- Remove unsuitable material as specified
- Proof roll the entire footprint area of MSE wall to delineate any loose and/or unsuitable materials
- Compact any loose material and remove and replace any unsuitable material
- Perform DCP tests for verification



Excavation to Grade



Excavation to Grade



Leveling Pad

- **Excavate:** for leveling pad
- **Pour:** unreinforced concrete leveling pad as specified
- **Curing time:** at least 12 hrs before placing Panels
- **Vertical tolerance:** 3mm to design elevation
- **Improperly Placed Leveling Pad:** may result in panel misalignment, cracking, and spalling



Leveling Pad



Erection of Facing Elements

- Always begin adjacent to any existing structure and proceed toward the open end of the wall
- Horizontal joint material or wooden shims should not be permitted between the first course of panels and the leveling pad except for panel battering
- Vertical Backward Batter should not be more than 0.05 inch/foot of wall height



Erection of Facing Elements

- Use panel spacing bars for horizontal spacing between panels
- First row of panels must be continuously braced until several layers of reinforcements and backfill have been placed
- Adjacent panels should be clamped together to prevent individual panel displacement
- Since variety of panel types used on a project, facing element types must be checked to verify the installation exactly as shown on the plans



Erection of Facing Elements

Note: Numbers in squares show order of placement

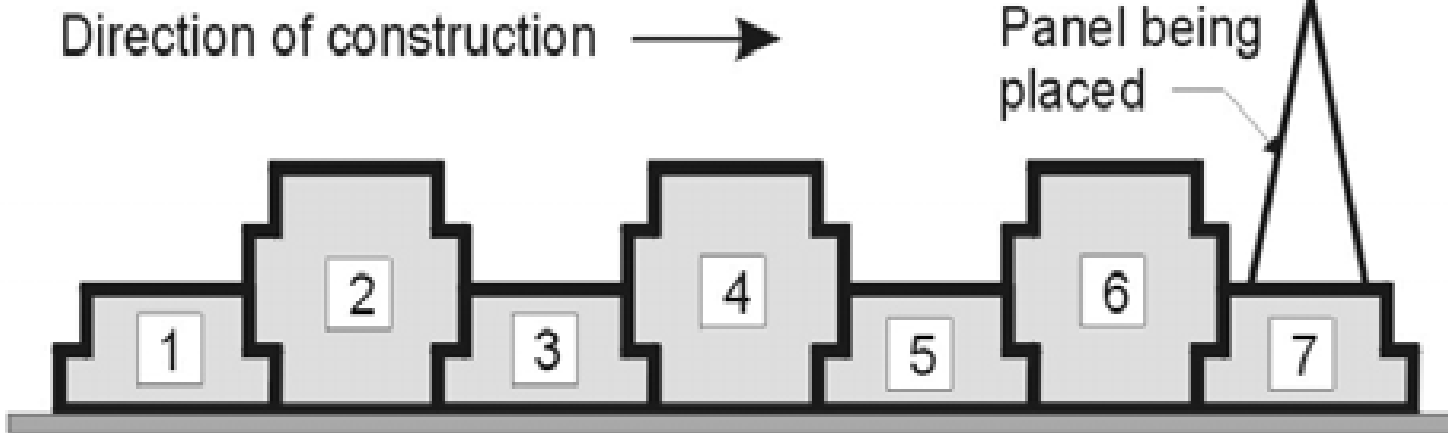

**USE OF 3/4" SPACER BLOCK
TO SET PANEL SPACING**

Leveling Pads at Panel Step-up

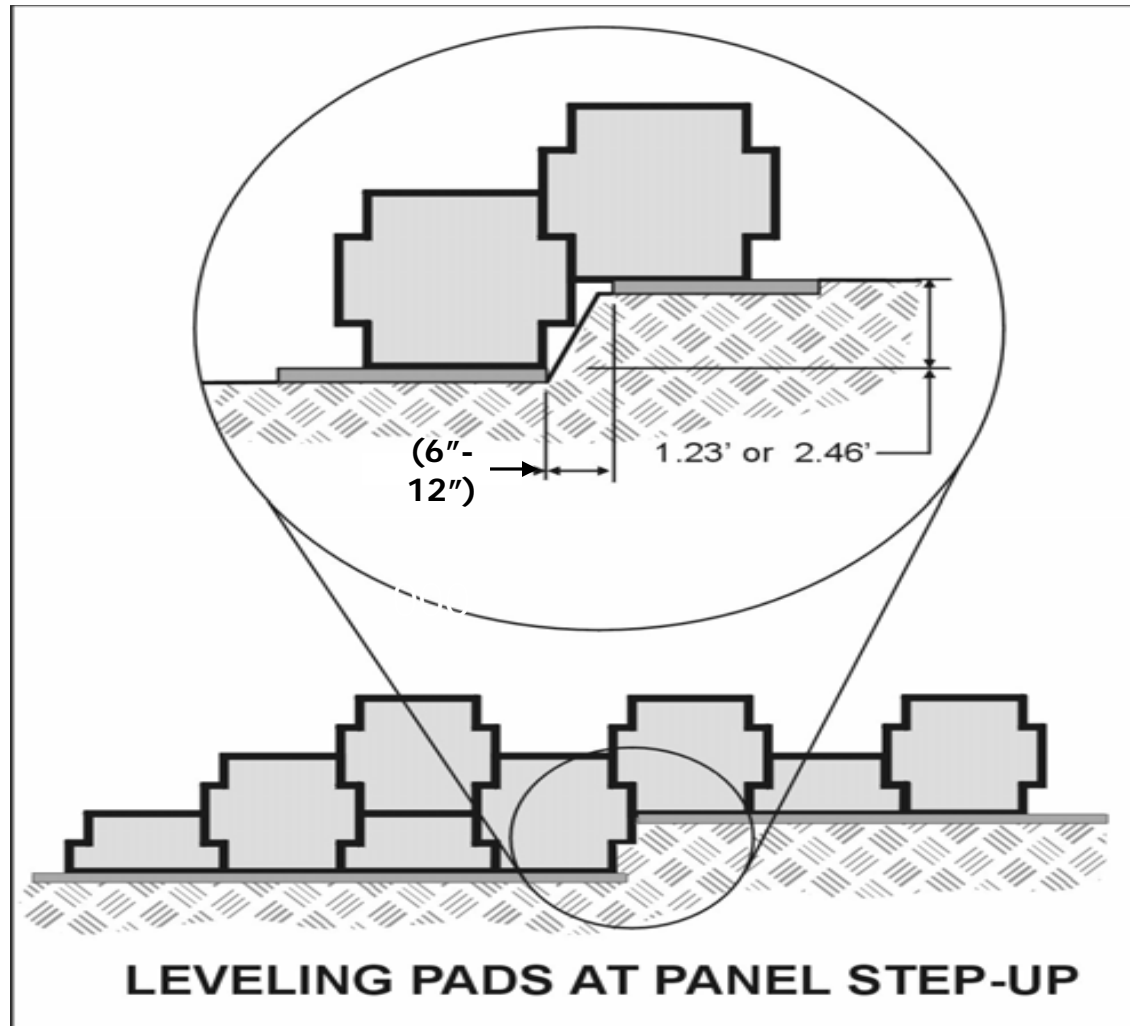

Erection of Facing Elements

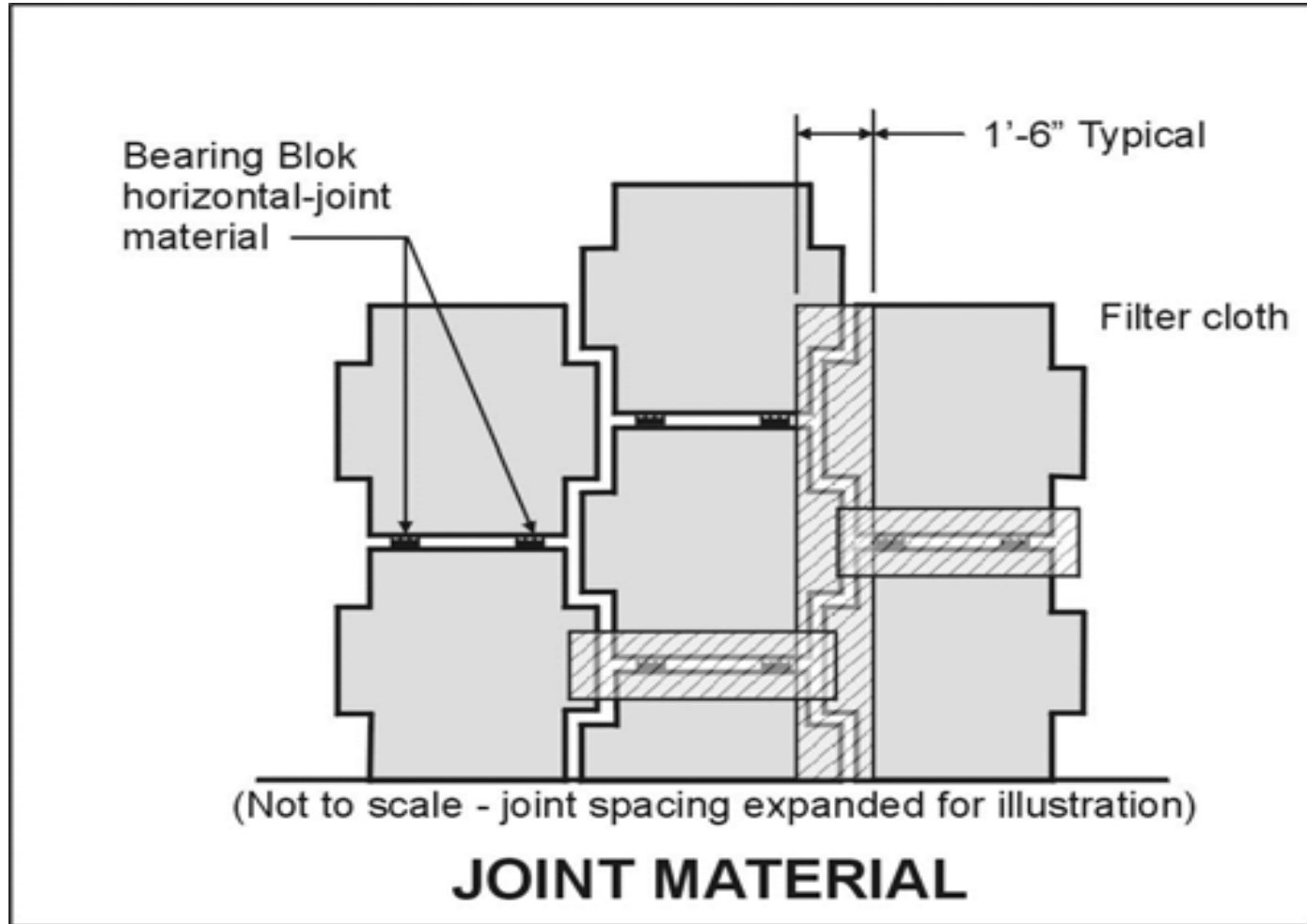

Erection of Facing Elements



Erection of Facing Elements



Reinforced Fill Placement/Compaction

- **Mark** your 6" compacted lift on the back side of the wall panels
- **Place backfill** parallel to the wall and starting approximately 3 feet from the back of wall panel
- **Level** the fill by machinery moving parallel to the wall, windrowing toward the reinforcement ends
- **Lock** the reinforcement and the panels in position
- **Place the backfill** not exceeding 5 " in loose thickness within 3 feet behind the wall by windrowing after locking the reinforcement



Reinforced Fill Placement Compaction

- **Compacting lift** not exceeding 5 " in loose thickness with a minimum of 5 passes using vibratory roller or plate weighing less than 1000 pounds
- **Except** for the initial layer the fill must be brought up uniformly for the whole layer
- **Soil layers** should be compacted up to or even slightly above the elevation of each level of reinforcement connections prior to placing that layer of reinforcement elements



Lift Thickness Marking on Facing Panel



Backfill Measurement Solution Template



Reinforced Fill Placement & Compaction

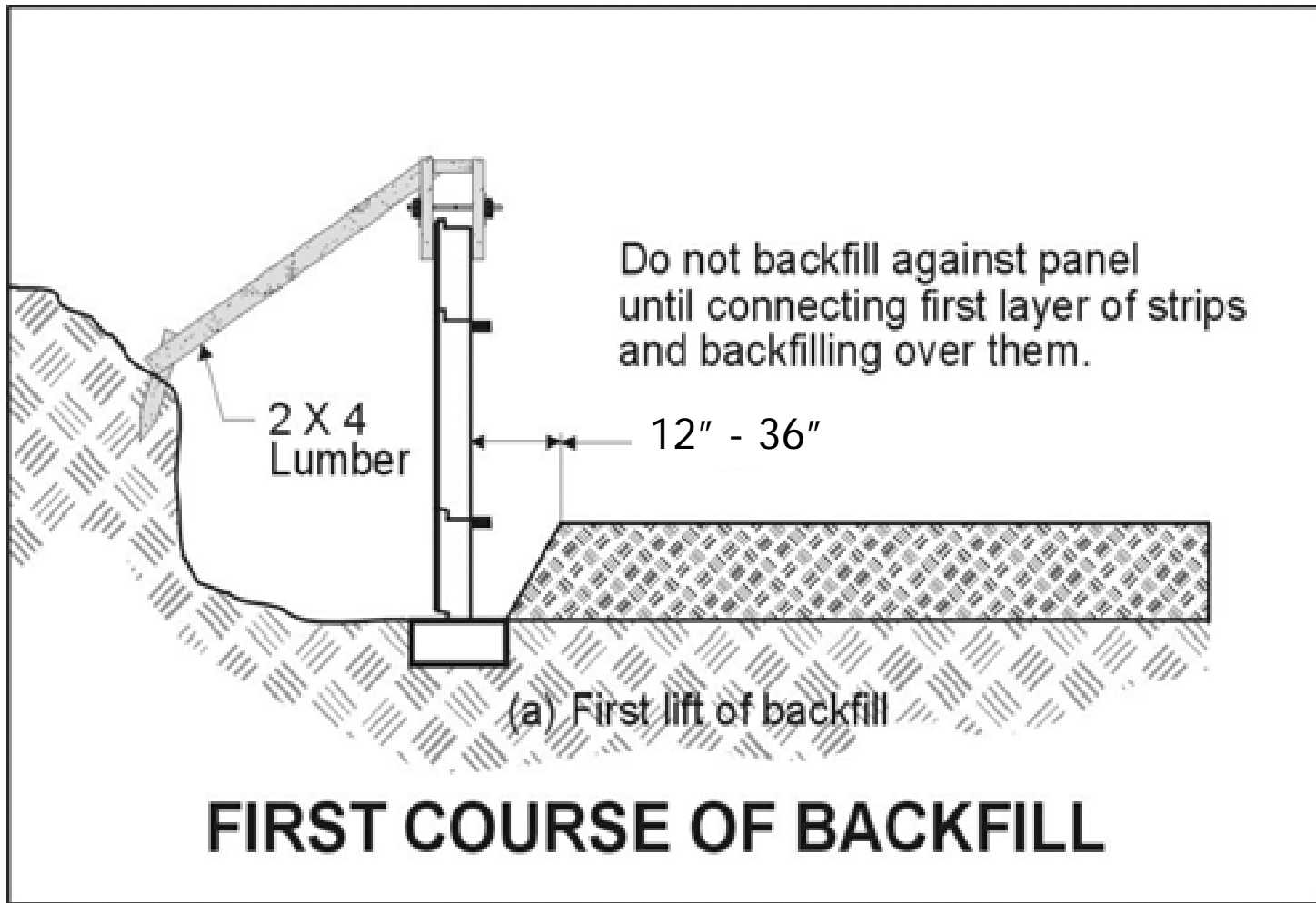

Reinforced Fill Placement & Compaction

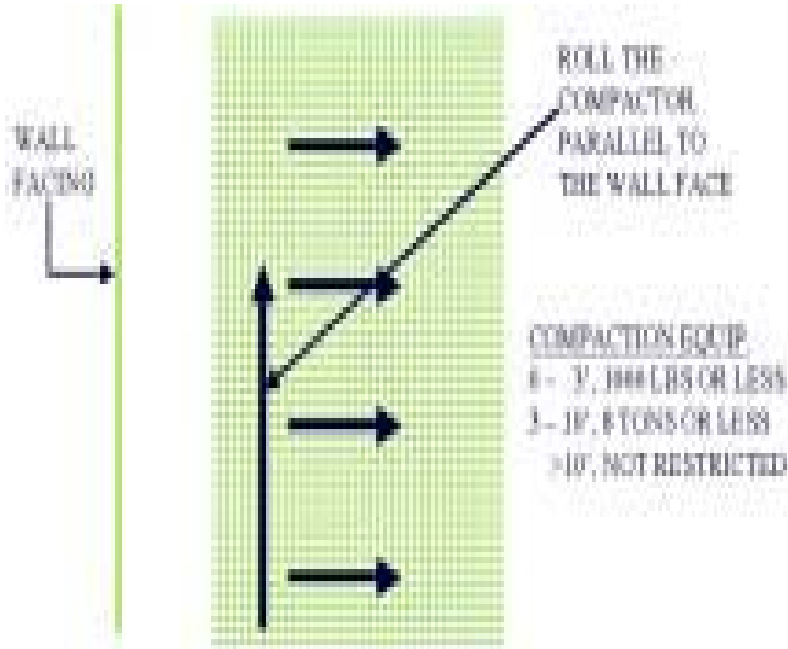

START COMPACTING 3' FROM THE WALL PANEL AND WORK TOWARD THE REINFORCEMENT ENDS.

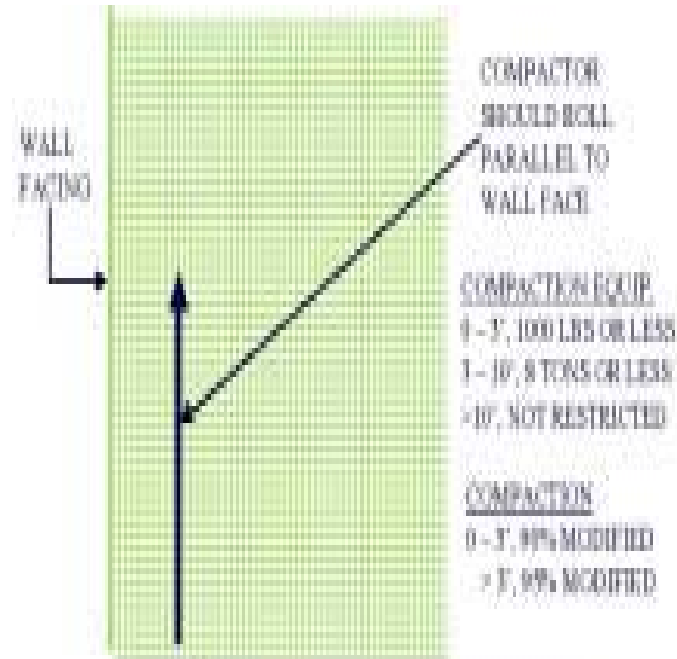

COMPACT THE REMAINING 3' AFTER THE REST OF THE BACKFILL HAS BEEN COMPACTED

Reinforced Fill Placement & Compaction

Sheepfoot Rollers Not Allowed



Reinforced Fill Placement & Compaction



Reinforced Fill Placement & Compaction



Reinforced Fill Placement & Compaction



Placement of Reinforcing Elements



Placement of Reinforcing Elements

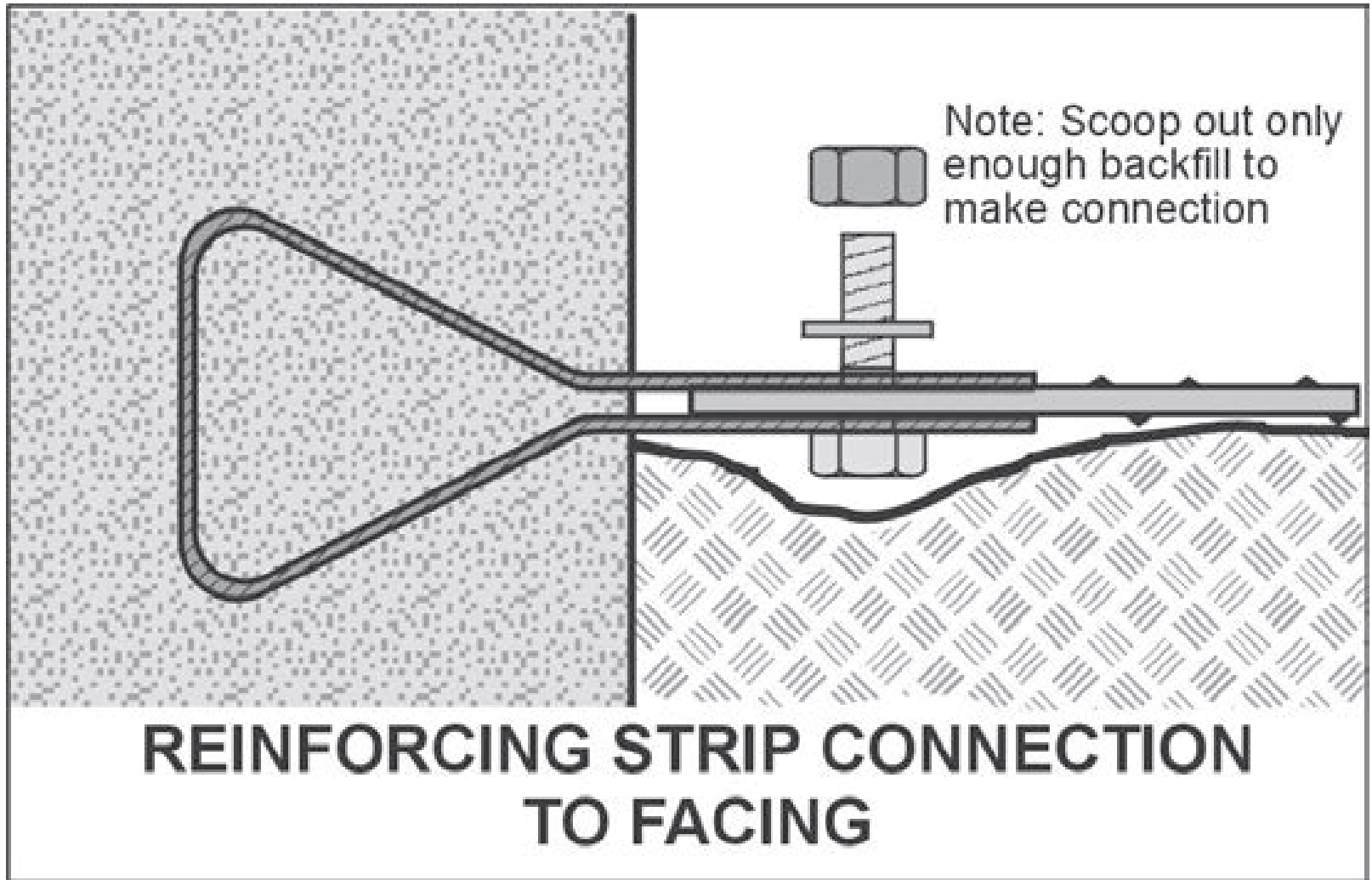

Placement of Reinforcing Elements

Improper bolting at connections



Placement of Reinforcing Elements

Reinforcing Strip Connection to Facing



Placement of Reinforcing Elements

- Straps not installed perpendicular to wall



Fill must be placed so as not to damage reinforcement or facing panels

Do not drive any machinery over reinforcement



Avoid exerting excessive pressures on the panels



Placement of Reinforcing Elements

Broken connections with new brackets



To accommodate vertical obstructions, reinforcement may be splayed, but by no more than 15°

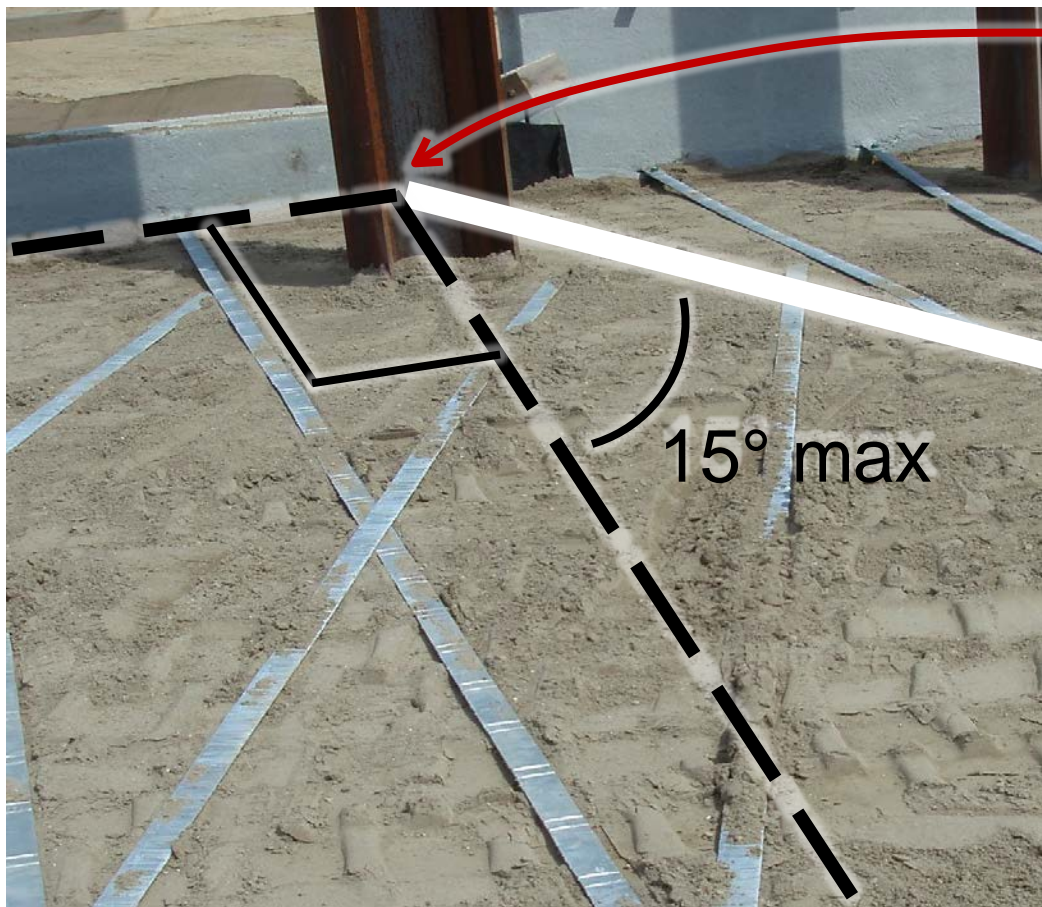

Location of reinforcement connection

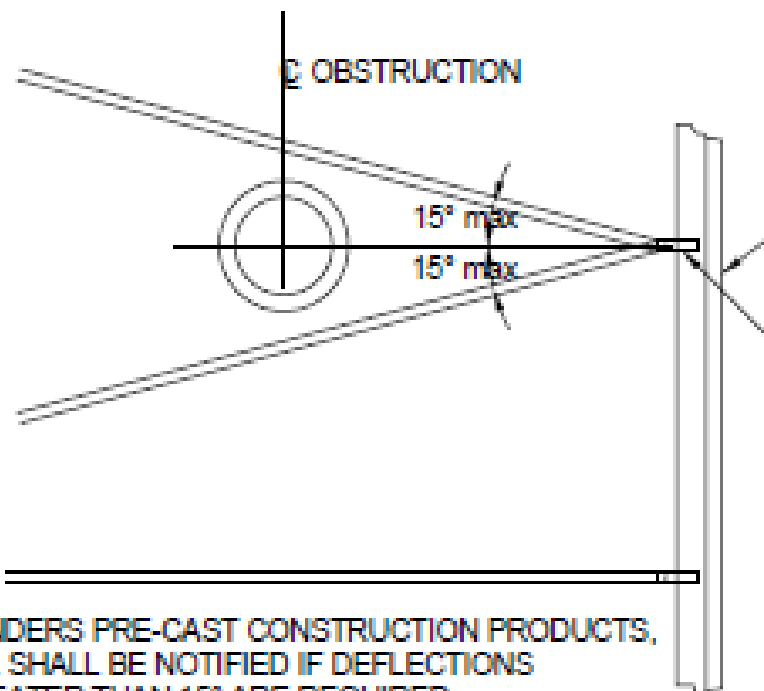

SANDERS PRE-CAST CONSTRUCTION PRODUCTS, INC. SHALL BE NOTIFIED IF DEFLECTIONS GREATER THAN 15° ARE REQUIRED.

Geotechnical Initiatives

■ Current:

- Recent Specification Changes
- Standardized MSE Wall Recommendations
- Developed a Checklist for Construction Personnel
- Developed a Bearing Capacity Verification Table
- Developed a Training Course for construction Inspection with the Assistance of the Research Division

■ Future:

- Modification to INDOT specs to address some design and construction issues such as splay angle of 15 degrees
- Use of Type IC subgrade treatment on MSE walls
- Use of impervious Geomembrane over MSE walls
- Development of MSE Wall Inventory



Recent Specification Changes

■ Design:

- **Contractor:** Responsible for Internal & External stability of the wall
- **Engineer:** Responsible for Global stability
- **Design Method:** AASHTO LRFD Bridge Design Specification
- **F* Value:** Standardized use of AASHTO default values
- **Tributary Area:** Use as per FHWA-NHI-10-025



Recent Specification Changes

- **Material:**

- **Unit weight:** Structure backfill should be at least 120pcf, design values for foundation soil should be as per the Geotechnical report
- **Geotextile:** Use at the interface between the reinforced and retained backfill zones or adjacent soil



Recent Specification Changes

- **Construction:**

- **Foundation Preparation:**

- Proofrolling of the entire footprint of Reinforced backfill zone
 - Verification of foundation by DCP Testing
 - Geotextile in conjunction with MSE wall construction will not be measured or paid separately



MSE Wall- 731.07 Rev.

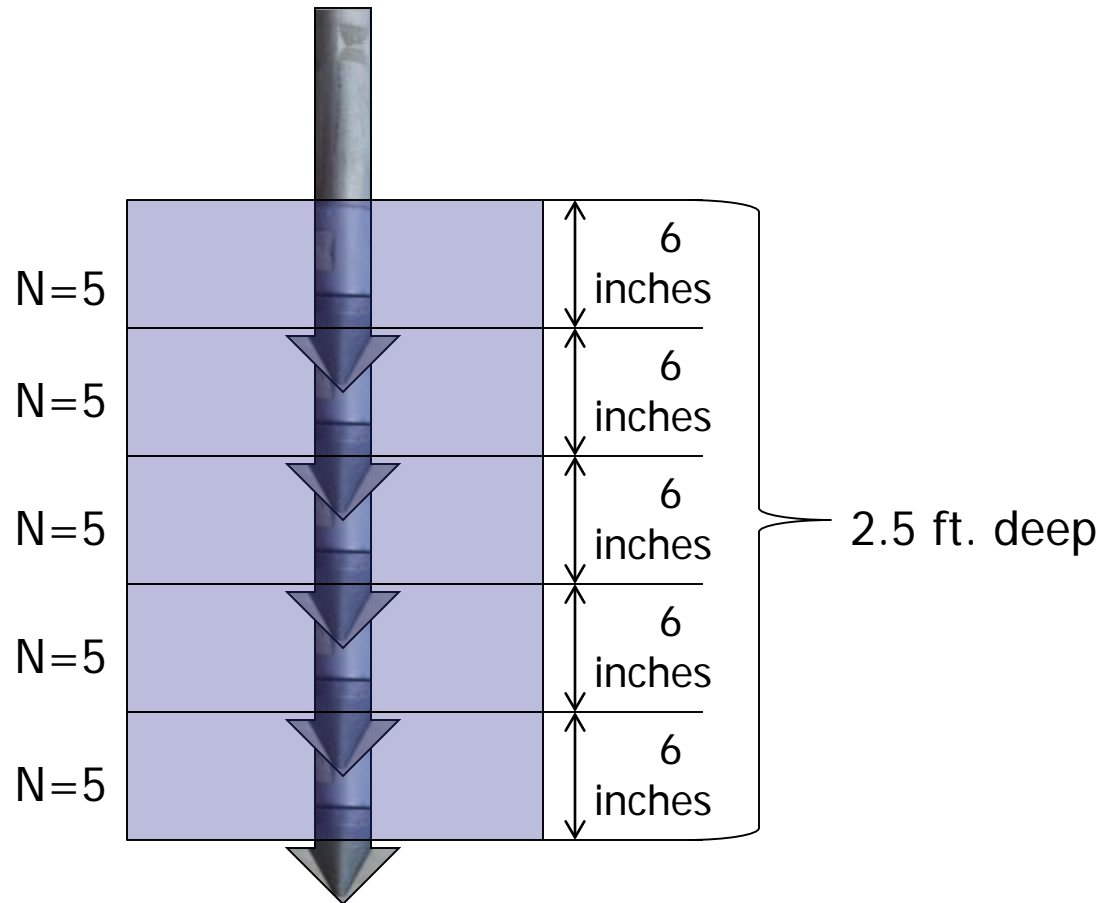

DCP Tests for Foundation Requirement

MSE Wall- 731.07 Rev.

DCP Test Frequency

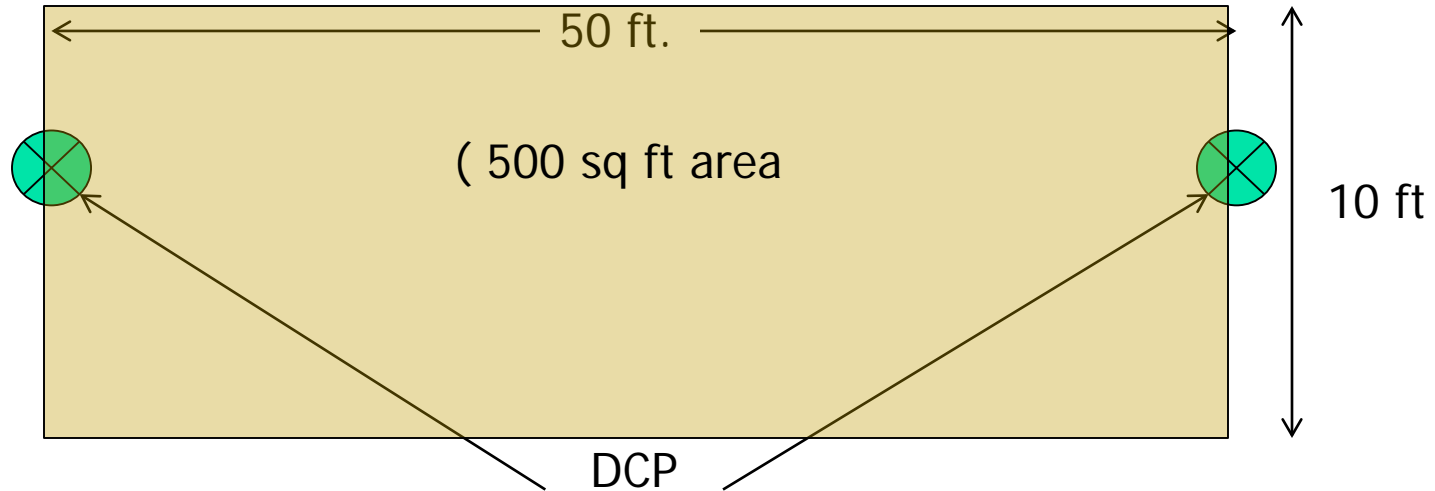

The frequency of DCP measurements is:

1 DCP test for every 500 sq ft

Or

5 DCP tests per end bent

Unsuitable areas shall be removed, replaced, and compacted in accordance with 203 and 211.

MSE Wall Geotechnical Design Parameter Table

Design Parameter	Value (area 1)*
Maximum Calculated Settlement	"x" inches
Maximum Differential Settlement	"y" inches
Time for settlement completion	"z" days
Maximum wall height	XX ft
Design Recommendations	
Minimum Reinforcement Length/Height Ratio	0.75H?? (example)
Undercut required	yes/no
Undercut depth	X feet??
Undercut area	from Sta. XX to XX line "XX"
Undercut Backfill Material	XXXXXXX
Seismic recommendation	
Site Class	
Seismic Zone	
Peak Ground Acceleration As	
Geotechnical Analysis Checks	CDR
Sliding	≥ 1.0
Eccentricity	≥ 1.0
Global Stability	Factor of safety/resistance factor
Factored Bearing Resistance	5400 psf (example value)
Foundation Soils Strength Parameters**	
Cohesion	
internal friction angle	
Notes:	
*more sheets can be added to include recommendations for each area of concern.	
**if varying soil conditions encountered underneath the MSE wall, the table can be expanded to include all soil profile information	



Check List

The following is a general checklist to follow when constructing a Mechanically

Stabilized Earth wall (MSE wall). The answer to each of these should be yes unless

plans, specifications or specific approval has been given otherwise.

YES NO

1. Has the contractor submitted wall shop drawings?
2. Has the contractor submitted select backfill certification?
3. Has the contractor furnished a copy of any instructions the wall supplier may have furnished?
4. Has the contractor supplied a Certificate of Compliance that the wall materials comply with the applicable sections of the specifications? Has the contractor supplied a copy of all test results performed by the Contractor supplier to assure compliance with specifications?



Check List

YES NO

5. Have the shop drawings been approved?
6. Has the geotechnical report been checked for undercutting?
7. Did the contractor receive the correct panels (shape, size and soil reinforcement connection layout) per the approved shop drawings?
8. Did the contractor receive the correct reinforcement (proper length and size)?
9. Have the panels and the reinforcement been Inspected for damage as outlined in the Specs?.



Check List

YES NO

10. **If any panels or soil reinforcement were found damaged have they been rejected or repaired in accordance with the specifications?**
11. **Are the panels and the soil reinforcement properly stored to prevent damage?**
12. **Has the MSE wall area been excavated to the proper elevation?**
13. **Has the area been proof rolled(a minimum of five passes by a roller weighing a minimum of 8 tons)?**
14. **Has all soft or unsuitable materials been compacted or removed and replaced?**



Check List

YES NO

15. Has the leveling pad area been properly excavated?
16. Has the leveling pad been set to the proper alignment?
17. Has the leveling pad cured for a minimum of 12 hours?
18. Is the first row of panels properly placed? Do they have proper spacing, bracing, tilt and where required, do they the spacers installed?
19. Has the proper filter fabric and adhesive been supplied?
20. Is the filter fabric being properly placed over the joints?
21. Is the adhesive being applied to the panel, than the filter fabric being placed?



Check List

YES NO

22. Is the filter fabric stored properly away from sunlight and protected from UV radiation?
23. Is the contractor using correct panels (size, shape & # of connections) for that panel's wall location & elevation?
24. Is fill being placed and compacted in 6 inch lifts?
25. Is the equipments are kept off the reinforcement until a minimum of 6 inches of fill is placed?
26. Are the lifts being placed by the proper method and sequence?
27. Is the fill being compacted by the correct equipment and in the correct pattern?
28.



Check List

YES NO

28. Is the proper compaction being met within 3 feet of wall and greater than 3 feet from the wall based on DCP criteria?
29. Is the fill being brought up to or slightly above the soil reinforcement elevation before the reinforcement are connected?
30. Is the reinforcement being properly connected?
31. Is the soil reinforcement in the proper alignment?
32. Is the vertical and horizontal alignments are checked periodically and adjusted as needed?
33. Is the contractor removing the wooden wedges as per specification?



Check List

YES NO

34. At the end of each day's operation is the contractor shaping the last level of backfill to permit a positive drainage away from the wall such as temporary pipe etc.?
35. Has the contractor backfilled the front of the wall?
36. Is the correct coping being installed?



Factored Bearing Resistance vs DCP Blow Counts

DCP Blows for 12 inches	Factored Bearing Resistance (psf)	DCP Blows for 12 inches	Factored Bearing Resistance (psf)
10	4,000.00	21	7,600.00
11	4,300.00	22	8,000.00
12	4,600.00	23	8,300.00
13	5,000.00	24	8,600.00
14	5,300.00	25	9,000.00
15	5,600.00	26	9,300.00
16	6,000.00	27	9,600.00
17	6,300.00	28	10,000.00
18	6,600.00	29	10,300.00
19	7,000.00	30	10,600.00
20	7,300.00	31	11,000.00

Note: This table is applicable only for fine grained soils. For sand & gravel, please contact Office of Geotechnical Services



Questions



Anne Rearick

Director of Bridges

Office: (317) 232-5152

Email: arearick@indot.in.gov

Athar A. Khan

Manager, Office of Geotechnical Engineering

Office: (317) 610-7251 ext 219

Email: atkhan@indot.in.gov