

## MT-5 Tracer Meter



RENOGY MT-5 Tracer Meter for MPPT Charge Controller



**RENOGY**  
THE FUTURE OF CLEAN ENERGY

2775 E. Philadelphia St., Ontario CA 91761  
1-800-330-8678

## Table of Contents

 <b>Important Safety Instructions</b> 	3
<b>General Information</b>	3
<b>Identification of Display</b>	4
<b>Installation</b>	5
<b>Operation</b>	5
Menu Display	5
Data Setting	5
<b>System Status Icons and Considerations</b>	7
Error Indicator	7
Telecommunication Port	7
Battery Level Flashing	7
Battery capacity AH	7
<b>Troubleshooting</b>	8
<b>Technical Specifications</b>	8
Parameters	8
Mechanical Parameters	8
Temperature Parameters	8
CAD Dimensions	9

## Important Safety Instructions

Please save these instructions.

This manual contains important safety, installation, and operating instructions for the charge controller. The following symbols are used throughout the manual to indicate potentially dangerous conditions or important safety information.

 **WARNING:** Indicates a potentially dangerous condition. Use extreme caution when performing this task.

**CAUTION:** Indicates a critical procedure for safe and proper operation of the controller

**NOTE:** Indicates a procedure or function that is important to the safe and proper operation of the controller.

### General Safety Information

- Read all instructions, cautions, and notes in the manual before starting the installation.
- There are no serviceable parts inside the MT-5. Do not disassemble or attempt to repair the meter electronics
- Do not allow water to enter the MT-5.

## General Information

The Renogy MT-5 Tracer meter is the remote digital display used for the 20Amp or 40Amp MPPT Charge Controllers. It is a self-diagnostics meter ideal for monitoring and displaying the current solar system status information and any error indications the system might be experiencing. The information is displayed on a backlit LCD display and is easily navigated using the large buttons on the meter. The MT-5 Tracer meter could also be flush mounted on a wall or flat surface using the mounting frame provided. The MT-5 Tracer is supplied with a 6.5 foot long cable and is connected using the RJ45 port.

### Key Features

- Displays system status and parameters with digital and graphical icons
- Battery type function and Battery Amp Hour (Ah) setting function
- Temperature compensation coefficient adjustable
- Control of the load terminal

### Included Components

- Wall Mounting Frame
- 6.5 ft. cable

### Components NOT included

- Screws →  $\varnothing$  4mm (0.16in)

## Identification of Display

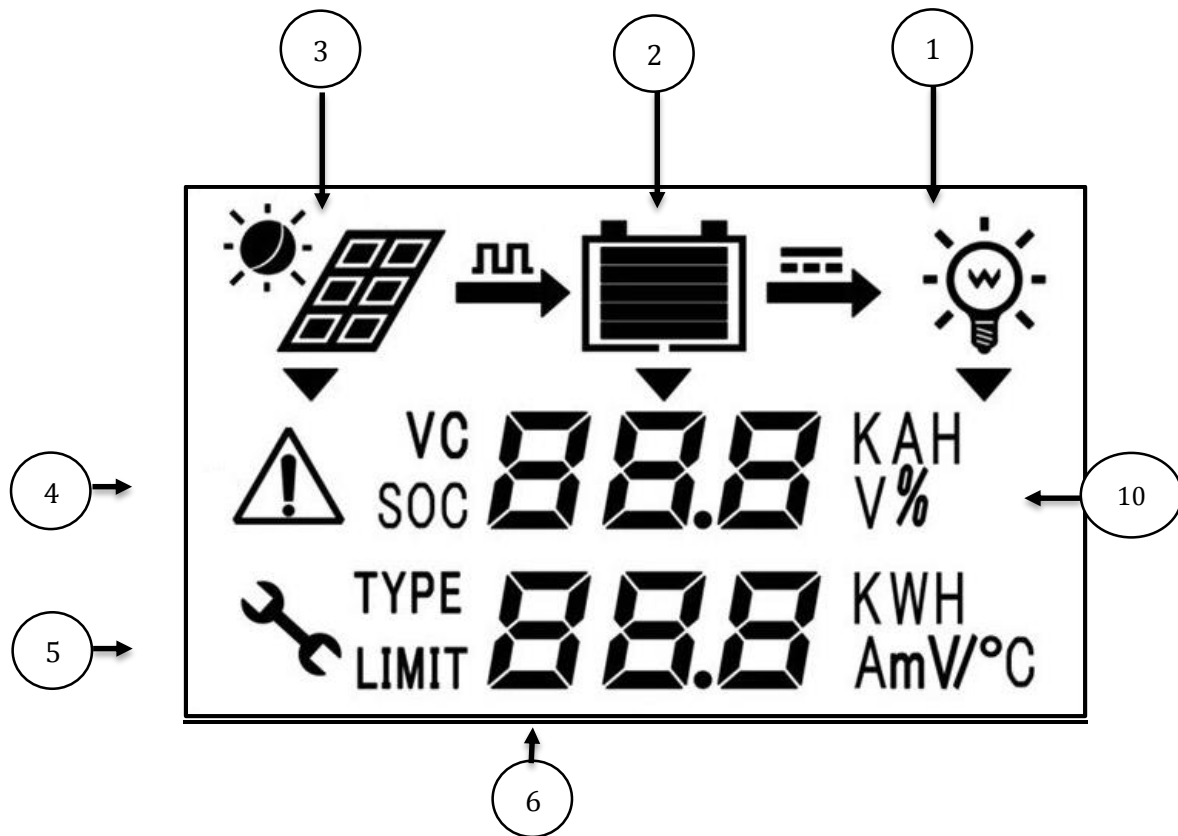

1. **Load Icon**
2. **Battery Icon(s)**—icon is present if the battery is connected otherwise it will remain flashing. It will demonstrate the battery level in which each bar represents 20% of the battery capacity.
3. **Solar Icon**
4. **Error Indicator**—indicates improper connection, tracer error, or short circuiting of the battery or solar panels.
5. **Setting Icon**—icon is present when the user is modifying parameters of the Tracer
6. **Data Units**

**NOTE:** The LCD has two different brightness levels. After any button is pressed, the display's backlight will be bright. After about 30 seconds the display will turn off the backlight.

## Installation

**CAUTION:** Before installing the MT-5 Tracer, apply power and make sure the meter is working properly. Resolve any issues before installing the meter and the meter cable.

The MT-5 can be mounted in two ways: Frame Mount or in a Wall Mount. A plastic mounting frame has been included for the purpose of Frame Mounting. If Wall Mounting then the MT-5 faceplate sits flush with the mounting surface and the body of the meter would be able to rest comfortably in a hole cut-out on the mounting surface.

**NOTE:** The screws are NOT included for installation purposes.

## Operation

The following keys are used to cycle through the screens or adjust the parameters on the tracer : (K1) **SET**, (K2) (**←**), (K3) (**→**), (K4) **/ESC** 

### Menu Display

The MT-5 Tracer displays several screens. Use the (K2) (**←**), (K3) (**→**) keys to cycle through the menu and access the data. The screens are displayed in the following order:

1. Solar Panel Voltage
2. Battery Voltage and Battery Current
3. Load Voltage and Load Current
4. Battery capacity (Ah) and Battery temperature
5. Battery State of Charge (SOC) (%) and Temperature Compensation
6. Battery Amp-hour (Ah) and Battery Type
7. Load Timer 1 and Load Timer 2 Mode
8. Discharge Accumulation in Amp-hour(Ah) and Watt-hour (Wh)

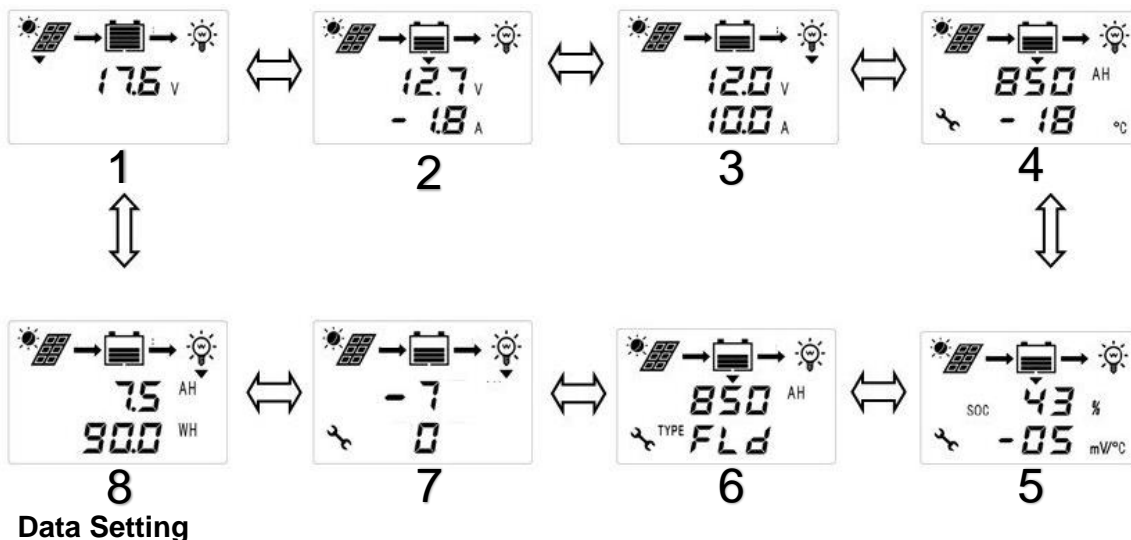

By pressing the **SET** button, the user is able to modify some parameters of the meter. They include: Battery Amp-Hours (Ah) (4), Battery Temperature Compensation (5), Battery Type (6), and Load Timer Mode (7). The user uses the (K2) (←) and (K3) (→) to adjust the parameter, and then press (K1) **SET** again to save the setting.

The  icon will be displayed when the user is in the **SET** function. It will disappear once the user is in the reading menu.

**NOTE:** In the menu display above, you will see the screens with the adjustable parameters because they will have the  icon.

## Data Setting

**NOTE:** The user uses the SET function to access the data setting parameter. A  symbol will appear by which the user utilizes the (K2) (←) and (K3) (→) to adjust the parameter, and then press (K1) SET again to save the setting.

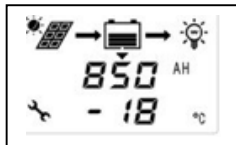

### Battery Amp-hour (Ah)

Battery Amp-hour ranges from 10Ah to 900Ah. The default value will be 200Ah. Once the user presses the **SET** button, they will be able to modify the Amp-hours in increments of 10Ah.

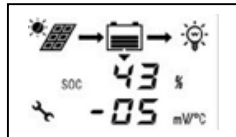

### Battery Temperature Compensation

The data ranges from 0 to 10mV/Cell/°C. When the function is set to 0, there will be no temperature compensation.

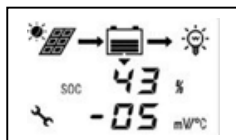

### Battery Type

Choose from a sealed lead acid battery (SEL), a gel battery (GEL), or a flooded battery (FLD).

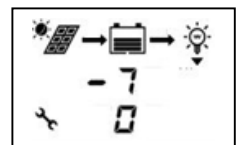

### Load Timer 1 and 2 Mode

This screen corresponds with the MPPT charge controller's Timer 1 and Timer 2 option. The user is able to program the timer from the MT-5 Tracer by choosing the number that corresponds to the desired timer. This information can be found on the manual of the MPPT Charge Controller.

## System Status Icons and Considerations

### **Error Indicator**

The red LED on the tracer is on or the “▲” symbol is visible in the digital display. Possible reasons for the Error Indicator include:

1. Battery could be disconnected, over voltage, or open circuit. Check connections. Disconnect and reconnect.
2. The system is experiencing overcharging current. Check connections, disconnect and reconnect
3. Solar PV is short circuited. Check connections, disconnect and reconnect.

### **Telecommunication Port**

When the meter running on individual power or the communication is cut off, the MT-5 will display graphical symbols abnormally. Press any key to stop the display and resume normal activity. IF problem persists, disconnect the port and connect it again. Normal behavior is when the meter updates every 20 seconds.

**NOTE: Errors could occur in the telecommunication port if the connection is not properly secured. Also, too long of a cable may cause some inconsistencies.**

### **Battery Level Flashing**

Each strip equals to 20% of battery capacity. The bar that is flashing indicates that the battery is within the next increment of 20% of the battery capacity. For example: when the first bar is flashing, the battery is at 1-19% of capacity. Similarly, when the second bar of the battery is flashing, then the capacity is at 21-39%.

**NOTE: The meter measures battery capacity by the voltage it is experiencing. When batteries are charging, they will not necessarily match the accurate battery capacity.**

### **Battery capacity AH**

AH is the accumulation of charging, each one minute will count. The data is not accurate while the charge current is too small. The min. is 1AH, means 1 amps charging for 1 hour, Ah comes to show.

## Troubleshooting

### **MT-5 has no display**

- Verify that the MPPT charge controller is powered on and that it is connected to the MT-5 since the charge controller powers on the Tracer.

### **LCD display is dim**

- Check the system battery voltage. The MT-5 needs a minimum of 8 V to operate.
- Verify that the temperature is within range of the LCD operating parameters.

### **MT-5 turns on, but shows no data**

- MT-5 is potentially damaged or the cable is damaged. Replace the cable by contacting the manufacturer.

### **MT-5 display does not match product manual**

- Our products undergo manual revisions from time to time. Please check our website at [Renogy-store.com](http://Renogy-store.com) > downloads for latest documentation.

### **Buttons do not work**

- Disconnect the MT-5 and clean the faceplate to remove any potential buildup of residue
- Reconnect MT-5

## Technical Specifications

Parameters	
Rated Voltage	12V
Minimum Voltage Suggested	8V
Strong backlight on	< 23mA
Low Backlight on	< 20mA
Backlight and LED indicator off	< 17mA

Mechanical Parameters	
Communication Cable	RJ45 (8 pin)
Cable Length	6.5 ft.
Faceplate Dimensions	95 x 95mm (3.74 x 3.74in)
Wall Frame Dimensions	110 x 110mm (4.33 x 4.33in)

Temperature Parameters	
Operation Temperature	-40°F to 140°F
LCD Operation Temperature	-14°F to 104°F
Humidity	0-100%



**CAD Dimensions**

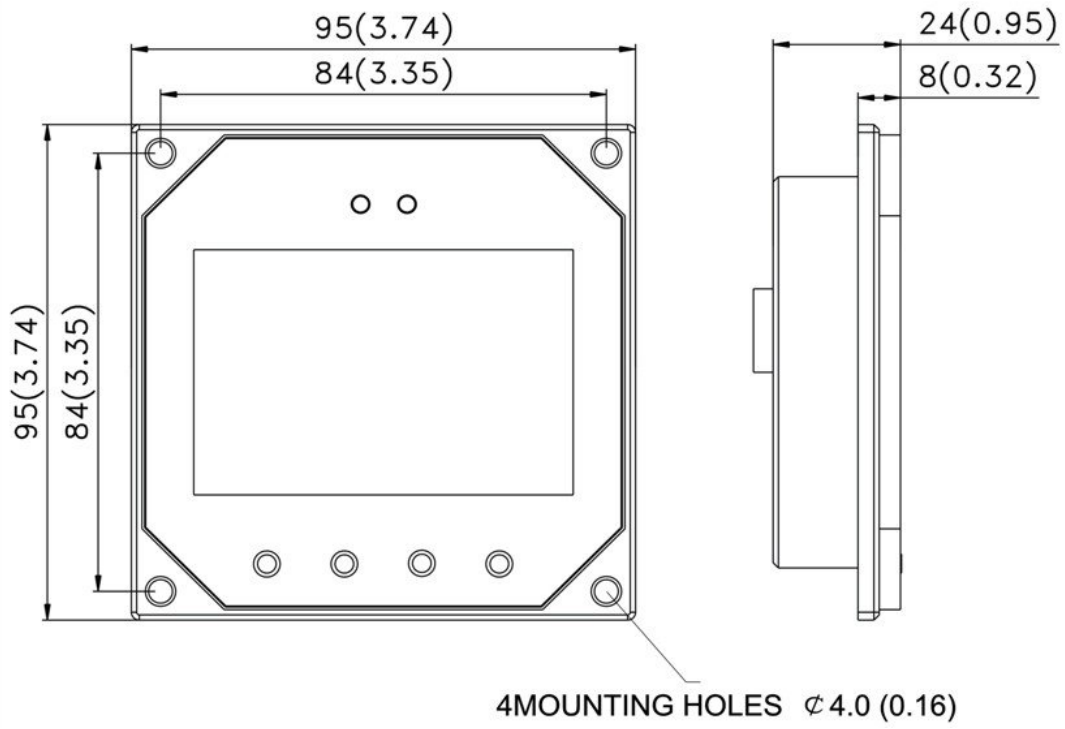

**NOTE:** Dimensions are in millimeters (inches)

Updated: July 10, 2015