



Where Automation Connects.



inRAx[®]

MVI56E-MNETR

ControlLogix Platform

ControlLogix Enhanced Modbus
TCP/IP Communication Module
with Reduced Data Block

July 1, 2010

SETUP GUIDE

Important Safety Information - MVI56E Modules

North America Warnings

- A** Warning - Explosion Hazard - Substitution of components may impair suitability for Class I, Division 2.
- B** Warning - Explosion Hazard - When in Hazardous Locations, turn off power before replacing or rewiring modules.
Warning - Explosion Hazard - Do not disconnect equipment unless power has been switched off or the area is known to be nonhazardous.
- C** Suitable for use in Class I, Division 2 Groups A, B, C, and D, T5 Hazardous Locations or Non-Hazardous Locations.

ATEX Warnings and Conditions of Safe Usage

Power, Input, and Output (I/O) wiring must be in accordance with the authority having jurisdiction

- A** Warning - Explosion Hazard - When in hazardous locations, turn off power before replacing or wiring modules.
- B** Warning - Explosion Hazard - Do not disconnect equipment unless power has been switched off or the area is known to be non-hazardous.
- C** These products are intended to be mounted in an IP54 enclosure. The devices shall provide external means to prevent the rated voltage being exceeded by transient disturbances of more than 40%. This device must be used only with ATEX certified backplanes.
- D** DO NOT OPEN WHEN ENERGIZED.

Electrical Ratings

- Backplane Current Load: 800 mA @ 5 Vdc; 3 mA @ 24 Vdc
- Operating Temperature: 0°C to 60°C (32°F to 140°F)
- Storage Temperature: -40°C to 85°C (-40°F to 185°F)
- Shock: 30 g operational; 50 g non-operational; Vibration: 5 g from 10 to 150 Hz
- Relative Humidity 5% to 95% (without condensation)
- All phase conductor sizes must be at least 1.3 mm (squared) and all earth ground conductors must be at least 4mm (squared).

Markings

ANSI / ISA	ISA 12.12.01 Class I Division 2, GPs A, B, C, D
CSA/cUL	C22.2 No. 213-M1987
CSA CB Certified	IEC61010
ATEX	EN60079-0 Category 3, Zone 2 EN60079-15



RoHS

243333

E183151

CL I Div 2 GP A, B, C, D

Temp Code T5

II 3 G

Ex nA nL IIC T5 X

0°C <= Ta <= 60°C

II – Equipment intended for above ground use (not for use in mines).

3 – Category 3 equipment, investigated for normal operation only.

G – Equipment protected against explosive gasses.

Battery Life Advisory

The module uses a rechargeable Lithium Vanadium Pentoxide battery to backup the real-time clock and CMOS settings. The battery itself should last for the life of the module. However, if left in an unpowered state for 14 to 21 days, the battery may become fully discharged and require recharging by being placed in a powered-up ControlLogix chassis. The time required to fully recharge the battery may be as long as 24 hours.

Once it is fully charged, the battery provides backup power for the CMOS setup and the real-time clock for approximately 21 days. Before you remove a module from its power source, ensure that the battery within the module is fully charged (the BATT LED on the front of the module goes OFF when the battery is fully charged). If the battery is allowed to become fully discharged, the module will revert to the default BIOS and clock settings.

Note: The battery is not user-replaceable or serviceable.

ProSoft Technology® Product Documentation

In an effort to conserve paper, ProSoft Technology no longer includes printed manuals with our product shipments. User Manuals, Datasheets, Sample Ladder Files, and Configuration Files are provided on the enclosed CD-ROM, and are available at no charge from our web site: www.prosoft-technology.com

Printed documentation is available for purchase. Contact ProSoft Technology for pricing and availability.

North America: +1.661.716.5100

Asia Pacific: +603.7724.2080

Europe, Middle East, Africa: +33 (0) 5.3436.87.20

Latin America: +1.281.298.9109

Your Feedback Please

We always want you to feel that you made the right decision to use our products. If you have suggestions, comments, compliments or complaints about our products, documentation, or support, please write or call us.

ProSoft Technology

5201 Truxtun Ave., 3rd Floor
Bakersfield, CA 93309
+1 (661) 716-5100
+1 (661) 716-5101 (Fax)
www.prosoft-technology.com
support@prosoft-technology.com

Copyright © 2010 ProSoft Technology, Inc., all rights reserved.

MVI56E-MNETR Setup Guide
6/30/2010

ProSoft Technology[®], ProLinx[®], inRAx[®], ProTalk[®], and RadioLinx[®] are Registered Trademarks of ProSoft Technology, Inc. All other brand or product names are or may be trademarks of, and are used to identify products and services of, their respective owners.

Contents

Important Safety Information - MVI56E Modules.....	2
Battery Life Advisory.....	3
ProSoft Technology® Product Documentation.....	3
Your Feedback Please.....	4
1 Scope	7
1.1 What's New?	7
1.2 Learning Objectives.....	8
1.3 ProSoft Technology Documentation	9
1.4 Prerequisites	10
2 Before You Begin	11
2.1 System Requirements.....	12
2.2 Required Items.....	13
2.3 Sample Files.....	14
3 Install the Configuration Tools	15
3.1 Install ProSoft Configuration Builder	15
4 The Sample Application	17
4.1 About the MODBUS TCP/IP Protocol	17
4.2 General Overview.....	18
4.2.1 Required Steps.....	19
4.3 Architecture	20
4.4 Memory Map	21
5 Procedures	23
5.1 Physical Setup.....	23
5.1.1 Setting Jumpers	23
5.1.2 Install the Module in the Rack	24
5.1.3 Connect your PC to the Module	25
5.1.4 Set Temporary IP Address.....	26
5.1.5 Connect to the Module's Web Page.....	34
5.1.6 Upload the Add-On Instruction from the Module.....	36
5.2 Connect your PC to the ControlLogix Processor	47
5.3 Download the Sample Program to the Processor.....	48
5.4 Using ProSoft Configuration Builder Software	49
5.4.1 Upload the Sample Configuration from the Module	50
5.4.2 Enable the MNET Client 0 Commands	52
5.5 Download the Project to the Module	55
5.6 Configure the NOE Ethernet adapter for Modbus TCP/IP (Server)	57
5.7 Connect the MVI56E-MNETR Module to the Modbus TCP/IP Server	58
5.8 Verify Communication	59

5.8.1	View Exchanged Data	59
5.8.2	Check Module Status through ControlLogix Controller Tags	62
5.8.3	LED Status Indicators	64
6	Building on Success	67
6.1	Frequently Asked Questions.....	68
6.1.1	What are the differences between the MVI56 and the MVI56E modules? What does the "E" stand for?.....	68
6.1.2	What is the difference between the MVI56E-MNET(R) and the MVI56E-MNETC(R)?	69
6.1.3	Is the MVI56E product a direct replacement to my existing MVI56 product?.....	69
6.1.4	How is the MVI56E-MNETR configured?	69
6.1.5	What is ProSoft Configuration Builder (PCB)?	69
6.1.6	What is the purpose of the MVI56E-MNETR Ethernet (E1) Port?.....	70
6.1.7	How do I change the module's IP address?	70
6.1.8	What is the purpose of the Optional MVI56E-MNETR Add-On Instruction?	70
6.1.9	Is there a Setup Guide to help with configuration?	70
6.1.10	What is ProSoft Discovery Service (PDS)?	71
6.1.11	Does the MVI56E-MNETR module require processor logic?	71
6.1.12	How do I monitor MVI56E-MNETR operation?.....	71
6.1.13	Are there any other ways to monitor module diagnostics besides being connected to the module's network (subnet)?	71
7	Glossary of Terms	73
Index	77

1 Scope

In This Chapter

❖ What's New?	7
❖ Learning Objectives.....	8
❖ ProSoft Technology Documentation.....	9
❖ Prerequisites	10

This document acts as a tutorial, providing step-by-step instructions on how to read and write bi-directional data from one network device to another network device using the MVI56E-MNETR.

1.1 What's New?

MVI56E products are **backward compatible** with existing MVI56 products, ladder logic, and module configuration files already in use. Easily swap and upgrade products while benefiting from an array of new features designed to improve interoperability and enhance ease of use.

- **Web Server:** The built-in web server and web page allow access to manuals and other tools previously provided only on a product CD-ROM or from the ProSoft Technology® web site.
- **ProSoft Configuration Builder (PCB):** New Windows software for diagnostics, connecting via the module's Ethernet port or CIPconnect®, to upload/download module configuration information and access troubleshooting features and functions.
- **ProSoft Discovery Service (PDS):** Utility software to find and display a list of MVI56E modules on the network and to temporarily change an IP address to connect with a module's web page.
- **CIPconnect-enabled:** Allows PC-to-module configuration and diagnostics from the Ethernet network through a ControlLogix 1756-ENBT EtherNet/IP™ module.
- **Personality Card:** An industrial compact flash memory card storing the module's complete configuration and Ethernet settings, allowing quick and easy replacement.
- **LED Scrolling Diagnostic Display:** 4-character, alphanumeric display, providing English messages for status and alarm data, and for processor and network communication status.

1.2 Learning Objectives

When you have completed all the steps in this Setup Guide, you will have learned how to

- Understand how the sample application works (page 17)
- Install the MVI56E-MNETR configuration software (page 15)
- Install the MVI56E-MNETR module (page 23)
- Import the Add-On Instruction to the processor (page 48)
- Configure the Modbus TCP/IP Client
- Configure the Modbus TCP/IP Server (page 57)
- Verify the MVI56E-MNETR module communication status (page 59)

1.3 ProSoft Technology Documentation

ProSoft Technology provides the following documentation (manuals) with your MVI56E-MNETR.

Electronic documentation (on the MVI56E-MNETR web page)

- **Setup Guide: (this manual)** Describes a sample application, and takes you through the steps necessary to install, configure, and verify the correct operation of the module
- **User Manual:** Detailed reference guide to the module, protocol configuration, functional overview, diagnostics and troubleshooting procedures, and product specifications
- **Datasheet:** Brief description of the module hardware and protocol implementation, as well as general and functional specifications

Additional documentation, tools, and product support

- **Web Site Support:** Visit the ProSoft Technology web site at www.prosoft-technology.com to download additional documentation, tools, and application information.
- **Email Technical Support:** Send your support questions to Support@prosoft-technology.com.
- **Telephone Support:** Please call ProSoft Technology Technical Support at: (Country Code 1+) 661-716-5100. Support is available 24 hours a day, 7 days a week. ProSoft Technology telephone support is free and unlimited.

1.4 Prerequisites

To get the most benefit from this setup guide, you should have the following skills:

- **Rockwell Automation® RSLogix™ 5000 software:** launch the program, configure and transfer the Add-On Instruction to the processor
- **Microsoft Windows:** install and launch programs, execute menu commands, navigate dialog boxes and enter data.
- **Ethernet networking:** connect the MVI56E-MNETR module to an Ethernet network using a valid IP address and subnet mask
- **Hardware installation and wiring:** install the module and safely connect Modbus TCP/IP and ControlLogix devices to a power source and to the MVI56E-MNETR module's Ethernet port

2 Before You Begin

In This Chapter

❖ System Requirements	11
❖ Required Items	13
❖ Sample Files.....	14

2.1 System Requirements

The MVI56E-MNETR module requires the following minimum hardware and software components:

- Rockwell Automation ControlLogix[®] processor (firmware version 10 or higher), with compatible power supply, and one free slot in the rack for the MVI56E-MNETR module. The module requires 800 mA of available 5 Vdc power
- Rockwell Automation RSLogix 5000 programming software
 - Version 16 or higher required for Add-On Instruction
 - Version 15 or lower must use Sample Ladder, available from www.prosoft-technology.com
- Rockwell Automation RSLinx[®] communication software version 2.51 or higher
- ProSoft Configuration Builder (PCB) (included)
- ProSoft Discovery Service (PDS) (included in PCB)
- Pentium[®] II 450 MHz minimum. Pentium III 733 MHz (or better) recommended
- Supported operating systems:
 - Microsoft Windows[®] Vista
 - Microsoft Windows XP Professional with Service Pack 1 or 2
 - Microsoft Windows 2000 Professional with Service Pack 1, 2, or 3
 - Microsoft Windows Server 2003
- 128 Mbytes of RAM minimum, 256 Mbytes of RAM recommended
- 100 Mbytes of free hard disk space (or more based on application requirements)
- 256-color VGA graphics adapter, 800 x 600 minimum resolution (True Color 1024 × 768 recommended)
- CD-ROM drive

Note: The Hardware and Operating System requirements in this list are the minimum recommended to install and run software provided by ProSoft Technology[®]. Other third party applications may have different minimum requirements. Refer to the documentation for any third party applications for system requirements.

Note: You can install the module in a local or remote rack. For remote rack installation, the module requires EtherNet/IP or ControlNet communication with the processor.

2.2 Required Items

This Setup Guide uses a sample application that shows you how to establish communication between the MVI56E-MNETR module (Modbus TCP/IP Client) and a Modbus TCP/IP Server device. The sample application requires the following equipment.

Item	Description
MVI56E-MNETR	ControlLogix Enhanced Modbus TCP/IP Communication Module with Reduced Data Block
1756-L63	ControlLogix processor
1756-A7/B	2 ControlLogix racks: one local rack with processor and one remote rack with MVI56E-MNETR
1756-PA72/B	2 ControlLogix rack power supplies: one local rack and one remote rack
1756-ENBT	2 EtherNet/IP Bridge Modules, one local rack and one remote rack
CPU434 12A	Quantum processor (Modbus device)
CPS 114 20	Quantum power supply
140XBP01000	Quantum rack
140NOE77111	NOE Card
Ethernet cable	Ethernet cable to connect MVI56E-MNETR module to Ethernet network for Modbus TCP/IP communication and diagnostics (supplied with the module)

Note: You can also use ControlNet with two 1756-CNB modules to communicate from the processor to the remote rack. Other remote communication configurations are also possible. Please refer to your Rockwell Automation documentation for information on communicating with a remote rack.

2.3 Sample Files

The following file is required for this procedure:

Item	Description
MVI56EMNETR_AddOn_Rung_v1_3.L5X	Sample rung import file containing Add-On Instruction

This procedure requires RSLogix 5000 version 16 (or later), which supports Add-On Instructions. The sample MVI56EMNETR_AddOn_Rung_v1_3.L5X Add-On Instruction file contains all elements required for the MVI56E-MNETR module to function.

- User-defined Data Types (UDTs)
- Add-On Instruction (AOI)
- Ladder rung with AOI
- Controller tags

The AOI L5X rung import file is located on the module's built-in web page.

Note: For RSLogix v15 (or older) applications, please refer to the *MVI56E-MNETR User Manual* for information on how to use the sample ladder logic.

3 Install the Configuration Tools

In This Chapter

- ❖ Install ProSoft Configuration Builder..... 15

3.1 Install ProSoft Configuration Builder

To install ProSoft Configuration Builder from the CD-ROM

- 1 Insert the ProSoft Solutions CD-ROM into the CD drive of your PC. Wait for the startup screen to appear.

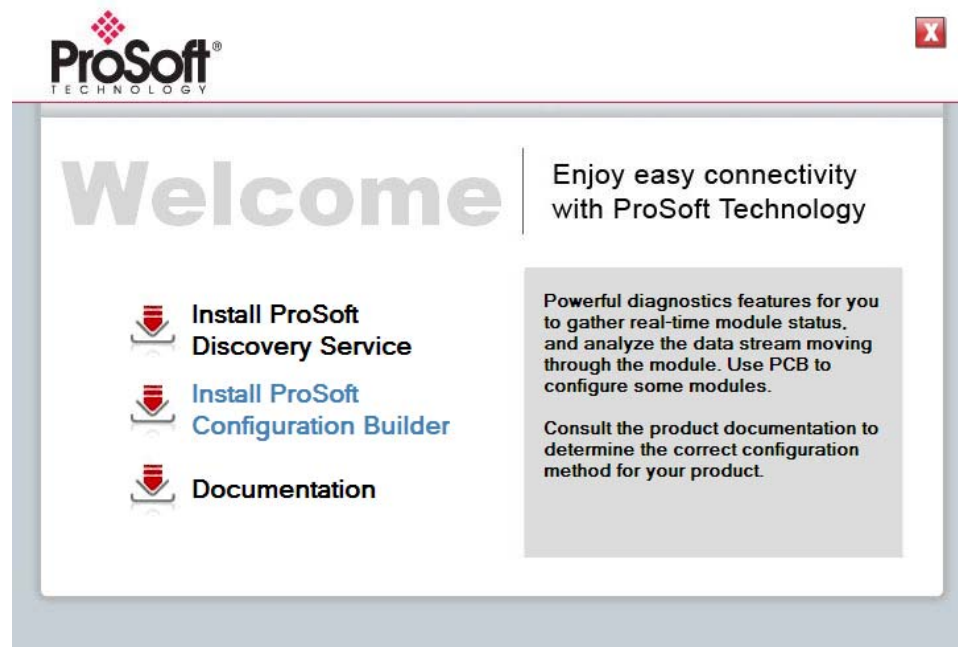

- 2 On the startup screen, click **INSTALL PROSOFT CONFIGURATION BUILDER**. This action starts the installation wizard for *ProSoft Configuration Builder*.
- 3 Click **NEXT** on each page of the installation wizard. Click **FINISH** on the last page of the wizard.

4 The Sample Application

In This Chapter

❖ About the MODBUS TCP/IP Protocol.....	17
❖ General Overview.....	18
❖ Architecture	20
❖ Memory Map	21

4.1 About the MODBUS TCP/IP Protocol

MODBUS is a widely used protocol originally developed by Modicon in 1978. Since that time, the protocol has been adopted as a standard throughout the automation industry.

The original MODBUS specification uses a serial connection to communicate commands and data between client and server devices on a network. Later enhancements to the protocol allow communication over Ethernet networks using TCP/IP as a "wrapper" for the MODBUS protocol. This protocol is known as MODBUS TCP/IP.

MODBUS TCP/IP is a client/server protocol. The client establishes a connection to the remote server. When the connection is established, the client sends the MODBUS TCP/IP commands to the server. The MVI56E-MNETR module works both as a client and as a server.

Aside from the benefits of Ethernet versus serial communications (including performance, distance, and flexibility) for industrial networks, the MODBUS TCP/IP protocol allows for remote administration and control of devices over a TCP/IP network. The efficiency, scalability, and low cost of a MODBUS TCP/IP network make this an ideal solution for industrial applications.

The MVI56E-MNETR module acts as an input/output module between devices on a MODBUS TCP/IP network and the Rockwell Automation backplane. The module uses an internal database to pass data and commands between the processor and the client and server devices on the MODBUS TCP/IP network.

4.2 General Overview

This Setup Guide shows you how to configure the MVI56E-MNETR module and establish communication with a Modbus TCP/IP device (a Quantum processor with a NOE Ethernet adapter, for this example).

The MVI56E-MNETR Ethernet application port will be configured as a Modbus TCP/IP (MNET) Client device. The NOE Ethernet adapter will operate as a Modbus TCP/IP Server device, passing data to the Quantum processor. The MVI56E-MNETR will be configured to send two MNET Client commands to the Modbus TCP/IP Server device:

- Write 10 words (Modbus Function 16 - Preset [Write] Multiple Registers)
- Read 10 words (Modbus Function 3 -Read Holding Registers)

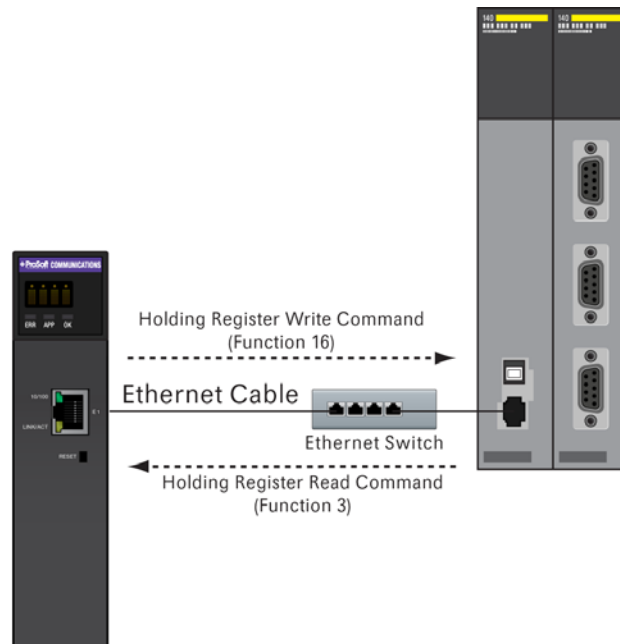

When you finish the steps in this Setup Guide, you will have enough information to set up your own application.

4.2.1 Required Steps

This Setup Guide will take you through the following steps:

- 1** Install the ProSoft Module in the rack (page 23)
- 2** Use the Add-On Instruction to Configure the Module (page 37)
- 3** Connect your PC to the Processor (page 47)
- 4** Download the Sample Program to the Processor (page 48)
- 5** Set up the Sample Application (page 50)
 - a** Configure the Modbus TCP/IP Client
 - b** Configure the Modbus TCP/IP Client Read Command
 - c** Configure the Modbus TCP/IP Client Write Command (page 53, page 54)
- 6** Transfer the configuration to the module (page 55)
- 7** Set up the NOE Modbus TCP/IP Server (page 57)
- 8** Verify Communication (page 59)

4.3 Architecture

The sample application uses the following hardware and connections.

- A Personal Computer running a supported version of Microsoft Windows, with a web browser, RSLogix 5000, ProSoft Discovery Service and an Ethernet port
- A ControlLogix processor with MVI56E-MNETR module acting as a Modbus TCP/IP Client
- A Quantum processor with a NOE Ethernet adapter acting as a Modbus TCP/IP Server
- An Ethernet network connecting the PC with the MVI56E-MNETR, either directly or through an Ethernet hub or switch.
- An Ethernet cable connecting the MVI56E-MNETR Modbus TCP/IP Client to the Modbus TCP/IP Server.

The following illustration shows the sample application.

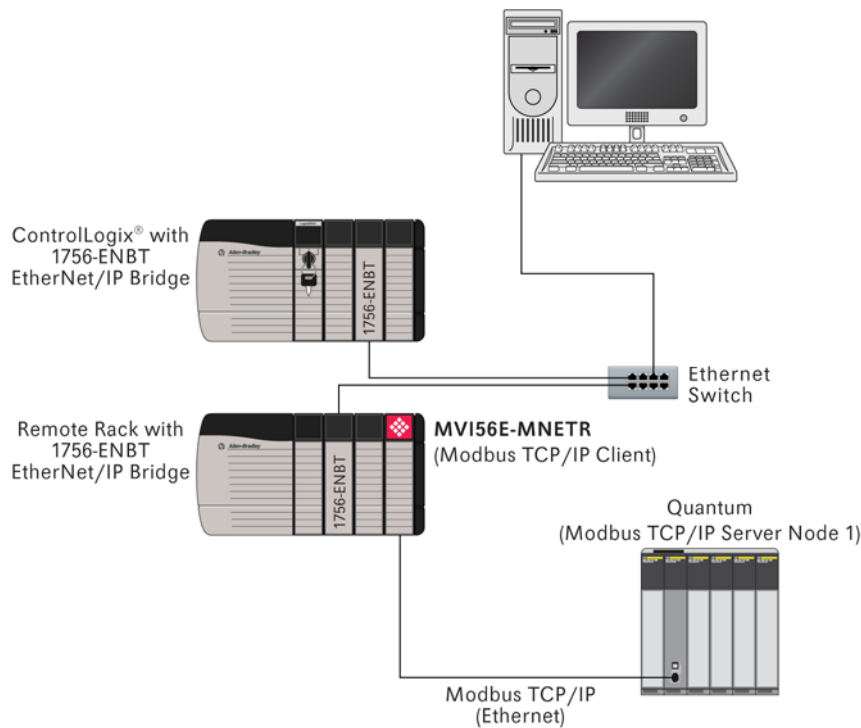

Note: The illustration does not show the required Ethernet connection for processor programming.

4.4 Memory Map

The memory map consists of the starting addresses for Read Data and Write Data areas in the MVI56E-MNETR module and in the Quantum processor. The sample application reads and writes 10 words between the Modbus TCP/IP Client and the Modbus TCP/IP Server.

The following table describes the memory map for data transfer between the MVI56E-MNETR module and the Quantum processor.

Function	MVI56E-MNETR Database Start Address (Client)	Quantum Memory Start Address (Server)	Word Count
Read	1000	400801	10
Write	0	400401	10

5 Procedures

In This Chapter

- ❖ Physical Setup.....23
- ❖ Connect your PC to the ControlLogix Processor47
- ❖ Download the Sample Program to the Processor.....48
- ❖ Using ProSoft Configuration Builder Software.....49
- ❖ Download the Project to the Module.....55
- ❖ Configure the NOE Ethernet adapter for Modbus TCP/IP (Server)57
- ❖ Connect the MVI56E-MNETR Module to the Modbus TCP/IP Server ...58
- ❖ Verify Communication59

5.1 Physical Setup

5.1.1 Setting Jumpers

The Setup Jumper acts as "write protection" for the module's flash memory. In "write protected" mode, the Setup pins are not connected, and the module's firmware cannot be overwritten. Do not jumper the Setup pins together unless you are directed to do so by ProSoft Technical Support.

The following illustration shows the MVI56E-MNETR jumper configuration.

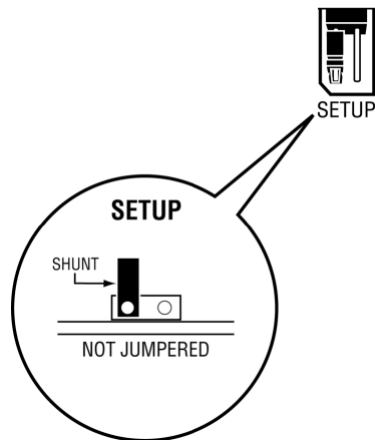

Note: If you are installing the module in a remote rack, you may prefer to leave the Setup pins jumpered. That way, you can update the module's firmware without requiring physical access to the module.

5.1.2 Install the Module in the Rack

If you have not already installed and configured your ControlLogix processor and power supply, please do so before installing the MVI56E-MNETR module. Refer to your Rockwell Automation product documentation for installation instructions.

Warning: You must follow all safety instructions when installing this or any other electronic devices. Failure to follow safety procedures could result in damage to hardware or data, or even serious injury or death to personnel. Refer to the documentation for each device you plan to connect to verify that suitable safety procedures are in place before installing or servicing the device.

After you have checked the placement of the jumpers, insert the MVI56E-MNETR into the ControlLogix chassis. Use the same technique recommended by Rockwell Automation to remove and install ControlLogix modules.

You can install or remove ControlLogix system components while chassis power is applied and the system is operating. However, please note the following warning.

Warning: When you insert or remove the module while backplane power is on, an electrical arc can occur. An electrical arc can cause personal injury or property damage by:

- sending an erroneous signal to your system's actuators causing unintended machine motion or loss of process control
- causing an explosion in a hazardous environment

Verify that power is removed or the area is non-hazardous before proceeding. Repeated electrical arcing causes excessive wear to contacts on both the module and its mating connector. Worn contacts may create electrical resistance that can affect module operation.

- 9 Align the module with the top and bottom guides, and then slide it into the rack until the module is firmly against the backplane connector.

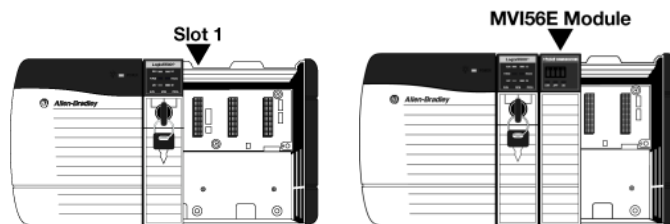

- 10 With a firm, steady push, snap the module into place.
- 11 Check that the holding clips on the top and bottom of the module are securely in the locking holes of the rack.
- 12 Make a note of the slot location. You must identify the slot in which the module is installed in order for the sample program to work correctly. Slot numbers are identified on the green circuit board (backplane) of the ControlLogix rack.
- 13 Turn power ON.

Note: If you insert the module improperly, the system may stop working, or may behave unpredictably.

5.1.3 Connect your PC to the Module

With the module securely mounted, connect one end of the Ethernet cable to the **CONFIG (E1)** Port, and the other end to an Ethernet hub or switch accessible from the same network as your PC. Or, you can connect directly from the Ethernet Port on your PC to the **CONFIG (E1)** Port on the module.

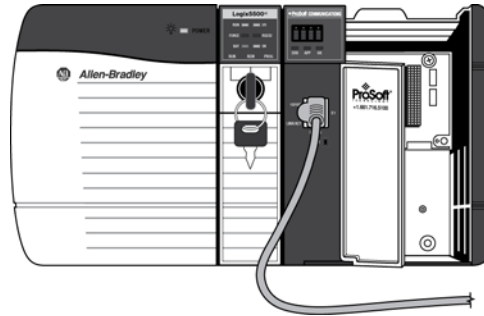

5.1.4 Set Temporary IP Address

Important: ProSoft Configuration Builder locates MVI56E-MNETR modules through UDP broadcast messages. These messages may be blocked by routers or layer 3 switches. In that case, ProSoft Discovery Service will be unable to locate the modules. To use ProSoft Configuration Builder, arrange the Ethernet connection so that there is no router/layer 3 switch between the computer and the module OR reconfigure the router/layer 3 switch to allow the routing of the UDP broadcast messages.

- 1 Click the **START** button, and then navigate to **PROGRAMS / PROSOFT TECHNOLOGY**

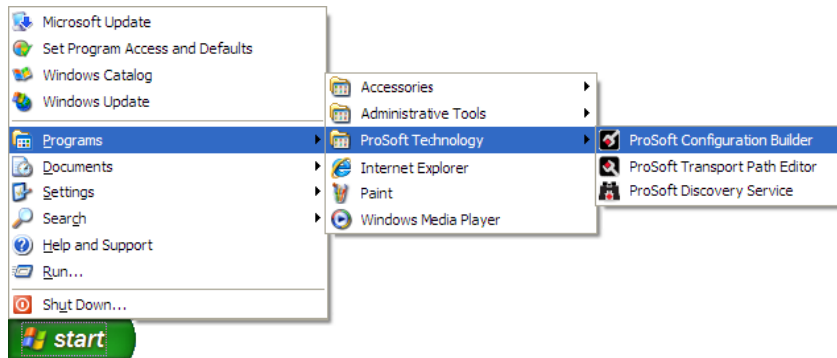

- 2 Click to start **PROSOFT CONFIGURATION BUILDER**

If you have used other Windows configuration tools before, you will find the screen layout familiar. PCB's window consists of a tree view on the left, and an information pane and a configuration pane on the right side of the window. When you first start *PCB*, the tree view consists of folders for **DEFAULT PROJECT** and **DEFAULT LOCATION**, with a **DEFAULT MODULE** in the Default Location folder. The following illustration shows the *PCB* window with a new project.

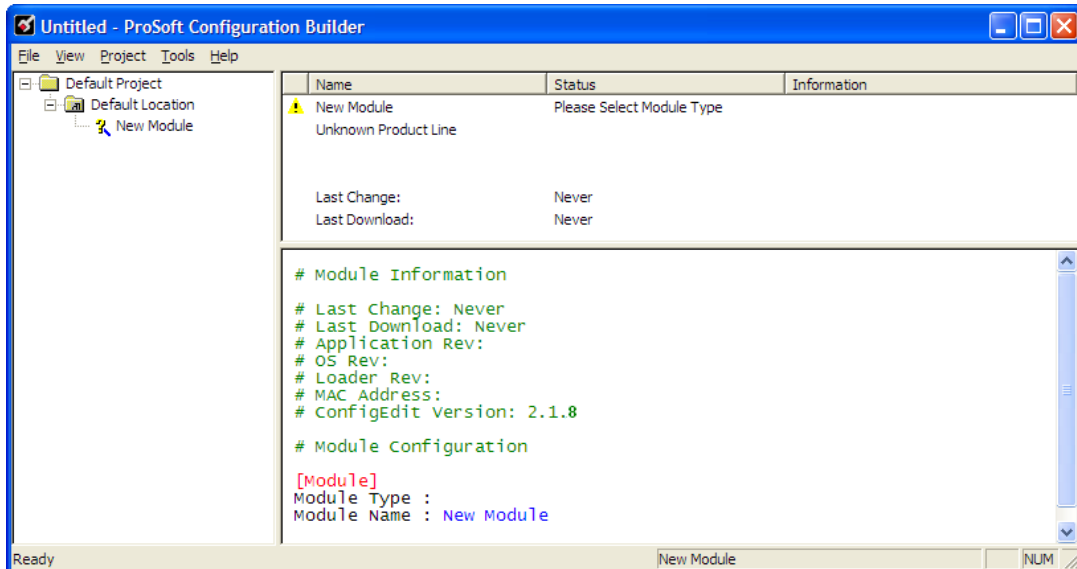

- 3 Use the mouse to select **DEFAULT MODULE** in the tree view, and then click the right mouse button to open a shortcut menu.

- 4 On the shortcut menu, choose **CHOOSE MODULE TYPE**. This action opens the **CHOOSE MODULE TYPE** dialog box.

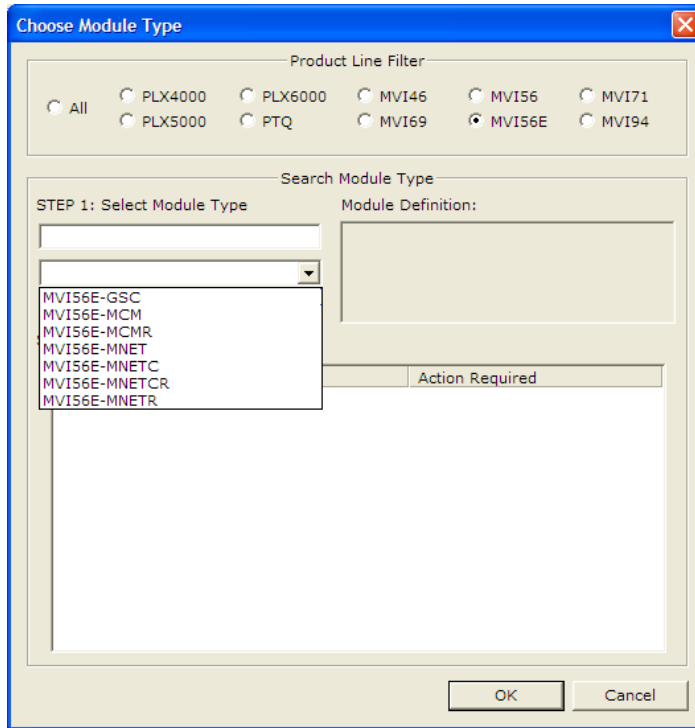

- 5 In the **PRODUCT LINE FILTER** area of the dialog box, select MVI56E. In the **SELECT MODULE TYPE** dropdown list, select MVI56E-MNETR, and then click **OK** to save your settings and return to the ProSoft Configuration Builder window.
- 6 Right click over the module icon.

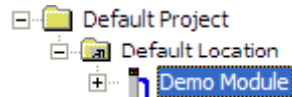

If there is no response from the module,

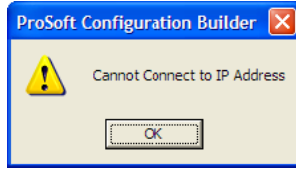

- 1 Click the **SET UP CONNECTION** button to browse for the module's IP address.



Click to set up connection

- 2 On the **CONNECTION SETUP** dialog box, click the **TEST CONNECTION** button to verify if the module is accessible with the current settings

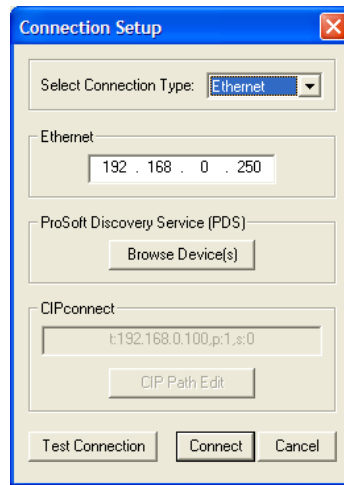

- 3 If PCB is still unable to connect to the module, click the **BROWSE DEVICE(S)** button to open the **PROSOFT DISCOVERY SERVICE**.

- 4 Select the module, then right click and choose **ASSIGN TEMPORARY IP**.

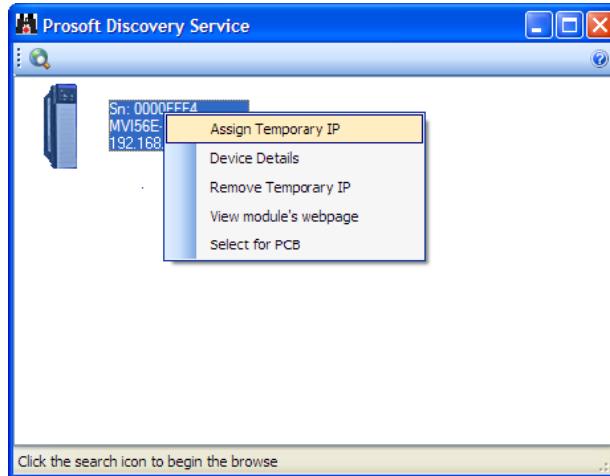

- 5 The module's default IP address is 192.168.0.250.

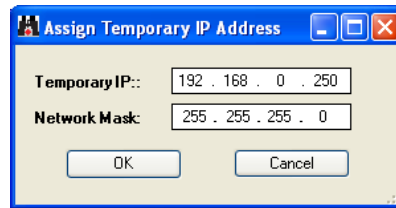

- 6 Choose an unused IP within your subnet, and then click **OK**.

CIPconnect

You can use CIPconnect® to connect a PC to the MVI56E-MNETR module over Ethernet using Rockwell Automation’s 1756-ENBT EtherNet/IP® module. This allows you to configure the MVI56E-MNETR module and network, upload and download files, and view network and module diagnostics from a PC. RSLinx is not required when you use CIPconnect. All you need are:

- The IP addresses and slot numbers of any 1756-ENBT modules in the path
- The ControlNet node numbers and slot numbers of any 1756-CNBx ControlNet Bridge modules in the path
- The slot number of the MVI56E-MNETR in the destination ControlLogix chassis (the last ENBT/CNBx and chassis in the path).

To use CIPconnect, follow these steps.

- 1 In the **SET CONNECTION TYPE** dropdown list, choose 1756-ENBT. The default path appears in the text box, as shown in the following illustration.

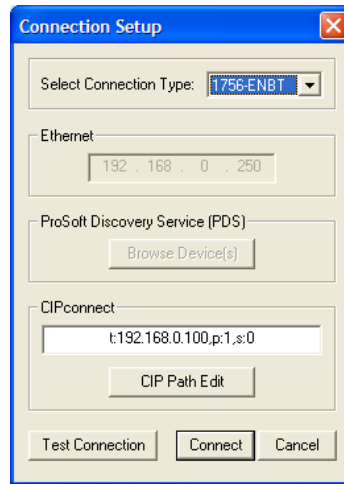

- Click **CIP PATH EDIT** to open the **CIPCONNECT PATH EDITOR** dialog box.

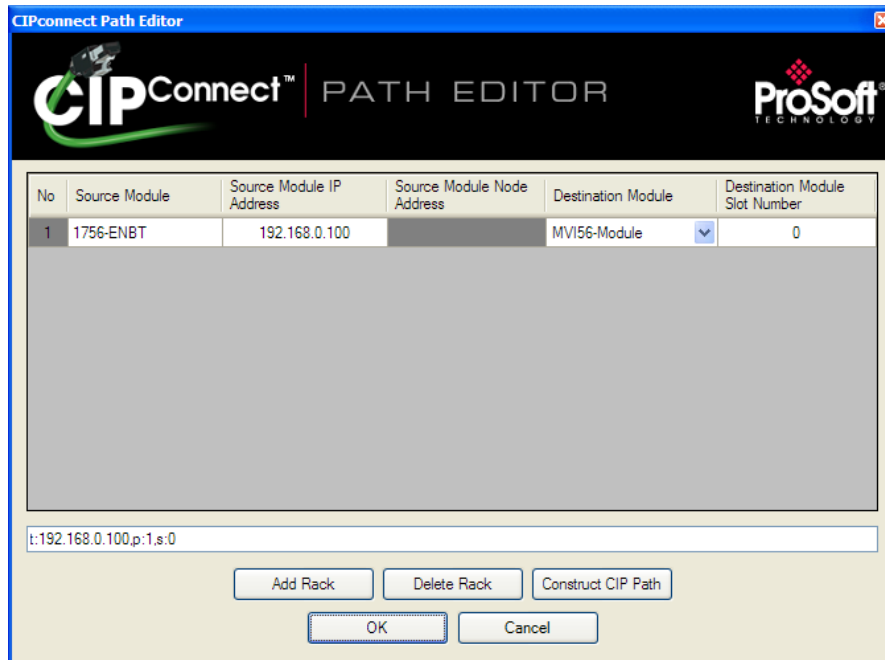

The **CIPCONNECT PATH EDITOR** allows you to define the path between the PC and the MVI56E-MNETR module. The first connection from the PC is always a 1756-ENBT (Ethernet/IP) module.

Each row corresponds to a physical rack in the CIP path.

- If the MVI56E-MNETR module is located in the same rack as the first 1756-ENBT module, select **RACK No. 1** and configure the associated parameters.
- If the MVI56E-MNETR is available in a remote rack (accessible through ControlNet or Ethernet/IP), include all racks (by using the **ADD RACK** button).

Parameter	Description
Source Module	Source module type. This field is automatically selected depending on the destination module of the last rack (1756-CNB or 1756-ENBT).
Source Module IP Address	IP address of the source module (only applicable for 1756-ENBT)
Source Module Node Address	Node address of the source module (only applicable for 1756-CNB)
Destination Module	Select the destination module associated to the source module in the rack. The connection between the source and destination modules is performed through the backplane.
Destination Module Slot Number	The slot number where the destination MVI56E module is located.

To use the CIPconnect Path Editor, follow these steps.

- 1 Configure the path between the 1756-ENBT connected to your PC and the MVI56E-MNETR module.
 - If the module is located in a remote rack, add more racks to configure the full path.
 - The path can only contain ControlNet or Ethernet/IP networks.
 - The maximum number of supported racks is six.
- 2 Click **CONSTRUCT CIP PATH** to build the path in text format
- 3 Click **OK** to confirm the configured path.

5.1.5 Connect to the Module's Web Page

- 1 In ProSoft Discovery Service, select the module to configure, and then click the right mouse button to open a shortcut menu.
- 2 On the shortcut menu, choose **VIEW MODULE'S WEBPAGE**.

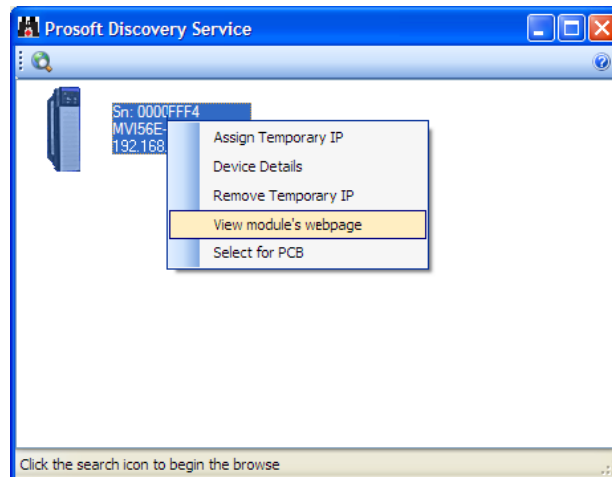

The web page contains the product documentation and sample programs.

All manuals and configuration tools are available from the module's web page

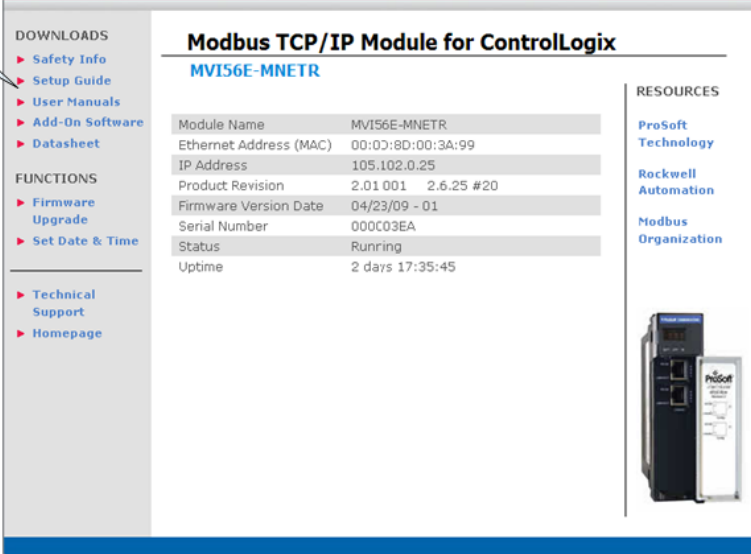

The screenshot displays the web interface for the MVI56E-MNETR module. On the left, there are two main navigation sections: 'DOWNLOADS' and 'FUNCTIONS'. The 'DOWNLOADS' section includes links for Safety Info, Setup Guide, User Manuals, Add-On Software, and Datasheet. The 'FUNCTIONS' section includes links for Firmware Upgrade and Set Date & Time. Below these are links for Technical Support and Homepage. The main content area is titled 'Modbus TCP/IP Module for ControlLogix MVI56E-MNETR' and features a table of system information. To the right of the table is a 'RESOURCES' section with links to ProSoft Technology, Rockwell Automation, and Modbus Organization. An image of the physical module is shown in the bottom right corner of the page.

Modbus TCP/IP Module for ControlLogix MVI56E-MNETR	
Module Name	MVI56E-MNETR
Ethernet Address (MAC)	00:00:8D:00:3A:99
IP Address	105.102.0.25
Product Revision	2.01 001 2.6.25 #20
Firmware Version Date	04/23/09 - 01
Serial Number	000C03EA
Status	Running
Uptime	2 days 17:35:45

Important: The temporary IP address is only valid until the next time the module is initialized. Please refer to Set Temporary IP Address (page 26) in the MVI56E-MNETR User Manual for information on how to set the module's permanent IP address.

You will need the User Manual and the Add-On Software to complete the steps in the following sections of this Setup Guide.

5.1.6 Upload the Add-On Instruction from the Module

Configuration and control information for the MVI56E-MNETR module is provided as an Add-On Instruction for RSLogix 5000, version 16 or higher.

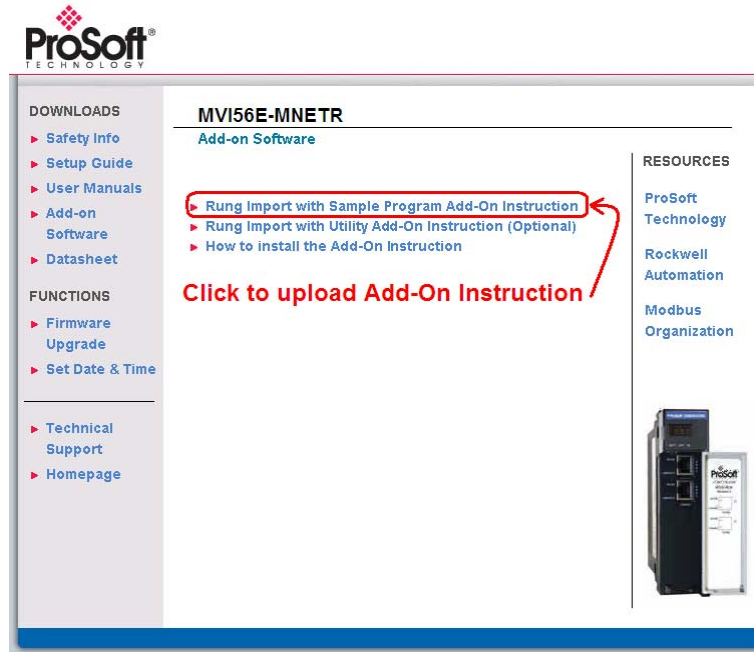

Two Add-On Instructions are provided:

- The **RUNG IMPORT WITH SAMPLE PROGRAM ADD-ON INSTRUCTION:**
MVI56EMNETR_AddOn_Rung_v1_3.L5X
Includes the User Defined Data Types, data objects and ladder logic required to configure the MVI56E-MNETR module.
- The **RUNG IMPORT WITH UTILITY ADD-ON INSTRUCTION (OPTIONAL):**
MVI56EMNETR_Optional_Rung_v1_1.L5X
Includes the data types and controller tags that allow you to update the IP address, date and time on the module.

Create a new RSLogix 5000 project

- 1 Open the **FILE** menu, and then choose **NEW...**

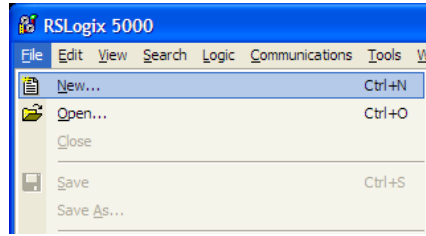

- 2 Select your ControlLogix controller model.
- 3 Select **REVISION 16**.
- 4 Enter a name for your controller, such as "My_Controller".
- 5 Select your ControlLogix chassis type.
- 6 Select **SLOT 0** for the controller.

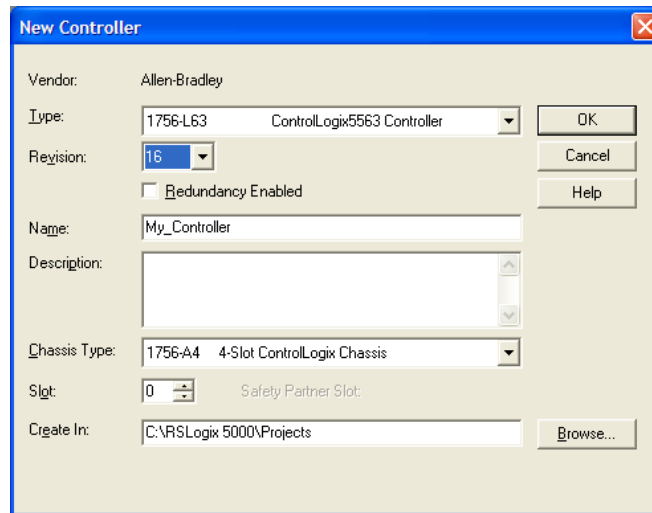

Create the Remote Network

- 1 Right-click **I/O CONFIGURATION** and choose **NEW MODULE...**

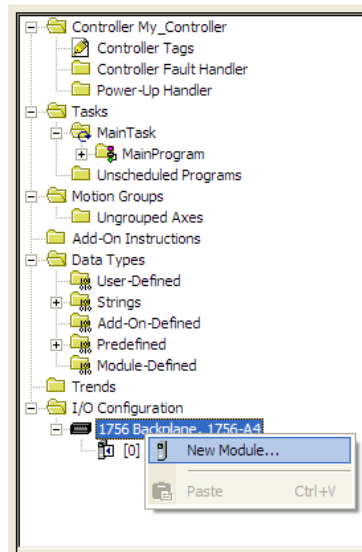

- 2 Expand the **COMMUNICATIONS** module selections and then select the Ethernet Bridge module that matches your hardware. This example uses a 1756-ENBT/A module.

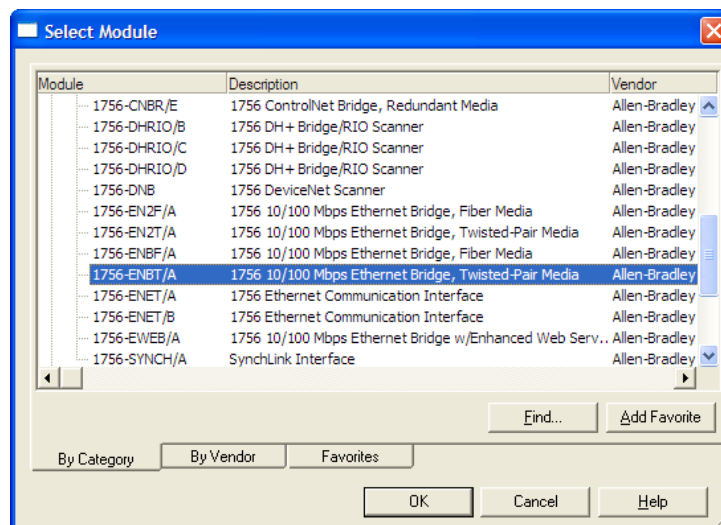

Note: If you are prompted to "Select Major Revision", choose the lower of the available revision numbers.

- 3 Name the ENBT/A module, then set the IP Address and slot location in the local rack with the ControlLogix processor.

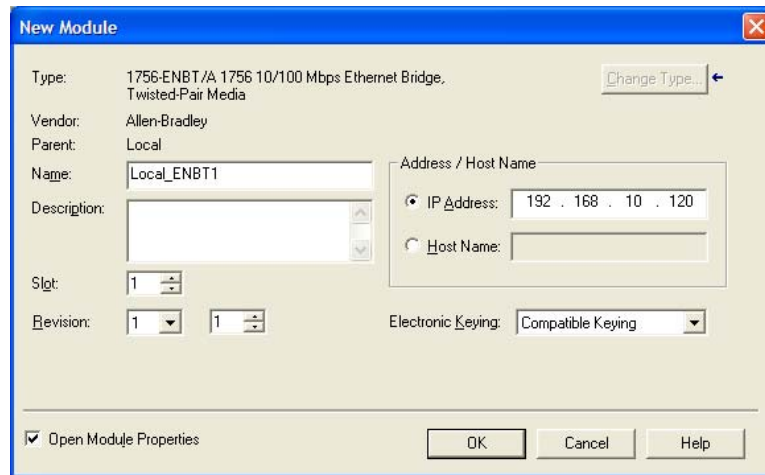

- 4 Click **OK**.
- 5 Next, select the **1756-ENBT** module that you just created in the Controller Organization pane and click the right mouse button to open a shortcut menu. On the shortcut menu, choose **NEW MODULE**.

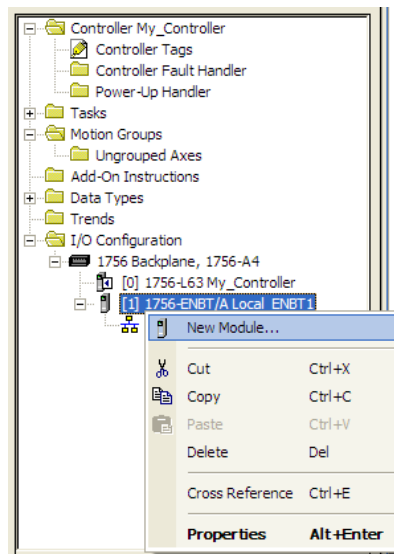

- 6 Repeat steps 2 and 3 to add the second EtherNet/IP module to the remote rack.

Create the Module - Remote Rack

- 1 Next, select the remote **1756 BACKPLANE** node in the Controller Organization pane underneath the remote rack EtherNet/IP module you just created and click the right mouse button to open a shortcut menu. On the shortcut menu, choose **NEW MODULE**.

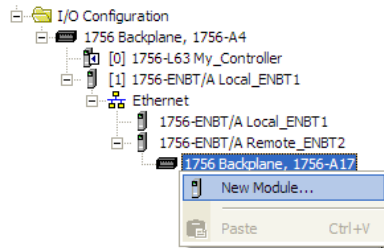

This action opens the **SELECT MODULE** dialog box.

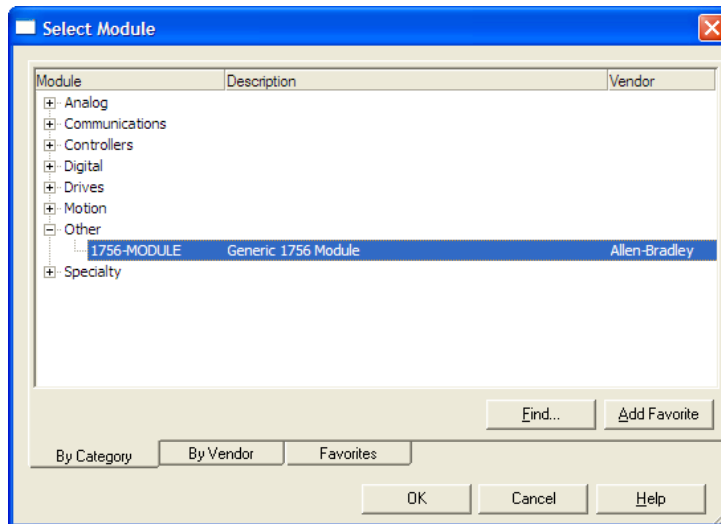

- 2 Select the **1756-MODULE (GENERIC 1756 MODULE)** from the list and click **OK**. This action opens the **NEW MODULE** dialog box.

3 Set the Module Properties values as follows:

Parameter	Value
Name	Enter a module identification string. The recommended value is MNETR.
Description	Enter a description for the module. Example: ControlLogix Enhanced Modbus TCP/IP Communication Module with Reduced Data Block.
Comm Format	Select DATA-INT (Very Important)
Slot	Enter the slot number in the rack where the MVI56E-MNETR module will be installed.
Input Assembly Instance	1
Input Size	42
Output Assembly Instance	2
Output Size	42
Configuration Assembly Instance	4
Configuration Size	0

4 On the **CONNECTION** tab, set the **RPI** value for your project. Fifty (50) milliseconds is usually a good starting value.

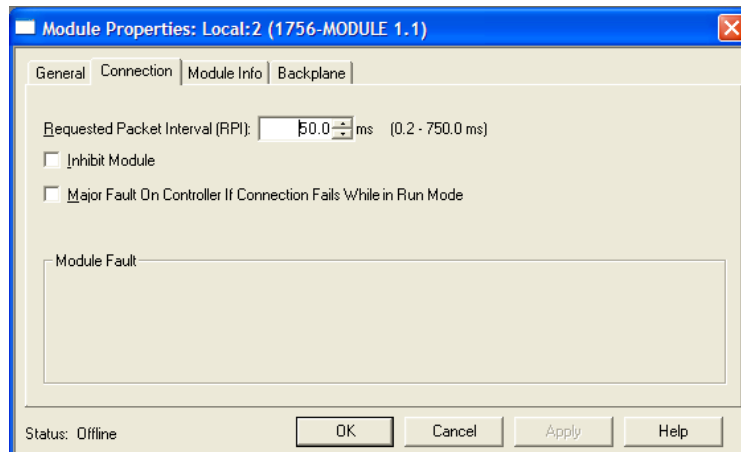

The **MVI56E-MNETR** module is now visible in the **I/O CONFIGURATION** section

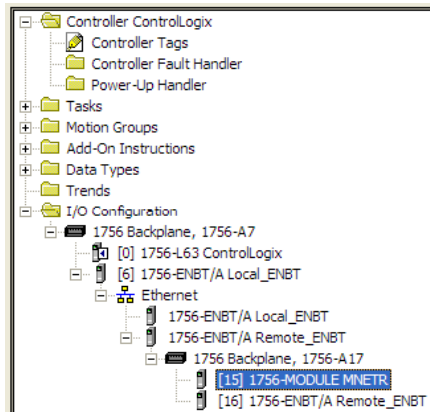

Import Add-On Instruction

- 1 In the **CONTROLLER ORGANIZATION** window, expand the **TASKS** folder and subfolder until you reach the **MAINPROGRAM** folder.
- 2 In the **MAINPROGRAM** folder, double-click to open the **MAINROUTINE** ladder.
- 3 Select an empty rung in the new routine, and then click the right mouse button to open a shortcut menu. On the shortcut menu, choose **IMPORT RUNG...**

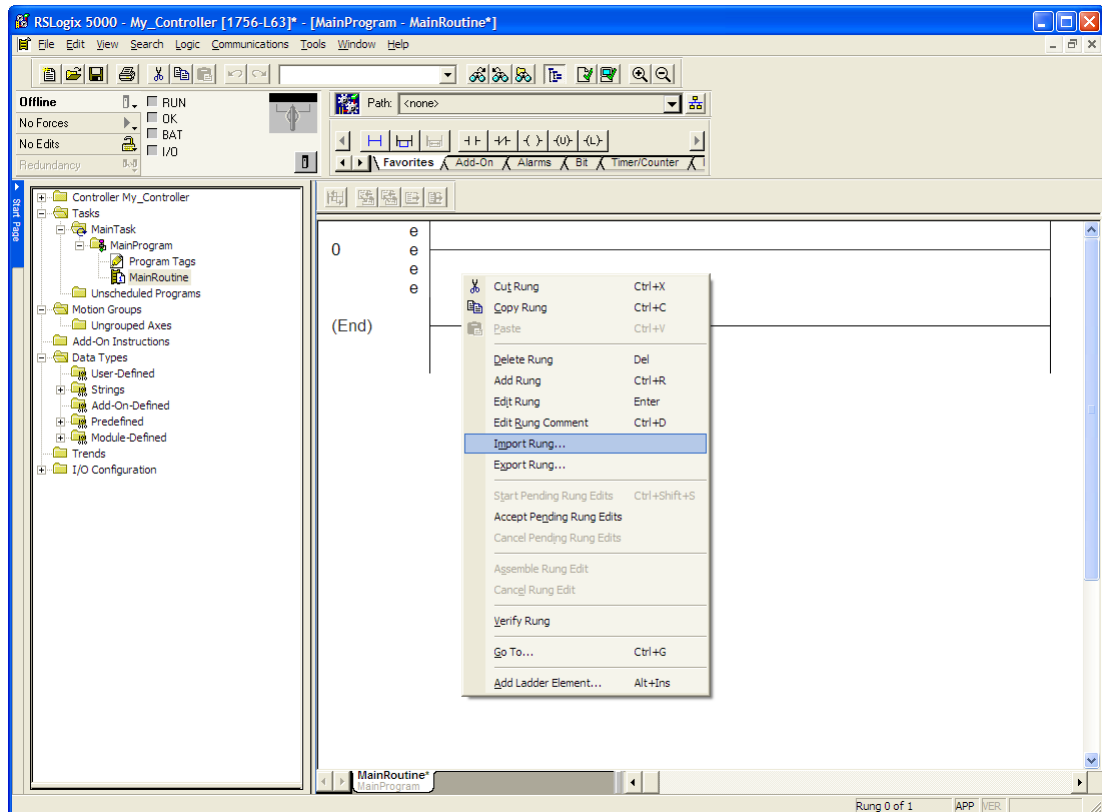

- 4 Navigate to the location on your PC where you saved (page 36) the Add-On Instruction (for example, "My Documents" or "Desktop"). Select the **MVI56EMNETR_ADDON_RUNG_v1_3.L5X** file

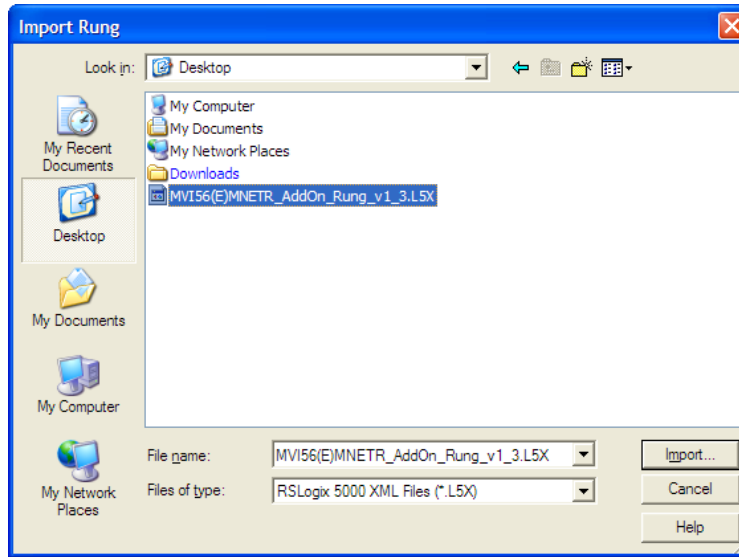

This action opens the **IMPORT CONFIGURATION** dialog box, showing the controller tags that will be created.

- If you are installing the module in a Remote Rack, open the dropdown menus for the Input and Output tags, and select the MNETR module in the remote rack.

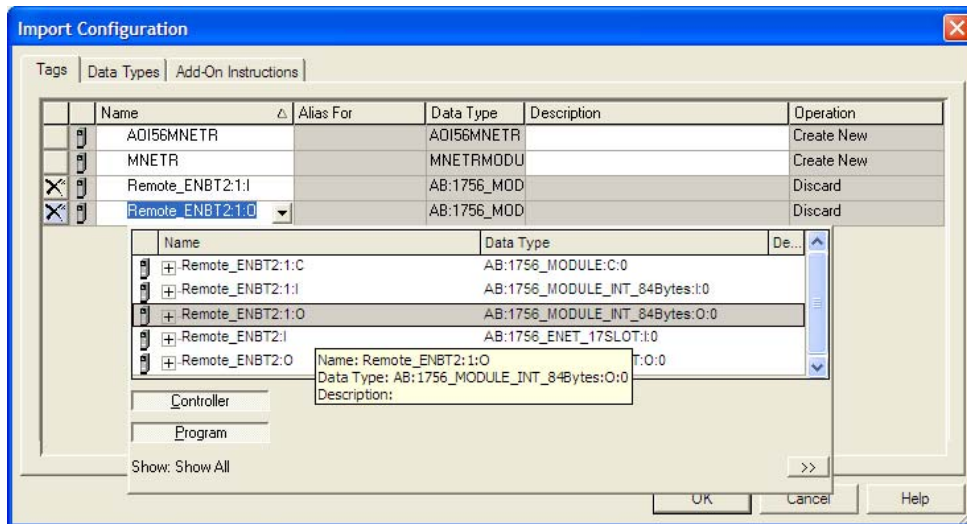
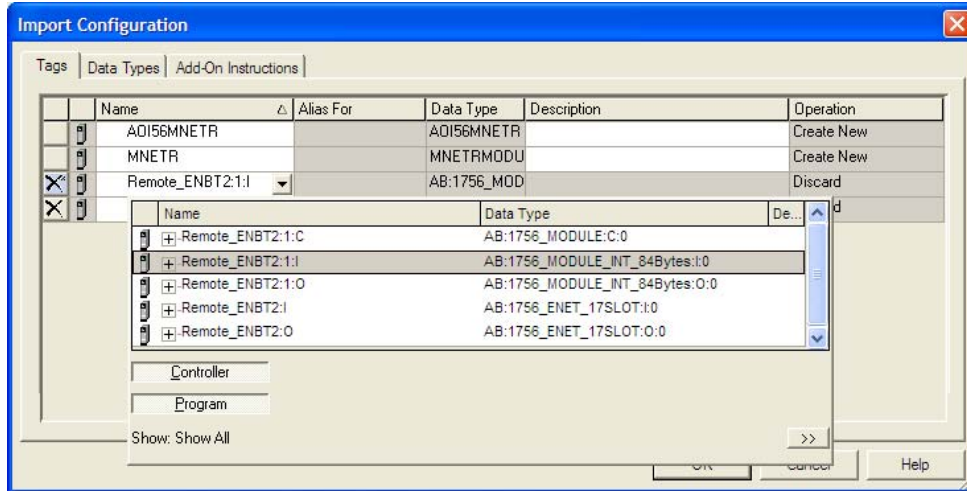

- 5 Click **OK** to confirm the import. RSLogix will indicate that the import is in progress:

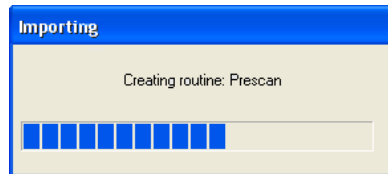

When the import is complete, you will see the new Add-On Instruction rung in the ladder.

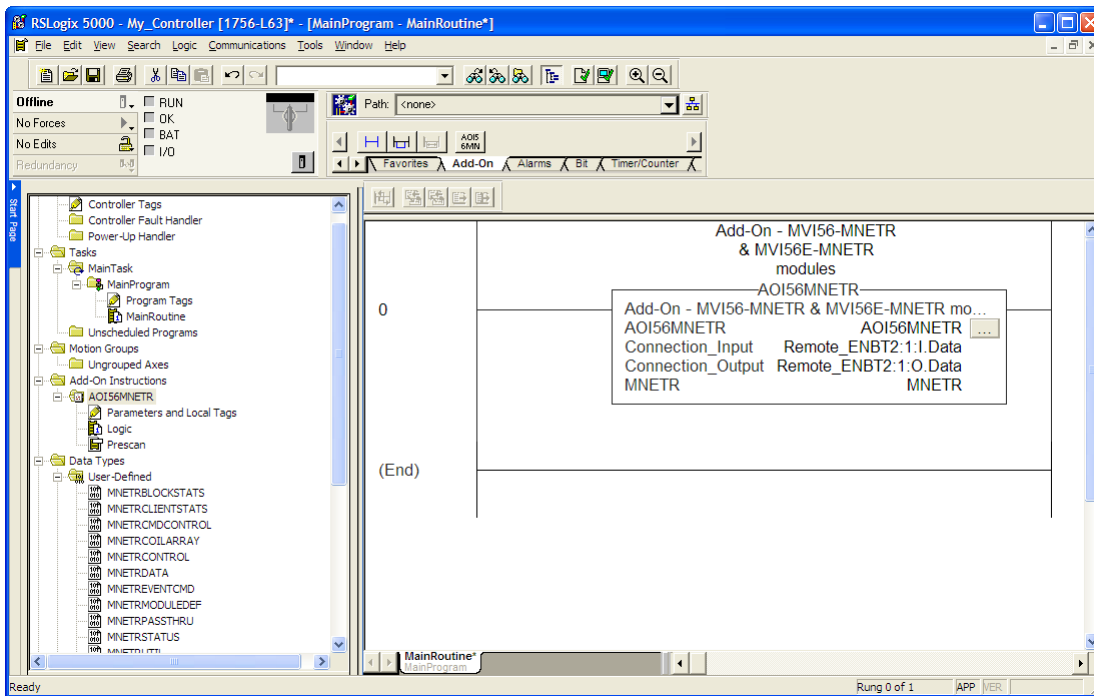

The procedure has also imported new User Defined Data Types, data objects and the Add-On instruction for your project.

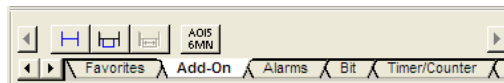

- 6 Save the application and then download the sample ladder logic into the processor.

5.2 Connect your PC to the ControlLogix Processor

There are several ways to establish communication between your PC and the ControlLogix processor. The following steps show how to establish communication through the serial interface. It is not mandatory that you use the processor's serial interface. You may access the processor through whatever network interface is available on your system. Refer to your Rockwell Automation documentation for information on other connection methods.

- 1 Connect the right-angle connector end of the cable to your controller at the communications port.

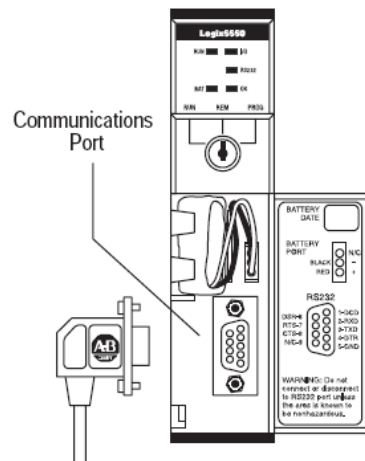

- 2 Connect the straight connector end of the cable to the serial port on your computer.

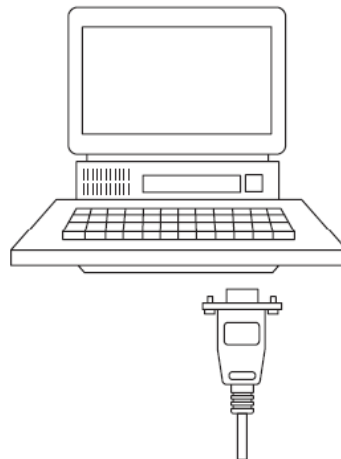

5.3 Download the Sample Program to the Processor

Note: The key switch on the front of the ControlLogix processor must be in the REM or PROG position.

- 1 If you are not already online with the processor, open the **COMMUNICATIONS** menu, and then choose **DOWNLOAD**. RSLogix will establish communication with the processor. You do not have to download through the processor's serial port, as shown here. You may download through any available network connection.
- 2 When communication is established, RSLogix will open a confirmation dialog box. Click the **DOWNLOAD** button to transfer the sample program to the processor.

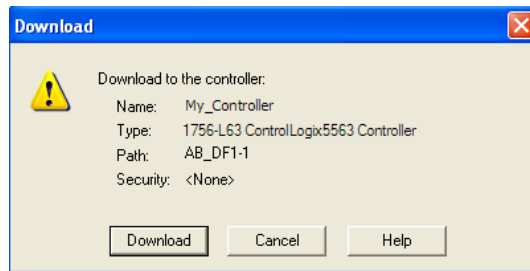

- 3 RSLogix will compile the program and transfer it to the processor. This process may take a few minutes.
- 4 When the download is complete, RSLogix will open another confirmation dialog box. If the key switch is in the **REM** position, click **OK** to switch the processor from **PROGRAM** mode to **RUN** mode.

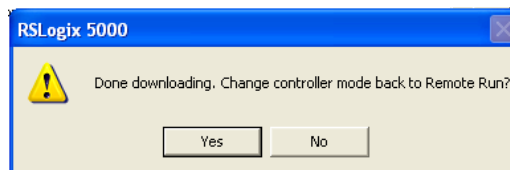

Note: If you receive an error message during these steps, refer to your RSLogix documentation to interpret and correct the error.

5.4 Using ProSoft Configuration Builder Software

ProSoft Configuration Builder (PCB) provides a quick and easy way to manage gateway configuration files customized to meet your application needs. *PCB* is not only a powerful solution for new configuration files, but also allows you to import information from previously installed (known working) configurations to new projects.

Note: The MVI56E-MNETR module receives its protocol and backplane configuration information from the *Personality Module* (Compact Flash). Use ProSoft Configuration Builder to configure module settings, and to download changes to the Personality Module.

5.4.1 Upload the Sample Configuration from the Module

The MVI56E-MNETR module contains a sample configuration file, with configuration parameters that match the sample application in this Setup Guide. To retrieve the sample configuration file, follow these steps.

- 1 In ProSoft Configuration Builder, select the **MVI56E-MNETR** module, and then click the right mouse button to open a shortcut menu. On the shortcut menu, choose **UPLOAD FROM DEVICE TO PC**.

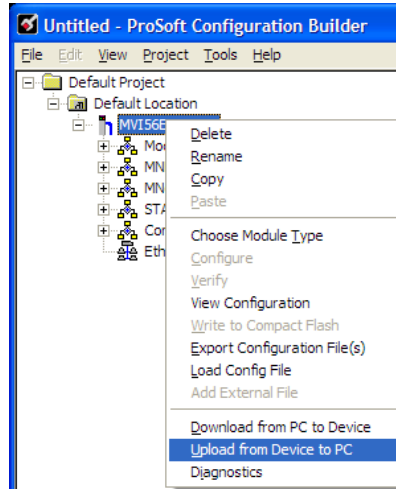

This action opens the **UPLOAD FILES** dialog box.

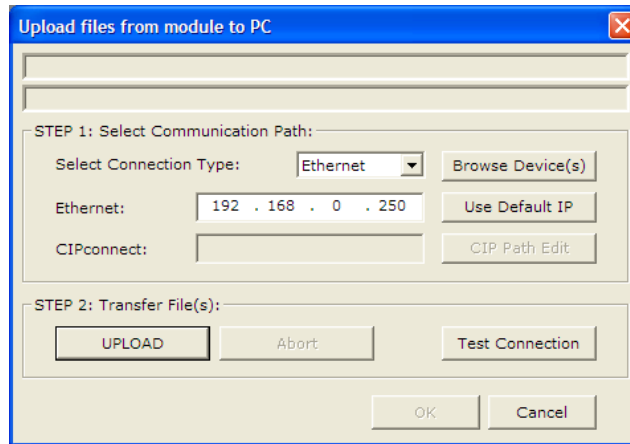

- In the **UPLOAD FILES** dialog box, click **BROWSE DEVICES** to locate the MVI56E-MNETR module. This action opens the **PROSOFT DISCOVERY SERVICE** dialog box. Select the module, and then click the right mouse button to open a shortcut menu. On the shortcut menu, choose **SELECT FOR PCB**. This action places the module's Ethernet address in the Upload Files dialog box.

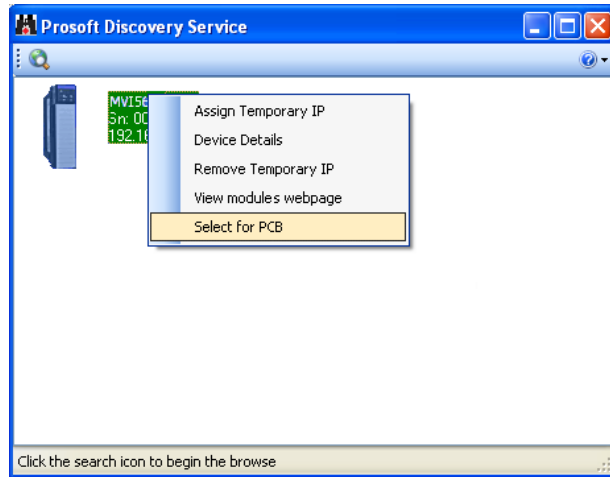

- Click the **X** in the top right corner to close the ProSoft Discovery Service dialog box.
- In the **UPLOAD FILES** dialog box, click Upload. When the upload is complete, as shown in the following illustration, click the **OK** button.

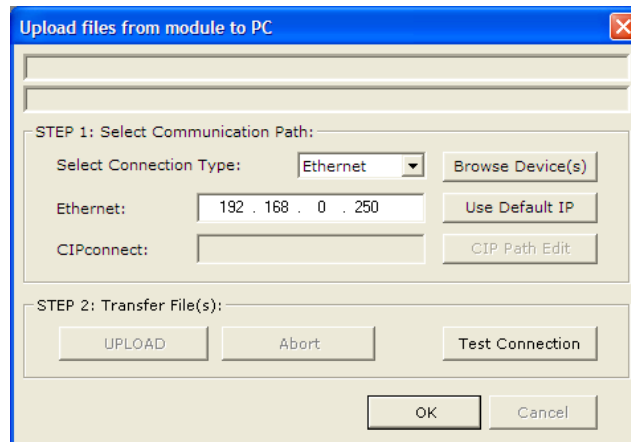

ProSoft Configuration Builder now contains the sample configuration for your MVI56E-MNETR module. In the following steps, you will configure the Read and Write commands.

5.4.2 Enable the MNET Client 0 Commands

The default module configuration contains two Modbus Client commands. In the default configuration file, these commands are disabled.

- 1 To enable the commands, expand the **MVI56E-MNETR** node in ProSoft Configuration Builder until the **MNET CLIENT 0 COMMANDS** tag is visible.

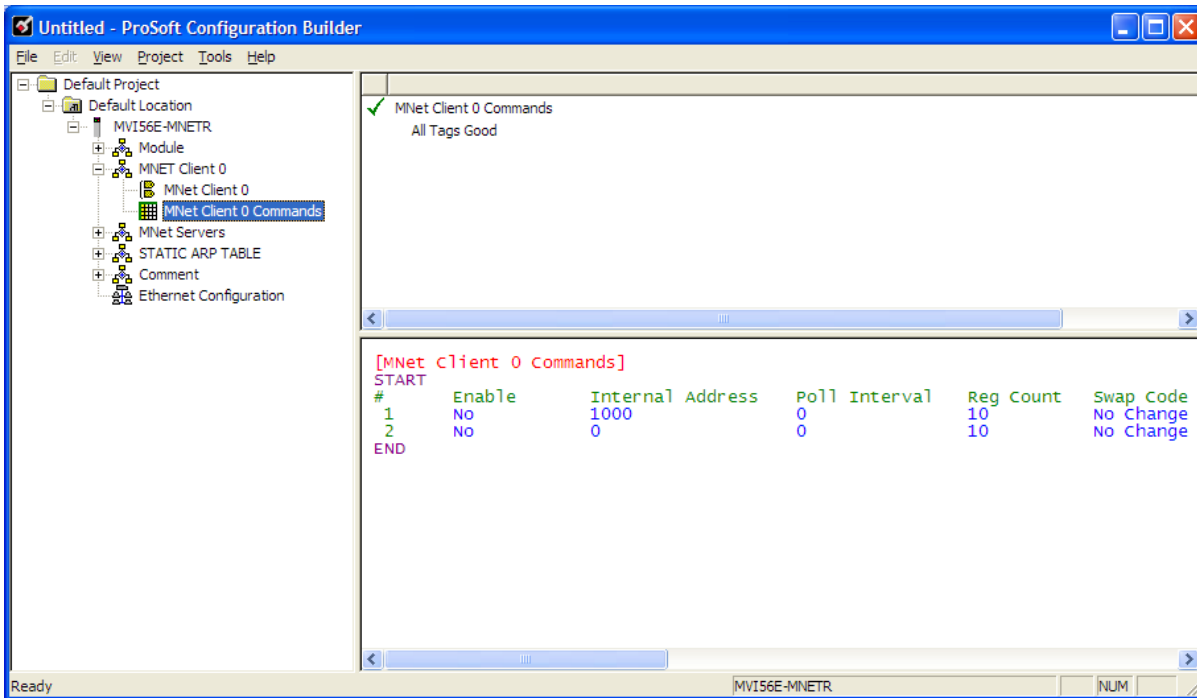

- 2 Double-click the **MNET CLIENT 0 COMMANDS** tag to open the **EDIT MNET CLIENT 0 COMMANDS** dialog box.

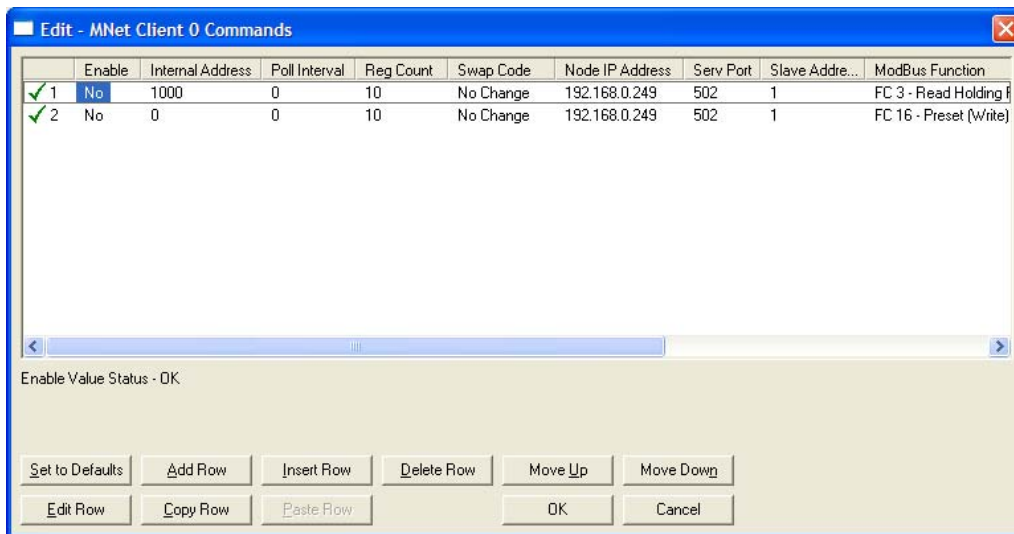

- 3 Select the first command in the list, and then click **EDIT ROW**.

Configure the Modbus Client Read Command

The Modbus Read Command reads 10 words of data from the Quantum processor (Modbus Slave) and transfers it to the MVI56E-MNETR module's internal database. The following table describes the relationship between memory addresses in the Modbus Master (MVI56E-MNETR) and the Modbus Slave (Quantum processor).

MVI56E-MNETR Database Address	Quantum Memory Address
1000	400801
1001	400802
1002	400803
1003	400804
1004	400805
1005	400806
1006	400807
1007	400808
1008	400809
1009	400810

In the sample configuration, the Modbus Read Command is present, but disabled. To enable the command, change the **ENABLE** field from No to **YES**, as shown in the following illustration.

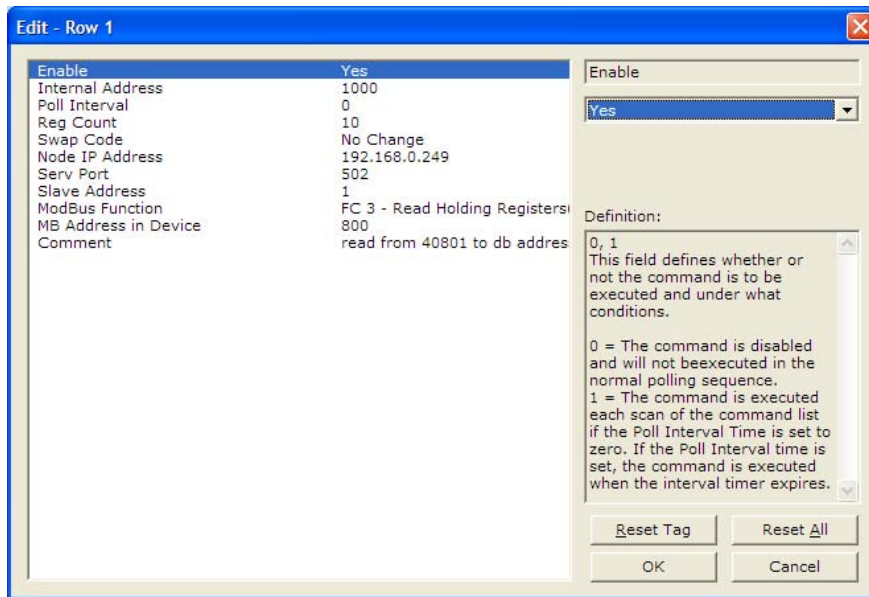

Notes:

- Func 3 represents Modbus Function Code 3, the command code to Read Holding Registers
- The DevAddress parameter is 0-based so 800 = 400801, 801 = 400802, and so on.
- The Enable code must be set to 1 to enable the command (0 = disable)
- The destination Slave node address must be set as 1 (Node parameter)

Configure the Modbus Client Write Command

The Modbus Write Command will write data from the MVI56E-MNETR module to the Quantum processor as follows.

MVI56E-MNETR Database Address	Quantum Memory Address
0	400401
1	400402
2	400403
3	400404
4	400405
5	400406
6	400407
7	400408
8	400409
9	400411

In the sample configuration, a Modbus Write Command is present, but disabled. To enable this command, change the **ENABLE** field from No to **YES**, as shown in the following illustration.

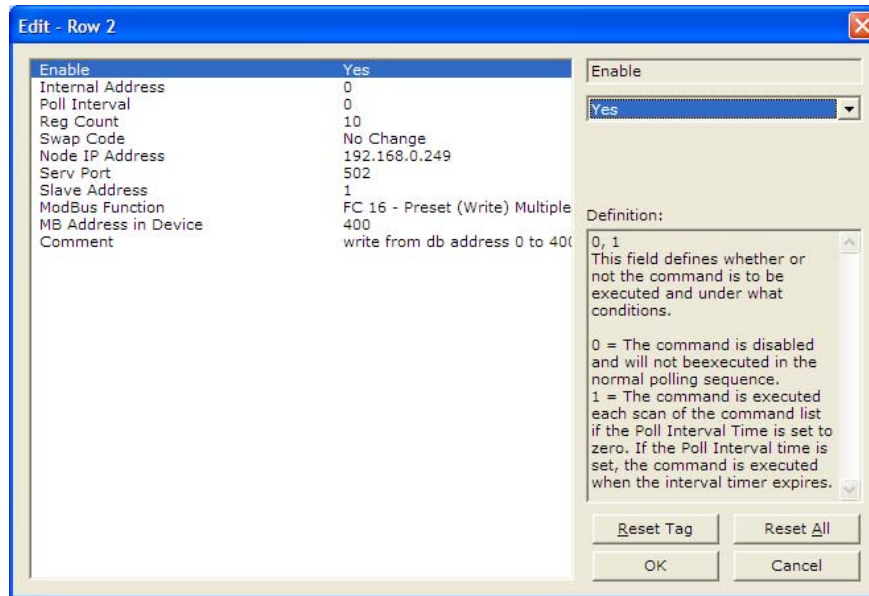

Notes:

- Func 16 represents Modbus Function Code 16, the command code to Preset (Write) Holding Registers
- The DEVADDRESS parameter is 0-based so 400 = 400401, 401 = 400402, and so on.
- The ENABLE code must be set to 1 to enable the command (0 = disable).
- The destination Slave node address must be set as 1 (Node parameter)

5.5 Download the Project to the Module

In order for the module to use the settings you configured, you must download (copy) the updated Project file from your PC to the module.

- 1 In the tree view in ProSoft Configuration Builder, click once to select the MVI56E-MNETR module.
- 2 Open the **PROJECT** menu, and then choose **MODULE / DOWNLOAD**.

This action opens the **DOWNLOAD** dialog box. Notice that the Ethernet address field contains the temporary IP address you assigned in the previous step. ProSoft Configuration Builder will use this temporary IP address to connect to the module.

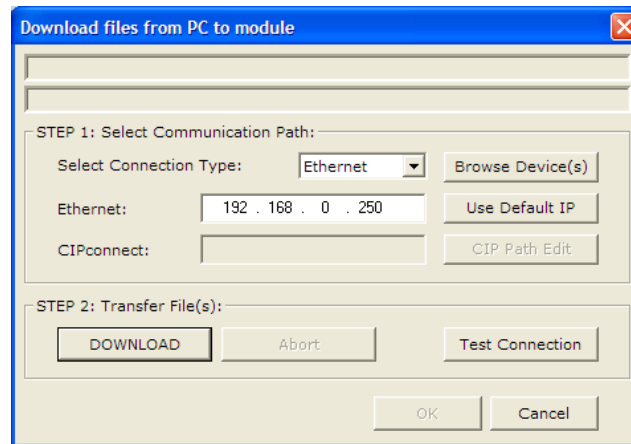

Click **TEST CONNECTION** to verify that the temporary IP address is correct.

- 3 If the connection succeeds, click **DOWNLOAD** to transfer the Ethernet configuration to the module.

If the Test Connection procedure fails, you will see an error message. To correct the error, follow these steps.

- 1 Click **OK** to dismiss the error message.
- 2 On the **DOWNLOAD** dialog box, click **BROWSE DEVICES** to open **PROSOFT DISCOVERY SERVICE**.

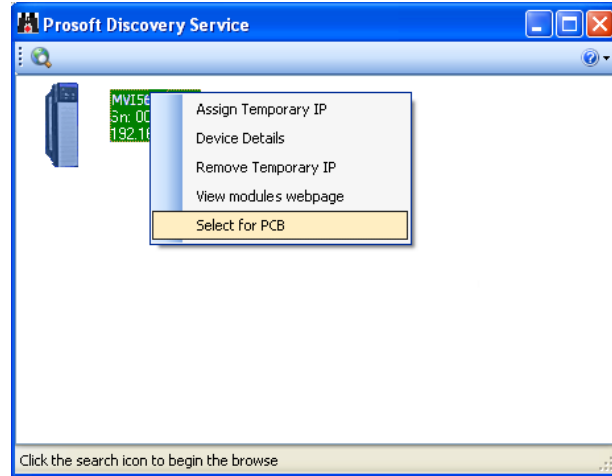

- 3 Select the module, and then click the right mouse button to open a shortcut menu. On the shortcut menu, choose **SELECT FOR PCB**.
- 4 Close ProSoft Discovery Service.
- 5 Click **DOWNLOAD** to transfer the configuration to the module.

5.6 Configure the NOE Ethernet adapter for Modbus TCP/IP (Server)

The next part of this tutorial is to configure the remote Modbus TCP/IP Server. For this example, the Modbus TCP/IP Server will be a NOE communication adapter.

The IP Address for the Modbus TCP/IP Server must match the IP Address settings for the MNET Client 0 Commands in ProSoft Configuration Builder.

The following illustration shows the **ETHERNET / I/O SCANNER** dialog box with the NOE card configured as a Modbus TCP/IP Server in Concept version 2.6.

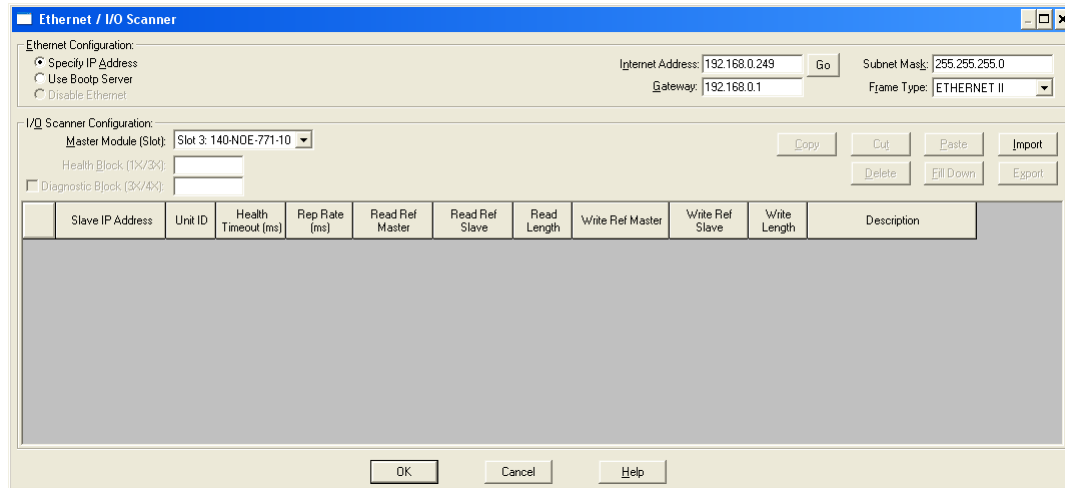

5.7 Connect the MVI56E-MNETR Module to the Modbus TCP/IP Server

The final part of this tutorial is to connect the supplied Ethernet cable to the Ethernet Application Port on the MVI56E-MNETR module either directly, or through an Ethernet hub or switch, to the Ethernet port on an NOE card in the same rack with the Quantum processor.

The following illustration shows the Ethernet connection between the MVI56E-MNETR module and the Quantum processor.

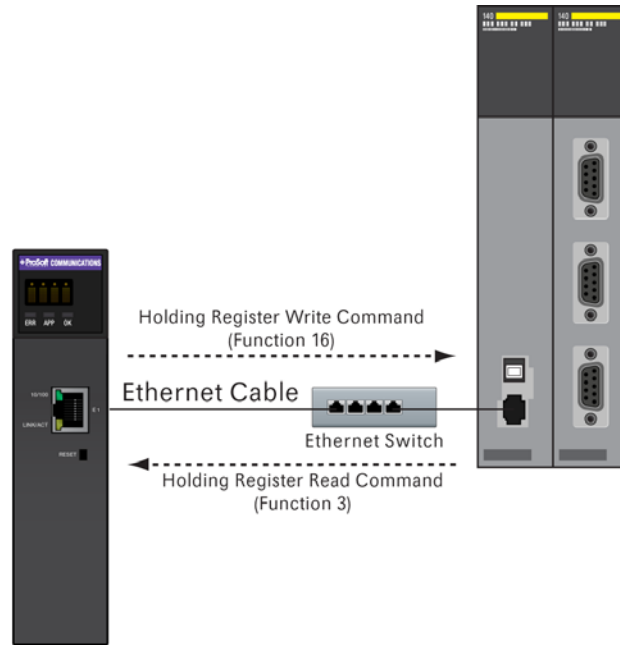

5.8 Verify Communication

There are several ways to verify that the MVI56E-MNETR module is communicating with the processor and with the Modbus TCP/IP network. You can:

- View Exchanged Data
- View the Module Status in the RSLogix 5000 Controller Tags
- View the LED Status Indicators (page 64)

5.8.1 View Exchanged Data

The following illustration describes the source and destination for the data exchanged by the two Modbus TCP/IP Client Commands.

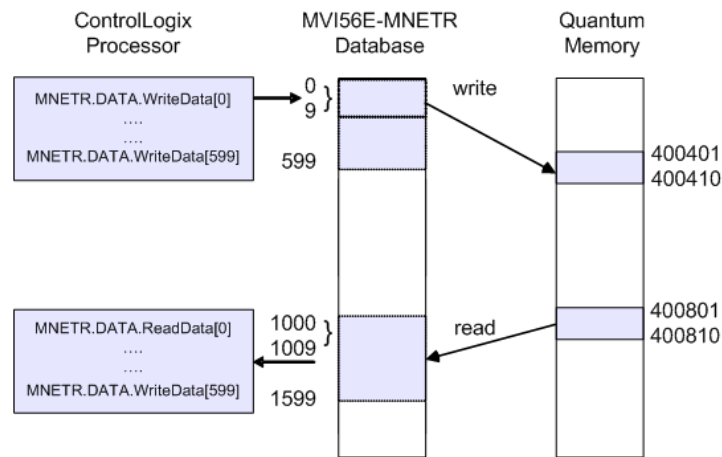

Check Write Data

The following steps show you how to verify that the WriteData Command is working.

- 1 In RSLogix, navigate to the processor controller tags **MNETR.DATA.WRITEDATA[0]** through **MNETR.DATA.WRITEDATA[9]**.
- 2 For words **[0]** through **[9]**, enter the numbers shown in the following illustration.

[-] MNETR.DATA.WriteData	{...}
[+] MNETR.DATA.WriteData[0]	1
[+] MNETR.DATA.WriteData[1]	2
[+] MNETR.DATA.WriteData[2]	3
[+] MNETR.DATA.WriteData[3]	4
[+] MNETR.DATA.WriteData[4]	5
[+] MNETR.DATA.WriteData[5]	6
[+] MNETR.DATA.WriteData[6]	7
[+] MNETR.DATA.WriteData[7]	8
[+] MNETR.DATA.WriteData[8]	9
[+] MNETR.DATA.WriteData[9]	10
[+] MNETR.DATA.WriteData[10]	0

This action sends the values you entered to the **MODBUS CLIENT 0** on the MVI56E-MNETR, and then to the Quantum processor, where you will be able to see the data in Concept.

- 3 In Concept, navigate to the **REFERENCE DATA EDITOR** to monitor the processor memory addresses from 400401 through 400410. The data should match the data you sent from RSLogix 5000.

RDE Template (untitled) - Animation ON				
	Variable Name	Data Type	Address	Value
1				
2			400401	1
3			400402	2
4			400403	3
5			400404	4
6			400405	5
7			400406	6
8			400407	7
9			400408	8
10			400409	9
11			400410	10

Check Read Data

The following steps show you how to verify that the ReadData Command is working.

- 1 In Concept, navigate to the **REFERENCE DATA EDITOR**, and enter the following values in processor memory addresses from 400801 through 400810 as shown in the following illustration.

RDE Template (untitled) - Animation ON				
	Variable Name	Data Type	Address	Value
14				
15			400801	101
16			400802	102
17			400803	103
18			400804	104
19			400805	105
20			400806	106
21			400807	107
22			400808	108
23			400809	109
24			400810	110

This action populates the memory addresses in the Quantum processor that the MVI56E-MNETR will attempt to retrieve with the ReadData Command.

- 2 In RSLogix 5000, the values in **MNETR.DATA.READDATA[0]** through **[9]** should match the data you entered in Concept.

[-] MNETR.DATA.ReadData	{...}
[+] MNETR.DATA.ReadData[0]	101
[+] MNETR.DATA.ReadData[1]	102
[+] MNETR.DATA.ReadData[2]	103
[+] MNETR.DATA.ReadData[3]	104
[+] MNETR.DATA.ReadData[4]	105
[+] MNETR.DATA.ReadData[5]	106
[+] MNETR.DATA.ReadData[6]	107
[+] MNETR.DATA.ReadData[7]	108
[+] MNETR.DATA.ReadData[8]	109
[+] MNETR.DATA.ReadData[9]	110

Tip: Repeat these tests, using different values each time, to verify that the same data appears in the proper place in each processor.

5.8.2 Check Module Status through ControlLogix Controller Tags

You can view network status through the ControlLogix controller tags that are updated through the MVI56E-MNETR sample ladder.

To verify that the Modbus TCP/IP Client is communicating with one or more Modbus TCP/IP Servers, view the contents of the two ReadData array elements beginning at the address you used for the **COMMAND ERROR POINTER** parameter, minus the value of the **READ REGISTER START** parameter.

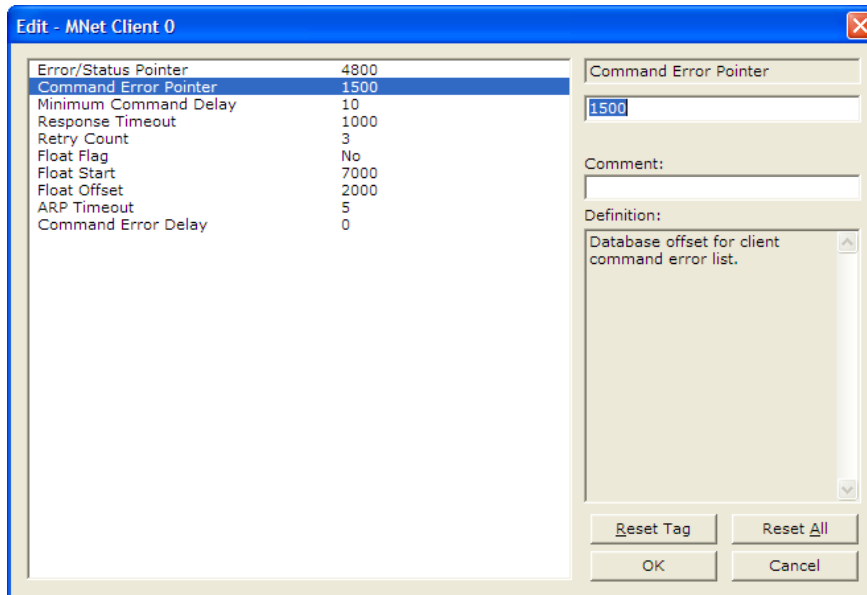

In this case, the **COMMAND ERROR POINTER** was set to 1500 and the **READ REGISTER START** to 1000. This means that $(1500 - 1000 = 500)$; so **READDATA[500]** and **READDATA[501]** will tell you the individual status of each of the two commands issued by the module.

To verify that the Modbus TCP/IP Server is communicating with a Modbus TCP/IP Client, view the contents of the **MNETR.STATUS.CLIENTSTATUS** tag for total commands issued, responses received, errors, and so on.

[-] MNETR.STATUS.ClientStatus	{...}
[+] MNETR.STATUS.ClientStatus.CmdReq	26
[+] MNETR.STATUS.ClientStatus.CmdResp	26
[+] MNETR.STATUS.ClientStatus.CmdErr	0
[+] MNETR.STATUS.ClientStatus.Requests	26
[+] MNETR.STATUS.ClientStatus.Responses	26
[+] MNETR.STATUS.ClientStatus.ErrSent	0
[+] MNETR.STATUS.ClientStatus.ErrRec	0
[+] MNETR.STATUS.ClientStatus.CfgErrWord	256
[+] MNETR.STATUS.ClientStatus.CurErr	0
[+] MNETR.STATUS.ClientStatus.LastErr	0

The following controller tags should increment periodically, indicating that the Modbus TCP/IP Client is continuously sending commands and receiving responses:

- **MNETR.STATUS.CLIENTSTATUS.CMDREQ**
- **MNETR.STATUS.CLIENTSTATUS.CMDRESP**
- **MNETR.STATUS.CLIENTSTATUS.REQUESTS**
- **MNETR.STATUS.CLIENTSTATUS.RESPONSES**

If the error counters continuously increment, the **LASTERROR** controller tag value shows the command index that caused the latest failure.

+	MNETR.STATUS.ClientStatus.CurErr	0
+	MNETR.STATUS.ClientStatus.LastErr	0

5.8.3 LED Status Indicators

Scrolling LED Status Indicators

The scrolling LED display indicates the module's operating status as follows:

Initialization Messages

Code	Message
Boot / DDOK	Module is initializing
Ladd	Module is waiting for required module configuration data from ladder logic to configure the application port(s)
Waiting for Processor Connection	<p>Module did not connect to processor during initialization</p> <ul style="list-style-type: none"> ▪ Sample ladder logic or AOI is not loaded on processor ▪ Module is located in a different slot than the one configured in the ladder logic/AOI ▪ Processor is not in RUN or REM RUN mode
Last config: <date>	Indicates the last date when the module changed its IP address. You can update the module date and time through the module's web page, or with the optional MVI56E Optional Add-On Instruction.
C0 (Client): CmdCnt: X MinDly : X CmdOffs: X RespTmout : X Retries : X ErrOffs : X ARPTmout : X ErrDelay : X FltFlag : X FltSt : X FltOffs : X SVR (server) : BOffs: X WIOffs : X OutOffs : X HoldOffs : X FltFlag : X FltSt : X FltSt : X CommTmout : X	<p>After power up and every reconfiguration, the module will display the configuration the application port(s). The information consists of:</p> <p>Client</p> <ul style="list-style-type: none"> ▪ CmdCnt : number of commands configured for the client ▪ MinDly : Minimum Command Delay parameter ▪ CmdOffs : Command Error Pointer parameter ▪ RespTmout : Response Timeout parameter ▪ Retries : Retry Count parameter ▪ ErrOffs : Error/Status Offset parameter ▪ ARPTmout : ARP Timeout parameter ▪ ErrDelay: Command Error Delay parameter ▪ FltFlag: Float Flag parameter ▪ Flt St : Float Start parameter ▪ FltOffs : Float Offset parameter <p>Server</p> <ul style="list-style-type: none"> ▪ BOffs: Bit Input Offset parameter ▪ WIOffs : Word Input Offset parameter ▪ OutOffs : Output offset parameter ▪ HoldOffs : Holding Register offset parameter ▪ FltFlag: Float Flag parameter ▪ Flt St : Float Start parameter ▪ FltOffs : Float Offset parameter

Operation Messages

After the initialization step, the following message pattern will be repeated.

<Backplane Status> <IP Address> <Backplane Status> <Port Status>

Code	Message
<Backplane Status>	OK: Module is communicating with processor ERR: Module is unable to communicate with processor. For this scenario, the <Port Status> message above is replaced with "Processor faulted or is in program mode".
<IP Address>	Module IP address
<C0>	OK: Port is communicating without error Communication Errors: port is having communication errors. Refer to PCB diagnostics for further information about the error.

Ethernet LED Indicators

The Ethernet LEDs indicate the module's Ethernet port status as follows:

LED	State	Description
Data	Off	Ethernet connected at 10Mbps duplex speed
	Amber Solid	Ethernet connected at 100Mbps duplex speed
Link	Off	No physical network connection is detected. No Ethernet communication is possible. Check wiring and cables.
	Green Solid or Blinking	Physical network connection detected. This LED must be on solid for Ethernet communication to be possible.

Non-Scrolling LED Status Indicators

The non-scrolling LEDs indicate the module’s operating status as follows:

LED Label	Color	Status	Indication
APP	Red or Green	OFF	The module is not receiving adequate power or is not securely plugged into the rack. May also be OFF during configuration download.
		GREEN	The MVI56E-MNETR is working normally.
		RED	The most common cause is that the module has detected a communication error during operation of an application port. The following conditions may also cause a RED LED: <ul style="list-style-type: none"> ▪ The firmware is initializing during startup ▪ The firmware detects an on-board hardware problem during startup ▪ Failure of application port hardware during startup ▪ The module is shutting down ▪ The module is rebooting due to a ColdBoot or WarmBoot request from the ladder logic or Debug Menu
OK	Red or Green	OFF	The module is not receiving adequate power or is not securely plugged into the rack.
		GREEN	The module is operating normally.
		RED	The module has detected an internal error or is being initialized. If the LED remains RED for over 10 seconds, the module is not working. Remove it from the rack and re-insert it to restart its internal program.
ERR	Red	OFF	The battery voltage is OK and functioning.
		ON	The battery voltage is low or battery is not present. Allow battery to charge by keeping module plugged into rack for 24 hours. If ERR LED still does not go off, contact ProSoft Technology, as the battery is not a user-serviceable item.

6 Building on Success

In This Chapter

- ❖ Frequently Asked Questions 68

Now that you have successfully installed, configured, and verified operation of the MVI56E-MNETR module, you should have a better understanding of how to make it work for your specific application. The following resources are available to help you build on your success.

- For more information about the MVI56E-MNETR module, including detailed hardware and software configuration, troubleshooting, and application information, refer to the *MVI56E-MNETR User Manual*.
- For technical support and warranty information for your MVI56E-MNETR module, refer to *Support, Service, and Warranty* in the *MVI56E-MNETR User Manual*.
- For more information on ProSoft Technology products and services, please visit www.prosoft-technology.com.

6.1 Frequently Asked Questions

6.1.1 *What are the differences between the MVI56 and the MVI56E modules? What does the "E" stand for?*

The "E" stands for **E**nhanced with **E**thernet communication capabilities. The new enhancements are:

- **PCB:** ProSoft Configuration Builder software; a Windows-based configuration utility providing a graphical user interface for module diagnostics with screen navigation, improving interoperability with the module.
- **Seamless Migration:** MVI56E products are backward compatible with existing ladder logic and module configuration files, allowing for a smooth transition when upgrading MVI56 products.
- **Personality Module:** The MVI56E incorporates a non-volatile CF (Industrial Compact Flash) memory card for storing the modules setup and network configuration data (or personality). This feature benefits the end-user with quick replacement of modules for disaster recovery. Restore a module by a simple exchange of the Personality Module with absolutely no PC or configuration requirements.
- **Ethernet Configuration port:** Allows for remote module connectivity. Replaces the serial communication port, becoming the primary configuration port with faster access.
- **Web server:** Provides HTML information about the status of the product, download access to documents such as the product manual, and for firmware updates. Components are stored locally in the modules flash memory.
- **LED Display:** The LED provides detailed, plain English diagnostics and error information for the module, backplane communication, and network conditions.
- **Discovery Service:** Allows PCB configuration software (or separate utility) to find and display products located on the network with key product attributes such as name, serial number, and IP address. The user will be able to change IP address, upload/download, and enter into diagnostics from the list.
- **CIPconnect[®]-enabled:** Allows end-users to use PCB from remote locations to local and remote chassis installed MVI56E module(s) through a 1756-ENxT. Multi hop (Ethernet and ControlNet[™]) connections are supported. RSLinx OEM is not required.

6.1.2 What is the difference between the MVI56E-MNET(R) and the MVI56E-MNETC(R)?

The MNETC and MNETCR modules support up to 30 Modbus TCP/IP Clients, while the MNET and MNETR modules support one Client.

- If your ControlLogix application needs to poll a large number of Modbus TCP/IP Server devices, and requires quick responses from these servers, you can divide the Servers among multiple Clients, and avoid timeouts if an individual Server does not respond to a Modbus TCP/IP command from a Client. The single Modbus TCP/IP Server in the MNET and MNETR modules must open and close connections to each server device they talk to, whereas the MNETC or MNETCR can have connect each client connect to its own server device and keep these connections open, thereby improving performance. The MNETC and MNETCR modules act as Modbus TCP/IP Clients only.
- If your application must respond to commands from another Modbus TCP/IP Client on the network, use the MNET or MNETR module. The MNET and MNETR modules can act as both a Modbus TCP/IP Server and as a Modbus TCP/IP Client

6.1.3 Is the MVI56E product a direct replacement to my existing MVI56 product?

Yes

6.1.4 How is the MVI56E-MNETR configured?

The module is configured using ProSoft Configuration Builder (PCB) software via the module's Ethernet port or through the backplane using CIPconnect[®]. The product no longer requires Windows HyperTerminal for configuration and does not come with a serial port.

6.1.5 What is ProSoft Configuration Builder (PCB)?

ProSoft Configuration Builder (PCB) provides a quick and easy way to manage module diagnostics and troubleshooting operations. Built-in module diagnostics menus and the serial port data stream analyzer can be accessed using PCB through the module's high-speed Ethernet configuration port (E1) or through Rockwell Automation 1756-ENxT or 1756-CNBx communications interfaces using CIPconnect[®].

6.1.6 What is the purpose of the MVI56E-MNETR Ethernet (E1) Port?

The Ethernet port (E1) is the application port as well as the configuration port and allows a remote PC to upload and download configuration files and monitor the module operation through ProSoft Configuration Builder (PCB). The Ethernet port also provides access to the module's webpage, where you can download the module's documentation.

6.1.7 How do I change the module's IP address?

- 1 Use ProSoft Configuration Builder to edit and download the Ethernet configuration to the module.
- 2 Use the Optional Add-On Instruction (AOI) provided with the module. The AOI can be downloaded from the module's web page.

6.1.8 What is the purpose of the Optional MVI56E-MNETR Add-On Instruction?

The Optional Add-On Instruction (AOI) allows the processor to perform the following tasks:

- 1 Set the MVI56E Ethernet settings
- 2 Read the MVI56E Ethernet settings
- 3 Set MVI56E date/time information
- 4 Read the MVI56E date/time information

Items 1 and 2 can also be performed through ProSoft Configuration Builder (PCB) using ProSoft Discovery Service. Items 3 and 4 can also be performed through the module's built-in web page.

The Optional AOI is needed only for specific applications where Ethernet or CIPconnect access from a programmer's personal computer (PC) to the module is not possible.

6.1.9 Is there a Setup Guide to help with configuration?

The Setup Guide provides an example of how to setup the module and move data between the network and processors. It is stored on the module, and can be downloaded to a PC.

6.1.10 What is ProSoft Discovery Service (PDS)?

ProSoft Discovery Service (PDS) is Windows-based software that connects to the Ethernet port of the module for the following purposes:

- Automatic module discovery on the Ethernet network
- Set a temporary IP address for the module for easy commissioning
- Allow PCB to select the module for monitoring and IP address reconfiguration

The ProSoft Discovery Service software is supplied as a stand-alone utility, as well as being integrated into PCB.

6.1.11 Does the MVI56E-MNETR module require processor logic?

Yes, ladder logic is required for data transfer between the MVI56E module and the ControlLogix[®] processor.

- For RSLogix[™] 5000 version 16 applications (or later), the included Add-On Instruction encapsulates the entire ladder logic into one single instruction.
- For RSLogix 5000 version 15 and older, sample ladder logic is available from the ProSoft Technology[®] website at www.prosoft-technology.com.

6.1.12 How do I monitor MVI56E-MNETR operation?

Module operation can be monitored either through the processor controller tags or through the ProSoft Configuration Builder diagnostic window. Available status information includes number of messages sent, number of messages received, number of errors, and error codes.

6.1.13 Are there any other ways to monitor module diagnostics besides being connected to the module's network (subnet)?

PCB can monitor the module via ControlLogix backplanes and process networks using CIPconnect. The PC running PCB can use its Ethernet port to connect to any 1756-ENxT EtherNet/IP[™] interface module which is on the same Ethernet subnet. Through this connection, PCB can use CIPconnect to route through the ControlLogix backplane to other 1756-ENxT or 1756-CNBx modules, for up to five more route links, to reach an MVI56E module in a chassis connected on EtherNet/IP or ControlNet[™] process networks.

7 Glossary of Terms

A

ASCII

American Standard Code for Information Interchange. A communication mode in which each eight-bit byte in a message contains one ASCII character code. ASCII characters (or hexadecimal characters) are sometimes used as a key to encrypt data and ensure its secure transmission.

C

Client

A client is a software program, or the device on which that program runs, that makes requests for information from a software program, or the device on which that program runs, in a client-server relationship.

A Client on an Ethernet network is equivalent to a Master on a serial network.

D

Default Gateway

The IP address of a network router where data is sent if the destination IP address is outside the local subnet. The gateway is the device that routes the traffic from the local area network to other networks such as the Internet.

E

ESD

Electrostatic Discharge. Can cause internal circuit damage to the coprocessor.

Ethernet

A set of network cabling and network access (CSMA/CD) protocol standards for bus topology computer networks invented by Xerox but now controlled by the 802.3 subcommittee of the IEEE.

F

Firmware

Software for embedded computers.

Full-Duplex

A communications circuit or system designed to simultaneously transmit and receive two different streams of data. Telephones are an example of a full-duplex communication system. Both parties on a telephone conversation can talk and listen at the same time. If both talk at the same time, their two signals are not corrupted.

H

Half-Duplex

A communications circuit or system designed to transmit and receive data, but not both simultaneously. CB or walkie-talkie radios are an example of a half-duplex communication system. Either parties on a radio conversation may talk or listen; but both cannot talk at the same time without corrupting each other's signal. If one operator is "talking", the other must be "listening" to have successful communication.

I

IP Address

A 32-bit identification number for each node on an Internet Protocol network. These addresses are represented as four sets of 8-bit numbers (numbers from 0 to 255), separated by periods ("dots").

Networks using the TCP/IP Protocol route messages based on the IP address of the destination. Each number can be 0 to 255. For example, 192.168.0.100 could be an IP address. Each node on the network must have a unique IP address.

L

LED

Light-emitting diode.

M

MAC ID

A hexadecimal number that uniquely identifies an Ethernet device.

Master

A Master is a device that makes requests for information from a software program, or the device on which that program runs, in a Master-Slave relationship.

A Client on an Ethernet network is equivalent to a Master on a Serial network.

N

Network

A series of stations or nodes connected by some type of communication medium. A network may consist of a single link or multiple links.

Node

An address or software location on the network.

P

Peer-to-Peer

A network relationship between devices where each device can send commands as a master or client, and respond to commands as a slave or server.

Power Supply

Device that supplies electrical power to the I/O chassis containing the processor, coprocessor, or other modules.

Protocol

The language or packaging of information that is transmitted between nodes on a network.

S

Server

A Server is a software program, or the device on which that program runs, that provides a specific kind of service to a Client software program, or the device on which that program runs, on an Ethernet network.

A Server on an Ethernet network is equivalent to a Slave on a Serial network.

Simplex

A communications circuit or system designed to either transmit data or receive data, but not both. Broadcast television is an example of simplex communication system. A television station sends a TV signal but cannot receive responses back from the television sets to which it is transmitting. The TV sets can receive the signal from the TV station but cannot transmit back to the station.

Slave

A Slave is a software program, or the device on which that program runs, which provides a specific kind of service to a Master software program, or the device on which that program runs, on a serial network.

A Slave on a Serial network is equivalent to a Server on an Ethernet network.

Subnet Mask

A mask used to determine what subnet an IP address belongs to. An IP address has two components: the network address, and the host (node or device) address. For example, consider the IP address 150.215.017.009. Assuming this is part of a Class B network (with a subnet mask of 255.255.0.0), the first two numbers (150.215) represent the Class B network address, and the second two numbers (017.009) identify a particular host on this network.

Index

A

About the MODBUS TCP/IP Protocol • 17
Architecture • 20
Are there any other ways to monitor module
diagnostics besides being connected to the
module's network (subnet)? • 71
ASCII • 73

B

Battery Life Advisory • 3
Before You Begin • 11
Building on Success • 67

C

Check Module Status through ControlLogix Controller
Tags • 62
Check Read Data • 61
Check Write Data • 60
CIPconnect • 32
Client • 73
Configure the Modbus Client Read Command • 19, 53
Configure the Modbus Client Write Command • 19, 54
Configure the NOE Ethernet adapter for Modbus
TCP/IP (Server) • 8, 19, 57
Connect the MVI56E-MNETR Module to the Modbus
TCP/IP Server • 58
Connect to the Module's Web Page • 34
Connect your PC to the ControlLogix Processor • 19,
47
Connect your PC to the Module • 25
Create a new RSLogix 5000 project • 19, 37
Create the Module - Remote Rack • 40
Create the Remote Network • 38

D

Default Gateway • 73
Does the MVI56E-MNETR module require processor
logic? • 71
Download the Project to the Module • 19, 55
Download the Sample Program to the Processor • 8,
19, 48

E

Enable the MNET Client 0 Commands • 52
ESD • 73
Ethernet • 73
Ethernet LED Indicators • 65

F

Firmware • 73
Frequently Asked Questions • 68

Full-Duplex • 74

G

General Overview • 18

H

Half-Duplex • 74
How do I change the module's IP address? • 70
How do I monitor MVI56E-MNETR operation? • 71
How is the MVI56E-MNETR configured? • 69

I

Import Add-On Instruction • 43
Important Safety Information - MVI56E Modules • 2
Install ProSoft Configuration Builder • 15
Install the Configuration Tools • 8, 15
Install the Module in the Rack • 24
IP Address • 74
Is the MVI56E product a direct replacement to my
existing MVI56 product? • 69
Is there a Setup Guide to help with configuration? • 70

L

Learning Objectives • 8
LED • 74
LED Status Indicators • 59, 64

M

MAC ID • 74
Master • 74
Memory Map • 21

N

Network • 75
Node • 75
Non-Scrolling LED Status Indicators • 66

P

Peer-to-Peer • 75
Physical Setup • 8, 19, 23
Power Supply • 75
Prerequisites • 10
Procedures • 23
ProSoft Technology Documentation • 9
ProSoft Technology® Product Documentation • 3
Protocol • 75

R

Required Items • 13
Required Steps • 19

S

Sample Files • 14
Scope • 7
Scrolling LED Status Indicators • 64
Server • 75

Set Temporary IP Address • 26, 35
Setting Jumpers • 23
Simplex • 75
Slave • 75
Subnet Mask • 76
System Requirements • 12

T

The Sample Application • 8, 17

U

Upload the Add-On Instruction from the Module • 36,
44
Upload the Sample Configuration from the Module •
19, 50
Using ProSoft Configuration Builder Software • 49

V

Verify Communication • 8, 19, 59
View Exchanged Data • 59

W

What are the differences between the MVI56 and the
MVI56E modules? What does the • 68
What is ProSoft Configuration Builder (PCB)? • 69
What is ProSoft Discovery Service (PDS)? • 71
What is the difference between the MVI56E-MNET(R)
and the MVI56E-MNETC(R)? • 69
What is the purpose of the MVI56E-MNETR Ethernet
(E1) Port? • 70
What is the purpose of the Optional MVI56E-MNETR
Add-On Instruction? • 70
What's New? • 7

Y

Your Feedback Please • 4