

Keysight N9000A CXA X-Series Signal Analyzer

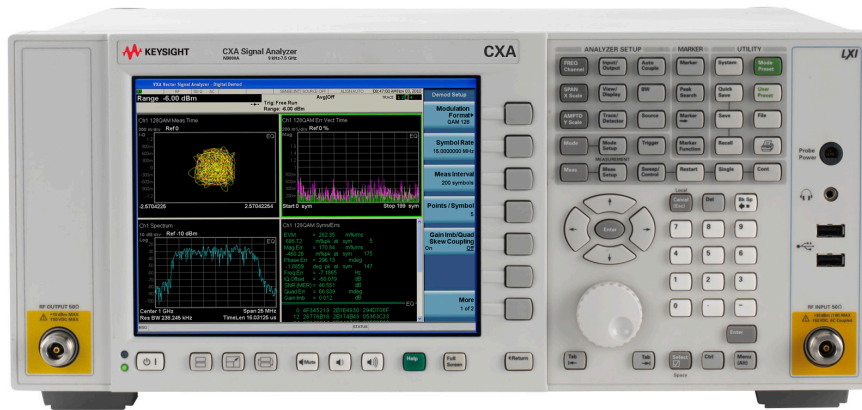

- 9 kHz up to 26.5 GHz frequency range
- Up to +17 dBm TOI, -163 dBm DANL
- ± 0.50 dB absolute amplitude accuracy
- Up to 25 MHz analysis bandwidth
- 9 kHz up to 6 GHz tracking generator

What is X-Series Signal Analysis?

Future-ready

Optimize your investment and extend instrument longevity with upgradeable processor, memory, connectivity, and more to keep your test assets current today and tomorrow.

Consistent measurement framework

Achieve measurement integrity across your organization and drive more productivity in less time by leveraging a proven foundation for signal analysis and identical operation across the X-Series instruments.

Broadest set of applications

Address the changing demands of technology with more than 25 measurement applications, the ability to run software inside the open Windows operating system, and a first-to-market track record in emerging standards.

Stay ready, stay in sync, and arrive ahead—with the Keysight Technologies, Inc. X-Series.

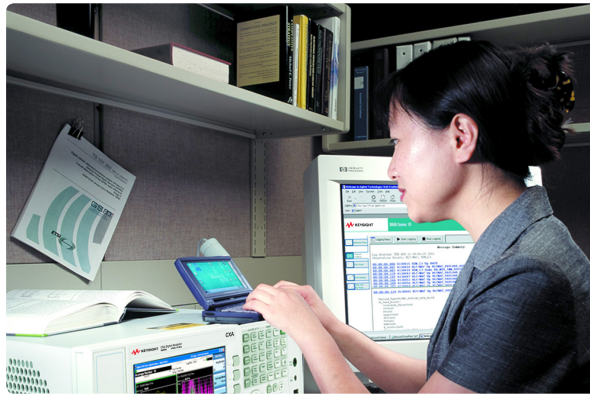

Summary of Key Specifications

	RF	Microwave
Frequency ranges	Minimum: 9 kHz	Minimum: 9 kHz
	Maximum: 3.0, 7.5 GHz	Maximum: 13.6, 26.5 GHz
Analysis bandwidth	10 MHz (standard)	10 MHz (standard)
	25 MHz (optional)	25 MHz (optional)
Displayed average noise level (DANL)	-163 dBm at 1 GHz, preamplifier on	-163 dBm at 1 GHz, -147 dBm at 26.5 GHz, preamplifier on
Third-order intermodulation (TOI) distortion	+17 dBm at 1 GHz	+15 dBm at 1 GHz, +14 dBm at 26.5 GHz
W-CDMA ACLR dynamic range	63 dBc (66 dBc with noise correction on)	66 dBc (73 dBc with noise correction on)
Phase noise	-102 dBc/Hz (10 kHz offset, 1 GHz carrier)	-102 dBc/Hz (10 kHz offset, 1 GHz carrier)
Amplitude accuracy	± 0.50 dB	± 0.50 dB

www.keysight.com/find/X-Series

Master the Essentials

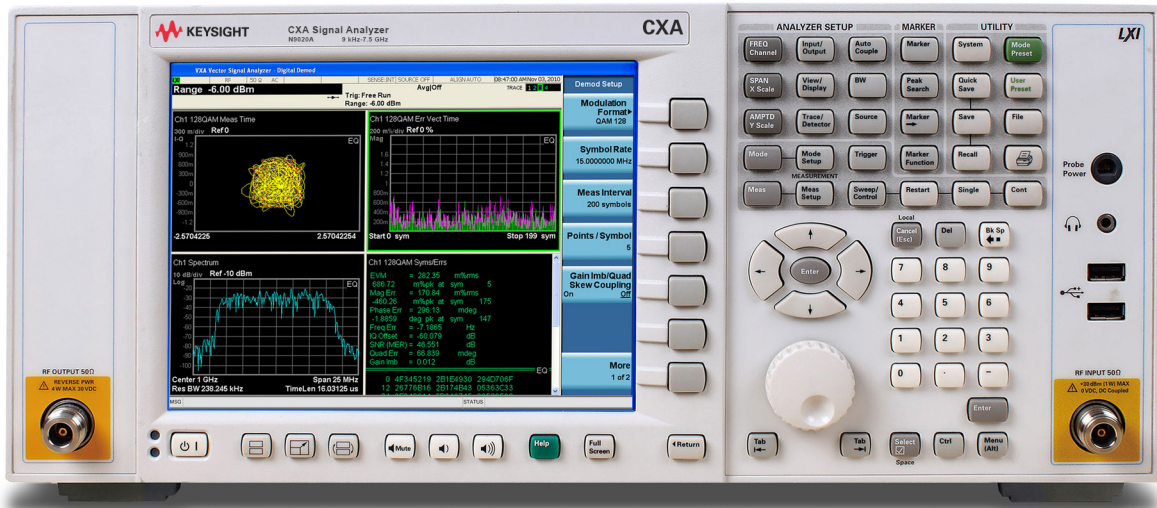

A great low-cost signal analyzer surpasses the basics and delivers crucial functionality. That's the strength of the CXA signal analyzer, the leading low-cost tool for essential signal characterization. Its capabilities provide a foundation for cost-effective testing and seamless integration with the other X-Series models. The CXA is also an excellent teaching tool for RF and microwave technologies and signal analysis. Get must-have capability with X-Series expandability in the CXA—and master the essentials.

Master the essentials in product development

The CXA helps you accelerate product development and design, while staying within your equipment budget. The ability to add measurement applications and 89600 VSA software allows you to work in more than 75 different modulation formats.

Master the essentials in RF and microwave education

The CXA is also an excellent tool for the teaching of RF and microwave signal analysis, from basic circuit characterization to advanced signal analysis. Beyond its versatile range of built-in capabilities, you can add 89600 VSA software as well as easily integrate the CXA into analysis environments such as MATLAB.

Master the essentials in manufacturing test

With general-purpose signal analysis and a variety of license key upgradable measurement applications, you can quickly and easily reconfigure the CXA to fit changing requirements in manual or automated testing. You can also improve system uptime with the proven reliability of the X-Series technology platform.

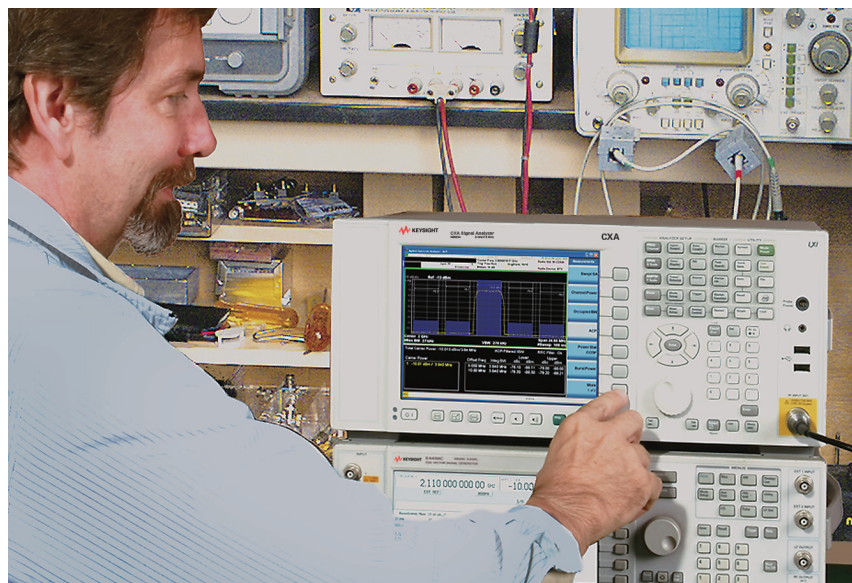

Add Dependable Signal Analysis to Manufacturing Test

The CXA is ideal for manual or automated testing of RF and microwave components such as amplifiers and filters, as well as electronic products such as cordless phones, wireless LAN routers, and wireless paging systems. Whether you are pursuing cost-reduction initiatives or greater throughput, the flexible, dependable CXA can enhance your manufacturing process.

Measurement capabilities include general-purpose spectrum analysis and one-button PowerSuite measurements. The optional built-in tracking generator¹ provides a fast and cost-effective solution for scalar network analysis. The additional 75 Ω input connector¹ helps make an easy cable TV signal measurement. For greater flexibility, you can quickly configure—and reconfigure—the CXA with more than 25 of software applications for specific measurements including analog demodulation, digital video, and wireless connectivity. Licensing upgrades make transitions fast and easy.

For automated test systems, the CXA provides GPIB, USB 2.0, and LAN (1000Base-T) connections, and is LXI class C compliant. In addition to SCPI programmability, the CXA is code-compatible with Keysight ESA spectrum analyzers, making it easy to move up to the CXA. The CXA is also remote-language compatible with all other Keysight X-Series signal analyzers.

In manual testing applications, learning is fast with the Windows-based user interface. In addition, operators who are familiar with the Keysight ESA Series will appreciate the similarity of the CXA. Whenever questions do arise, the CXA's built-in help function provides fast access to the information you need to move forward.

Whether on the bench or integrated in a system, the CXA is designed to promote uptime with the proven reliability of the X-Series hardware and software platform—also used in the Keysight EXA, MXA, and PXA signal analyzers.

Express CXA

If you do not require specialized functionality, such as measurement applications or wider bandwidth, then a preconfigured CXA signal analyzer may be appropriate for you. Available through Keysight's distribution partners, these express configurations offer excellent value and the fastest delivery. For more information on the N9000AEP, see the CXA signal analyzer configuration guide (5990-4341EN).

www.keysight.com/find/express_CXA

1. Supported on models up to 7.5 GHz frequency range.



You can upgrade!

Options can be added after your initial purchase.

All of our X-Series application options are license-key upgradeable.



Control Costs with Essential R&D Measurements



Whether you're rapidly updating a next-generation product or revising an existing design, the CXA can help you perform signal characterization for testing, verification, and troubleshooting. The CXA's built-in capabilities allow you to obtain essential measurements of frequency, level, spurious, and distortion without overspending your budget.

For example, you can quickly measure spurs and harmonics by leveraging the speed and solid DANL performance of the CXA. In addition, you can make one-button measurements such as channel power, adjacent channel power (ACP), and occupied bandwidth (OBW) with PowerSuite.

The CXA's built-in tracking generator provides a cost-effective solution for RF scalar network analysis allowing you to characterize the behavior of components or subsystems such as frequency response and insertion loss or gain.

Perform flexible digital modulation analysis with the W9064A VXA vector signal analysis measurement application, a general-purpose FFT-based spectrum analysis application with a wide selection of demodulation types and filters. Add the W9069A noise figure measurement application for one-button noise figure and gain measurements to help you design and evaluate your devices or receiv-

ing systems. Transform the CXA into a cost-effective EMI pre-compliance solution with the W6141A EMI measurement application to identify EMI problems earlier in the development process. These applications are tightly integrated with the CXA signal analyzer and SCPI programmable for easier operation.

On its own, the CXA supports low-cost research and design projects. As part of the Keysight X-Series, the CXA lets you leverage your expertise—and test procedures—across the EXA, MXA, and PXA, and across the life cycle of your product.

Enhance Theory with Practical Skills in Your Educational Lab

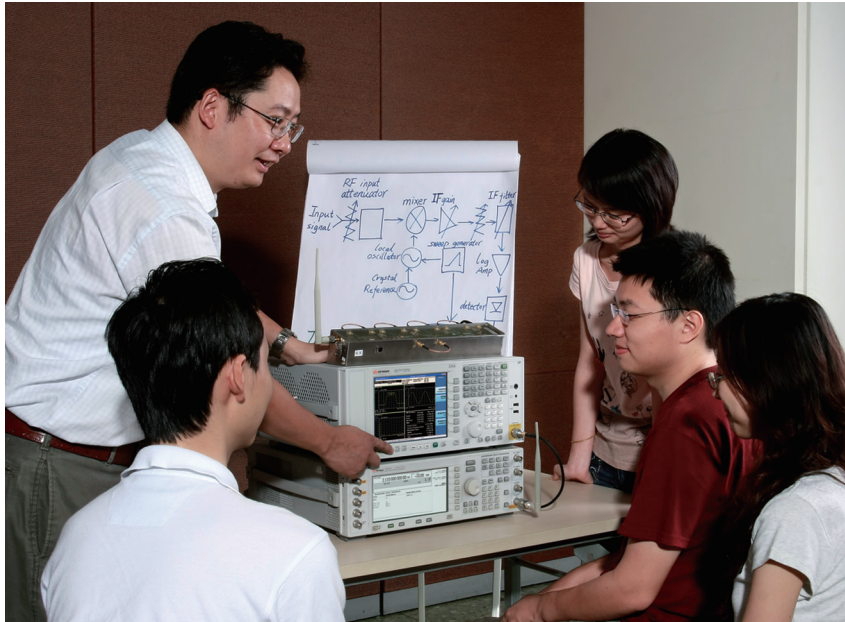

Help students explore RF concepts

The Keysight Y1800A RF training kit and Y1801A RF principle teaching slides can help students explore concepts in RF basics, circuit design, and communication systems. The whole solution includes RF transceiver training boards, lab sheets, and lecture materials. When performing the exercises, the N9310A signal generator is a useful companion to the CXA signal analyzer.

For deeper insight into RF technology, the Keysight 89600 VSA software allows students to view what's happening inside complex wireless devices.

www.keysight.com/find/89600
www.keysight.com/find/RFkit

Whether their goal is to perform research or work in industry, the next generation of RF and microwave engineers can learn a lot with the CXA and its easy-to-use measurement capabilities. In your educational lab, students can develop practical skills and deeper insights into RF and microwave technologies through the fundamentals of signal analysis. You can also address future measurement needs with the flexibility of X-Series measurement applications and the 89600 VSA software.

The familiar and intuitive Windows-based X-Series interface lets your students focus on learning measurement techniques rather than instrument operation—skills that are applicable to across the Keysight X-Series product line.

Easily integrate the CXA into popular analysis environments such as MATLAB for data analysis, visualization, and publication using the instrument's open Windows platform. You can also utilize visual programming environments such as Keysight VEE Education for computation, simulation, and instrument control.

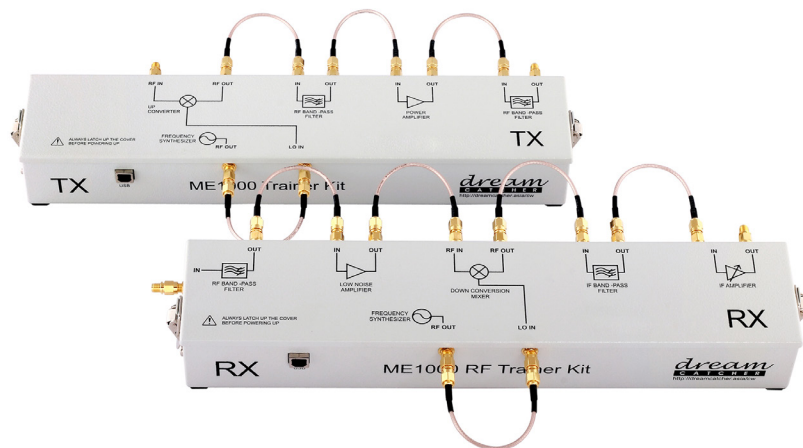

CXA Front and Rear Panels

View traces, results, and status easily on the 21.4 cm, high resolution XGA display.

Use up to six traces and three different detectors simultaneously.

Comprehensive marker functions for measuring a specific point/segment of data.

Select a mode or measurement for your specific application.

Control instrument configuration, I/O setup files, printers, and instrument presets.

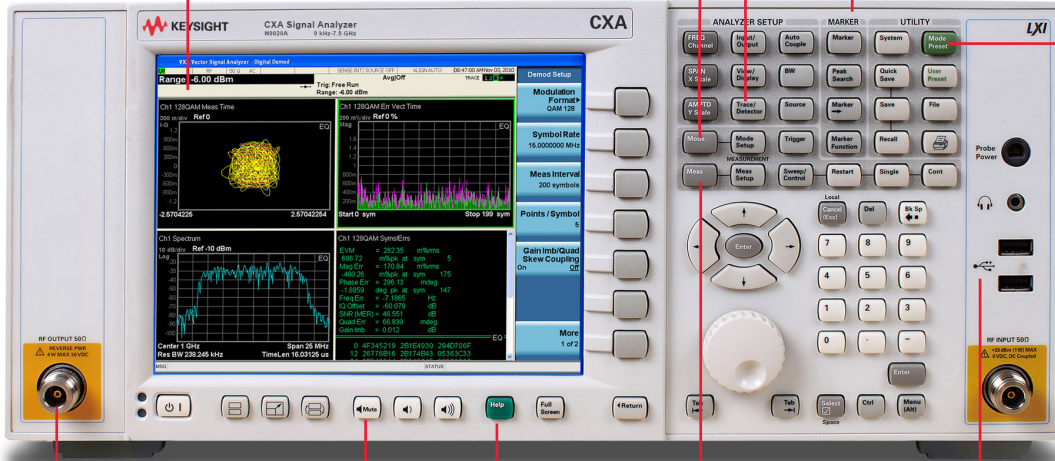

Built-in tracking generator for low-cost scalar network analysis or additional 75 Ω input for cable TV analysis (on models up to 7.5 GHz frequency range)

Increase, decrease, or mute the speaker volume.

Get answers quickly from the comprehensive, context-sensitive help system.

Built-in PowerSuite for easy one-button power measurements.

Connect USB devices through the convenient front-panel ports.

Send and receive SCPI commands over the GPIB interface.

Control the CXA remotely with an external PC through the type-B USB 2.0 interface.

Connect peripherals and transfer data via the USB 2.0 (type-A port) interface.

Control the CXA remotely through 1000Base-T LAN port and LXI compatibility.

Wideband IF output



Evaluate noise figure using SNS or 346 Series noise sources and the W9069A measurement application.

View the display on an external VGA monitor.

Start measurements based on specific conditions by connecting external trigger signals.

Use the CXA in an aerospace and defense environment with 50/60/400 Hz power input.

Removable solid-state drive for instrument security

Related Literature

Data Sheet 5990-4327EN

Configuration Guide 5990-4341EN

X-Series Measurement Applications Brochure 5989-8019EN

X-Series Signal Analysis Brochure 5990-7998EN

Evolving Since 1939

Our unique combination of hardware, software, services, and people can help you reach your next breakthrough. We are unlocking the future of technology.

From Hewlett-Packard to Agilent to Keysight.

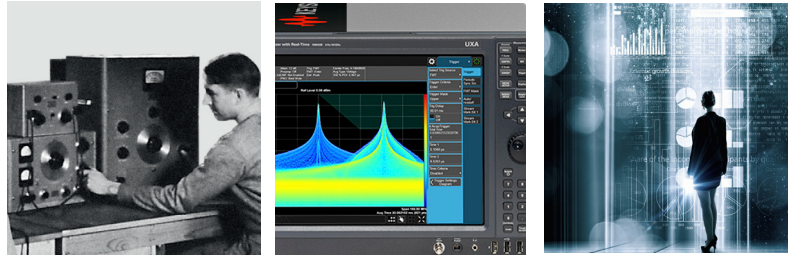

For more information on Keysight Technologies' products, applications or services, please contact your local Keysight office. The complete list is available at: www.keysight.com/find/contactus

Americas

Canada	(877) 894 4414
Brazil	55 11 3351 7010
Mexico	001 800 254 2440
United States	(800) 829 4444

Asia Pacific

Australia	1 800 629 485
China	800 810 0189
Hong Kong	800 938 693
India	1 800 11 2626
Japan	0120 (421) 345
Korea	080 769 0800
Malaysia	1 800 888 848
Singapore	1 800 375 8100
Taiwan	0800 047 866
Other AP Countries	(65) 6375 8100

Europe & Middle East

Austria	0800 001122
Belgium	0800 58580
Finland	0800 523252
France	0805 980333
Germany	0800 6270999
Ireland	1800 832700
Israel	1 809 343051
Italy	800 599100
Luxembourg	+32 800 58580
Netherlands	0800 0233200
Russia	8800 5009286
Spain	800 000154
Sweden	0200 882255
Switzerland	0800 805353
	Opt. 1 (DE)
	Opt. 2 (FR)
	Opt. 3 (IT)
United Kingdom	0800 0260637

For other unlisted countries: www.keysight.com/find/contactus (BP-9-7-17)



www.keysight.com/go/quality
 Keysight Technologies, Inc.
 DEKRA Certified ISO 9001:2015
 Quality Management System

myKeysight

myKeysight

www.keysight.com/find/mykeysight

A personalized view into the information most relevant to you.

http://www.keysight.com/find/emt_product_registration

Register your products to get up-to-date product information and find warranty information.



Keysight Services

www.keysight.com/find/service

Keysight Services can help from acquisition to renewal across your instrument's lifecycle. Our comprehensive service offerings—one-stop calibration, repair, asset management, technology refresh, consulting, training and more—helps you improve product quality and lower costs.



Keysight Assurance Plans

www.keysight.com/find/AssurancePlans

Up to ten years of protection and no budgetary surprises to ensure your instruments are operating to specification, so you can rely on accurate measurements.

Keysight Channel Partners

www.keysight.com/find/channelpartners

Get the best of both worlds: Keysight's measurement expertise and product breadth, combined with channel partner convenience.

www.keysight.com/find/n9000a