

# LEGO Parts Guide

©Science and Engineering Education Center  
The University of Texas at Dallas  
Version 1.3 4/12/10

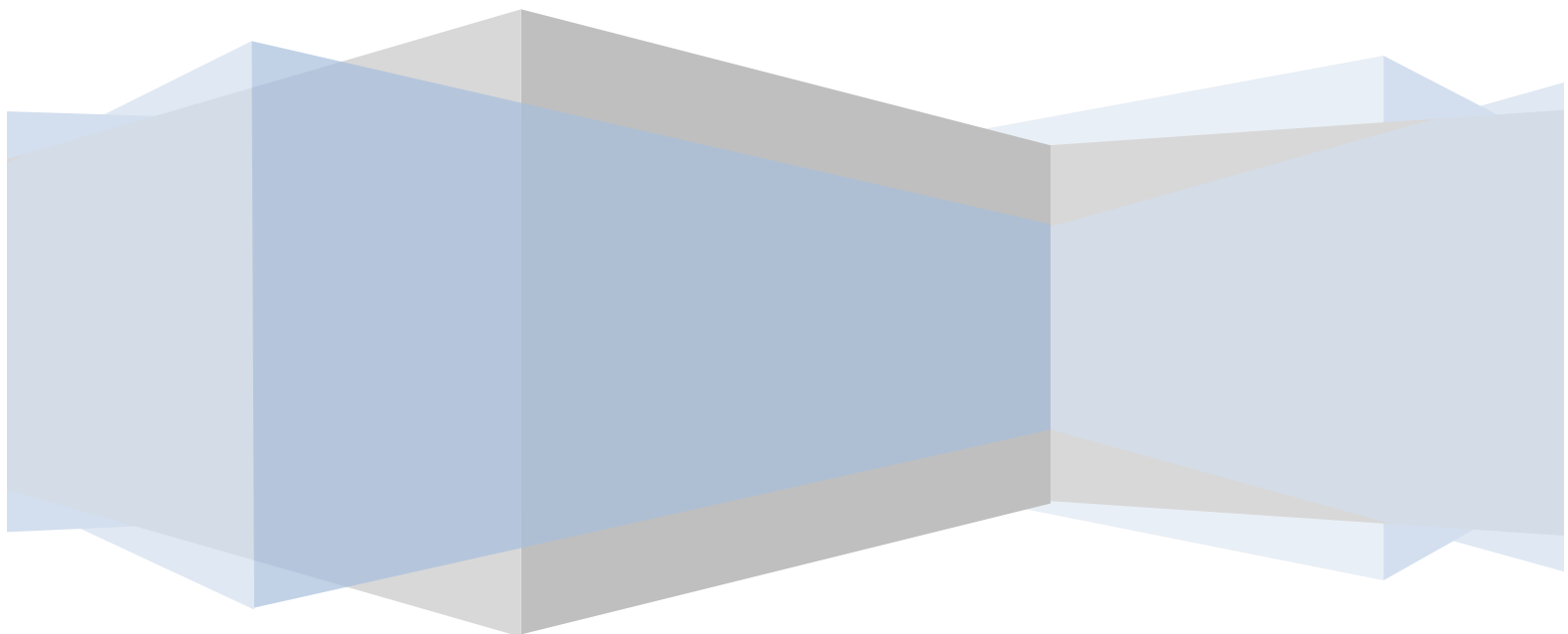

## Table of Contents





Connectors .....	4
Friction Pegs.....	4
Frictionless Pegs .....	5
Ball Joints / Tie Rods.....	6
Bushings.....	7
Angle Connectors .....	8
Axle Extenders .....	9
Catches / Cross Blocks .....	10
Toggle Joints / Universal Joints.....	12
Gears .....	13
Spur Gears .....	13
Bevel Gears.....	14
Other Gears.....	15
Racks.....	16
Differential /Gear Box / Chain Links .....	17
Axles / Beams / Tires.....	18
Cross Axles .....	18
Technic Plates.....	19
Straight Rounded Beams .....	20
Angled Rounded Beams.....	21
Square Beams / Bricks .....	22
Rims / Tires / Treads .....	24
Other .....	25
Pulleys / Cams.....	25
Rubber Belts.....	26
Red Rubber Belt- Medium .....	26
Steering Elements .....	27
Liftarms / Triangles / Hooks.....	28
Miscellaneous.....	29
Building and taking apart tips.....	30
Axles as Tools .....	30
Building.....	30

Taking apart.....	30
Screwdriver.....	30
Connector pegs .....	30
Axle holes and connector pegs with axle connection .....	31





©Science and Engineering Education Center  
The University of Texas at Dallas

## Connectors





### Friction Pegs

Picture	Name	Usage
	Technic Peg with Friction	This connector is used to connect two square beams and/or rounded beams. The fact that it is a friction peg makes the connection steadier.
	Technic Axle Peg with Friction	This connector is used to connect two rounded beams together, one with a regular hole and one with an axle hole. The fact that it is a friction peg makes the connection steadier.
	Technic Long Peg with Friction	This connector is used to connect two or three beams together. The fact that it is a friction peg makes the connection steadier.
	Technic Peg Long with Stop Bushing	This connector is used to connect one or two beams together and/or to an axle.
	Technic Double Peg 3L	This connector is used to connect one, two, three, or four beams together and/or an axle via the axle hole in the center.

## Frictionless Pegs



Picture	Name	Usage
	Technic Peg	This connector is used to connect two square beams and/or rounded beams together. The fact that it's frictionless makes the connection slip or slide easily.
	Technic Axle Peg	This connector is used to connect two rounded beams together, one with a regular hole and one with an axle hole. The fact that it is a frictionless peg makes the connection slip or slide easily.
	Technic $\frac{1}{2}$ Peg	This connector peg is used to connect a rounded beam to the bottom of a regular LEGO brick. The $\frac{1}{2}$ length is the length of a stud.
	Technic $\frac{3}{4}$ Peg	This connector is used to connect a square beam or rounded beam to a half beam (such as a rounded quarter ellipse).
	Technic Long Peg	This connector is used to connect two or three beams together. The fact that it is a friction peg makes the connection slip or slide easily.

## Ball Joints / Tie Rods

Picture	Name	Usage
	Technic Axle Towball	Towballs are used to connect steering links together. They can also be used to attach rubber belts more easily.
	Technic Peg Towball with Friction	
	Technic Steering Link 9L	Steering links are used to connect two towballs together. They can be used for steering mechanisms.
	Technic Steering Link 6L	







©Science and Engineering Education Center  
The University of Texas at Dallas

## Bushings

Picture	Name	Usage
	Technic Bushing	Bushings are used to hold axles still (not rotating) inside a hole. They can also be used as a measurement tools. For example if you want to put a beam at a distance of 2.5L from the end of an axle, just put 2 bushings and a half bushing at the end of the axle. This can be useful for keeping wheels a certain distance away from a chassis.
	Technic Smooth ½ Bushing	



©Science and Engineering Education Center  
The University of Texas at Dallas

## Angle Connectors

Picture	Name	Usage
	Technic Angle Connector #1 (0°)	Angle connectors are used to connect two (except for #1) axles together and/or a connector peg (or freely rotating axle) in the center.
	Technic Angle Connector #2 (180°)	
	Technic Angle Connector #3 (157.5°)	
	Technic Angle Connector #4 (135°)	
	Technic Angle Connector #5 (112.5°)	
	Technic Angle Connector #6 (90°)	















## Axle Extenders

Picture	Name	Usage
	Technic Axle Extender	Axle extenders are used to connect two axles together to make them longer.
	Technic Round Peg Joiner / Technic Axle Sleeve	Axle sleeves / Peg joiners are used to cover axles (to measure distance) or connect two pegs together. (The piece has two names, depending on its usage.)
	Technic Flexible Double Axle Joiner	A double axle joiner can hold two axles side-by-side. The fact that it is flexible allows movement even when joined.

©Science and Engineering Education Center  
The University of Texas at Dallas

## Catches / Cross Blocks

Picture	Name	Usage
	Technic Perpendicular Axle Joiner	These pieces are used in conjunction with pegs and/or axles to change the direction of beams.
	Technic Perpendicular Axle Joiner with 2 Holes	
	Technic Perpendicular Axle Joiner 3L	
	Technic Perpendicular Axle Joiner 3 Long	
	Technic Perpendicular Double Axle Joiner	
	Technic Perpendicular Double Split Axle Joiner	
	Technic Perpendicular Dual Peg Joiner	
	Technic Pole Reverser Handle	Can be used for steering mechanisms.
	Technic Connector with Axle hole	Can hold two axles perpendicular to each other.
	Technic Perpendicular Bent Peg Joiner	Can hold up to three pegs in different directions. Useful for changing directions.

	Technic Bent Beam with Pegs	These pieces are mainly used to change the direction of the beams holes.
	Technic Perpendicular Axle Joiner 3L with Pegs	

©Science and Engineering Education Center  
The University of Texas at Dallas





## Toggle Joints / Universal Joints

Picture	Name	Usage
	Technic Universal Joint	The universal joint is used to connect two axles together when they make a custom angle between each other and/or they are required to rotate.

©Science and Engineering Education Center  
The University of Texas at Dallas





# Gears

## Spur Gears

Picture	Name	Usage
	Technic 8 Tooth Gear	Gears are used to change rotational speed or force.
	Technic 16 Tooth Gear	
	Technic 24 Tooth Gear	
	Technic 40 Tooth Gear	



Science and Engineering Education Center  
The University of Texas at Dallas

## Bevel Gears

Picture	Name	Usage
	Technic 12 Tooth Bevel Gear	Gears are used to change rotational speed or force. However, unlike spur gears, bevel gears can also mesh with each other at a 90° angle.
	Technic 12 Tooth Double Bevel Gear	
	Technic 20 Tooth Double Bevel Gear	
	Technic 36 Tooth Double Bevel Gear	



©Science and Engineering Education Center  
The University of Texas at Dallas

## Other Gears

Picture	Name	Usage
	Technic 24 Tooth Crown Gear	Crown gears are used to flip the direction of spur gears by 90°.
	Technic Worm Screw	Worm gears are used in gearboxes or racks.
	Technic Knob Gear	Knob gears are mainly used to change gear row direction by 90°.

©Science and Engineering Education Center  
The University of Texas at Dallas



## Racks

Picture	Name	Usage
	1 x 4 Technic Gear Rack	Racks are used to convert rotational motion (a gear) to linear motion.
	1 x 8 Technic Gear Rack with Holes	

©Science and Engineering Education Center  
The University of Texas at Dallas













## Differential / Gear Box / Chain Links

Picture	Name	Usage
	Technic Differential	The differential allows to connect two axles while allowing them to turn at different speeds. This is what is used between the back wheels of a car.
	Technic Gearbox	The gearbox is used to connect a worm gear to a 24-tooth gear, which largely increases the torque but also reduces its speed.
	Technic Chain Link	Chan links are used to make a chain.









©Science and Engineering Education Center  
The University of Texas at Dallas

## Axles / Beams / Tires







### Cross Axles

Picture	Name	Usage
	Technic Axle 2 Notched	<p>Axles can be used as connectors on angled rounded beams and other pieces with axle holes. They are mainly used to connect gears to a motor or to other gears.</p>
	Technic Axle 3	
	Technic Axle 4	
	Technic Axle 5	
	Technic Axle 6	
	Technic Axle 7	
	Technic Axle 8	
	Technic Axle 10	
	Technic Axle 12	
	Technic Axle 3 with Stud	
	Technic Axle 5.5 with Stop	

## Technic Plates







Picture	Name	Usage
	1 x 2 Tile	These plates are used to create a smooth surface on which flat pieces can slide on.
	1 x 2 Technic Plate	
	1 x 4 Technic Plate	
	2 x 4 Technic Plate	
	1 x 6 Technic Plate	
	2 x 6 Technic Plate	<p style="text-align: center; opacity: 0.5; font-size: 1.2em;">             Science and Engineering Education Center              University of Texas at Dallas           </p>
	1 x 8 Technic Plate	
	2 x 8 Technic Plate	

## Straight Rounded Beams

Picture	Name	Usage
	Size 3 Rounded Beam	Rounded beams are used as the main structure for LEGO Technic constructions.
	Size 5 Rounded Beam	
	Size 7 Rounded Beam	
	Size 9 Rounded Beam	
	Size 11 Rounded Beam	
	Size 13 Rounded Beam	
	Size 15 Rounded Beam	









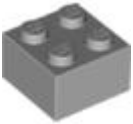

Science and Engineering Education Center  
University of Texas at Dallas



## Angled Rounded Beams

Picture	Name	Usage
	7 x 3 x 3 C-shaped Rounded Beam with 2 Axle Holes	Angled rounded beams are used like the rounded beams. However their curved shape allows for more secure complex structures.
	4 x 4 45° Rounded Beam with 2 Axle Holes	
	6 x 4 45° Rounded Beam with 2 Axle Holes	
	7 x 3 45° Rounded Beam with 2 Axle Holes	
	5 x 3 90° Rounded Beam	
	4 x 2 90° Rounded Beam with 1 Axle Hole	

Science and Engineering Education Center  
 University of Texas at Dallas









## Square Beams / Bricks

Picture	Name	Usage
	2 x 2 Square Brick	These bricks are regular LEGO bricks. They can be connected to each other via stacking them.
	1 x 2 Brick	
	2 x 2 Round Plate	
	2 x 2 Round Brick	
	1 x 2 Red Lamp Cover Brick	Those bricks can be used as regular LEGO bricks. However these bricks are transparent and can be used as filters for lamps (When coupled with a turned on lamp, the green brick will emit green light, the yellow one will emit yellow light and the red one will emit red light).
	1 x 2 Yellow Lamp Cover Brick	
	1 x 2 Green Lamp Cover Brick	
	1 x 2 Brick with Axle Hole	Technic bricks are also known as square beams. They can be used just like the rounded beams, however they can be also connected directly to a regular LEGO brick. In addition, a smaller brick can be connected to a larger technic brick side ways to change the direction of the holes; (in other words, the studs of one fit well into the holes of another, as long as ALL of the studs have a hole to fit into.)
	1 x 2 Technic Brick	
	1 x 4 Technic Brick	
	1 x 6 Technic Brick	
	1 x 8 Technic Brick	

	1 x 12 Technic Brick	
	1 x 14 Technic Brick	
	1 x 16 Technic Brick	

©Science and Engineering Education Center  
The University of Texas at Dallas



## Rims / Tires / Treads

Picture	Name	Usage
	Small Rim	The small rim has a hole in its center, which makes it very slippery. It is usually used to hold a small flat tire.
	Large Rim	These rims have an axle hole in their center they are therefore linked to the axle going through them. The large rims can be used with the large flat tires, large balloon tires, or treads if spaced properly. The motorcycle rim can be used with the motorcycle tire. They can also be used with rope (the rope can wind around the rim), or by themselves.
	Motorcycle Rim	
	Small Flat Tire	
	Large Flat Tire	Tires are used with the appropriate rims, as mentioned above. They are made out of rubber, which makes them have a lot of friction. They can be used either to make a wheel or as a nonskid device. (It is important to note that when a tire has a rim inside of it, it is now called a wheel.)
	Large Balloon Tire	
	Motorcycle Tire	
	Technic Tread	





## Other

### Pulleys / Cams

Picture	Name	Usage
	Technic Wedge Belt Wheel Tire	The wedge belt wheel tire can be used as a tire or as nonskid device.
	Technic Wedge Belt Wheel	The wedge belt wheel can be used either as a rim for the wedge belt wheel tire or it can be used with rope or a rubber belt to form a pulley.
	Technic Cam	Can change the force at which the wheel turns as it is turning.

©Science and Engineering Education Center  
The University of Texas at Dallas

## Rubber Belts

Picture	Name	Usage
	Red Rubber Belt-Medium	Rubber belts can be used to connect to pulleys. They can also be used to store energy. The difference between a rubber belt and a rubber band is that the cross-section of a rubber belt is circular, whereas the cross-section of a rubber band is rectangular.
	Yellow Rubber Belt-Extra Large	





©Science and Engineering Education Center  
The University of Texas at Dallas

## Steering Elements

Picture	Name	Usage
	Technic Steering Arm with Connectors	Used to steer in rack and pinion steering.









©Science and Engineering Education Center  
The University of Texas at Dallas

## Liftarms / Triangles / Hooks

Picture	Name	Usage
	Technic Liftarm Quarter Ellipse	
	Technic Triangle	
	Technic Liftarm with Boss and Pin	Can be used as a crank for a pully system.
	Technic Hook- Metallic	Can be used to add weight.

©Science and Engineering Education Center  
The University of Texas at Dallas

## Miscellaneous

Picture	Name	Usage
	Red Technic Ball 52mm	Mainly used as an “object” for programming tasks.
	Blue Technic Ball 52mm	Mainly used as an “object” for programming tasks.
	Technic Bionicle Tooth with Axlehole	
	Technic Bionicle Weapon Pincer	
	Technic Turntable	Can be used to turn two structures in different directions.
	Lamp Brick	Used to generate light with the correct programming, (use with a lamp cable). A colored lamp cover can be placed over the light to change colors.
	1 x 1 Cone	
	2 x 2 Round Dish	

## **Building and taking apart tips**

### **Axles as Tools**

#### **Building**

Axles can be useful when building. For example:

-You may find yourself trying to put together something that needs to have many parts aligned on an axis. Putting an axle through a hole will both allow you to have your parts perfectly aligned and free one of your hands (the one that was holding the beams aligned) or at least make its job easier.

-You may want to put a peg through many (2) beams at once. Sometimes, like when attaching a beam below the motor, it can be tricky to align the two beams and put the peg through them. By putting an axle through them first and then pushing the axle with the peg will make it a lot easier.

#### **Taking apart**

Axles can also be useful when taking apart. For example:

-Sometimes some friction pegs can be tricky to remove. To easily remove this peg just put an axle below it and push the peg with it. However you have to be careful that you push the peg in the direction that will push the ring on the peg away from the axle you want to remove it from.

-Axles can also be used as levers. However you have to be careful about pieces jumping all over the place.

-You can also use axles to take out other axles in hard to reach places. For example in a motor, the axle can be hard to take out, in this case, just take a longer axle and push the other one out of the motor.

### **Screwdriver**

A flat head screwdriver can be a useful tool to take your constructions apart. Just place the flat end of the screwdriver between two beams and use it as a lever.

### **Connector pegs**

Connector pegs can be tricky to put in or to take apart. The simple way to take them apart is not to pull them away from the beam directly but rather twist them while pulling them away. The same is true when putting them in.

### **Axle holes and connector pegs with axle connection**

When taking a connector peg from an axle hole, there are many ways to do it easily. The first way is to use an axle and push the peg out of the hole. When the axle hole is on an angled rounded beam, you can use your nails, just like an axle to push them out.

©Science and Engineering Education Center  
The University of Texas at Dallas