

nanDECK Manual

by Andrea “Nand” Nini

Program version 1.26.2 – 2021-12-08

Index

An overview	7
Editor commands	10
Getting started	12
Ranges	16
Colors	18
Labels and sequences	21
Label functions	27
AUTOLABEL	27
AUTORANGE	27
CALC	27
CASESTRING	28
CONCAT	28
CONCAT1	28
COOFRAME	28
COOFRAMES	28
COOICON	29
DIRFILES	29
ENVIRONMENT	30
EVAL	30
EXPAND	30
FILTER	31
GRADIENTSEQ	33
GROUP	33
IMAGECREATE	33
INDEX	33
INFO	33
JOIN	34
JOINIF	34
LABELRANGE	34
LABELSTRING	35
LABELSUB	35
LENGTH	36
PDFMERGE	36
PDFPAGES	36
PRODUCT	36
RANGEADD	36
RANGECOUNT	37
RANGELABEL	37
RANGEMERGE	37
RANGEMUL	37
RANGEREM	38
RANGESUB	38
REPLACE	38
ROUND	39
SAVELABEL	39
SCHEMA	39
STRINGLABEL	39
STRINGSUB	40
TAGFRAME	40
TOKENIZE	40
TOKENIZESEQ	40
TRANSLATE	40
Frames	42
Frame functions	46
FRAMEBAR	46
FRAMEBEZIER	46
FRAMEBOX	46
FRAMECLOCK	47
FRAMECOUNT	48
FRAMEDISK	48

FRAMEHEX	48
FRAMEIMAGE	49
FRAMELINE	49
FRAMELIST	50
FRAMEMAZE	50
FRAMEMELD	51
FRAMEMOSAIC	51
FRAMENET	51
FRAMEPATH	52
FRAMEPER	52
FRAMERECT	53
FRAMESUB	53
FRAMETRANS	53
FRAMETRI	54
Expressions	55
Comments	57
Script lists	58
Create PDF	59
Save images	60
Convert a PDF to images	61
Command-line parameters	62
Keyword wizard	63
Linked data editor	65
Virtual table	66
Visual editor	68
Configuration	70
Compare decks	73
Shortcuts	74
References	75
F.A.Q.	76
Directives	78
BASERANGE	78
BATCH	78
BEZIER	78
BEZIERS	79
BLEED	80
BORDER	80
BRUSH	81
BUTTON	82
CANVAS	83
CANVASSIZE	83
CANVASWORK	84
CARDS	84
CARDSIZE	84
CASE	84
CASEELSE	85
CHROMAKEY	85
CIRCLE	85
CMYK	86
COLOR	86
COLORCHANGE	87
COLORS	87
COMMENT	88
COMPARE	88
COPY	89
COPYCARD	89
CORRECTION	90
COUNTER	90
DECK	91
DEPTH	92
DICE	92
DISPLAY	93

DOWNLOAD.....	94
DPI.....	94
DRAW.....	94
DUPLEX.....	95
EDGE.....	95
ELLIPSE.....	96
ELSE.....	97
ELSEIF.....	97
END.....	97
ENDFRAME.....	97
ENDIF.....	98
ENDIMAGEENC.....	98
ENDLAYER.....	98
ENDLINK.....	98
ENDSECTION.....	99
ENDSELECT.....	99
ENDSEQUENCE.....	99
ENDVISUAL.....	99
EXPRESSION.....	99
FACTORS.....	100
FILL.....	100
FLAGS.....	101
FOLD.....	101
FOLDER.....	102
FONT.....	102
FONTALIAS.....	103
FONTCHANGE.....	104
FONTRANGE.....	104
FOOTER.....	105
FOR.....	106
FRAME.....	106
GAP.....	107
GRID.....	107
HEADER.....	108
HEXGRID.....	109
HTMLBORDER.....	109
HTMLFILE.....	110
HTMLFONT.....	111
HTMLFONTSTEP.....	113
HTMLIMAGE.....	113
HTMLKEY.....	113
HTMLLANG.....	114
HTMLMARGINS.....	114
HTMLTEXT.....	115
ICON.....	116
ICONS.....	117
IF.....	118
IMAGE.....	119
IMAGEENC.....	122
IMAGEFILTER.....	122
IMAGELIMIT.....	123
IMAGESIZE.....	123
INCLUDE.....	124
INPUTCHOICE.....	124
INPUTLIST.....	125
INPUTNUMBER.....	125
INPUTTEXT.....	126
LABELMERGE.....	127
LAYER.....	127
LAYERDRAW.....	128
LIMIT.....	128
LINE.....	129

LINERECT	130
LINK.....	131
LINKCOLOR	132
LINKENCCSV	133
LINKENCODE.....	133
LINKEXEC	133
LINKFILL	133
LINKFILTER	133
LINKFONT	134
LINKMULCOPY	134
LINKMULDIS	135
LINKMULTI.....	135
LINKNEW.....	136
LINKRANDOM.....	136
LINKSEP	136
LINKSPLIT	137
LINKSTYLES	137
LINKTRIM.....	137
LINKUNI.....	137
LOADPDF.....	138
LOG	138
MACRO.....	139
MARGINS	139
MERGEPDF	140
MOSAIC.....	140
NANDECK.....	141
NEXT.....	141
ORIGIN	142
OVERSAMPLE.....	142
PAGE.....	142
PAGEFONT	143
PAGEIMAGE.....	144
PAGESHAPE	144
PATTERN	145
PIE	146
POLYGON	147
PRINT.....	147
QRCODE.....	148
RECTANGLE.....	148
RENDER	149
RHOMBUS	149
ROUNDRECT	150
RTFFILE	151
RTFTEXT.....	151
SAVE.....	152
SAVEGIFA	153
SAVEPAGES	154
SAVEPDF	154
SECTION	155
SELECT.....	155
SEQUENCE	156
SET	156
SPECIAL	157
STAR.....	157
STORE.....	158
SYMBOL.....	158
TABLE	159
TAG.....	160
TAGS.....	160
TEXT	161
TEXTFONT.....	163
TEXTLIMIT	163

THREADS.....	164
TOKEN.....	164
TRACK.....	165
TRACKRECT.....	166
TRIANGLE.....	166
UNIT.....	167
VECTOR.....	167
VISUAL.....	168
VORONOI.....	169
ZOOM.....	169
Code examples.....	170
Wargame counters.....	170
Dice results.....	171
Score track.....	172
Boggle dice.....	173
Catan map.....	174
Clock.....	175
Hex board.....	176
Triangle map.....	177
Chess board.....	178
Trivia cards.....	179
Hex racetrack.....	180
Tuckbox.....	181
Number wheel.....	182
Tripples tiles.....	183
Path tiles.....	184
Combinations.....	185
Standard 52-deck of cards.....	186

An overview

nanDECK is a program capable of creating graphic elements from scripts: every line of a script contains a command, for rendering texts, rectangles, and other graphic elements. The program was made for creating cards, but it can be used for many other graphic objects; each card is treated like a different page, in which you can draw different graphical elements. At the start, you can write the script in the large edit box in the center of the window:

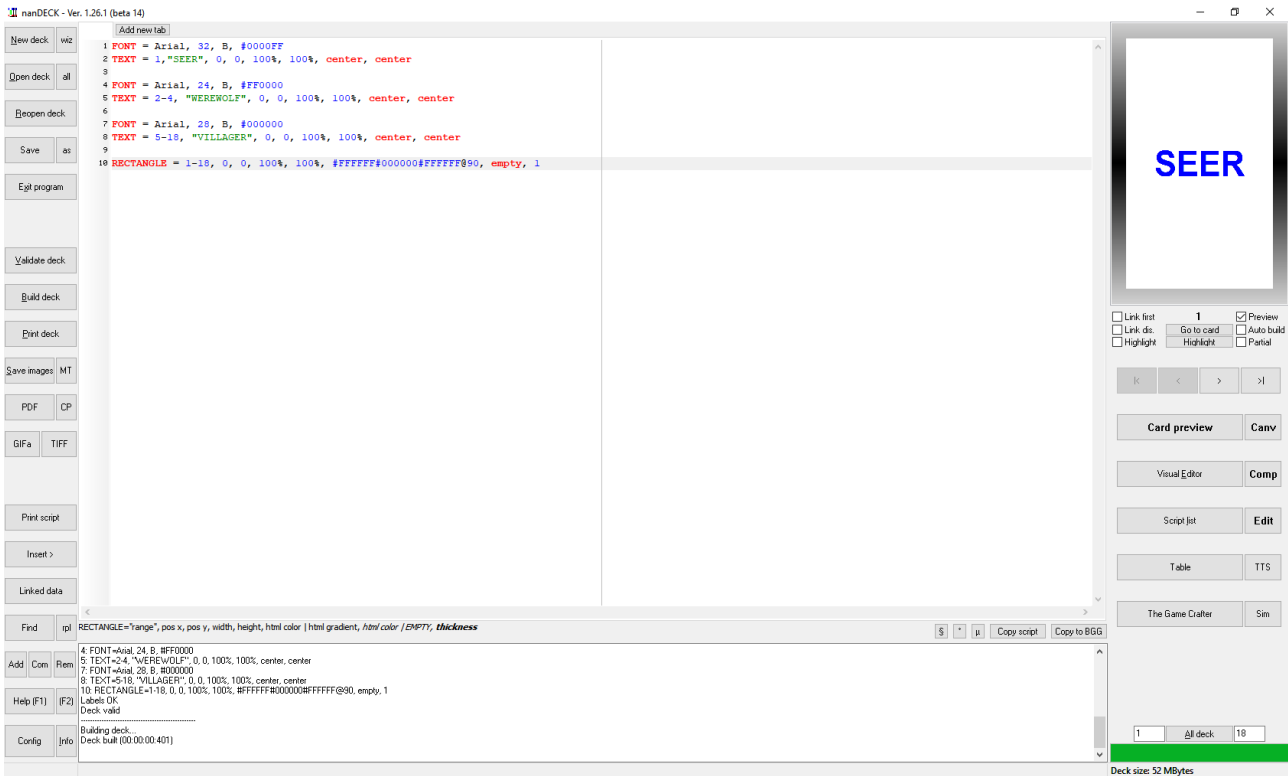

You can load a script with the “Open deck” button, save it with “Save” and “as” buttons, and create the deck with the buttons “Validate deck” and “Build deck”.

Tip: You can do both if you right-click the “Validate deck” button.

All commands start with a keyword, an equal sign (=) and a list of parameters; for many commands, the 1st parameter is a range of “cards” in which the command will be executed. The commands without a range will be evaluated only once (for example the BORDER directive to draw a border on all cards, or the CARDS directive for setting the number of the cards in the deck), or for every card (like the FONT directive); in other words, the program creates the 1st card in the deck, and executes all the script on it, then it switches on the 2nd card, and executes all the script and so on; each ranged directive is executed only if the range match.

Note: the CARDS directive is no longer needed, now the program creates automatically a deck using the information from all the directives in the script. For example, if you have a 10-30 range, the deck will be created with 30 cards.

For example, in a game of Werewolf, I need a card with a word “SEER”, three “WEREWOLF” and thirteen “VILLAGER”. The first card will be:

```
FONT = Arial, 32, B, #0000FF
TEXT = 1, "SEER", 0, 0, 100%, 100%, center, center
```

With the 1st line, I choose a font: Arial 32, bold, and blue (the #0000FF parameter); with the 2nd line I draw the word “SEER” in the center of the whole card #1 (starting from 0,0 – top left of the card, 100% width and 100% height). The other cards will be drawn with these lines:

```
FONT = Arial, 24, B, #FF0000
TEXT = 2-4, "WEREWOLF", 0, 0, 100%, 100%, center, center
```

```
FONT = Arial, 28, B, #000000
TEXT = 5-18, "VILLAGER", 0, 0, 100%, 100%, center, center
```

Note the range 2-4 and 5-18, for three and thirteen cards. Other elements can be added, for example a rectangle:

```
RECTANGLE = 1-18, 0, 0, 100%, 100%, #FFFFFF#000000#FFFFFF@90, empty, 1
```

The rectangle is on all the cards (range 1-18), from 0,0 – top left, 100% width and 100% height, with a gradient starting from white (#FFFFFF), to black (#000000), again to white, rotated 90°; not filled (empty parameter) and with a border thickness of 1”.

The flexibility of the program is that an element can be added on one or more than one card, changing only the range parameter. If you want to add an image on all the cards, you can add a line like this:

```
IMAGE = 1-18, "Logo.png", 0, 0, 20%, 20%, 0, TP
```

In the left bar in the main window, you can use these command buttons:

New deck: creates a new script.

wiz: creates a new script selecting some options.

Open deck: open a saved script.

all: open all the scripts (files with extension .txt and .nde) in a folder.

Reopen deck: open a saved script, picking one from a list of the last accessed.

Save: save the current script.

as: save the current script with another name.

Exit program: close the program.

Validate deck: the program checks the syntax of the script.

Build deck: the program builds the deck of cards.

Print deck: the program prints the deck of cards.

Save images: the program saves the images of each card of the deck, see page 60.

MT: the program can launch several instances of itself, each with a range of the deck.

PDF: the program creates a PDF file with all the cards’ images, see page 59.

CP: the program creates one image from each page of a PDF, see page 61.

GIFa: with this option, you can save the current deck into an animated GIF image (you can choose the delay between images and select an optimized palette).

TIFF: with this option, you can save a multi-page TIFF image (with RGB or CMYK color space).

Print script: print the current script.

Insert >: this button opens a menu, where you can insert a color, a font, an image, a symbol, a gradient, an include file, a linked file, a label, a frame, or a folder.

Linked data: you can edit the data from a linked csv file, see page 65.

Find: find a string in the script editor.

rpl: find and replace a string in the script editor.

Add (CTRL+R): the program adds a comment in the current line / selected block of the script.

Com (CTRL+E): the program toggles a comment in the current line / selected block of the script.

Rem (CTRL+U): the program removes a comment in the current line / selected block of the script.

Help (F1): the program shows a help page for the current directive.

(F2): the program shows a window for modifying the current directive.

Config: the configuration options, see page 70.

Info: info about the author.

In the right bar, you find a preview of the current card and if you hover the pointer on a feature, a hint box shows you the corresponding line(s) in the script; a CTRL click moves the caret to the corresponding line. In this bar you can use these command buttons:

Link first: if you check this option, only the first line from a data file (csv or spreadsheet) is read, for testing purpose.

Link dis.: if you check this option, the data file (csv or spreadsheet) is not read, and are shown only the fields' names, for testing purpose.

Preview: remove the check in this option if you want to hide the card preview (the rendering is faster).

Go to card: click to select a card from the deck to be viewed.

Auto build: check this option if you want to see in real time the script's changes in the preview.

Highlight (checkbox): check this option to highlight with colors each line of the editor and each graphic element of the preview.

Highlight (button): click to highlight the graphic element of the preview corresponding to the current line of the editor.

Partial: the program renders the current card only until the position of the cursor in the editor.

Arrow buttons: with these buttons, you move between the cards of the deck (first, prior, next, and last).

Card preview: this button shows you an enlarged view of the current card.

Canv: this button shows you the canvas (the "zero" card).

Visual Editor: the program opens the visual editor window, see page 68.

Comp: this button shows a window for comparing different decks of cards.

Script list: in this window, you can execute several scripts, in a batch mode, see page 58.

Edit: in this window, you can edit the content of a linked spreadsheet file.

Table: the program opens the virtual table window, see page 66.

The Game Crafter: in this window, you can upload a deck of card directly to the website <http://www.thegamecrafter.com> for printing and/or publishing your game.

All deck: this button selects all the cards in the deck to be rendered (the start-end range is in the two edit boxes to the left and right of this button).

Editor commands

CTRL+X	Cut
CTRL+C	Copy
CTRL+V	Paste
CTRL+A	Select all
CTRL+B	Validate and build the current card
CTRL+I	Insert card's number (character §)
CTRL+O	Insert frame's number (character °)
CTRL+P	Insert frame's number (character μ)
CTRL+R	Comment current line/selected text
CTRL+U	Remove comment from current line/selected text
CTRL+E	Toggle comment on/off in current line/selected text
SHIFT+CTRL+I	Block indent
SHIFT+CTRL+U	Block un-indent
SHIFT+ALT+UP	Move block up one line
SHIFT+ALT+DOWN	Move block down one line
CTRL+D	Add new tab with a new version
SHIFT +CTRL+D	Duplicate current line/block
CTRL+M	Line break
CTRL+N	Add new tab (empty)
CTRL+T	Show windows side by side
CTRL+Y	Delete current line/block
SHIFT+CTRL+Y	Delete EOL
CTRL+Z	Undo
SHIFT+CTRL+Z	Redo
CTRL+0...9	Go to marker 0...9
SHIFT+CTRL+0...9	Set/remove marker 0...9
SHIFT+CTRL+C	Set columns selection
SHIFT+CTRL+L	Set lines selection
SHIFT+CTRL+N	Set standard selection
SHIFT+CTRL+B	Match bracket
CTRL+F	Find
CTRL+H	Replace
CTRL+G	Go to line
F1	Help (current line directive)
CTRL+F1	Auto layout (white on black)
F2	Modify (current line directive)
CTRL+F2	Auto layout (color)
F3	Modify (current line directive, visual mode)
CTRL+F3	Auto layout (black on white)
F4	Visual editor
F5	Auto build switch
CTRL+F5	Insert character for Game-Icons.net font
F6	Go to card
F7	Highlight current line
CTRL+F7	Highlight all lines switch
F8	Insert label
CTRL+F8	Insert frame
F9	Insert color
CTRL+F9	Insert gradient
F10	Partial build switch (build source until current line)
F11	Select the next font (in alphabetical order)
CTR+F11	Select the previous font (in alphabetical order)
F12	Open the reference manual (if not present, it is downloaded)

Tip: You can copy the current card's image if you press CTRL+C after a click on the card image.

Tip: You can validate and build the current card's image if you right-click on the card image.

Tip: You can validate and build the whole deck if you right-click on the “Validate deck” button.

Tip: You can edit more than one script simultaneously, right click on the tab on the upper side of the screen and choose the voice “Add new tab” to add another tab to the editor.

Tip: You can move between cards using the mouse wheel.

Getting started...

This is a simple yet complete tutorial about how to create a deck of cards starting from a spreadsheet file.

First, I wrote some data, and save them as Data.xlsx:

	A	B	C	D	E	F	G	I
1	Name	Desc	Img	Icons	Value	Num		
2	Desert	A desert is a barren area of land where little precipitation occurs and consequently living conditions are hostile for plant and animal life.	desert.jpg	EF	8	1		
3	Lighthouse	A lighthouse is a tower, building, or other type of structure designed to emit light from a system of lamps and lenses and used as a navigational aid for maritime pilots at sea or on inland waterways.	lighthouse.jpg	EW	10	2		
4	Jellyfish	Jellyfish are typified as free-swimming marine animals consisting of a gelatinous umbrella-shaped bell and trailing tentacles.	jellyfish.jpg	AW	5	3		
5								
6								

Note: each column will be identified with the name in the first line (each must be different).

I start nanDECK, and as first line I link that file:

```
LINK = Data.xlsx
```

Then I save the script, as **tut01.txt**, in the same folder with the Excel file (if I want to save it in a different folder, in the LINK line I must also specify the path, for example `c:\users\nand\desktop\data\data.xls`).

I want to put the title in the top of the card, then I select a font with the line:

```
FONT = Arial, 24, , #000000
```

Font name for the 1st parameter, size for the 2nd, and color for the 4th. The 3rd is empty, this is the place for flags like **B** (bold), **I** (italic), **U** (underline) and so on (among others, if you want to shrink the font size to fit the space, use a **N** flag, if you do not want to see the text background, use a **T** flag). If you use more than one flag, put them all in this parameter (for example: **BTN**).

And add the title with this line:

```
TEXT = 1-3, [name], 0, 0, 100%, 20%
```

The 1st parameter is the range, and I want to put this text on three cards (from 1 to 3, then the syntax is 1-3), the 2nd parameter is the column name from the Excel file (enclosed in square brackets), the others are the position (0, 0 is top left), width (100% of the card's width) and height (20% is a fifth of the card's height).

Note: I can use also values in cm, and I can specify 0, 0, 6, 1.8 (for a default card of 6 x 9 cm), but with percent values I can change the size of the card without having to change every size of every element.

With a click on "Validate deck" button, "Build deck" button, the deck is created with three (ugly) cards:

Desert	Lighthouse	Jellyfish
--------	------------	-----------

Let us add some images:

IMAGE = 1-3, [img], 0, 20%, 100%, 40%, 0, P

The 0 in the 7th parameter is the angle of rotation for the image, and the P is for proportionally resize the image, if you have transparent PNGs, add a N flag in the same parameter (i.e., PN).

I have added the images' files in the same folder with the spreadsheet and the script, and this is the result after Validate + Build:



These lines are for the description:

FONT = Arial, 10, , #000000
 TEXT = 1-3, [desc], 5%, 65%, 90%, 30%, left, wordwrap

I choose a smaller font, and since the description is more than one line, I add left as horizontal alignment and wordwrap as vertical. This is the result:



These lines are for the value column:

FONT = Arial, 32, T, #FF0000
 TEXT = 1-3, [value], 0, 20%, 20%, 40%

To make the number readable on every background, I can add an outlined text:

FONT = Arial, 32, T, #FFFFFF
 TEXT = 1-3, [value], 0, 20%, 20%, 40%, center, center, 0, 100, 0.1

The "0, 100, 0.1" are respectively for angle, transparency, and outline width.

Note that these lines must be added before, because every element in a script is drawn accordingly to its position: first are drawn elements in the first lines, the last drawn are those in the bottom lines.



I have four icons (one for each element), each identified with a letter in my Excel file (and on each card, there may be more than one icon). I add these lines in the script:

ICON = 1-3, A, air.png
 ICON = 1-3, E, earth.png
 ICON = 1-3, F, fire.png
 ICON = 1-3, W, water.png
 ICONS = 1-3, [icons], 80%, 20%, 20%, 40%, 20%, 10%, 0, PN

In the last line, I specify the icons' area (80%, 20%, 20%, 40%), the size of each icon (20%, 10%), the angle of rotation (0) and to use proportional resize (P) and PNG transparency (N).

I have added the four .png files in the same folder. And this is the result:

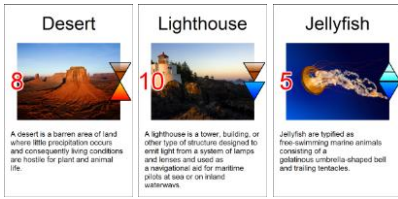

Finally, I want to duplicate each card for the number specified in the “num” column, then I add, as first line (before the LINK), this directive:

```
LINKMULTI = num
```

I must also change every range 1-3 into 1-7. This is the result page:



This is a more compact version of the script, here the 1st parameter (the range) is empty for most directives because I want to put the text/images on all the cards, and if I leave the 1st parameter empty, nanDECK uses as a default 1-n, where n is the number of lines in the Excel file.

```
LINKMULTI = num
LINK = Data.xlsx

FONT = Arial, 24, , #000000
TEXT = , [name], 0, 0, 100%, 20%

IMAGE = , [img], 0, 20%, 100%, 40%, 0, P

FONT = Arial, 10, , #000000
TEXT = , [desc], 5%, 65%, 90%, 30%, left, wordwrap

FONT = Arial, 32, T, #FFFFFF
TEXT = , [value], 0, 20%, 20%, 40%, center, center, 0, 100, 0.1
FONT = Arial, 32, T, #FF0000
TEXT = , [value], 0, 20%, 20%, 40%

ICON = , A, air.png
ICON = , E, earth.png
ICON = , F, fire.png
ICON = , W, water.png

ICONS = , [icons], 80%, 20%, 20%, 40%, 20%, 10%, 0, PN
```

Ranges

Many directives (like IMAGE or TEXT) have a parameter for specifying for which cards will be executed that directive. A card in a range may be specified directly with a number, a list of cards with a list of numbers separated by a comma “,” and a range of cards with the first and last cards separated with a dash “-” or the first card and a number, separated with a number sign “#”.

Examples:

```
RECTANGLE = 1, 0, 0, 6, 9, #0000FF
RECTANGLE = "1,3,5,7", 0, 0, 6, 9, #0000FF
RECTANGLE = 1-10, 0, 0, 6, 9, #0000FF
RECTANGLE = 10#5, 0, 0, 6, 9, #0000FF
```

Note: in the 2nd line the range must be enclosed in quote for the presence of commas, however, you can always enclose all ranges in quotes.

You can mix the two methods, and use a complex range, like:

```
RECTANGLE = "1-10,12,15,19-20,35#3", 0, 0, 6, 9, #0000FF
```

A number in a range can be the result of an expression (see page 55) and must be enclosed between “{” and “}”. For example:

```
RECTANGLE = 1-{2*5}, 0, 0, 6, 9, #0000FF
```

Note that a best practice is to create a range (and therefore a label) linked with the number of elements in a sequence, as when read from a linked file. For example, if you have a column named "title" in a spreadsheet, you can create a label for a range with this line:

```
[all]=1-{(title)}
```

Note that, since each column in a spreadsheet has the same length, usually is needed only one of these definitions, and you can use the label **[all]** with all the directives.

Usually, the order does not matter (1-10 is equal to 10-1) but for one command, COPYCARD, the order is important, because the source range is uses as specified, these two rows are different:

```
COPYCARD = 11-20, 1-10
COPYCARD = 11-20, 10-1
```

The 1st row gives as result this sequence of cards:
1,2,3,4,5,6,7,8,9,10,1,2,3,4,5,6,7,8,9,10

The 2nd row gives as result this sequence of cards:
1,2,3,4,5,6,7,8,9,10,10,9,8,7,6,5,4,3,2,1

There is a syntax that can be used to change that behavior, useful, for example, to invert sub-ranges of cards (for printing front-back). For example:

```
COPYCARD = 10-18, 1-9$abc>cba
```

The first group of characters is the start pattern, the second group is the destination pattern, in this case reversed in groups of three cards. You can obtain the same result manually writing:

```
COPYCARD = 10-18, "3-1,6-4,9-7"
```

Note that you are not limited at patterns of three letters, you can use all that you need (until the twenty-six letters). This syntax is useful also if you want to specify a “hollow” range, for example, if you want a rectangle only on even cards:

```
RECTANGLE = 1-10$ab>a, 1, 1, 4, 4, #FF0000
```

Note: the \$abc>cba syntax works only when the total number of cards is defined using a CARDS command.

See also: Labels and sequences chapter (page 21), AUTORANGE label function (page 27), and BASERANGE directive (page 78) about the interaction between ranges and sequences.

Colors

In this program, the colors will be defined by a string of seven characters, starting with a number sign “#” and six hexadecimal digits (using the HTML syntax), two for each component (red-green-blue), for example:

White	#FFFFFF
Black	#000000
Red	#FF0000
Green	#00FF00
Blue	#0000FF
Cyan	#00FFFF
Magenta	#FF00FF
Yellow	#FFFF00

Tip: if you use the wizard for a new deck (the “wiz” button, to the right of “New deck” button), you can check the “Include labels for HTML colors” to obtain a set of 140 label definition for many colors.

Tip: you can choose a color from a color picker, clicking on the button “Insert” and choosing the menu voice “Color”.

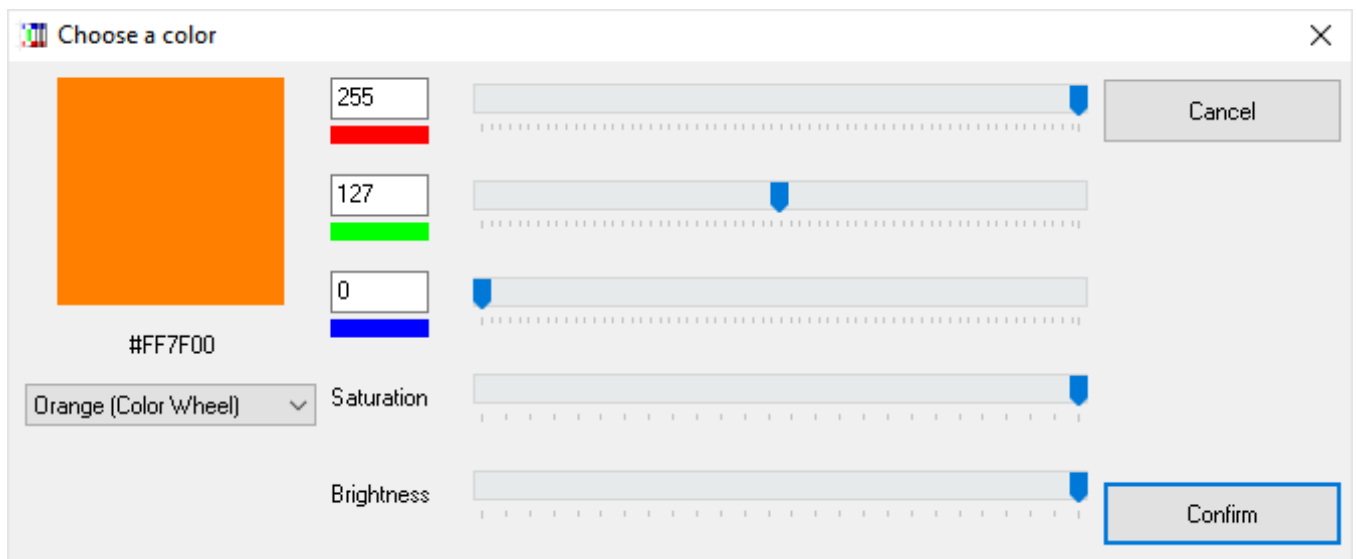







If instead of a hexadecimal digit you specify a letter “H”, you obtain a random value from 0 to 15. For example, if you want a complete random color, with this syntax you can use #HHHHHH, instead for a random hue of blue, you can use #0000HH, and so on. The letter “L” stands for the last color used, then #LLLLLL is the last color, instead #0000LL is the last blue component used.

You can concatenate more than one color to obtain a gradient, followed by a “@” to specify the angle. If you use these special values for the angle, you obtain a special gradient:

- 360 Radial gradient
- 361 Elliptical gradients
- 362 Square gradient
- 363 Star gradient

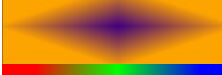
These are some examples:

From black to white, horizontal	<code>#FFFFFF#000000@0</code>	
From red to blue, vertical	<code>#0000FF#FF0000@90</code>	
From cyan to magenta, radial	<code>#FF00FF#00FFFF@360</code>	
From cyan to magenta, elliptical	<code>#FF00FF#00FFFF@361</code>	
From teal to yellow, square	<code>#FFFF00#008080@362</code>	
From orange to purple, star	<code>#400080#FFA500@363</code>	
From red, to green, to blue, horizontal	<code>#0000FF#00FF00#FF0000@0</code>	



If you omit the “@”, the colors are randomized (and smoothed); specifying a “%” and a number, you set a threshold for the 2nd color, for example:

Blue and red, randomized	<code>#0000FF#FF0000</code>	
Blue and red, randomized 50%	<code>#0000FF#FF0000%50</code>	
Red and blue, randomized 50%	<code>#FF0000#0000FF%50</code>	
Blue, green, and red, randomized	<code>#0000FF#00FF00#FF0000</code>	

Specifying a \$ and a number, the colors are smoothed that number of times (without specifying it, the color is smoothed only one time), for example:

Blue and red	<code>#0000FF#FF0000</code>	
Blue and red, no smoothing	<code>#0000FF#FF0000\$0</code>	
Red and blue, two smoothing	<code>#FF0000#0000FF\$2</code>	

If you add a & and a number in the color, the pattern is created with a Perlin Noise algorithm, with several iteration equal to the numeric parameter, for example:

Blue and red, eight iterations	<code>#0000FF#FF0000&8</code>	
Blue and red, six iterations	<code>#0000FF#FF0000&6</code>	
Blue and red, three iterations	<code>#0000FF#FF0000&3</code>	

If you add a ¢ in the color, the random pattern is made of stripes (and you can use more ¢ to make the stripes longer), for example:

Blue and red, randomized

#0000FF#FF0000

Blue and red, striped

#0000FF#FF0000ç

Blue and red, striped x 2

#0000FF#FF0000çç

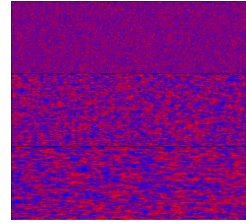

Tip: you can choose a gradient from a visual form, clicking on the button "Insert" and choosing the menu voice "Gradient".

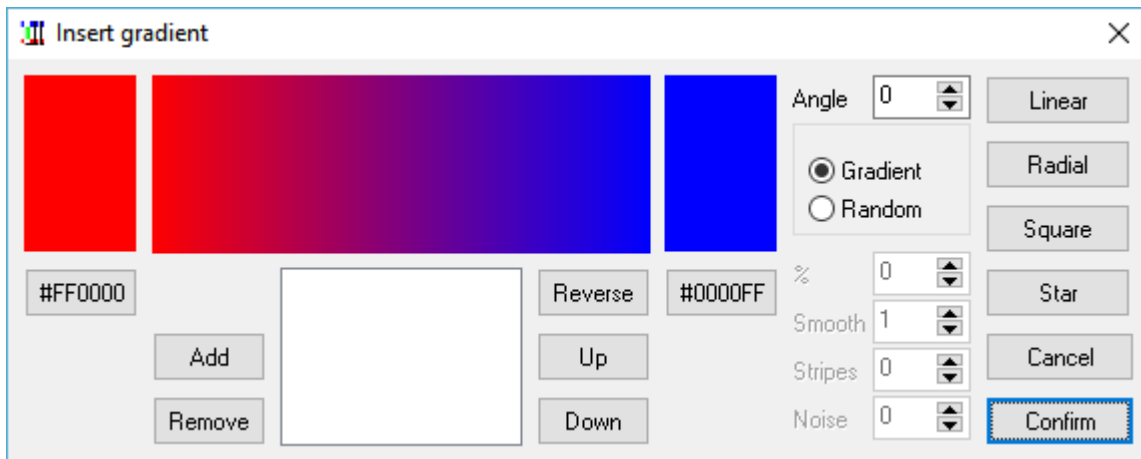

There are directives (HTMLFILE, HTMLTEXT, ICONS, IMAGE, LAYER, LAYERDRAW, PATTERN, RTFFILE, RTFTEXT, TEXT, and TEXTFONT) that have a parameter in which you can set the level of transparency, from 0 (full transparent) to 100 (full solid). You can also specify an angle for the transparency, with the format **level@angle**; in this case, the level of transparency is the starting level, ending with 0 (full transparent). If you use these special values for the angle, you obtain a special alpha gradient:

- 360 Radial gradient
- 361 Elliptical gradient
- 362 Square gradient
- 363 Star gradient

You can also add these flags to the **level@angle** parameter:

- \$ The transparency starts at zero, goes to the level set in the parameter, and returns to zero,
- % The transparency starts at the level set in the parameter, goes to zero, and returns to the starting level.

Labels and sequences

A label is used as a variable value in a script and may be initialized and used several times in the code. It can be initialized with this syntax:

```
[name] = value
```

And used specifying its name (always delimited with “[” and “]”). This is an example:

```
[alpha] = "This is a text"  
FONT = Arial, 32, , #000000  
TEXT = 1-10, [alpha], 0, 0, 6, 9, center
```

A sequence is a list of values used as a parameter in a directive. Each value is separated using the character pipe “|”. For each card in the directive’s range the program uses a different element in a sequence (restarting from the first if the sequence’ size isn’t enough to fill the range), for example, if you want ten cards, half with the word “odd” and half with the word “even”, you can use the TEXT directive, with a range 1-10 and a sequence of the two words as text parameter (“odd|even”).

```
FONT = Arial, 32, , #000000  
TEXT = 1-10, "odd|even", 0, 0, 6, 9, center
```

Sequences may be exceedingly long; you can manipulate them in a clearer manner if you use them in labels. Usually, a sequence must be on a single line, but you can split a long sequence into multiple lines, starting the first line with a “{” and ending the last line with a “}”. For example:

```
{[long] = "one|  
two|  
three|  
four|  
five|  
six|  
seven|  
eight|  
nine|  
ten"}  
FONT = Arial, 32, , #000000  
TEXT = 1-10, [long], 0, 0, 6, 9, center
```

Tip: The split-line syntax with “{” and “}” can be used not only for sequences, but with every command.

If the label contains a sequence (like in the above example), you can obtain the number of elements contained using the syntax “(name)”. It can be used directly as a parameter or in an expression. For example:

```
[alpha] = one|two|three  
FONT = Arial, 32, , #000000  
TEXT = 1-{(alpha)*2}, [alpha], 0, 0, 6, 9, center
```

The result deck will be composed of six cards, with the word sequence one-two-three-one-two-three.

When you define a label, there are some characters you can use as prefix or postfix for the [name] to obtain special behavior.

```
[name]number = value
```

The resulting value is the original value repeated *number* times. Instead, with these letters as a prefix, you can use this program as a combinatorial engine:

C	combination
P	permutation
E	derangement (permutation with no element in its original position)

F circular shift (right)
B circular shift (left)
CR combination with repetitions
PR permutation with repetitions
ER derangement with repetitions
Tn extracts only a random sample of *n* elements instead of the full set
Kn stops the creation of the sequence after *n* elements are added

`C[name]number = object1|object2...objectN`
`P[name]number = object1|object2...objectN`
`E[name]number = object1|object2...objectN`
`F[name]number = object1|object2...objectN`
`B[name]number = object1|object2...objectN`

These syntaxes create two labels with a combination and a permutation of *number* objects from the sequences, for example:

`C[label1]2 = A|B|C`
`P[label2]2 = A|B|C`
`E[label3]2 = A|B|C`
`F[label4]2 = A|B|C`
`B[label5]2 = A|B|C`

these labels will be translated into:

`[label1] = AB|AC|BC`
`[label2] = AB|AC|BA|BC|CA|CB`
`[label3] = BA|BC|CA`
`[label4] = AB|BC|CA`
`[label5] = AB|CA|BC`

With repetitions:

`CR[label1]2 = A|B|C`
`PR[label2]2 = A|B|C`
`ER[label3]2 = A|B|C`

the result will be:

`[label1] = AA|AB|AC|BB|BC|CC`
`[label2] = AA|AB|AC|BA|BB|BC|CA|CB|CC`
`[label3] = BA|BC|CA|CC`

A sample of three elements:

`CRT3[label1]2 = A|B|C`

one of the possible results could be:

`[label1] = BC|AA|CC`

Special flags:

D remove duplicate elements
X remove “rotated” elements
S remove elements with the same “structure”
N randomize elements
A sort elements in ascending order
Z sort elements in descending order
I keep only crossing paths
O keep only paths that does not cross themselves

The “D” flag is useful when you have multiple elements in combinations/repetitions, for example:

```
C[label1]2 = A|B|C|C
```

will be evaluated as:

```
[label1] = AB|AC|AC|BC|BC|CC
```

If you do not want repetitions, you can add the “D” flag (as a prefix) and the result will be:

```
[label1] = AB|AC|BC|CC
```

The “X” flag needs a longer explanation. Let us say, you need to create tiles with 4 quadrants, with all the combination of three elements (plains, woods, and mountains), this is the starting script:

```
CARDSIZE = 4, 4
[QUARTER1] = 0, 0, 2, 2, 0, 4
[QUARTER2] = 0, 0, 4, 0, 2, 2
[QUARTER3] = 4, 0, 4, 4, 2, 2
[QUARTER4] = 0, 4, 2, 2, 4, 4

PR[SCHEMA]4 = P|F|M
[ALL] = 1-{(SCHEMA)}

[COLOR_P] = #00FF00
[COLOR_F] = #008000
[COLOR_M] = #C0C0C0

TRIANGLE = [ALL], [QUARTER1], [COLOR_[SCHEMA:1,1]]
TRIANGLE = [ALL], [QUARTER2], [COLOR_[SCHEMA:2,1]]
TRIANGLE = [ALL], [QUARTER3], [COLOR_[SCHEMA:3,1]]
TRIANGLE = [ALL], [QUARTER4], [COLOR_[SCHEMA:4,1]]
```

This is the result (4 pages of 81 tiles):

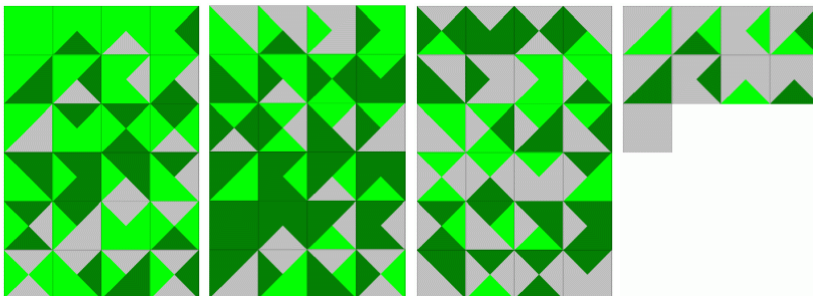

The tiles are all different, but not if you rotate them, for example, PFPF is equal to FFPF (rotated 90°). To eliminate them, you can use the “X” prefix. This is the result (1 page of 24 tiles):

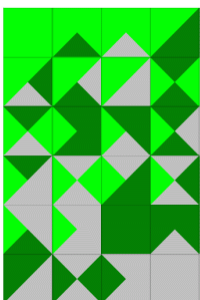

The “X” flag can be used more than once, to specify that not all the “rotations” will be considered as equals; for example, with only one “X”, the sequence 0102 is equal to:

```
1020
```

0201
2010

In a square token with a number on each side, this is equal to 90° rotations. Instead, with “XX”, the sequence 0102 is equal only to 0201 (in a square token, this is equal to considering only rotations of 180°, or rather, that rotations of 90° are not considered).

The “S” flag removes elements with the same structure: for example, the sequence 0102 has the same structure of the sequence 1210. In the previous example, from the 24 tiles, only six have a different structure:

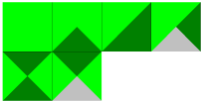

The “N” flag will be used if you want to randomize the sequence, if you write, for example:

```
N[elements] = alpha|beta|gamma|delta
```

it will be randomly evaluated each time you validate the deck, for example as:

```
[elements] = beta|gamma|delta|alpha
```

If you want to analyze only a sub-string from the result of the permutation/combination engine or an external linked file, you can use the “:” syntax to extract a sub-string, the syntax is `[label:start,number]` where *start* is the starting character and *number* is the length of the sub-string in characters. For example, in the script about tiles in the previous page, every line extract only a character from the label (composed of four characters), and associates it with another label:

```
TRIANGLE = [ALL], [QUARTER1], [COLOR_[SCHEMA:1,1]]  
TRIANGLE = [ALL], [QUARTER2], [COLOR_[SCHEMA:2,1]]  
TRIANGLE = [ALL], [QUARTER3], [COLOR_[SCHEMA:3,1]]  
TRIANGLE = [ALL], [QUARTER4], [COLOR_[SCHEMA:4,1]]
```

If the label [SCHEMA] was, as an example, “PFPM”, these lines will be evaluated as:

```
TRIANGLE = [ALL], [QUARTER1], [COLOR_P]  
TRIANGLE = [ALL], [QUARTER2], [COLOR_F]  
TRIANGLE = [ALL], [QUARTER3], [COLOR_P]  
TRIANGLE = [ALL], [QUARTER4], [COLOR_M]
```

Tip: you can view a list of labels, their contents, and choose one of them from a list, clicking on the button “Insert” and choosing the menu voice “Label”.

You can extract a single element in a sequence using the ? operator in an expression (delimited with curly brackets { and }). If you omit the number, it is used the current card (i.e., is the same to use ? or ?\$).

For example, this script will print the letter “c”:

```
[ALPHA] = a|b|c|d|e  
FONT = ARIAL, 32, , #000000  
TEXT = 1, {ALPHA?3}, 0, 0, 100%, 100%
```

There is also a syntax for creating labels with a condition and with a for...next cycle (note that you cannot define a label between standard IF...ENDIF or FOR...NEXT blocks):

```
[label]%[condition], variable, start, end, step = value
```

The [condition] parameter must be a label (only if present since it is optional); it cannot be written directly because a condition is too complex to be evaluated correctly in a single line. This is an example:

```
[check1]=[a]=1  
[check2]=[a]<>1
```



```
[color] %[check1] = #FF0000
[color] %[check2] = #0000FF
```

In this example, if [a] is 1, the label [color] is red (#FF0000), if [a] is not 1, the label [color] is blue (#0000FF).

The condition can be omitted, in this case the label is defined only if it does not already exist. In this example, the label [alpha] is red, and the label [beta] is blue:

```
[alpha] = #FF0000

[alpha] % = #0000FF
[beta] % = #0000FF
```

The label creation can be repeated in a for...next cycle, for example, if you want to define ten labels, with powers of two, you can write:

```
[lab(count)] %, (count), 1, 9 = {(count)^2}
```

Note that the condition parameter is empty (the comma after the % symbol), and that if the step parameter is omitted, its value is assumed equal to one. The variable (count) can be anything (the parentheses are not really needed). The result is equal to write this code:

```
[lab1]=1
[lab2]=4
[lab3]=9
[lab4]=16
[lab5]=25
[lab6]=36
[lab7]=49
[lab8]=64
[lab9]=81
```

Instead of a cycle between two values, this is an alternate syntax for the definitions of labels in a loop:

```
[label] %[condition], variable, [sequence] = value
```

In this syntax, a step in the loop is executed for each value of the sequence (value that is replaced in the variable), for example:

```
[seq] = alpha|beta|gamma
[lab_(var)] %, (var), [seq] = test_(var)
```

The result is equal to this script:

```
[lab_alpha]=test_alpha
[lab_beta]=test_beta
[lab_gamma]=test_gamma
```

Note that if **[condition]** is a sequence of more than one value, the result would be a sequence; if you want to obtain a sequence without using a **[condition]** parameter, you can replace it with the **&** flag, for example:

```
[seq] = alpha|beta|gamma
[lab] %&, (var), [seq] = test_(var)
```

The result is equal to this script:

```
[lab]=test_alpha|test_beta|test_gamma
```

Note that the interaction between ranges and sequences is based on the extraction of the Nth element from a sequence when is rendered the Nth card in the range, i.e., if you have a range that does not starts with the 1st card of the deck, the elements from the sequence are apparently extracted wrongly. Example:

```
[ALPHA] = a|b|c|d|e
FONT = ARIAL, 32, , #000000
TEXT = 3-5, [ALPHA], 0, 0, 100%, 100%
```

In the 3rd card (the 1st of the range) shows the letter **a** (the 1st of the sequence). If you instead want to show the letter **c** you must add a **BASERANGE** directive:

```
BASERANGE = 1-5, ON
[ALPHA] = a|b|c|d|e
FONT = ARIAL, 32, , #000000
TEXT = 3-5, [ALPHA], 0, 0, 100%, 100%
```

With the **BASERANGE** directive (see page 78), nanDECK uses the position of the Nth card from all the deck (and not from the range) to evaluate what element to extract from the sequence, and therefore in the 3rd card it goes the 3rd element (i.e., the letter **c**).

Label functions

AUTOLABEL

This function creates a label containing a sequence of numbers. This is the syntax:

```
[name] = AUTOLABEL(start, end, step, separator, padding)
```

For example, this line:

```
[a] = AUTOLABEL(1, 10, 2)
```

will be evaluated as:

```
[a] = 1|3|5|7|9|11
```

The standard separator is the pipe (the “|” character), if you want a different separator, you can specify it as the 4th parameter. If you specify a number in the 5th parameter, the result number is padded to the left with zeroes until the length of the number reach that parameter.

AUTORANGE

This function calculates a range starting from the previous AUTORANGE (or card 1, if it was the first instance), the only parameter is the number of cards in the range (or, if omitted, the number of lines in the linked file). This is the syntax:

```
[name] = AUTORANGE(number)
```

For example, these rows:

```
[a] = AUTORANGE(10)  
[b] = AUTORANGE(5)  
[c] = AUTORANGE(8)
```

will be evaluated as:

```
[a] = 1-10  
[b] = 11-15  
[c] = 16-23
```

You can reset the counter, using a negative number as parameter. For example, these rows:

```
[a] = AUTORANGE(10)  
[b] = AUTORANGE(-5)  
[c] = AUTORANGE(8)
```

will be evaluated as:

```
[a] = 1-10  
[b] = 1-5  
[c] = 6-13
```

CALC

This function is used to get a result from a specific trigonometric function. The syntax is:

```
[label] = CALC(flag, value1, value2)
```

You can choose one of these flags:

C cosine function of value1,
 S sine function of value1,
 T tangent function of value1,
 P pi function (the other parameters are not used),
 M the higher between value1 and value2,
 N the lower between value1 and value2.

CASESTRING

This function modifies the capitalization of a string, this is the syntax:

```
[label] = CASESTRING(string, flag)
```

You can choose one of these flags:

U the string changes to uppercase
 L the string changes to lowercase
 F every first character in a string is changed to uppercase, the others to lowercase

If the flag is not specified, the string is changed to uppercase. Note that for texts printed with HTMLTEXT, there are also three flag in the HTMLFONT directive (see page 111).

CONCAT

This function creates a label concatenating different strings (if you want to concatenate sequences, use JOIN, see page 34, or PRODUCT, see page 36, instead), this is the syntax:

```
[name] = CONCAT(parameter1, repeat1, parameter2, repeat2, ...parameterN, repeatN)
```

Each parameter is repeated several times equal to the next parameter. This is an example:

```
[test] = CONCAT(#000000, 3, #FFFFFF, 2)
```

Will be evaluated as:

```
[test] = #000000#000000#000000#FFFFFF#FFFFFF
```

CONCAT1

This function is equivalent to **CONCAT**, with a repetition of each parameter of one, this is the syntax:

```
[name] = CONCAT(parameter1, parameter2, ...parameterN)
```

COOFRAME

This function outputs the four coordinates of a frame (see page 42); instead of using the standard **<frame>** syntax, that is evaluated in the Validate step, this function is evaluated later, in the Build step. This is the syntax:

```
[name] = COOFRAME(frame)
```

COOFRAMES

This function is like COOFRAME and is used when there is more than one frame that can be selected. The 1st parameter is the number of the frame, selected from all that have the name specified in the 2nd parameter (you can also use wildcard characters like * and ?):

```
[name] = COOFRAMES(number, frame)
```

COOICON

This function returns the space occupied by an icon (x, y, width, height), given its key; if an icon with that key is not drawn on the current card, the function returns null coordinates and the directive that uses that coordinate does not draw anything. This is the syntax:

```
[name] = COOICON(key, type, width, height, index)
```

Instead of the whole space, you can use a section of it, specifying a *type* parameter, chosen from this list:

TL	a section aligned to the top-left, using width and height as % of the icon space
TC	a section aligned to the top-center, using width and height as % of the icon space
TR	a section aligned to the top-right, using width and height as % of the icon space
CL	a section aligned to the center-left, using width and height as % of the icon space
CC	a section aligned to the center, using width and height as % of the icon space
CR	a section aligned to the center-right, using width and height as % of the icon space
BL	a section aligned to the bottom-left, using width and height as % of the icon space
BC	a section aligned to the bottom-center, using width and height as % of the icon space
BR	a section aligned to the bottom-right, using width and height as % of the icon space
TW	a section with the width of the icon space, aligned to the top, with a height as % of the icon space
CW	a section with the width of the icon space, aligned to the center, with a height as % of the icon space
BW	a section with the width of the icon space, aligned to the bottom, with a height as % of the icon space
HL	a section with the height of the icon space, aligned to the left, with a width as % of the icon space
HC	a section with the height of the icon space, aligned to the center, with a width as % of the icon space
HR	a section with the height of the icon space, aligned to the right, with a width as % of the icon space
PTL	a single point in the top-left
PTC	a single point in the top-center
PTR	a single point in the top-right
PCL	a single point in the center-left
PCC	a single point in the center
PCR	a single point in the center-right
PBL	a single point in the bottom-left
PBC	a single point in the bottom-center
PBR	a single point in the bottom-right
HTL	a triangle, the top-left half of the icon space
HTR	a triangle, the top-right half of the icon space
HBL	a triangle, the bottom-left half of the icon space
HBR	a triangle, the bottom-right half of the icon space
TTL	a triangle, pointing to the top-left of the icon space
TTC	a triangle, pointing to the top-center of the icon space
TTR	a triangle, pointing to the top-right of the icon space
TCL	a triangle, pointing to the center-left of the icon space
TCR	a triangle, pointing to the center-right of the icon space
TBL	a triangle, pointing to the bottom-left of the icon space
TBC	a triangle, pointing to the bottom-center of the icon space
TBR	a triangle, pointing to the bottom-right of the icon space
ET	a line, from top-left to top-right of the icon space
EB	a line, from bottom-left to bottom-right of the icon space
EL	a line, from top-left to bottom-left of the icon space
ER	a line, from top-right to bottom-right of the icon space
ED	a line, from top-left to bottom-right of the icon space
EG	a line, from bottom-left to top-right of the icon space

If you do not specify the index parameter and there are more than one icon with that specific key, the result is the sum of the spaces. Otherwise you can specify the Nth instance of an icon by using the index parameter.

DIRFILES

This function creates a sequence label using names of files from a folder (and subfolders), this is the syntax:

```
[name] = DIRFILES(path, extension)
```

The extension can be a sequence of extensions, like jpg|bmp|gif.

This is an example:

```
[img] = DIRFILES("c:\images\", jpg)
```

and it will be evaluated as:

```
[img] = "c:\images\one.jpg|c:\images\two.jpg|c:\images\three.jpg"
```

Instead of an extension, you can specify in the 2nd parameter a file mask (with * and ? as wildcards). For example:

```
[img] = DIRFILES("c:\images\", "img*.jpg")
```

You can also combine the two parameters in one. For example:

```
[img] = DIRFILES("c:\images\img*.jpg")
```

ENVIRONMENT

This function reads an environment variable from the operating system, this is the syntax:

```
[name] = ENVIRONMENT(variable)
```

For example, this reads the path for the user folder:

```
[folder] = ENVIRONMENT(userprofile)
```

EVAL

This function creates a sequence with the results of the evaluation of another sequence, this is the syntax:

```
[name] = EVAL(sequence)
```

This is an example:

```
[alpha] = {1+1}|{2*3}|{3^3}  
[beta] = EVAL([alpha])
```

These two lines are equivalent to:

```
[beta] = 2|6|27
```

Note: you obtain the same result with a single line:

```
[beta] = EVAL({1+1}|{2*3}|{3^3})
```

EXPAND

This function creates a sequence replicating itself *numseq* times, with each element replicated *numele* times (this parameter is optional, if not specified is treated equal to one):

```
[name] = EXPAND(sequence, numseq, numele)
```

This is an example:

```
[alpha] = a|b|c  
[beta] = EXPAND([alpha], 2, 3)
```

These two lines are equivalent to:

```
[beta] = a|a|a|b|b|b|c|c|c|a|a|a|b|b|b|c|c|c
```

The *numele* parameter can also be a sequence of numbers, if you need to specify a different number of copies of each single element. For example:

```
[alpha] = a|b|c  
[beta] = 1|2|3  
[gamma] = EXPAND([alpha], 1, [beta])
```

These three lines are equivalent to:

```
[gamma] = a|b|b|c|c|c
```

FILTER

This function creates a sequence taking elements from another sequence, filtering and grouping them using some rules. The basic syntax is:

```
[name] = FILTER([name], filter1, filter2 ...filterN)
```

In the filterN parameters you can use wildcards: ? for any character, * for any characters, and use ranges of characters within parenthesis (as an example, **1(0-9)** matches a number from 10 to 19). For example, this script will print only elements that start with a zero (four elements on eight):

```
[ALPHA] = 000|001|010|011|100|101|110|111  
[BETA] = FILTER([ALPHA], 0*)  
FONT = ARIAL, 32, , #000000  
TEXT = 1-{(BETA)}, [BETA], 0, 0, 100%, 100%
```

In the 1st parameter you can specify these additional flags:

§	the sorted/added elements are used to create the new sequence
>	(multiple, header) sort characters from an element in ascending order before comparing it to the filters
<	(multiple, header) sort characters from an element in descending order before comparing it to the filters
+	(multiple, header) add numbers from an element before comparing it to the filters
@	keep only the characters specified after this flag
#	discard all the characters specified after this flag
\$	(multiple, header) counts the maximum occurrences of a character(s) in the same element
?	(multiple, header) counts the number of different characters(s) in the same element
^	(multiple, header) counts the maximum occurrences of specific character(s) in all positions on the previous accepted elements
~	(header) counts all the occurrences of specific character(s) in all positions on the previous accepted elements
=	(multiple, header) counts the maximum occurrences of specific character(s) in the same position on the previous accepted elements
£	(header) counts the maximum occurrence of a straight of characters
°	set the rule for evaluating a straight (if not specified, is used the ASCII sequence of letters/numbers)
%	(multiple) replace a character(s) with another(s), all the couples are specified after this flag
!	counts the distance (in characters) between two copies of the same characters, specified after this flag
&	(header) the element is evaluated from his position within the sequence, starting from one
¬	the condition (for including or not an element) is reversed (for inserting the symbol, type ALT + 0172)
_	if an element is not included, a null string is added in its position
ç	the result is not padded with zeroes to the length of the longest element
.	(multiple, header) the starting characters in each element are permuted

You can combine multiple flags and use a space if you want to mix two similar functions, for example, a \$ followed by \$\$ can be coded as "\$ \$\$". The flags marked with *header* must be specified before the sequence, not after.

For example, this script will print only elements that contains one zero and two ones (three elements on eight):

```
[ALPHA] = 000|001|010|011|100|101|110|111  
[BETA] = FILTER(>[ALPHA], 011)
```

```
FONT = ARIAL, 32, , #000000
TEXT = "1-{(BETA)}", [BETA], 0, 0, 100%, 100%
```

The flags marked with (*multiple*) in the above list (i.e.: > < + \$? ^ = % .) can be repeated, when you must consider elements not as single characters, but as strings composed with more than one character. For example, the element “0123” gives these results:

```
+      6
++     24
>     0123
>>   0123
<     3210
<<   2301
```

This is an example for utilization of “\$” flag. First, a label is created with all the permutations (with repetitions) of four elements from a set of five (a, b, c, d, and e), then, another label is created filtering only the occurrence of a three-of-a-kind and four-of-a-kind:

```
pr[a]4 = a|b|c|d|e
[b] = FILTER($[a], 3, 4)
FONT = ARIAL, 64, , #000000
TEXT = 1-{(b)}, [b], 0, 0, 100%, 100%
```

In this example, the same sequence is filtered to get only the labels that contain one or less repetitions of the same character in the same position:

```
pr[a]4 = a|b|c|d|e
[b] = FILTER(=[a], 0, 1)
FONT = ARIAL, 64, , #000000
TEXT = 1-{(b)}, [b], 0, 0, 100%, 100%
```

In this example of the replacement option (with the % option), the characters “a”, “d”, and “g” are replaced with the numbers “1”, “2”, and “3”:

```
[test_a] = abc|def|ghi
[test_b] = FILTER($[test_a]%a1d2g3)
```

The result sequence [test_b] is equal to:

```
1bc|2ef|3hi
```

Usually, the strings found and replaced with the % option are the same length, but you can specify a null character using a ¢ symbol (for inserting it, type ALT + 0162). Example:

```
[test_a] = abc|def|ghi
[test_b] = FILTER($¢[test_a]%%abx¢de¢¢)
```

Note the ¢ symbol added to disable the padding; the result sequence [test_b] is equal to:

```
xc|f|ghi
```

You can create a sequence of parameters with a “FOR=” keyword, for example, if you want ten numbers, instead of adding all of them you can use a single parameter like “1-10FOR=-” (the 2nd minus symbol is the position of the counter in the result).

Instead of a parameter used as a filter, you can specify a “mask” (with the prefix “MASK=”), that is used to apply the filter only to some characters of the elements from the sequence; you specify a character that you want to consider with a “1”, and a character to ignore with a “0”. For example, if you want to apply the rules only to the even characters of a ten-character string, use this parameter: MASK=0101010101

If there are more than one rule in the 1st parameter, and if you specify a number before the mask keyword, that mask is applied only to a single rule (1 for the 1st rule, 2 for the 2nd, and so on).

GRADIENTSEQ

This function creates a sequence of gradients, splitting one into several sections, the syntax is:

```
[name] = GRADIENTSEQ(gradient, number, element)
```

For example, with this line the program creates a sequence of three gradients:

```
[gradient] = GRADIENTSEQ(#000000#FF0000@0, 3)
```

If you do not specify the 3rd parameter, the sequence contains *number* element; instead, it contains only the Nth parameter, where N is the 3rd parameter.

GROUP

This function takes all the elements in a sequence and removes all the duplicate elements, optionally, it can return a count of all the elements adding the keyword **COUNT** in the 2nd parameter. The syntax is:

```
[name] = GROUP(sequence, function)
```

For example:

```
[alpha] = a|b|a|e|c|c|c|a|b|f|d|e  
[beta] = GROUP([alpha])  
[gamma] = GROUP([alpha], COUNT)
```

The two resulting sequences contain these values:

```
[beta] = a|b|c|d|e|f  
[gamma] = 3|2|3|1|2|1
```

IMAGECREATE

This function can be used to create an image executing another nanDECK script, and it returns the name of the (temporary) image file (note that only card #1 is saved). The syntax for this function is:

```
[name] = IMAGECREATE(script, param1, param2, param3, param4, param5)
```

The optional parameters can be used in the called script as labels, named respectively [param1], [param2], [param3], [param4], and [param5]. If you want to save a PNG image with a transparent color, you can specify it as a parameter, in the format **PNGTRANS=**color (example, **PNGTRANS=#FFFFFF**).

INDEX

This function returns the position of a substring in a string, the syntax is:

```
[name] = INDEX(substring, string)
```

Note that both the parameters, or only one parameter, can be sequences, in this case the return is a sequence instead of a single value.

INFO

This function returns a value that depends on the flag used, the syntax is:

```
[name] = INFO(flag)
```

The flag can be one of this:

S the filename of the current script
C the number of the current card

JOIN

This function uses alternatively the elements from two (or more) sequences for building a new sequence, the syntax is:

```
[name] = JOIN(sequence1, sequence2, ...sequenceN)
```

The length of the new sequence is equal to the longest source sequence. This is an example:

```
[label1] = A|B  
[label2] = 1|2|3|4  
[label3] = JOIN([label1], [label2])
```

The 3rd label will be evaluated as:

```
[label3] = A1|B2|A3|B4
```

JOINIF

This function adds elements to a sequence using a condition to choose from two other sequences, the syntax is:

```
[name] = JOINIF(sequence, value1, condition, value2, sequence true, sequence false)
```

Every parameter can be a single value or a sequence. The condition can be one of these symbols:

=	equal
<>	different
>	major
<	minor
>=	major or equal
<=	minor or equal
@	contained
#	not contained

This is an example:

```
[label] = JOINIF(A|B|C, 1|2|3, <=, 2, D|E|F, X)
```

The label will be evaluated as:

```
[label] = AD|BE|CX
```

LABELRANGE

This function creates a range, using elements from a sequence. The syntax for this function is:

```
[name] = LABELRANGE(sequence, value, offset)
```

If you specify the optional *value* parameter, the range is created with only the cards matching the *value* parameter position (wildcards * and ? are accepted). If you do not specify the *value* parameter, the default element from a sequence is considered "1". The *offset* parameter, if specified, will be added to every card of the range.

For example:

```
[sequence] = 0|1|1|1|0|0|1  
[label] = LABELRANGE([sequence])
```

Result:

```
[label] = "2,3,6"
```

The *item* parameter can also accept these operators (in the format *operatorvalue*):

=	the item's position from the sequence is included if it is equal to the value (this operator can be omitted)
<>	the item's position from the sequence is included if it is different from the value
>	the item's position from the sequence is included if it is greater than the value
<	the item's position from the sequence is included if it is smaller than the value
>=	the item's position from the sequence is included if it is greater or equal to the value
<=	the item's position from the sequence is included if it is smaller or equal to the value
@	the item's position from the sequence is included if the value is contained in it
#	the item's position from the sequence is included if the value is not contained in it

For example:

```
[sequence] = 1|2|3|4|5|6|7|8|9|10  
[label] = LABELRANGE([sequence], >=5)
```

Result:

```
[label] = "5,6,7,8,9,10"
```

LABELSTRING

This function creates a string with elements taken from a sequence. The syntax for this function is:

```
[name] = LABELSTRING(sequence, number)
```

Without the optional *number* parameter, the result is a single string, taken from concatenating every element of the sequence. If you specify a number as 2nd parameter, for every nth element a new element of the sequence is created. For example:

```
[sequence] = A|B|C|D|E|F  
[label] = LABELSTRING([sequence])
```

These two lines are equivalent to:

```
[label] = ABCDEF
```

Another example:

```
[sequence] = A|B|C|D|E|F  
[label] = LABELSTRING([sequence], 2)
```

Result:

```
[label] = AB|CD|EF
```

LABELSUB

This function extracts a sequence from another, taken only the elements in a range, the syntax is:

```
[name] = LABELSUB(sequence, "range")
```

For example:

```
[sequence] = LABELSUB(alpha|beta|gamma|delta, "1,3-4")
```

Result:

```
[sequence] = alpha|gamma|delta
```

LENGTH

This function creates a new sequence with the lengths of the elements of the sequence in the 1st (and only) parameter, the syntax is:

```
[name] = LENGTH(sequence)
```

For example:

```
[sequence] = ABC|DE|F|GH|IJK|LMNO  
[label] = LENGTH([sequence])
```

Result:

```
[label] = 3|2|1|2|3|4
```

Note that letters outside the standard codepage read from a spreadsheet are converted to HTML codes and therefore with a length longer than one, therefore if you need the correct length you should before read the spreadsheet with a LINKUNI=OFF line (see page 137).

PDFMERGE

This function creates a new PDF file, you can specify a file or a sequence of files as sources, with related page ranges (the syntax for a range is, for example, "1-10,15,18,20-30"), if the result file is not already present, it is created (otherwise, it is overwritten). This function is the equivalent of the MERGEPDF directive (see page 140). The syntax is:

```
[name] = pdfmerge("result file", "source file", "source range", rotation)
```

Example (a loop to split a pdf into single pages):

```
[pdf]%, (a), 1, PDFPAGES(source.pdf) = PDFMERGE(split(a).pdf, source.pdf, (a))
```

PDFPAGES

This function returns the number of the pages contained in a PDF file. The syntax is:

```
[name] = pdfpages("filename")
```

PRODUCT

This function combines two (or more) sequences, in the result every element of the first sequence is combined with every element of the second sequence (and so on), the syntax is:

```
[name] = PRODUCT(sequence1, sequence2, ...sequenceN)
```

The length of the new sequence is equal to the product of the length of all source sequences. This is an example:

```
[label1] = A|B  
[label2] = 1|2|3|4  
[label3] = PRODUCT([label1], [label2])
```

The 3rd label will be evaluated as:

```
[label3] = A1|A2|A3|A4|B1|B2|B3|B4
```

RANGEADD

This function combines several ranges in one, the syntax is:

```
[range] = RANGEADD("range1", "range2", ..."rangeN")
```

For example:

```
[range1] = "1-3"  
[range2] = "2-4"  
[range3] = "8-10"  
[range] = RANGEADD([range1],[range2],[range3])
```

Result:

```
[range] = "1-4,8-10"
```

RANGECOUNT

This function returns the number of cards in a range, the syntax is:

```
[number] = RANGECOUNT("range")
```

For example:

```
[number] = RANGECOUNT("1,4-6,10-15")
```

Result:

```
[number] = 10
```

RANGELABEL

This function converts a sequence of numbers into a range:

```
[label] = RANGEREM([sequence])
```

For example:

```
[seq] = 1|2|3|10  
[range] = RANGELABEL([seq])
```

Result:

```
[range] = "1,2,3,10"
```

RANGEMERGE

This function creates a new range mixing the cards from two or more ranges:

```
[range] = RANGEMERGE("range1", "range2", ..."rangeN")
```

For example:

```
[range] = RANGEMERGE(1-5,6-10)
```

Result:

```
[range] = "1,6,2,7,3,8,4,9,5,10"
```

RANGEMUL

This function creates a new range from pairs of range/number of repetitions of that range:

```
[range] = RANGEMUL("range1", num1, "range2", num2, ..."rangeN", numN)
```

For example:

```
[range] = RANGEMUL(1,2,3,4)
```

Result:

```
[range] = "1,1,3,3,3,3"
```

RANGEREM

This function extracts a sub-range from another range, this is the syntax:

```
[range] = RANGEREM("range1", "range2", ..."rangeN")
```

This directive removes the ranges *range2*, ... *rangeN* from *range1*.

For example:

```
[range1] = "1-10"  
[range2] = "3,4"  
[range3] = "7-9"  
[range] = RANGEREM([range1], [range2], [range3])
```

Result:

```
[range] = "1-2,5-6,10"
```

RANGESUB

This function extracts a sub-range from another range, this is the syntax:

```
[range] = RANGESUB("range", start, number)
```

The sub-range starts from the element specified by the *start* parameter and is composed of *number* elements. If the *number* parameter is missing (or equal to zero) the sub-range goes to the end of the initial range; if the *start* parameter is equal to zero, the sub-range starts from the last element taken with another RANGESUB function (or from the start of the initial range), in a behavior like that implemented with AUTORANGE function.

For example:

```
[range1] = "1-10"  
[range] = RANGESUB([range1], 3, 4)
```

Result:

```
[range] = "3-6"
```

REPLACE

This function replaces in a string (or a sequence) all instances of a substring with another. The syntax for this function is:

```
[name] = REPLACE("string", "from", "to", flags)
```

You can choose one of these flags:

- C the replacement is made case-sensitive (the default)
- I the replacement is made case-insensitive

ROUND

This function returns the 1st parameter rounded, the 2nd parameter specify the number of decimal digits (if not specified, it is zero, if it's a negative number, the rounding is by power of tens), the 3rd parameter is a keyword that specify if the rounding is UP, or DOWN (if you don't specify it, the rounding is down when the rounded digit is 4 or less, and up if it's 5 or more). The syntax is:

```
[name] = ROUND(value, precision, keyword)
```

SAVELABEL

This function saves the content of a label (or more than one label) into a CSV text file or a spreadsheet file (if the extension of the filename is .xls or .xlsx). The syntax for this function is:

```
[name] = SAVELABEL("filename", label1 , label2, ...labelN)
```

The result label [**name**] contains the filename. Note: do not use the [] in the label parameters.

SCHEMA

This function creates a sequence label with multiple elements taken from another sequence, to be used to create structures like tables, when the number of sub-elements may change. The syntax for this function is:

```
[name] = SCHEMA(sequence, number, header, footer, body1, body2, ...bodyN)
```

Each element in the sequence may contain multiple sub-elements, each one delimited by an underscore “_”; each element contained in the resulting sequence is composed by the **header**, one **body** for each element of the starting sequence, and one **footer**; in these resulting elements you can replace parameters with sub-elements taken from the starting sequence; the syntax for these parameters is ((N)), and the number of sub-elements that must be considered present in one of the body element of the resulting sequence is defined by the 2nd parameter (**number**) of the function. For example:

```
[data] = "one_two|three_four_five_six"  
[result] = SCHEMA([data], 2, "<table>", "</table>", "<tr> <td> ((1)) </td> <td>  
((2)) </td> </tr>")
```

The [**result**] label is equal to (spaces are added to increase readability):

```
[result] = <table><tr> <td> one </td> <td> two </td> </tr></table>|<table><tr>  
<td> three </td> <td> four </td> </tr> <tr> <td> five </td> <td> six </td>  
</tr></table>
```

You can specify multiple **body** parameters, that are use one for each sequence element, i.e., if you specify two body parameters, one is used for odd elements, and the other for even elements.

STRINGLABEL

This function creates a sequence label with elements taken from a string. The syntax for this function is:

```
[name] = STRINGLABEL("string", length)
```

The optional length parameter sets the number of characters taken for each element of the sequence. If omitted, the length is one character. For example, these two lines are equivalent:

```
[label] = STRINGLABEL("This is a test")  
  
[label] = "T|h|i|s| |i|s| |a| |t|e|s|t"
```

STRINGSUB

This function extracts a substring from a string, or a sequence of substrings from a sequence of string. The syntax for this function is:

```
[name] = STRINGSUB("string", start, length)
```

If the length parameter is omitted, the substring is extracted until the end of the string.

TAGFRAME

This function can be used to associate a string to a frame (to be used as a color for VORONOI directive, see page 169), or to create a label that contains the strings associated with a frame. You can also specify a list of frames using the * symbol (and the resulting label will be a sequence). The syntax for this function is (when used to create a label, do not use the **tag** parameter):

```
[name] = TAGFRAME(frame, tag)
```

TOKENIZE

This function extracts a substring from a string, using a separator that slices the string into several tokens, and a number that specify the single token extracted. The syntax for this function is:

```
[name] = TOKENIZE("string", number, separator)
```

If the separator is not specified, is assumed to be equal to “|” (pipe), note that is the same separator for the elements in a sequence. For example:

```
[result] = TOKENIZE("Alpha-Beta-Gamma", 2, -)
```

The **[result]** label would be equal to “**Beta**”

TOKENIZESEQ

This function extracts a sequence from another sequence, using a separator that slices each element of that sequence into several tokens, and a number that specify which tokens are extracted; all the tokens are concatenated in the result sequence. The syntax for this function is:

```
[name] = TOKENIZESEQ("string", number, separator)
```

For example:

```
[result] = TOKENIZESEQ("Alpha-Beta-Gamma|Delta-Epsilon-Zeta|Eta-Theta-Iota", 2, -)
```

The **[result]** label would be equal to “**Beta|Epsilon|Theta**”

TRANSLATE

This function replaces in a sequence (specified in the 1st parameter) all the elements found in another sequence (specified in the 2nd parameter) with elements taken from another sequence (specified in the 3rd parameter). The syntax is:

```
[label] = TRANSLATE(sequence, sequence key, sequence value)
```

For example, this script:

```
[test] = x|y|x|w|x|y|y|z
[from] = x|y|z
[to] = a|b|c
[result] = TRANSLATE([test],[from],[to])
```

Gives this sequence as a result:

```
[result] = a|b|a||a|b|b|c
```

Frames

A frame is a special label, used when you need to identify a rectangular area used for placing a graphical content. A frame is defined used this syntax:

```
<name> = position x, position y, width, height
```

And can be used for example with a RECTANGLE directive:

```
RECTANGLE = 1, <name>, #000000
```

This is a behavior that can be done also with a label, but in a frame, you can add an alignment and a specific size, with this syntax:

```
<name, alignment, width, height>
```

The “alignment” can be a flag from this list:

TL	top-left
TC	top-center
TR	top-right
CL	center-left
CC	center-center
CR	center-right
BL	bottom-left
BC	bottom-center
BR	bottom-right

An example with all these nine alignments:

```
<frame> = 1, 1, 4, 7
FONT = Arial, 16, , #FFFFFF, #0000FF
RECTANGLE = 1, <frame>, #CCCCFF
TEXT = 1, "TL", <frame, TL, 1, 1>, CENTER, CENTER
TEXT = 1, "TC", <frame, TC, 1, 1>, CENTER, CENTER
TEXT = 1, "TR", <frame, TR, 1, 1>, CENTER, CENTER
TEXT = 1, "CL", <frame, CL, 1, 1>, CENTER, CENTER
TEXT = 1, "CC", <frame, CC, 1, 1>, CENTER, CENTER
TEXT = 1, "CR", <frame, CR, 1, 1>, CENTER, CENTER
TEXT = 1, "BL", <frame, BL, 1, 1>, CENTER, CENTER
TEXT = 1, "BC", <frame, BC, 1, 1>, CENTER, CENTER
TEXT = 1, "BR", <frame, BR, 1, 1>, CENTER, CENTER
```

Result: Figure 1

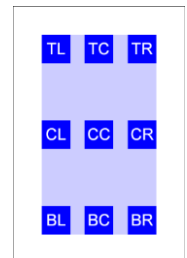

Figure 1

One between width and height can be expanded to the full extent of frame’s width or height, using this syntax and one of these alignments for width:

```
<name, alignment, height>
```

TW	top aligned, full width
CW	center aligned, full width
BW	bottom aligned, full width

Example:

```
<frame> = 1, 1, 4, 7
FONT = Arial, 16, , #FFFFFF, #0000FF
RECTANGLE = 1, <frame>, #CCCCFF
TEXT = 1, "TW", <frame, TW, 1>, CENTER, CENTER
TEXT = 1, "CW", <frame, CW, 1>, CENTER, CENTER
TEXT = 1, "BW", <frame, BW, 1>, CENTER, CENTER
```

Result: Figure 2

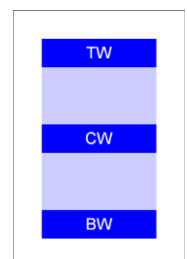

Figure 2

This syntax and these alignments are used for a full height:

```
<name, alignment, width>
```

HL full height, left aligned
HC full height, center aligned
HR full height, right aligned

```
<frame> = 1, 1, 4, 7  
FONT = Arial, 16, , #FFFFFF, #0000FF  
RECTANGLE = 1, <frame>, #CCCCFF  
TEXT = 1, "HL", <frame, HL, 1>, CENTER, CENTER  
TEXT = 1, "HC", <frame, HC, 1>, CENTER, CENTER  
TEXT = 1, "HR", <frame, HR, 1>, CENTER, CENTER
```

Result: Figure 3

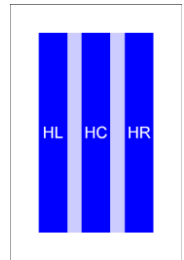

Figure 3

Another type of syntax can be used to extract only a position (useful with lines):

```
<name, alignment>
```

PTL top-left
PTC top-center
PTR top-right
PCL center-left
PCC center-center
PCR center-right
PBL bottom-left
PBC bottom-center
PBR bottom-right

```
<frame> = 1, 1, 4, 7  
RECTANGLE = 1, <frame>, #CCCCFF  
LINE = 1, <frame, PTL>, <frame, PBR>, #FF0000, 0.2  
LINE = 1, <frame, PTR>, <frame, PBL>, #FF0000, 0.2
```

Result: Figure 4

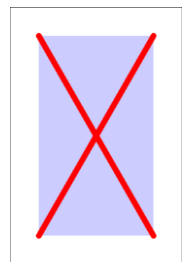

Figure 4

Instead of using two frames, you can also combine two alignments of this type in a single frame, for example, with this script the result is the same of the above example:

```
<frame> = 1, 1, 4, 7  
RECTANGLE = 1, <frame>, #CCCCFF  
LINE = 1, <frame, PTL, PBR>, #FF0000, 0.2  
LINE = 1, <frame, PTR, PBL>, #FF0000, 0.2
```

Instead of using a size (width or height) in cm, you can use a fraction of the whole frame size, using a number followed by “%%” (instead, a single “%” gives you a size equal to a fraction of the whole card). For example:

```
<frame> = 1, 1, 4, 7  
FONT = Arial, 16, , #FFFFFF, #0000FF  
RECTANGLE = 1, <frame>, #CCCCFF  
TEXT = 1, "TL", <frame, TL, 50%%, 50%%>, CENTER, CENTER
```

Result: Figure 5

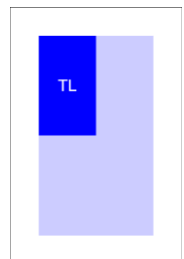

Figure 5

Tip: you can view a list of frames, their contents, and choose one of them from a list, clicking on the button “Insert” and choosing the menu voice “Frame”.

With these syntaxes, you can align a sub-frame starting from the last sub-frame, in the four directions:

TS top aligned, full width
BS bottom aligned, full width

SL left aligned, full height
 SR right aligned, full height

```
<frame> = 1, 1, 4, 7
FONT = Arial, 16, , #FFFFFF, #0000FF
TEXT = 1, TS1, <frame, TS, 1>, CENTER, CENTER
FONT = Arial, 16, , #FFFFFF, #00FF00
TEXT = 1, TS2, <frame, TS, 1>, CENTER, CENTER
FONT = Arial, 16, , #FFFFFF, #FF0000
TEXT = 1, TS3, <frame, TS, 1>, CENTER, CENTER
FONT = Arial, 16, , #000000, #FFFF00
TEXT = 1, TS4, <frame, TS, 0>, CENTER, CENTER
```

Result: Figure 6

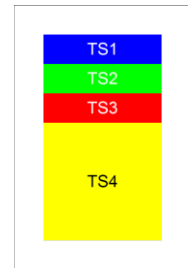

Figure 6

In this example, the first frame can also be referenced with TW, and the result did not change.
 If you specify a zero as the width/height of the element, it fills all the available space (the 4th frame in this example).

With these flags, the program extracts three coordinates from the four of a frame, useful when using the TRIANGLE directive (see page 166), for a shape that fills half of the frame:

HTL top left, top right, and bottom left
 HTR top left, top right, and bottom right
 HBL top left, bottom left, and bottom right
 HBR top right, bottom left, and bottom right

For example:

```
<frame> = 1, 1, 4, 7
RECTANGLE = 1, <frame>, #CCCCFF
TRIANGLE = 1, <frame, HTL>, #FF0000
```

Result: Figure 7

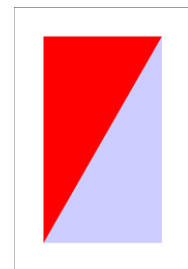

Figure 7

These flags also give three coordinates:

TTL an arrowhead with the point to the top-left corner of the frame
 TTC an arrowhead with the point to the center of the top side of the frame
 TTR an arrowhead with the point to the top-right corner of the frame
 TCL an arrowhead with the point to the center of the left side of the frame
 TCR an arrowhead with the point to the center of the right side of the frame
 TBL an arrowhead with the point to the bottom-left corner of the frame
 TBC an arrowhead with the point to the center of the bottom side of the frame
 TBR an arrowhead with the point to the bottom-right corner of the frame

For example:

```
<frame> = 1, 1, 4, 7
RECTANGLE = 1, <frame>, #CCCCFF
TRIANGLE = 1, <frame, TTC>, #FF0000
```

Result: Figure 8

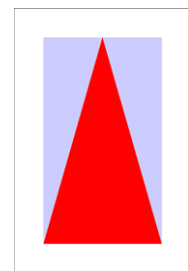

Figure 8

With several functions, you can create groups of frames, and referencing them with wildcards (the list is after this chapter):

- * a group of any characters,
- ? any one character,
- ~ a random frame from a group,
- ! the first frame from a group, the frame is then deleted from the frame group (instead of the first frame, a random frame is selected if used with the “~” symbol),
- / normally, the frames created with a function are added to the existing ones; with this character in the frames’ name, the definition rewrites the previous frames (the name is considered without “/”),
- ° this is not a wildcard used in a frame name, but instead is used when the frame number is needed in a standard expression (with “{” and “}” delimiters),

μ this is not a wildcard used in a frame name, but instead is used when the frame name is needed in a text (without “{” and “}” delimiters).

Finally, in a frame name with ! or ~ wildcards, you can specify more than one frame adding a number before the symbol. For example, if you want three random green boxes from a grid, three blue and three red you can write:

```
[base] = FRAMEBOX(0, 0, 6, 9, 1, 1, E)
RECTANGLE = 1, <3!~base*>, #00FF00
RECTANGLE = 1, <3!~base*>, #0000FF
RECTANGLE = 1, <3!~base*>, #FF0000
GRID = 1, 0, 0, 6, 9, #000000, 0.1, 6, 9
```

Result: Figure 9

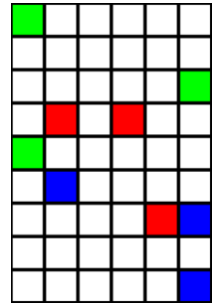

Figure 9

Note: without the “!” symbol, the randomized frames may overlay themselves. Instead, without the “~” symbol, the frames are extracted from the start of the group. For example, with this script:

```
[base] = FRAMEBOX(0, 0, 6, 9, 1, 1, E)
RECTANGLE = 1, <3!base*>, #00FF00
RECTANGLE = 1, <3!base*>, #0000FF
RECTANGLE = 1, <3!base*>, #FF0000
GRID = 1, 0, 0, 6, 9, #000000, 0.1, 6, 9
```

Result: Figure 10

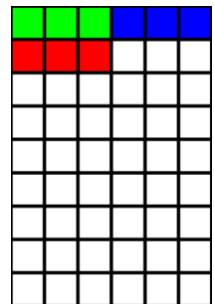

Figure 10

Frame functions

FRAMEBAR

This function creates a list of frames (see page 42) arranged in a line. The syntax for this function is:

```
[name] = FRAMEBAR(pos x1, pos y1, pos x2, pos y2, frame width, frame height, number, zoom)
```

The frames are created with a name composed from the **[name]** and a number, the number goes from “1” to the 7th parameter.

Example:

```
[bar] = FRAMEBAR(0, 0, 6, 6, 1, 1, 5)
```

You can use frames with wildcards (? for any one character, * for a group of any characters), can use the tilde (~) symbol as a flag for addressing a random frame, the exclamation mark (!) as a flag for deleting the frame after use, and referencing the current frame’s number with the degree (°) symbol (in an expression) or the current frame’s name with the micro (μ) symbol (in a text).

The *zoom* optional parameter is used if you want to resize the frame of a percent (100 is equal to no change).

FRAMEBEZIER

This function creates a list of frames (see page 42) arranged in a Bezier curve. The syntax for this function is:

```
[name] = FRAMEBEZIER(pos x1, pos y1, handle x1, handle y1, handle x2, handle y2, pos x2, pos y2, frame width, frame height, number, zoom)
```

The frames are created with a name composed from the **[name]** and a number, the number goes from “1” to the 11th parameter.

Example:

```
[bezier] = FRAMEBEZIER(0, 0, 3, 0, 3, 6, 6, 6, 1, 1, 10)
```

You can use frames with wildcards (? for any one character, * for a group of any characters), can use the tilde (~) symbol as a flag for addressing a random frame, the exclamation mark (!) as a flag for deleting the frame after use, and referencing the current frame’s number with the degree (°) symbol (in an expression) or the current frame’s name with the micro (μ) symbol (in a text).

The *zoom* optional parameter is used if you want to resize the frame of a percent (100 is equal to no change).

FRAMEBOX

This function creates a list of frames (see page 42), based on a rectangular grid. The syntax for this function is:

```
[name] = FRAMEBOX(pos x, pos y, width, height, frame width, frame height, flags, zoom x, zoom y)
```

The last parameters (*zoom x* and *zoom y*) are optional, if not specified are equal to 100 (no zoom); if you want half sized frames, you can specify 50, if you want double sized frames, the value is 200, and so on. The zoom can be different between horizontal and vertical values.

The frames are created with a name composed from the **[name]** and the flag in the 7th parameter. You can use these flags:

L	letters
N	numbers
P	zero-padded numbers
C	coordinates
E	coordinates with letters and numbers

R coordinates with letters and numbers (numbers are reversed)
 . dot separator for C flag
 - minus separator for C flag
 _ underscore separator for C flag
 W add only “white” squares in a chessboard
 B add only “black” squares in a chessboard

With these flags, coordinates are added to each frame name:

L A, B, C, D...
 N 1, 2, 3, 4...
 P 01, 02, 03, 04...
 C 0101,0102,0103...0201,0202,0203...
 E A1,A2,A3...B1,B2,B3...
 C. 1.1,1.2,1.3...2.1,2.2,2.3...
 C- 1-1,1-2,1-3...2-1,2-2,2-3...
 C_ 1_1,1_2,1_3...2_1,2_2,2_3...

If you did not specify any flag, the frames are created with the same name.

Example:

```
[box] = FRAMEBOX(0, 0, 4, 3, 1, 1, C_)
```

The resulting frames will be:

```
<BOX1_1> = 0, 0, 1, 1  

<BOX1_2> = 0, 1, 1, 1  

<BOX1_3> = 0, 2, 1, 1  

<BOX2_1> = 1, 0, 1, 1  

<BOX2_2> = 1, 1, 1, 1  

<BOX2_3> = 1, 2, 1, 1  

<BOX3_1> = 2, 0, 1, 1  

<BOX3_2> = 2, 1, 1, 1  

<BOX3_3> = 2, 2, 1, 1  

<BOX4_1> = 3, 0, 1, 1  

<BOX4_2> = 3, 1, 1, 1  

<BOX4_3> = 3, 2, 1, 1
```

You can use frames with wildcards (? for any one character, * for a group of any characters), can use the tilde (~) symbol as a flag for addressing a random frame, the exclamation mark (!) as a flag for deleting the frame after use, and referencing the current frame’s number with the degree (°) symbol (in an expression), or the current frame’s name with the micro (μ) symbol (in a text). For example, if you want to split an image into 4 images (in a 2 x 2 pattern) and save them, you can use this script:

```
[a] = FRAMEBOX(0, 0, 6, 9, 3, 4.5, N)  

IMAGE = 1, "c:\my images\earth.jpg", 0, 0, 6, 9, 0  

SAVE = 1, "c:\my images\earth_{°}.jpg", <a*>
```

FRAMECLOCK

This function creates a list of frames (see page 42) arranged in a circle (like a clock’s quadrant). The syntax for this function is:

```
[name] = FRAMECLOCK(pos x, pos y, width, height, frame width, frame height,  

number, angle, zoom, start, end, factor)
```

The frames are created with a name composed from the [name] and a number, the number goes from “1” to the 7th parameter.

Example:

```
[clock] = FRAMECLOCK(0, 0, 4, 4, 1, 1, 8)
```

You can use frames with wildcards (? for any one character, * for a group of any characters), can use the tilde (~) symbol as a flag for addressing a random frame, the exclamation mark (!) as a flag for deleting the frame after use, and referencing the current frame's number with the degree (°) symbol (in an expression) or the current frame's name with the micro (μ) symbol (in a text).

The *angle* optional parameter is used if you want to rotate all the frames of a precise degree.

The *zoom* optional parameter is used if you want to resize the frame of a percent (100 is equal to no change).

The *start* and *end* optional parameters are used if you want to draw only an arc instead of full circle (both are degrees).

The *factor* optional parameter, if not zero, creates a spiral of frames, instead of a circle (positive for clockwise spirals, negative for anti-clockwise spirals).

FRAMECOUNT

This function creates a label with the number of frames from a single frame name, or a list of frame names. The syntax for this function is:

```
[name] = FRAMECOUNT(frame1, frame2, ...frameN)
```

In the **[name]** parameter you can use wildcards (? for any one character, * for a group of any characters).

FRAMEDISK

With this function, you can define a group of frames, specifying two frames, and including all the frames in the circle drawn used the first frame as a center and the latter as a radius. It works with frames created from FRAMEBOX and FRAMEHEX functions. The syntax is:

```
[diskgroup] = FRAMEDISK(frame center, frame radius)
```

For example:

```
CARDSIZE = 18, 20
HEXGRID = 1, 0, 0, 18, 20, 1, , #000000, EMPTY, 0.1
[base] = FRAMEHEX(0, 0, 18, 20, 1, E)
[diskgroup] = FRAMEDISK(basee6, basee4)
POLYGON = 1, <diskgroup>, 6, 90, #FF0000
```

FRAMEHEX

This function creates a list of frames (see page 42), based on a hexagonal grid. The syntax for this function is:

```
[name] = FRAMEHEX(pos x, pos y, width, height, hex size, flags, zoom x, zoom y)
```

The last parameters (*zoom x* and *zoom y*) are optional, if not specified are equal to 100 (no zoom); if you want half sized frames, you can specify 50, if you want double sized frames, the value is 200, and so on. The zoom can be different between horizontal and vertical values.

The frames are created with a name composed from the **[name]** and the flag in the 6th parameter. You can use these flags:

L	letters
N	numbers
P	zero-padded numbers
C	coordinates
E	coordinate with letters + numbers
.	dot separator for C flag
-	minus separator for C flag
_	underscore separator for C flag
O	outer frame (the default, it creates a frame suitable for drawing a circle outside the hex)
I	inner frame (it creates a frame suitable for drawing a circle inside the hex)

X uses a pattern for obtaining “easy to cut” hexagons (“trihexagonal” tiling)
 A the hexes are arranged in horizontal lines instead of vertical
 S the line (or the column if the A flag is specified) starts with a shifted hex
 M the 5th parameter is read as the diameter of the hex, instead of the side of the hex (the default)
 T the last row (or column) of shifted hexes is not drawn

With these flags, coordinates are added to each frame name:

L A, B, C, D...
 N 1, 2, 3, 4...
 P 01, 02, 03, 04...
 C 0101,0102,0103...0201,0202,0203...
 E A1,A2,A3...B1,B2,B3...
 C. 1.1,1.2,1.3...2.1,2.2,2.3...
 C- 1-1,1-2,1-3...2-1,2-2,2-3...
 C_ 1_1,1_2,1_3...2_1,2_2,2_3...

If you did not specify any flag, the frames are created with the same name.

You can use frames with wildcards (? for any one character, * for a group of any characters), can use the tilde (~) symbol as a flag for addressing a random frame, the exclamation mark (!) as a flag for deleting the frame after use and referencing the current frame with the degree (°) symbol (in an expression) or the current frame’s name with the micro (μ) symbol (in a text). For example, this script draws a circle on a random hex of the first column of a grid:

```
CARDSIZE = 18, 20
HEXGRID = 1, 0, 0, 18, 20, 1, , #000000, EMPTY, 0.1
[base] = FRAMEHEX(0, 0, 18, 20, 1, E)
ELLIPSE = 1, <~basea*>, #FF0000
```

FRAMEIMAGE

This function creates a list of frames (see page 39), taking only the frames from a source list that contain more than a percentage of a color (or a similar color) read over a reference image file. The syntax for this function is:

```
[name] = FRAMEIMAGE(frames, "image file", color, threshold, percentage)
```

If not specified, the threshold parameter is considered zero, otherwise it is the difference between the color specified as 3rd parameter and the colors read from the image; if not specified, the percentage parameter is considered 50. For example:

```
[list] = frameimage(frame*, "europe.png", #000000)
```

In this case, all the frames that start with “frame” are drawn over the “europe.png” file and are considered only those who are black over the 50% of their area.

FRAMELINE

With this function, you can define a group of frames, specifying a first frame, a last frame, and including all the frames in the shortest path between the two. It works with frames created from FRAMEBOX and FRAMEHEX functions. The syntax is:

```
[linegroup] = FRAMELINE(frame start, frame end)
```

For example:

```
CARDSIZE = 18, 20
HEXGRID = 1, 0, 0, 18, 20, 1, , #000000, EMPTY, 0.1
[base] = FRAMEHEX(0, 0, 18, 20, 1, E)
[linegroup] = FRAMELINE(basea1, baseh9)
POLYGON = 1, <linegroup>, 6, 90, #FF0000
```

FRAMELIST

With this function, you can define a group of frames, and use a single command on all of them. The syntax is:

```
[group] = FRAMELIST(frame1, frame2, ...frameN)
```

You can specify a single frame for parameter, or use another group of frames, or specify a range of frames using the syntax **frameX..frameY** (to add every frame with that name and numbered between X and Y). Before the name of the frame, you can use these flags:

- £ the frames are reversed on each line (from top to bottom, from right to left)
- \$ the frames are in bidirectional order (from left to right in the first row, from right to left in the next row, and so on...)
- % the frames are listed in vertical order (from left to right, from top to bottom)
- %£ the frames are reversed on each vertical line (from left to right, from bottom to top)
- \$\$ the frames are in bidirectional vertical order (from top to bottom in the first column, from bottom to top in the next column, and so on...)
- the order with the frames in a group are added is completely reversed (it can be added to each of the above combinations)

After the name of the frame, you can specify how many frames are skipped with the syntax **frame&N** where **N** is the number of the frames to skip.

For example, this script draws three circles on the first three hexes in the top-left corner of a grid:

```
CARDSIZE = 18, 20
HEXGRID = 1, 0, 0, 18, 20, 1, , #000000, EMPTY, 0.1
[base] = FRAMEHEX(0, 0, 18, 20, 1, E)
[group] = FRAMELIST(basea1, basea2, baseb1)
ELLIPSE = 1, <group>, #FF0000
```

FRAMEMAZE

This function reads a list of edge frames as 1st parameter (created with a FRAMEPER function), and creates another list of edge frames, arranged as a maze. The 2nd and 3rd parameters are the width and height of the rectangle defined by the edge frames. You can specify the coordinates of the starting cell (as 4th and 5th parameter), otherwise it is randomly selected (this also when set to zero); the ending cell is selected as the farthest from the starting one. The syntax is:

```
[newframe] = FRAMEMAZE(frames, width, height, X start cell, Y start cell, flags)
```

You can use these flags in the 6th parameter:

- S is created a group of frames for the solution
- M is created a group of frames with the sequence used in the creation of the maze
- E the exit is along the edge of the maze

At the end of the process other two frames are created, one for the starting cell (with postfix **start**) and one for the ending cell (with postfix **end**); if the **S** flag is used is created also a group of frames for the solution (with postfix **solution**), i.e. the path from the starting to the ending cell; if the **E** flag is specified is created also two frames for the edge of the starting cell (with postfix **startedge**) and for the ending cell (with postfix **endedge**); if the **M** flag is specified is created also a group of frames with the sequence used for creating the maze (with postfix **map**).

This example creates two cards, one with the maze, starting and ending cells, and one that adds the solution:

```
[x] = 20
[y] = 20
CARDSIZE = [x], [y]
[cell] = FRAMEBOX(0, 0, [x], [y], 1, 1)
[edge] = FRAMEPER(cell, 0.1)
[maze] = FRAMEMAZE(edge, [x], [y], 0, 0, S)
RECTANGLE = 2, <mazesolution>, #FFFF00
ELLIPSE = 1-2, <mazestart>, #FF0000
ELLIPSE = 1-2, <mazeend>, #00FF00
RECTANGLE = 1-2, <maze>, #0000FF
```

```
FONT = Arial, 10, T, #000000
TEXT = 2, {}, <mazesolution>
```

FRAMEMELD

With this function, you create a new frame, merging several others. The syntax is:

```
[newframe] = FRAMEMELD(frame1, frame2, ...frameN)
```

For example:

```
CARDSIZE = 18, 20
HEXGRID = 1, 0, 0, 18, 20, 1, , #000000, EMPTY, 0.1
[base] = FRAMEHEX(0, 0, 18, 20, 1, E)
[group] = FRAMEDISK(basef3, basef1)
POLYGON = 1, <group>, 6, 90, #FF0000
[meld] = FRAMEMELD(based1, baseh5)
ELLIPSE = 1, <meld>, #0000FF, EMPTY, 0.2
```

FRAMEMOSAIC

This function reads all the images in a folder, arrange them in a rectangle, and creates a new group of frames, one for each image. If the images fill more than one instance of that rectangle, you can use a **page** parameter to specify which rectangle is drawn from all the possible choices. The frames are created with a name composed from the **[name]** and a number, the number starts from "1". The syntax for this function is:

```
[newframe] = FRAMEMOSAIC("folder", pos x, pos y, width, height, page, flags, zoom)
```

Parameters:

"folder": a folder to search, eventually with a file pattern,

position x: horizontal position (in cm),

position y: vertical position (in cm),

width: width of the rectangle (in cm),

height: height of the rectangle (in cm),

page: if not specified, is equal to **1**,

flags: one or more of these flags:

H	the schema is mirrored horizontally
V	the schema is mirrored vertically
S	the images are read also in the subfolders

zoom: if not specified, is equal to **100**.

This function creates also a label named **namePAGES** (where **name** is the frames' prefix) with a value equal to the number of pages resulting.

FRAMENET

This function creates a new group of frames, composed with all possible couple from two groups of frames, eventually including only these contained with a range of distances. The syntax is:

```
[newframe] = FRAMENET(frame group 1, frame group 2, min distance, max distance, flags)
```

In the parameter *flags*, you can use one or more of these flags:

- L the frame(s) added is from the center of the starting frame to the center of the ending frame (it can be used for drawing lines), this is the default option,
- N the frame(s) added is the ending frame,
- 1 the frame(s) added are only from the 1st quadrant (top-right),
- 2 the frame(s) added are only from the 2nd quadrant (bottom-right),
- 3 the frame(s) added are only from the 3rd quadrant (bottom-left),
- 4 the frame(s) added are only from the 4th quadrant (top-left).

If you did not specify any of flags *1234*, the frames are taken from all the starting lists.

For example, this is a net from all the points in a rectangular grid, with a maximum distance of four units:

```
[net0] = FRAMEBOX(0, 0, 6, 9, 1, 1, L)
[net1] = FRAMENET(net0*, net0*, 0, 4)
LINERECT = 1, <net1>, #000000
```

Another example, this is a “star map”, connecting ten random “planets” in a hexagonal grid with a distance from two to four units:

```
[map0] = FRAMEHEX(0, 0, 6, 9, 0.1, L, 50%)
[map1] = FRAMELIST(10!~map0*)
[map2] = FRAMENET(map1, map1, 2, 4)
LINERECT = 1, <map2>, #000000
ELLIPSE = 1, <map1>, #0000FF
```

FRAMEPATH

With this function, you can define a group of frames, specifying a first frame, a last frame, and including all the frames in the shortest path between the two, and optionally remove a list of frames (specified in the 4th parameter) from the result. It works with frames created from FRAMEBOX. The syntax is:

```
[pathgroup] = FRAMEPATH(frame start, frame end, flags, exclusions)
```

In the parameter *flags*, you can use one or more of these flags:

- F add **frame1** to the result group
- L add **frame2** to the result group
- D delete the frames used for the path
- S delete the frame used as 1st parameter (start frame)
- E delete the frame used as 2nd parameter (end frame)
- T use the shortest path

For example:

```
[grid] = FRAMEBOX(0, 0, 6, 9, 0.5, 0.5, C)
[path1] = FRAMEPATH(grid0203, grid1116, D)
[path2] = FRAMEPATH(grid0203, grid1116, D)
[path3] = FRAMEPATH(grid0203, grid1116, D)
RECTANGLE = 1, <grid*>, #0000FF, #FF0000, 0.1
ELLIPSE = 1, <path1>, #AAAAAA, #00FF00, 0.05
ELLIPSE = 1, <path2>, #AAAAAA, #0000FF, 0.05
ELLIPSE = 1, <path3>, #AAAAAA, #FF0000, 0.05
```

FRAMEPER

This function creates a new group of frames, adding for each starting frame the four frames from its sides (the starting frame is considered rectangular). The syntax is:

```
[newframe] = FRAMEPER(frame group, width, flags, margin)
```

The **width** parameter specifies the width of the left and right frames, and the height of top and bottom frames. In the parameter *flags*, you can use one or more of these flags:

- 1 a frame for the top side of the rectangular frame is added to the result,
- 2 a frame for the right side of the rectangular frame is added to the result,
- 3 a frame for the bottom side of the rectangular frame is added to the result,
- 4 a frame for the left side of the rectangular frame is added to the result,
- V with this flag the frames are created in vertical order (instead of a horizontal order),
- N with this flag the frames are created with individual names: *nameN* (top), *nameE* (right), *nameS* (bottom), *nameW* (left).

If you did not specify any of flags **1234**, all the four frames are added. The margin parameter specifies how much space is added to the left and to the right (for horizontal sides) and to the top and to the bottom (for vertical sides) of the frame.

FRAMERECT

With this function, you can define a group of frames, specifying two frames, and including all the frames in the rectangle drawn used the first frame as top-left and the latter as bottom-right. It works with frames created from FRAMEBOX and FRAMEHEX functions. The syntax is:

```
[rectgroup] = FRAMERECT(frame start, frame end)
```

For example:

```
CARDSIZE = 18, 20  
HEXGRID = 1, 0, 0, 18, 20, 1, , #000000, EMPTY, 0.1  
[base] = FRAMEHEX(0, 0, 18, 20, 1, E)  
[rectgroup] = FRAMERECT(baseb3, basei6)  
POLYGON = 1, <rectgroup>, 6, 90, #FF0000
```

FRAMESUB

With this function, you can define a new frame from another frame (1st parameter), removing items from a third frame (2nd parameter). The syntax is:

```
[group] = FRAMESUB(frame1, frame2)
```

For example, this script uses two square group of frames for creating a third hollow group of frames (subtracting the second from the first):

```
[grp_a] = FRAMEBOX(0, 0, 6, 6, 1, 1, C)  
[grp_b] = FRAMEBOX(1, 1, 4, 4, 1, 1, C)  
[grp_c] = FRAMESUB(grp_a*, grp_b*)  
ELLIPSE = 1, <grp_c*>, #00FF00
```

FRAMETRANS

This function creates a new group of frames, taking all the frames from a group, and applying to them a horizontal and a vertical offset, and optionally a change in width and height. The syntax is:

```
[newframe] = FRAMETRANS(frame group, x offset, y offset, width change, height change)
```

For example, this line takes all frames from group **test**, and creates a group **test_trans** shifted right of 0.5:

```
[test_trans] = FRAMETRANS(test, 0.5, 0)
```

FRAMETRI

With this function, you can define a group of frames, specifying three frames, and including all the frames in the triangle drawn used the frames as vertexes. It works with frames created from FRAMEBOX and FRAMEHEX functions. The syntax is:

```
[trianglegroup] = FRAMETRI(frame1, frame2, frame3, flags)
```

You can use these flags in the 4th parameter:

O = does not include the outer frames

I = does not include the inner frames

For example:

```
CARDSIZE = 18, 20  
HEXGRID = 1, 0, 0, 18, 20, 1, , #000000, EMPTY, 0.1  
[base] = FRAMEHEX(0, 0, 18, 20, 1, E)  
[trianglegroup] = FRAMETRI(baseb3, basei6, basec10)  
POLYGON = 1, <trianglegroup>, 6, 90, #FF0000
```

Expressions

Expressions may be used to calculate numeric parameters or numbers in TEXT parameters, these delimited with “{” and “}”. You can use numbers (integer and decimal separated with a dot “.”), parenthesis and these operators:

+	addition
-	subtraction
*	multiplication
/	division
^	exponentiation
#	modulus
£	integer division

For changing the order of operations, you can use “(, “)”, “{” and “}”, these are treated like the same. You cannot use “[” and “]” (used for labels).

For example, these are valid expressions:

```
RECTANGLE = 1, 0, 0, (1+2)*2, (1+2)^2, #FF0000
TEXT = 1, "Result {(2+2)^2}", 0, 0, 6, 9, center
```

This is a special variable: the paragraph character (§) gives you the current card number; for example, that script creates ten cards, each with a number from 1 to 10:

```
FONT = Arial, 32, , #000000
TEXT = 1-10, "{§}", 0, 0, 6, 9, center
```

That script creates ten cards, each with a random number from 1 to 100:

```
FONT = Arial, 32, , #000000
TEXT = 1-10, "{1d100}", 0, 0, 6, 9, center
```

Counters are variables, that can be used in expressions; there are two kinds of counter, these are used for integer values:

```
A B C D E F G H I J
```

And these are used for floating-point values:

```
AA BB CC DD EE FF GG HH II JJ
```

A counter can be initialized with COUNTER directive:

```
COUNTER = 1, A, 1
```

and later re-used in an expression:

```
RECTANGLE = 1, 0, 0, A, A, #00FF00
```

A counter can be auto incremented with a pre- and/or a post- number. If A has a value of 10, this command:

```
TEXT = 1, "{1A2}", 0, 0, 3, 3, center
```

will give an output of 11, and A will have a value of 13 after that line.

The counter D is a special case, it has been changed for default into a dice (see DICE keyword, page 92), to give a random value, the syntax is *ndf*, where *n* is the number of dice, each with *f* faces. If not specified, *n* is set to one, and *f* is set to six.

These are special symbols:

Z Format
X Repeat

The “Z” symbol may be used when you need to format a decimal value with a fixed number of digits. The syntax is *valueZmask*, where the mask is a sequence characters for the integer part, a dot (“.”) and a sequence characters for the decimal part. The characters that can be used for the mask are:

0 a digit taken from the number, if there is not a digit in that position, a zero (“0”) is written instead.
a digit taken from the number, if there is not a digit in that position, a space (“ ”) is written instead.

For example:

```
FONT = Arial, 32, , #000000  
TEXT = 1, "{4/3Z00.00}", 0, 0, 6, 9, center, center
```

The result will be a “01.33” printed on the card.

The syntax for the “X” symbol is *textXnumber* and duplicates the *text* for several times. For example:

```
FONT = Arial, 32, , #000000  
TEXT = 1-5, "{*X$}", 0, 0, 6, 9, center, center
```

Will output an asterisk on the 1st card, two asterisks on the 2nd card, three on the 3rd and so on.

Comments

Comments can be inserted in scripts, marking them with a character on the start of the line. The character can be an apostrophe (') or a semicolon (;) or a custom character selected from the “Config” window.

Example:

```
CARDS = 52  
'This is a standard deck
```

From the “Config” window you can also check the “Use in-line comments marked by ...” option, and after that you can use a syntax like that:

```
CARDS = 52 `` This is a standard deck
```

If you use a custom character and open your script on another computer (with a different configuration) your comments will not be evaluated as such. To avoid this problem, you must include a COMMENT directive at the start of your script (see page 88).

You can apply or remove the current comment's character in a block of selected text with two buttons on the right side of the main window: “+Com” for apply comments and “-Com” for removing comments.

Script lists

If you must work on multiple scripts, you can create a list for manipulating them. You can activate this option clicking on the button “Script list”:

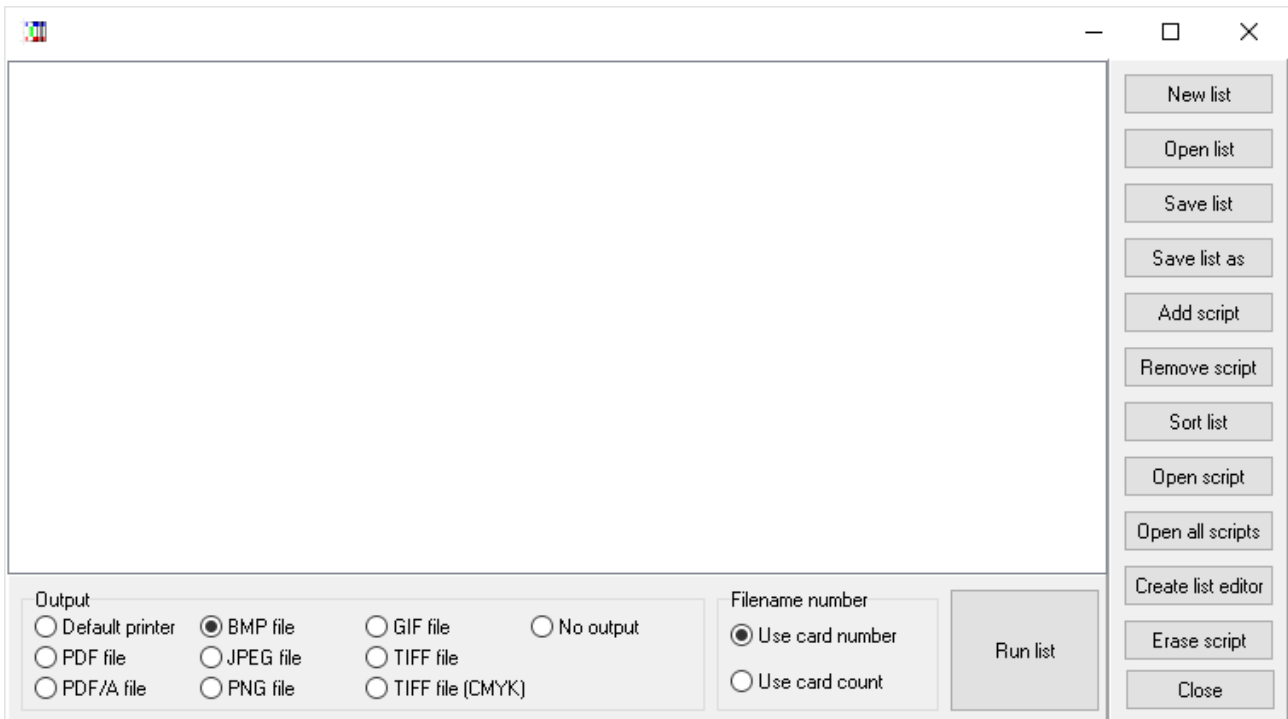

With the buttons on the right side, you can create a new list, open an old list, save the current list (with the current name or specifying another), add another script to the list, remove a script and sort the list. You can also open the selected script, or open all of them (in multiple tabs), create a list from all the current scripts and erase the selected script.

With the button “Run list” you can launch a “Validate and build” task on all the scripts listed in this window, choosing the output for them with the “Output” box: you can print the result, create PDF, and save the images in bmp, jpg, png or tiff format (the latter with standard and CMYK color space). With the “Filename number” box you can choose if the filename must be chosen from card number or card count: it can be different if you use a PRINT directive (see page 147) in your scripts.

Create PDF

The button “**PDF**” in the main window opens this form:

Save deck as a PDF file

PDF filename: test.pdf

PDF author:

PDF/A

Use JPEG Compression for images

Use scaled images

PDF compression level

None

Low

Default

Max

Save a copy with a CMYK colorspace

Gswin32c.exe:

ICC profile:

None

With this form, you can specify a filename and an author for the PDF file.

PDF/A: with this option, the PDF file is saved in this format.

Use JPEG Compression form images: with this option enabled all the images in the PDF file are internally stored in JPEG format.

Use scaled images: with this option enabled, the program uses a high image compression for the PDF file, reducing its size (and its quality).

PDF compression level: you can choose between four standard compression level for the images (None, Low, Default and Max).

Save a copy with a CMYK color space: if you have installed Ghostscript (<http://www.ghostscript.com>) you can also save it with CMYK color space (instead of RGB), specifying the path for the executable (Gswin32c.exe), and use an ICC color profile.

Save images

The button “MT” in the main window opens this form:

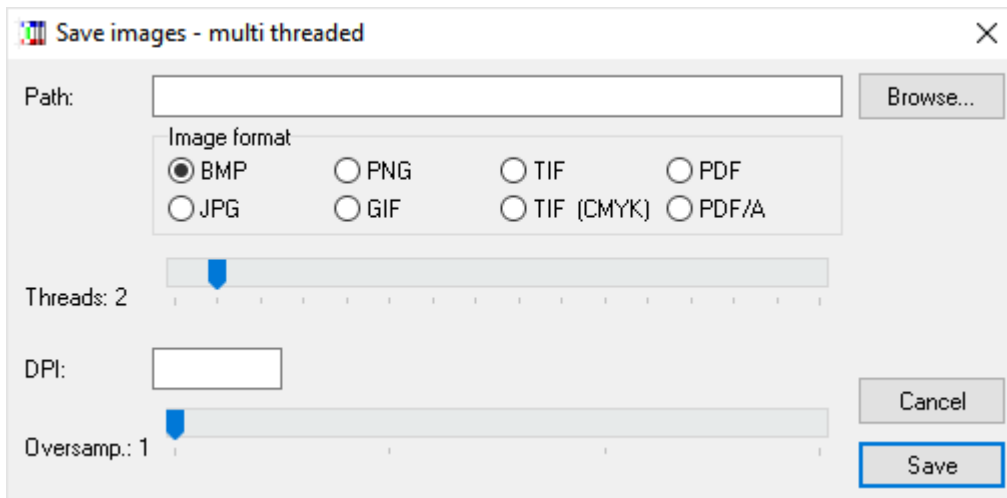

The dialog box titled "Save images - multi threaded" contains the following elements:

- Path:** A text input field with a "Browse..." button to its right.
- Image format:** A group box containing eight radio button options: BMP, PNG, TIF, PDF, JPG, GIF, TIF (CMYK), and PDF/A.
- Threads:** A slider control with the label "Threads: 2" and a blue marker at the second position.
- DPI:** A text input field.
- Oversamp.:** A slider control with the label "Oversamp.: 1" and a blue marker at the first position.
- Buttons:** "Cancel" and "Save" buttons are located at the bottom right. The "Save" button is highlighted with a blue border.

With this form, you can specify a path for saving the cards' images, the file format, the number of threads to be used, the DPI (see page 94) and oversampling (see page 142) values.

Note: every thread uses a separate memory pool, thus it is possible to use more than 4GBytes of memory.

Convert a PDF to images

The button “CP” in the main window opens this form:

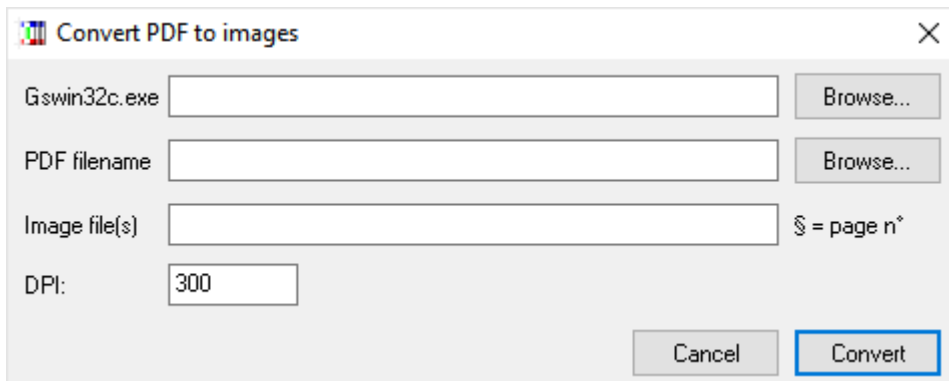

The screenshot shows a dialog box titled "Convert PDF to images" with a close button (X) in the top right corner. It contains four input fields and two buttons:

- The first field is labeled "Gswin32c.exe" and has a "Browse..." button to its right.
- The second field is labeled "PDF filename" and has a "Browse..." button to its right.
- The third field is labeled "Image file(s)" and has a "\$ = page n*" label to its right.
- The fourth field is labeled "DPI:" and contains the value "300".

At the bottom right of the dialog box, there are two buttons: "Cancel" and "Convert". The "Convert" button is highlighted with a blue border.

If you have installed Ghostscript (<http://www.ghostscript.com>) you can convert PDF files into images. The first field is for the Ghostscript executable; the second is the name of the PDF file, the third is for the resulting images (you can use the \$ character for the page number); the fourth field is for the DPI resolution of the final images.

Command-line parameters

You can run nanDECK from the command line (if you want to execute a script in a batch, for example). The syntax is:

```
nanDECK <script file> <1st action> <2nd action> ... <nth action>
```

The *action* parameter can be one or more of the following:

```
/createbmp
/createjpg
/createpng      the program creates all the cards and saves them in bmp/jpg/png/gif/tif formats (also with CMYK
/creategif      color space), one file for each card
/createtif
/createtifcmyk

/creategifa
/createpdf      the program creates all the cards and saves them in one single file in animated-gif or pdf format
/createpdfa

/print          the program creates all the cards and prints them with the default printer

/exec          the program runs the script (useful when using SAVE directive)

/range=        the program creates only a range of the card, with the syntax start-end (for example /range=1-10)
/output=       this is the path for the resulting files
/dpi=         you can specify a different DPI value (the value in the script is not used)
/oversample=  you can specify an oversample value (the value in the script is not used)
/name=        the program uses a label for the name of the card when saved as individual images
/[label]=value the program adds a label with that name and that value
```

For example, to save all images obtained with script “c:\my scripts\test01.txt” in png files, you can write:

```
nanDECK "c:\my scripts\test01.txt" /createpng
```

To create a pdf with all the cards, you can write:

```
nanDECK "c:\my scripts\test01.txt" /createpdf
```

The images are created in the same folder for the script, and for multiple images, a number will be added to the end of the filename. In the 1st example, the images will be named:

```
c:\my scripts\test01_01.png
c:\my scripts\test01_02.png
c:\my scripts\test01_03.png
...
```

In the 2nd example, the file will be named:

```
c:\my scripts\test01.pdf
```

If you leave the *action* parameter empty, the program will only load the script specified in the 2nd parameter.

Optional parameters are in *italic* (like *Thickness* in the above form). A hint for the syntax is show in the bottom of the form, with the “**Confirm**”, “**Help**” (it points to the RECTANGLE help page) and “**Cancel**” buttons. For some parameters, there are buttons for inserting specific values (like colors and gradients). For position and size there is a specific form (“**Pick rect.**” Button, in the above form):

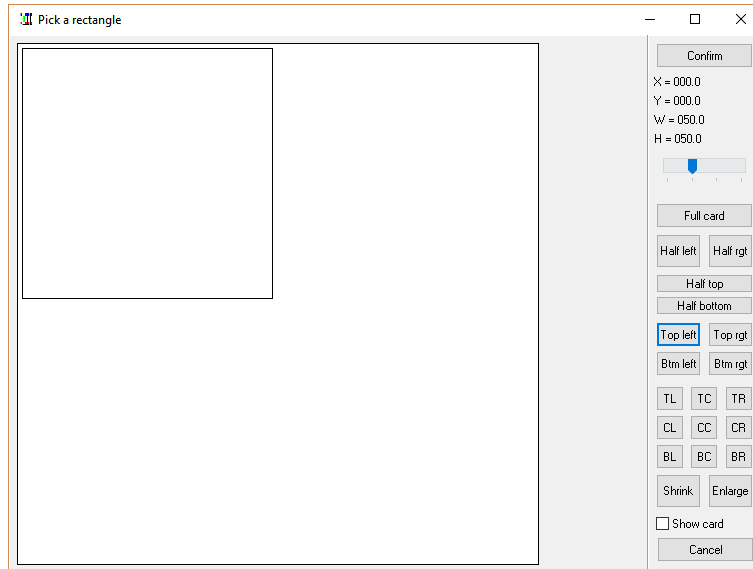

The rectangle can be moved and resized, dragging it with the mouse; you can use the rightmost buttons to change the rectangle size or position into some standard values.

Tip: you can go directly to this form, pressing the key F3 (or clicking the “Visual edit” button) where you are on a line with a graphic directive.

In the wizard form, if you double click in a field, you can choose a label name from a list (you can see also the label’s value):

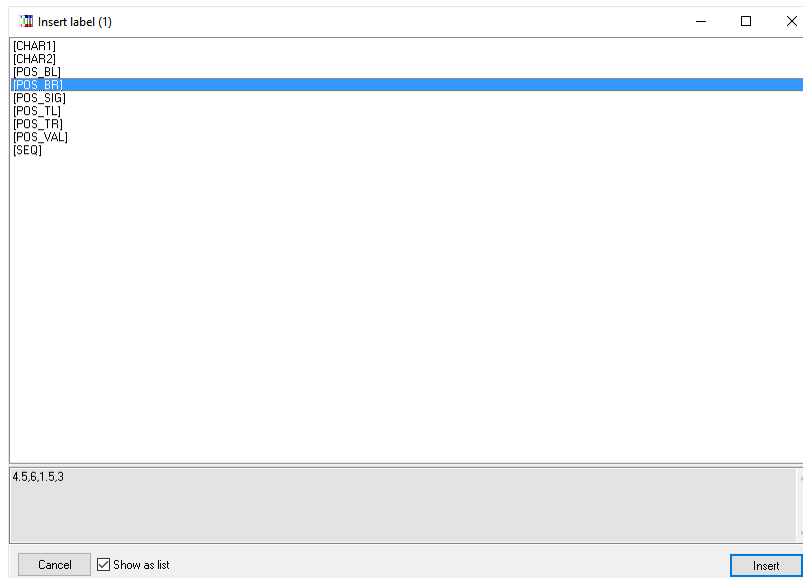

Tip: in every field, you can use the mouse wheel to increase / decrease a numeric value.

Linked data editor

If you use a LINK directive (see page 131) to use a CSV data file, you can edit directly this file using the “Linked data” button. If you click on it, the program shows you a list of linked files. If you choose one of this, a window opens itself, showing you a table with the file content. For example:

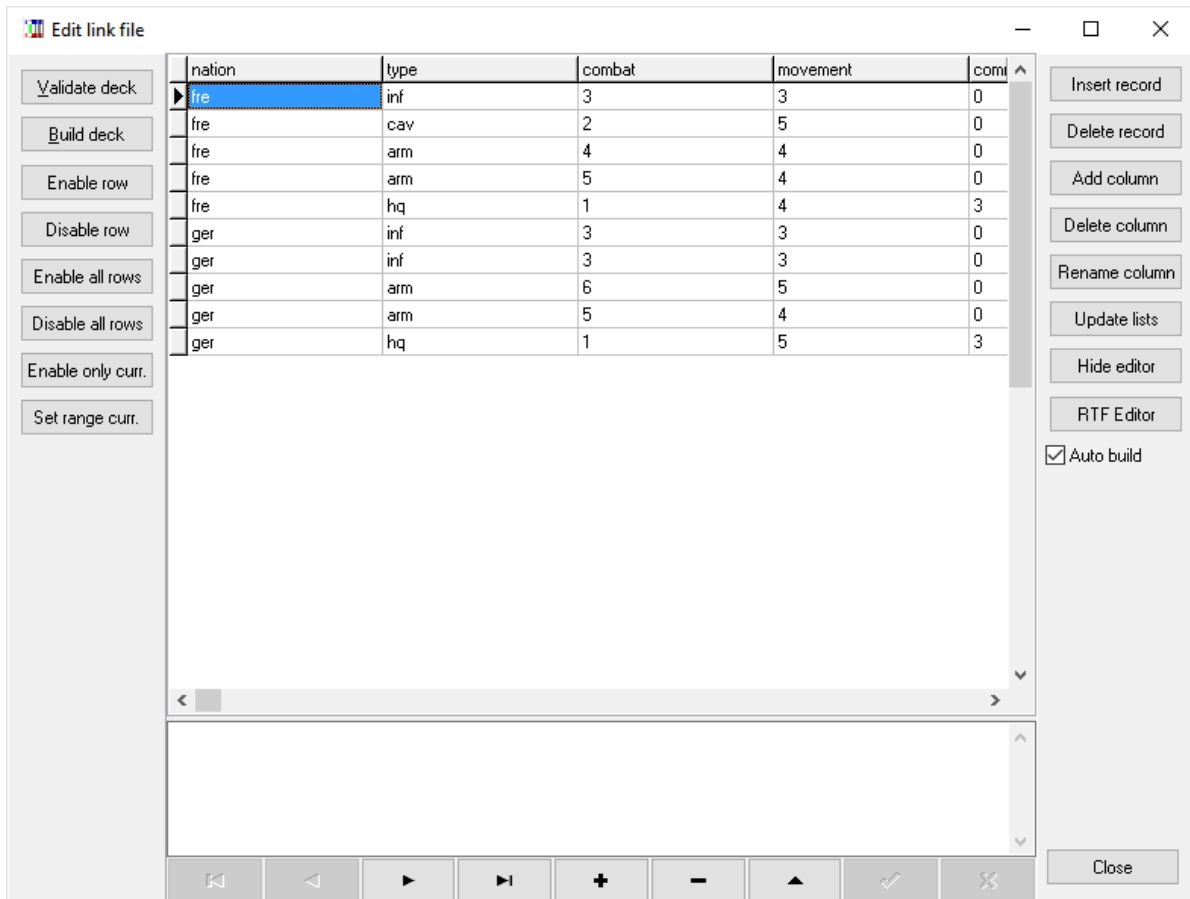

You can modify directly a cell clicking on it (there is a larger edit box on the bottom of the window), you can also change the table' sorting with a click on the column (one click sets an ascending order, another click sets a descending order, it doesn't work for larger fields). With the buttons on the right, you can do some tasks, like insert or delete a record, add, delete, or rename a column (a field), update the lists of data (in the drop-down menu in each field), hide or show the editor, open an external RTF editor (for the current field), or close the window.

The two buttons “Validate deck” and “Build deck” on the left are replicated from the main window. With the other buttons on the left you enable or disable the current row (putting a ‘ in front of it) or enable or disable all the rows. You can also enable only the current row or setting the range for the deck building. With the buttons on the lower side of the window (under the edit box) you can move the current record (first, previous, next, and last), add (+), delete (-), edit (the triangle), confirm (the check sign) or discard (X) the changes in a record.

All the change made in this window to the linked file will be saved if you save the main script file.

Tip: you can instantly build a single card with a double click on one row of data.

Tip: you can instantly open the external RTF editor with a double click on the lower editor.

Tip: you can select the external RTF in the “Config” button from the main window.

Virtual table

The “Virtual table” option is a desktop in which you can put the result of card rendering, you can use it for saving images for a manual or play test the drawing of cards from a deck. Without modifying your script, you can view the Virtual table clicking on the button “Table” after building a deck. Then you can see a window with your deck in the center of the screen, and you can use these commands:

Mouse commands on decks

click	select deck
double click	draws a card face up
shift double click	draws a card face down
right click	rotate deck 90°
resize	resize deck image
shift resize	resize deck image without keeping size ratio
ctrl resize	resize deck image from the center

Mouse commands on cards

click	select card
double click	turn card face down/face up
right click	rotate card 90°
resize	resize card image
shift resize	resize card image without keeping size ratio
ctrl resize	resize card image from the center

ctrl click	pick all the cards and the decks under the cursor and create a new deck
mouse wheel	zoom table

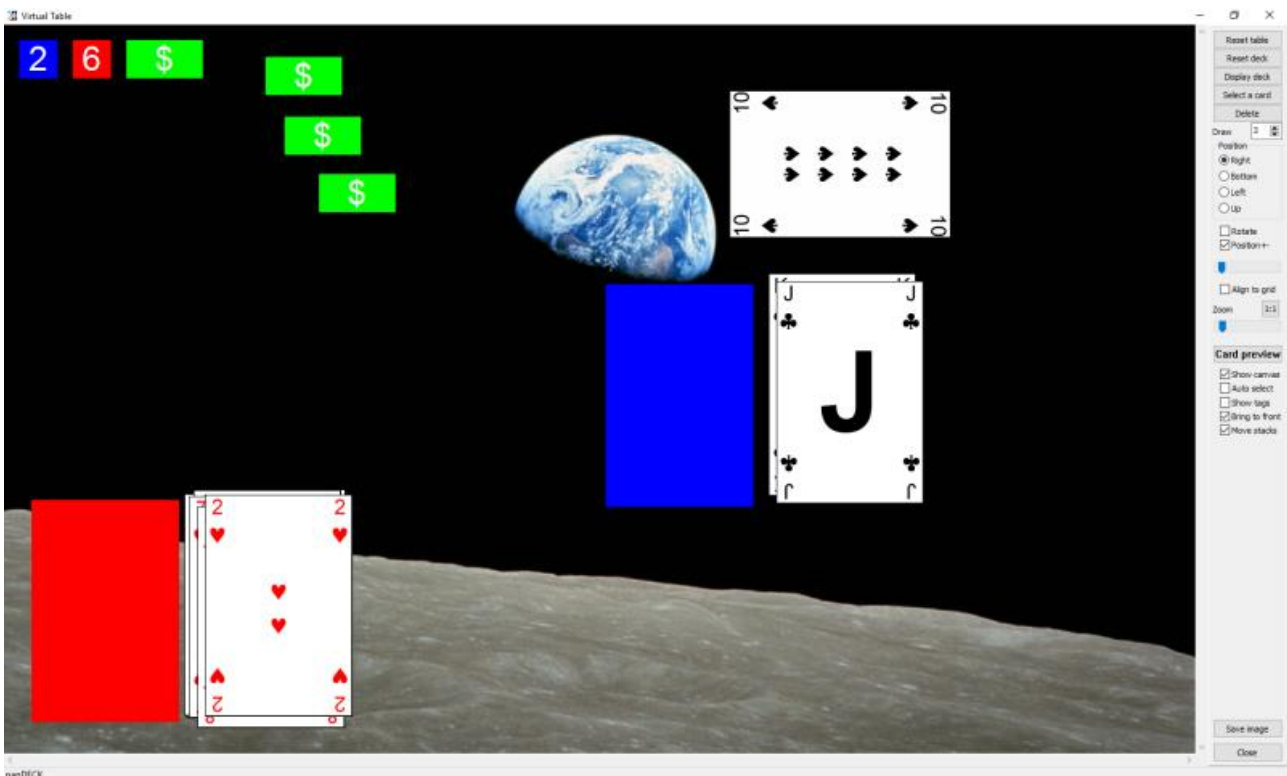

In the bottom line of the window, you can read the number of cards in the selected deck. On the right panel, you have these controls:

Reset table	this button reset to the initial state all the decks and the elements on the table
Reset deck	this button reset to the initial state the selected deck
Display deck	this button draws all cards in the deck, and position them left to right, top to bottom in the table

Select a card	this button lets you to select a single card from a deck
Delete	this button deletes the selected object (deck, card, or token)
Draw (number)	the number of cards specified is drawn each time you double click on a deck
Position	the card drawn from the deck is placed to this position, relative to its deck
Rotate	after a card is draw, the position is moved to the next
Position +/-	the card drawn is placed in a slightly random direction
Position slider	the amount of the offset of the position when the last option is enabled
Align to Grid	the card drawn is placed in a grid of the same size of the card
Zoom slider	this slider enlarges or reduce the table size
1:1 button	this button reset the zoom
Card preview	this button show the current card, enlarged
Show canvas	the canvas is shown as a background image
Auto select	the elements of the table are selected automatically when the mouse pass over them
Show tags	the tags (see page 160) are shown in the four quadrants of the table
Bring to front	an object clicked is pushed to the front, before all the other objects
Move stacks	when you move a card, all the other cards on top of it are also moved
Save image	the table is saved as a bmp file
Close	you close this window

This is the window that the program shows you to select a single card from a deck:

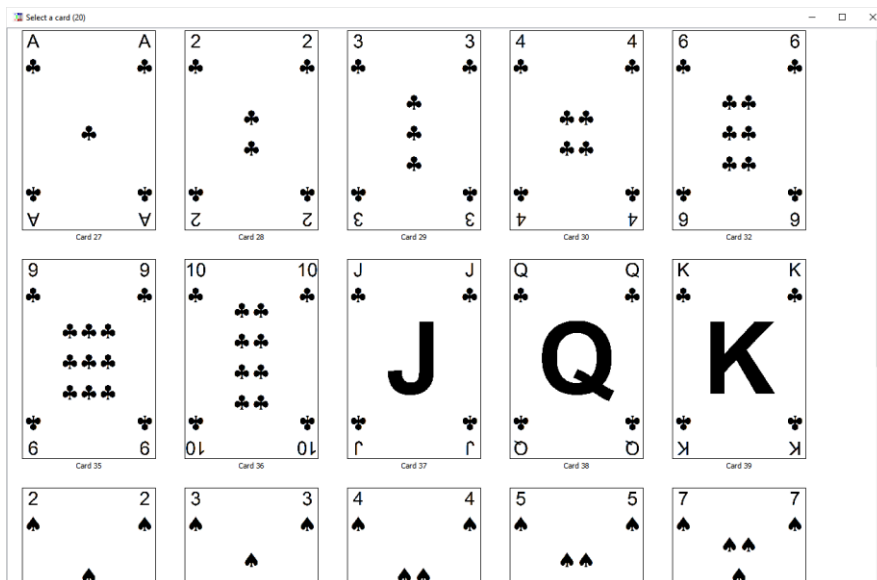

There are two directives that you can use in your script to customize the Virtual table: the DECK directive splits the cards in more than one deck, and the TOKEN directive creates some elements to be used on the table, with a fixed text or a randomized value, in the latter case you can “roll” the token with a double click on it.

Example:

```
...
DECK = "1-26", "Red", #FF0000, 30%
DECK = "27-52", "Black", #0000FF, 30%
TOKEN = "{1d6}", 50, 50, #FFFFFF, #0000FF, 1
TOKEN = "{1d6}", 50, 50, #FFFFFF, #FF0000, 1
TOKEN = "$", 100, 50, #FFFFFF, #00FF00, 10
```

Both in DECK and TOKEN directives you can specify a list of frames for deck/token starting position, another list of frames for the positions in which they can be moved, and a list of rules to be enforced; in this case, you can specify one or more keywords from this list:

MAX1->BLOCK if the item is moved in a frame already occupied, the moving is blocked,
MAX1->PUSHF if the item is moved in a frame already occupied, the occupying item is moved in the next frame in the list.

Visual editor

You can open the Visual Editor with a click on the “Visual editor” button, or pressing F4 on the keyboard, or by a middle button (or wheel) click on the mouse, this is the main form:

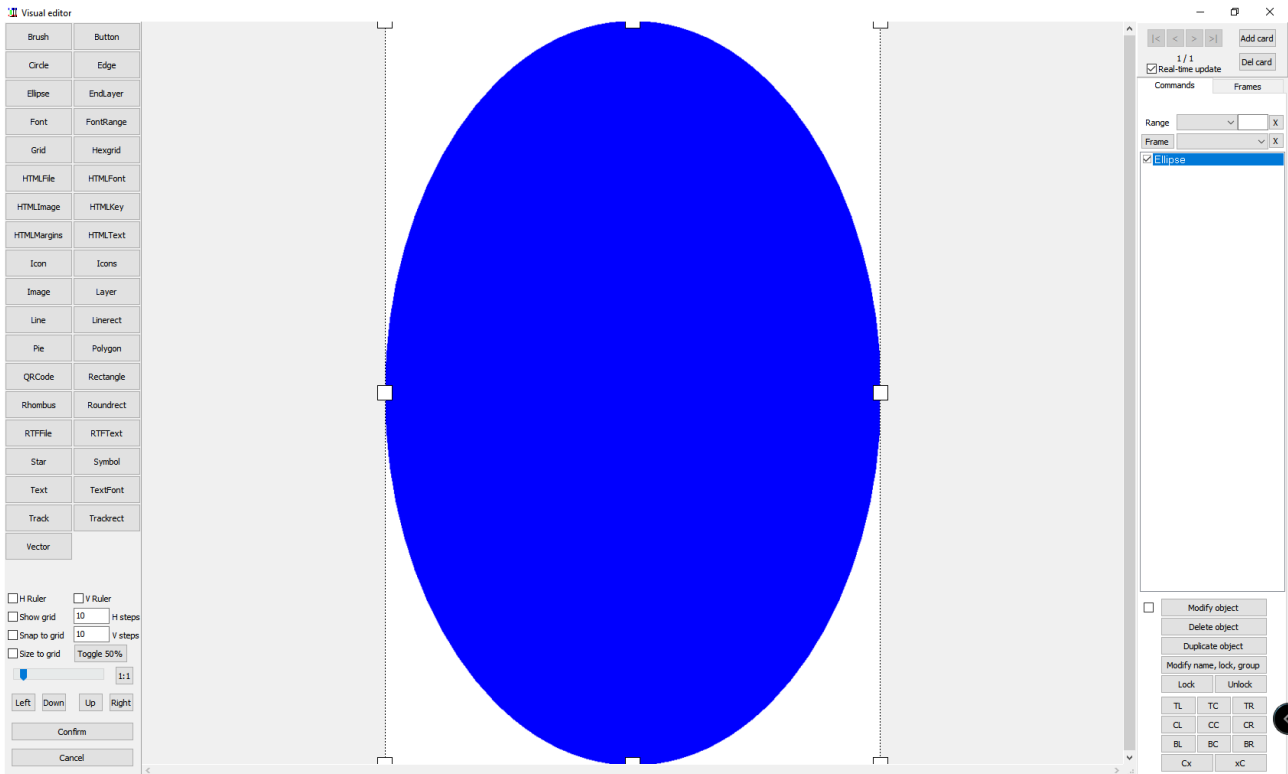

The visual directives are a subset of the standard ones, and are loaded from a section of the source delimited with VISUAL / ENDDIRECTIVE directives, for example:

```
VISUAL
ELLIPSE = 1, 0, 0, 100%, 100%, #0000FF
ENDDIRECTIVE
```

With this script, when you press the “Visual Editor” button, the program loads the lines between VISUAL / ENDDIRECTIVE in the visual GUI, and you can modify them, or add new directives (with the toolbox on the left of the window).

When you press the “Confirm” button, all the objects are inserted in the source, between VISUAL / ENDDIRECTIVE, so there is a two-way interaction between source and GUI (but only in a section of the source). Non-visual directives are not allowed in this section (the program gives an error in the validation step).

If the VISUAL / ENDDIRECTIVE section is not present, the program shows you an empty GUI (but you can add new objects) and when you return to the source, a visual section is added to the end of it.

You can see at the right of the GUI window a list of directives, that will go to the source if confirmed, that are layered from the top (first, to the rear) to the bottom (last, to the front). They can be drag and dropped across the list to change their layer position (the result is shown immediately in the main panel).

At the top right of the window there are some buttons to navigate through the deck (and add or delete cards), a checkbox to enable/disable the real-time update of the current object when you change its parameters (with F2), a combo box for choosing a label / sequence to be inserted in directives like TEXT or IMAGE and another combo box for choosing a sequence to be used with a LABELRANGE function to choose a range (the object is shown only when the item of the sequence is equal to “1”).

The last combo box is when you want to link the object to a frame (only frames defined within VISUAL / ENDDIRECTIVE section are shown); these frames are shown by clicking on the “Frames” tab (all other objects are locked); in this tab, you can also enable only a group of frames: to define a group you can create frames with a

group/name syntax (for example: **group1/frame1**, **group1/frame2**, etc.). If you enable the option “Change objects’ frames”, when you choose a group, the program will move all the objects that has frames with compatible names to the new frames.

In the bottom left of the windows there are the controls for showing h/v rulers, a grid (with the number of horizontal and vertical steps) and snap/size to the grid, a slider for zooming in and out the card, a button “Toggle 50%” to toggle on/off 50% transparency to the current object (useful to see what lies beneath), and a button “**1:1**” for restoring a 100% zoom and four buttons to move the selected object in the four directions (these buttons are linked to the arrows keys on the keyboard).

In the bottom right there are nine buttons, to move the selected element to these positions. If you use the right mouse, the element instead of being moved is resized (for example, the CC button resize it to the whole card). The last two buttons, “Cx” and “xC” centers the element vertically and horizontally, respectively.

Mouse controls:

- right click (on the object and the command in the list): modify the parameters utilized for rendering the object,
- double click (on the command in the list): modify properties of an object (comment, lock, group, snap to grid, and size to grid),
- use mouse wheel for zooming the card’s image,
- use CTRL + mouse wheel to move between cards.

Shortcuts:

F2	modify current element,
Del	delete current element,
CTRL+D	duplicate the current object,
CTRL+L	lock the position of the current object,
CTRL+U	unlock the position of the current object,
CTRL+H	toggle 50% transparency on/off,
LEFT	move the current object one pixel to the left,
DOWN	move the current object down one pixel,
UP	move the current object up one pixel,
RIGHT	move the current object one pixel to the right.

Configuration

The “Config” button on the main window brings you to the configuration window:

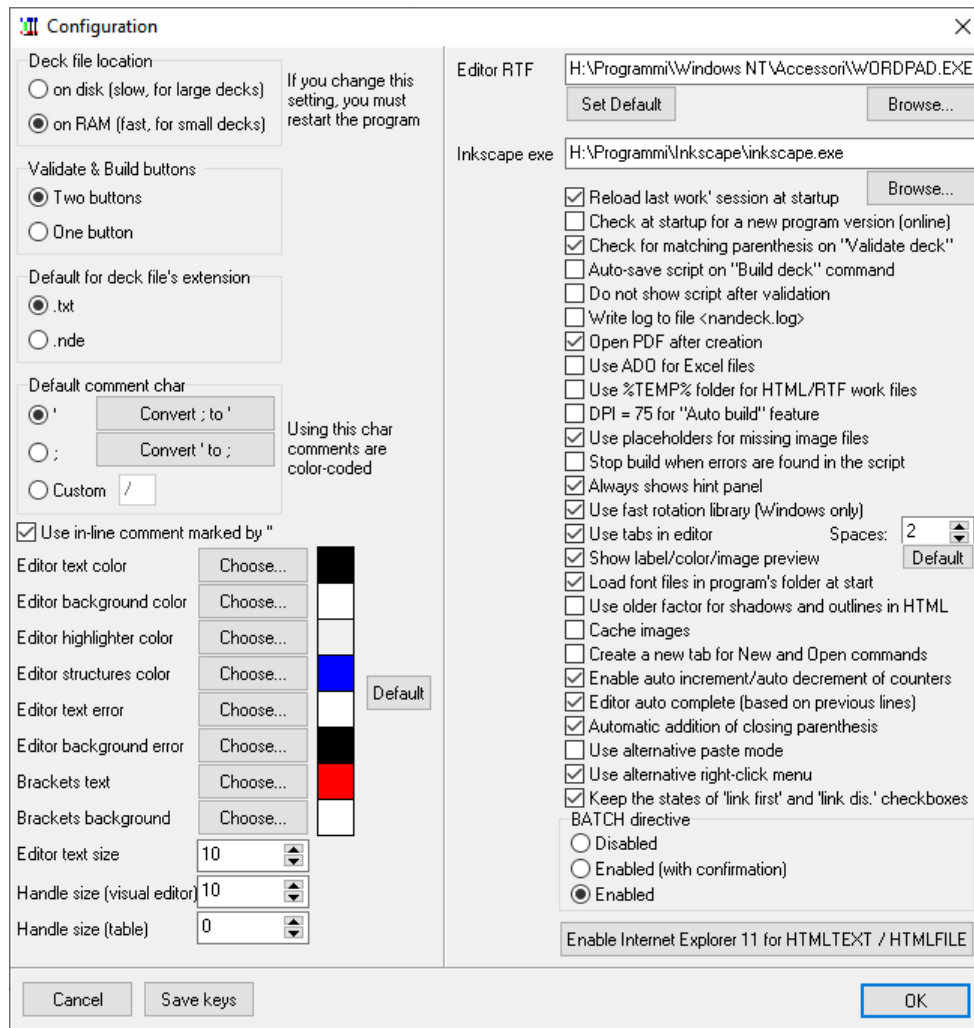

Deck file location: the program can run in two modes, the default “on RAM” setting uses RAM for the card rendering, it is fast, but if you have many high-resolution cards, it can slow down the whole computer (when the RAM is full). Instead, the “on disk” setting is slower, but it can render many high-resolution cards without slowing down your PC. The same is true if you have exceptionally large decks (thousands of cards).

Validate & Build buttons: usually “Validate” and “Build” are two distinct buttons in the main window. With this option, you can have one single button “Validate & Build”; if you click it, the script will be first validated, and if valid, the deck will be built next.

Default for deck file’s extension: with this option, you can choose the default extension between “.txt” and “.nde” (and assigning these files to the nanDECK program and open them with a double click).

Default comment char: with this option, you can choose the character used for commenting lines, and changing all of them from one to another, you can also use a custom character (instead of the default ‘ and ;)).

Use in-line comment marked by ;;: if you enable this option, you can use a double comment char for inserting comments on the same line used for commands. For example (with the default “;” comment char):

```
CARDSIZE = 6, 9 ;; default card size
```

Editor text color, Editor background color, Editor highlighter color, Editor structures color, Editor text error, Editor background error, Brackets text, Brackets background: with these buttons, you can change the default

colors for the editor text, background, highlighted line, lines that contain special directives, text and background for lines that contain errors and brackets (and re-setting them to the default values by pressing the **Default** button).

Editor text size: this number sets the size of the font for the editor's character (the default is 10).

Precision visual → script: this is the number of digits for fractional values that the software uses when an object in visual editor is converted to a script line.

Handle size (visual editor): this is the size (in pixels) of the eight white squares that you can use to resize an object in the visual editor.

Handle size (table): this is the size (in pixels) of the eight white squares that you can use to resize an object in the virtual table.

Editor RTF: this is the path to the executable file called when you want to edit a field text in a linked file with an external RTF editor. You can also choose the default executable linked with an ".rtf" file extension.

Inkscape exe: this is the path to the executable file for Inkscape, used with the VECTOR directive (see page 167) when you want to use it for the rendering, instead of the internal engine (the default, less accurate).

Reload last work' session at startup: with this option enabled, at the start the program loads the file(s) opened in the last session.

Check at startup for a new program version (online): with this option enabled, at the start the program checks online if a new release is available for the download and warns you in the window's title.

Check for matching parenthesis on "Validate deck": with this option enabled, the program checks if the parenthesis match in all your script.

Auto-save script on "Build deck" command: with this option enabled, the program always saves the script when you click on the "Build deck" button.

Do not show script after validation: usually the program, after the validation procedure, writes the script in the lower box in the main window. With this option enabled, the script is not written (speeding up the validation process).

Write log to file <nandeck.log>: with this option enable, you can save the program log (all the text shown in the lower box in the main window) in a text file.

Open PDF after creation: with this option enabled, after a PDF is created, the program opens it, using the default application associated with ".pdf" extension.

Use ADO for Excel files: with this option for loading files from Excel is used an ADO library, is slower than the internal method, but you can open files that are concurrently open in Excel.

Use %TEMP% folder for RTF/HTML work files: these directives create a temporary file, if you enable this option that file will be create in the temporary folder, if you disable this option, it will be created in the current folder. Note that if you have projects in folder linked to a cloud service (like Dropbox™) you should enable this option.

DPI = 75 for "Auto build" feature: if you have enabled the "Auto build" option, if this option is enabled, the preview is done at a lower resolution (useful for slow PC).

Use placeholders for missing image files: if you specify file images that does not exists, the program creates them (a random color bitmap with the name of the file repeated on it) and shows you in a window the list of the missing files.

Stop build when errors are found in the script: with this option enabled, the validate procedure is stopped when an error is found in the editor, if it is disabled, the line with errors are highlighted and the validation is completed.

Always shows hint panel: with this option enabled the bottom panel with the keyword's help is shown always, and not only when a keyword is present in the current editor line.

Use fast rotation library (Windows only): use an alternative rotation library that uses routines available only on Windows (when the program is executed for the first time on Wine, this option is unchecked).

Use tabs in editor: if you enable this option, each tab key is converted to the specified number of spaces.

Show label/color/image preview: with this option enabled, when the caret is on a label, its content (text, color, or image) is shown in the lower part of the main window (the Default button resets the standard widths of these resizable panels).

Load font files in program's folder at start: if this option is enabled, nanDECK, when it is started, loads all the font files that are found in the same folder with its executable.

Use older factor for shadows and outlines in HTML: when they were first implemented, shadows and outlines with HTMLFONT use a value for size that was not correct; now it is fixed, but if you want to use the older routines, check this option.

Cache images: with this option enabled, all the files loaded with an IMAGE directive are stored in RAM, for a faster reload; if you need more RAM for your deck, uncheck this option.

Create a new tab for New and Open commands: if this option is enabled, when you create a new script or load an existing one, a new editor tab is created, instead of executing that command in the existing editor tab.

Enable auto-increment/auto-decrement of counters: with this option enabled, you can use numbers before or after counters to add/subtract a number from them (if before, the number is added/subtracted before using the counter, if after, the addition/subtraction occurs after having used the counter).

Editor auto complete (based on previous lines): if this option is enabled, when you digit some characters, if an existing line is already present in the editor, that starts with these characters, is proposed as selected text.

Automatic addition of closing parenthesis: if this option is enabled, when you digit an open parenthesis (standard, square, or curly) the corresponding closing parenthesis is automatically added.

Use alternative paste mode: if you are unable to paste text in the editor, try this alternative method for the clipboard.

User alternative right-click menu: with this option enabled, the right-click on a directive line open the keyword list instead of the keyword editor (note that you can always have the non-selected option with a CTRL+right-click).

Keep the states of 'link first' and 'link dis.' checkboxes: note that usually these two checkboxes are not saved between sessions (i.e., closing and reopening nanDECK do not restore their state).

BATCH directive: for security reason the BATCH directive (see page 78) must be enabled before use, selecting an option from "Disabled", "Enabled (with confirmation)", and "Enabled".

Enable Internet Explorer 11 for HTMLTEXT / HTMLFILE: as a default a program cannot use Internet Explorer features beyond version 6, until there is a specific entry in Windows' Regedit; by using this button the program writes that correct entry.

Save keys: the program saves a "keys.txt" file, that contains the shortcuts for several actions, if you want to change them modify this file (with an editor) and restart nanDECK.

Compare decks

When you have loaded more than one deck (adding another tab with CTRL+N) you can view them side to side by clicking on the “Comp” button in the right side of the main window:

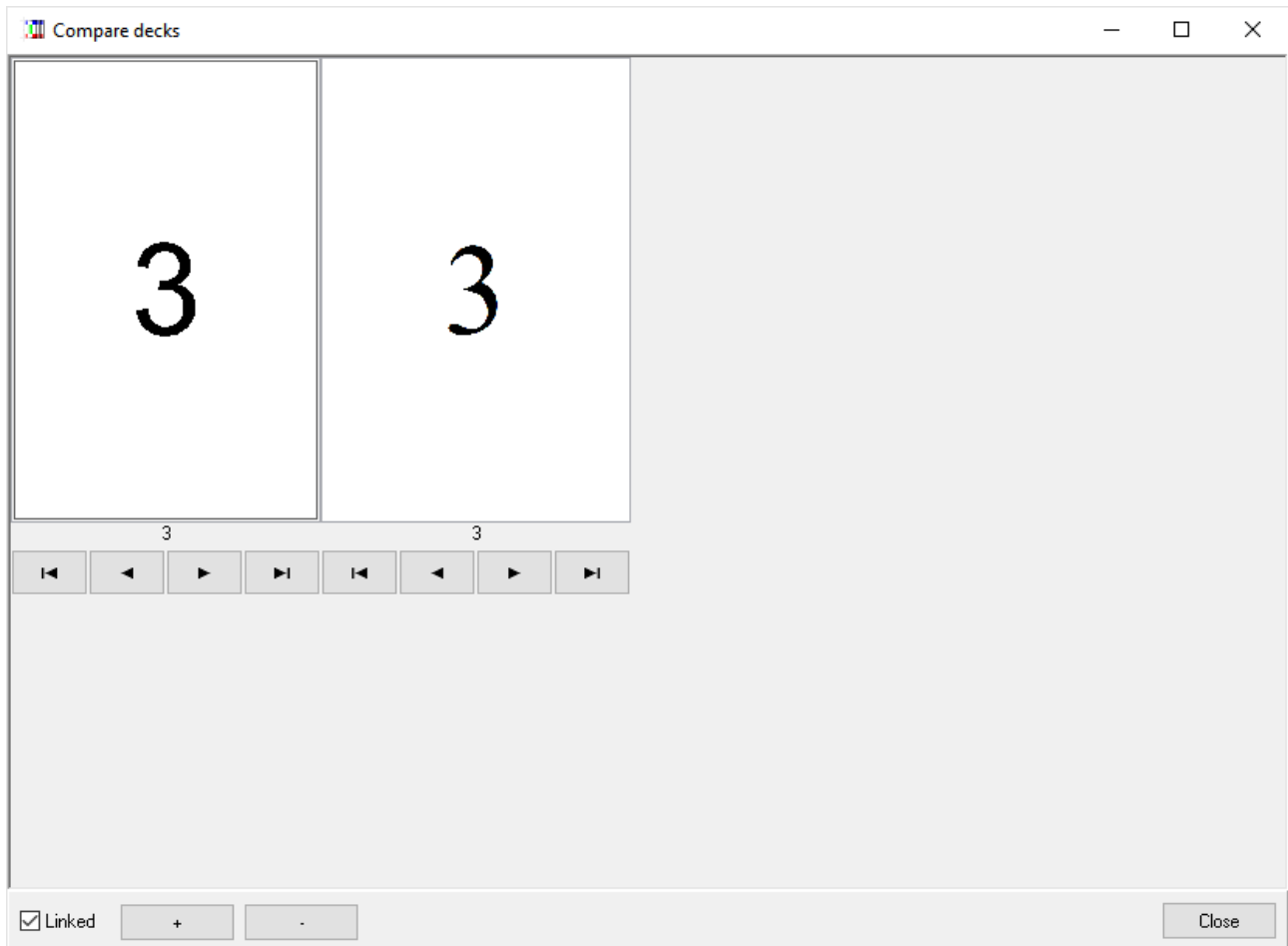

You can browse the decks with the arrow buttons (linked by default, but you can remove this feature with the “Linked” checkbox) and you can zoom in or out with the two buttons “+” and “-”.

Shortcuts

At the start, nanDECK reads a **shortcuts.txt** file from the same folder, and creates shortcuts for every line read (or combinations of lines). You can recall these clips of text with combinations of keys like **Ctrl + Alt + *letter*** or **Ctrl + Alt + Shift + *letter***. The lines associated with the *letter* character, lower or uppercase, (identified before a “:” colon) are inserted in the main editor (in the current edit position).

For example, if you have this **shortcuts.txt** file (created with Notepad or another text editor):

```
r:RECTANGLE = 1, 0, 0, 100%, 100%, #0000FF  
T:FONT = ARIAL, 32, , #000000  
TEXT = 1, "Test", 0, 0, 100%, 100%
```

You can press **Ctrl + Alt + r** for the RECTANGLE line or **Ctrl + Alt + Shift + t** for the FONT + TEXT lines.

References

E-mail	nand@libero.it
Website	http://www.nandeck.com
Yahoo! Group	http://tech.groups.yahoo.com/group/nandeck
BoardGameGeek Guild	http://www.boardgamegeek.com/guild/454

F.A.Q.

1) When must I use quotes (““)?

This program uses an interpreter for the evaluation of all parameters, this code separates them using commas (,). So, if a parameter has a comma in it, you must enclose the parameter in quotes. Otherwise, if a parameter has no commas, the quotes are optional (the program will accept the parameter with or without quote), but for some parameter quotes are an error (for numeric parameters, for example).

Correct examples:

```
IMAGE = "1-10", "c:\my images\earth.jpg", 0, 0, 6, 9, 0
IMAGE = 1-10, c:\my images\earth.jpg, 0, 0, 6, 9, 0

TEXT = 1-10, "This, is a test", 0, 0, 6, 9
```

Note: quotes in ranges are not needed.

Wrong example:

```
TEXT = 1-10, This, is a test, 0, 0, 6, 9
```

The 2nd parameter will be split into “This” for 2nd parameter and “is a test” for 3rd.

2) How can I insert quotes (or another character) in a text?

You can use `\n` syntax to insert a character in a text, with `n` being the ASCII code of that character, for example, if you want to enclose a text in quotes (ASCII 34) or add a new line (ASCII 13):

```
FONT = Arial, 32, , #000000
TEXT = 1, "I say \34>Hello\34\"", 0, 0, 6, 9, center, center
```

Note that `\13` works with TEXT directive, instead with HTMLTEXT you must use the HTML tag `
`.

3) Why this program uses so much memory?

This program has two settings for storing cards during creation: RAM or disk. The default setting is in RAM, and you can change that in the “Config” window, remember that RAM is faster (and you can run multiple instances of the program) but the computer may slow down when it starts using swap space; on disk is slower (and you can’t run multiple instances) but the speed remains the same even with very large decks (or higher DPI settings).

4) Why there is option (X) if you can use (Y)?

When writing this program, I tried to maintain backward compatibility with previous version, so you can do the same thing in more than one way. For example: WWTOP option for vertical alignment in TEXT command is equal to CENTER, for backward compatibility.

5) There is a Linux version?

No, but if you install Wine, you can run the same nanDECK version for Windows on your Linux, with all the major features; also, if you want better compatibility, you can download and install the “Microsoft core fonts”.

Wine <http://www.winehq.org/>
Microsoft core fonts <http://sourceforge.net/projects/corefonts/files/the%20fonts/>

Note: with a recent update, nanDECK uses a DLL (FONTSUB.DLL) that is not present in every distribution, if this is the case the program will not start, you must download a zip that includes this file from here:

http://www.nand.it/nandeck/nandeck_wine.zip

6) There is a Mac version?

No, but if you install Winebottler (and XQuartz) you can run the same nanDECK version for Windows on your OSX, with all the major features. You can also use an emulator like Virtual Box (free) or Parallels (commercial software).

Winebottler <http://winebottler.kronenberg.org/>
XQuartz <http://xquartz.macosforge.org/>

Note: with a recent update, nanDECK uses a DLL (FONTSUB.DLL) that is not present in every distribution, if this is the case the program will not start, you must download a zip that includes this file from here:

http://www.nand.it/nandeck/nandeck_wine.zip

Directives

BASERANGE

For each card in a range an element is extracted from a sequence, and as a default the first element from the sequence is paired from the first card in the range. The only exception is when you have a LABELRANGE function (see page 34): in this case, the n^{th} element from the sequence is paired with the n^{th} card from the deck. With this directive, you can change this behavior.

Syntax:

BASERANGE = “range”, switch

Parameters:

“range”: a range of cards,

switch: values accepted are:

ON the n^{th} element from the sequence is paired with the n^{th} card from the deck
OFF the n^{th} element from the sequence is paired with the n^{th} card from the range

BATCH

This directive executes an external batch script (a text file with a “.bat.” extension). For security reasons, you must enable the relative option in the Configuration form: here you can choose between “Disabled”, “Enabled (with confirmation)”, and “Enabled”. The batch file is called with these parameters:

%1 the current card’s number,
%2 the total number of cards in the deck,
%3 the name of the script.

Syntax:

BATCH = “batch file”, *flags*

Parameters:

“batch file”: path and name for a batch file,

flags: one or more of the following flags:

V the batch is executed at the validation step (the default, if not specified)
S the batch is executed at the start of the build step
C the batch is executed at the end of each built card
E the batch is executed at the end of the build step

Example:

```
BATCH = "c:\bat\copy_files.bat"
```

BEZIER

This directive draws a Bezier curve from a starting point (x1, y1) to an ending point (x2, y2), using two “handles” (h1 and h2).

Syntax:

BEZIER = “range”, pos x1, pos y1, handle x1, handle y1, handle x2, handle y2, pos x2, pos y2, html color, *thickness*, *end arrow*, *start arrow*

Parameters:

“range”: a set of cards,

pos x1, pos y1: coordinates of starting point (in cm),

handle x1, handle y1: coordinates of handle for starting point (in cm),

handle x2, handle y2: coordinates of handle for ending point (in cm),

pos x2, pos y2: coordinates of ending point (in cm),

html color: color of the curve, in the same format used for HTML. You can also specify a gradient,

thickness: thickness of the curve (in cm), if omitted, the curve is 1 pixel wide,

end arrow: width of the arrow (in cm), if omitted (or zero) there is no arrow at the end of the curve,

start arrow: width of the arrow (in cm), if omitted (or zero) there is no arrow at the start of the curve.

Example:

```
BEZIER = 1, 1.5, 0, 1.5, 4.5, 4.5, 4.5, 4.5, 9, #0000FF, 0.15
BEZIER = 1, 4.5, 0, 4.5, 4.5, 1.5, 4.5, 1.5, 9, #0000FF, 0.15
BEZIER = 1, 0, 3, 3, 3, 3, 6, 6, 6, #FF0000, 0.15
BEZIER = 1, 0, 6, 3, 6, 3, 3, 6, 3, #FF0000, 0.15
```

Result: Figure 11

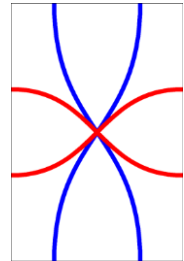

Figure 11

BEZIERS

This directive draws a Bezier curve from a starting point (from the last BEZIERS directive) to an ending point (x, y), using two “handles” (one from the last directive and one from parameter h). The first directive sets only the starting point, for each subsequent directive a curve is drawn (the starting point for the next curve is the ending point of the last). For restarting the process, you can specify a BEZIERS with only the range parameter.

Syntax:

BEZIERS = “range”, pos x, pos y, handle x, handle y, html color, thickness, end arrow, start arrow

Parameters:

“range”: a set of cards,

pos x, pos y: coordinates of starting/ending point (in cm),

handle x, handle y: coordinates of handle for starting/ending point (in cm),

html color: color of the curve, in the same format used for HTML. You can also specify a gradient,

thickness: thickness of the curve (in cm), if omitted, the curve is 1 pixel wide,

end arrow: width of the arrow (in cm), if omitted (or zero) there is no arrow at the end of the curve,

start arrow: width of the arrow (in cm), if omitted (or zero) there is no arrow at the start of the curve.

Example:

```
BEZIERS = 1, 0, 0, 3, 0, #000000, 0.1
BEZIERS = 1, 0, 3, 3, 3, #FF0000, 0.1, 0.5
BEZIERS = 1, 0, 6, 3, 6, #00FF00, 0.1, 0.5
BEZIERS = 1, 0, 9, 3, 9, #0000FF, 0.1, 0.5
```

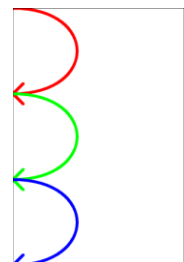

Figure 12

BLEED

This directive fills the space beyond a rectangle with the colors from the border of the rectangle, if you do not specify the size of the outer rectangle, this directive fills the whole card.

Syntax:

BLEED = "range", pos x1, pos y1, width1, height1, pos_x2, pos_y2, width2, height2

Parameters:

"range": a set of cards

pos x1: horizontal position (in cm)

pos y1: vertical position (in cm)

width1: width of the rectangle (in cm)

height1: height of the rectangle (in cm)

pos x2: horizontal position (in cm) of the outer rectangle

pos y2: vertical position (in cm) of the outer rectangle

width2: width of the outer rectangle (in cm)

height2: height of the outer rectangle (in cm)

Examples:

```
BLEED = "1-10", 1, 1, 4, 7
```

```
BLEED = "1-10", 1, 1, 4, 7, 0.5, 0.5, 5, 6
```

BORDER

This directive draws a border around all the cards.

Syntax:

BORDER = type, *html color*, *thickness*, *guidelines*, *guide color*, *mark/cross size*, *hor. guide offset*, *ver. guide offset*, *num. of guides*, *hor. gap offset*, *ver. gap offset*

Parameters:

type: the type of border can be chosen between:

RECTANGLE	draws a rectangle (the default)
ROUNDED	draws a rectangle with rounded corners
MARK	draws cut marks (the length is set with the 6 th parameter)
NONE	no border

html color: color of the border, in the same format used for HTML, black if not specified,

Note: if you want a different border color on each card, use instead RECTANGLE or ROUNDRECT

thickness: thickness of the border (in cm), if omitted, it is 1 pixel wide,

Note: the thickness of the border is measured on two cards; if you use a thickness of 1 cm, for example, on each card the border is 0.5 cm wide.

guidelines: this is for drawing lines beyond the card's boundaries (over the page's margins). You can choose between:

NONE	no guidelines (the default)
SOLID	solid lines
DOTTED	dotted lines
DASHED	dashed lines
MARK	draws cut marks only (solid lines)
MARKDOT	draws cut marks only (dotted lines)
MARKDASH	draws cut marks only (dashed lines)
CROSS	draws cut marks and crosses (solid lines, the length is set with the 6 th parameter)
CROSSDOT	draws cut marks and crosses (dotted lines, the length is set with the 6 th parameter)
CROSSDASH	draws cut marks and crosses (dashed lines, the length is set with the 6 th parameter)

guide color: color of the guidelines, in the same format used for HTML, black if not specified,

mark size: length of the cut marks (in cm) for MARK border type, and length of the arm of the cross (in cm) for CROSS/CROSSDOT/CROSSDASH guideline type,

hor. guide offset: horizontal guides are displaced of an offset (in cm), zero if not specified,

ver. guide offset: vertical guides are displaced of an offset (in cm), equal to horizontal offset if not specified,

num. of guides: number of guides drawn (0 means a single line),

hor. gap offset: a gap in horizontal marks (in cm), if zero (or not specified) the mark starts at the cards,

ver. gap offset: a gap in vertical marks (in cm), if zero (or not specified) the mark starts at the cards.

Examples:

```
BORDER = RECTANGLE
```

```
BORDER = ROUNDED, #0000FF, 0.5
```

BRUSH

This directive changes the style used for filling the shapes in these directives:

```
CIRCLE  
ELLIPSE  
FILL  
HEXGRID  
PIE  
POLYGON  
RECTANGLE  
RHOMBUS  
ROUNDRECT  
STAR  
TRIANGLE
```

Syntax:

```
BRUSH="range", type, "image file", width, height, flags
```

Parameters:

"range": a set of cards,

type: you can choose a type between these options:

SOLID	draws a solid fill (the default),
DIAGLEFT	fills with lines, drawn diagonally from top right to bottom left,
DIAGRIGHT	fills with lines, drawn diagonally from top left to bottom right,
SQUARE	fills with squares,
CROSS	fills with squares, rotated 45°,
HORIZONTAL	fills with lines, drawn horizontally,
VERTICAL	fills with lines, drawn vertically,
CUSTOM	fills with an image

“image file”: the image file used for filling the shapes

width: width of the image, in cm

height: height of the image, in cm

flags: one or more of the following flags:

A	absolute position of the custom bitmap (relative to the card)
R	relative position of the custom bitmap

Examples:

```
BRUSH="1-10", SQUARE
```

```
BRUSH="1-10", CUSTOM, "dots.gif", 5%, 5%
```

BUTTON

This directive draws a 3D rectangle over a set of cards. This directive works only if you have previously drawn something in the specified area.

Syntax:

```
BUTTON = “range”, pos x, pos y, width, height, depth, flags
```

Parameters:

“range”: a set of cards,

pos x: horizontal position (in cm),

pos y: vertical position (in cm),

width: width of the rectangle (in cm),

height: height of the rectangle (in cm),

depth: width of the 3D border,

flags: one or more of the following flags:

I	from out to in
O	from in to out
G	gradient effect

Example:

```
RECTANGLE = 1, 1, 1, 4, 3, #00FFFF  
RECTANGLE = 1, 1, 5, 4, 3, #00FFFF
```

```
BUTTON = 1, 1, 1, 4, 3, 0.3, I
BUTTON = 1, 1, 5, 4, 3, 0.3, O
```

Result: Figure 13

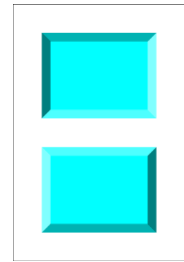

Figure 13

CANVAS

With this directive, the program splits the canvas (card 0) onto a range of cards. The canvas' size can be decided with a CANVASSIZE directive (see page 83).

Syntax:

CANVAS = "range", flags

Parameters:

"range": a set of cards,

flags: in this parameter you can specify a special behavior, possible values are:

- H the canvas is horizontally centered in the cards,
- V the canvas is vertically centered in the cards.

Tip: You can view the content of the canvas bitmap with a click on the button "Canv" (to the right of the "Card preview" button). You can reduce/enlarge it with a double-click on the image.

For example, if you must draw a large circle, to be split onto six cards, you can use the CANVASSIZE/CANVAS directives, like in this script:

```
BORDER = MARK
CANVASSIZE = 18, 18
CANVAS = 1-6
ELLIPSE = 0, 0, 0, 18, 18, #0000FF#FF0000@360
FONT = Arial, 48, , #000000
TEXT= 1-9, {$}, 0, 0, 2, 2, CENTER, CENTER
```

This is the resulting printed page (I have added a number in the top-left corner of each card for helping identify them):

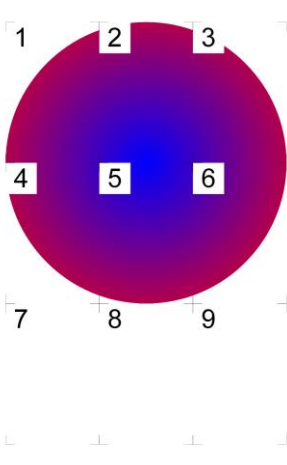

CANVASSIZE

This directive sets the size of the canvas (card number 0). If omitted, is 6 cm x 9 cm. The card 0 is a card that isn't printed with the deck, is can have a different size than the standard card and can be used in two ways: as a drawing board to realize special effects, and to draw a larger card that must be split onto several standard cards, using the CANVAS directive (see page 83).

Syntax:

CANVASSIZE = width, height

Example:

```
CANVASSIZE = 12, 18
```

CANVASWORK

This directive tells the program to draw the canvas (card 0) after drawing the range of cards specified in the parameter.

Syntax:

```
CANVASWORK = "range"
```

Parameters:

"range": a set of cards.

CARDS

This directive can be used to specify the total number of cards that compose the current deck.

Syntax:

```
CARDS = number
```

This directive is somehow obsolete, if you do not specify it, the total number of cards is deducted from the other directives. For example, in that script the total number of cards is set to 20:

```
RECTANGLE = "1-5,15-20", 0, 0, 6, 9, #00FF00
```

But, if you also specify a CARDS directive, the cards' number is forced. For example, in that script the total number of cards is set to 15 (and the extra cards specified in RECTANGLE are ignored):

```
CARDS = 15  
RECTANGLE = "1-5,15-20", 0, 0, 6, 9, #00FF00
```

CARDSIZE

This directive sets the size of cards (in cm). If omitted, is 6 cm x 9 cm.

Syntax:

```
CARDSIZE = width, height
```

Examples:

```
CARDSIZE = 5, 10
```

```
CARDSIZE = 2.5, 2.5
```

CASE

This directive is used in a structure SELECT...ENDSELECT to specify a code that must be executed when the value in the SELECT is equal to a specific value (see page 155).

Syntax:

```
CASE = value
```

Parameters:

value: a string, number, label, or expression that can be evaluated.

CASEELSE

This directive is used in a structure SELECT...ENDSELECT to specify a code that must be executed only if all the CASEs directives are not executed (see page 155).

Syntax:

CASEELSE

Parameters:

None

CHROMAKEY

This directive sets the color to be treated as transparent during image loading (with IMAGE directive, see page 119). The default transparent color, if CHROMAKEY was not used, is the color in the top-left pixel of the image.

Syntax:

CHROMAKEY = html color | corner type, *level*

Parameters:

corner type: the color will be picked from one of the four corners, or from the center of the image:

TOPLEFT
TOPRIGHT
BOTTOMLEFT
BOTTOMRIGHT
CENTER

level: if specified, are treated as transparent also the colors within a level of difference from the base transparent color (calculated as a distance in CIELab space).

Examples:

CHROMAKEY = #FFFFFF

CHROMAKEY = TOPLEFT

CIRCLE

This directive draws a circle in a set of cards.

Syntax:

CIRCLE = “range”, pos x, pos y, width, height, html color, *html color*, *thickness*

Parameters:

“range”: a set of cards,

pos x: horizontal position (in cm),

pos y: vertical position (in cm),

width: width of the circle (in cm),

height: height of the circle (in cm),

html color: border color of the circle, in the same format used for HTML. You can also specify a gradient.

html color: inner color of the circle, in the same format used for HTML, if not specified the inner color is the same of border color. You can also specify “EMPTY” for a hollow circle or a gradient.

thickness: thickness of the border of the circle (in cm), if omitted, the circle’s border is 1 pixel wide.

Examples:

```
CIRCLE = 1, 1, 1, 4, 7, #00FF00
```

Result: Figure 14

```
CIRCLE = 1, 1, 1, 4, 7, #FF00FF, EMPTY, 0.1
```

Result: Figure 15

```
ELLIPSE = 1, 1, 1, 4, 7, #FF0000#0000FF@90
```

Result: Figure 16

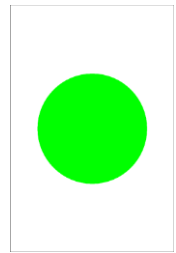

Figure 14

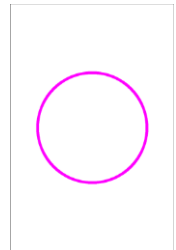

Figure 15

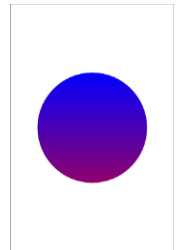

Figure 16

CMYK

This directive modifies the color space of JPG/JPEG images saved with a SAVE directive (see page 152).

Syntax:

CMYK = “range”, switch, *color profile*

Parameters:

“range”: a set of cards.

The *switch* parameter can be set equal to:

ON to use the CMYK color space when a JPG/JPEG file format is specified,
OFF to use the RGB color space (default).

If the former switch is ON, it can also be specified an optional color profile parameter, that can be an ICC/ICM file, or a JPG/JPEG (from which a color profile is extracted).

COLOR

This directive modifies the colors, brightness, contrast, and saturation of images (and text) being rendered on a range of cards. See directives IMAGE (page 119), ICONS (page 117), PATTERN (page 144) and TEXT (page 160).

Syntax:

COLOR = “range”, html color, *bri-con-sat*

Parameters:

“range”: a set of cards,

html color: color used for rendering the image, in the same format used for HTML. If you want to maintain the original colors, you must use a median gray (#808080).

bri-con-sat: a triplet of brightness, contrast, and saturation value, used for rendering the image, written in hexadecimal format (like an html color), starting with an ampersand (&) character. If you want to maintain some of the original values, use the median value (hexadecimal 80). If this parameter is omitted, are used three neutral values (&808080).

Examples:

```
COLOR = 1, #00FF00
IMAGE = 1, "c:\images\earth.jpg", 0, 0, 6, 9, 0, P
Result: Figure 17
```

```
COLOR = 1, #808080, &FF8080
IMAGE = 1, "c:\images\earth.jpg", 0, 0, 6, 9, 0, P
Result: Figure 18
```

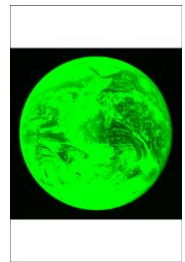

Figure 17



Figure 18

COLORCHANGE

This directive changes one color into another, in a rectangle area of a range of cards.

Syntax:

COLORCHANGE = “range”, pos x, pos y, width, height, html color source, html color destination, *level*

Parameters:

“range”: a set of cards,

pos x: horizontal position (in cm),

pos y: vertical position (in cm),

width: width of the rectangle (in cm),

height: height of the rectangle (in cm),

html color source: a color value, in HTML format

html color destination: a color value, in HTML format

level: if zero, the source color is exactly the one specified in the 6th parameter, otherwise are taken also colors that differ from that source a value equal this parameter in one, two, or three RGB components.

COLORS

This directive writes from one to four colors into as many variables, that can be used instead of a color value.

Syntax:

COLORS = “range”, html color1, *html color2*, *html color3*, *html color4*, *html color5*

Parameters:

“range”: a set of cards,

html color1: a color value, in HTML format, that is stored into variable #ZZZZZZ

html color2: a color value, in HTML format, that is stored into variable #YYYYYY

html color3: a color value, in HTML format, that is stored into variable #XXXXXX

html color4: a color value, in HTML format, that is stored into variable #WWWWW

html color5: a color value, in HTML format, that is stored into variable #VVVVV

Instead of a color, you can use another variable, or the syntax #X ζ Y to read a color located at position X, Y of the current card (you can use also % with each value, for example: #50% ζ 50%).

With the syntax #X1 ζ Y1 ζ X2 ζ Y2 you can read the most used color in an image, (the image starts from X1, Y1 and end to X2, Y2).

With the syntax #X1 ζ Y1 ζ X2 ζ Y2 ζ Min ζ Max you can read the most used color in an image, (the image starts from X1, Y1 and end to X2, Y2), excluding colors with percent brightness lower than **Min** and higher than **Max**.

With the syntax #AAAAA>#BBBBB<#CCCCC you can select between two colors: if the brightness of color #A is more or equal to 50%, the variable is set to color #B, if the brightness is less than 50%, the variable is set to color #C. Every color can be also modified adding a value for saturation and a value for brightness change (in percent), with the syntax #000000+saturation+brightness (the values for saturation and brightness can also be negatives).

Example:

```
COLORS = 1, #FF0000
COLORS = 2, #00FF00
COLORS = 3, #0000FF
RECTANGLE = 1-3, 0, 0, 100%, 100%, #ZZZZZZ
```

COMMENT

This directive sets the character used for comments, and eventually activate the in-line comments. The utilization of this directive is equivalent to the settings in the "Config" section of the program.

Syntax:

COMMENT = character, *INLINE*

Parameters:

character: the character used for comments, it must be the first character of the line,

INLINE: the same character (doubled) will be used for in-line comments.

Examples:

```
COMMENT = &
& This is a comment

COMMENT = !, INLINE
RECTANGLE=1, 0, 0, 6, 9, #00FF00 !! This is another comment
```

COMPARE

This directive compares the cards built with the current script with those built with the filename specified as a parameter and creates a range (to be used with PRINT=COMPARE) with only the cards which are different.

Syntax:

COMPARE = "filename"

Parameter:

"filename": the filename to be compared with the current script.

Example:

```
COMPARE="script_ver1.txt"  
PRINT=COMPARE
```

COPY

This directive does a copy-and-paste of a section of a card into another position on the same card. If you want to copy a section of a card onto another card, you must use the SAVE and IMAGE directives (see page 152).

Syntax:

```
COPY = "range", pos x1, pos y1, width1, height1, pos x2, pos y2, width2, height2, angle, flags
```

Parameters:

"range": a set of cards,

pos x1: starting horizontal position (in cm) of the image,

pos y1: starting vertical position (in cm) of the image,

width1: starting width of the image (in cm),

height1: starting height of the image (in cm),

pos x2: ending horizontal position (in cm) of the image,

pos y2: ending vertical position (in cm) of the image,

width2: ending width of the image (in cm),

height2: ending height of the image (in cm),

angle: angle of image rotation, can be 0 for no rotation,

flags: in this parameter, you can specify a special behavior for the image, possible values are:

H Horizontal mirror
V Vertical mirror

Example:

```
IMAGE = 1, " c:\images\earth.jpg", 0, 0, 3, 3.5, 0, P  
FONT = Arial, 16, , #FFFFFF, #00000  
TEXT = 1, "Earth", 0, 3.5, 3, 1, CENTER, CENTER  
COPY = 1, 0, 0, 3, 4.5, 3, 0, 3, 4.5, 0, H  
COPY = 1, 0, 0, 3, 4.5, 0, 4.5, 3, 4.5, 0, V  
COPY = 1, 0, 0, 3, 4.5, 3, 4.5, 3, 4.5, 0, HV
```

Result: Figure 19



Figure 19

COPYCARD

This directive duplicates cards from a source range to a destination range. Both source and destination ranges can be single cards.

Syntax:

```
COPYCARD = "destination range", "source range"
```

Parameters:

“**destination range**”: a set of cards,

“**source range**”: a set of cards.

Example:

```
COPYCARD = "5-8", "1-2"
```

This is the deck, before the directive:

```
CARD 1  
CARD 2  
CARD 3  
CARD 4
```

This is the deck, after the directive:

```
CARD 1  
CARD 2  
CARD 3  
CARD 4  
CARD 1  
CARD 2  
CARD 1  
CARD 2
```

CORRECTION

This directive enables/disables the pixel correction. If enabled, one pixel is added to width and heights of ELLIPSE, RECTANGLE, ROUNDRECT, and RHOMBUS directives. The correction default is ON.

Syntax:

```
CORRECTION = “range”, switch
```

Parameters:

“**range**”: a range of cards,

switch: values accepted are:

```
ON    Pixel correction enabled  
OFF   Pixel correction disabled
```

Example:

```
CORRECTION = 1, OFF
```

COUNTER

This directive sets a counter to a value. A counter is a variable that can be used in expressions (see page 55). This directive can be used with a dice (see DICE directive, page 92) to revert it into a counter. Note: after the build, a warning is issued if one counter is used in an expression without being initialized.

Syntax:

```
COUNTER = “range”, counter name, counter value, counter inc, counter limit
```

Parameters:

“range”: a set of cards,

counter name: a counter letter(s),

counter value: a value, it can be a fixed number or an expression,

counter inc: each time the counter is used, is incremented of this value (or decremented, if negative),

counter limit: if the value of the counter is higher of this value, the counter is reset at the starting value.

Valid counters for integer values:

A B C D E F G H I J

Valid counters for floating values:

AA BB CC DD EE FF GG HH II JJ

Examples:

COUNTER = "1", A, 100

COUNTER = "1-10", B, 2D6

DECK

This directive prepares a deck of cards to be used in the “Virtual table” option (see page 66). If you do not use this directive, the program prepares a deck to be used in the virtual table with all the cards.

Syntax:

DECK = “range”, “deck name”, html color, height, *flag*, *back range*, *pos x*, *pos y*, *starting frames*, *frames*, *rules*

Parameters:

“range”: a set of cards,

“deck name”: the name of the deck,

html color: deck color in the same format used for HTML,

height: height of the deck (in pixels), you can also specify a % of the screen’s height. The deck’s width is proportional to the height.

flag: you can specify these options:

R the deck is shuffled (the default)

N the deck is not shuffled (the order of the cards is that one specified in **“range”** parameter)

back range: if you specify a number for this parameter, for the deck image (back of cards) is used that card (taken from the deck) instead of a color. You can also use a range of cards for this parameter,

pos x: horizontal position for the deck (in pixels), you can also specify a % of the screen’s width,

pos y: vertical position for the deck (in pixels), you can also specify a % of the screen’s height,

starting frames: if specified, the deck is placed in a frame randomly taken from this list,

frames: when a card from this deck is moved on the table, it is positioned in the nearest frame from this list,

rules: when a card from this deck is moved on the table, are enforced the rules specified in this list (see page 66 for a list of rules).

Note: the DECK directive is not compatible with the DUPLEX directive, do not use both in the same script.

Example:

```
DECK = 1-13, "Hearts", #FF0000, 50%
```

DEPTH

This directive changes the number of bitplanes (and therefore the maximum number of colors) used in storing the cards' images, so you can use less RAM and can manage more cards.

Syntax:

DEPTH = "range", bitplanes

Parameters:

"range": a set of cards.

The *bitplanes* parameter can be set equal to:

24	16 millions of colors (the default),
16	65536 colors,
8	256 colors,
4	16 colors.

DICE

This directive converts one counter into a dice (it can be used later in expressions).

Syntax:

DICE = "range", counter, "dice range", dice number, *flags*, *default1*, *default2*, *reroll*

Parameters:

"range": a set of cards,

counter name: valid counters are:

```
A B C D E F G H I J
```

"dice range": a range of values, from which is taken the result of the dice roll; if a ">>" is added, the result adds another roll; if a "<<" is added, the result subtracts another roll; if a "***" is added, the result is rerolled,

dice number: the number of dice rolled,

flags: the syntax for this parameter is *fng*, where *f* is the flag that specify how the dice are grouped, *n* is a number that specify how much dice are used, and *g* is the flag that specify how the dice to be grouped are chosen from the main pool.

The 1st flag can be chosen between:

+	sum (the default, if not specified)
*	multiply
-	subtract
#	absolute value after subtracting
£	concatenate

^ concatenate without duplicates

The 2nd flag can be chosen between:

- + upper dice (the default, if not specified)
- lower dice

default1: the value to be used if the number before the dice is missing,

default2: the value to be used if the number after the dice is missing,

reroll: the times the dice are rerolled if the result is marked with "***".

Example, rolling four dice (with values from one to six) and sum the upper three:

```
DICE = 1, A, "1-6", 4, +3+
```

Example, rolling four open dice (subtracting dice for one, adding dice for six):

```
DICE = 1, A, "1<<,2,3,4,5,6>>", 4
```

Example, rolling four dice, and rerolling them three times when the result is "-1":

```
DICE = 1, A, "-1**, -1**, 0, 0, 1, 1", 4, , , , 3
```

DISPLAY

This directive draws a list of cards to the canvas (card 0), resizing it accordingly, and save it with a filename (if specified). If the range is omitted, all the deck is drawn and saved. The width parameter is the number of cards in horizontal, if omitted, is chosen the maximum number from the factors of the total number of the cards. Note that if there are N cards, and N is a prime number, the default result will be a line of N cards (since the only other number that is a divisor of a prime number is one); in this case you can specify a different width, and the last cards would be filled with blanks. Instead of specifying starting and ending card, you can use a range as 5th parameter (leave the other at zero). If you specify a filename with a question mark (?) as a first character, the program asks you if the existing file must be overwritten.

Syntax:

```
DISPLAY = "image file", first card, last card, width, "range", transparent color, "mask file"
```

Parameters:

"image file": the name of the saved file,

first card: the first card drawn in the file,

last card: the last card drawn in the file,

width: the width (in cards) of the rectangle,

"range": the set of cards drawn in the file,

transparent color: for PNG and GIF, if this parameter is specified, the file is saved with this color as transparent, for PNG files you can also specify more than one color (for example #0000FF#00FF00 for two colors) and add a level of transparency, in the format #xxyyyyyy, where xx = transparency level (from 00 = full transparent to FF = full solid) and yyyyyy = color. Another format accepted is #xyyyyyyyzzz, where zzz is a number that is used as "likeness" of the color to be treated as transparent. Finally, you can also specify a G at the end to proportionally adjust the level of transparency to the level of likeness.

"mask file": if this parameter is specified (a PNG image), is used as transparency mask for the saved image (note that in this case the "transparent color" is not used).

Example:

```
DISPLAY = "c:\deck.png", 1, 10
```

DOWNLOAD

This directive downloads a file from Internet if the file does not already exist in the specified path.

Syntax:

```
DOWNLOAD = URL, "filename"
```

Parameters:

URL: the URL for a file, it must start with **http://** or **https://**,

"filename": the path and filename for the downloaded file, if omitted, the path is the current folder, and the name is taken from the URL parameter.

Example:

```
DOWNLOAD = http://game-icons.net/icons/delapouite/originals/png/sheep.png
```

<i>You can also use two sequences, one for the URLs and one for the filenames.</i>
--

DPI

This directive sets the resolution of cards (in Dots Per Inch). If omitted, is 300 (the default for printing); if you want to show the cards on screen, you can use a value of 150.

Syntax:

```
DPI = dpi number
```

Note that with a value too high, the time of rendering can be exceptionally long, and the program uses more memory (or disk space).

Example:

```
DPI = 150
```

DRAW

This directive draws several cards from a deck in the "Virtual table" option (see page 66). If you do not use this directive, the program prepares a deck to be used in the virtual table with all the cards. If you specify a new name, a deck is created with the card drawn, if you leave the 2nd parameter empty, the cards drawn are shown into the table as separated objects.

Syntax:

```
DRAW = "deck name", "deck name new", number, flag, pos x, pos y, starting frames
```

Parameters:

"deck name": the name of the deck from which the cards are drawn,

"deck name new": the name of the deck created with the cards drawn,

number: the number of cards drawn,

flag: you can specify these options:

U the cards are drawn face up
D the cards are drawn face down (the default)

pos x: horizontal position for the cards/deck drawn (in pixels), you can also specify a % of the screen's width,

pos y: vertical position for the cards/deck drawn (in pixels), you can also specify a % of the screen's height,

starting frames: if specified, the cards drawn are placed in frames randomly taken from this list.

Example:

```
DRAW = "standard", "new", 10, U
```

DUPLEX

This directive copies a card (or a range of cards) to another position (or range) calculated automatically by the software, it is useful to manage duplicates or synchronize the front and back of cards for a duplex printing. See also PRINT directive (see page 147).

Syntax:

DUPLEX = "range front", "range back", *number*

Parameters:

"range front": a card or a range of card to be copied,

"range back": a card or a range of card to be copied, front-to-back with the card(s) specified in the 1st parameter,

number: if specified, the card is replicated several times; if not specified, it is treated like one copy.

Example:

```
DUPLEX = 1-10, 11  
DUPLEX = 12-21, 22, 2
```

Note: since nanDECK need to add cards to the deck, you must not use a CARDS directive in the script.

Note: the DUPLEX directive is not compatible with the DECK directive, do not use both in the same script.

EDGE

This directive changes the style used for drawing the lines / boundaries with these directives:

BEZIER
BEZIERS
CIRCLE
ELLIPSE
HEXGRID
LINE
LINERECT
GRID
PIE
POLYGON
RECTANGLE
RHOMBUS
ROUNDRECT
STAR

TRACK
TRACKRECT
TRIANGLE

Syntax:

EDGE = “range”, type, *pattern*

Parameters:

“range”: a set of cards,

type: you can choose a type between these options:

SOLID	draws a solid line (the default),
DASH	draws a dashed line,
DOT	draws a dotted line,
DASHDOT	draws a line alternating a dash and a dot,
DASHDOTDOT	draws a line alternating a dash and two dots,
CUSTOM	draws a line using a custom pattern.

pattern: a pattern for the custom style, this pattern can be composed of:

O	dot
D	dash
S	space

These letters can be repeated, for example “OSDSOS” is a valid pattern.

ELLIPSE

This directive draws an ellipse in a set of cards.

Syntax:

ELLIPSE = “range”, pos x, pos y, width, height, html color, *html color*, *thickness*

Parameters:

“range”: a set of cards,

pos x: horizontal position (in cm),

pos y: vertical position (in cm),

width: width of the ellipse (in cm),

height: height of the ellipse (in cm),

html color: border color of the ellipse, in the same format used for HTML. You can also specify a gradient.

html color: inner color of the ellipse, in the same format used for HTML, if not specified the inner color is the same of border color. You can also specify “EMPTY” for a hollow ellipse or a gradient.

thickness: thickness of the border of the ellipse (in cm), if omitted, the ellipse’s border is 1 pixel wide.

Examples:

```
ELLIPSE = 1, 1, 1, 4, 7, #00FF00
```

Result: Figure 20

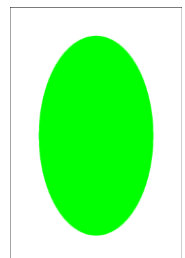

Figure 20

```
ELLIPSE = 1, 1, 1, 4, 7, #FF00FF, EMPTY, 0.1  
Result: Figure 21
```

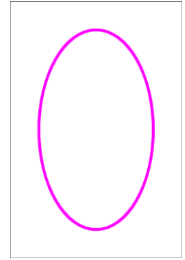

Figure 21

```
ELLIPSE = 1, 1, 1, 4, 7, #FF0000#0000FF@90  
Result: Figure 22
```

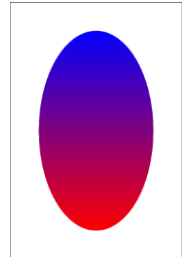

Figure 22

ELSE

This directive is used in a structure IF...ENDIF to specify a code that must be executed only if the test in the IF directive is not true (see page 118).

Syntax:

```
ELSE
```

Parameters:

none

ELSEIF

This directive is used in a structure IF...ENDIF to specify a code that must be executed only if the test in this line is true and the test in the first IF directive is false (see page 118).

Syntax:

```
...  
ELSEIF = value1 operator value2  
...
```

Parameters:

value: a string, number, label, or expression that can be evaluated,

operator: the condition is evaluated using the two values and this operator, you can use one operator from the same listed for the IF directive.

END

This directive is used to close a MACRO...END structure (see page 139).

Syntax:

```
END
```

Parameters:

none

ENDFRAME

This directive closes a FRAME...ENDFRAME structure (see page 106).

Syntax:

```
ENDFRAME
```

Parameters:

none

ENDIF

This directive is used to close an IF...ENDIF structure (see page 118).

Syntax:

ENDIF

Parameters:

none

ENDIMAGEENC

This directive closes an IMAGEENC...ENDIMAGEENC structure (see page 122).

Syntax:

ENDLAYER

Parameters:

none

ENDLAYER

This directive closes a LAYER...ENDLAYER structure (see page 127).

Syntax:

ENDLAYER

Parameters:

none

ENDLINK

This directive closes a LINK...ENDLINK structure (see page 131).

Syntax:

ENDLINK

Parameters:

none

Example:

```
linkmulti=num
link=
num,string
1,alpha
2,beta
3,gamma
endlink
[all]="1- { (num) } "
font=Arial,48,,#000000
```

```
text=[all],[num],0,0,100%,50%
text=[all],[string],0,50%,100%,50%
```

ENDSECTION

This directive closes a SECTION...ENDSECTION structure (see page 155).

Syntax:

ENDSECTION

Parameters:

none

ENDSELECT

This directive is used to close a SELECT...ENDSELECT structure (see page 155).

Syntax:

ENDSELECT

Parameters:

none

ENDSEQUENCE

This directive is used to close a SEQUENCE...ENDSEQUENCE structure (see page 156).

Syntax:

ENDSEQUENCE

Parameters:

none

ENDVISUAL

This directive closes a VISUAL...ENDVISUAL structure (see page 168).

Syntax:

ENDVISUAL

Parameters:

none

EXPRESSION

This directive specifies the characters used to define expressions to be evaluated in texts in HTMLTEXT (see page 115) and RTFTEXT (see page 151) directives.

Syntax:

EXPRESSION = exp. HTML start, exp. HTML end, exp. RTF start, exp. RTF end

Parameters:

exp. HTML start: character(s) used to define start of expressions in HTMLTEXT directive,

exp. HTML end: character(s) used to define end of expressions in HTMLTEXT directive,

exp. RTF start: character(s) used to define start of expressions in RTFTEXT directive,

exp. RTF end: character(s) used to define end of expressions in RTFTEXT directive,

Example:

```
EXPRESSION = { , }
```

FACTORS

This directive sets two factors used in elements printed with HTMLTEXT (see page 115).

Syntax:

FACTORS = background size factor, *font size factor*

Parameters:

background size factor: the size of the background printed with B flag is multiplied for this value.

font size factor: the size of the font is multiplied for this value.

Example:

```
FACTORS = 1.2
```

FILL

This directive fills a region with a color (the region is delimited by another color).

Syntax:

FILL = “range”, pos x, pos y, html fill color, html border color, *flags*

Parameters:

“range”: a set of cards,

pos x: horizontal initial position (in cm) of the fill,

pos y: vertical initial position (in cm) of the fill,

html fill color: color of the fill. You can also specify a gradient,

html border color: this is the area color (or boundary color) for the fill,

flags: one of the following flags

A the 5th parameter is the color of the area to be filled

B the 5th parameter is the color of the boundary that enclose the area to be filled

If you do not specify a flag, it is considered B as default.

Example:

```

LINE = 1, 0, 1, 6, 1, #0000FF, 0.1
LINE = 1, 0, 8, 6, 8, #0000FF, 0.1
LINE = 1, 1, 0, 1, 9, #0000FF, 0.1
LINE = 1, 5, 0, 5, 9, #0000FF, 0.1
LINE = 1, 0, 9, 6, 0, #0000FF, 0.1
FILL = 1, 2, 2, #FFFF00#FF8000@0, #0000FF
FILL = 1, 2, 7, #FF8000#FFFF00@0, #0000FF

```

Result: Figure 23

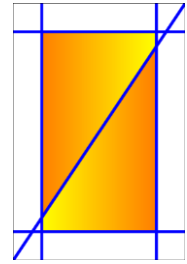

Figure 23

FLAGS

This directive sets a set of flags to all the subsequent directives in the script. If you want to remove a flag instead of adding it, use before the “-” symbol (minus).

Syntax:

FLAGS = “range”, directive, flags

Parameters:

“range”: a set of cards,

directive: the directive affected by the flags,

flags: the flag or flags to be set.

Example:

```

FLAGS = 1-10, HTMLTEXT, BE

```

FOLD

This directive copies a card (or a range of cards) to another position (or range) calculated automatically by the software, it is useful when you want to print fronts and backs of cards on a single page, that can be folded on the horizontal or vertical axis and glued (note that with the horizontal folding the backs are rotated 180°). See also PRINT directive (see page 147).

Syntax:

FOLD = “range front”, “range back”, *number*, *flags*

Parameters:

“range front”: a card or a range of card to be copied,

“range back”: a card or a range of card to be copied, front-to-back with the card(s) specified in the 1st parameter,

number: if specified, the card is replicated several times; if not specified, it is treated like one copy.

flags: one or more of the following flags

- H the folding line is horizontal (if not specified, this is the default folding for landscape page orientation)
- V the folding line is vertical (if not specified, this is the default folding for portrait page orientation)
- A if there is a horizontal folding line, the vertical gap is augmented until there is an even number of rows, if there is a vertical folding line, the horizontal gap is augmented until there is an even number of columns

Example:

```

FOLD = 1-10, 11
FOLD = 12-21, 22, 2

```

Note: since nanDECK need to add cards to the deck, you must not use a CARDS directive in the script.

Note: the FOLD directive is not compatible with the DECK directive, do not use both in the same script.

FOLDER

This directive sets the current working directory (if you do not specify it, it will be used the folder where the script is located).

Syntax:

FOLDER = "folder"

Parameters:

"folder": the folder to be used as current working directory.

Example:

```
FOLDER = "c:\projects\test"
```

FONT

This directive sets the font for any following TEXT command (see page 160). Note that there is not any reference to a range of cards. If you want a ranged command, you can use FONTRANGE instead (see page 104).

Syntax:

FONT = "font name", font size, style, html color font, *html color background*, *outline x*, *outline y*, *step x*, *step y*, *char space*

Parameters:

"font name": character font name (string),

font size: character font size, in typographical points (1 point = 1/72 of an inch),

style: character font style and flag used for visualization; values accepted are:

B	bold
I	italic
U	underline
S	strikeout
T	transparent font background
N	do not clip text at the boundary
C	circular text
R	circular text, reversed
H	circular text, half circumference
Q	circular text, one quarter circumference
E	circular text, three quarter circumference
Z	the text follows the curve drawn with the last BEZIER directive
F	the size is reduced until the text fits in the rectangle specified by TEXT directive (this value is stored in TF var)
V	vertical text
P	do not clip text area beyond the rectangle
O	transparent font text (flag T is ignored)
D	the text is placed in the rectangle's diagonal (from top-left to bottom-right)
G	the text is placed in the rectangle's diagonal (from top-right to bottom-left)
A	gradient is calculated from the text instead of from the rectangle
X	the text is shrunk if too large to fit the rectangle
Y	the text is stretched if too small to fit the rectangle

html color font: character color, in the same format used for HTML. You can also specify a gradient,

html color background: background color, in the same format used for HTML. You can also specify a gradient.

This parameter can be omitted (it will be used the last background color used, or white if none was specified), if you specified T as a style flag, the background color will not be used.

Tip: you can choose the font with a Windows standard dialog, clicking on the button "Insert" and choosing the menu voice "Font".

Examples (the difference was in the T flag in the 2nd FONT command):

```
RECTANGLE = 1, 0, 0, 6, 4, #FF0000
FONT = "Arial", 32, B, #FFFFFF, #0000FF
TEXT = 1, "TEST", 0, 1, 6, 2, center
```

Result: Figure 24



Figure 24

```
RECTANGLE = 1, 0, 0, 6, 4, #FF0000
FONT = "Arial", 32, BT, #FFFFFF, #0000FF
TEXT = 1, "TEST", 0, 1, 6, 2, center
```

Result: Figure 25



Figure 25

outline x: horizontal expansion in cm, with that parameter the text will be replicated horizontally from -x to +x,

outline y: vertical expansion in cm, with that parameter the text will be replicated vertically from -y to +y,

step x: the number of times the text is printed horizontally,

step y: the number of times the text is printed vertically,

char space: spacing between characters in circular text (if not present, the text is justified).

Example:

```
FONT = "Arial", 32, B, #FFFFFF, #0000FF, 0.1, 0.1
TEXT = 1, "TEST", 0, 1, 6, 2, center
```

Result: Figure 26



Figure 26

FONTALIAS

This directive enables/disables the font anti-aliasing, using the Operating System's routines. It is useful to remove colored pixels in the text's boundaries, especially when using HTMLTEXT (see page 115) or RTFTEXT (see page 151) directives with transparent background.

Syntax:

FONTALIAS = "range", switch

Parameters:

"range": a range of cards,

switch: values accepted are:

- ON Font anti-aliasing enabled
- OFF Font anti-aliasing disabled

Example:

```

{[html_on]="<style type='text/css'>p {font-size: 32px}</style><p>
ANTIALIASING ON</p>"}
{[html_off]="<style type='text/css'>p {font-size: 32px}</style><p>
ANTIALIASING OFF</p>"}
ELLIPSE = 1, 0, 0, 6, 3, #FF0000
ELLIPSE = 1, 0, 3, 6, 3, #FF0000
FONTALIAS = 1, ON
HTMLTEXT = 1, [html_on], 0, 0, 6, 3, #FFFFFF, 0, T
FONTALIAS = 1, OFF
HTMLTEXT = 1, [html_off], 0, 3, 6, 3, #FFFFFF, 0, T

```

Result: Figure 27

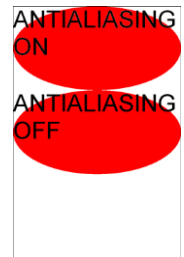

Figure 27

FONTCHANGE

This directive changes a font in the script with another. It is useful when you want to test a script on a computer that does not have a font, and you did not want to change all the occurrences (or use a label).

Syntax:

FONTCHANGE = “old font”, “new font”

Parameters:

“old font”: the font that you want to be changed,

“new font”: the font that you want to use instead.

Example:

```
FONTCHANGE = "Calibri", "Times New Roman"
```

FONTRANGE

This command is equivalent to FONT (see page 102) but is applied to a range of cards (specified by the 1st parameter).

Syntax:

FONTRANGE = “range”, “font name”, font size, style, html color font, *html color background*, *outline x*, *outline y*, *step x*, *step y*, *char space*

Parameters:

“range”: a range of cards,

“font name”: character font name (string),

size: character font size, in typographical points (1 point = 1/72 of an inch),

style: character font style and flag used for visualization; values accepted are:

B	bold
I	italic
U	underline
S	strikeout
T	transparent font background
N	do not clip text at the boundary
C	circular text
R	circular text, reversed
H	circular text, half circumference
Q	circular text, one quarter circumference

E	circular text, three quarter circumference
Z	the text follows the curve drawn with the last BEZIER directive
F	the size is reduced until the text fits in the rectangle specified by TEXT directive
V	vertical text
P	do not clip text area beyond the rectangle
O	transparent font text (flag T is ignored)
D	the text is placed in the rectangle's diagonal (from top-left to bottom-right)
G	the text is placed in the rectangle's diagonal (from top-right to bottom-left)
A	gradient is calculated from the text instead of from the rectangle
X	the text is shrunk if too large to fit the rectangle
Y	the text is stretched if too small to fit the rectangle

html color font: character color, in the same format used for HTML. You can also specify a gradient,

html color background: background color, in the same format used for HTML. You can also specify a gradient,

outline x: horizontal expansion in cm, with that parameter the text will be replicated horizontally from $-x$ to $+x$,

outline y: vertical expansion in cm, with that parameter the text will be replicated vertically from $-y$ to $+y$,

step x: the number of times the text is printed horizontally,

step y: the number of times the text is printed vertically,

char space: spacing between characters in circular text (if not present, the text is justified).

Tip: you can choose the font with a Windows standard dialog, clicking on the button "Insert" and choosing the menu voice "Font".

FOOTER

This directive prints a text in the page's footer specified by a page range (with a syntax like cards' range).

Syntax:

FOOTER = "page range", "text", *horizontal alignment*

Parameters:

"page range": a set of pages, if empty the text is printed onto all the pages,

"text": the text to be printed, you can also use four variables:

{P}	page number
{N}	total page number
{D}	date
{T}	time

horizontal alignment: the text's horizontal alignment in the page, values accepted are:

LEFT	left aligned
CENTER	centered
RIGHT	right aligned

if not specified, the text is centered.

Examples:

FOOTER = "1-3", "Deck 1", CENTER

FOOTER = "", "printed {D} {T}", RIGHT

FOR

This directive executes the code between a FOR row and a NEXT row (see page 141), exiting when the **counter** value is equal to **end** value, starting from **start** value and adding a **step** value at each loop.

Syntax:

FOR = counter name, start, end, *step*

Parameters:

counter name: the variable counter storing the value, can be chosen between A B C E F G H I J,

start: starting value for the counter,

end: ending value for the counter,

step: increment for counter at each loop, if not specified is assumed to be 1.

Example:

```
FOR = A, 1, 4
  FOR = B, 1, 7
    RECTANGLE = 1, A, B, 1, 1, #FF0000, #0000FF
  NEXT
NEXT
```

Result: Figure 28

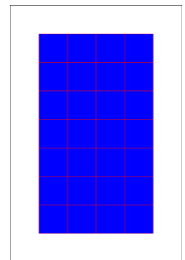

Figure 28

FRAME

This directive is used in a FRAME...ENDFRAME structure to define frames using characters in rectangular patterns, for example, if you want to define three frames, one for the card, one for an image and one for the text below, you can write these lines:

```
FRAME
AAAAAA
ABBBBA
ABBBBA
ABBBBA
ABBBBA
ACCCCA
ACCCCA
AAAAAA
ENDFRAME
```

The result is equal to these lines:

```
<A>=0%,0%,100%,100%
<B>=16.7%,14.3%,66.7%,42.9%
<C>=16.7%,57.1%,66.7%,28.6%
```

With this method, you can create 36 frames (one for each letter/number), the names are case-insensitive.

Syntax:

FRAME = *list split frames*

Parameters:

list split frames: if you add here some frames, these frames are treated individually, and are not merged in a single frame. In the last example, if you specify **B** as a parameter, instead of one frame, the program creates twelve frames (all named **B**).

GAP

This directive sets a space between cards in printed pages. If the directive **GAP** is not specified, there will be no gap between cards.

Syntax:

GAP = horizontal gap, vertical gap, *line switch*, *fill switch*, *guidelines*, *guide color*, *cross size*

Parameters:

horizontal gap: horizontal space (in cm),

vertical gap: vertical spaces (in cm).

line switch: values accepted are:

ON to enable a guideline in the middle of the gap
OFF to disable it (the default)

fill switch: values accepted are:

ON when using **CROSS** guidelines, they are prolonged across the middle of the gap
OFF the middle of the gap is not drawn (the default)

guidelines: the graphic type of the middle guideline (if present). You can choose between:

NONE	no guideline
SOLID	solid lines
DOTTED	dotted lines
DASHED	dashed lines
MARK	draws cut marks only (solid lines)
MARKDOT	draws cut marks only (dotted lines)
MARKDASH	draws cut marks only (dashed lines)
CROSS	draws cut marks and crosses (solid lines, the length is set with the 6th parameter)
CROSSDOT	draws cut marks and crosses (dotted lines, the length is set with the 6th parameter)
CROSSDASH	draws cut marks and crosses (dashed lines, the length is set with the 6th parameter)

guide color: color of the middle guideline (if present), in the same format used for HTML, same color of other guidelines if not specified

cross size: length of the arm of the cross (in cm) for **CROSS/CROSSDOT/CROSSDASH** guideline type

If the directive **GAP** is not specified, there is no gap between cards.

Example:

```
GAP = 1, 1
```

GRID

This directive draws a grid in a set of cards.

Syntax:

GRID = "range", pos x, pos y, width, height, html color, thickness, horiz. cells, vert. cells, *pattern*

Parameters:

“range”: a set of cards,

pos x: horizontal position (in cm),

pos y: vertical position (in cm),

width: width of the rectangle (in cm),

height: height of the rectangle (in cm),

html color: border color of the grid, in the same format used for HTML. You can also specify a gradient,

thickness: thickness of the grid (in cm), if set to zero, the grid’s border will be 1 pixel wide,

horiz. cells: number of horizontal cells,

vert. cells: number of vertical cells,

pattern: a pattern for the line used to draw the grid, this pattern can be composed of:

O dot
D dash
S space

These letters can be repeated, for example “OSDSOS” is a valid pattern.

Example:

```
GRID = 1, 1, 1, 4, 4, #FF0000#0000FF@90, 0.1, 3, 3
```

Result: Figure 29

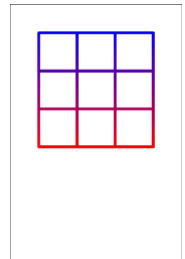

Figure 29

HEADER

This directive prints a text in the page’s header specified by a page range (with a syntax like cards’ range).

Syntax:

HEADER = “page range”, “text”, *horizontal alignment*

Parameters:

“page range”: a set of pages, if empty the text is printed onto all the pages,

“text”: the text to be printed, you can also use four variables:

{P} page number
{N} total page number
{D} date
{T} time

horizontal alignment: the text’s horizontal alignment in the page, values accepted are:

LEFT left aligned
CENTER centered
RIGHT right aligned

if not specified, the text is centered.

Examples:

```
HEADER = "1-3", "Deck 1", CENTER
```

```
HEADER = "", "printed {D} {T}", RIGHT
```

HEXGRID

This directive draws a hexagonal grid in a set of cards.

Syntax:

```
HEXGRID = "range", pos x, pos y, width, height, hex side, flags, html color, html color, thickness
```

Parameters:

"range": a set of cards,

pos x: horizontal position (in cm),

pos y: vertical position (in cm),

width: width of the rectangle (in cm),

height: height of the rectangle (in cm),

hex side: length of the hexagon' side (in cm),

flags: you can use the following flags:

D	add a dot in the center of the hexagon
L	add a letter in each hexagon (A, B, C...)
N	add a number in each hexagon (1, 2, 3...)
P	add a zero-padded number in each hexagon (01, 02, 03...)
C	add two numbers in each hexagon (11, 12, 13...21, 22, 23...)
E	add a letter and a number in each hexagon (A1, A2, A3...B1, B2, B3...)
.	add a dot as a separator for C flag
-	add a minus as a separator for C flag
_	add an underscore as a separator for C flag
X	do not draw the grid (useful if you want only a dot or a label)

html color: border color of the grid, in the same format used for HTML. You can also specify a gradient,

html color: inner color of the hexagons, in the same format used for HTML, if not specified the inner color is the same of border color. You can also specify "EMPTY" for a hollow (and transparent) hexagon or a gradient,

thickness: thickness of the grid (in cm), if omitted, the grid's border is 1 pixel wide.

Example:

```
FONT = ARIAL, 10, , #000000  
HEXGRID = 1, 0, 0, 6, 9, 1, N, #000000, #00FF00
```

Result: Figure 30

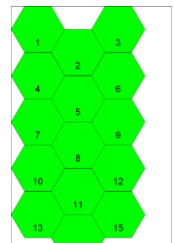

Figure 30

HTMLBORDER

This directive draws a border around a text with a specific tag (that was created with HTMLFONT directive, see page 111) to be used in HTMLTEXT directive (see page 115); this directive works only with E flag in HTMLTEXT (MS Explorer).

Syntax:

HTMLBORDER = "html tag", type, html color, thickness, *gap top*, *gap left*, *gap right*, *gap bottom*, *corner rounding*, *html color background*

Parameters:

"html tag": a name used for referencing the font,

type: the style used to draw the border, can be one of this keyword:

RECTANGLE
DOTTED
DASHED
DOUBLE
GROOVE
RIDGE
INSET
OUTSET
NONE

html color: the color of the border, in the same format used for HTML,

thickness: thickness of the border (in cm),

gap top: the gap between top border and the text, in cm,

gap left: the gap between left border and the text, in cm,

gap right: the gap between right border and the text, in cm,

gap bottom: the gap between bottom border and the text, in cm,

corner rounding: the corners of the border are rounded, the value is the radius of the circle used,

html color background: the color of the inner rectangle, in the same format used for HTML.

Example:

```
HTMLFONT = alpha, Arial, 32, , #000000
HTMLBORDER = alpha, DOTTED, #FF0000, 0.1
HTMLTEXT = 1, "this is a test", 0, 0, 100%, 100%, #FFFFFF, 0, EB, 100, alpha
```

HTMLFILE

This directive prints the HTML text loaded from a filename in the cards specified by a range.

Syntax:

HTMLFILE = "range", "html file", pos x, pos y, width, height, *html color*, *angle*, *flags*, *alpha*

Parameters:

"range": a set of cards,

"html file": the HTML filename for text to be printed (eventually with a pathname),

pos x: horizontal position (in cm),

pos y: vertical position (in cm),

width: width of the text's rectangle (in cm),

height: height of the text's rectangle (in cm),

html color: background color for text,

angle: angle of text rotation, you must specify 0 for no rotation,

flags: you can specify one or more flags, chosen between:

T	Transparent background for text
H	Horizontal mirror
V	Vertical mirror
I	HTML rendering with internal engine
A	HTML rendering with internal engine (new)
E	HTML rendering with Explorer
2	Render a x2 image (do not use if you already have an OVERSAMPLE directive)
4	Render a x4 image (do not use if you already have an OVERSAMPLE directive)
8	Render a x8 image (do not use if you already have an OVERSAMPLE directive)
R	Vertical text
B	Transparent background, better rendering of png, works only with E flag (MS Explorer)
W	Wait 100 msec
O	Replace tags also between < and >
C	Clear page after rendering (MS Explorer)
N	Use always a new instance (MS Explorer)

alpha: level of transparency of text, from 0 (full transparent) to 100 (full solid). If omitted, the level is set to 100 (full solid). You can also specify an angle for the transparency, with the format **level@angle**; in this case, the level of transparency is the starting level, ending with 0 (full transparent).

Example:

```
HTMLFILE = 1, "c:\test.html", 0, 0, 6, 9, #FFFFFF, 0, T
```

Result: Figure 31



Figure 31

HTMLFONT

This directive creates a tag that can be used for recalling a font in an HTMLTEXT directive (see page 115), for example, if the tag is **name**, the string “one <name>two</name> three” has the word “two” written with the font defined by it; tags can be nested, therefore if you want the other words to be written with **other** font, you can use the string “<other>one <name>two</name> three</other>”. If you create a tag with name **example**, in HTMLTEXT you can also assign these characteristics in an HTML text using **example** as the 11th parameter. If an alignment is specified, the program creates a “paragraph” font (a <div> tag in HTML) therefore its text is organized in a new paragraph (with a newline added when it's closed), otherwise the program creates a “text” font (a tag in HTML). In other words, if you want to use different font on the same line, it is possible only by omitting the alignment parameter. Note that for default the text in HTMLTEXT is word-wrapped, so there is not a flag to enable it. There are three special tags: **th**, **tr**, and **td**, that are used with the HTML tags of the same names (i.e. in tables).

Syntax:

HTMLFONT = tag, “font name”, font size, style, html color, *alignment*, *shadow x*, *shadow y*, *shadow blur*, *shadow color*, *outline color*, *outline width*, *indent*, *highlight color*, *char. spacing*

Parameters:

tag: a name used for referencing the font,

“font name”: character font name (string),

font size: character font size, in typographical points (1 point = 1/72 of an inch),

style: character font style and flag used for visualization; values accepted are:

B bold
I italic
U underline
S strikethrough
O shadow over outline (the default is outline over shadow)
N do not resize this font when using F flag in HTMLTEXT (see page 115)
R the outline of the font is done in a more refined way
C break lines at every character
T the HTML syntax is formatted for table cells
A small caps
M multiple shadows (use sequences for parameters from 7th to 10th)
D keep decimals in the font size calculation
L round down to integers the font size calculation
G last line aligned to the right
E last line aligned to the center
J last line justified
H automatic hyphenation (you must specify the language with an HTMLLANG directive, see page 114)
Y manual hyphenation (you must specify the syllables of a word using one or more **­** tag)
Z force the text on a single line
W the text is converted to upper case
V the text is converted to lower case
F the first letter of the text is converted to upper case, the others to lower

html color: character color, in the same format used for HTML,

alignment: the text's horizontal alignment, values accepted are:

left left aligned
 center centered
 right right aligned
 justify the text is justified

The horizontal alignment is optional, if omitted is equal to **left**,

shadow x: the horizontal offset for a shadow drawn under the text. Note: all the shadow's parameters work only with flag E, and Internet Explorer must be version 11 or more,

shadow y: the vertical offset for a shadow drawn under the text,

shadow blur: if you specify this parameter, the shadow is blurred,

shadow color: the color for the text' shadow, in the same format used for HTML,

outline color: the color for the text's outline, in the same format used for HTML,

outline width: the width for the text's outline,

indent: the indentation in cm of the first line (you can specify a negative number for hanging indentation),

highlight color: color for the background of the text, in the same format used for HTML,

char. spacing: the spacing used between each character, it can be negative.

Example:

```

HTMLFONT = alpha, Arial, 32, , #000000
HTMLFONT = beta, "Times New Roman", 18, I, #0000FF
HTMLKEY = 1, (test), test, alpha
HTMLTEXT = 1, "This is a (test)", 0, 0, 100%, 100%, #FFFFFF, 0, E, 100, beta
  
```

Result: Figure 32



Figure 32

HTMLFONTSTEP

The F flag in the HTMLTEXT directive (see page 115) works by reducing the size of the font by steps of one until the text fits in the rectangle area. This directive changes the value of the step. Note that you should not choose a value too small, because if nanDECK does not see a variation in the size of the text (i.e., the variation is small than one pixel), it stops this process.

Syntax:

HTMLFONTSTEP = "range", font size step

"range": a set of cards,

font size step: the value of the step.

HTMLIMAGE

To simplify insertion of images in HTMLTEXT directives (see page 115), you can specify a name with this directive, associated with a filename, width, and height. When an HTMLTEXT is rendered, the name is substituted with an HTML tag for the image, with the correct size.

Syntax:

HTMLIMAGE = "range", key, "image file", width, height, *flags*

"range": a set of cards,

key: the name associated to the image (replaced in HTML),

"image file": the filename for the image,

width: width of the image (in cm),

height: height of the image (in cm),

flags: you can specify one or more flags, chosen between:

P	proportional
T	image alignment to the top of text (only with Explorer)
M	image alignment to the middle of text (only with Explorer)
B	image alignment to the bottom of text (only with Explorer)
L	image alignment to the left of the rectangle, text flushing right (only with Explorer)
R	image alignment to the right of the rectangle, text flushing left (only with Explorer)
E	image alignment to the left (under other images with L flag), text flushing right (only with Explorer)
I	image alignment to the right (under other images with R flag), text flushing left (only with Explorer)
C	the replacement of the key with the image is made in a case-sensitive way
D	this image is not resized when a F flag is used in the HTMLTEXT directive
H	this image does not cause the line spacing between lines of text to increase

Example:

```
HTMLIMAGE = 1, "(one)", "image.bmp", 1, 1, P
HTMLTEXT = 1, "Test (one)", 0, 0, 6, 9, #FFFFFF, 0, T
```

HTMLKEY

With this directive, you can create words that are replaced by longer texts in HTMLTEXT directive (see page 115).

Syntax:

HTMLKEY = "range", key, "text", *htmlfont*, *flags*

"range": a set of cards,

key: a string that is searched and replaced with text parameter,

"text": a string that replaces the **key** parameter,

htmlfont: add start and end tags for a font defined by an HTMLFONT directive (see page 111),

flags: you can specify one or more of these flags:

C the replacement of the key with the text is made in a case-sensitive way

Example:

```
HTMLFONT = fnt0, Arial, 10, , #000000
HTMLFONT = fnt1, Arial, 16, , #000000
HTMLFONT = fnt2, Arial, 16, B, #FF0000
HTMLKEY = 1, (test), "only (one) word", fnt1
HTMLKEY = 1, (one), "one", fnt2
HTMLTEXT = 1, "Test (test)", 0, 0, 6, 9, #FFFFFF, 0, E, 100, fnt0
```

HTMLLANG

With this directive, you specify the language that is used for the automatic hyphenation, when the H flag is used in HTMLFONT (see page 111).

Syntax:

HTMLLANG = language

language: a string that define the language used (en, fr, de, it, etc.)

Example:

```
HTMLLANG = it
```

HTMLMARGINS

This directive adds the settings for margins and vertical alignment to an existing tag (that was created with HTMLFONT directive, see page 111) to be used in HTMLTEXT directive (see page 115); this directive works only with E flag in HTMLTEXT (MS Explorer).

Syntax:

HTMLMARGINS = "html tag", margin top, *margin left*, *margin right*, *margin bottom*, *paragraph alignment*, *line spacing*, *cell width*, *cell height*

Parameters:

"html tag": a name used for referencing the font,

margin top: the size of the top margin, in cm,

margin left: the size of the left margin, in cm,

margin right: the size of the right margin, in cm,

margin bottom: the size of the bottom margin, in cm,

paragraph alignment: the text's vertical alignment, values accepted are:

top	top aligned
center	centered
bottom	bottom aligned

line spacing: the text's line spacing in %, the default is 100 is for a single line,

cell width: the width of a table cell, in cm (it works only when T flag is used in HTMLFONT),

cell height: the height of a table cell, in cm (it works only when T flag is used in HTMLFONT).

Example:

```
HTMLFONT = alpha, Arial, 32, , #000000
HTMLMARGINS = alpha, 0.5, 1, 1
HTMLTEXT = 1, "This is a test", 0, 0, 100%, 100%, #FFFFFF, 0, EB, 100, alpha
```

*Note: using 100 as **line spacing** gives a different result from leaving that parameter empty, it is a behavior of HTML.*

HTMLTEXT

This directive prints a text, using HTML format, in the cards specified by a range. This directive is useful if you want to print a text with multiple size, font, attributes, colors and so on. For expressions, you must include them in double curly parentheses {{ ... }}. You can add also one or more images, using a keyword(s), coded with the HTMLIMAGE directive (see page 113).

Syntax:

HTMLTEXT = "range", "text", pos x, pos y, width, height, *html color*, *angle*, *flags*, *alpha*, *htmlfont*

Parameters:

"range": a set of cards,

"text": the HTML text to be printed,

pos x: horizontal position (in cm),

pos y: vertical position (in cm),

width: width of the text's rectangle (in cm),

height: height of the text's rectangle (in cm),

html color: background color for text,

angle: angle of text rotation, you must specify 0 for no rotation,

flags: you can specify one or more flags, chosen between:

T	Transparent background for text
H	Horizontal mirror
V	Vertical mirror
I	HTML rendering with internal engine
A	HTML rendering with internal engine (new)
E	HTML rendering with MS Explorer
2	Render a x2 image (do not use if you already have an OVERSAMPLE directive)
4	Render a x4 image (do not use if you already have an OVERSAMPLE directive)
8	Render a x8 image (do not use if you already have an OVERSAMPLE directive)

R Vertical text
 B Transparent background, better rendering of png, works only with E flag
 F The text is reduced to fit the rectangle, works only with E flag
 S The text is reduced to fit the rectangle and the size is saved for the next cards, works only with E flag
 J The text is enlarged to fit the rectangle, works only with E flag
 G The width is reduced to set the lines with the same length
 M The images are resized with the text, works only with EF flags
 L TEXTLIMIT variables are calculated more accurately, works only with E flag
 O Replace tags also between < and >
 C Clear page after rendering, works only with E flag
 N Use always a new instance, works only with E flag
 Y Keep the HTML file on disk, for debugging, works only with E flag
 Z Instead of a temporary file on disk, use RAM, works only with E flag

alpha: level of transparency of text, from 0 (full transparent) to 100 (full solid). If omitted, the level is set to 100 (full solid). You can also specify an angle for the transparency, with the format **level@angle**; in this case, the level of transparency is the starting level, ending with 0 (full transparent).

htmlfont: add start and end tags for a font defined by an HTMLFONT directive (see page 111)

Example:

```
[HTML] = "(text) example<br>(image) example<br>(earth) "
HTMLFONT = fnt, Arial, 10, , #000000
HTMLFONT = fntb, Arial, 10, B, #000000
HTMLKEY = 1, (text), "Text", fntb
HTMLKEY = 1, (image), "Image", fntb
HTMLIMAGE = 1, (earth), earth.jpg, 6, 6
HTMLTEXT = 1, [HTML], 0, 0, 6, 9, #FFFFFF, 0, E, 100, fnt
```

Result: Figure 33



Figure 33

ICON

This directive assigns one or more characters (a “key”) to an image, to be used later with an ICONS directive (see page 117).

Syntax:

ICON = “range”, key, “image file”, *width factor*, *height factor*

Parameters:

“range”: a set of cards,

key: one or more characters used to identify the image (like “A” or “001”),

“**image file**”: an existent image file (eventually with a path), formats allowed are bmp, gif, png, jpg, and tif,

width factor: the width of the image is adjusted with this factor, a value larger than 100 enlarge the width of the image, a value less than 100 shrink the width of the image (if not specified, the width factor of the image is 100),

height factor: the height of the image is adjusted with this factor, a value larger than 100 enlarge the height of the image, a value less than 100 shrink the height of the image (if not specified, the height factor of the image is 100).

Example:

```
ICON = "1-10", A, "c:\images\image1.jpg"
ICON = "1-10", B, "c:\images\image2.jpg"
ICON = "1-10", C, "c:\images\image3.jpg"
```

ICONS

This directive prints a number of images in a rectangular area, like a multi-image PATTERN directive (see page 144), the “keys” parameter identifies the images used, defined before with some ICON directives (see page 116). For example, if you write:

```
ICON = "1-10", A, "c:\images\image1.jpg"  
ICON = "1-10", B, "c:\images\image2.jpg"  
ICON = "1-10", C, "c:\images\image3.jpg"
```

You can use a key of “ABC” in an ICONS line to print the three images all together in a rectangular area. This directive is useful when you must convert to images an output from the combination/permutation engine. You can also use these special characters:

- < adds a *backspace* and draw two images in the same place; for example, a key like “P<2” means that the image assigned to “2” is printed over the image assigned to “P”.
- > adds a *newline*; for example, a key like “A>BB” draws first the image “A”, and two images “B” in a new line, i.e., the three images are arranged in a triangle pattern.
- _ the image corresponding to the next key is shown in the current icon space, merged with the next. For example, _A means that image A is shown in the merged space of two icons; __A means that image A is shown in the merged space of three icons.

Note: if you have a key longer than one character, these special characters must be replicated as well (i.e., with a key length of two, the special characters become “<<”, “>>”, “__”.

Syntax:

ICONS = “range”, keys, pos x, pos y, width, height, obj width, obj height, *angle, flags, horizontal alignment, vertical alignment, alpha, key length, width factor, height factor*

Parameters:

“range”: a set of cards,

keys: a string, composed by characters assigned to images with ICON directives,

pos x: horizontal position (in cm),

pos y: vertical position (in cm),

width: width of the rectangle in which the images are printed (in cm),

height: height of the rectangle in which the images are printed (in cm),

obj width: width of the single image to be printed (in cm),

obj height: height of the single image to be printed (in cm),

angle: angle of image rotation, if not specified it is assumed to be 0 (for no rotation),

flags: in this parameter, you can specify a special behavior for images, possible values are:

T	Transparent
An	Anti-aliasing
R	Reverse, reversing the filling order of pattern’s elements (from bottom to top)
N	Use PNG transparency
P	Proportional
V	Vertical pattern

horizontal alignment: the images’ horizontal alignment in the rectangle, values accepted are:

LEFT	left aligned
------	--------------

CENTER centered (the default)
 RIGHT right aligned

vertical alignment: the images' vertical alignment in the rectangle, values accepted are:

TOP top aligned
 CENTER centered (the default)
 BOTTOM bottom aligned

alpha: level of transparency of text, from 0 (full transparent) to 100 (full solid). If omitted, the level is set to 100 (full solid). You can also specify an angle for the transparency, with the format **level@angle**; in this case, the level of transparency is the starting level, ending with 0 (full transparent),

key length: the default length of the character string utilized for key is one character, but a different length can be specified here, the "keys" parameter length must be a multiple,

width factor: the width of the space for an image is adjusted with this factor, a value larger than 100 enlarge the width of the space, a value less than 100 shrink the width of the space (if not specified, the width factor of the space is 100),

height factor: the height of the space for an image is adjusted with this factor, a value larger than 100 enlarge the height of the space, a value less than 100 shrink the height of the space (if not specified, the height factor of the space is 100).

Example:

```
RECTANGLE = 1, 0, 0, 6, 6, #0000FF
ICON = 1, A, "c:\images\dot_red.gif"
ICON = 1, B, "c:\images\dot_blue.gif"
ICON = 1, C, "c:\images\dot_black.gif"
ICONS = 1, BAC, 0, 0, 6, 6, 2, 2, 0, T, CENTER, CENTER
```

Result: Figure 34

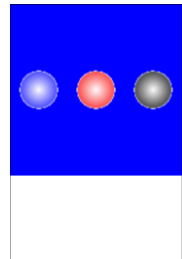

Figure 34

IF

The IF...ENDIF structure can be used to create sections of code that must be executed only if are verified some conditions.

Syntax:

```
IF = value1 operator value2
...
ELSEIF = value3 operator value4
...
ELSEIF = value5 operator value6
...
ELSE
...
ENDIF
```

Parameters:

value: a string, number, label, or expression that can be evaluated,

operator: the condition is evaluated using the two values and this operator, you can use one operator from this list:

- = value1 and value2 are equal
- > value1 is major than value2
- < value1 is minor than value2
- >= value1 is major or equal than value2
- <= value1 is minor or equal than value2
- <> value1 and value 2 are different
- @ value1 is contained into value2

value1 is not contained into value2

More than one test can be combined using Boolean logic, every test must be enclosed in parenthesis, and these are the accepted keywords:

```
_TRUE_  
_FALSE_  
_NOT_  
_AND_  
_OR_
```

If in an expression there are more than one logic operator, they are evaluated with these priorities (if they have the same priorities, they are evaluated from left to right):

- 1) `_NOT_`
- 2) `_AND_`
- 3) `_OR_`

Examples:

```
; choose a value between R, E and T  
[check] = R  
IF = [check] = R  
    RECTANGLE = 1, 0, 0, 6, 9, #0000FF  
ELSEIF = [check] = E  
    ELLIPSE = 1, 0, 0, 6, 9, #00FF00  
ELSEIF = [check] = T  
    TRIANGLE = 1, 3, 0, 6, 9, 0, 9, #FF0000  
ELSE  
    RECTANGLE = 1, 0, 0, 6, 9, #000000  
ENDIF
```

```
; complex logic  
if=([a]=1) _AND_ _NOT_ ([b]=3)  
  
; in this example, the _AND_ operator is evaluated first  
if=([a]=1) _OR_ ([b]=1) _AND_ ([c]=1)  
  
; in this example, the _OR_ operator is evaluated first  
if=(([a]=1) _OR_ ([b]=1)) _AND_ ([c]=1)
```

Note: if you want to use a sequence as argument for the IF directive, you must extract an element using the ? operator (and \$ for the number of the current card) inside an expression (with curly brackets). For example:

```
IF = {sequence?$} = element
```

IMAGE

This directive can be used to add an external image to a range of cards.

Syntax:

```
IMAGE = range, image file, pos x, pos y, width, height, angle, flag, alpha, texture width, texture height, skew x, skew y,  
img width, img height, loc x, loc y, copy x, copy y
```

Parameters:

range: a set of cards (the standard rules about ranges will be applied),

image file: an existent image file (eventually with a path), formats allowed are bmp, gif, png, jpg, and tif,

pos x: horizontal position (in cm),

pos y: vertical position (in cm),

width: width of the image (in cm),

height: height of the image (in cm),

angle: angle of image rotation, can be 0 for no rotation.

These are the required parameters. This directive can be used for a background on all your cards, or a logo on top-right, or a centered image. Simply specify range, image, position, and angle. For example:

```
IMAGE = 1, "c:\images\earth.jpg", 0, 0, 6, 9, 0
```

Result: Figure 35



Figure 35

Note that the image will fill the destination rectangle, the standard behavior of this command is resizing the original image and altering the aspect ratio for width and height. If you want to maintain the original aspect you must use a flag, as additional parameter.

```
RECTANGLE = 1, 0, 0, 6, 9, #0000FF
```

```
IMAGE = 1, "c:\images\earth.jpg", 0, 0, 6, 9, 0, P
```

Result: Figure 36



Figure 36

flag: in this parameter you can specify any, some or all these letters:

- P Proportional
- A Anti-aliasing
- G Grayscale
- H Horizontal mirror
- V Vertical mirror
- T Transparent
- X Texture
- N Use PNG transparency
- R Do not adjust size for rotated images
- D Use DPI from image file
- C Extends the image cropping the borders
- I Reads the EXIF tags for orientation from file
- U Align the image to the upper boundary of the rectangle (with P/C flag)
- E Align the image to the right boundary of the rectangle (with P/C flag)
- S Align the image to the lower boundary of the rectangle (with P/C flag)
- W Align the image to the left boundary of the rectangle (with P/C flag)

With the “P” flag, the image will be resized maintaining the original aspect ratio. The previous background remains unchanged in the zone not occupied by the image.

With the “A” flag, to the image will be applied a smoothing filter. There are no other settings related to that parameter.

With the “G” flag, the image will be reduced to tones of gray (256 levels maximum). There are no other settings related to that parameter.

With the “H” or “V” flags, the image will be mirrored in the corresponding direction (these flags may be used both with the same image).

If the “T” flag is used, the image will be rendered with a transparent color. If the CHROMAKEY directive was not used before, the transparent color is assumed to be the first pixel of the image (top left pixel). With the CHROMAKEY directive (see relative entry, page 84), you can specify a pixel from another corner, or directly a color.

With the “X” flag, the image is used to fill the destination space (see texture width/height parameters).

With the “N” flag, the image is loaded reading the transparency information (only PNG format).

Without the “R” flag, a rotated image is stretched to be fully included in the destination rectangle, with this flag, the directive maintains the original size for the rotated image.

With the “D” flag, the size of the image is adjusted reading the DPI from the file (only with BMP, PNG, and JPG formats).

With the “U”, “E”, “S”, and “W” flags (to be used with P/C flag), the image is aligned to the relative boundaries of the rectangle (if not specified, the image is centered).

alpha: level of transparency of image, from 0 (full transparent) to 100 (full solid). If omitted, the level is set to 100 (full solid). You can also specify an angle for the transparency, with the format **level@angle**; in this case, the level of transparency is the starting level, ending with 0 (full transparent), for example:

```
RECTANGLE = 1, 0, 0, 6, 9, #0000FF
IMAGE = 1, "c:\images\earth.jpg", 0, 0, 6, 9, 0, P, 100@90
```

Result: Figure 37



Figure 37

texture width: width of the texture (in cm), used only with “X” flag, if omitted the default is the image’s width,

texture height: height of the texture (in cm), used only with “X” flag, if omitted the default is the image’s height.

This is an example of using a texture to fill a space on a card (note, the alpha-channel is specified because you cannot leave the parameter empty), with texture size 1x1 cm (remember, the card is 6x9 cm):

```
IMAGE = 1, "c:\images\earth.jpg", 0, 0, 6, 9, 0, X, 100, 1, 1
```

Result: Figure 38



Figure 38

skew x: draw the image shifted horizontally (to the right for positive number, to the left for negative), the value 1 is the image’s width (you can use a decimal value),

skew y: draw the image shifted vertically (to the bottom for positive number, to the top for negative), the value 1 is the image’s height (you can use a decimal value).

This is an example for the skew effect (horizontal, value 0.5), note that the second image was vertically mirrored and printed with an alpha-channel value of 60.

```
RECTANGLE = 1, 0, 0, 6, 9, #000000
IMAGE = 1, "c:\images\earth.jpg", 0, 0, 6, 6, 0
IMAGE = 1, "c:\images\earth.jpg", 0, 6, 6, 3, 0, V, 60, 0, 0, 0.5, 0
```

Result: Figure 39



Figure 39

img width: if this parameter is specified, the image is not enlarged to the whole rectangle, but instead is drawn with this width (in cm),

img height: if this parameter is specified, the image is not enlarged to the whole rectangle, but instead is drawn with this width (in cm),

loc x: if this parameter is a positive value, the image is positioned at that % of width, with a width equal to the parameter **img width**; if this parameter is a negative one, the image is split horizontally at that % of his width, and the two halves are positioned at the edge of the rectangle,

loc y: if this parameter is a positive value, the image is positioned at that % of height, with a height equal to the parameter **img height**; if this parameter is a negative one, the image is split vertically at that % of his height, and the two halves are positioned at the edge of the rectangle,

copy x: if the image is split horizontally, the empty gap between the two halves is filled with a % of the image, starting from the cut point,

copy y: if the image is split vertically, the empty gap between the two halves is filled with a % of the image, starting from the cut point.

Tip: you can choose a name (and path) from a Windows standard dialog, clicking on the button “Insert” and choosing the menu voice “Image”.

Tip: if you drag and drop an image file in nanDECK’s window, an IMAGE line is added with the path and filename of the image.

IMAGEENC

This directive is used to start an IMAGEENC...ENDIMAGEENC structure, for including an image as encoded text directly into the script. You can encode an image file with a click on the “Insert >” button and choosing the “Image as encoding” option.

Syntax:

IMAGEENC = filename

Parameter:

filename: the filename of the image that is created with the encoded data.

Example:

```
IMAGEENC = sun.png
iVBORw0KGgoAAAANSUhEUgAAAsUAAALFCAYAAAAry54YAAAACXBIWXMAAC4jAAAuIwF4pT92AAAZIUlE
QVR42u3WWXYcOQxFQXv/
...
AwBQnigGAKA8UQwAQHmiGACA8kQxAADliWIAAMoTxQAAlCeKAQAO719v+uorjuQNjgAAAABJRU5ErkJg
gg==
ENDIMAGEENC
```

IMAGEFILTER

This directive sets the filter using when images are loaded and resized in a card (with IMAGE, ICONS, PATTERN, HTMLTEXT/HTMLFILE, RTFTEXT/RTFFILE, and OVERSAMPLE directives). If not specified, the default filter is LINEAR.

Syntax:

IMAGEFILTER = filter name

Parameter:

filter name: the filter may be one of the following:

```
NEAREST
DRAFT
LINEAR
COSINE
SPLINE
LANCZOS
MITCHELL
```

Example:

```
IMAGEFILTER=LANCZOS
```

IMAGELIMIT

This directive fills four variables with the values of the coordinates that delimit an image, specifying a background color, optionally with a threshold (zero for detecting every color different from the background, 100 for a difference between total white and total black). You can use these variables in other commands.

Syntax:

```
IMAGELIMIT = "range", pos x, pos y, width, height, html color, threshold
```

The four variables are:

```
PL    (left)
PR    (right)
PT    (top)
PB    (bottom)
```

Parameters:

"range": a set of cards,

pos x: horizontal position (in cm),

pos y: vertical position (in cm),

width: width of the area (in cm),

height: height of the area (in cm),

html color: background color for identify the image,

threshold: this parameter sets the difference between the background color and the color detected as part of the image.

IMAGESIZE

This directive reads an image and writes in two variables the image's width and height (in pixel).

Syntax:

```
IMAGESIZE = "range", "image file"
```

The variables are:

```
IW    image's width
IH    image's height
```

Parameters:

"range": a set of cards,

"Image file": an existent image file (eventually with a path), formats allowed are bmp, gif, png and jpg.

Example:

```
IMAGESIZE = 1, "c:\images\earth.jpg"
IMAGE = 1, "c:\images\earth.jpg", 0, 0, 6, 6, 0, P
FONT = Arial, 16, , #000000
TEXT = 1, "Width={IW}" ,0 ,7 ,6 ,1 ,left, center
TEXT = 1, "Height={IH}" ,0 ,8 ,6 ,1 ,left, center
```

Result: Figure 40



Figure 40

INCLUDE

This directive includes another script file in the current script, as if it were copied and pasted. You can omit the path if the included file is in the same directory of the including script.

Syntax:

```
INCLUDE = "filename"
```

Examples:

```
INCLUDE = "c:\test\alpha.txt"
```

```
INCLUDE = beta.txt
```

Tip: you can choose a name (and path) from a Windows standard dialog, clicking on the button "Insert" and choosing the menu voice "Include".

INPUTCHOICE

With this directive, the user can input a variable text that can be used as a label value, this text can be chosen between the values from a sequence. The text confirmed is stored to a file with the same name of the script and "ini" for extension, or can be saved to a specific configuration file, to be loaded in a subsequent execution.

Syntax:

```
INPUTCHOICE = "label", "description", "default", "values"
```

Parameters:

"label": the label for storing input text,

"description": a text shown before the input box,

"default": starting value for the label,

"values": a sequence with the available choices.

Example:

```
INPUTCHOICE = "color", "Choose a color, please:", "Red", "Red|Green|Blue"
```

This is the resulting input form:

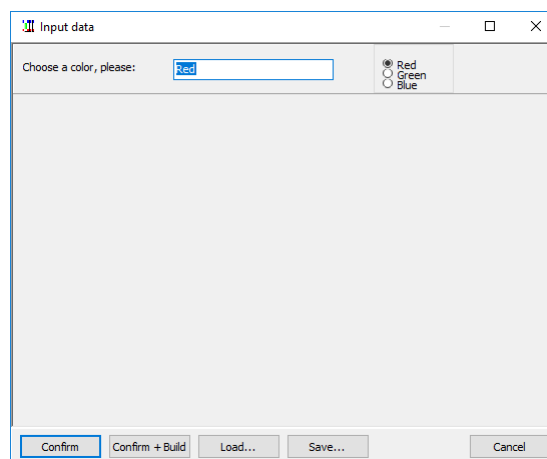

INPUTLIST

With this directive, the user can input a variable text that can be used as a label value, this text can be chosen between the values from a sequence. The text confirmed is stored to a file with the same name of the script and “ini” for extension, or can be saved to a specific configuration file, to be loaded in a subsequent execution.

Syntax:

```
INPUTLIST = “label”, “description”, “default”, “values”
```

Parameters:

“**label**”: the label for storing input text,

“**description**”: a text showed before the input box,

“**default**”: starting value for the label,

“**values**”: a sequence with the available choices.

Example:

```
INPUTLIST = "color", "Choose a color, please:", "Red", "Red|Green|Blue"
```

This is the resulting input form:

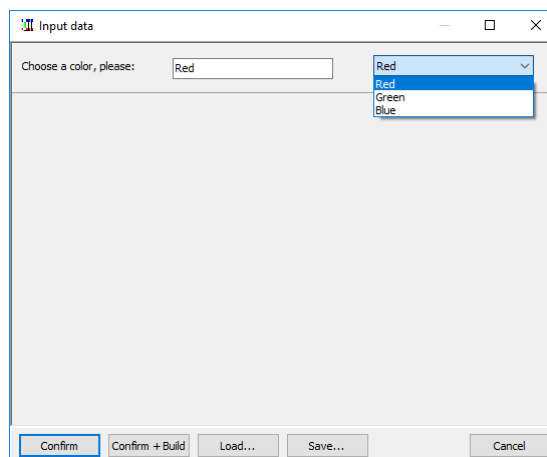

INPUTNUMBER

With this directive, the user can input a variable integer number that can be used as a label value, this number can be chosen between a minimum and a maximum value. The number confirmed is stored to a file with the same name of the script and “ini” for extension, or can be saved to a specific configuration file, to be loaded in a subsequent execution.

Syntax:

```
INPUTNUMBER = “label”, “description”, default, min, max
```

Parameters:

“**label**”: the label for storing input number,

“**description**”: a text shown before the input box,

default: starting value for the number,

min: minimum value for the number,

max: maximum value for the number.

Example:

```
INPUTNUMBER = "name", "Choose a number, please:", 5, 1, 10
```

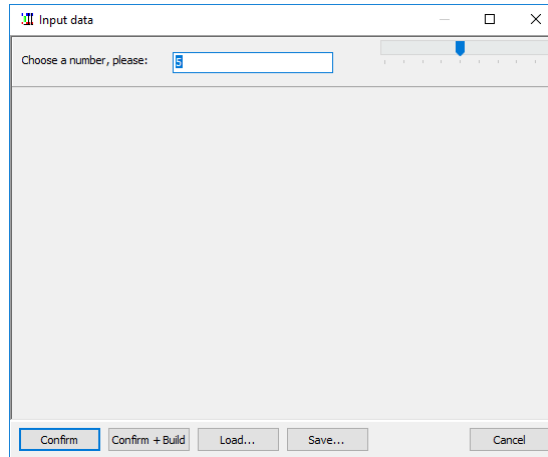

INPUTTEXT

With this directive, the user can input a variable text that can be used as a label value. The text confirmed is stored to a file with the same name of the script and “ini” for extension, or can be saved to a specific configuration file, to be loaded in a subsequent execution.

Syntax:

```
INPUTTEXT = “label”, “description”, “default”, flags
```

Parameters:

“**label**”: the label for storing input text,

“**description**”: a text showed before the input box,

“**default**”: starting value for the label.

flags: in this parameter, you can add a flag for a special effect, like:

- F The program shows a button for browsing a file (to be added in the text field),
- G The program shows a button for browsing a graphical file (to be added in the text field),
- C The program shows a button for selecting a color,
- R The program shows a button for selecting a color gradient.

Example:

```
INPUTTEXT = "name", "Input you name, please:", "John"
```

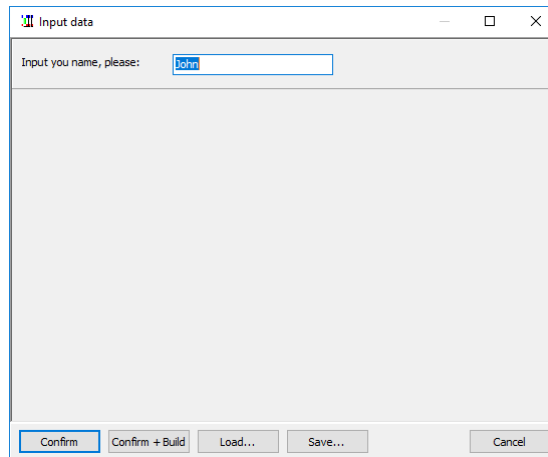

LABELMERGE

When you define a label that is already defined, the default behavior is that the current value (both single elements and sequences) replaces the existing. With this directive you change that behavior and appending instead the current value to the existing one (creating a longer sequence).

Syntax:

LABELMERGE = switch

Parameter:

switch: values accepted are:

- ON a new sequence is created, appending the current value to the former one,
- OFF the current value replaces the former one (this is the default behavior).

Note: this setting is valid also for labels read from linked files.

LAYER

The directives between a structure LAYER...ENDLAYER are drawn in a separate card, then printed on the main card (or stored for a later use). Since the drawing directives like the RECTANGLE does not support alpha transparency, they can be drawn in this mode with a LAYER structure. If you specify the 5th parameter the layer is stored in memory (using that parameter as a name) and drawn later with a LAYERDRAW directive, if the name is not specified, the layer is drawn immediately.

Syntax:

LAYER = *alpha, offset x, offset y, angle, name, width, height*

Parameters:

alpha: level of transparency of the layer, from 0 (full transparent) to 100 (full solid). If omitted, the level is set to 100 (full solid). You can also specify an angle for the transparency, with the format **level@angle**; in this case, the level of transparency is the starting level, ending with 0 (full transparent).

offset x: the horizontal offset of layer,

offset y: the vertical offset of layer,

angle: the angle of rotation of layer,

name: the name of the layer,

width: a zoom factor for stretching the image horizontally (100 is the original size),

height: a zoom factor for stretching the vertically the image (100 is the original size).

Example:

```
LAYER = 50
RECTANGLE = 1, 3, 0.5, 3, 8, #FF0000
FONT = Arial, 24, T, #000000
TEXT = 1, Alpha, 3, 5, 3, 5
ENDLAYER
```

LAYERDRAW

The directive draws a layer in a range of cards. The layer drawn is specified using its name (defined by the 5th parameter in the LAYER directive), and it must have been created before with a LAYER...ENDLAYER structure. You can also specify a list of layers, separated by commas.

Syntax:

LAYER = “range”, name, *alpha*, *offset x*, *offset y*, *angle*

Parameters:

“range”: a set of cards,

name: the name of the layer(s),

alpha: level of transparency of the layer, from 0 (full transparent) to 100 (full solid). If omitted, the level is set to 100 (full solid). You can also specify an angle for the transparency, with the format **level@angle**; in this case, the level of transparency is the starting level, ending with 0 (full transparent),

offset x: the horizontal offset of layer,

offset y: the vertical offset of layer,

angle: the angle of rotation of layer.

LIMIT

This directive fills four variables with the coordinates of latest drawn object’s boundaries (in cm), from various command (*). You can use these variables in other commands.

Syntax:

LIMIT = “range”

The four variables are:

```
PL    (left)
PR    (right)
PT    (top)
PB    (bottom)
```

Parameters:

“range”: a set of cards

(*) This directive works with this list of directives:

```
BEZIER
```

BEZIERS
BUTTON
CIRCLE
COPY
ELLIPSE
GRID
HEXGRID
HTMLFILE
HTMLTEXT
ICONS
IMAGE
LINE
LINERECT
PATTERN
PIE
POLYGON
RECTANGLE
RHOMBUS
ROUNRECT
RTFFILE
RTFTEXT
STAR
TEXT
TRACK
TRACKRECT
TRIANGLE

LINE

This directive draws a line from a point (x1, y1) to another point (x2, y2).

Syntax:

LINE = “range”, pos x1, pos y1, pos x2, pos y2, *html color*, *thickness*, *pattern*, *end arrow*, *start arrow*

Parameters:

“range”: a set of cards,

pos x1, pos y1: coordinates of first point (in cm),

pos x2, pos y2: coordinates of second point (in cm),

html color: color of the line, in the same format used for HTML (black, if not specified). You can also use a gradient,

thickness: thickness of the line (in cm), if omitted, the line is 1 pixel wide,

pattern: a pattern for the line, this pattern can be composed of:

O	dot
D	dash
S	space

These letters can be repeated, for example “OSDSOS” is a valid pattern,

end arrow: width of the arrow (in cm), if omitted (or zero) there is no arrow at the end of the line,

start arrow: width of the arrow (in cm), if omitted (or zero) there is no arrow at the start of the line.

Example:

```
LINE = 1, 1, 1, 5, 1, #0000FF#FF0000@0
```

```

LINE = 1, 1, 2, 5, 2, #0000FF#FF0000@0, 0.05
LINE = 1, 1, 3, 5, 3, #0000FF#FF0000@0, 0.1
LINE = 1, 1, 4, 5, 4, #0000FF#FF0000@0, 0.15
LINE = 1, 1, 5, 5, 5, #0000FF#FF0000@0, 0.2
LINE = 1, 1, 6, 5, 6, #0000FF#FF0000@0, 0.25
LINE = 1, 1, 7, 5, 7, #0000FF#FF0000@0, 0.3
LINE = 1, 1, 8, 5, 8, #0000FF#FF0000@0, 0.35, OSDSOS

```

Result: Figure 41



Figure 41

LINERECT

This directive draws a line from a vertex of a rectangle to the opposite vertex.

Syntax:

LINERECT = “range”, pos x, pos y, width, height, *html color*, *thickness*, *pattern*, *end arrow*, *start arrow*, *flags*

Parameters:

“range”: a set of cards,

pos x: horizontal position (in cm),

pos y: vertical position (in cm),

width: width of the rectangle (in cm),

height: height of the rectangle (in cm),

html color: color of the line, in the same format used for HTML (black if not specified). You can also use a gradient,

thickness: thickness of the line (in cm), if omitted, the line is 1 pixel wide,

pattern: a pattern for the line, this pattern can be composed of:

O	dot
D	dash
S	space

These letters can be repeated, for example “OSDSOS” is a valid pattern,

end arrow: width of the arrow (in cm), if omitted (or zero) there is no arrow at the end of the line,

start arrow: width of the arrow (in cm), if omitted (or zero) there is no arrow at the start of the line,

flags: you can specify one or more of these flags to choose which lines to draw:

T	top side
R	right side
B	bottom side
L	left side
D	diagonal from top-left to bottom-right
G	diagonal from top-right to bottom-left

If you do not specify a flag, the default is top-left to bottom-right diagonal.

Example:

```

LINERECT = 1, 1, 1, 4, 0, #0000FF#FF0000@0
LINERECT = 1, 1, 2, 4, 0, #0000FF#FF0000@0, 0.05
LINERECT = 1, 1, 3, 4, 0, #0000FF#FF0000@0, 0.1
LINERECT = 1, 1, 4, 4, 0, #0000FF#FF0000@0, 0.15

```



Figure 42

```

LINERECT = 1, 1, 5, 4, 0, #0000FF#FF0000@0, 0.2
LINERECT = 1, 1, 6, 4, 0, #0000FF#FF0000@0, 0.25
LINERECT = 1, 1, 7, 4, 0, #0000FF#FF0000@0, 0.3
LINERECT = 1, 1, 8, 4, 0, #0000FF#FF0000@0, 0.35, OSDSOS

```

Result: Figure 42

LINK

This directive is used to link data, written as a text file (CSV format) or a spreadsheet (with **xls**, **xlsx**, or extensions), with the current script. The data linked are referenced in the script as sequences. If the fields' names are omitted, the fields are referenced using the names contained in the first row of the file.

For text files, the character used to separate fields' data can be changed using the LINKSEP directive (see page 136). See also the LINKMULTI directive (page 134) if you need to duplicate the data rows, and the "Linked data editor" chapter (page 65).

Syntax for text files:

```
LINK = "filename", "field1", "field2", ... "fieldN"
```

If you omit the "filename" parameter, the program reads the data directly from the script file, until it reads a ENDLINK directive (see page 98).

Syntax for Excel files:

```
LINK = "filename!sheet", "field1", "field2", ... "fieldN"
```

Note: If you did not specify the sheet's name, the program reads the 1st sheet in the file (for example, "sheet1").

*Note: accented or foreign characters are translated in HTML codes, to be used with HTMLTEXT (see page 115). If you want to disable this feature, add a **LINKUNI=OFF** line (see page 137) before the LINK line.*

Tip: you can choose a name (and path) from a Windows standard dialog, clicking on the button "Insert" and choosing the menu voice "Link".

Tip: if you drag and drop a spreadsheet file in nanDECK's window, a LINK line is added with the path and filename of the spreadsheet.

If the spreadsheet file does not exist, the program asks if you want to create it (with the names of the fields specified in the line as the parameters field1, field2, etc).

Examples:

```

LINK = "c:\test\data01.txt"
LINK = "c:\test\data02.txt", size, speed, weight
LINK = "c:\test\data01.xls"
LINK = "c:\test\data01.xls!sheet2"

```

With the 2nd example, in the script these fields are referenced as [size], [speed] and [weight].

Example of file "data02.txt":

```

1,2,3
4,5,6
7,8,9
10,11,12

```

The program will translate the data file in these sequences:

```
[size]=1|4|7|10  
[speed]=2|5|8|11  
[weight]=3|6|9|12
```

You can also link a Google Sheet document, using the ID of the file instead of “*filename*” parameter, but you must share it first, following these steps:

- select the file in Google Drive web page,
- click the Share icon (the icon with the “little man” in top-right button bar),
- click the dropdown menu below “Link sharing on” in the window,
- select a link sharing option, one of the “Anyone with the link...” option.

Now Google shows you a link like this:

```
https://docs.google.com/spreadsheets/d/1s_p1gcL2BBO_zYIe_v8bADjWzFtc0hh_eY8DIw8OPfY/edit?usp=sharing
```

The ID of the sheet is the bold part, copy it and paste it in a nanDECK line like this:

```
LINK=1s_p1gcL2BBO_zYIe_v8bADjWzFtc0hh_eY8DIw8OPfY
```

You can also select one of the sheets, with this syntax:

```
LINK=ID!Sheet_name
```

Example:

```
LINK=1s_p1gcL2BBO_zYIe_v8bADjWzFtc0hh_eY8DIw8OPfY!Beta
```

But you must enable the web sharing, with these steps:

- open the spreadsheet in a browser,
- select from menu File → Publish to the Web,
- click on “Publish” button.

LINKCOLOR

This directive is used to create a sequence with the colors from spreadsheet’s cells; it must be used before the LINK directive (see page 131).

Syntax:

```
LINKCOLOR = label, “field”, flag
```

Parameters:

label: is the name of the sequence,

“field”: is the name of the field from the spreadsheet,

flag: it specifies if the color read is from the background or the font, if not specified is read from the background:

```
F    font  
B    background
```

LINKENCCSV

This directive is used to specify which characters are replaced with `\n` encoding (where `n` is the ASCII code) when read from a csv file with the LINK directive (see page 131). As default, there are not characters encoded.

Syntax:

LINKENCCSV = *string*

LINKENCODE

This directive is used to specify which characters are replaced with `\n` encoding (where `n` is the ASCII code) when read from a spreadsheet file with the LINK directive (see page 131). As default, characters encoded are [] { }.

Syntax:

LINKENCODE = *string*

LINKEXEC

This directive is used to specify that one or more fields in a spreadsheet linked with the LINK directive (see page 131) are used to store commands in nanDECK's scripting language (commands that are executed as they would be read from the current script). Note that if you use directives that are related to others (like FONT/TEXT) they must reside before the LINK line.

Syntax:

LINKEXEC = *field1, field2, ..., fieldN*

LINKFILL

This directive is used when you have a schema on several rows in a spreadsheet and you want to straighten it in a single row (using the first line to specify the total number of columns that will be filled with the cells); this directive must be used before the LINK command (see page 131).

Syntax:

LINKFILL = *switch*

Parameter:

switch: values accepted are:

ON to enable the redistribution of the cells
OFF to disable the redistribution of the cells (the default)

LINKFILTER

This directive is used to filter the rows in a linked file. You can specify more than one LINKFILTER directive for a linked file and must be used before the LINK directive (see page 131).

Syntax:

LINKFILTER = CLEAR | *field operator value*

Parameters:

field_name: is the name of the field for the filter,

operator: these are the possible operators used for the filter:

=	equal
>	major
<	minor
>=	major or equal
<=	minor or equal
<>	different
@	contained into
#	not contained into

value: is the value used for the filter.

Example:

Linked file:

```
Name, count
Alpha, 1
Beta, 2
Gamma, 3
```

With this script line:

```
LINKFILTER = count < 3
LINK = linked.csv
```

The resulting linked file will be:

```
Name, count
Alpha, 1
Beta, 2
```

If you want to clear all filter, you can use this directive with “CLEAR” parameter:

```
LINKFILTER = CLEAR
```

LINKFONT

This directive adds a couple of HTML tag when a different font is read from a cell in a linked spreadsheet; this directive must be used before the LINK command (see page 131).

Syntax:

```
LINKFONT = switch
```

Parameter:

switch: values accepted are:

ON	to enable the font detection
OFF	to disable the font detection (the default)

LINKMULCOPY

This directive enables/disables the copy of identical card when a linked file is preceded by the LINKMULTI directive (see page 135); this directive must be used before the LINK command (see page 131).

Syntax:

```
LINKMULCOPY = switch
```

Parameter:

switch: values accepted are:

ON to enable the copy of identical cards (the default),
OFF to disable the copy, each card is created from the script, even if it is identical to prior cards.

LINKMULDIS

When a linked file is used with a LINKMULTI directive (see page 135), you can specify with this directive one or more fields that are not replicated; instead of a replica, a single element in a sequence field is taken for each record. It must be used before the LINK directive (see page 131).

Syntax:

```
LINKMULDIS = "field1", "field2", ... "fieldN"
```

For example, if this is a linked file:

```
name, count, data  
Alpha, 1, a  
Beta, 2, b|c  
Gamma, 3, d|e
```

And you add these lines to your script:

```
LINKMULTI = count  
LINKMULDIS = data  
LINK = linked.csv
```

The resulting linked file will be:

```
name, count, data  
Alpha, 1, a  
Beta, 2, b  
Beta, 2, c  
Gamma, 3, d  
Gamma, 3, e  
Gamma, 3, d
```

Note: if a sequence is smaller than the requested number of replicated rows, it is extended (like the d|e sequence in the example, extended to d|e|d for the three rows).

Note: if you use the \$ symbol in the linked field, it gives you a count starting from one on each new row multiplied by LINKMULTI.

LINKMULTI

This directive is used to specify a field, used for identifying a multiplier for a line in a linked file. It must be used before the LINK directive (see page 131) and it must refer an existing field in the linked file (or a field specified in the LINK directive). Note that the default behavior is to copy the 1st card over the others, if instead you need that all the cards are created, use a LINKMULCOPY=OFF line before the LINKMULTI (see page 134).

Syntax:

```
LINKMULTI = field
```

The field must contain a number. For example, if this is a linked file:

```
Name, count
```

```
Alpha, 1
Beta, 2
Gamma, 3
```

And you add these lines to your script:

```
LINKMULTI = count
LINK = linked.csv
```

The resulting linked file will be:

```
Name, count
Alpha, 1
Beta, 2
Beta, 2
Gamma, 3
Gamma, 3
Gamma, 3
```

LINKNEW

This directive is used to specify a string, used in substitution for a carriage return read from a spreadsheet file with the LINK directive (see page 131). If you do not specify a LINKNEW directive in your script file, every carriage return read is replaced by `\13\`.

Syntax:

```
LINKNEW = string
```

If you want to use a linked file with an HTMLTEXT directive, you should convert all the carriage returns with the corresponding HTML code, i.e.:

```
LINKNEW = <br>
```

LINKRANDOM

This directive enables/disables the randomization of lines read with a LINK directive (see page 131), it must be used before the LINK line.

Syntax:

```
LINKRANDOM = switch
```

Parameter:

switch: values accepted are:

```
ON      To enable randomization
OFF     To disable randomization (the default)
```

Example:

```
LINKRANDOM = ON
LINK = linked.csv
```

LINKSEP

This directive is used to specify the character used in a link file to separate fields. It must be used before the LINK directive (see page 131).

If this command is omitted, is used the default separator, a comma “,”.

Syntax:

LINKSEP = separator

You can also specify a special character with the syntax `\n`. For example, for a tab you can use this line:

```
LINKSEP = \9\
```

Example:

```
LINKSEP = ;  
LINK = linked.csv
```

LINKSPLIT

This directive is used to read each line from a linked file as two different lines. It must be used before the LINK directive (see page 131).

Syntax:

LINKSPLIT = every row, odd rows, even rows

The fields specified in the 1st parameter are duplicated in two rows, those specified in the 2nd parameter are put only in the 1st row, and those specified in the 3rd parameter are put only in the 2nd row. Every parameter can contain more than one field, separated by a pipe (“|”) symbol.

LINKSTYLES

This directive is used to specify alternatives for HTML tags when reading formats from a spreadsheet file. It must be used before the LINK directive (see page 131).

If this command is omitted, the standard HTML tags are used instead.

Syntax:

LINKSTYLES = *bold on, bold off, italic on, italic off, strikethrough on, strikethrough off, underline on, underline off, superscript on, superscript off, subscript on, subscript off*

LINKTRIM

This directive enables/disables the deletion of empty rows at the end of a spreadsheet file; this directive must be used before the LINK command (see page 131).

Syntax:

LINKTRIM = switch

Parameter:

switch: values accepted are:

ON to enable the deletion of empty rows (the default)
OFF to disable the deletion of empty rows

LINKUNI

This directive enables/disables the conversion of Unicode characters when read from a spreadsheet file (to be used with an HTMLTEXT directive, see page 115); this directive must be used before the LINK command (see page 131).

Syntax:

LINKUNI = switch

Parameter:

switch: values accepted are:

ON to enable the Unicode conversion (the default)

OFF to disable the Unicode conversion

LOADPDF

This directive draws a page(s) taken from a PDF file into a range of cards. If you want to know how many pages are in the file, use the PDFPAGES function (see page 36).

Syntax:

LOADPDF = “range”, “filename”, pos x, pos y, width, height, *number*, *dpi*, *angle*

Parameters:

“**range**”: a set of cards,

“**filename**”: name of the PDF file,

pos x: horizontal position (in cm),

pos y: vertical position (in cm),

width: width of the text’s rectangle (in cm),

height: height of the text’s rectangle (in cm),

number: the page to be printed, if not specified the default is 1,

dpi: the resolution of the image, if not specified the default is 300,

angle: angle of PDF rotation, can be 0 for no rotation.

Example:

```
LOADPDF = 1-10, "nandeck-manual.pdf", 0, 0, 100%, 100%, {$}
```

LOG

This directive appends a string in a text file, if the file does not exist, it will be created. If you do not specify a value, the file is deleted instead.

Syntax:

LOG = “range”, “filename”, “*string*”

Parameters:

“**range**”: a set of cards,

“**filename**”: name of the file,

“**string**”: the string that will be written in the text file.

Example:

```
LOG = 1-10, "log.txt", "Card n° {$}"
```

MACRO

With this directive, you can create new procedures, to be used like other directives. The END directive marks the end of the new procedure, and you can specify a list of parameters, delimited with parenthesis, to be reused in the script block. You can also specify a default value for each parameter, then if you did not use a parameter when you call a macro, the default value is used instead. In a macro, you can recall another macro, but you cannot create recursive macros.

Syntax:

```
MACRO = name, (parameter1)value1, (parameter2)value2, ...
```

```
...  
END
```

Example:

```
[black] = #000000  
[red] = #FF0000  
[blue] = #0000FF  
;  
MACRO = dot, (rng), (x), (y), (r)  
    ELLIPSE = (rng), (x)-(r), (y)-(r), (r)*2, (r)*2, [red][blue]@0  
END  
;  
MACRO = shadow, (rng), (x), (y), (w), (h), (txt), (col)  
    FONTRANGE = (rng), Arial, 20, B, [black]  
    TEXT = (rng), "(txt)", (x)+0.08, (y)+0.08, (w), (h), CENTER, CENTER, 0, 50  
    FONTRANGE = (rng), Arial, 20, BT, (col)  
    TEXT = (rng), "(txt)", (x), (y), (w), (h), CENTER  
END  
;  
MACRO = card, (rng), (txt), (x), (y), (w), (h), (col)  
    shadow = (rng), (x), (y), (w), (h), (txt), (col)  
    dot = (rng), (x), (y), 0.5  
    dot = (rng), (x)+(w), (y), 0.5  
    dot = (rng), (x), (y)+(h), 0.5  
    dot = (rng), (x)+(w), (y)+(h), 0.5  
END  
;  
card = 1, "Test1", 1, 1, 4, 3, [red][blue]@0  
card = 1, "Test2", 1, 6, 2, 2, [red][blue]@0
```

Result: Figure 43

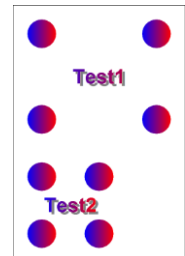

Figure 43

MARGINS

This directive sets the page's margins. If the directive MARGINS is not specified, the standard margins are 1 cm (each).

Syntax:

```
MARGINS = left margin, right margin, top margin, bottom margin, odd horiz, odd vert., even horiz., even vert.
```

Parameters:

left margin: left margin (in cm),

right margin: right margin (in cm),

top margin: top margin (in cm),

bottom margin: bottom margin (in cm),

odd horiz.: horizontal margins offset in odd pages (in cm),

odd vert.: vertical margins offset in odd pages (in cm),

even horiz.: horizontal margins offset in even pages (in cm),

even vert.: vertical margins offset in even pages (in cm).

Example:

```
MARGINS = 2, 2, 1, 1
```

MERGEPDF

This directive creates a new PDF file, you can specify a file or a sequence of files as sources, with related page ranges (the syntax for a range is, for example, "1-10,15,18,20-30"), if the result file is not already present, it is created (otherwise, it is overwritten).

Syntax:

```
MERGEPDF = "result file", "source file", "source range", rotation
```

Parameters:

“result file”: the file that is created,

“source file”: a file or a sequence of files taken as the source of the resulting file,

“source range”: a range or a sequence of ranges,

rotation: an angle or a sequence of angles (only 0, 90, 180, or 270 are accepted).

Example:

```
MERGEPDF = "result.pdf", "source1.pdf|source2.pdf", 1-10|11-20
```

MOSAIC

This directive reads all the images in a folder and arrange them in a rectangle. If the images fill more than one instance of that rectangle, you can use a **page** parameter to specify which rectangle is drawn from all the possible choices.

Syntax:

```
MOSAIC = "range", "folder", pos x, pos y, width, height, page, flags, zoom
```

Parameters:

“range”: a set of cards,

“folder”: a folder to search, eventually with a file pattern,

pos x: horizontal position (in cm),

pos y: vertical position (in cm),

width: width of the rectangle (in cm),

height: height of the rectangle (in cm),

page: if not specified, is equal to **1**,

flags: one or more of these flags

H the schema is mirrored horizontally
V the schema is mirrored vertically
S the images are read also in the subfolders

zoom: if not specified, is equal to **100**.

Example:

```
MOSAIC = 1, "images\*.png", 0, 0, 0, 100%
```

NANDECK

This directive executes another instance of the program, loads a script, render all the cards, and saves them to disk. Then the execution continues with the next line. This directive is executed only one time with each run of the script.

Syntax:

```
NANDECK = "source", output, "path", dpi, oversample, "range"
```

Parameters:

"source": another nanDECK script,

output: this flag specifies the format of the saved images; you can choose between:

BMP
JPG
PNG
GIF
GIFA
TIF
PDF

"path": the path for the saved images, if is not specified, the images are saved in the save folder of the source,

dpi: the resolution for the images (see page 60), the default is 300,

oversample: the value for the oversample (see page 142), the default is 1 (no oversample),

"range": you can specify a range if you do not want to render all the deck.

Example:

```
NANDECK = "c:\scripts\test.txt", PNG, "c:\output"
```

NEXT

This directive closes a FOR...NEXT loop (see page 106).

Syntax:

```
NEXT
```

Parameters:

none

ORIGIN

With this directive you can specify values to be added to the horizontal and vertical coordinates of all graphic directives in a range of cards.

Syntax:

ORIGIN = range, pos x, pos y, *hor. perc.*, *ver. perc.*

Parameters:

“range”: a set of cards,

pos x: the offset value for all horizontal coordinates,

pos y: the offset value for all vertical coordinates,

hor. perc.: this value is the % of the width of a card (the default is 100),

ver. perc.: this value is the % of the height of a card (the default is 100).

Example:

```
ORIGIN = 1-10, 0.5, 0.5
```

OVERSAMPLE

If you specify a parameter greater than one, the program works with cards 2x, 3x, or greater than the size specified, and then resize them to the original size, using the filter specified with IMAGEFILTER directive (see page 122). It is useful to smooth every element of the cards, especially with small size one.

Syntax:

OVERSAMPLE = number

Example:

```
OVERSAMPLE = 2
```

With this directive, the memory required (and the rendering time) is much more than usual.

PAGE

This directive sets the paper' size and orientation (for printing and PDF creation).

Syntax:

PAGE = width, height, orientation, *flags*, *html color*, *“no border range”*, *edge color*, *edge left*, *edge right*, *edge top*, *edge bottom*

Parameters:

width: page width (in cm)

height: page height (in cm)

orientation: the orientation can be chosen between:

LANDSCAPE horizontal
PORTRAIT vertical

flags: in this parameter, you can specify a special behavior for pages, possible values are:

H	the cards are horizontally centered
V	the cards are vertically centered
E	guides are not printed on even pages
O	guides are not printed on odd pages
M	the horizontal margins are mirrored in even pages
D	the page is centered (with H/V flags) without considering the edges
L	guides are not printed in the left half of the page
R	guides are not printed in the right half of the page
T	guides are not printed in the top half of the page
B	guides are not printed in the bottom half of the page

html color: paper color, in the same format used for HTML; you can also use a sequence of two or more colors, if you want a different color on each page.

no border range: if a range is specified, the border is not printed on these cards,

edge color: edge color, in the same format used for HTML; you can also use a sequence of two or more colors if you want a different color on each page.

edge left: the horizontal width of a colored area at the left edge of the page,

edge right: the horizontal width of a colored area at the right edge of the page,

edge top: the vertical height of a colored area at the top edge of the page,

edge bottom: the vertical height of a colored area at the bottom edge of the page.

If the directive PAGE is not specified, the standard is 21 x 29.7 (A4), portrait, no flags.

Example:

```
PAGE = 21, 29.7, LANDSCAPE
```

PAGEFONT

This directive changes the font's characteristics for page's headers (see page 108) and footers (see page 105). If you do not specify this directive in your script, it will be used Arial 10, black.

Syntax:

```
PAGEFONT = "font name", font size, style, html color
```

Parameters:

"font name": character's name (string),

font size: character's size (integer), in typographical points = 1/72 of an inch,

style: character' style, values accepted are:

B	bold
I	italic
U	underline
S	strikeout

html color: character's color, in the same format used for HTML.

Examples:

```
PAGEFONT = Arial, 10, B, #000000
```

```
PAGEFONT = "Times new roman", 16, IU, #FF0000
```

PAGEIMAGE

This directive draws an image centered on all the printed pages (like a watermark).

Syntax:

```
PAGEIMAGE = "image file", flags
```

Parameters:

"image file": the image to be printed,

flag: one or more of the following flags:

P	proportional
E	do not print on even pages
O	do not print on odd pages

Example:

```
PAGEIMAGE = watermark.png, P
```

<i>Note: use only .bmp or .png images</i>

PAGESHAPE

This directive draws lines, rectangles, and ellipses directly in a page (therefore there is not a range parameter, and a 100% here refers to the whole page, not to the card).

Syntax:

```
PAGESHAPE = pos x, pos y, width, height, flags, html color
```

Parameters:

pos x: horizontal position (in cm),

pos y: vertical position (in cm),

width: width of the shape (in cm),

height: height of the shape (in cm),

flags: one or more of the following flags:

A	draw a rectangle
I	draw an ellipse
S	set solid background
M	set empty background
0	set solid edge
1	set dotted edge
2	set dashed edge
3	set dash+dot pattern for edge
4	set dash+dot+dot pattern for edge
T	draw a line in the top side of the rectangle
R	draw a line in the right side of the rectangle

- B draw a line in the bottom side of the rectangle
- L draw a line in the left side of the rectangle
- H draw a horizontal line in the middle of the rectangle
- V draw a vertical line in the middle of the rectangle
- D draw a diagonal line in the rectangle
- G draw a diagonal line (reversed) in the rectangle
- E do not draw the shape on even pages
- O do not draw the shape on odd pages

html color: color of the shape, in the same format used for HTML

Example:

```
PAGESHAPE = 1, 1, 19, 27.7, MA, #0000FF
PAGESHAPE = 0.25, 0.25, 0.5, 0.5, SI, #FF0000
PAGESHAPE = 20.25, 0.25, 0.5, 0.5, SI, #FF0000
PAGESHAPE = 0.25, 28.95, 0.5, 0.5, SI, #FF0000
PAGESHAPE = 20.25, 28.95, 0.5, 0.5, SI, #FF0000
```

PATTERN

This directive prints repeated images in a rectangular area. If you want to print different images instead, you can use the ICONS directive (see page 117).

Syntax:

PATTERN = “range”, “image file”, repetition, pos x, pos y, width, height, obj width, obj height, *angle, flags, horizontal alignment, vertical alignment, alpha*

Parameters:

“**range**”: a set of cards,

“**image file**”: an existent image file (eventually with a path), formats allowed are bmp, gif, png, jpg, and tif,

repetition: the number of images printed (you can also use a sequence here),

pos x: horizontal position (in cm),

pos y: vertical position (in cm),

width: width of the rectangle in which the images are printed (in cm),

height: height of the rectangle in which the images are printed (in cm),

obj width: width of the single image to be printed (in cm),

obj height: height of the single image to be printed (in cm),

angle: angle of image rotation, if not specified it is assumed to be 0 (for no rotation),

flags: in this parameter, you can specify a special behavior for images, possible values are:

- T Transparent
- A Anti-aliasing
- R Reverse, reversing the filling order of pattern’s elements (from bottom to top)
- N Use PNG transparency
- P Proportional
- V Vertical pattern

horizontal alignment: the images’ horizontal alignment in the rectangle, values accepted are:

LEFT left aligned
 CENTER centered (the default)
 RIGHT right aligned

vertical alignment: the images' vertical alignment in the rectangle, values accepted are:

TOP top aligned
 CENTER centered (the default)
 BOTTOM bottom aligned

alpha: level of transparency of text, from 0 (full transparent) to 100 (full solid). If omitted, the level is set to 100 (full solid). You can also specify an angle for the transparency, with the format **level@angle**; in this case, the level of transparency is the starting level, ending with 0 (full transparent).

Example:

```
[img] = "c:\images\dot_red.gif"
RECTANGLE = 1, 0, 0, 6, 5, #0000FF
PATTERN = 1, [img], 5, 0, 1, 6, 3, 1.5, 1.5, 0, T, CENTER, CENTER
Result: Figure 44
```

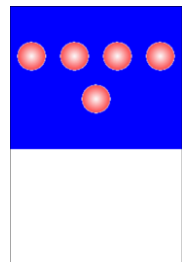

Figure 44

PIE

This directive draws a pie slice in a set of cards.

Syntax:

PIE = "range", pos x, pos y, width, height, start angle, end angle, html color, *html color*, *thickness*

Parameters:

"range": a set of cards,

pos x: horizontal position (in cm),

pos y: vertical position (in cm),

width: width of the pie (in cm),

height: height of the pie (in cm),

start angle: start angle of pie (0=north, 90=east, 180=south, 270=west)

end angle: end angle of pie (0=north, 90=east, 180=south, 270=west)

html color: border color of the pie, in the same format used for HTML. You can also specify a gradient.

html color: inner color of the pie, in the same format used for HTML, if not specified the inner color is the same of border color. You can also specify "EMPTY" for a hollow pie or a gradient.

thickness: thickness of the border of the pie (in cm), if omitted, the pie's border is 1 pixel wide.

Examples:

```
PIE = 1, 1, 3, 4, 4, 0, 90, #00FF00
Result: Figure 45
```

```
PIE = 1, 1, 3, 4, 4, 90, 270, #FF00FF, EMPTY, 0.1
Result: Figure 46
```

```
PIE = 1, 1, 3, 4, 4, 0, 270, #FF0000#0000FF@90
```

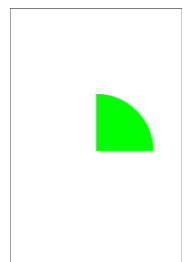

Figure 45

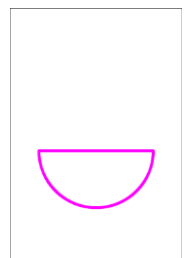

Figure 46

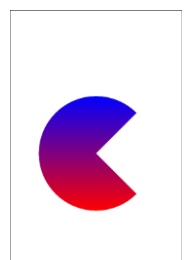

Figure 47

Result: Figure 47

POLYGON

This directive draws a polygon in a set of cards.

Syntax:

POLYGON = “range”, pos x, pos y, width, height, num sides, angle, html color, *html color*, *thickness*, *start side*, *end side*

Parameters:

“range”: a set of cards,

pos x: horizontal position (in cm),

pos y: vertical position (in cm),

width: width of the polygon (in cm),

height: height of the polygon (in cm),

num sides: number of sides (3 = triangle, 4 = square, 5 = pentagon, and so on...),

angle: angle of rotation (in degrees),

html color: border color of the polygon, in the same format used for HTML. You can also specify a gradient,

html color: inner color of the polygon, in the same format used for HTML, if not specified the inner color is the same of border color. You can also specify “EMPTY” for a hollow polygon or a gradient,

thickness: thickness of the border of the polygon (in cm), if omitted, the polygon’s border is 1 pixel wide,

start side: the polygon is drawn starting from this side, it omitted is equal to 1,

end side: the polygon is drawn until this side, if omitted is equal to **num sides**.

Examples:

```
POLYGON = 1, 1, 1, 4, 7, 3, 45, #00FF00
```

Result: Figure 48

```
POLYGON = 1, 1, 1, 4, 7, 4, 0, #FF00FF, EMPTY, 0.1
```

Result: Figure 49

```
POLYGON = 1, 1, 1, 4, 7, 5, 0, #FF0000#0000FF@90
```

Result: Figure 50

PRINT

This directive restricts the deck creation to the specified cards.

Syntax:

PRINT = “range” | DUPLEX | FOLD | COMPARE

Parameters:

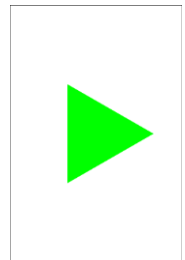

Figure 48

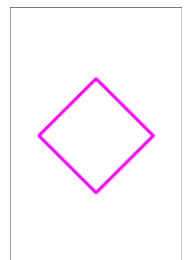

Figure 49

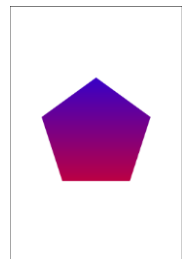

Figure 50

“range”: a range of cards. If you specify the DUPLEX parameter, the range is built using information from the DUPLEX directive (see page 95), if you specify the FOLD parameter, the range is built using information from the FOLD directive (see page 101), if you specify the COMPARE parameter, is used the range created with a COMPARE directive (see page 88).

Examples:

```
PRINT = "1-3, 8, 10-12"
```

```
PRINT = DUPLEX
```

QR CODE

This directive draws a QR Code (useful to be read with a smartphone) in a set of cards.

Syntax:

```
QR CODE = “range”, “text”, pos x, pos y, width, height, html color, html color
```

Parameters:

“range”: a set of cards,

“text”: the text written in the QR Code,

pos x: horizontal position (in cm),

pos y: vertical position (in cm),

width: width of the QR Code (in cm),

height: height of the QR Code (in cm),

html color: color of the QR Code, in the same format used for HTML, black if not specified. You can also specify a gradient,

html color: color of the background, in the same format used for HTML, white if not specified. You can also specify a gradient.

Example:

```
QR CODE = "1-10", "http://www.nandeck.com", 1, 1, 4, 4
```

RECTANGLE

This directive draws a rectangle in a set of cards.

Syntax:

```
RECTANGLE = “range”, pos x, pos y, width, height, html color, html color, thickness
```

Parameters:

“range”: a set of cards,

pos x: horizontal position (in cm),

pos y: vertical position (in cm),

width: width of the rectangle (in cm),

height: height of the rectangle (in cm),

html color: border color of the rectangle, in the same format used for HTML. You can also specify a gradient.

html color: inner color of the rectangle, in the same format used for HTML, if not specified the inner color is the same of border color. You can also specify "EMPTY" for a hollow rectangle or a gradient.

thickness: thickness of the border of the rectangle (in cm), if omitted, the rectangle's border is 1 pixel wide.

Examples:

```
RECTANGLE = 1, 1, 1, 4, 7, #00FF00
```

Result: Figure 51

```
RECTANGLE = 1, 1, 1, 4, 7, #FF00FF, EMPTY, 0.1
```

Result: Figure 52

```
RECTANGLE = 1, 1, 1, 4, 7, #FF0000#0000FF@90
```

Result: Figure 53

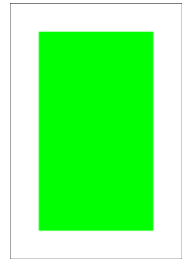

Figure 51

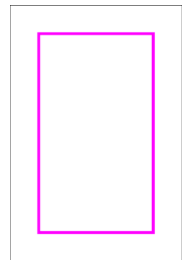

Figure 52

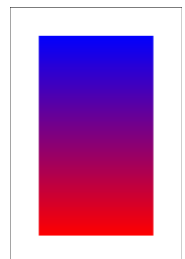

Figure 53

RENDER

With this directive, the program renders only a range of cards. If omitted, all the deck is rendered. If a **name** is specified, the range is associated with this string, and can be selected on a window, for a faster switch on multiple ranges.

Syntax:

```
RENDER = first card, last card, name
```

Examples:

```
RENDER = 10, 20
```

```
RENDER = 1, 10, "full deck"
```

```
RENDER = 1, 5, "first half"
```

```
RENDER = 6, 10, "second half"
```

RHOMBUS

This directive draws a rhombus in a set of cards.

Syntax:

```
RHOMBUS = "range", pos x, pos y, width, height, html color, html color, thickness
```

Parameters:

"range": a set of cards,

pos x: horizontal position (in cm),

pos y: vertical position (in cm),

width: width of the rhombus (in cm),

height: height of the rhombus (in cm),

html color: border color of the rhombus, in the same format used for HTML. You can also specify a gradient.

html color: inner color of the rhombus, in the same format used for HTML, if not specified the inner color is the same of border color. You can also specify “EMPTY” for a hollow rhombus or a gradient.

thickness: thickness of the border of the rhombus (in cm), if omitted, the rectangle’s border is 1 pixel wide.

Examples:

```
RHOMBUS = 1, 1, 1, 4, 7, #00FF00
```

Result: Figure 54

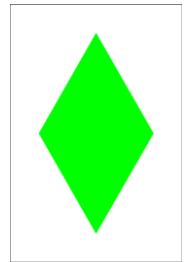

Figure 54

ROUNDRECT

This directive draws a rounded rectangle in a set of cards.

Syntax:

RECTANGLE = “range”, pos x, pos y, width, height, html color, *html color*, *thickness*, *round width*, *round height*, *flags*

Parameters:

“range”: a set of cards,

pos x: horizontal position (in cm),

pos y: vertical position (in cm),

width: width of the rounded rectangle (in cm),

height: height of the rounded rectangle (in cm),

html color: border color of the rounded rectangle, in the same format used for HTML. You can also specify a gradient,

html color: inner color of the rounded rectangle, in the same format used for HTML, if not specified the inner color is the same of border color. You can also specify “EMPTY” for a hollow rounded rectangle or a gradient,

thickness: thickness of the border of the rounded rectangle (in cm), if omitted, the rectangle’s border is 1 pixel wide,

round width: rounding horizontal factor for the rectangle (1 for a circle), if omitted the default is 5,

round height: rounding vertical factor for the rectangle (1 for a circle), if omitted the default is equal to **horizontal factor** parameter (or 5 if the latter is missing),

flags: you can specify one or more flags, chosen between:

- F The corners are calculated as specified in the prior two parameters (the default)
- R The last two parameters are the radius (horizontal and vertical) of the corners’ ellipses

Note that if you want rounded corners with the same aspect, the horizontal/vertical factors must have a ratio proportional to the width/height of the rectangle.

Examples:

```
ROUNDRECT = 1, 1, 1, 4, 7, #00FF00
```

Result: Figure 55

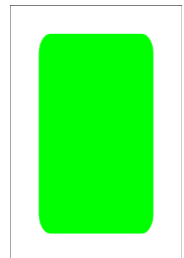

Figure 55

```
ROUNDRECT = 1, 1, 1, 4, 7, #FF00FF, EMPTY, 0.1, 2
```

Result: Figure 56

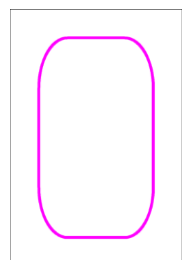

Figure 56

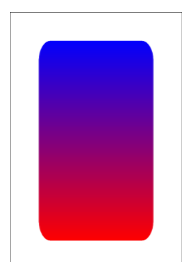

Figure 57

```
ROUNDRECT = 1, 1, 1, 4, 7, #FF0000#0000FF@90
```

Result: Figure 57

RTFFILE

This directive prints the RTF text loaded from a filename in the cards specified by a range. This directive is useful if you want to print a text from a document written using a word-processor (every program has the option to save a file in RTF format).

Syntax:

```
RTFFILE = "range", "rtf file", pos x, pos y, width, height, html color, angle, flags, alpha
```

Parameters:

"range": a set of cards,

"rtf file": the RTF filename for text to be printed (eventually with a pathname),

pos x: horizontal position (in cm),

pos y: vertical position (in cm),

width: width of the text's rectangle (in cm),

height: height of the text's rectangle (in cm),

html color: background color for text,

angle: angle of text rotation, you must specify 0 for no rotation,

flags: you can specify one or more flags, chosen between:

T	Transparent background for text
H	Horizontal mirror
V	Vertical mirror

alpha: level of transparency of text, from 0 (full transparent) to 100 (full solid). If omitted, the level is set to 100 (full solid). You can also specify an angle for the transparency, with the format **level@angle**; in this case, the level of transparency is the starting level, ending with 0 (full transparent).

Example:

```
RTFFILE = 1, "c:\temp\document.rtf", 0, 0, 6, 8, #FFFF80, 0
```

Result: Figure 58

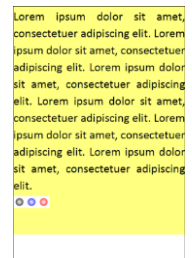

Figure 58

RTFTEXT

This directive prints a text, using RTF format, in the cards specified by a range. This directive is useful if you want to print a text with multiple size, font, attributes, colors and so on. For expression, you must include them in double curly parentheses {{ ... }}.

Syntax:

```
RTFTEXT = "range", "text", pos x, pos y, width, height, html color, angle, flags, alpha
```

Parameters:

"range": a set of cards,

“text”: the RTF text to be printed,

pos x: horizontal position (in cm),

pos y: vertical position (in cm),

width: width of the text’s rectangle (in cm),

height: height of the text’s rectangle (in cm),

html color: background color for text,

angle: angle of text rotation, you must specify 0 for no rotation,

flags: you can specify one or more flags, chosen between:

T	Transparent background for text
H	Horizontal mirror
V	Vertical mirror

alpha: level of transparency of text, from 0 (full transparent) to 100 (full solid). If omitted, the level is set to 100 (full solid). You can also specify an angle for the transparency, with the format **level@angle**; in this case, the level of transparency is the starting level, ending with 0 (full transparent).

Example:

```
RTFTEXT = 1, "{\rtf normal\par{\b bold}\par{\i italic}\par{\ul underline}}", 0, 0, 6, 6, #FFFF80, 0
```

Result: Figure 59

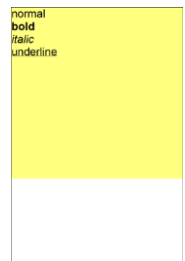

Figure 59

SAVE

This directive saves the full or partial image(s) of card(s) specified by a range in a file(s). You can use expressions like {§} to specify different filenames for different cards in the range. The image can also be loaded in another card with IMAGE directive (see page 119). The formats you can use for the image are BMP, JPG, PNG, and GIF, if you did not specify an extension for the filename, the default is BMP. If you did not specify a size, the default is all the cards.

Syntax:

SAVE = “range”, “image file”, *pos x*, *pos y*, *width*, *height*, *transparent color*, “zipfile”, “mask file”, *width pixels*, *height pixels*, *bitplanes*

Parameters:

“range”: a set of cards,

“filename”: the name of the file created,

pos x: horizontal start of saved area (in cm),

pos y: vertical start of saved area (in cm),

width: width of the saved area (in cm),

height: height of the saved area (in cm),

transparent color: for PNG and GIF, if this parameter is specified, the file is saved with this color as transparent, for PNG files you can also specify more than one color (for example #0000FF#00FF00 for two colors) and add a level of transparency, in the format #xxyyyyyy, where xx = transparency level (from 00 = full transparent to FF = full solid) and yyyyyy = color. Another format accepted is #xxyyyyyyzzz, where zzz is a number that is used as “likeness” of the color

to be treated as transparent. Finally, you can also specify a G at the end to proportionally adjust the level of transparency to the level of likeness.

“zipfile”: if this parameter is specified, the image file is added to this zip file,

“mask file”: if this parameter is specified (a PNG image), is used as transparency mask for the saved image (note that in this case the “transparent color” is not used),

width pixels: the width of the saved images, in pixels,

height pixels: the height of the saved images, in pixels,

bitplanes: sets the depth of the saved image, and can be set equal to:

24	16 millions of colors (the default),
16	65536 colors,
8	256 colors,
4	16 colors.

Examples:

```
SAVE = 1-3, "card{$}.bmp", 0, 0, 6, 9

RECTANGLE = 1, 1, 1, 4, 7, #0000FF#FF0000@90
RECTANGLE = 1, 0, 0, 6, 9, #000000, EMPTY, 0.5
SAVE = 1, "temp.bmp", 0, 0, 6, 9
IMAGE = 1, "temp.bmp", 3, 0, 3, 4.5, 0, A
```

Result: Figure 60

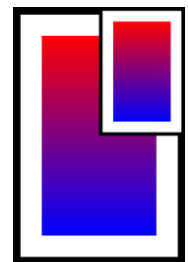

Figure 60

SAVEGIFA

This directive saves the full deck of cards in an animated GIF file specified in “filename” parameter. Note that you can use only one of this kind of directives in a script (only the last is considered).

Syntax:

SAVEGIFA = “filename”, msec, flags, transparent color

Parameters:

“filename”: the name of the file to be created (.gif extension)

msec: the delay between each frame (the default is 1000 = 1 second)

flags: one or more of the following flags

O	all the images use a single-color palette,
P	the color palette(s) are packed,
T	the frames of the image are saved with a transparent color, specified in the 4 th parameter

transparent color: the transparent color in HTML format (if not specified, is set to white) to be used with the T flag.

Example:

```
SAVEGIFA = deck.gif
```

Note: there is not a “range” parameter because only the final deck can be printed (and then exported in an animated GIF file). If you want a partial deck, use a PRINT directive.

SAVEPAGES

This directive saves the full deck of cards in one or more image files (one for each page), with names specified in “filename” parameter, adding a progressive number for each page. The file formats accepted are BMP, JPG (or JPEG), and PNG.

Syntax:

SAVEPAGE = “filename”, *switch*, *color profile*

Parameters:

“**filename**”: the name of the file(s) to be created.

The *switch* parameter can optionally be set equal to:

ON to use the CMYK color space when a JPG/JPEG file format is specified,
OFF to use the RGB color space (default).

If the former switch is ON, it can also be specified an optional *color profile* parameter, that can be an ICC/ICM file, or a JPG/JPEG (from which a color profile is extracted).

Example:

```
SAVEPAGES = page.png
```

Note: there is not a “range” parameter because only the final deck can be printed (and then exported in one or more image files). If you want a partial deck, use a PRINT directive.

SAVEPDF

This directive saves the full deck of cards in a PDF file specified in “filename” parameter. Note that you can use only one of this kind of directives in a script (only the last is considered).

Syntax:

SAVEPDF = “pdf file”, *flags*

Parameters:

“**pdf file**”: the name of the file to be created (.pdf extension)

flags: one or more of the following flags

A save the file in the PDF/A format,
J compress the images as Jpeg,
S scale down the images,
N do not use compression,
L use low level of compression,
D use default level of compression,
M use max level of compression.

Example:

```
SAVEPDF = deck.pdf
```

Note: there is not a “range” parameter because only the final deck can be printed (and then exported in a PDF file). If you want a partial deck, use a PRINT directive.

SECTION

The directives contained between SECTION and ENDSECTION directives are associated with the parameter “**text**” and can be activated or deactivated (using the **switch** parameter), this option can be selected on a window, for a faster activation/deactivation for multiple names. In this window, there are three buttons: one for enabling all the sections, one for disabling all the sections, and one (named “Cycle build”) that validates and builds in sequence all the sections (enabling only one at each cycle).

Syntax:

```
SECTION = “text”, switch, flag
```

The switch parameter can be set equal to:

ON to enable the section
OFF to disable the section

The flag parameter can be one or more of the following flags:

N this section is not included in the “Cycle build” procedure
O when this section is enabled, all the others are disabled (excluding sections with N flag)

Example:

```
SECTION = "Border", ON  
  BORDER = RECTANGLE  
ENDSECTION
```

SELECT

The SELECT...ENDSELECT structure can be used to create sections of code that must be executed only if are verified some conditions. In the default mode, a value is evaluated and only the CASE code with the same value is executed; you can also add an operator to be used for the test evaluation.

Syntax:

```
SELECT = value  
...  
CASE = value1  
...  
CASE = value2  
...  
...  
CASEELSE  
...  
ENDSELECT
```

Parameters:

value: a string, number, label, or expression that can be evaluated.

Example:

```
CARDS = 4  
[TEST] = 1|2|3|4  
SELECT = [TEST]  
CASE = 1  
  RECTANGLE = 1-4, 0, 0, 100%, 100%, #FF0000  
CASE = <4  
  ELLIPSE = 1-4, 0, 0, 100%, 100%, #0000FF  
CASEELSE
```

```
RHOMBUS = 1-4, 0, 0, 100%, 100%, #00FF00
ENDSELECT
```

SEQUENCE

This directive is used to start a SEQUENCE...ENDSEQUENCE structure, for creating one or more sequences.

Syntax:

```
SEQUENCE = label name
```

Parameters:

label name: the name of the label

Each line in this structure is added to the sequence with the name specified as a parameter.

Example:

```
SEQUENCE = Title
Earth
Moon
Mars
Venus
Jupiter
ENDSEQUENCE
```

There is an alternative syntax, for creating multiple sequences. Each line in this structure must contains the name of the sequence and a value, separated with a pipe | character. For example, this script creates five sequences of two elements each:

```
SEQUENCE =

Title           |Earth
Image           |Earth.jpg
Description     |Earth is the third planet from the Sun.
Radius          |6.371
Orbital Period |365

Title           |Moon
Image           |Moon.jpg
Description     |The Moon is Earth's only natural satellite.
Radius          |1.737
Orbital Period |26

ENDSEQUENCE
```

That script is equivalent to this:

```
[Title] = Earth|Moon
[Image] = Earth.jpg|Moon.jpg
[Description] = Earth is the third planet from the Sun.| The Moon is Earth's
only natural satellite.
[Radius] = 6.371|1.737
[Orbital Period] = 365|26
```

SET

This directive sets a label with a value. Note: since the syntax **[label]** is replaced in the validations step, if you want to read a value memorized with a SET directive, you must use the **{label?n}** syntax, where **n** is the index of the sequence (use 1 if it is a single value).

Syntax:

SET = “range”, label name, label value

Parameters:

“range”: a set of cards,

label name: the name of the label to be changed (or added, if not exists)

label value: the value of the label

SPECIAL

This directive is used to change the special symbols used for some variables.

Syntax:

SPECIAL = char cardnum, char framenum, char framename

Parameters:

char cardnum: the character used for the number of the current card (default \$).

char framenum: the character used for the number of the current frame (default °).

char framename: the character used for the name of the current frame (default μ).

Example:

```
SPECIAL = $, ^, ?
```

STAR

This directive draws a star in a set of cards.

Syntax:

STAR = “range”, pos x, pos y, width, height, num points, angle, factor, html color, *html color*, *thickness*

Parameters:

“range”: a set of cards,

pos x: horizontal position (in cm),

pos y: vertical position (in cm),

width: width of the star (in cm),

height: height of the star (in cm),

num points: number of points,

angle: angle of rotation (in degrees),

factor: from 0 (very pointy star) to 100 (polygon),

html color: border color of the star, in the same format used for HTML. You can also specify a gradient.

html color: inner color of the star, in the same format used for HTML, if not specified the inner color is the same of border color. You can also specify “EMPTY” for a hollow star or a gradient.

thickness: thickness of the border of the star (in cm), if omitted, the star’s border is 1 pixel wide.

Examples:

```
STAR = 1, 1, 1, 4, 7, 3, 0, 20, #00FF00
```

Result: Figure 61

```
STAR = 1, 1, 1, 4, 7, 5, 0, 50, #FF00FF, EMPTY, 0.1
```

Result: Figure 62

```
STAR = 1, 1, 1, 4, 7, 6, 90, 80, #FF0000#0000FF@90
```

Result: Figure 63

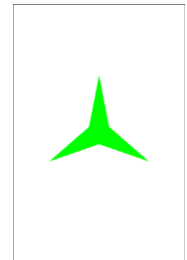

Figure 61



Figure 62

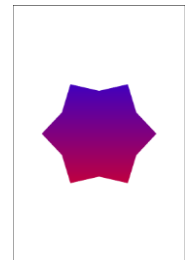

Figure 63

STORE

This directive enables/disables the storing of cards to the deck. The default behavior is that the program memorizes the images of the cards, but it can be disabled, useful when you do not want to print them or create a PDF, but need only the images, to be saved with a SAVE directive (see page 152).

Syntax:

STORE = “range”, switch

Parameters:

“range”: a range of cards,

switch: values accepted are:

ON to enable the storing of cards (the default)

OFF to disable the storing of cards

SYMBOL

This directive draws a NATO symbol in a rectangular area (to be used in a counter for a wargame); the “keys” parameter identifies the symbol used (with a code of three letters), and you can also draw more than one symbol by using a key with two or more codes.

Syntax:

SYMBOL = “range”, keys, pos x, pos y, width, height, html color, *html color*, *width*

Parameters:

“range”: a set of cards,

keys: a string, composed by codes of three characters each,

pos x: horizontal position (in cm),

pos y: vertical position (in cm),













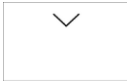
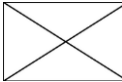

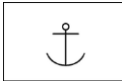
width: width of the rectangle in which the symbols are drawn (in cm),

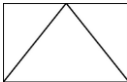
height: height of the rectangle in which the symbols are drawn (in cm),

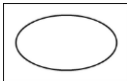
html color: color of the symbol, in the same format used for HTML. You can also specify a gradient.

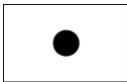
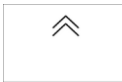
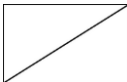
html color: background color of the symbol, in the same format used for HTML, if not specified the background color is not drawn (you can also specify "EMPTY" for the same result).

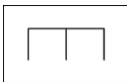
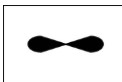
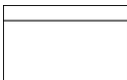
thickness: thickness of the lines used to draw the symbol (in cm), if omitted, the lines are 1 pixel wide.

Code	Description	Symbol	Code	Description	Symbol
ADE	air defense		HQ2	headquarter	
AIM	airmobile		INF	infantry	
AIR	airborne		MAR	marine	
AMP	amphibious		MOT	motorized	
ANT	anti-tank		MTN	mountain	
ARM	armor		PAR	paratrooper	
ART	field artillery		ROC	rocket	
CAV	cavalry		WHE	wheeled	
ENG	engineer		WIF	fixed wing	
HQ1	headquarter		WIR	rotary wing	

Example:

`SYMBOL = 1, INFMTN, 10%, 10%, 80%, 50%, #000000, EMPTY, 2%`

TABLE

This directive opens the virtual table (see page 66) at the end of the building process.

Syntax:

`TABLE = num draw, flags`

Parameters:

num draw: the number of cards drawn when you double click a deck,

flags: you can choose these flags:

R the drawn card is placed at the right of the deck

L	the drawn card is placed at the left of the deck
U	the drawn card is placed at the top of the deck
B	the drawn card is placed at the bottom of the deck
O	the drawn position is rotated
P	the drawn position is randomized
A	enable the alignment to grid
C	show the canvas as a background image
S	automatic selection of object
T	show the tags
F	bring the selected object to the front
M	move complete stacks of cards

TAG

This directive assigns a label and a numeric value to a card (or a range of cards). This tag is shown in the Virtual Table (see page 66) when a card is put in a specific location of the table (if more than one card is in one location, the values of all the tags with the same name are added up).

Syntax:

TAG = "range", tag, number

Parameters:

"range": a set of cards,

tag: the name of the tag,

number: the value of the tag (it can be a sequence of values).

Examples:

TAG = 1-10, card, 1

TAG = 1-20, value, 1|2|3|4|5

TAGS

This directive creates a rule that is evaluated in the Simulator. The rule can contain series of letters of numbers, with this syntax:

- one or more "\$" symbol, then letters to define a tag's value that is present, using the same letter means that the same element is present with that number of copies,
- one or more "£" symbol, then numbers to define the difference between the values of tag when multiple copies are present (i.e., in a straight); with the !N>M syntax is defined that a tag with value N is treated also like M (i.e., the ace in a straight can be positioned before the 2 or after the King),
- one or more "=" symbol, then one or more tags that must be present.

You can specify more than one rule for a single directive, all of which will be evaluated at the same time, by separating each rule (and each tag) with the pipe character "|".

Syntax:

TAGS = tag, schema, *name of schema*

Parameters:

tag: the name of the tag used in the schema,

schema: letters and numbers that define a rule that is evaluated,

name of schema: the name of the schema used in the simulator.

Example:

```
TAG = 1-52, value, 1|2|3|4|5|6|7|8|9|10|11|12|13
TAG = 1-13, seed, 1
TAG = 14-26, seed, 2
TAG = 27-39, seed, 3
TAG = 40-52, seed, 4
TAGS = suite|value, $aaaaa|==1011121301, Royal flush
TAGS = suite|value, $aaaaa|£1111!1>14, Straight flush
TAGS = value, $aaaab, Four of a kind
TAGS = value, $aabbb, Full house
TAGS = seed, $aaaaa, Flush
TAGS = value, £1111!1>14, Straight
TAGS = value, $aaabc, Three of a kind
TAGS = value, $aabbc, Two pairs
TAGS = value, $aabcd, One pair
TAGS = value, $abcde, No pair
```

TEXT

This directive writes a text on a range of cards. The font used is specified using FONT (see page 102) or FONTRANGE (see page 104) command.

Syntax:

TEXT = “range”, “text”, pos x, pos y, width, height, *horizontal alignment*, *vertical alignment*, *angle*, *alpha*, *outline width*, *circle offset*, *circle angle*, *width factor*, *height factor*

Parameters:

“range”: a set of cards,

“text”: the text to be printed,

pos x: horizontal position (in cm),

pos y: vertical position (in cm),

width: width of the rectangle used to draw the text (in cm), you can specify a negative number for a text mirrored horizontally,

height: height of the rectangle used to draw the text (in cm), you can specify a negative number for a text mirrored vertically,

horizontal alignment: the text’s horizontal alignment in the rectangle, values accepted are:

left	left aligned
center	centered
right	right aligned

The horizontal alignment is optional, if omitted is equal to **center**.

vertical alignment: the text’s vertical alignment in the rectangle, values accepted are:

top	top aligned
center	centered
bottom	bottom aligned
wordwrap	the text is top aligned and word-wrapped in the rectangle
wwtop	the text is top aligned and word-wrapped in the rectangle
wwcenter	the text is center aligned and word-wrapped in the rectangle
wwbottom	the text is bottom aligned and word-wrapped in the rectangle

charwrap the text is centered, spaced and word-wrapped (every character) in a pattern

The vertical alignment is optional, if omitted is equal to **center**.

angle: angle of text rotation, if omitted is 0 (no rotation),

alpha: level of transparency of text, from 0 (full transparent) to 100 (full solid). If omitted, the level is set to 100 (full solid). You can also specify an angle for the transparency, with the format **level@angle**; in this case, the level of transparency is the starting level, ending with 0 (full transparent),

outline width: if you specify a number, the font is drawn as outlined, with this number as line's width,

circle offset: if you specify a number, this is the offset for a circular text (from 0 to 100), the default is 25,

circle angle: if you specify a number, this is the angle of each letter in a circular text, the default is 0,

width factor: if you specify a number, the text is horizontally stretched (the default is 100),

height factor: if you specify a number, the text is vertically stretched (the default is 100).

If you want a more flexible command for text, you can use HTMLTEXT (with HTMLFONT, HTMLMARGINS, HTMLIMAGE, and HTMLKEY). With these commands, you can use multiple fonts, sizes, colors, images, justified alignment and more (anything you can write with an HTML editor).

Tip: you can choose a single specific symbol or character from a visual form, clicking on the button "Insert" and choosing the menu voice "Symbol".

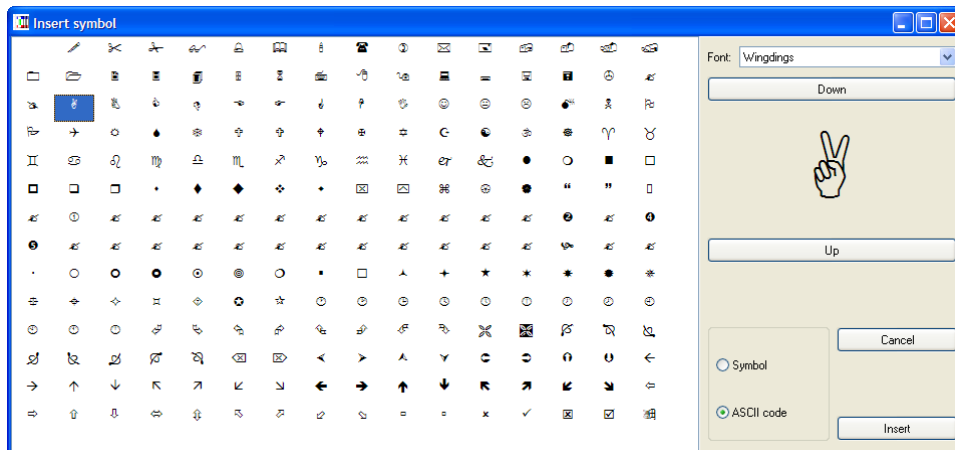

Examples:

```
RECTANGLE = 1, 1, 1, 4, 7, #0000FF
FONT = Arial, 16, T, #FFFFFF
TEXT = 1, "center-top", 1, 1, 4, 2, center, top
TEXT = 1, "center-center", 1, 3, 4, 3, center, center
TEXT = 1, "center-bottom", 1, 6, 4, 2, center, bottom
```

Result: Figure 64

```
RECTANGLE = 1, 1, 1, 4, 7, #0000FF
FONT = Arial, 16, T, #FFFFFF
TEXT = 1, "left-top", 1, 1, 4, 2, left, top
TEXT = 1, "left-center", 1, 3, 4, 3, left, center
TEXT = 1, "left-bottom", 1, 6, 4, 2, left, bottom
```

Result: Figure 65

```
RECTANGLE = 1, 1, 1, 4, 7, #0000FF
FONT = Arial, 16, T, #FFFFFF
TEXT = 1, "right-top", 1, 1, 4, 2, right, top
```

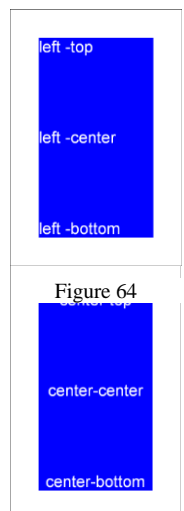

Figure 65

```
TEXT = 1, "right-center", 1, 3, 4, 3, right, center
TEXT = 1, "right-bottom", 1, 6, 4, 2, right, bottom
```

Result: Figure 66

```
[test] = "Lorem ipsum dolor sit amet, consectetur adipiscing elit.
Aenean fermentum ipsum eu sapien."
RECTANGLE = 1, 1, 1, 4, 7, #0000FF
FONT = Arial, 12, T, #FFFFFF
TEXT = 1, [test], 1, 1, 4, 7, left, wvtop
```

Result: Figure 68

```
[test] = "Lorem ipsum dolor sit amet, consectetur adipiscing elit.
Aenean fermentum ipsum eu sapien."
RECTANGLE = 1, 1, 1, 4, 7, #0000FF
FONT = Arial, 12, T, #FFFFFF
TEXT = 1, [test], 1, 1, 4, 7, center, wvcenter
```

Result: Figure 67

```
[test] = "Lorem ipsum dolor sit amet, consectetur adipiscing elit.
Aenean fermentum ipsum eu sapien."
RECTANGLE = 1, 1, 1, 4, 7, #0000FF
FONT = Arial, 12, T, #FFFFFF
TEXT = 1, [test], 1, 1, 4, 7, right, wvbottm
```

Result: Figure 69

TEXTFONT

This directive writes a text on a range of cards, it uses the parameters both from TEXT (see page 160) and FONT (see page 102) directives.

Syntax:

TEXTFONT = "range", "text", pos x, pos y, width, height, *horizontal alignment*, *vertical alignment*, *angle*, *alpha*, "font name", font size, style, html color font, html color background, outline width, circle offset, circle angle, char space

TEXTLIMIT

This directive fills four variables with the coordinates of latest drawn text's boundaries (in cm), from TEXT command (see page 160). You can use these variables in other commands.

Syntax:

TEXTLIMIT = "range"

The four variables are:

```
TL    (left)
TR    (right)
TT    (top)
TB    (bottom)
```

Parameters:

"range": a set of cards

Example:

```
FONT = Arial, 16, , #000000
TEXT = 1, "This is a test", 0, 0, 6, 2, center, center
TEXTLIMIT = 1
LINE = 1, TL, 0, TL, 2, #000000, 0.05
```

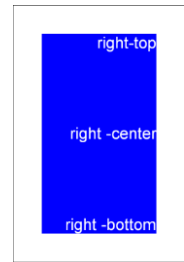

Figure 66

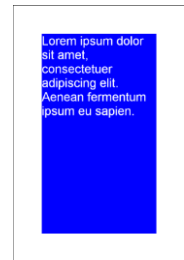

Figure 67

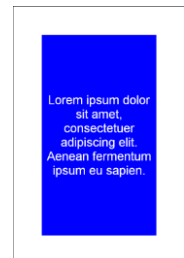

Figure 68

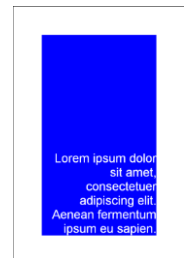

Figure 69

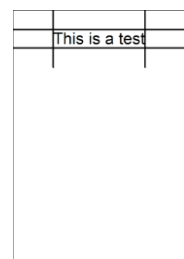

Figure 70

```
LINE = 1, TR, 0, TR, 2, #000000, 0.05
LINE = 1, 0, TT, 6, TT, #000000, 0.05
LINE = 1, 0, TB, 6, TB, #000000, 0.05
```

Result: Figure 70

THREADS

When the deck is built, if you specify a number different from one, nanDECK executes n copies of itself that render a section of the current deck. The main program waits until all the sections are complete and loads them in the current deck. With a multithreaded CPU, the result is a shorter time for building a deck.

Syntax:

```
THREADS = number
```

Parameter:

number: the number of threads that must be used.

Example:

```
THREADS = 4
```

*Note: this method works if the cards are made independently each other, it cannot be used if in the script there are keywords like **COPYCARD** or **DUPLEX**.*

TOKEN

This directive prepares a token to be used in the “Virtual table” option (see page 66). A token in the Virtual table can be a simple counter with a text that can be moved or stacked, or a dice that can be rolled to obtain random values.

Syntax:

```
TOKEN = “formula”, width, height, font color, back color, number, pos x, pos y, sequence, starting frames, frames, rules
```

Parameters:

“formula”: the text visualized in the token, can be an empty string or it can be used an expression. If you use an expression with a “d” for a random value, it can be rolled like a die with a double-click of the mouse on the token itself,

width: width of the token (in pixels), you can also specify a % of the screen width,

height: height of the token (in pixels), you can also specify a % of the screen height,

font color: font color in the same format used for HTML,

back color: background color in the same format used for HTML,

number: the number of tokens (one, if not specified), if more than one the tokens are stacked together on the table,

pos x: horizontal position for the token (in pixels), you can also specify a % of the screen’s width,

pos y: vertical position for the token (in pixels), you can also specify a % of the screen’s height,

sequence: a sequence of images from which is extracted the image shown on the token (the position of the image extracted is specified in the formula as a number, and it can be a random value),

starting frames: if specified, the token is placed in a frame randomly taken from this list,

frames: when a token is moved on the table, it is positioned in the nearest frame from this list,

rules: when a token is moved on the table, are enforced the rules specified in this list (see page 66 for a list of rules).

Examples:

```
TOKEN = "{1d6}", 50, 50, #FFFFFF, #0000FF
```

```
TOKEN = "$", 100, 50, #FFFFFF, #00FF00, 10
```

TRACK

This directive draws a racetrack section from a point (x1, y1) to another point (x2, y2).

Syntax:

TRACK = “range”, pos x1, pos y1, pos x2, pos y2, track width, html color, *num lanes*, *num spaces*, *flags*, *thickness*, *left factor*, *right factor*, *pattern*

Parameters:

“**range**”: a set of cards,

pos x1, **pos y1**: coordinates of first point (in cm),

pos x2, **pos y2**: coordinates of second point (in cm),

track width: width of the track (in cm),

html color: color of the track, in the same format used for HTML. You can also specify a gradient,

num lanes: the number of the lanes that compose the track, the minimum is one.

num spaces: the number of spaces long the track, the minimum is one.

flags: you can choose these flags:

S	the track section is closed at the start
E	the track section is closed at the end
H	even lanes are drawn forward one-half space
L	the track is linked, using a line, to the last track drawn on the same card
C	the track is linked, using a curve, to the last track drawn on the same card
R	do not draw external right link
F	do not draw external left link

thickness: thickness of the track’s line (in cm), if omitted, the line is 1 pixel wide,

left factor: for curved link, this parameter set the width of the curve, for the left side of the track,

right factor: for curved link, this parameter set the width of the curve, for the right side of the track,

pattern: a pattern for the track’s line, this pattern can be composed of:

O	dot
D	dash
S	space

These letters can be repeated, for example “OSDSOS” is a valid pattern.

Example:

```
TRACK = 1, 1, 8, 5, 1, 1, #000000, 3, 4, SE, 0.1
```

Result: *Figure 71*

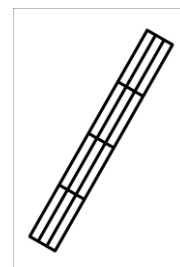

Figure 71

TRACKRECT

This directive draws a racetrack section from a vertex of a rectangle to the opposite vertex.

Syntax:

TRACK = “range”, pos x, pos y, width, height, track width, html color, *num lanes*, *num spaces*, *flags*, *thickness*, *left factor*, *right factor*, *pattern*

Parameters:

“range”: a set of cards,

pos x: horizontal position (in cm),

pos y: vertical position (in cm),

width: width of the rectangle (in cm),

height: height of the rectangle (in cm),

track width: width of the track (in cm),

html color: color of the track, in the same format used for HTML. You can also specify a gradient,

num lanes: the number of the lanes that compose the track, the minimum is one.

num spaces: the number of spaces long the track, the minimum is one.

flags: you can choose these flags:

S	the track section is closed at the start
E	the track section is closed at the end
H	even lanes are drawn forward one-half space
L	the track is linked, using a line, to the last track drawn on the same card
C	the track is linked, using a curve, to the last track drawn on the same card
R	do not draw external right link
F	do not draw external left link

thickness: thickness of the track’s line (in cm), if omitted, the line is 1 pixel wide,

left factor: for curved link, this parameter set the width of the curve, for the left side of the track,

right factor: for curved link, this parameter set the width of the curve, for the right side of the track,

pattern: a pattern for the track’s line, this pattern can be composed of:

O	dot
D	dash
S	space

These letters can be repeated, for example “OSDSOS” is a valid pattern.

TRIANGLE

This directive draws a triangle in a set of cards.

Syntax:

TRIANGLE = “range”, pos x1, pos y1, pos x2, pos y2, pos x3, pos y3, html color, *html color*, *thickness*

Parameters:

“range”: a set of cards,

pos x1, pos y1: coordinates of 1st point (in cm),

pos x2, pos y2: coordinates of 2nd point (in cm),

pos x3, pos y3: coordinates of 3rd point (in cm),

html color: border color of the triangle, in the same format used for HTML. You can also specify a gradient.

html color: inner color of the triangle, in the same format used for HTML, if not specified the inner color is the same of border color. You can also specify “EMPTY” for a hollow triangle or a gradient.

thickness: thickness of the border of the triangle (in cm), if omitted, the triangle’s border is 1 pixel wide.

Examples:

```
TRIANGLE = 1, 1, 8, 3, 1, 5, 8, #00FF00
```

Result: Figure 72

```
TRIANGLE = 1, 1, 8, 3, 1, 5, 8, #FF00FF, EMPTY, 0.1
```

Result: Figure 73

```
TRIANGLE = 1, 1, 8, 3, 1, 5, 8, #FF0000#0000FF@90
```

Result: Figure 74

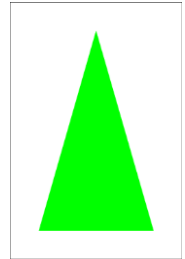

Figure 72

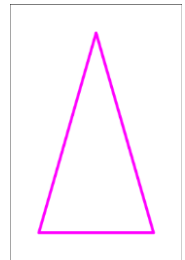

Figure 73

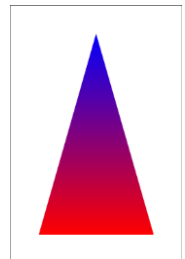

Figure 74

UNIT

This directive chooses a unit to be used with all the numeric size in the script. For a correct use, it is better to include it in the first line of the script. The default size unit, if UNIT is not used, is the “cm”.

Syntax:

UNIT = type

Parameters:

type: the type of unit can be chosen between:

CM

MM

INCH

Example:

```
UNIT = inch
```

Tip: instead of using absolute values, you can always specify a size (in every directive) as a fraction of the whole card, using number followed by the percentage “%”.

VECTOR

This directive draws an SVG file in a set of cards.

Syntax:

VECTOR = “range”, “image file”, pos x, pos y, width, height, *angle*, *alpha*, *flags*

Parameters:

“**range**”: a set of cards,

“**image file**”: an existent .svg image file (eventually with a path),

pos x: horizontal position (in cm),

pos y: vertical position (in cm),

width: width of the image (in cm),

height: height of the image (in cm),

angle: angle of image rotation, can be 0 for no rotation,

alpha: level of transparency of image, from 0 (full transparent) to 100 (full solid). If omitted, the level is set to 100 (full solid),

flags: you can choose these flags:

I use the internal engine (default)

E use Inkscape for image’s rendering (you must specify the path in the Config window)

Example:

```
VECTOR=1-10, test.svg, 0, 0, 4, 4
```

Note: with the internal engine, the SVG file specifications are not fully implemented, some issues exist (for example, in gradient fill).

VISUAL

This directive is used to open a VISUAL...ENDVISUAL structure (see “Visual editor”, page 68).

Syntax:

VISUAL = *flags*, *horizontal steps*, *vertical steps*

Parameters:

flags: you can choose these flags:

H show the horizontal ruler

V show the vertical ruler

G show the grid

P snap to the grid when you move an object

S snap to the grid when you resize an object

horizontal steps: number of horizontal steps for the grid,

vertical steps: number of vertical steps for the grid.

VORONOI

This directive draws a Voronoi diagram in a card. To specify the points, you use frames with a color as 5th parameter (you can also use a gradient with multiple colors or add the “strength” of the point after a % symbol); the color can also be specified with a TAGFRAME function.

Syntax:

VORONOI = “range”, pos x, pos y, width, height, frames, *flags*

Parameters:

“range”: a set of cards,

pos x: horizontal position (in cm),

pos y: vertical position (in cm),

width: width of the image (in cm),

height: height of the image (in cm),

frames: the frames used to plot points; you can use * in the name,

flags: you can choose these flags:

E the distances are measured using an “Euclidean” formula (square root and powers)

M the distances are measured using a “Manhattan” formula (absolute differences)

R the colors are drawn with a gradient calculated using RGB color space

H the colors are drawn with a gradient calculated using HSB color space

Example:

```
<vor01> = 2, 2, 0, 0, #FF0000
<vor02> = 4, 2, 0, 0, #00FF00
<vor03> = 2, 7, 0, 0, #0000FF
<vor04> = 4, 7, 0, 0, #00FFFF
<vor05> = 3, 4.5, 0, 0, #FFFF00
VORONOI = 1, 1, 1, 4, 7, voro*
```

ZOOM

This directive changes the size of cards (all elements, FONT included). Useful to change the result without having to modify all the data. If omitted, is 100 (and there is no change in size). You can specify a 2nd parameter for vertical zoom if it is different from horizontal one.

Syntax:

ZOOM = width, *height*

Examples:

```
;half size
ZOOM = 50
```

```
;double size
ZOOM = 200
```

Code examples

Wargame counters

```

cardsize=2,2
dpi=600
linkmulti=number
link=data.txt

[back_ger]=#C0C0C0
[front_ger]=#000000
[out_ger]=#808080

[back_fre]=#8ADDF4
[front_fre]=#000000
[out_fre]=#808080

macro=outline,(range1),(text1),(frame),(font1),(size1),(col1),(col2),(col3)
font=(font1),(size1),,(col3),(col2),0.01,0.01
text=(range1),(text1),(frame)
font=(font1),(size1),T,(col1),(col2)
text=(range1),(text1),(frame)
end

[all]=1-{(number)}
<cnt_all>=0,0,2,2
<val_lft>=0.25,1.25,0.5,0.75
<val_cnt>=0.75,1.25,0.5,0.75
<val_rgt>=1.25,1.25,0.5,0.75
<val_id>=0.25,0,1.5,0.25
<img_cnt>=0.45,0.3,1.1,0.9
<img_cnt2>=0.6,0.5,0.8,0.5
rectangle=[all],0,0,2,2,[back_[nation]]

outline=[all],[combat],<val_lft>,Arial,16,[front_[nation]],[back_[nation]],[out_[nation]]
outline=[all],[movement],<val_rgt>,Arial,16,[front_[nation]],[back_[nation]],[out_[nation]]
if=[command]<>0
outline=[all],[command],<val_cnt>,Arial,16,[front_[nation]],[back_[nation]],[out_[nation]]
endif
outline=[all],[id],<val_id>,Arial,7,[front_[nation]],[back_[nation]],[out_[nation]]
if=[type]=inf
line=[all],<img_cnt,PTL>,<img_cnt,PBR>,[front_[nation]],0.04
line=[all],<img_cnt,PBL>,<img_cnt,PTR>,[front_[nation]],0.04
line=[all],<img_cnt,PTL>,<img_cnt,PBR>,[out_[nation]],0.02
line=[all],<img_cnt,PBL>,<img_cnt,PTR>,[out_[nation]],0.02
endif
if=[type]=cav
line=[all],<img_cnt,PBL>,<img_cnt,PTR>,[front_[nation]],0.04
line=[all],<img_cnt,PBL>,<img_cnt,PTR>,[out_[nation]],0.02
endif
if=[type]=arm
ellipse=[all],<img_cnt2>,[front_[nation]],EMPTY,0.04
ellipse=[all],<img_cnt2>,[out_[nation]],EMPTY,0.02
endif
if=[type]=hq
outline=[all],HQ,<img_cnt>,Arial,16,[front_[nation]],[back_[nation]],[out_[nation]]
endif
rectangle=[all],<img_cnt>,[front_[nation]],"empty",0.05
rectangle=[all],<img_cnt>,[out_[nation]],"empty",0.02

```

Data file (data.txt):

```

nation,type,combat,movement,command,id,number
fre,inf,3,3,0,XXX,2
fre,cav,2,5,0,XX,2
fre,arm,4,4,0,XXX,2
fre,arm,5,4,0,XXX,2
fre,hq,1,4,3,"De Gaulle",1
ger,inf,3,3,0,XXX,2
ger,inf,3,3,0,XXXX,2
ger,arm,6,5,0,XXX,2
ger,arm,5,4,0,XXX,2
ger,hq,1,5,3,Rommel,1

```

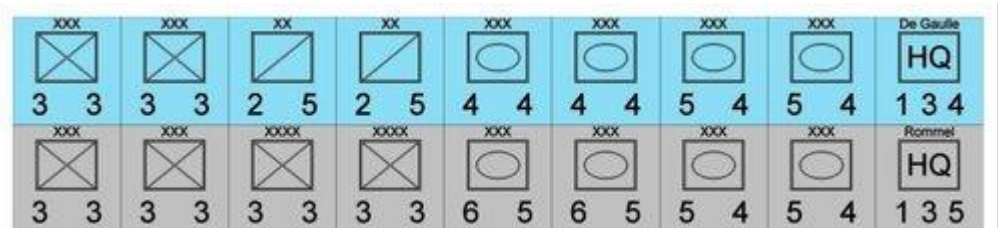

Dice results

```
cardsize=18,3
border=rectangle
zoom=50
[all]=1-36
```

```
<d4>=0,0,3,3
<d6>=3,0,3,3
<d8>=6,0,3,3
<d10>=9,0,3,3
<d12>=12,0,3,3
<d20>=15,0,3,3
```

```
[col]=#000000
```

```
font=Arial,32,T,[col]
```

```
polygon=[all],<d4>,3,0,[col],EMPTY,0.1
text=[all],"{1d4}",<d4>
```

```
polygon=[all],<d6>,4,45,[col],EMPTY,0.1
text=[all],"{1d6}",<d6>
```

```
polygon=[all],<d8>,4,0,[col],EMPTY,0.1
text=[all],"{1d8}",<d8>
```

```
line=[all],9,1,10.5,0,[col],0.1
line=[all],10.5,0,12,1,[col],0.1
line=[all],12,1,10.5,3,[col],0.1
line=[all],10.5,3,9,1,[col],0.1
text=[all],"{1d10}",<d10>
```

```
polygon=[all],<d12>,5,0,[col],EMPTY,0.1
text=[all],"{1d12}",<d12>
```

```
polygon=[all],<d20>,3,90,[col],EMPTY,0.1
text=[all],"{1d20}",<d20>
```

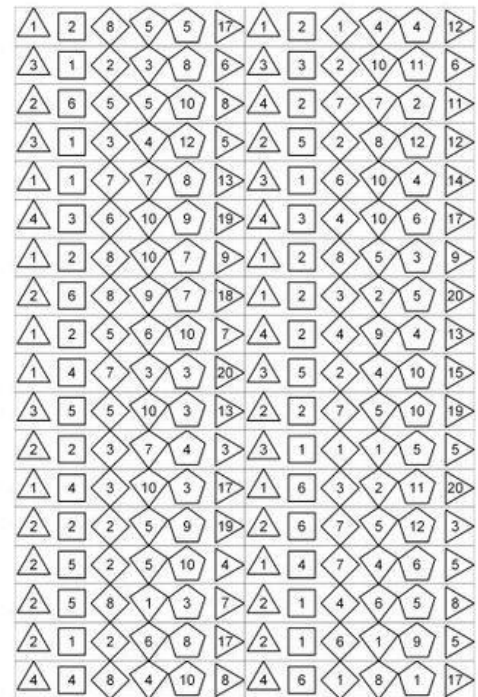

Score track

```
unit=inch
canvassize=15,15

[side_a]=framebox(0,0,14,1,1,1,C)
[side_b]=framebox(14,0,1,14,1,1,C)
[side_c]=framebox(1,14,14,1,1,1,C)
[side_d]=framebox(0,1,1,14,1,1,C)

rectangle=0,<side*>,#000000,empty

font=arial,16,T,#000000
text=0,"{-1}",<side_a*>
text=0,"{13+°}",<side_b*>,center,center,90
text=0,"{26+16-°}",<side_c*>,center,center,180
text=0,"{40+16-°}",<side_d*>,center,center,270

save=0,"board.png"0,0,15,15
```

0	1	2	3	4	5	6	7	8	9	10	11	12	13	14
15														15
16														16
17														17
18														18
19														19
20														20
21														21
22														22
23														23
24														24
25														25
26														26
27														27
28	29	30	31	32	33	34	35	36	37	38	39	40	41	28

Boggle dice

```
N[a]=01|02|03|04|05|06|07|08|09|10|11|12|13|14|15|16
[range]=1-{(a)}
[d01]=LRYTTE
[d02]=VTHRWE
[d03]=EGHWNE
[d04]=SEOTIS
[d05]=ANAEEG
[d06]=IDSYTT
[d07]=OATTOW
[d08]=MTOICU
[d09]=AFPKFS
[d10]=XLDERI
[d11]=HCPOAS
[d12]=ENSIEU
[d13]=YLDEVVR
[d14]=ZNRNHL
[d15]=NMIQHU
[d16]=OBBAOJ
CARDSIZE = 4.5, 4.5
FONT = Arial, 96, , #000000
TEXT = [range], [[d[a]]:d6,1], 0, 0, 100%, 100%
RECTANGLE = [range], 0, 0, 100%, 100%, #0000FF, EMPTY, 10%
```

N	S	R	O
V	O	V	L
E	O	S	E
I	T	H	E

Catan map

```
canvassize=35,35
[sea]=framehex(0,0,35,35,3,C)
[map]=framedisk(sea43,sea41)
'sea
polygon=0,<sea*>,6,90,#000000,#0000FF,0.1
'field
polygon=0,<4~!map*>,6,90,#000000,#CEC90B,0.1
'forest
polygon=0,<4~!map*>,6,90,#000000,#008000,0.1
'pasture
polygon=0,<4~!map*>,6,90,#000000,#80FF00,0.1
'mountain
polygon=0,<3~!map*>,6,90,#000000,#80FF00,0.1
'hill
polygon=0,<3~!map*>,6,90,#000000,#C0C0C0,0.1
'desert
polygon=0,<3~!map*>,6,90,#000000,#800000,0.1
'hill
polygon=0,<3~!map*>,6,90,#000000,#800000,0.1
'desert
polygon=0,<~!map*>,6,90,#000000,#FFFF80,0.1
save=0,"catan.jpg",0,0,35,35
```

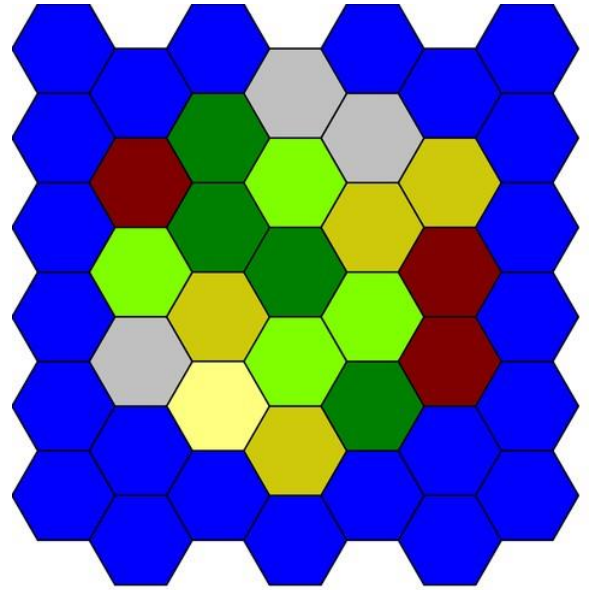

Clock

```
cardsize = 10,10
[clock] = frameclock(1, 1, 8, 8, 2, 2, 12)
ellipse = 1, <clock*>, #CCCCCC
font = Arial, 32, T, #000000
text = 1, "{°}", <clock*>, center, center, °*360/12

layer = 50
;hours
[hour] = frameclock(2, 2, 6, 6, 1, 1, 12)
line = 1, 5, 5, <hour4, PCC>, #FF0000, 0.6

;minutes
line = 1, 5, 5, <clock2, PCC>, #0000FF, 0.4
endlayer
```

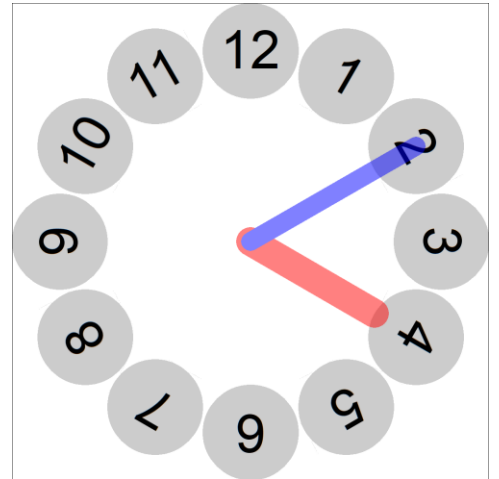

Hex board

```
page=21.59,27.94,portrait,hv
cardsize=16,24
border=none
[base]=framehex(0,0,16,24,0.85,C)
[hex01]=frameline(base0101,base0111)
[hex02]=frameline(base0201,base0211)
[hex03]=frameline(base0302,base0312)
[hex04]=frameline(base0402,base0412)
[hex05]=frameline(base0503,base0513)
[hex06]=frameline(base0603,base0613)
[hex07]=frameline(base0704,base0714)
[hex08]=frameline(base0804,base0814)
[hex09]=frameline(base0905,base0915)
[hex10]=frameline(base1005,base1015)
[hex11]=frameline(base1106,base1116)
polygon=1,<hex*>,6,90,#000000,EMPTY,0.1
```

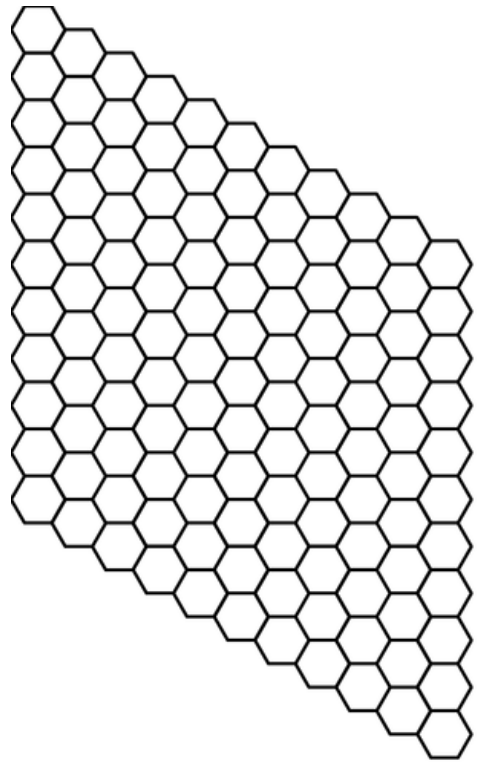

Triangle map

```
canvassize=21,27
[h]=framehex(0,0,21,27,1,C)
star=0,<h*>,6,90,1,#000000,EMPTY,0.05
hexgrid=0,0,0,21,27,1,,#000000,EMPTY,0.05
save=0,"triangle.png",0,0,21,27
```

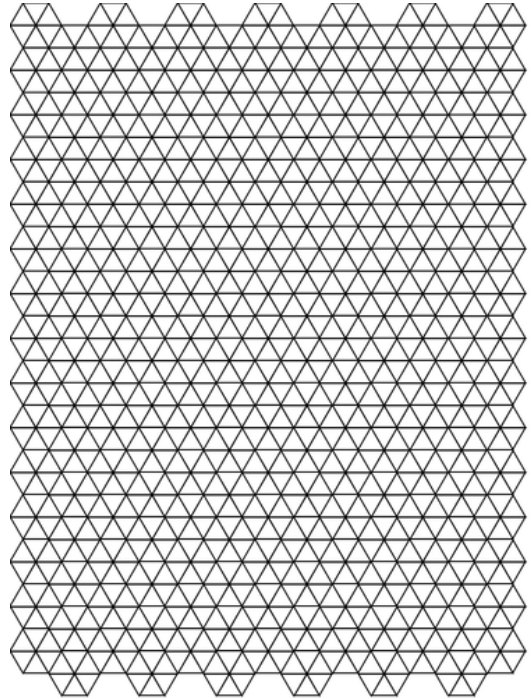

Chess board

With font "Chess Cases". Link: <http://www.enpassant.dk/chess/fonteng.htm#CASES>

```

canvassize=18,18
[ch]=framebox(1,1,16,16,2,2,E)
{[ch_white]=framelist(cha1, chc1, che1, chg1, chb2, chd2, chf2, chh2, cha3, chc3, che3, chg3, chb4, chd4, chf4, chh4,
cha5, chc5, che5, chg5, chb6, chd6, chf6, chh6, cha7, chc7, che7, chg7, chb8, chd8, chf8, chh8) }
{[ch_black]=framelist(chb1, chd1, chf1, chh1, cha2, chc2, che2, chg2, chb3, chd3, chf3, chh3, cha4, chc4, che4, chg4,
chb5, chd5, chf5, chh5, cha6, chc6, che6, chg6, chb7, chd7, chf7, chh7, cha8, chc8, che8, chg8) }
rectangle=0,<ch_white>,#EEEEEE
rectangle=0,<ch_black>,#BBBBBB
[tt]=framebox(1,0,16,1,2,1,N)
[tb]=framebox(1,17,16,1,2,1,N)
[t1]=framelist(tt1,tb1)
[t2]=framelist(tt2,tb2)
[t3]=framelist(tt3,tb3)
[t4]=framelist(tt4,tb4)
[t5]=framelist(tt5,tb5)
[t6]=framelist(tt6,tb6)
[t7]=framelist(tt7,tb7)
[t8]=framelist(tt8,tb8)
[s1]=framebox(0,1,1,16,1,2,N)
[sr]=framebox(17,1,1,16,1,2,N)
[s1]=framelist(s11,sr1)
[s2]=framelist(s12,sr2)
[s3]=framelist(s13,sr3)
[s4]=framelist(s14,sr4)
[s5]=framelist(s15,sr5)
[s6]=framelist(s16,sr6)
[s7]=framelist(s17,sr7)
[s8]=framelist(s18,sr8)
font=arial,16,,#000000
text=0,a,<t1>
text=0,b,<t2>
text=0,c,<t3>
text=0,d,<t4>
text=0,e,<t5>
text=0,f,<t6>
text=0,g,<t7>
text=0,h,<t8>
text=0,8,<s1>
text=0,7,<s2>
text=0,6,<s3>
text=0,5,<s4>
text=0,4,<s5>
text=0,3,<s6>
text=0,2,<s7>
text=0,1,<s8>
font="chess cases",48,T,#000000
[wpa]=p
[wkn]=n
[wbi]=b
[wro]=r
[wqu]=q
[wki]=k
[bpa]=o
[bkn]=m
[bbi]=v
[bro]=t
[bqu]=w
[bki]=l
text=0,[wpa],<ch?7>
text=0,[wro],<cha8>
text=0,[wkn],<chb8>
text=0,[wbi],<chc8>
text=0,[wqu],<chd8>
text=0,[wki],<che8>
text=0,[wbi],<chf8>
text=0,[wkn],<chg8>
text=0,[wro],<chh8>
text=0,[bpa],<ch?2>
text=0,[bro],<cha1>
text=0,[bkn],<chb1>
text=0,[bbi],<chc1>
text=0,[bqu],<chd1>
text=0,[bki],<che1>
text=0,[bbi],<chf1>
text=0,[bkn],<chg1>
text=0,[bro],<chh1>
save=0,chessboard2.png,0,0,18,18

```

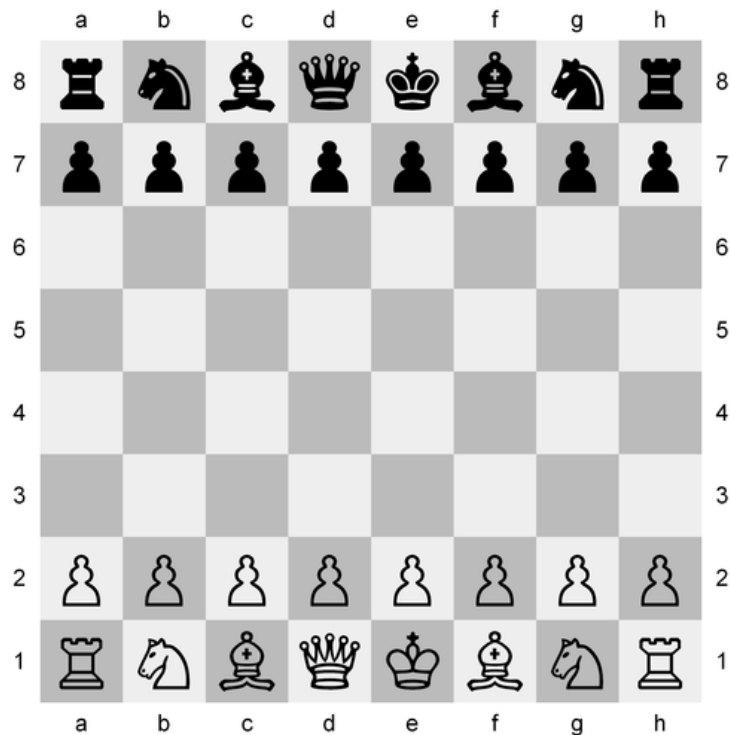

Trivia cards

```
linkmulti=num
link="q&a.txt"
[all]="1-{"id}"
[card_id]=join("Card #",[id])
[background]=#D0D0D0
[ink]=#000000
[col_q]=#FFFF80
[col_a]=#80FF80
rectangle=[all],0,0,100%,100%,[background]
font=arial,16,,[ink],[background]
text=[all],[card_id],0,0,100%,20%,center,center
roundrect=[all],5%,20%,90%,35%,#000000,[col_q],0.1
font=arial,12,,[ink],[col_q]
text=[all],[question],10%,22%,80%,31%,left,wordwrap
roundrect=[all],5%,60%,90%,35%,#000000,[col_a],0.1
font=arial,12,,[ink],[col_a]
text=[all],[answer],10%,62%,80%,31%,left,wordwrap
```

Data file (q&a.txt):

```
id,num,question,answer
1,1,"This is question #1","This is answer #1"
2,1,"This is question #2","This is answer #2"
3,1,"This is question #3","This is answer #3"
4,1,"This is question #4","This is answer #4"
5,1,"This is question #5","This is answer #5"
6,1,"This is question #6","This is answer #6"
7,1,"This is question #7","This is answer #7"
8,1,"This is question #8","This is answer #8"
9,1,"This is question #9","This is answer #9"
10,1,"This is question #10","This is answer #10"
```

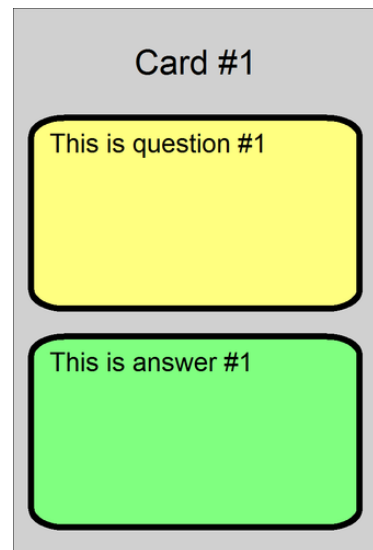

Hex racetrack

```
canvassize=42,44  
[hexa]=framehex(0,0,42,44,1,C)  
[hexb]=framedisk(hexa1412,hexa0112)  
[hexc]=framedisk(hexa1412,hexa0912)  
[hexd]=framesub(hexb*,hexc*)  
polygon=0,<hexd*>,6,90,#000000,EMPTY,0.1  
save=0,"track.png",0,0,42,44
```

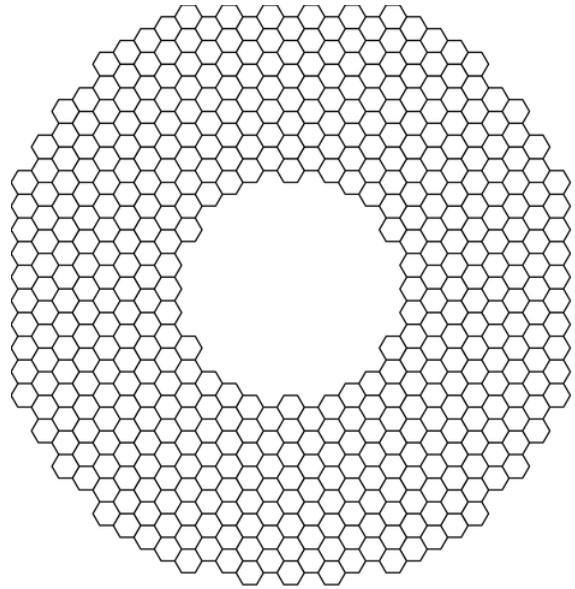

Tuckbox

```

[img1]=none
[img2]=none
INPUTTEXT="wid","Width (cm)","6"
INPUTTEXT="hei","Height (cm)","9"
INPUTTEXT="dep","Depth (cm)","3"
INPUTCHOICE="extra","Add extra lines","Yes","Yes|No"
INPUTTEXT="img1","Box image (front)","",G
INPUTTEXT="img2","Box image (rear)","",G

[fla]=[dep]/2
[ide]=[fla]/2
[coll]=#000000
[col2]=EMPTY
[thi]=0.1

'Uncomment the following line for A4 paper
PAGE=21,29.7, PORTRAIT, HV

'Uncomment the following line for Letter paper
'PAGE=21.59,27.94, PORTRAIT, HV

BORDER=NONE
CARDSIZE=[fla]+[dep]+[hei]+[dep]+[fla],[dep]+[wid]+[dep]+[wid]+[fla]

IF=[img1]=none
ELSE
    IMAGE=1,[img1],[fla]+[dep],[dep],[hei],[wid],90,P
ENDIF

IF=[img2]=none
ELSE
    IMAGE=1,[img2],[fla]+[dep],[dep]+[wid]+[dep],[hei],[wid],90,P
ENDIF

RECTANGLE=1,[fla]+[dep],0,[hei],[dep],[coll],[col2],[thi]
RECTANGLE=1,[fla],[dep],[dep],[wid],[coll],[col2],[thi]
RECTANGLE=1,[fla]+[dep],[dep],[hei],[wid],[coll],[col2],[thi]
RECTANGLE=1,[fla]+[dep]+[hei],[dep],[dep],[wid],[coll],[col2],[thi]
RECTANGLE=1,[fla]+[dep],[fla]+[dep],[dep]+[wid],[hei],[dep],[coll],[col2],[thi]
RECTANGLE=1,[fla]+[dep],[dep]+[wid]+[dep],[hei],[wid],[coll],[col2],[thi]

LINE=1,[fla]+[dep],0,[fla]+[dep]-[fla],[ide],[coll],[thi]
LINE=1,[fla]+[dep]-[fla],[ide],[fla]+[dep]-[fla],[dep]-[ide],[coll],[thi]
LINE=1,[fla]+[dep]-[fla],[dep]-[ide],[fla]+[dep],[dep],[coll],[thi]

LINE=1,[fla]+[dep]+[hei],0,[fla]+[dep]+[hei]+[fla],[ide],[coll],[thi]
LINE=1,[fla]+[dep]+[hei]+[fla],[ide],[fla]+[dep]+[hei]+[fla],[dep]-[ide],[coll],[thi]
LINE=1,[fla]+[dep]+[hei]+[fla],[dep]-[ide],[fla]+[dep]+[hei],[dep],[coll],[thi]

LINE=1,[fla],[dep],[fla]-[fla],[dep]+[ide],[coll],[thi]
LINE=1,[fla]-[fla],[dep]+[ide],[fla]-[fla],[dep]+[wid]-[ide],[coll],[thi]
LINE=1,[fla]-[fla],[dep]+[wid]-[ide],[fla],[dep]+[wid],[coll],[thi]

LINE=1,[fla]+[dep]+[hei]+[dep],[dep],[fla]+[dep]+[hei]+[dep]+[fla],[dep]+[ide],[coll],[thi]
LINE=1,[fla]+[dep]+[hei]+[dep]+[fla],[dep]+[ide],[fla]+[dep]+[hei]+[dep]+[fla],[dep]+[wid]-[ide],[coll],[thi]
LINE=1,[fla]+[dep]+[hei]+[dep]+[fla],[dep]+[wid]-[ide],[fla]+[dep]+[hei]+[dep],[dep]+[wid],[coll],[thi]

LINE=1,[fla]+[dep],[dep]+[wid],[fla]+[dep]-[fla],[dep]+[wid]+[ide],[coll],[thi]
LINE=1,[fla]+[dep]-[fla],[dep]+[wid]+[ide],[fla]+[dep]-[fla],[dep]+[wid]+[dep]-[ide],[coll],[thi]
LINE=1,[fla]+[dep]-[fla],[dep]+[wid]+[dep]-[ide],[fla]+[dep],[dep]+[wid]+[dep],[coll],[thi]

LINE=1,[fla]+[dep]+[hei],[dep]+[wid],[fla]+[dep]+[hei]+[fla],[dep]+[wid]+[ide],[coll],[thi]
LINE=1,[fla]+[dep]+[hei]+[fla],[dep]+[wid]+[ide],[fla]+[dep]+[hei]+[fla],[dep]+[wid]+[dep]-[ide],[coll],[thi]
LINE=1,[fla]+[dep]+[hei]+[fla],[dep]+[wid]+[dep]-[ide],[fla]+[dep]+[hei],[dep]+[wid]+[dep],[coll],[thi]

LINE=1,[fla]+[dep],[dep]+[wid]+[dep]+[wid],[fla]+[dep]+[ide],[dep]+[wid]+[dep]+[wid]+[fla],[coll],[thi]
LINE=1,[fla]+[dep]+[ide],[dep]+[wid]+[dep]+[wid]+[fla],[fla]+[dep]+[hei]-[ide],[dep]+[wid]+[dep]+[wid]+[fla],[coll],[thi]
LINE=1,[fla]+[dep]+[hei]-[ide],[dep]+[wid]+[dep]+[wid]+[fla],[fla]+[dep]+[hei],[dep]+[wid]+[dep]+[wid],[coll],[thi]

IF=[extra]=Yes
    LINE=1,[fla]+[dep]+[hei]-[fla],[dep],[fla]+[dep]+[hei]-[fla],[dep]+[wid],[coll],[thi],DSS
    {
        BEZIER=1,
        [fla]+[dep]+[hei],[dep]+[wid]+[dep]+[wid]/2-[ide],
        [fla]+[dep]+[hei]-[ide],[dep]+[wid]+[dep]+[wid]/2-[ide],
        [fla]+[dep]+[hei]-[ide],[dep]+[wid]+[dep]+[wid]/2+[ide],
        [fla]+[dep]+[hei],[dep]+[wid]+[dep]+[wid]/2+[ide],
        [coll],[thi]}
    }
ENDIF

```

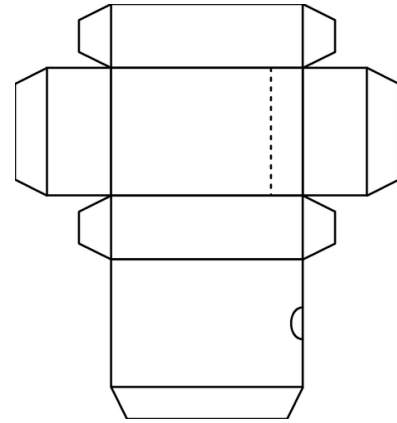

Number wheel

```
[size]=3.5
[numbers]=45
unit=inch
cardsize=[size],[size]
[num]=frameclock(0.1,0.1,[size]-0.2,[size]-0.2,0.3,0.3,[numbers])
[green]=framelist(num1..num15)
[yellow]=framelist(num16..num30)
[red]=framelist(num31..num45)
font=arial,12,T,#000000
ellipse=1,<green>,#00FF00
ellipse=1,<yellow>,#FFFF00
ellipse=1,<red>,#FF0000
text=1,{^-1},<num*>,center,center,°*360/[numbers]-90
ellipse=1,0,0,100%,100%,#000000,empty,0.01
ellipse=1,48%,48%,4%,4%,#000000,empty,0.01
save=1,"wheel_col.png",0,0,100%,100%
```

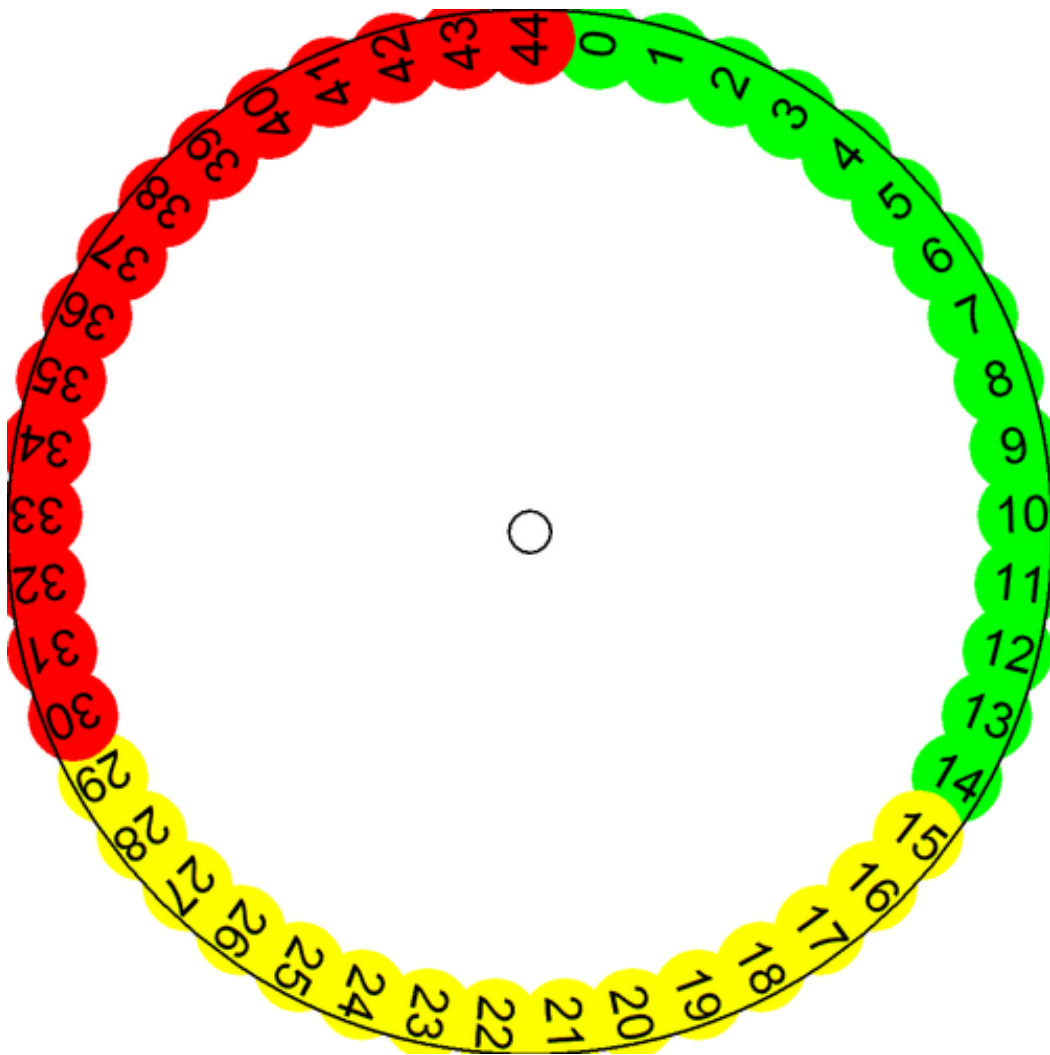

Tripples tiles

cardsize=2,2

```
'draw and save an image (an arrow)
line=0,1 ,0.2,1 ,1 ,#000000,0.15
line=0,1 ,0.2,1.2,0.4,#0000FF,0.15
line=0,1.2,0.4,0.8,0.4,#0000FF,0.15
line=0,0.8,0.4,1 ,0.2,#0000FF,0.15
save=0,"arrow.bmp",0,0,2,2
```

```
'create all the permutations (256) of two elements (0 and 1) taken eight times
pr[perm]8=0|1
'takes only the tiles with three '1'
[tiles]=filter(+[perm],3)
```

```
[all]=1-{(tiles)}
'draws a dot
ellipse=[all],0.95,0.05,0.1,0.1,#000000
'draws the eight arrows
if=[tiles:8,1]=1
    image=[all],"arrow.bmp",0,0,2,2,0,T
endif
if=[tiles:7,1]=1
    image=[all],"arrow.bmp",-0.5,-0.5,3,3,45,T
endif
if=[tiles:6,1]=1
    image=[all],"arrow.bmp",0,0,2,2,90,T
endif
if=[tiles:5,1]=1
    image=[all],"arrow.bmp",-0.5,-0.5,3,3,135,T
endif
if=[tiles:4,1]=1
    image=[all],"arrow.bmp",0,0,2,2,180,T
endif
if=[tiles:3,1]=1
    image=[all],"arrow.bmp",-0.5,-0.5,3,3,225,T
endif
if=[tiles:2,1]=1
    image=[all],"arrow.bmp",0,0,2,2,270,T
endif
if=[tiles:1,1]=1
    image=[all],"arrow.bmp",-0.5,-0.5,3,3,315,T
endif
```

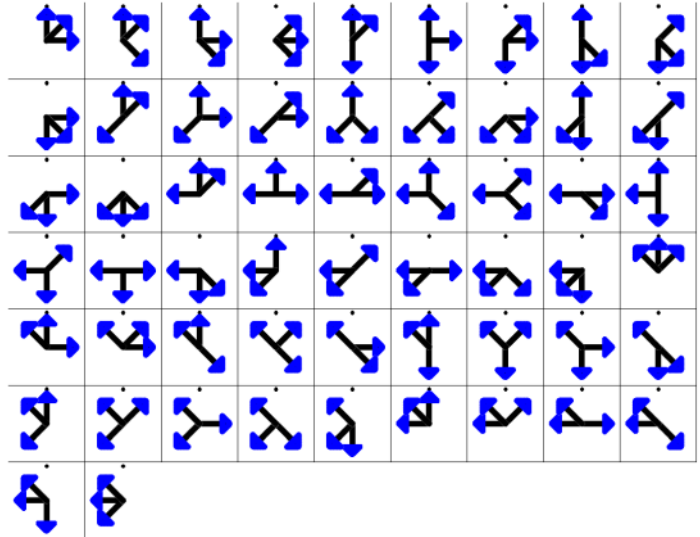

Path tiles

```
oversample=2
macro=tile, (range), (key), (char), (color), (width)
  beziers=(range)
  if=[(key):1,1]=(char)
    beziers=(range),1,0,1,1,(color),(width)
  endif
  if=[(key):2,1]=(char)
    beziers=(range),2,0,2,1,(color),(width)
  endif
  if=[(key):3,1]=(char)
    beziers=(range),3,1,2,1,(color),(width)
  endif
  if=[(key):4,1]=(char)
    beziers=(range),3,2,2,2,(color),(width)
  endif
  if=[(key):5,1]=(char)
    beziers=(range),2,3,2,2,(color),(width)
  endif
  if=[(key):6,1]=(char)
    beziers=(range),1,3,1,2,(color),(width)
  endif
  if=[(key):7,1]=(char)
    beziers=(range),0,2,1,2,(color),(width)
  endif
  if=[(key):8,1]=(char)
    beziers=(range),0,1,1,1,(color),(width)
  endif
end

cardsize=3,3

pxxs[list]8=a|a|b|b|c|c|d|d

[range]=1-{(list)}

tile=[range],[list],a,#000000,0.2
tile=[range],[list],a,#FFFFFF,0.1
tile=[range],[list],b,#000000,0.2
tile=[range],[list],b,#FFFFFF,0.1
tile=[range],[list],c,#000000,0.2
tile=[range],[list],c,#FFFFFF,0.1
tile=[range],[list],d,#000000,0.2
tile=[range],[list],d,#FFFFFF,0.1

rectangle=[range],0,0,3,3,#000000,EMPTY,0.1
```

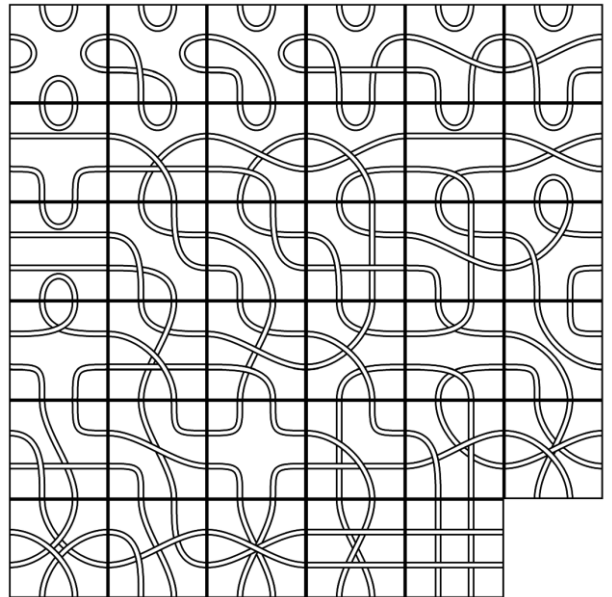

Combinations

```
ellipse=0,0,0,6,6,#FF0000#FFFFFF@360
save=0,a.png,0,0,6,6
ellipse=0,0,0,6,6,#00FF00#FFFFFF@360
save=0,b.png,0,0,6,6
ellipse=0,0,0,6,6,#0000FF#FFFFFF@360
save=0,c.png,0,0,6,6
ellipse=0,0,0,6,6,#FF00FF#FFFFFF@360
save=0,d.png,0,0,6,6
ellipse=0,0,0,6,6,#FFFF00#FFFFFF@360
save=0,e.png,0,0,6,6
ellipse=0,0,0,6,6,#00FFFF#FFFFFF@360
save=0,f.png,0,0,6,6
ellipse=0,0,0,6,6,#000000#FFFFFF@360
save=0,g.png,0,0,6,6
```

```
c[comb]3=a|b|c|d|e|f|g
[all]=1-{(comb)}
icon=[all],a,a.png
icon=[all],b,b.png
icon=[all],c,c.png
icon=[all],d,d.png
icon=[all],e,e.png
icon=[all],f,f.png
icon=[all],g,g.png
icons=[all],[comb],1.5,1.5,3,6,3,3,0,P
```

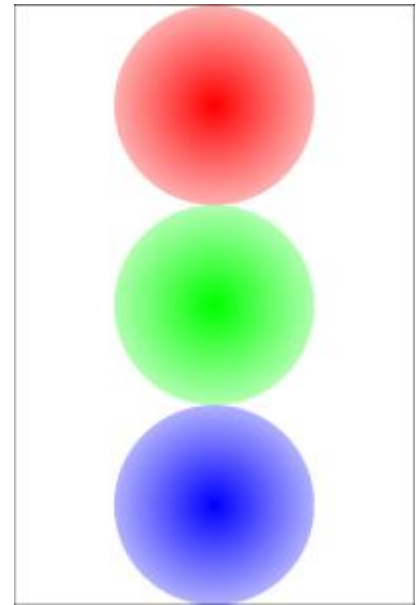

Standard 52-deck of cards

```

sequence=number
A
2
3
4
5
6
7
8
9
10
endsequence

sequence=face
J
Q
K
endsequence

sequence=
suit      |\169\
suit_fnt|Symbol
suit_col|#FF0000

suit      |\168\
suit_fnt|Symbol
suit_col|#FF0000

suit      |\167\
suit_fnt|Symbol
suit_col|#000000

suit      |\170\
suit_fnt|Symbol
suit_col|#000000
endsequence

<corner1>=0,0,15%,20%
<corner1_a>=0,0,15%,10%
<corner1_b>=0,10%,15%,10%
<corner2_a>=85%,0,15%,10%
<corner2_b>=85%,10%,15%,10%
<corner3_a>=0,90%,15%,10%
<corner3_b>=0,80%,15%,10%
<corner4_a>=85%,90%,15%,10%
<corner4_b>=85%,80%,15%,10%
<core>=15%,20%,70%,60%

cards={(suit)*((number)+(face))+1}
for=a,1,{(suit)}
  for=b,1,{(number)}
    font=Arial,24,T,{(suit_col?a)}
    text={b+((a)-1)*((number)+(face))},{(number?b),<corner1_a>
    text={b+((a)-1)*((number)+(face))},{(number?b),<corner2_a>
    text={b+((a)-1)*((number)+(face))},{(number?b),<corner3_a>,center,center,180
    text={b+((a)-1)*((number)+(face))},{(number?b),<corner4_a>,center,center,180
    font={(suit_fnt?a)},32,T,{(suit_col?a)}
    text={b+((a)-1)*((number)+(face))},{(suit?a),<corner1_b>
    text={b+((a)-1)*((number)+(face))},{(suit?a),<corner2_b>
    text={b+((a)-1)*((number)+(face))},{(suit?a),<corner3_b>,center,center,180
    text={b+((a)-1)*((number)+(face))},{(suit?a),<corner4_b>,center,center,180
    text={b+((a)-1)*((number)+(face))},{(suit?a)Xb},<core>,center,charwrap
  next
next
for=a,1,{(suit)}
  for=b,1,{(face)}
    font=Arial,24,T,{(suit_col?a)}
    text={b+((a)-1)*((number)+(face))+(number)},{(face?b),<corner1_a>
    text={b+((a)-1)*((number)+(face))+(number)},{(face?b),<corner2_a>
    text={b+((a)-1)*((number)+(face))+(number)},{(face?b),<corner3_a>,center,center,180
    text={b+((a)-1)*((number)+(face))+(number)},{(face?b),<corner4_a>,center,center,180
    font={(suit_fnt?a)},32,T,{(suit_col?a)}
    text={b+((a)-1)*((number)+(face))+(number)},{(suit?a),<corner1_b>
    text={b+((a)-1)*((number)+(face))+(number)},{(suit?a),<corner2_b>
    text={b+((a)-1)*((number)+(face))+(number)},{(suit?a),<corner3_b>,center,center,180
    text={b+((a)-1)*((number)+(face))+(number)},{(suit?a),<corner4_b>,center,center,180
    font=Arial,128,T,{(suit_col?a)}
    text={b+((a)-1)*((number)+(face))+(number)},{(face?b),<core>
  next
next

rectangle={(suit)*((number)+(face))+1},0,0,100%,100%,#FF0000#0000FF@90
font=arial,48,DNT,#FFFFFF
text={(suit)*((number)+(face))+1},"nanDECK",0,0,100%,100%

```

