

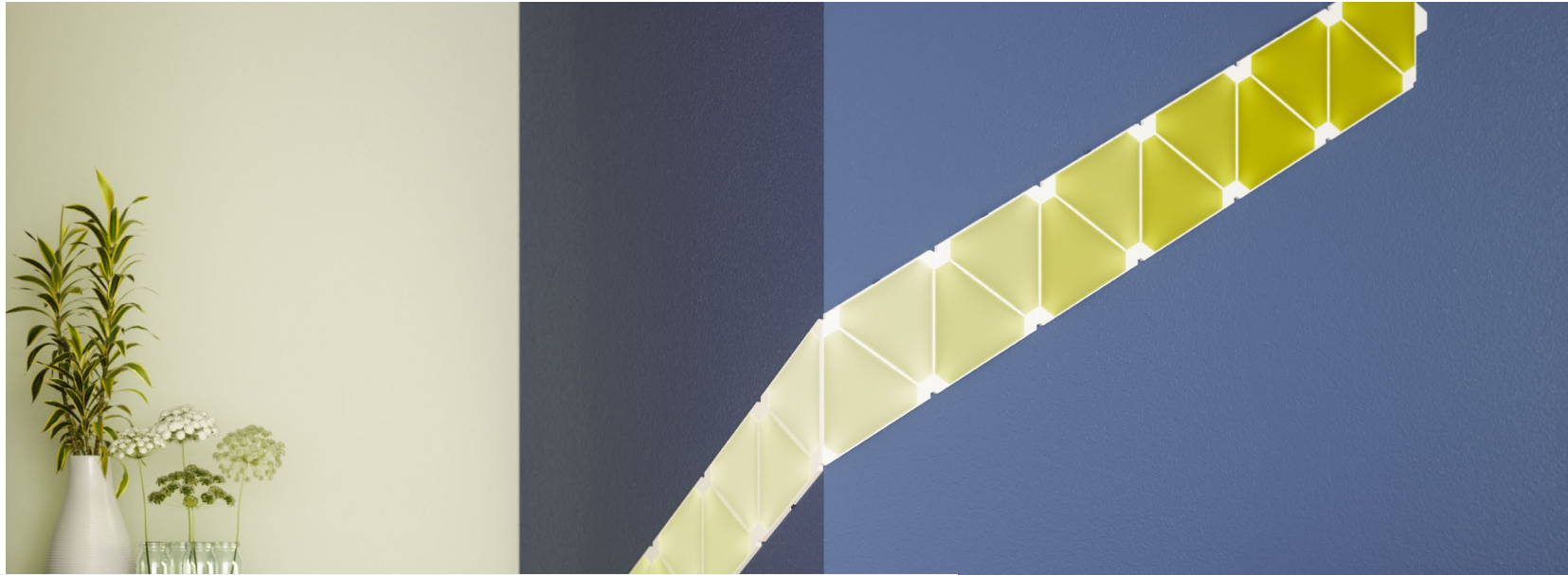

Nanoleaf Light Panels

User Manual





Welcome to Smarter Living

Congratulations on becoming an official owner of the Nanoleaf Light Panels. Remember, you can grow your setup with Expansion Packs to unleash your creativity to the fullest. Thank you for your support, you brighten our day like Nanoleaf brightens the world!



Table of Contents



Product Setup

Designing Your Layout	6
Mounting Your Panels	7
Pairing Your Panels for iOS	9
▬ Problems & Solutions	10
Pairing Your Panels for Android	11
▬ Problems & Solutions	12
Controlling Your Panels	13

Product Resources

What's in the Box	16
Design Inspiration	17

Problems & Solutions

Reset Options	19
Common Solutions	20
Placement Recommendations	22
Warnings & Cautions	23



Product Overview

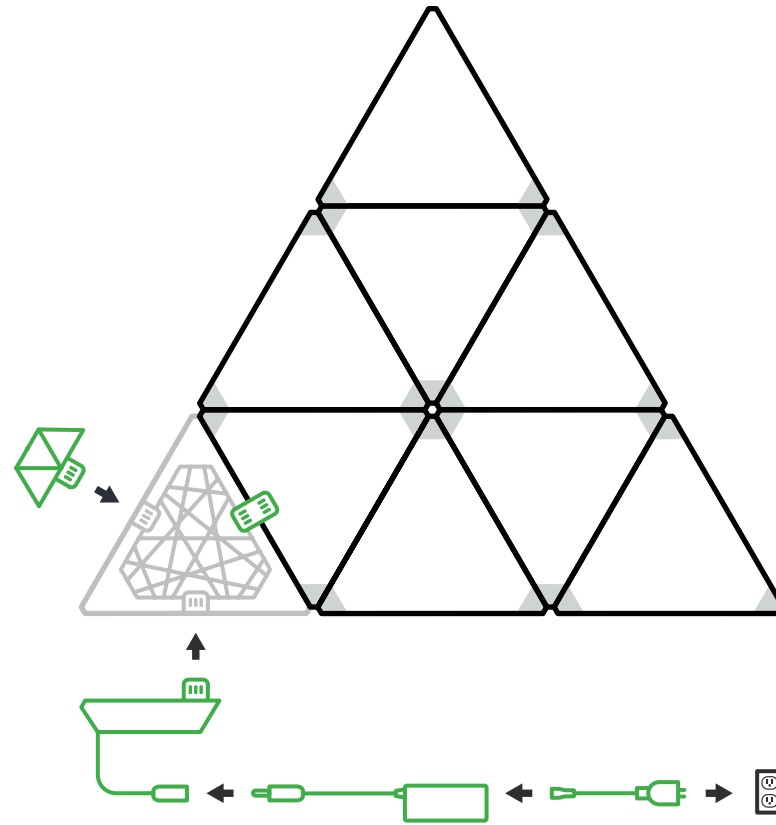

Light Panels



Linkers



Controller



Rhythm Module



Mounting Tape



Power Supply



Product Setup

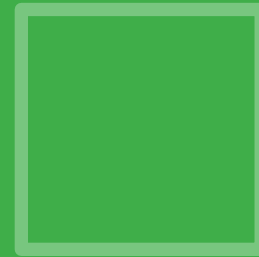

Designing Your Layout



Slow down tiger! Before you mount your panels onto the wall, plug it in to a power source and try it out on a table or floor. Make sure your design fits into your space by measuring the width and height of your intended setup (stencils or panels on the table). For the best placement of your Nanoleaf Light Panels, please refer to [page.22](#). You can also use the tools below to help plan out your design!



Layout Assistant

Explore different panel layouts with the Layout Assistant [here](#), and preview them in your room using the AR feature. Download the Nanoleaf App and open the Layout Assistant to get started.



Stencils

Recreate your design on the wall by taping the stencils up. Check for obstructions, make sure you like the positioning, and mark the wall lightly with pencil or masking tape to assist when mounting the panels.



Flex Linkers

Extend the possibilities of your Nanoleaf Light Panels even further! Bend around corners, mount the Light panels to angled surfaces, maybe even create something a little radical. Each linker bends up to 180 degrees.



Design Inspiration

Get inspired by the Nanoleaf community, check out our Social Media channels to see what other Nanoleaf owners are creating. You can also refer to [page.17](#) to see the most popular shapes.

Let's Get Social!

   @nanoleaf

Remember to share your designs with us on social media by tagging [@nanoleaf](#) and [#nanoleaf](#). Follow us to stay updated on upcoming giveaways, special promotions, and product updates.



Mounting Your Panels

1 Preparing Your Surface

The Nanoleaf Light Panels should only be installed in an indoor environment on a flat surface that can support the weight of the panels. Clean the surface so that it is dry and clean from any dust, debris, or oil.

NOTE: Installations using mounting tape on textured, porous, popcorn and ceiling surfaces is not recommended. The optional Nanoleaf Screw Mount Kit for Light Panels will be better for these surfaces.

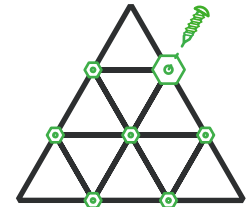
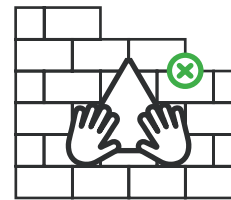

2 Using the Mounting Tape

Use the included mounting tape to securely attach the panels. We recommend using 3 pieces of mounting tape for each panel.

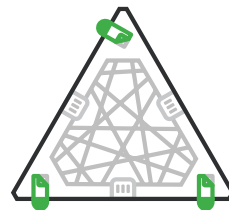

NOTE: Make sure to leave ends of the tape sticking out. This will allow you to safely remove them later from the wall.

3 Mounting Your First Panel

Designate a panel from your setup as the starting panel. Peel off the other side of the tape and press the panel firmly against the wall. Hold each corner for 30 seconds to ensure that your panel attaches firmly.

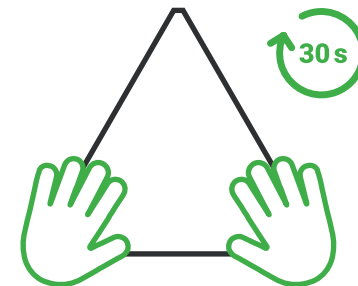



4 Connecting Your Controller

Connect your controller into an available linker slot of the first panel and plug in the other end to a power source. This will ensure that your setup is on and properly connected as you continue to link your panels together.

NOTE: This positioning can be changed after your setup has been completed. An additional controller and power supply is required for every additional 30 panels.

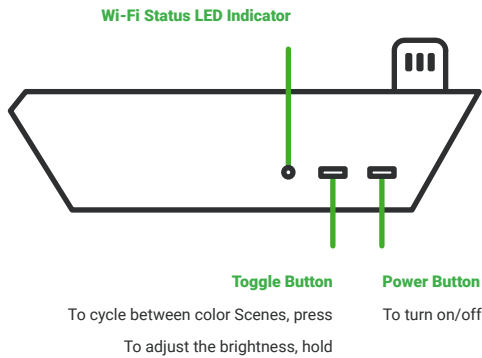

5 Completing Your Setup

Continue to link each panel together and ensure that each panel lights up as you do so. Make sure the linkers are fully slotted into the linker slot, the panels should be aligned edge to edge.

6 Connecting Your Rhythm Module

The Rhythm Module is included with any purchase of the Nanoleaf Light Panels Smarter Kit. It can also be bought separately to upgrade any larger setup. To connect the Rhythm, insert it into any available linker slot.

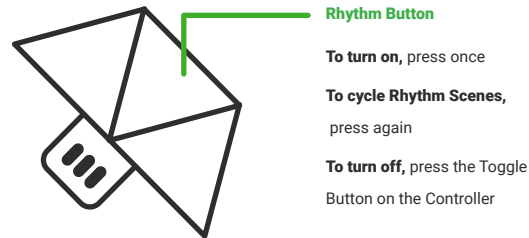

Using headphones but still want to see your panels react to music? Use a 3.5 mm audio cable and splitter to connect the Rhythm to an audio source. Audio cables and splitters do not come with any Nanoleaf products.

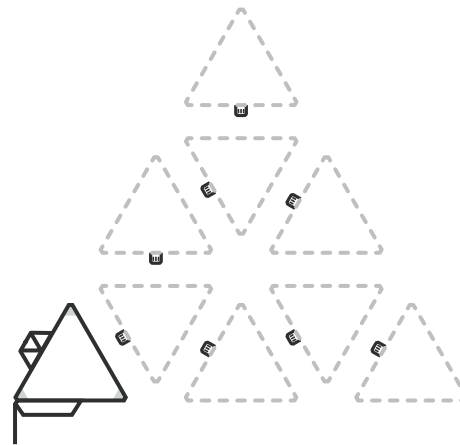

* Need to Dismount Your Panels?

With one hand on the Light Panels, use your other hand to pull the ends of tape along the wall. Do not pull perpendicularly or at any other angle, otherwise you may damage your wall. Continue removing the tape from each panel until they are all safely removed.

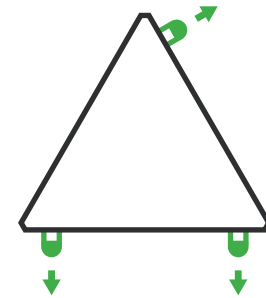

Add to Your Masterpiece!

Be even more creative and grow your setup with Expansion Packs. An additional controller and power supply is required for every additional 30 panels.

[GET ONE TODAY](#)



Pairing Your Panels iOS

Standard Pairing Process for iOS

To ensure a smooth pairing process, please make sure you have the following things ready:



Your Device
Requires iOS 10+



2.4 GHz Wi-Fi Network
5G networks are not compatible with Nanoleaf products.

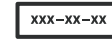

Pairing Code
Can be found on your Welcome Insert or Controller.



Controller
The controller is ready when the Status LED is solid white.

1 Download and Open the Nanoleaf App

You can find the official **Nanoleaf Smarter Series** App in the App Store. Make sure you have the latest version.

2 Pair Your Light Panels

- 2.1 Select the **MORE** tab **...**
- 2.2 Select **MY DEVICES** and **+** to add a device.
- 2.3 Select **LIGHT PANELS** as your product and **START PAIRING**.

NOTE: If you have more than one set of panels connected to your network, select the magnifying glass to identify the correct setup (it will flash green).

- 2.4 Once identified and selected, the camera will open.
- 2.5 Scan your pairing code to pair.
- 2.6 Your Nanoleaf Light Panels should now be connected and ready to go!

* Additional Pairing Method

- 1. Select **Don't Have a Code or Can't Scan?**
- 2. Manually enter your 8-digit pairing code (found on your Welcome Insert or Controller).

NOTE: Nanoleaf Light Panels are not currently supported by NFC.

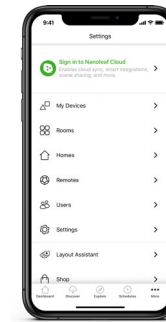

Step 2.2

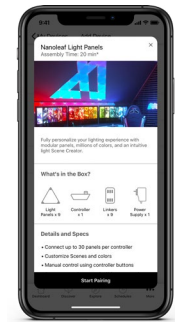

Step 2.3



Step 2.4

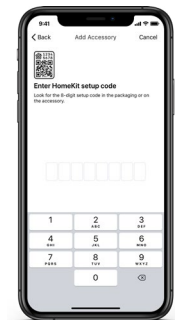

Step 2 of Additional Pairing Methods



Pairing Your Panels iOS

Continued

“How can the same setup be controlled by multiple iOS users?”

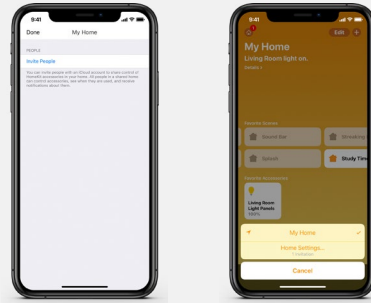

Step 1.4

Step 2.3

This is accomplished with Apple HomeKit. You can also do this through the Apple Home App or the Nanoleaf App.

Primary User

- 1.1 Open the Nanoleaf App.
- 1.2 Select the **MORE** tab. **...**
- 1.3 Select **USERS**.
- 1.4 Invite the secondary user with their email address.

Secondary User

- 2.1 A notification will appear for you to accept.
- 2.2 In the Home App, select the home icon in the top left.
- 2.3 Select **HOME SETTINGS**, a list of homes will appear.
- 2.4 Accept the home that has been shared with you. This will give you control of the Light Panels as well as any other HomeKit devices in the same home.

“How do I control a setup with more than 30 panels?”

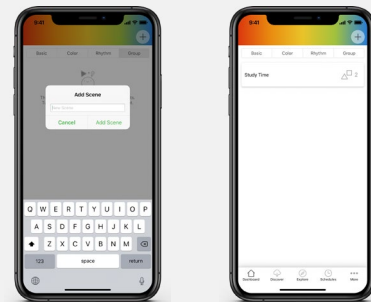

Step 4

Step 9

Setups are synchronized by creating Group Scenes. An additional controller and power supply is required for every additional 30 panels. Begin by pairing each controller separately using the Standard Pairing Process on [page.9](#).

1. Open the Nanoleaf App.
2. In the Dashboard, select the **GROUP** tab.
3. In the top right corner select **+**
4. Give your Group Scene a name.
5. Select **MANAGE**.
6. Select **MANAGE ACCESSORIES**.
7. Select the setups you want in the Group Scene.
8. Modify how you want each setup to look.
9. Your Group Scenes can be accessed under the **GROUPS** tab in the Dashboard.



Still Need Help?
nanoleaf.me/support



Pairing Your Panels Android

Standard Pairing Process for Android

To ensure a smooth pairing process, please make sure you have the following things ready:



Your Device

Requires Android 5.0+



2.4 GHz Wi-Fi Network

5G networks are not compatible with Nanoleaf products.

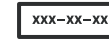

Pairing Code

Can be found on your Welcome Insert or Controller.



Controller

The controller is ready when the Status LED is solid white.

1 Download and Open the Nanoleaf App

You can find the official **Nanoleaf Smarter Series** App in the Google Play Store. Make sure you have the latest version.

2 Pair Your Light Panels

- 2.1 Ensure your location settings are turned on.
- 2.2 Select **DEVICES**, located in the side menu on the left.
- 2.3 Select **+** to add a device.
- 2.4 Select **LIGHT PANELS** as your product and **START PAIRING**.

NOTE: If you have more than one set of panels connected to your network, select the magnifying glass to identify the correct setup (it will flash green).

- 2.5 Once identified, **TAP TO PAIR**.
- 2.6 Enter your 8-digit pairing code manually to pair (found on your controller or welcome insert).
- 2.7 Your Nanoleaf Light Panels should now be connected and ready to go!

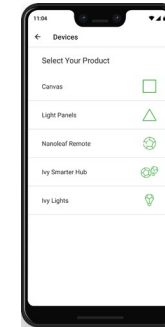

Step 2.4

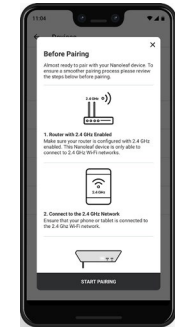

Step 2.4

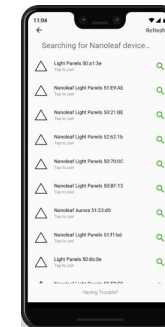

Step 2.5



Step 2.6



Pairing Your Panels Android

Continued

“How do I control a setup with more than 30 panels?”

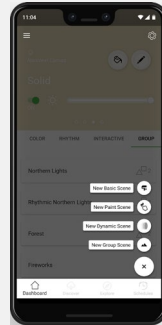

Step 3

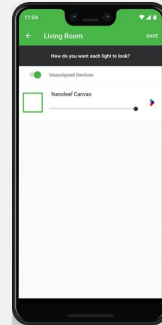

Step 7

Setups are synchronized by creating Group Scenes. An additional controller and power supply is required for every additional 30 panels. Begin by pairing each controller separately using the Standard Pairing Process on [page.11](#).

1. Open the Nanoleaf App.
2. In the Dashboard, select the **GROUP** tab.
3. In the bottom right corner select **+**
4. Select **NEW GROUP SCENE**.
5. Give your Group Scene a name.
6. Select the setups you want to include in the Group Scene.
7. Modify how you want each setup to look and **SAVE**.
8. Your Group Scenes can be accessed under the **GROUPS** tab in the Dashboard.



Still Need Help?
nanoleaf.me/support

Controlling Your Panels



Nanoleaf Controller

No Wi-Fi? No Problem! The Nanoleaf Light Panels work right out of the box. Find hundreds of pre-saved Scenes by using the Toggle Button on the controller. Refer to [page.21](#) if you are experiencing any connection issues.



Power Button

To turn on/off.



Toggle Button

To cycle between color Scenes, press
To adjust the brightness, hold.



The Nanoleaf App

Turn your lighting on and off, control brightness, group lights by home and by room, create and use Scenes, and much more.



Dashboard

Choose an existing Scene or create your own (Static, Dynamic, Rhythm, Group, Layered). You can also use the Paint Tool to color panels individually.



Explore

Find helpful information including tutorials, new device features, etc.



Schedules

Automate your Scenes to turn on or off.



Discover

Find and download new Scenes created by the Nanoleaf community.



Nanoleaf Remote

The Nanoleaf Remote is a sleek, dodecahedron-inspired Bluetooth HomeKit remote designed to enhance the smarter home experience and make controlling the Nanoleaf Light Panels and other HomeKit products even more convenient.



Control the brightness of your Light Panels by rotating the Remote clockwise and counterclockwise.



Save your favorite Scenes to any of the twelve sides. Face up to activate.



Controlling Your Panels

Continued



Nanoleaf Desktop App

With the Nanoleaf Desktop App, you can control your Light Panels from a web browser on your computer. Create and download new Scenes and set Schedules right from your computer. The Desktop App was designed to simplify the management of larger installations and offer control of many different layouts at once. Download it online [here](#).



Voice Control

You can easily control your Light Panels by voice in a few different ways. In the Nanoleaf App, make sure to name your panels something easy to say.



Hey Siri...

"Turn [Device Name] on/off."

"Set [Device Name] to 10% brightness."

"Brighten/dim the lights."

"Brighten/dim the lights to [%]."

"Set [Scene Name]."

"Set [Device Name] to [Scene Name]"

"Set [Device Name] to [Color]."



Okay Google...

"Turn on [Device Name or Scene Name]."

"Turn on/off the lights in [Room Name]."

"Turn on/off all my lights."

"Turn off [Device Name]."

"Brighten/dim [Device Name]."

"Brighten/dim the lights in [Room Name]."

"Brighten/dim all my lights."

"Set [Device Name] to [%]."

"Set [Device Name] to [Color]."



Alexa...

"Turn on [Device Name or Scene Name]."

"Turn off [Device Name]."

"Brighten/dim [Device Name]."

"Set [Device Name] to [%] brightness."

"Set [Device Name] to [Color]."



Nanoleaf Open API

A local network API designed to extend your experience and allow you to integrate the Light Panels with third party devices and services, as well as enable more granular control of the hardware. Find out more [here](#).



Product Resources

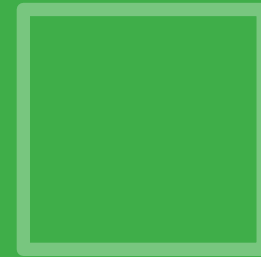



What's in the Box

 Light Panels	 Linkers	 Controller	 Rhythm Module	 Mounting Tape	 Power Supply
---	--	---	--	--	---

Nanoleaf Light Panels
4 Pack Smarter Kit

4 | 4 | 1 | 1 | 12 | 1

Nanoleaf Light Panels
9 Pack Smarter Kit

9 | 9 | 1 | 1 | 27 | 1

Nanoleaf Light Panels
15 Pack Smarter Kit

15 | 15 | 1 | 1 | 45 | 1

Nanoleaf Light Panels
3 Expansion Pack

3 | 3 | - | - | 9 | -



Design Inspiration

9 Panels



12 Panels



15 Panels

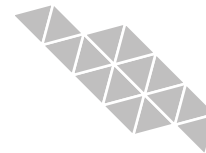

30 Panels

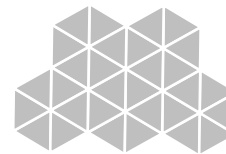



Problems & Solutions

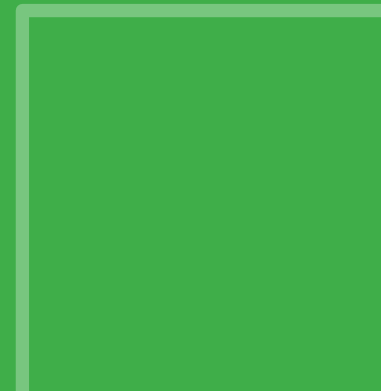
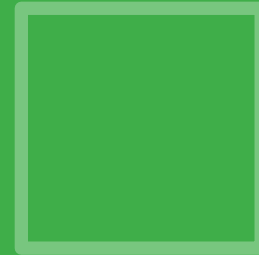



Reset Options

1 Soft Reset

This will reset the Wi-Fi and all saved pairing configurations. Your saved scenes will remain.

- 1.1 Press and hold the Toggle and Power buttons together on the controller for 15 seconds.
- 1.2 Let go once the Status LED starts flashing.
- 1.3 Release the buttons and wait for the Status LED indicator to become solid.

2 Hard Reset

This will reset your Light Panels to factory settings, deleting Wi-Fi settings, pairing information, and saved scenes. Your default scenes and settings will be restored.

NOTE: You can restore your Scenes after a Hard Reset if you are logged in to your Nanoleaf Account (see Restore Scenes procedure below).

- 2.1 Unplug your controller from the power source.
- 2.2 Press and hold the Toggle and Power buttons together on the controller, and plug the controller back into power without releasing the buttons.
- 2.3 After about 10 seconds, the Status LED will begin to flash rapidly, release the buttons.
- 2.4 Wait about 2 minutes for a reboot.
- 2.5 Your Light Panels should be reset when it begins flowing with color and the Status LED reflects a solid white.

* Need to Restore Your Scenes?

Nanoleaf Light Panels

Requires Firmware 3.1.0+

Nanoleaf App

Requires Software 3.4+ for iOS & Android

1. Open the Nanoleaf App.
2. Login to your Nanoleaf Account.
3. In the Dashboard tab, select the Settings icon in the top right.
4. Under **SYSTEM > BACKUP AND RESTORE**, ensure that **DEVICE SYNC** is enabled.
5. Select **RESTORE FROM BACKUP** and **RESTORE**.



Still Need Help?
nanoleaf.me/support

Common Solutions



“I moved or changed my Wi-Fi network.”

“My Light Panels are paired but unreachable.”

“I am not able to pair my Light Panels.”



Still Need Help?
nanoleaf.me/support

A Try Wi-Fi Settings Reset

This will allow you to connect your Light Panels to a new Wi-Fi network.

1. Plug in your controller to the power outlet.
2. Press the Power button and then Toggle button, repeat 5 times (10 presses in total).
3. The Status LED will become a solid white.

A Try to Toggle your Wi-Fi

On your phone, toggle the Wi-Fi off, then on again.

B Try to Power Cycle your Controller

Unplug your controller from power, then plug it back in.

C Try to Power Cycle your Router

On your phone, toggle the Wi-Fi off, then on again.

D Try a Soft Reset

A Check your Router Settings

1. 5 GHz networks do not support Nanoleaf products. Are you connected to a 2.4 GHz network?
2. Ensure multicast, IGMP, UPnP (if available) are enabled on your router settings.

B Try a Soft Reset

C Try a Hard Reset

Common Solutions

Continued

“I don't see my Light Panels in the App for setup.”

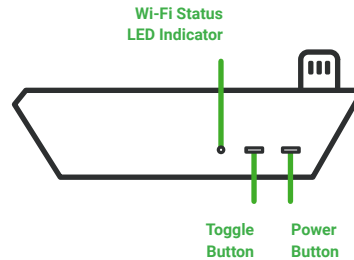

A Wi-Fi Troubleshooting

The Wi-Fi Status LED will light up after 1 minute from when you plug in the controller to the power outlet.

If your Status LED is **Solid White**

Your Light Panels are ready to connect to your network.

- Make sure your mobile device Wi-Fi is on.
- Move your mobile device closer to your panels.
- Toggle the Wi-Fi on your mobile device off, then on.
- Try a Hard Reset.

If your Status LED is **Unlit**

Your Wi-Fi is configured and connected to your router.

- Make sure your mobile device is on the same network.
- Toggle the Wi-Fi on your mobile device off, then on.

If your Status LED is **Flashing (1 second intervals)**

Your Wi-Fi configuration has timed out.

- Try to Power Cycle your controller (unplug your controller from power, then plug it back in).
- Try a Soft Reset.

If your Status LED is **Flashing (4 second intervals)**

Your Wi-Fi is configured, but the panels cannot connect to the target network.

- Power Cycle your router (unplug your router from power, then plug it back in).
- If your panels are paired on the Nanoleaf App, delete the device and re-pair them with the Standard Pairing Process.
- Try a Soft Reset.



Still Need Help?
nanoleaf.me/support



Placement Recommendations

The following tips can help your Nanoleaf Light Panels achieve the best wireless range & network reception.

- a. Place your Light Panels in an open area where there are less obstructions, such as large pieces of furniture or walls.
- b. Avoid placing your Light Panels behind furniture or inside cabinets.
- c. Don't place your Light Panels in areas surrounded by metal surfaces on three or more sides. This can cause signal issues.
- d. Try to place your Light Panels at least 25 feet (8 meters) away from any microwave oven, 2.4 GHz cordless phone, Wi-Fi devices, or other source of interference.
- e. Place your Light Panels as close to your Wi-Fi home router as possible. For best performance, keep the distance below 65 feet (20 meters) and have no more than one wall in between.



Still Need Help?
nanoleaf.me/support



Warnings & Cautions

Nanoleaf Light Panels are not designed for use in:

- a. Enclosed locations that limit the flow of air and/or trap excessive amounts of heat.
- b. Emergency exits or emergency lights.
- c. Conjunction with 3rd party sensors/timing devices that are not approved by Nanoleaf®.
- d. Places where there is a risk of electric shock.
- e. Outdoor areas.
- f. Wet or damp conditions.
- g. Excessively hot environments (e.g. close to ovens, radiators, heaters, etc).
- h. Regions or countries other than that in which the product was intended for.

When using Nanoleaf Light Panels:

- a. Do not open the device, as this will void the warranty.
- b. Do not place any metallic or conductive objects near the exposed contacts on the Nanoleaf Light Panels controller, power supply, linkers, or back of the Nanoleaf Light Panels panels.
- c. Do not allow small children to operate this device unsupervised. This device contains small parts that may be a choking hazard to small children.
- d. Do not clean the device when it is on and or connected to power.
- e. Clean the panels with a soft dry cloth, do not use cleaning agents.
- f. Do not bend the panels with the linker still attached.
- g. Do not attach the panels together with anything other than its original panel linkers.
- h. Do not puncture the panels with any nails or screws during installation.
- i. Do not attach the panels to a ceiling without consulting a qualified contractor and using additional mounting hardware designed to prevent the panels from falling.
- j. Do not attach the panels to the floor where they may get stepped on.
- k. Do not place the panels in water, or expose the panels to water.
- l. Do not use mounting tape for the following surfaces: brick or mortar wall, wallpaper, uneven/bumpy or textured surfaces.



Still Need Help?
nanoleaf.me/support



@nanoleaf



/thenanoleaf

nanoleaf.me

Design Inspiration

Nanoleaf Light Panels

9 Panels



12 Panels



15 Panels

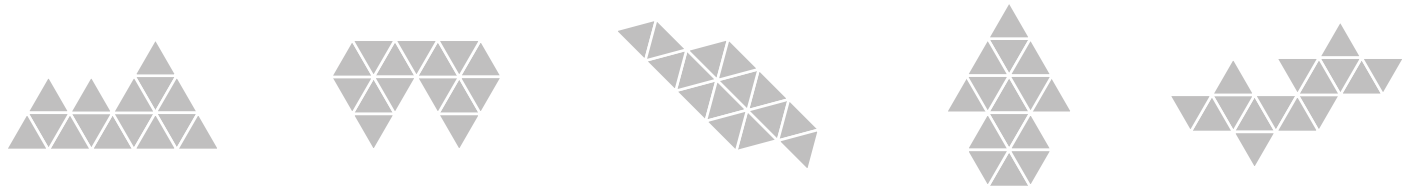

30 Panels

