

National Aeronautics and Space Administration

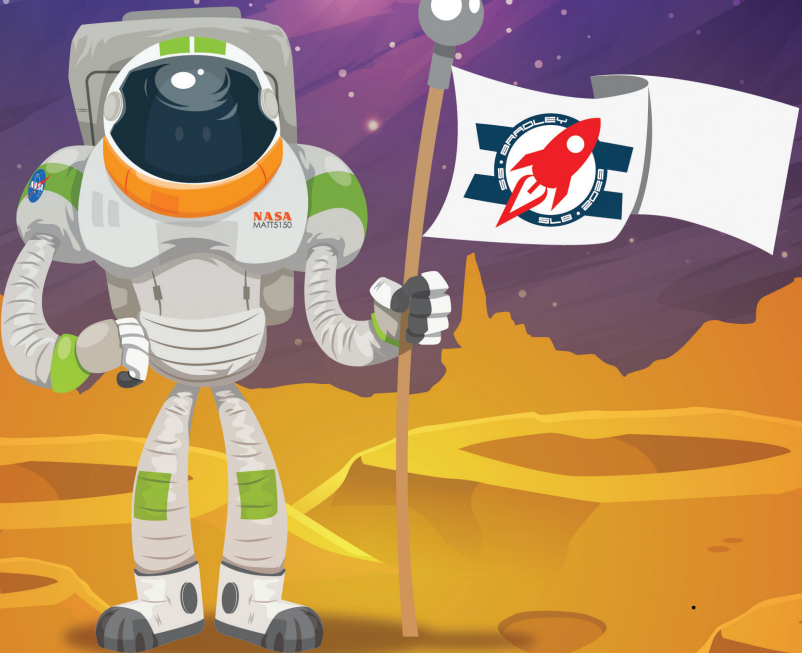

SPACE TECH FUNPAD



NASA Technology in Your World

Through sustained investments in technology, NASA is making a difference in the world around us. NASA technology investments in space exploration, science, and aeronautics is making it possible for us to learn more about our planet and outer space. Many of these technologies can also be found improving your daily life. Next time you travel by car or plane or when you brush your teeth today or check the weather forecast, you're using a bit of NASA technology if you know it or not...

Technology Drives Exploration



Computer Whiz

Find and circle these shapes.



Out of Place

Circle the robots that are different from the others.

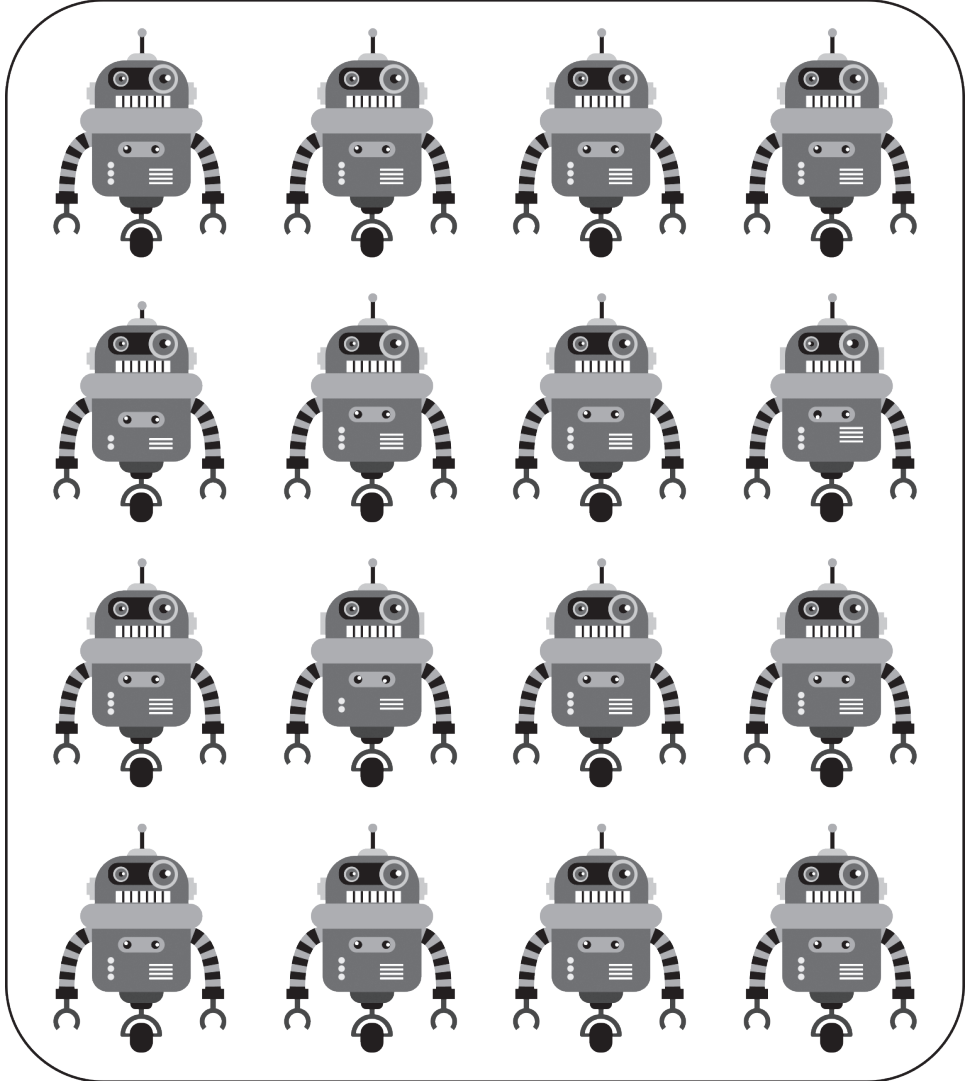

Solar Electric Propulsion

Color the worlds.

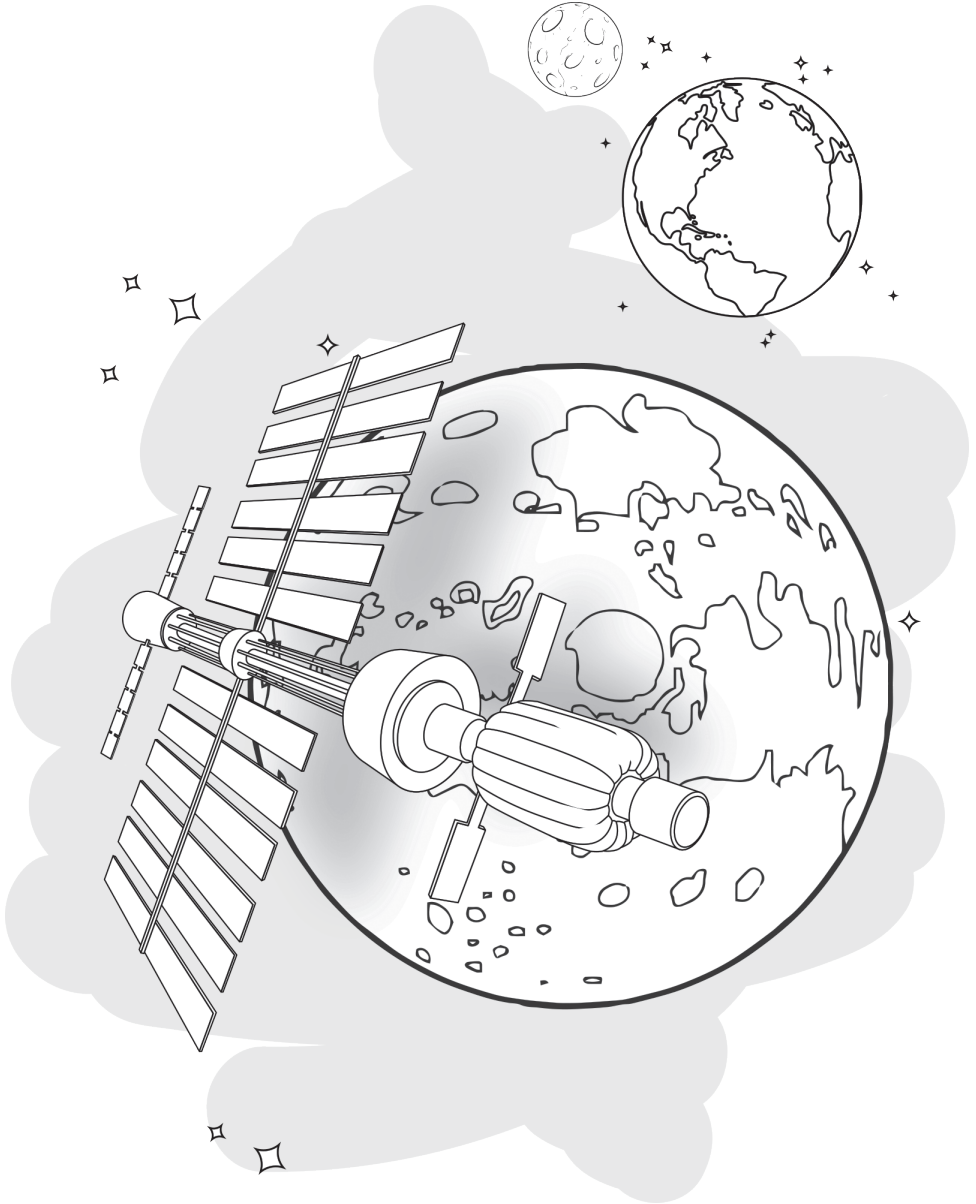

Solar Electric Propulsion (SEP) is a project to create technology that can push spacecraft to far-off destinations. SEP would collect the Sun's energy through solar panels so that less fuel is required for the spacecraft and it can reach much more distant worlds.

VEGGIES

Astronauts on the International Space Station used a special Vegetable Production System (VEGGIE) to grow lettuce that they could eat.

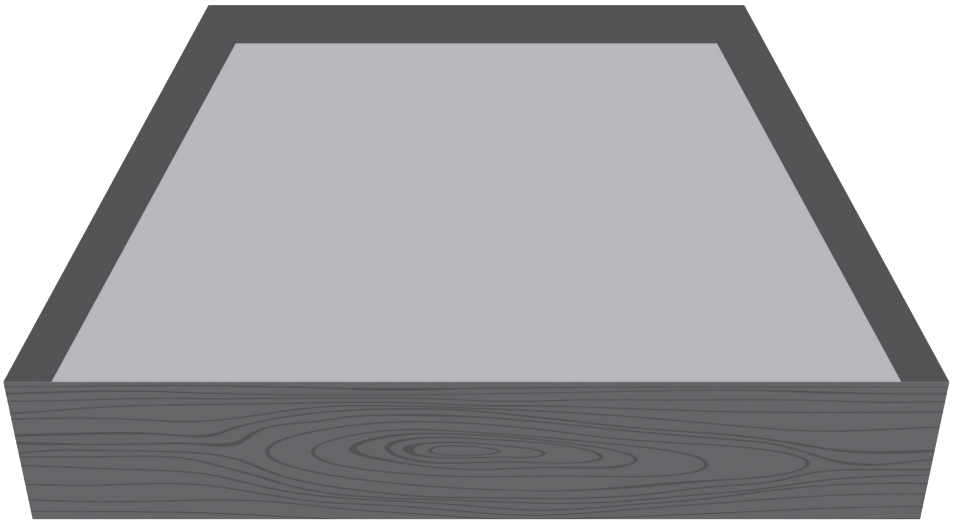
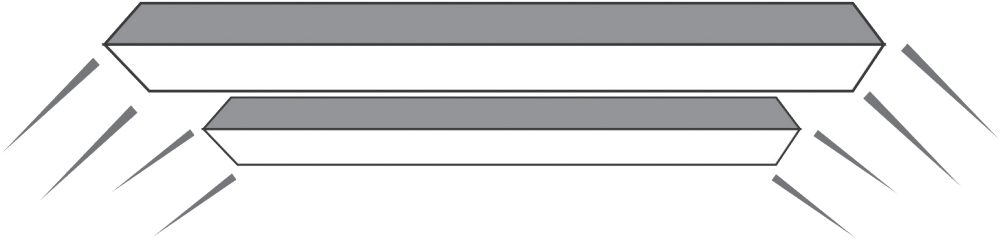

Draw your own garden of food for astronauts to harvest and eat.

Match the Satellites

Draw a line from each satellite to its twin.

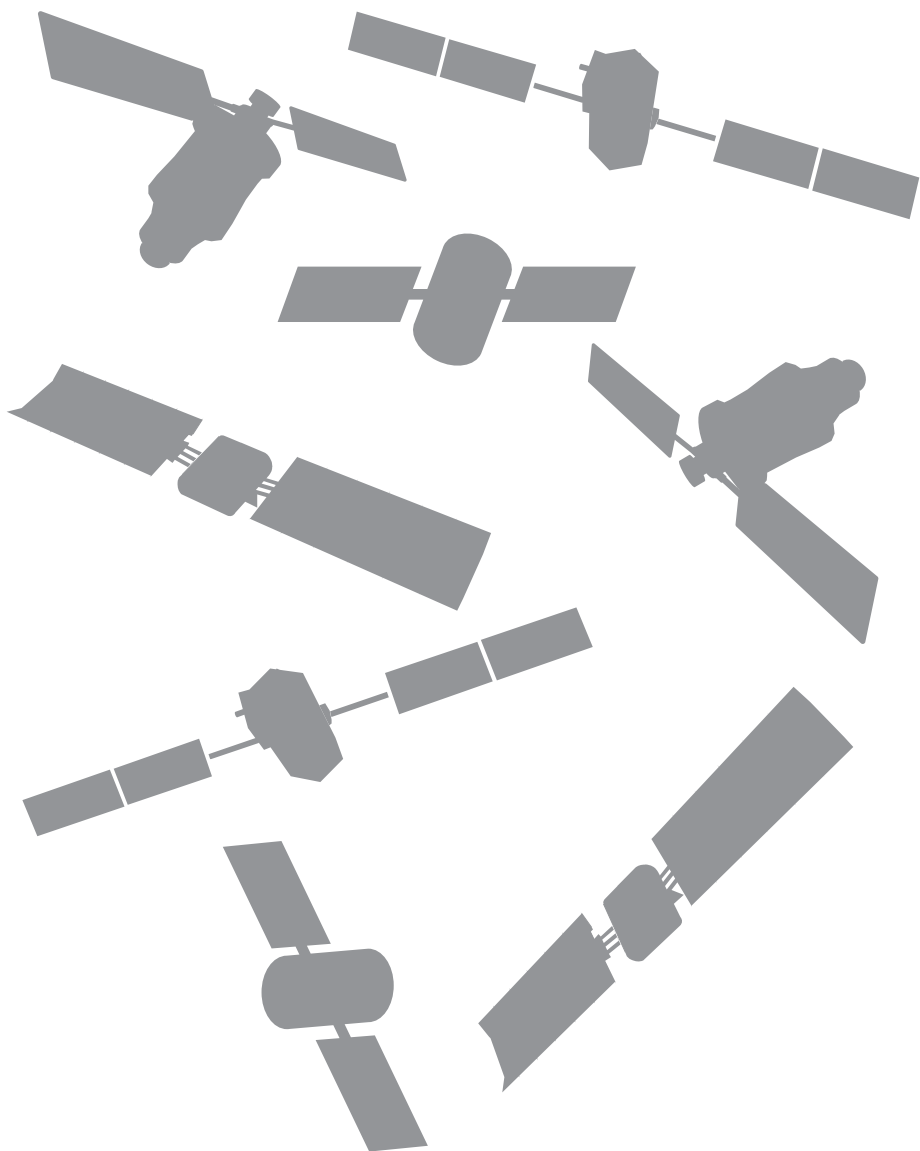

Lab Tech

Can you name these common tools used by scientists and engineers?

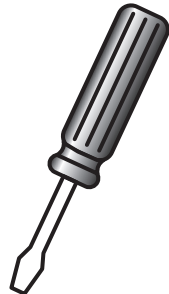
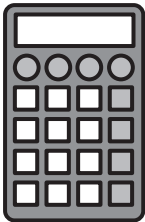
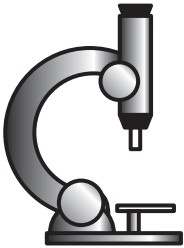
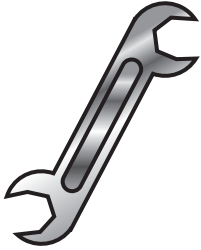

Connect the Dots

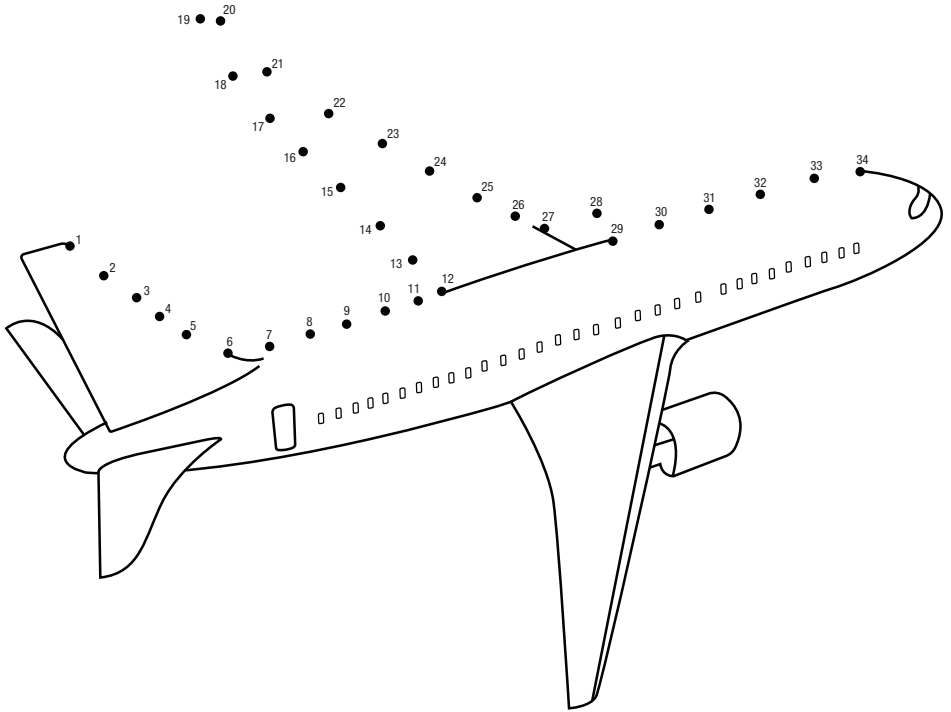

The design of aircraft has changed a lot over the years. NASA has helped improve airplanes with technology that saves fuel, makes flights quicker, helps pilots train better, and makes taking off and landing safer.

Life on Mars

Circle 11 things that are different in the images of an astronaut on Mars.

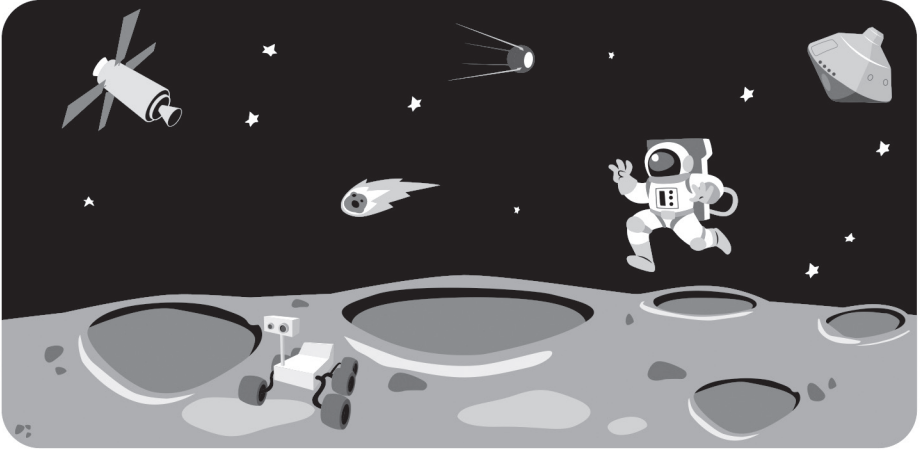

NASA is making new tools and systems to support astronauts going to Mars. Things they need include advanced life support systems to help them breathe; an updated space suit design; technology to produce water, oxygen, and fuel on the surface of Mars; and better ways to communicate with Earth.

Building Technology

Find and circle these hidden shapes.

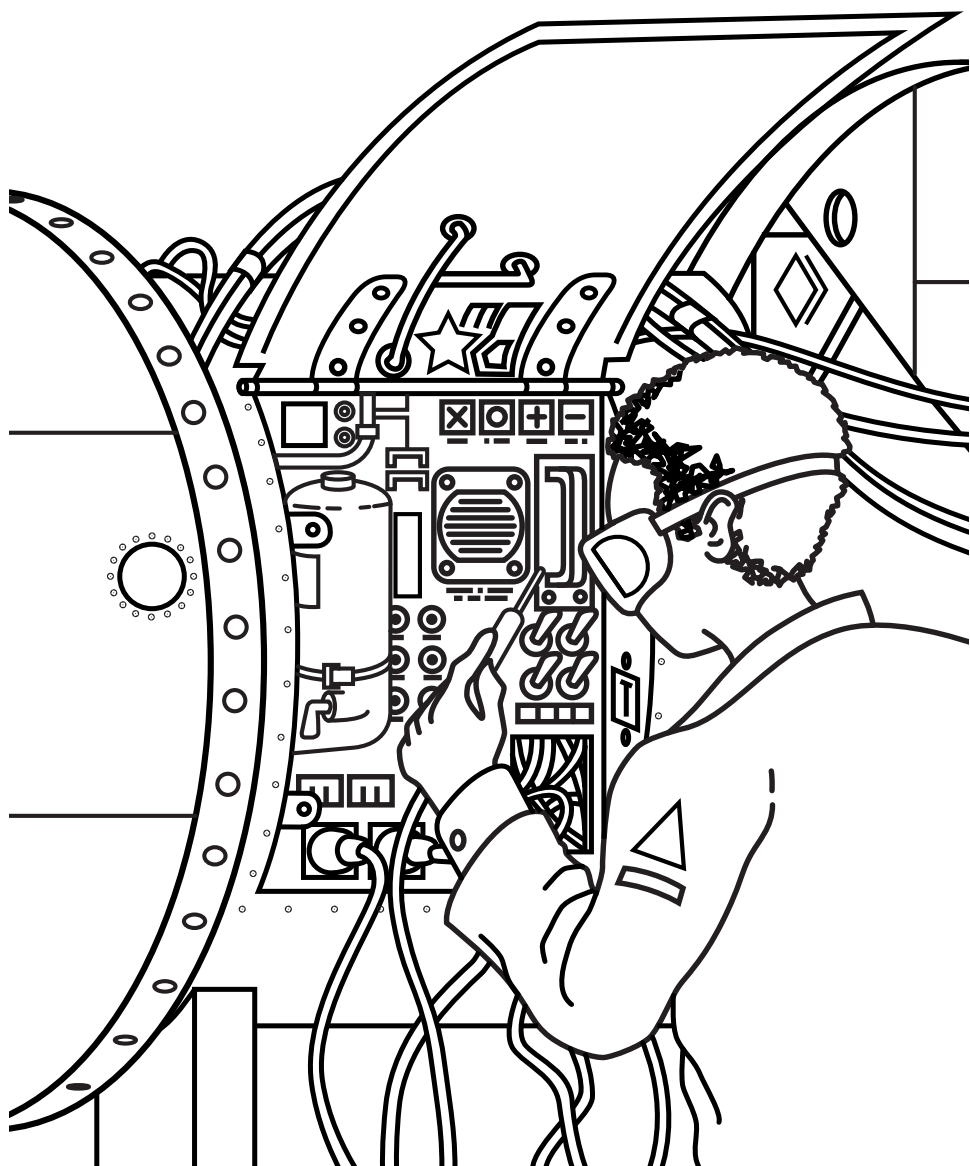

Where Is NASA?

NASA has many Centers across the United States that study Earth and space and build technology for exploration. Which ones are near you?

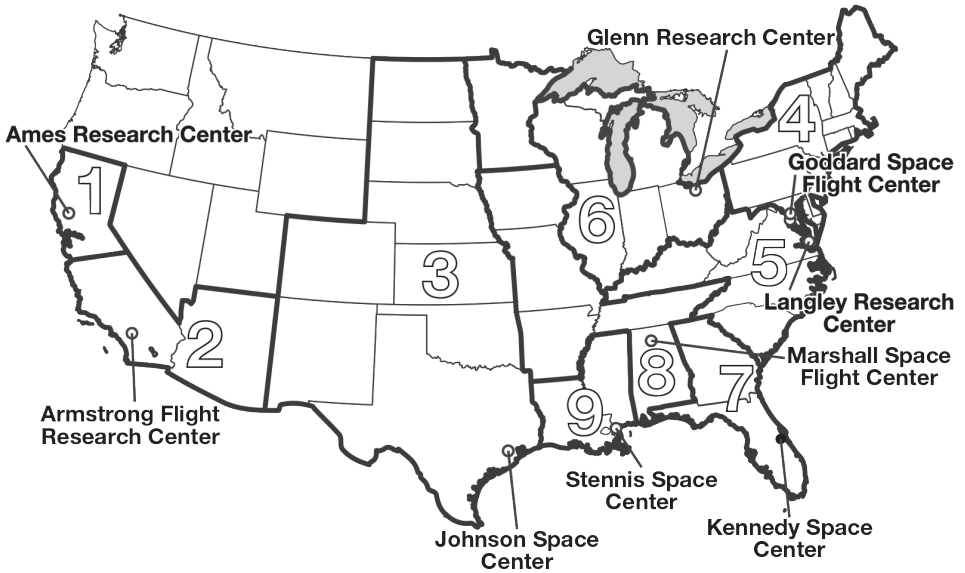

Each Center has its own region for educational programs. Color the regions by number.

- 1 = Yellow (Ames)
- 2 = Orange (Armstrong)
- 3 = Purple (Johnson)
- 4 = Red (Goddard)
- 5 = Dark Green (Langley)
- 6 = Blue (Glenn)
- 7 = Pink (Kennedy)
- 8 = Light Blue (Marshall)
- 9 = Light Green (Stennis)

Spacecraft Search

Find the names of these NASA Spacecraft.

W A P O L L O T N P Q M W S W E W W I A Q W P T W E Q
S S N D S G L G H O A A E D E D E E K S W E O G S R W
P D B F D B M B Y I Z T R G R C R R J D E R R V X T E
A F V G F Y O E B V O Y A G E R T T M F R T I Y E Y R
C G C H G H I E S K E I N S Y G Y Y O G T Y O H D U T
E H X Z H I U U I T X G P C S F U U P H Y U N B C I Y
S J W X C A S S I N I E O V D Y I I W J A U R U R O U
H Z E C X M T K C E D G I B F H O U S D S J E J F A I
U X R V V O E F F W C U L Y G N D J F F D N W N V S G
T C T P B L G S S D R J K U E J F N G G F Y S E T D E
T V Y A F I X C S F F N J E C I G M H H G H D D G F M
L B U T G J C V V E V P R J V J H N J X H B F S B G I
E N J H S F V J H H N K N H B I J B B C X R G Z F H N
B U H F D A B G J J G G M A I K U G V V C E H Q G J I
K H G I F S Z U B K B L E S K I N H C B V N J W H X A
B B F N G D X I H G Y K U R M E O J V T B I K E J C S
D I D D H F C X J H H M I X U I P G B Y N R L R K V D
F J S E C G V D H J N N H C J J N L N H F A M T U B F
G N A R V H B T A O U B J V H I W Y E J G M N Y J N G
I O X M B J Q W I W J V K B K I S T G R H Y B U O V H
U K C A I U A G I M N W P I Y K X S Y Y J Y V I K I N
Y M F T J I Z R O U I E V I G F A D U H H F C O M V K
Y P G S N E W H O R I Z O N S T A F I N J D X P P B L

APOLLO

KEPLER

PATHFINDER

CASSINI

MARINER

PIONEER

DAWN

MESSENGER

SPACE SHUTTLE

GEMINI

NEW HORIZONS

VIKING

JUNO

ORION

VOYAGER

OSIRIS-REX

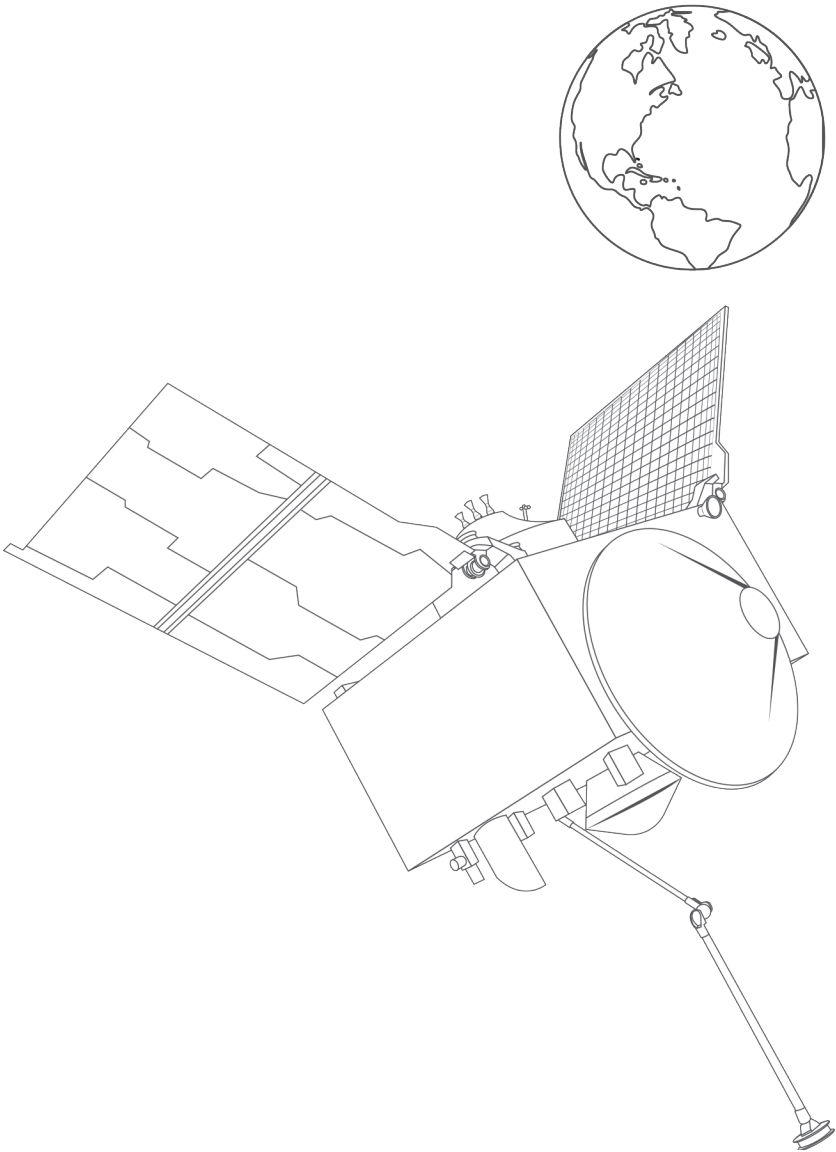

OSIRIS-REX is an unpiloted spacecraft that will travel to the asteroid Bennu and bring samples of it back to Earth. It will use cameras, lasers, spectrometers, and other instruments for viewing different wavelengths of light, to help us learn more about how planets formed and how life began.

Planetary Explorer

Fill in the blanks with words of your choice to create a story.

As a newly trained _____ for NASA, you get to
occupation

travel in the _____ spacecraft to visit _____!
constellation *planet*

The mission will take _____ years, so bring _____
number *book / movie*

to pass the time. When you get to _____, you will
same planet

live in a _____ and wear a special _____ that
building *clothing*

will help you survive the _____ environment. You
adjective

will take samples of _____ so scientists on Earth
noun

can _____ them. The best part is that you will be
verb

the first person to _____ on _____!
verb *same planet*

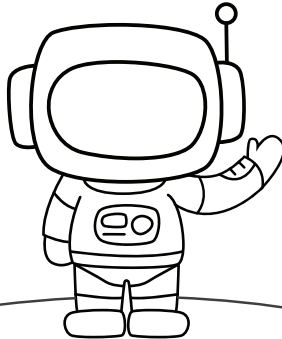

Draw NASA

Draw a picture to represent what each letter in NASA stands for.

National



Aeronautics



and

Space

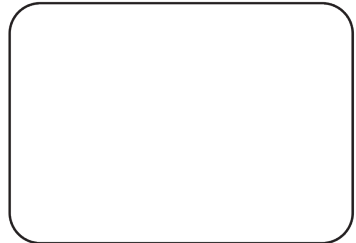

Administration

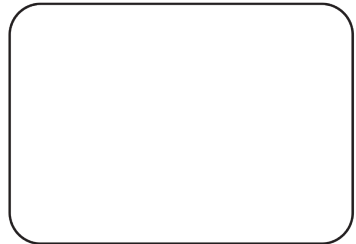

Living in Space

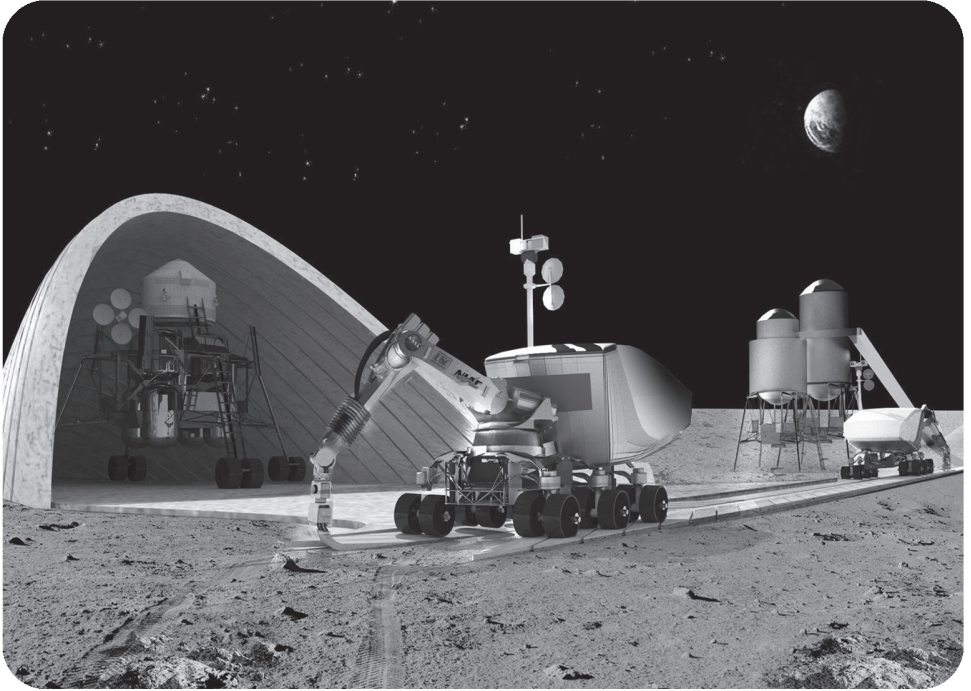

Living in space will require many things we take for granted here on Earth. A place to live in, for instance, isn't as easy to construct in space and would require innovative techniques to use the resources that are available to you. NASA is looking at innovations such as Contour Crafting technology that will use robots to help build habitats using lunar or Martian soil, allowing us to live off our planet and keep us protected.

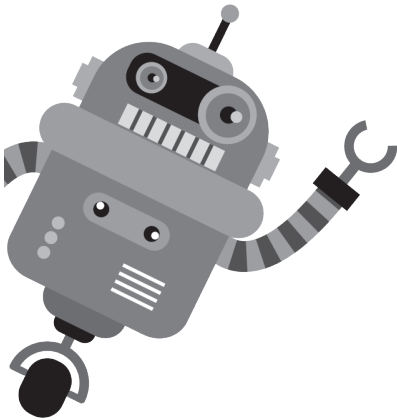
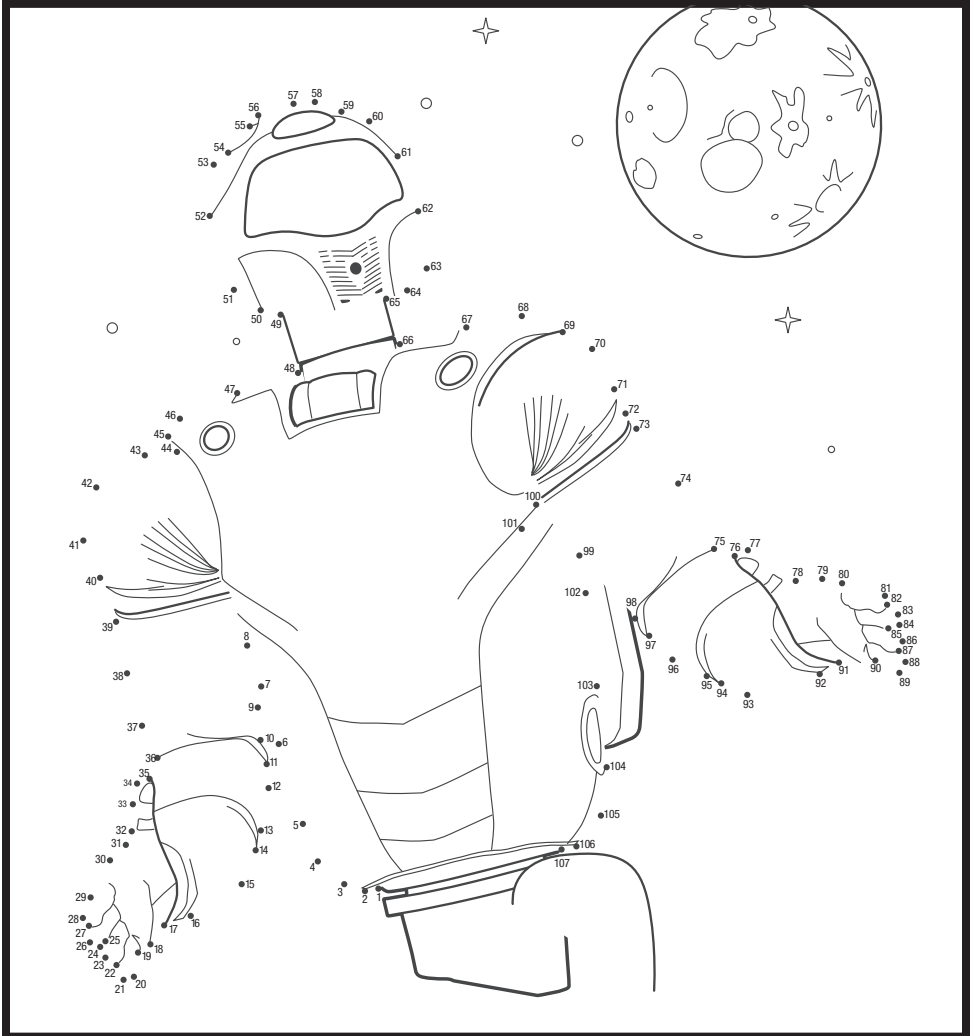

Photo Credit: Berok Khoshnevis, Director of USC Center for Rapid Automated Construction Technologies (CRAFT)

NASA's Outer Space Assistant

Connect the dots to see who's helping astronauts on the International Space Station.



Robonaut 2 (R2) is a humanoid robot that works aboard the International Space Station. It can perform tasks in microgravity and uses special climbing legs to help anchor it while it uses its hands. R2 will help astronauts make repairs to the Station.

Hidden Word

Fill in the spaces with the names of everyday objects that NASA technology has impacted. Clues to the items are below. The letters in the bold box make a secret word.

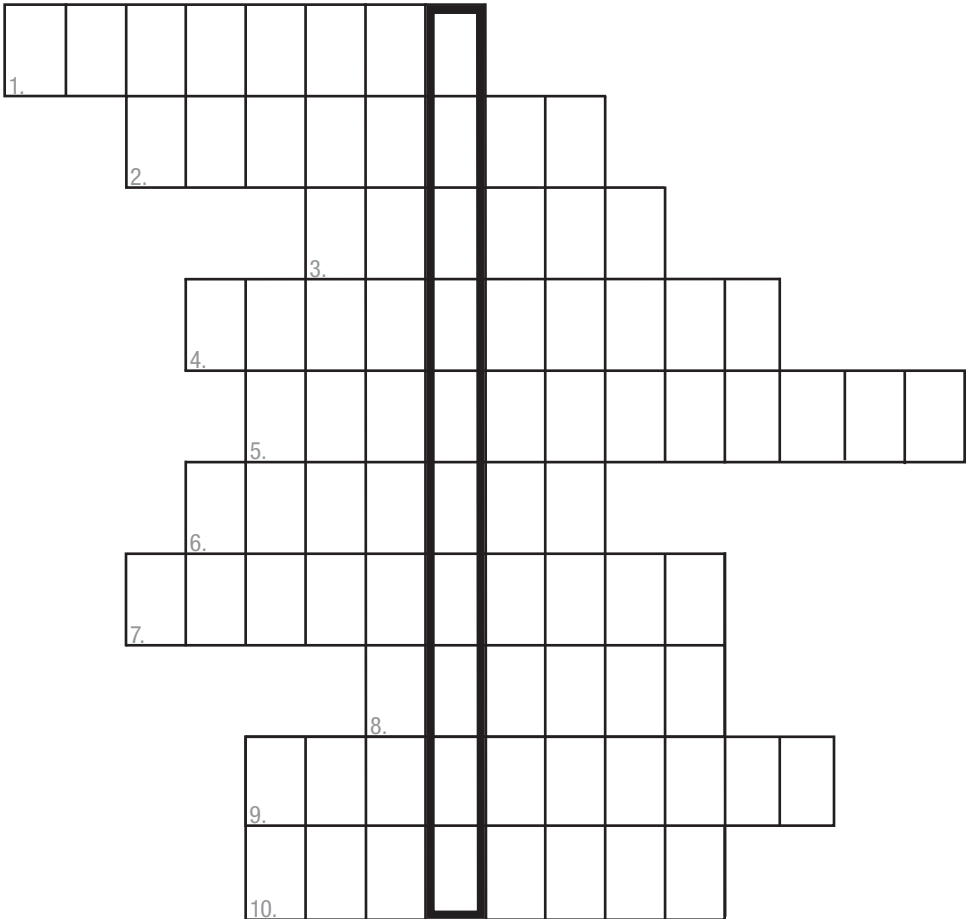

1. Worn to the pool or beach
2. What your bed sheets cover
3. A noisy machine that cleans floors
4. Squeezed from a tube to freshen your breath
5. Used to hit a ball back and forth across a net
6. Footwear used for a sport that takes place on snowy slopes
7. Tool to provide light in dark places
8. Storage box for keeping food and drinks cold
9. Protects your eyes from brightness
10. Soft, easy-to-eat food for infants

Mystery Shadows

Unscramble the letters to name the shadow.

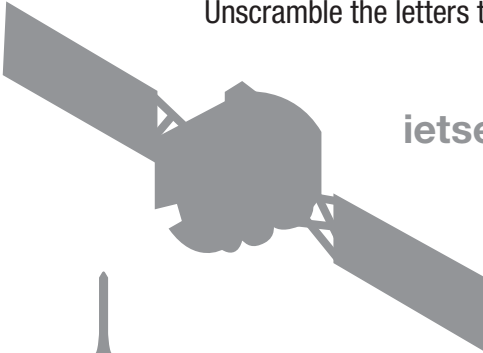

ietselalt _____

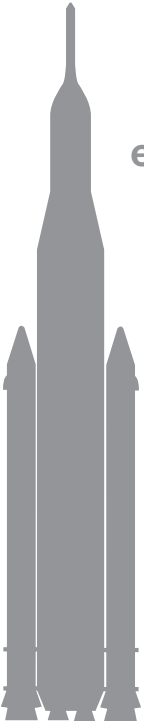

eortck _____

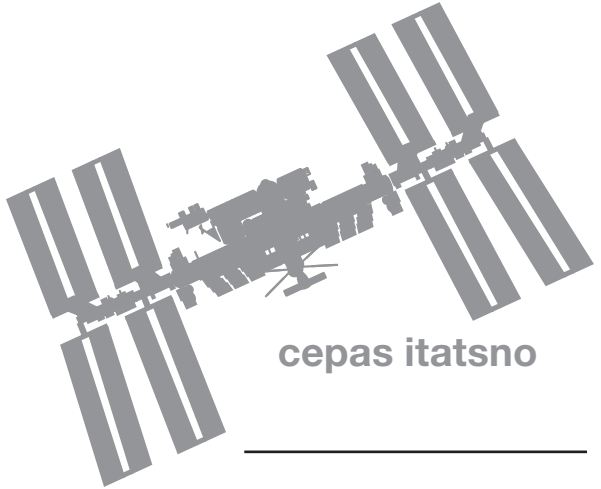

cepas itatsno _____

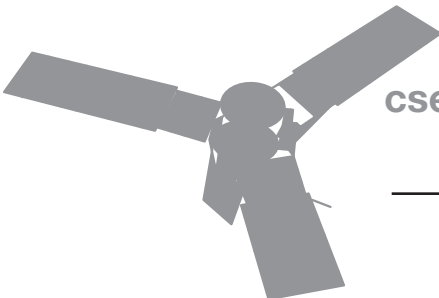

cseap robpe _____

Color the James Webb Space Telescope

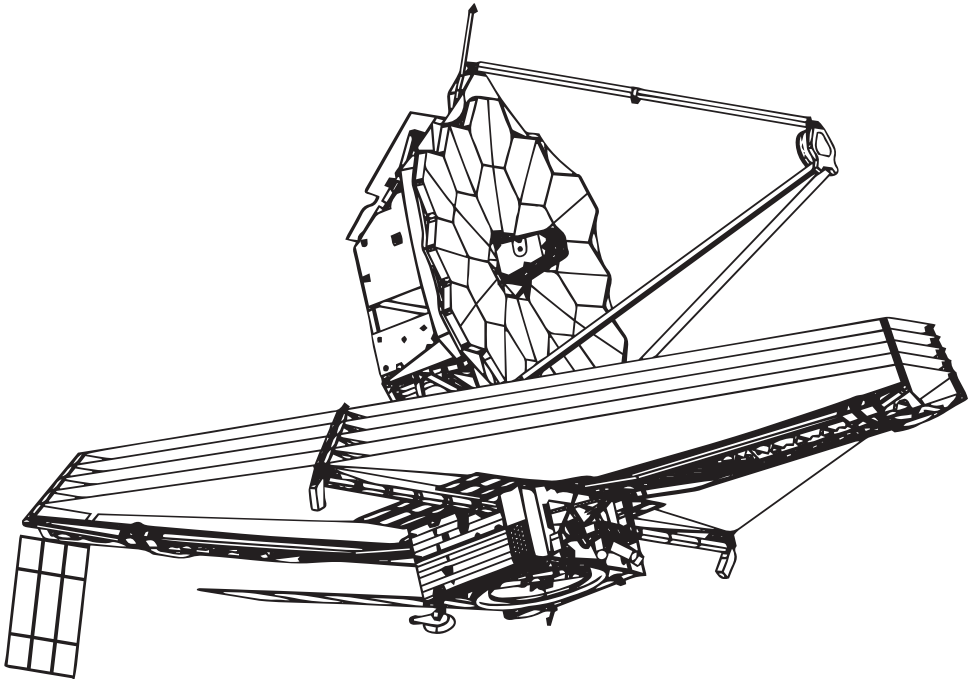

The James Webb Space Telescope (JWST) is an infrared telescope that will look deep into space to study the earliest stars and galaxies in the universe. It is more sensitive than the Hubble Telescope, with much larger mirror optics that have a highly reflective gold layer to gather lots of light.

What Do You See?

Draw what is outside the window of your deep-space habitat on Mars.

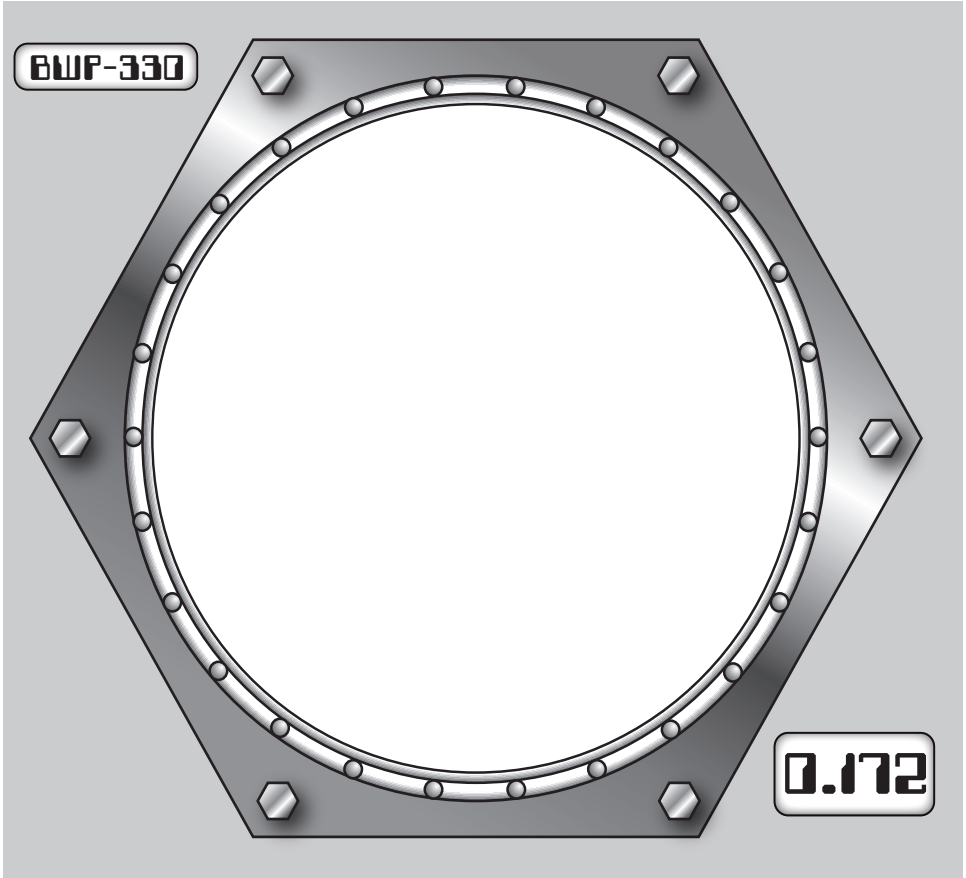

New life support technology will allow astronauts to live and work in habitats on Mars. The variable oxygen regulator keeps oxygen and pressure at a safe and comfortable level, and the rapid cycle amine swing bed takes carbon dioxide and water out of the air.

Green Propellant Infusion Mission

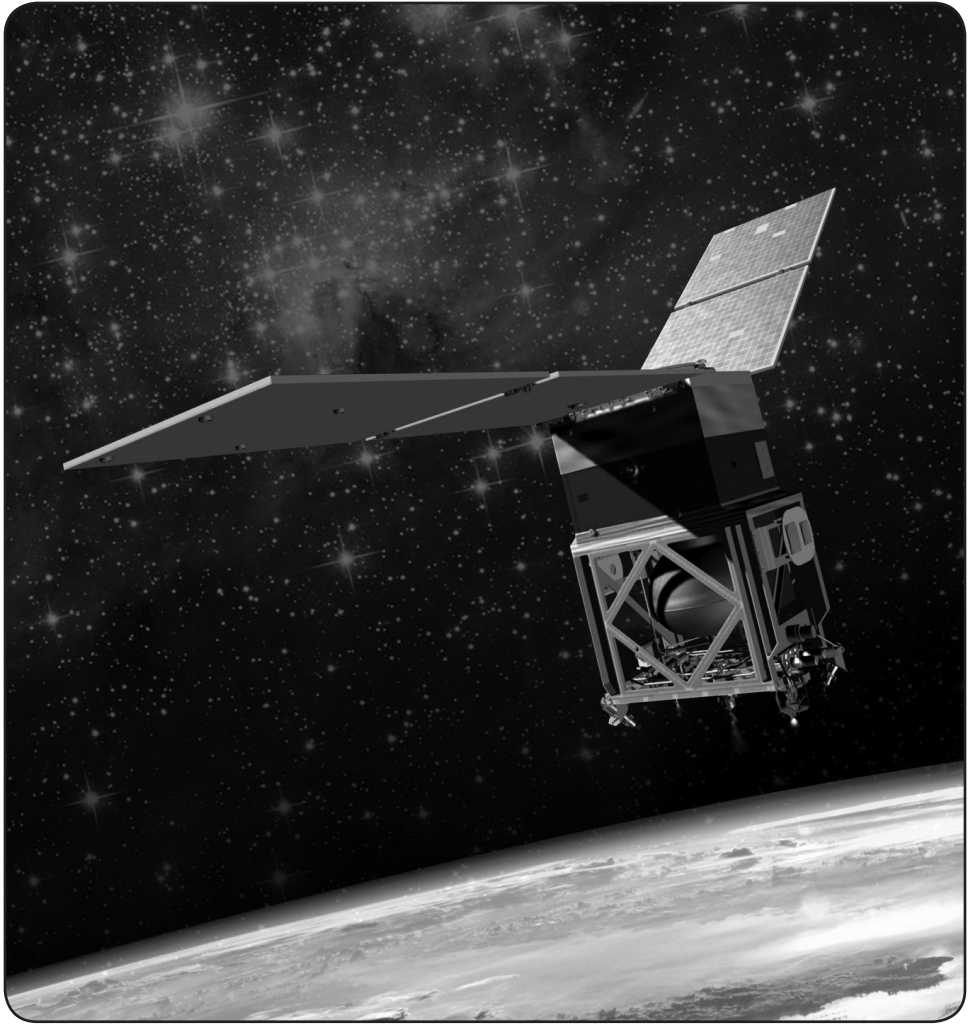

The goal of the Green Propellant Infusion Mission is to test new types of spacecraft fuel. The fuel that NASA currently uses, called hydrazine, is toxic and dangerous to handle. The new fuel will be much less harmful and will be much more environmentally friendly.

With You When You Fly

How is NASA technology improving flights at your local airport?

NASA is developing a coating that will keep bugs from sticking to the surface of planes. This improves the planes' speed because stuck bugs slow them down.



Many of today's air traffic control systems, which tell planes when it is safe to land and when to take off, are based on NASA-developed software.



LCRD

Laser Communications Relay Demonstration



The Laser Communications Relay Demonstration (LCRD) is demonstrating a new way of sending information between Earth and space. Satellites will use lasers instead of radio waves to communicate, because lasers can send much more data than radio waves. With this new and powerful system, NASA can gather more knowledge than ever, faster, on Earth and in space.

Learn how to say these words in Spanish, Chinese, French, and Russian.

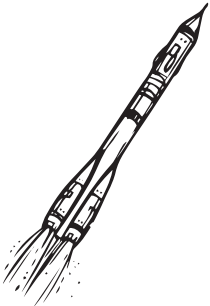

rocket
cohete
huǒjiàn
fusée
raketa (paketa)

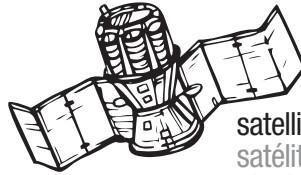

satellite
satélite
rénzào weixing
satellite
sputnik



galaxy
galaxia
xingxi
galaxie
galaktika



star
estrella
xing
étoile
zvezda



planet
planeta
xingxing
planete
planet



airplane
avion
fēist
avion
samoleb

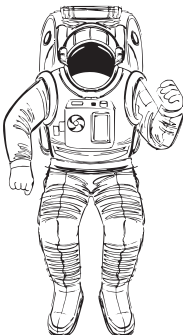

astronaut
astronaut
yǎnghángyuán
astronaut
kozmonaut



technology
tecnología
gōngyixué
technologie
tekhnologii

Juno to Jupiter

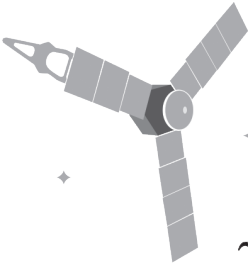

◆ Lead Juno safely through the dangerous radiation belts of Jupiter!

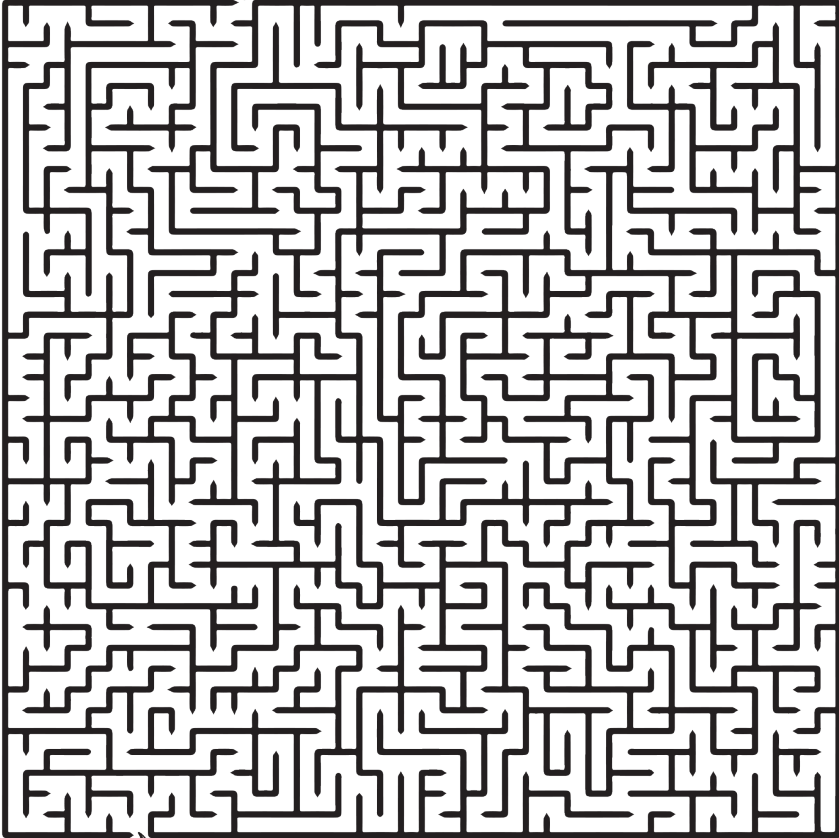

◆ Juno is a space probe that will orbit and study Jupiter. This will tell us important information about how our solar system formed. Juno's sensitive electronics must be protected from Jupiter's radiation by a titanium container.

How High Can You Go?

How many words can you make from the letters in

TECHNOLOGY?

Write your words here: _____

1–9 words: Flying high in the atmosphere

10–19 words: Low-Earth orbit

20+ words: The Moon and beyond!

Orion Maze

Help Orion find Mars!

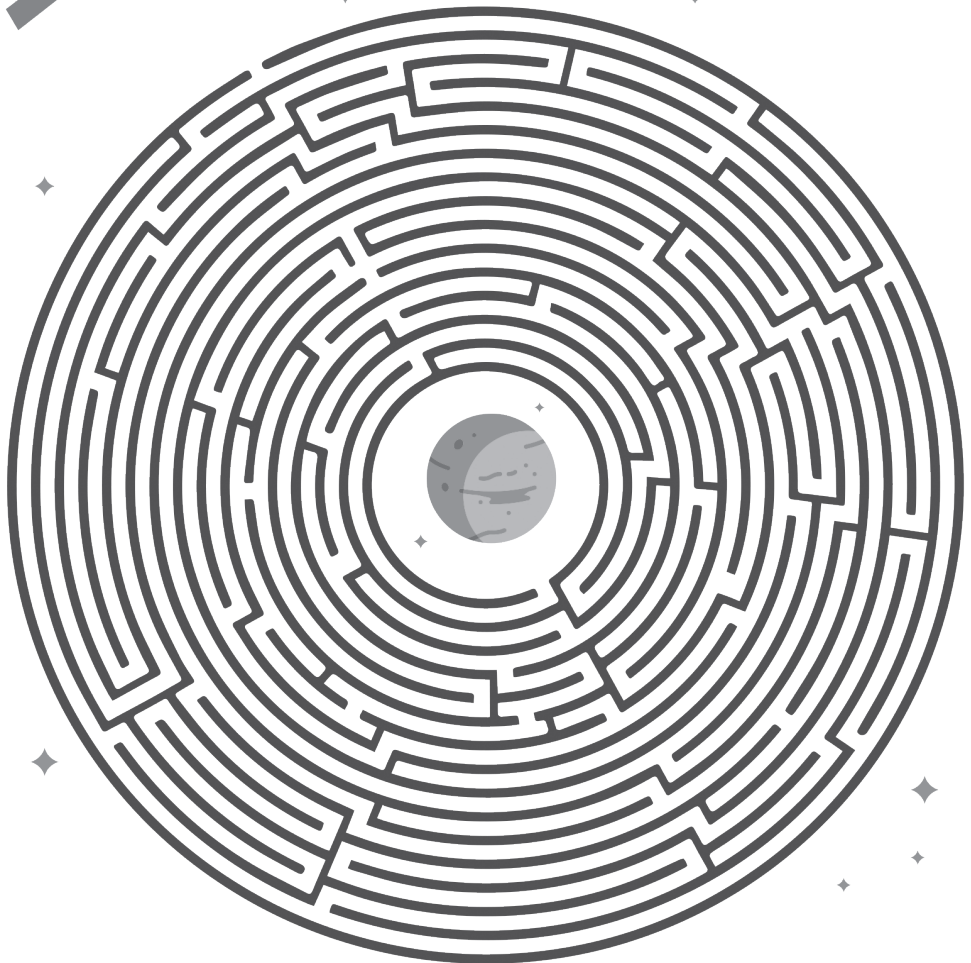
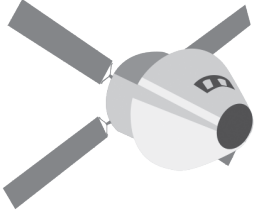

Orion is a spacecraft that will carry astronauts to Mars and beyond. It will be NASA's most advanced spacecraft in order to keep crew safe during their mission. It is designed to support long periods of space travel and to withstand the harsh environment of reentry into atmosphere.

How Fast?

Match the spacecraft with its speed.

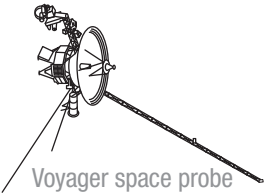
A.  17,150 mph

Voyager space probe

B.  36,373 mph (launch)

B52B launch aircraft

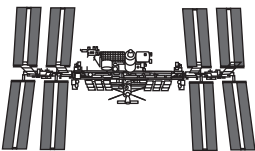
C.  38,610 mph

International Space Station

D.  24,791 mph (fastest piloted spacecraft)

New Horizons (Pluto space probe)

E.  448 mph

Apollo 10

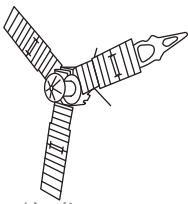
F.  4,520 mph (fastest piloted aircraft)

Juno (Jupiter space probe)

G.  165,000 mph

X-15 hypersonic plane

Build the NASA Ring Wing Glider

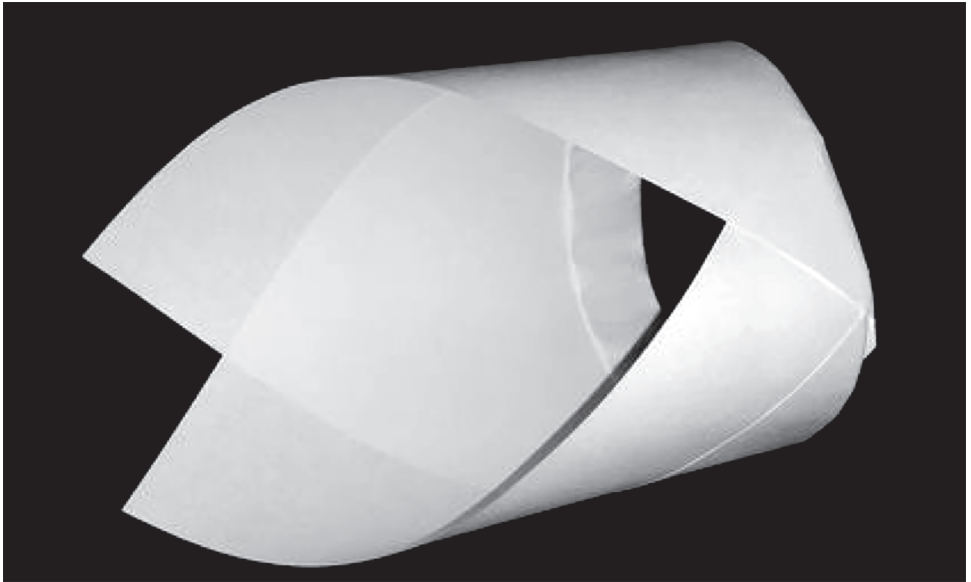

Procedure

1. Fold a piece of 8.5- × 11-inch paper diagonally as shown in diagram 1.
2. Make a 1/2-inch fold along the previously folded edge. See diagram 2.
3. Make a second 1/2-inch fold. See diagram 3.
4. Curl the ends of the paper to make a ring and tuck one end into the fold of the other. See diagram 4.
5. Gently grasp the “V” between the two “crown points” with your thumb and index finger.
6. Toss the glider lightly forward.
Note: The folds in the paper make the airplane’s front end heavy and the back end light. Curling the ends to make a ring changes the shape of the wing and improves the wing’s flight performance.

Diagram 1

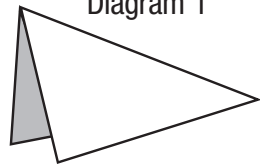

Diagram 2

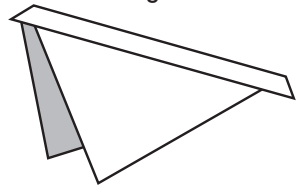

Diagram 3

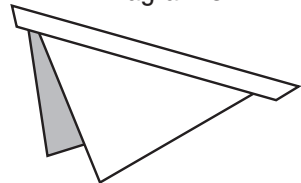
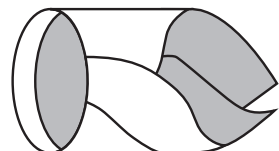

Diagram 4



Spinoff Fun Facts

Every year, NASA develops new technology that helps Earth research and space exploration. These innovations often go on to change life on Earth, too. What are some inventions in your life that got their start at NASA?

Ski boots came from the boots in an astronaut's spacesuit that let the wearer move around while the feet remained attached to the surface.



Today's baby formula was created when scientists discovered a healthy ingredient for babies in algae that they were using to develop life support.



Modern big rig trucks are designed with curves that help air move past the vehicle better. This is based on NASA's research on making vehicles faster and more aerodynamic.

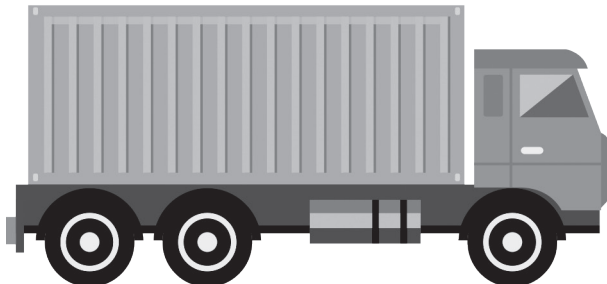

Stay up-to-date with NASA's newest technologies and missions.

Follow us:



Twitter: @NASA_Technology



Facebook: @NASATechnology



Instagram: @NASA



tumblr: nasa.tumblr.com



YouTube: NASA.gov.Video



Snapchat: @nasa

Download the free NASA app:



Get the latest content, including news, features, images, videos, NASA TV, and tweets!

Available for:



Apple



Android



Apple TV



Kindle Fire

Answers for pages 7, 9, 18, 19 and 29

page 7, Lab Tech

wrench safety glasses test tube
microscope tape measure computer
calculator thermometer screwdriver

page 9, Life on Mars

1. satellite on left missing two solar panels
2. one antenna removed from middle satellite
3. different flying saucer
4. three stars missing from right corner
5. mars rover facing opposite direction
6. spots on comet removed
7. light spots and right side crater removed
8. controls on astronaut's spacesuit missing

page 18, Hidden Word

1. swimsuit
2. mattress
3. vacuum
4. toothpaste
5. tennisracket
6. skiboats
7. flashlight
8. cooler
9. sunglasses
10. babyfood

Hidden word: TECHNOLOGY

page 19, Mystery Shadows

satellite
rocket
space station
space probe

page 29, How Fast?

- A = 38,610 mph
B = 448 mph
C = 17,150 mph
D = 36,373 mph (launch)
E = 24,791 mph (fasted piloted spacecraft)
F = 165,000 mph
G = 4,520 mph (fasted piloted aircraft)



SPACE TECH FUNPAD