



2018 NATIONAL RURAL FENCING PRODUCT GUIDE

Australian made and owned fencing solutions



PHONE - 1800 627 722 • FAX - (08) 9377 3888

WEBSITE - www.southernwire.com.au • EMAIL - enquiries@southernwire.com.au

CONTACTS

Southern Wire Pty Ltd

Head Office & Manufacturing

311 Collier Road Bassendean WA 6054

Mailing Address:

PO Box 3232 Bassendean DC WA 6942



Phone: +61 8 9279 9999

Fax: +61 8 9377 3888



Orders:

orders@southernwire.com.au

Enquiries:

enquiries@southernwire.com.au

SA Warehouse

Phone: 1800 627 722

Wingfield SA 5013

VIC Warehouse

Phone: 1800 627 722

Altona North VIC 3025

NSW Warehouse

Phone: 1800 627 722

Campbelltown NSW 2560

QLD Warehouse

Phone: 1800 627 722

Rocklea QLD 4106

WHO WE ARE

Southern Wire was established in 1994 and is a leading Australian manufacturer of farm fencing. Our focus on quality and innovation from the beginning has ensured that Southern Wire now offers a range of superior farm fencing products and solutions that are unrivalled in the market.

Reasons to buy Southern Wire

From the outset, Southern Wire successfully introduced a stronger hinged joint fencing, fabricated totally from high tensile wire. This was followed by Griplock, the 'fixed knot' fence renowned worldwide for being the strongest pre-fabricated farm fence available on the market. Griplock continues to replace the older 'ring joint' fences, capturing a steadily increasing market share.

More recently there's Fastlock, the new high performance fencing, featuring a new generation 'square knot' design for increased strength and safety.

Now there's FarmFence which supersedes the old 'ring joint' and 'hinged joint' type fences by offering outstanding economy combined with high tensile, heavy galvanised construction, one-piece vertical wires and stronger, easier to handle joints.

Southern Wire products have built a reputation synonymous with quality and unmatched durability, meaning they are insisted on for projects where the best fence is of paramount importance. They have been used to bring many successful projects to completion, ranging in diversity from sheep studs in WA's Great Southern region to airstrips in the Murchison, from exotic animal enclosures in South East Asia to cattle ranches in North America.

The quality of all Southern Wire's range of products is guaranteed and backed by the full resources of the company. Southern Wire exceeds the Australian Standard requirements at every stage of our manufacturing process, ensuring that our full range of fencing can be confidently specified in the most demanding of environments across rural Australia.

If you require additional information, ask your fencing agent or Freecall Southern Wire for assistance on **1800 627 722**.

CONTENTS

PREFABRICATED FENCING & WIRE NETTING Page

FarmFence _____	4
Fastlock Toughline _____	5
Fastlock Premier50 _____	6
Griplock _____	7
Hinged Joint Toughline _____	8
Fastlock HorseFence _____	9
Fastlock Vermin _____	10
Griplock Vermin _____	11
Vermin Exclusion Fencing _____	12-13
Wire Netting _____	14



BARBED WIRE & PLAIN WIRE Page

Barbed Wire _____	15
Fencing Wire _____	16-17
Trellis Wire _____	17



STEEL POSTS, SPACERS & END ASSEMBLIES Page

Steel Fence Posts _____	18-19
Rapid Posts _____	20-21
End Assemblies _____	22-23



FARM GATES & MESH Page

Farm Gates for WA _____	24-26
Cattle Gates _____	25
Horse Gates _____	25
5 Bar Gates _____	26
Vermin Exclusion Gates _____	26
Farm Gates for SA, VIC, TAS, NSW & QLD _____	27
Sheepyard Mesh _____	28

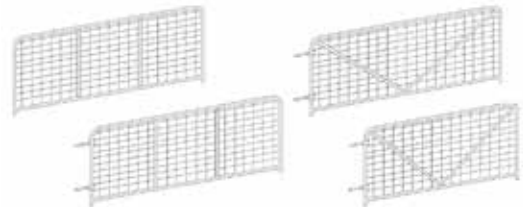

CHAINMESH FENCING Page

Chainmesh _____	29
Galvanised Pipe _____	30
Chainmesh Gates _____	31
Hinges & Pipe Fittings _____	32



FENCING TOOLS & ACCESSORIES Page

33-34



For WIRE SPACINGS

see page 36.



FARMFENCE SQUARE KNOT



FarmFence

FarmFence is a high quality, Australian manufactured product that is positioned to represent fair value for the price conscious buyer.

The 2.50mm heavy galvanised wire used to manufacture FarmFence has a minimum 230 grams/sqm zinc coating making it far superior to standard galvanised wire which is only 40 grams/sqm of zinc. The strong square knot that locks the vertical and horizontal wires together reduces the risk of the wires slipping compared to products like ring joint. FarmFence also has a 'one piece' vertical wire meaning it does not need to be clipped to support wires like hinged joint.

For extra strength 2.80mm top and bottom wires see the Fastlock Toughline range on page 7. For the highest corrosion resistant wire see the Fastlock Premier50 range on page 8.

Southern Wire FarmFence offers::

- **Good Value** - Manufactured in Australia using high quality 2.50mm heavy galvanised wire.
- **Strength** - Square knot locks the vertical and horizontal wires to minimise the risk of wires sliding.
- **Stability** - One piece vertical wires to provide vertical integrity.

CODE	PRODUCT	DESCRIPTION	LENGTH (m)	WEIGHT (kg)	ROLLS PER PALLET
7510	5/70/30	Sheep, Tree Protection	200	61	9
7509	5/70/30	Sheep, Tree Protection	500	152	4
7515	5/70/45	Sheep, Tree Protection	200	53	9
7512	5/70/90	Sheep, Tree Protection	500	115	5
7520	6/70/30	Sheep, Lamb, Tree Protection	200	69	9
7522	6/70/30	Sheep, Lamb, Tree Protection	500	173	4
7530	6/90/30	Cattle	200	74	9
7531	6/90/30	Cattle	500	186	4
7505	7/90/30	All Stock	200	83	9
7506	7/90/30	All Stock	500	207	4
7535	8/90/15	Intensive Stocking, Boundary	100	61	9
7536	8/90/15	Boundary	50	30	16
7540	8/90/30	Intensive Stocking, Boundary	200	91	9
7542	8/90/30	Boundary	500	229	4

Prices exclude GST and include delivery to your freight depot in Australian state capital cities.



For WIRE SPACINGS

see page 36.

FASTLOCK SQUARE KNOT



Fastlock® Toughline

Fastlock Toughline is a high quality, Australian manufactured product designed to suit a wide range of fencing applications.

With extra strength 2.80mm high tensile top and bottom wires, Fastlock Toughline is designed to handle the pressure of animals trying to push under or lean over the fence. All wires are heavy galvanised (minimum 230 grams/sqm zinc coating) for superior longevity. The strong square knot which locks the vertical and horizontal wires together reduces the risk of the wires slipping compared to products like ring joint. Fastlock Toughline also has a 'one piece' vertical wire meaning it does not need to be clipped to support wires like hinged joint.

For the highest corrosion resistant wire see the Fastlock Premier50 range on page 8.

Southern Wire Fastlock® Toughline provides:

- **Longevity** - Manufactured in Australia using high quality, heavy galvanised wire.
- **Durability** - 2.80mm high tensile top and bottom wires to manage heavy stock pressure.
- **Strength** - Square knot locks the vertical and horizontal wires to minimise the risk of wires sliding.
- **Stability** - One piece vertical wires to provide vertical integrity.
- **Easy to use** - Snag free rolls and compact knot means no-hassle unrolling and even wire tension.

CODE	PRODUCT	DESCRIPTION	LENGTH (m)	WEIGHT (kg)	ROLLS PER PALLET
7020	6/70/30	Sheep, Lamb	200	73	9
7021	6/70/30	Sheep, Lamb	500	183	4
7030	6/90/30	Sheep, Cattle	200	78	9
7033	6/90/45	Sheep	500	172	4
7105	7/90/30	All Stock	200	87	9
7106	7/90/30	All Stock	500	217	4
7111	7/90/45	All Stock	500	193	4
7035	8/90/15	Intensive Stocking, Boundary	100	63	9
7037	8/90/15	Intensive Stocking, Boundary	250	156	4
7040	8/90/30	Boundary	200	95	9
7041	8/90/30	Boundary	500	238	4

Prices exclude GST and include delivery to your freight depot in Australian state capital cities. For minimum purchase quantities please speak to your Southern Wire representative.



For WIRE SPACINGS

see page 36.

FASTLOCK SQUARE KNOT



Fastlock® Premier50®

Fastlock Premier50 is designed specifically for the harshest of environments and sets an industry standard for superior wire longevity.

Originally developed for the aquaculture industry, the Premier50 wire coating technology provides farmers with the assurance that they are fencing for the future generations. Fastlock Premier50 combines this assurance with the strength of the Square Knot and 2.80mm high tensile top and bottom wires to create a premium, market leading fence. Whether fencing for higher pressure situations in high corrosion areas, or simply wanting to ensure the best fence possible is erected, Fastlock Premier50 is the preferred option.

Southern Wire Fastlock® Premier50® offers:

- **Extended Longevity** - Manufactured in Australia using Premier50 coated wire.
- **Durability** - 2.80mm high tensile top and bottom wires to manage heavy stock pressure.
- **Strength** - Square knot locks the vertical and horizontal wires to minimise the risk of wires sliding.
- **Stability** - One piece vertical wires to provide vertical integrity.
- **Easy to use** - Snag free rolls and compact knot means no-hassle unrolling and even wire tension.

CODE	PRODUCT	DESCRIPTION	LENGTH (m)	WEIGHT (kg)	ROLLS PER PALLET
7630	5/70/30	Sheep, Tree Protection	500	161	4
7620	6/70/30	Sheep, Lamb, Tree Protection	200	73	9
7621	6/70/30	Sheep, Lamb, Tree Protection	500	183	4
7615	6/90/30	Sheep, Cattle	200	78	9
7616	6/90/30	Sheep, Cattle	500	195	4
7600	7/90/30	All Stock	200	87	9
7601	7/90/30	All Stock	500	217	4
7610	8/90/15	Intensive Stocking, Boundary	100	63	9
7605	8/90/30	Boundary	200	95	9
FASTLOCK VERMIN PREMIER50					
7625	11/90/15	Vermin	100	78	9
7625F	11/90/15	Vermin, with 30cm Hinged Apron	100	100	9

Prices exclude GST and include delivery to your freight depot in Australian state capital cities. For minimum purchase quantities please speak to your Southern Wire representative.



For WIRE SPACINGS

see page 36.

GRIPLOCK FIXED KNOT



Griplock®

Griplock is made to withstand extreme pressure that would normally destroy hinged joint and ring joint fences.

High tensile line wires and one piece vertical wires are locked with the unique Fixed Knot, giving Griplock maximum resistance to impact damage. Manufactured using premium quality heavy galvanised wire (minimum 230 grams/sqm of zinc), farmers can be assured that their Griplock fence will be 'Stronger for Longer'.

Griplock is used in areas with significant vermin presence and by discerning landowners who believe in building fences right the first time. Toughline fences have extra strength 2.80mm top and bottom wires.

Southern Wire Griplock® offers:

- **Longevity** - Manufactured in Australia using high quality heavy galvanised wire.
- **Durability** - Toughline fences have 2.80mm top and bottom wires to manage heavy stock pressure.
- **Extreme Strength** - Super strong Griplock knot that eliminates the risk of the vertical wires slipping.
- **Stability** - One piece vertical wires to provide vertical integrity.

CODE	PRODUCT	DESCRIPTION	LENGTH (m)	WEIGHT (kg)	ROLLS PER PALLET
GRIPLOCK - All Wires 2.50mm Heavy Galvanised.					
6215	5/70/60	Sheep, Station, Tree Protection	500	130	5
6220	6/70/30	Sheep, Lamb	200	75	9
6230	6/90/30	Cattle	200	80	9
6231	6/90/45	Cattle	250	86	9
6232	6/90/60	Cattle, Tree Protection	500	158	5
6235	8/90/15	Intensive Stocking, Boundary	100	70	9
6240	8/90/30	Boundary	200	101	9
6242	8/90/30	Boundary	400	209	4
GRIPLOCK TOUGHLINE - 2.80mm High Tensile Top and Bottom Wires.					
6305	7/90/30	All Stock	200	94	9
6308	7/90/30	All Stock	500	236	3
6310	7/90/45	All Stock	200	82	9

Prices exclude GST and include delivery to your freight depot in Australian state capital cities. For minimum purchase quantities please speak to your Southern Wire representative.



For WIRE SPACINGS

see page 36.

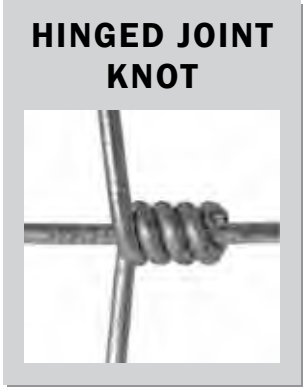

Hinged Joint Toughline

Southern Wire's Hinged Joint Toughline is manufactured in Australia using high quality, heavy galvanised wire.

The Hinged Knot construction and two way tension crimps allows the fence to flex up over hills and down through valleys. The knot also means that should an animal or fallen tree crush the top of the fence it can be easily straightened back to its vertical position. The heavy galvanised wire used to manufacture Hinged Joint Toughline has a minimum 230 grams/sqm zinc coating which compares to standard galvanised wire which is only 40 grams/sqm of zinc. Hinged Joint Toughline comes with high tensile 2.80mm top and bottom wires for extra strength.

Southern Wire Hinged Joint Toughline offers:

- **Longevity** - Manufactured in Australia using high quality, heavy galvanised wire.
- **Durability** - 2.80mm high tensile top and bottom wires to manage heavy stock pressure.
- **Flexibility** - Two way wire crimps and hinged knot construction allows it to follow contours.

CODE	PRODUCT	DESCRIPTION	LENGTH (m)	WEIGHT (kg)	ROLLS PER PALLET
2015	6/70/30	Sheep. Lamb	200	74	9
2020	6/70/30	Sheep. Lamb	500	185	4
2030	7/90/30	All Stock	200	87	9
2035	7/90/30	All Stock	500	218	4
2040	8/90/15	Intensive Stocking, Boundary	100	63	9
2045	8/90/30	Boundary	200	96	9

Prices exclude GST and include delivery to your freight depot in Australian state capital cities. For minimum purchase quantities please speak to your Southern Wire representative.





For WIRE SPACINGS

see page 36.

FASTLOCK SQUARE KNOT



Fastlock® HorseFence

Fastlock HorseFence is manufactured in Australia and designed to be a safe and secure fencing option for equine properties. It is used widely on horse studs throughout North America, Europe and Australia.

The high tensile, heavy galvanised horizontal wires have crimps or bends in the wire at 15cm intervals allowing the fence to absorb pressure should an animal lean against it. Once the animal is off the fence, the high tensile wire will return to its original position. This compares to other horse fence products which are made from soft wire and therefore tend to sag over time.

The knot used to secure the horizontal and vertical wires is smooth on both sides to prevent injury when animals rub against the fence. The closely spaced 5cm wide and 10cm high wire openings prevent horses from stepping through or becoming tangled in the fence minimising the risk of serious injury.

The 90cm and 120cm high sizes are available in 100m rolls to reduce the number of joins required when fencing long sections.

CODE	PRODUCT	DESCRIPTION	LENGTH (m)	WEIGHT (kg)	ROLLS PER PALLET
7113	10/90/5	Horse	50	70	5
7117	10/90/5	Horse	100	140	3
7200	13/120/5	Horse	50	90	5
7209	13/120/5	Horse	100	180	3
7205	16/150/5	Horse	50	110	5
7215	19/180/5	Horse	50	130	5

Horse Gates

Refer Page 25 for product listing.

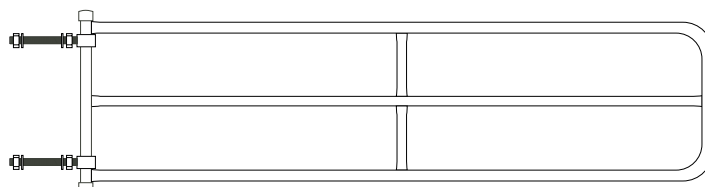

Prices exclude GST and include delivery to your freight depot in Australian state capital cities. For minimum purchase quantities please speak to your Southern Wire representative.

For WIRE SPACINGS

see page 12.



FASTLOCK SQUARE KNOT



Fastlock® Vermin

The Southern Wire Fastlock Vermin range is specially engineered to provide the easiest and most effective option for vermin exclusion fencing.

Developed in conjunction with landowners and government departments, Fastlock Vermin is constructed with one piece vertical wires and the strong Fastlock knot to ensure it will withstand pressure from the most determined of animals. It is also available in some sizes with a hinged footer section that is machine knotted to the base of the fence, offering a fully integrated barrier against kangaroos, wallabies, wombats and wild dogs.

Southern Wire Fastlock® Vermin offers:

- **Longevity** - Manufactured in Australia using high quality, heavy galvanised wire.
- **Strength** - FarmFence knot to minimise the risk of the vertical wire slipping.
- **Stability** - Single picket wire to provide long-lasting vertical integrity.
- **Durability** - Optional hinged footer to prevent vermin from pushing under the fence.

CODE	PRODUCT	DESCRIPTION	LENGTH (m)	WEIGHT (kg)	ROLLS PER PALLET
7546	5/40/15	Attachable apron	250	84	8
7551	11/90/15	Vermin	100	78	9
7551F	11/90/15	Vermin, with 30cm Hinged Apron	100	100	9
7553	8/115/15	Vermin	100	69	9
7552	8/115/30	Vermin	200	102	9
7562	11/115/15	Vermin	250	208	4
7555F	11/115/15	Vermin, with 30cm Hinged Apron	250	267	4
7549	12/115/15	Vermin	250	220	4
7549F	12/115/15	Vermin, with 30cm Hinged Apron	250	279	4
7422F	12/150/15	Vermin, with 30cm Hinged Apron	250	301	4
7421	13/150/15	Vermin, with 30cm Hinged Apron	250	313	4
7255	15/150/15	Vermin	100	111	9
7255F	15/150/15	Vermin, with 30cm Hinged Apron	250	336	4

Prices exclude GST and include delivery to your freight depot in Australian state capital cities.

For minimum purchase quantities please speak to your Southern Wire representative.



For WIRE SPACINGS

see page 12.

GRIPLOCK FIXED KNOT



Griplock® Vermin

Griplock provides the ultimate in exclusion fencing for exotic animals and vermin. Manufactured with all wires 100% high tensile and heavy galvanised, they combine the best features of strength, corrosion resistance and purpose built design.

Due to the strength and durability, these Griplock fences are commonly specified by government departments for vermin fencing and are also the fence of choice for regional airstrips. With the widest range of high fences available, you can be assured that there will be a Griplock fence to suit your specific application.

Southern Wire Griplock® Vermin offers:

- **Longevity** - Manufactured in Australia using high quality, heavy galvanised wire.
- **Strength** - Super strong Griplock knot that eliminates the risk of the vertical wires slipping.
- **Stability** - Able to withstand extreme vermin pressure.

CODE	PRODUCT	DESCRIPTION	LENGTH (m)	WEIGHT (kg)	ROLLS PER PALLET
6406	8/120/15	Boundary, Dog, Goat	100	77	9
6410	8/120/30	Internal Dog, Goat	200	108	9
6415	10/110/15	Emu, Vermin, Goat	100	87	9
6435	15/150/15	Internal Deer, Game	100	129	5
6440	15/150/30	Internal Deer, Game	200	187	5
6446	16/180/15	Boundary Deer, Game, including 30cm radius apron	250	364	3
6430	13/190/30	Boundary, Emu, Ostrich	200	176	5
6445	17/190/15	Boundary Deer, Game	100	152	5
6450	17/190/30	Boundary Deer, Game	200	217	5
6455	20/240/15	Roadside, Boundary, Security	100	183	5
6460	20/240/30	Roadside, Boundary, Security	100	130	5

Prices exclude GST and include delivery to your freight depot in Australian state capital cities.

For minimum purchase quantities please speak to your Southern Wire representative.



Vermin Exclusion Fencing

Over the past 10 years, Southern Wire has supplied 1000's of kilometres of vermin exclusion fencing to the Western Queensland and Western New South Wales regions. Some of the common sizes can be found below, however Southern Wire has the ability to manufacture a fence to your exact requirement ensuring the fence does not cost you more than it needs to suit your application. Many of these sizes suit the Rapid Post which are available at 2.1m, 2.3m or 2.4m lengths. The 2.4m Rapid Posts are also available in n EXTRA heavy post that weighs 75% more than the standard size Rapis Post.

- Customisable wire configurations to suit your application.
- Sizes that suit Rapid Posts to allow fast installation.
- Available in 250m or 500m rolls to reduce wire joining.

CODE	PRODUCT	DESCRIPTION	LENGTH (m)	WEIGHT (kg)	ROLLS PER PALLET
7562	11/115/15	Fastlock	250	208	4
7555F	11/115/15	Fastlock with 30cm Hinged Apron	250	267	4
7549	12/115/15	Fastlock	250	220	4
7549F	12/115/15	Fastlock with 30cm Hinged Apron	250	279	4
7422F	12/150/15	Fastlock with 30cm Hinged Apron	250	301	4
7421	13/150/15	Fastlock with 30cm Hinged Apron	250	313	4
7255	15/150/15	Fastlock	100	111	9
7255F	15/150/15	Fastlock with 30cm Hinged Apron	250	336	4
6446	16/180/15	Griplock including 30cm Radius Apron	250	364	3

Prices exclude GST and include delivery to your freight depot in Australian state capital cities.
For minimum purchase quantities please speak to your Southern Wire representative.

Vermin Exclusion Fencing Options

The Griplock with Radius Apron has what is widely regarded as the strongest fencing knot on the market. It is designed to withstand the extreme pressure placed on fences that are in an area with significant vermin presence.

The wire spacings of the 16/180/15 Griplock allow the bottom 300mm section to be radiused onto the ground to prevent animals from being able to push under the fence.

This product comes standard with 2.8mm wires at the top and bottom as well as where the fence is radiused to create the apron. Additional 2.8mm wires can be added to the fence on request.

Product Features:

- Griplock fixed knot – stands up to extreme vermin pressure.
- All wires heavily galvanised.
- 2.8mm wires at the top, bottom and edge of the apron.
- Additional 2.8mm wires available on request.
- Available in 250m and 500m rolls.

11/115/15
with 30cm Hinged Apron



14 Hole Post

15/150/15 Fastlock
with 30cm Hinged Apron

with one top barbed
or plain wires

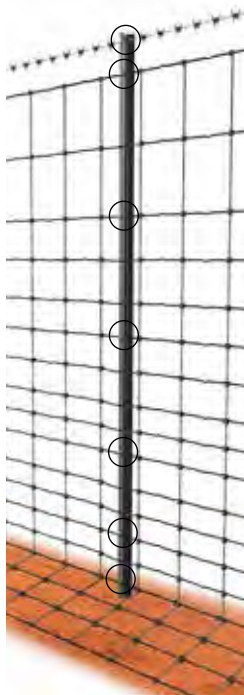

7 Clip Post

16/180/15 Griplock
including 30cm Radius Apron

with one top barbed
or plain wires

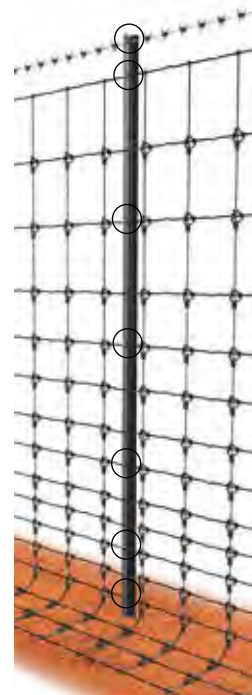

7 Clip Post

○ Wire lines up with clip

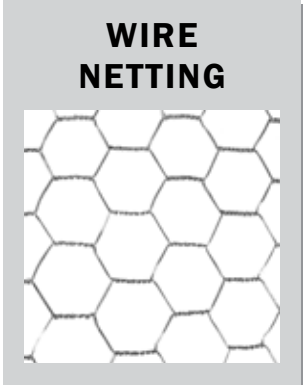

Wire Netting

Southern Wire Netting is a premium quality Australian made netting designed to effectively exclude vermin as well as control stock.

Choose our heavy galvanised netting for maximum durability and longevity. It lasts up to 6 times long life than standard galvanised netting.



Southern Wire Wire Netting offers:

- **Longevity** - Heavy galvanised netting is made from 1.4mm heavy galvanised wire.
- **Stability** - Twin selvedge wires for ease of tensioning and extra strength.
- **Efficiency** - Larger core to minimise end of roll wastage and allow for easy unrolling.

CODE	PRODUCT	DESCRIPTION	LENGTH (m)	WEIGHT (kg)	ROLLS PER PALLET
HEAVY GALVANISED WIRE NETTING					
9125	30/4/1.4mm	Rabbit	50	14	32
9101	30/4/1.4mm	Rabbit	100	28	18
9126	60/4/1.4mm	Rabbit	50	26	16
9116	60/4/1.4mm	Rabbit	100	51	9
9103	90/4/1.4mm	Rabbit	50	38	16
9105	90/4/1.4mm	Rabbit	100	75	9
9107	105/4/1.4mm	Rabbit	50	44	16
9109	105/4/1.4mm	Rabbit	100	87	9
9124	120/4/1.4mm	Rabbit	50	51	16
9117	120/4/1.4mm	Rabbit	100	102	9
9102	180/4/1.4mm	Rabbit	50	75	16
9118	180/4/1.4mm	Rabbit	100	150	9
STANDARD GALVANISED WIRE NETTING					
9111	90/5/1.0mm	Chicken	50	14	25
9112	90/3/0.9mm	Chicken	50	21	25
9113	180/5/1.0mm	Chicken	50	28	20

Prices exclude GST and include delivery to your freight depot in Australian state capital cities. For minimum purchase quantities please speak to your Southern Wire representative.



Barbed Wire

Southern Wire's range of high tensile, reverse twist barbed wire offers the full range of sizes from 1.57mm through to the traditional 2.50mm Iowa.

The economy barbed wire is wound on a wooden spool with a wire handle, whilst the premium barbed wire has a user friendly material handle and heavy duty spool.



HIGH TENSILE BARBED WIRE



IOWA BARBED WIRE

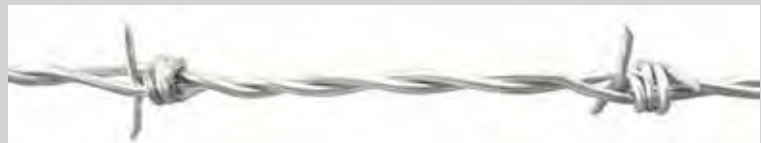

CODE	PRODUCT	LENGTH (m)	WEIGHT (kg)	ROLLS PER PALLET
8406	1.57mm Economy Barbed Wire, High Tensile, Heavy Galvanised	500	24	36
8407	1.57mm Premium Barbed Wire, High Tensile, Heavy Galvanised	500	24	32
8416	1.80mm Economy Barbed Wire, High Tensile, Heavy Galvanised	500	28	36
8417	1.80mm Premium Barbed Wire, High Tensile, Heavy Galvanised	500	28	32
8421	1.80mm Premium Barbed Wire, High Tensile Premier50	500	28	32
8418	2.00mm Premium Barbed Wire, High Tensile, Heavy Galvanised	500	35	36
8430	2.50mm Iowa Barbed Wire, Soft, Galvanised	400	45	27

Prices exclude GST and include delivery to your freight depot in Australian state capital cities. For minimum purchase quantities please speak to your Southern Wire representative.



Fencing Wire

Southern Wire offers a full range of heavy galvanized plain wires to support our pre-fabricated fence range.

The FlexiWire and StrongWire are appropriate for most fence building requirements, with a range of other wires from 2.0mm to 4.0mm available for special projects.



Selected sizes of Plainwire is available in the unique Reel Easy 1500m coils. The Reel Easy coils have had exceptional take up across Australia as they largely eliminate tangles and dispensing issues that are common with the traditional rolls. They can be particularly useful when erecting multiple strands of Plainwire which is common in many areas across Australia.



View the **Reel-Easy** video at:
www.southernwire.com.au

CODE	PRODUCT	UOM	LENGTH (m)	WEIGHT (kg)	ROLLS PER PALLET
8303	2.00mm TieWire, Soft Tensile, Heavy Galvanised	Coil	200	5	1
8205	2.50mm FenceWire, Soft Tensile, Heavy Galvanised	Coil	1300	50	10
8215	3.15mm FenceWire, Soft Tensile, Heavy Galvanised	Coil	750	46	10
8220	4.00mm FenceWire, Soft Tensile, Heavy Galvanised	Coil	500	49	10
8001	2.50mm FlexiWire, Medium Tensile, Heavy Galvanised	Handy Coil	300	12	10
8006	2.50mm FlexiWire, Medium Tensile, Heavy Galvanised	Coil	1500	58	10
8006S	2.50mm FlexiWire, Medium Tensile, Heavy Galvanised	Reel-Easy	1500	61	18
8105	2.50mm StrongWire, High Tensile, Heavy Galvanised	Coil	1500	58	10
8105S	2.50mm StrongWire, High Tensile, Heavy Galvanised	Reel-Easy	1500	61	18
8110	2.80mm StrongWire, High Tensile, Heavy Galvanised	Coil	1000	48	10
8110S	2.80mm StrongWire, High Tensile, Heavy Galvanised	Reel-Easy	1000	51	18
8320	5.5mm White HorseWire	Roll	400	43	10

Prices exclude GST and include delivery to your freight depot in Australian state capital cities.
 For minimum purchase quantities please speak to your Southern Wire representative.

Fencing Wire Premier50

In a world first for the rural and viticulture industries, Southern Wire introduces the Premier50 coating on our range of PlainWire fencing products.

The Premier50 coating was developed for the aquaculture industry where it is used in the harshest ocean environments. Southern Wire has taken this technology and applied it to its rural fencing products to ensure that the Plainwire Premier50 is the product of choice for farmers and growers across Australia.

Selected sizes of Plainwire Premier50 is available in the unique Reel Easy 1500m coils. The Reel Easy coils have had exceptional take up across Australia as they largely eliminate tangles and dispensing issues that are common with the traditional rolls. They can be particularly useful when erecting multiple strands of Plainwire which is common in many areas across Australia.



CODE	PRODUCT	UOM	LENGTH (m)	WEIGHT (kg)	ROLLS PER PALLET
PLAINWIRE PREMIER50 - Premier50 Coated					
8007	2.50mm FlexiWire, Medium Tensile	Coil	1500	58	10
8007S	2.50mm FlexiWire, Medium Tensile	Reel-Easy	1500	61	18
8107	2.50mm StrongWire, High Tensile	Coil	1500	58	10
8107S	2.50mm StrongWire, High Tensile	Reel-Easy	1500	61	18
8111	2.80mm VinWire, High Tensile	Coil	1000	48	10
8111S	2.80mm VinWire, High Tensile	Reel-Easy	1000	51	18

Trellising Wire

Southern Wire has a range of Trellis Wires both in the traditional heavy galvanised wire coating (minimum 230 grams/sqm zinc) and also in the revolutionary Premier50 wire coating.

The trellis wire is also available in some sizes on the time saving Reel Easy Wooden Spools.

CODE	PRODUCT	UOM	LENGTH (m)	WEIGHT (kg)	ROLLS PER PALLET
VINWIRE - Heavy Galvanised					
8200	2.00mm VinWire	Reel-Easy	4000	99	9
8315	2.65mm VinWire	Coil	1000	43	10
8315S	2.65mm VinWire	Reel-Easy	1000	46	18
8110	2.80mm VinWire	Coil	1000	48	10
8110S	2.80mm VinWire	Reel-Easy	1000	51	18
8216	3.15mm VinWire	Coil	1000	60	10
8216S	3.15mm VinWire	Reel-Easy	1000	63	18
VINWIRE PREMIER50					
8202	2.00mm VinWire	Coil	2000	50	10
8313	2.65mm VinWire	Coil	1000	43	10
8313S	2.65mm VinWire	Reel-Easy	1000	46	18
8111	2.80mm VinWire	Coil	1000	48	10
8111S	2.80mm VinWire	Reel-Easy	1000	51	18
8217	3.15mm VinWire	Coil	1000	61	10

Prices exclude GST and include delivery to your freight depot in Australian state capital cities. For minimum purchase quantities please speak to your Southern Wire representative.



Steel Fence Posts

Southern Wire’s range of steel posts are manufactured according to our exact specification. Rolled from high quality steel billet, the heavy weight posts are precision cut to ensure they do not twist and turn as they are driven into the ground. Uniform holes are then simultaneously punched for uniformity and consistency. The post are available with a black bituminous coating or hot dip galvanised for extended longevity.

The EXTRA Heavy Duty Steel posts are designed for superior strength and weigh 3.55kg per metre.

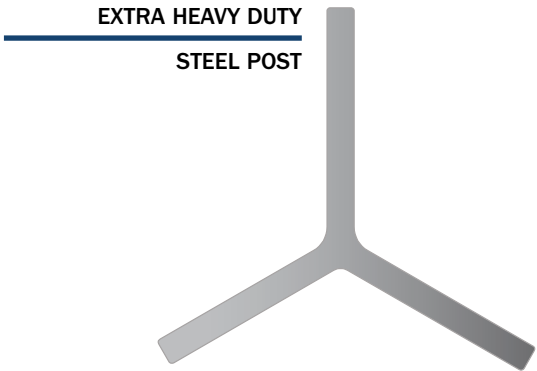
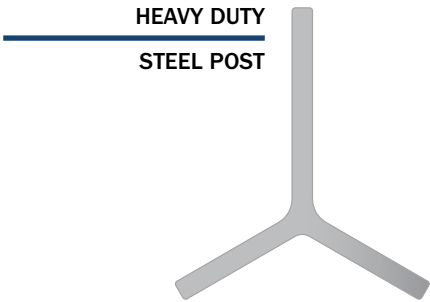
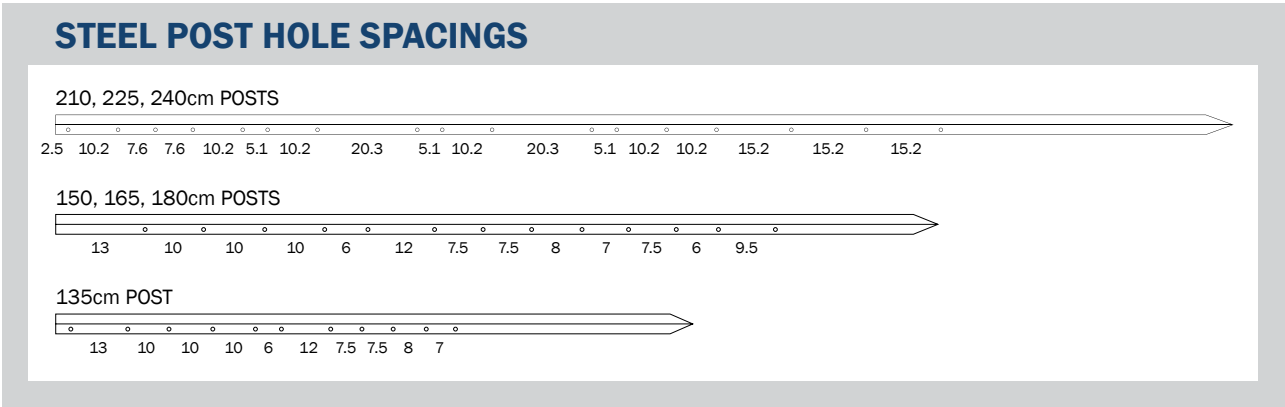

Heavy Duty Black Steel Posts



Heavy Duty Galvanised Steel Posts



CODE	PRODUCT	WEIGHT (kg)	POSTS PER SLING
HEAVY DUTY BLACK STEEL POSTS			
8505	135cm Black Steel Post	2.5	400
8510	150cm Black Steel Post	2.8	400
8515	165cm Black Steel Post	3.1	400
8520	180cm Black Steel Post	3.3	400
8526	210cm Black Steel Post	3.9	200
8527	225cm Black Steel Post	4.2	200
8525	240cm Black Steel Post	4.5	200
HEAVY DUTY GALVANISED STEEL POSTS			
8535	135cm Galvanised Steel Post	2.5	400
8560	150cm Galvanised Steel Post	2.8	400
8565	165cm Galvanised Steel Post	3.1	400
8570	180cm Galvanised Steel Post	3.3	400
8532	210cm Galvanised Steel Post	3.9	200
8595	240cm Galvanised Steel Post	4.5	200
EXTRA HEAVY DUTY BLACK STEEL POSTS			
8529	240cm Black Steel Post	8.5	100
EXTRA HEAVY DUTY GALVANISED STEEL POSTS			
8548	180cm Galvanised Steel Post	6.4	100
8549	210cm Galvanised Steel Post	7.5	100
8360	240cm Galvanised Steel Post	8.5	100

Prices exclude GST and include delivery to your freight depot in Australian state capital cities.
For minimum purchase quantities please speak to your Southern Wire representative.



View the **Rapid Post** video at:
www.southernwire.com.au

Rapid Post

The Southern Wire Rapid Post is designed to speed up fencing and make installation easier. The revolutionary self-sprung stainless steel clip firmly holds the fencing wire in the slot doing away with the need to cut tie wire saving both time, money and frustration!

The Rapid Posts are manufactured from steel billet which is rolled to form the Y shape. They are heavy weight compared to many other posts at 2.04kg per metre with precision cut ends to prevent the post from twisting as they are driven into the ground. The posts are hot dip galvanised after processing.

The Rapid Posts are available in both 9 clip and 14 clip versions and in lengths of 165cm and 180cm. See over the page for the different fence designs that can be achieved using the Rapid Posts.

- Revolutionary stainless steel spring clip to speed up wire fastening process by up to 8 times.
- Rolled from high quality steel billet for superior longevity.
- Precision cut ends to prevent post from twisting as they are driven into the ground.
- EXTRA heavy weight (3.55kg per metre) 180cm and 240cm posts available.

CODE	PRODUCT	WEIGHT (kg)	PACK SIZE
HEAVY DUTY GALVANISED RAPID POSTS			
8353	165cm Rapid Post (9 Clip)	3.4	Bundle of 10 or Sling of 400
8353-C	165cm Rapid Post (14 Clip)	3.4	Bundle of 10 or Sling of 400
8354	180cm Rapid Post (9 Clip)	3.7	Bundle of 10 or Sling of 400
8356	180cm Rapid Post (14 Clip)	3.7	Bundle of 10 or Sling of 400
8355	210cm Rapid Post (7 Clip)	4.3	Bundle of 10 or Sling of 200
8357	230cm Rapid Post (7 Clip)	4.7	Bundle of 10 or Sling of 200
8358	240cm Rapid Post (7 Clip)	4.9	Bundle of 10 or Sling of 200
EXTRA HEAVY DUTY GALVANISED RAPID POSTS			
8352	180cm Rapid Post (9 Clip)	6.4	Bundle of 10 or Sling of 100
8359	240cm Rapid Post (7 Clip)	8.5	Bundle of 10 or Sling of 100

Prices exclude GST and include delivery to your freight depot in Australian state capital cities.
 For minimum purchase quantities please speak to your Southern Wire representative.

RAPID POST CLIP SPACINGS

165cm 9 Clip Rapid Post

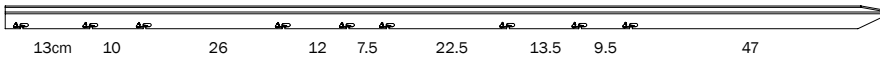

165cm 14 Clip Rapid Post

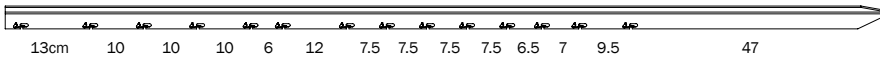

180cm 9 Clip Rapid Post

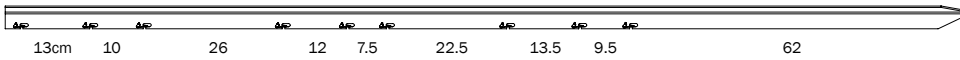

180cm 14 Clip Rapid Post

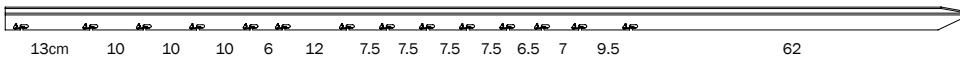

210cm 7 Clip Rapid Post

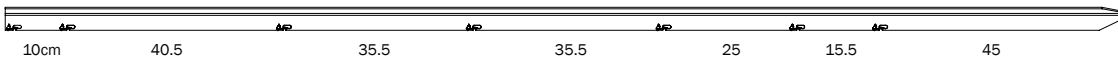

230cm 7 Clip Rapid Post

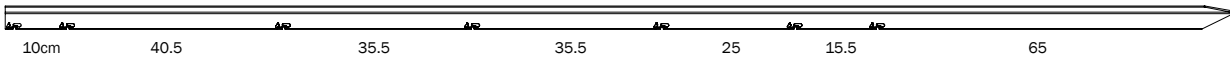

240cm 7 Clip Rapid Post



Below are the Southern Wire fence configurations which suit the 165cm and 180cm Rapid Posts. For fence designs to suit the 210cm, 230cm and 240cm please see page 13.

6/70/30

with top and bottom barbed or plain wires

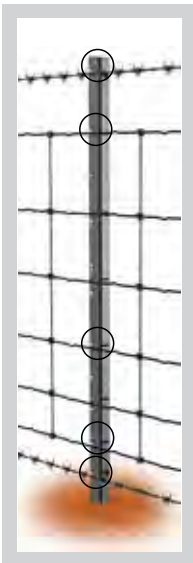

14 Clip Post

6/90/30

with two top barbed or plain wires

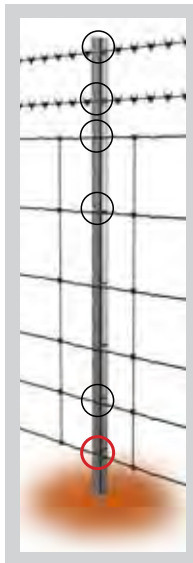

14 Clip Post

7/90/30

with one bottom barbed or plain wire



9 Clip Post

with top and bottom barbed or plain wires



9 Clip Post

with two top barbed or plain wires



9 Clip Post

8/90/30

with top and bottom barbed or plain wires

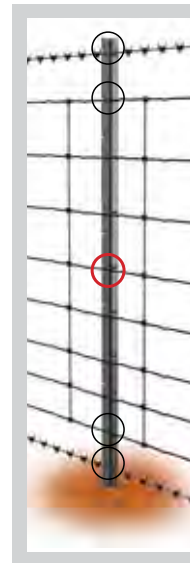

9 Clip Post

with two top barbed or plain wires

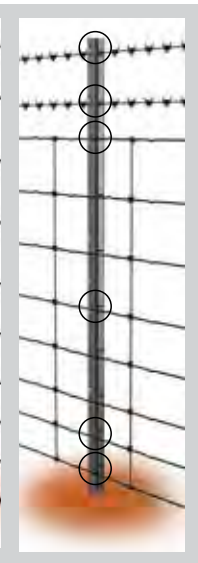

9 Clip Post

- Wire lines up with clip
- Wire lifted into clip



Strainer Assemblies

Heavy duty galvanised steel strainer assemblies take the effort out of fencing and guarantee your fence will still be standing in twenty years time. The most popular strainer, the 80/40 Tubular Strainer is concreted into the ground, while the Drive-In End assembly is simply driven into the ground. All strainers are manufactured from heavy duty steel, unlike other brands.

Tubular Strainer 80/40 Heavy Duty



CODE	PRODUCT	WEIGHT (kg)
TUBULAR STEEL STRAINER ASSEMBLIES - All Heavy Grade Pipe		
8605	80/40 Tubular Strainer Assembly - 2.1m post & 2.1m strut	27
G80M21C	80mm Strainer Post and Cap	18
8610	Extra 2.1m strut & fitting to suit 8605	8
8611	Extra 3.25m strut & fitting to suit 8605	12
8612	80/40 Tubular Strainer Assembly - 2.6m post & 3.25m strut	34
8613	Extra 3.25m strut & fitting to suit 8612	12

Prices exclude GST and include delivery to your freight depot in Australian state capital cities. For minimum purchase quantities please speak to your Southern Wire representative.



Drive-In End Assembly

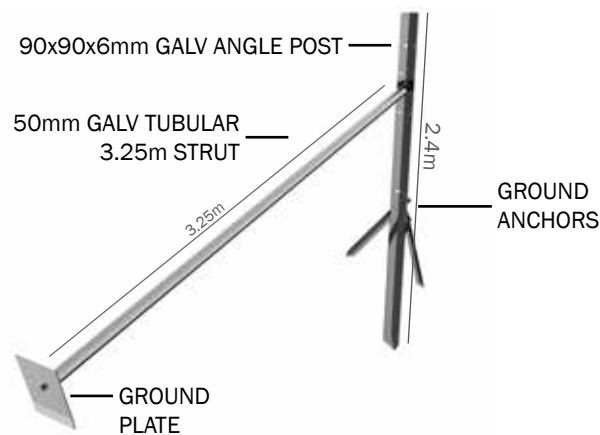

CODE	PRODUCT	WEIGHT (kg)
DRIVE-IN STRAINER ASSEMBLIES		
8615	2.4m Drive-In End Assembly	39
8616	2.1m Drive-In End Assembly	36
8620	Extra strut to suit Drive-In End Assembly	10

Prices exclude GST and include delivery to your freight depot in Australian state capital cities. For minimum purchase quantities please speak to your Southern Wire representative.

Farm Gates

Southern Wire manufactures an extensive range of heavy duty galvanised farm gates with 1.2m high fully welded pipe frames, vertical or vee bracing and 150mm x 100mm galvanised weldmesh as standard. Available with a range of Elgate farm gate fittings packs or the popular welded on Brooker galvanised hinge fittings.

Farm Gates provides:

- **Strength** - Profile cut pipe ends for extra strength welds.
- **Quality** - Fully automated fabrication for quality and consistency.
- **Durability** - Australian made to handle Australian conditions.

Vertical Brace Plain

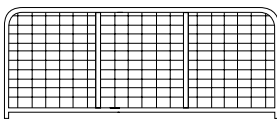

Vertical Brace with Brooker

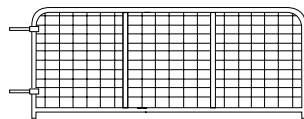

Vee Brace Plain

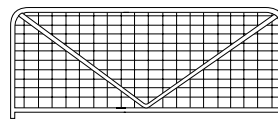

Vee Brace with Brooker

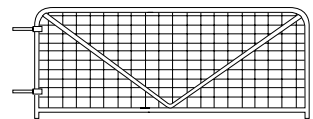

Farm Gates for Western Australia

PRODUCT	VERTICAL BRACE CODE	VEE BRACE CODE	WEIGHT (kg)
FARM GATES – PLAIN - 150mm x 100mm Mesh			
1.0m (3ft) opening	8803	-	14
1.2m (4ft) opening	8801C	-	15
1.5m (5ft) opening	8802C	-	16
1.8m (6ft) opening	8806C	-	17
2.4m (8ft) opening	8804	8804C	22
3.0m (10ft) opening	8809	8809C	27
3.6m (12ft) opening	8814	8814C	31
4.2m (14ft) opening	8819	8819C	34
4.8m (16ft) opening	8824	8824C	38
FARM GATES – WITH BROOKER HINGE FITTINGS - 150mm x 100mm Mesh			
1.0m (3ft) opening	8800	-	17
1.2m (4ft) opening	8801	-	18
1.5m (5ft) opening	8802	-	19
1.8m (6ft) opening	8806	-	20
2.4m (8ft) opening	8805	8807	25
3.0m (10ft) opening	8810	8812	30
3.6m (12ft) opening	8815	8817	34
4.2m (14ft) opening	8820	8822	37
4.8m (16ft) opening	8825	8827	41

Prices exclude GST and include delivery to your freight depot in Australian state capital cities.
For minimum purchase quantities please speak to your Southern Wire representative.

Cattle Gates

Southern Wire custom manufacturers heavy duty cattle gates using 32mm galvanised pipe. Choose these gates for high pressure situations.

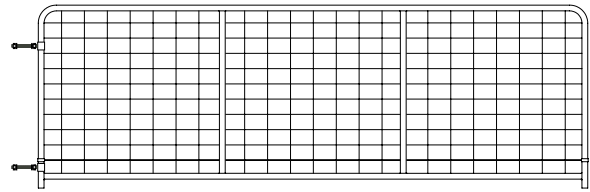

CODE	PRODUCT	WEIGHT (kg)
CATTLE GATES - WITH BROOKER HINGE FITTINGS - Heavy Duty 32NB Pipe, 1200mm High		
8852	3.0m (10ft) opening	
8853	3.6m (12ft) opening	
8823	4.2m (14ft) opening	
8854	4.8m (18ft) opening	

Horse Gates

Southern Wire horse gates are heavy duty three bar gates manufactured from 32NB pipe. Height is 900mm and they are generally installed approximately 300 - 400mm above the ground to prevent horses from sustaining any injury.

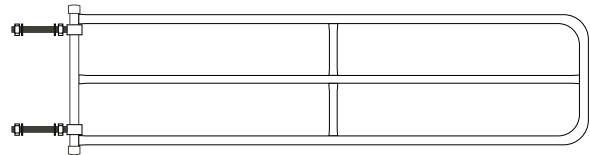

CODE	PRODUCT	WEIGHT (kg)
HORSE GATES - WITH BROOKER HINGE FITTINGS - Heavy Duty 32NB Pipe, 900mm High		
8833	1.8m (6ft) actual	17
8832	2.4m (8ft) actual	22
8834	3.0m (10ft) actual	27
8835	3.6m (12ft) actual	31
8857	4.2m (14ft) actual	36

CODE	PRODUCT	DESCRIPTION	WEIGHT (kg)
GATE FITTINGS			
8905	FGP2 Fittings Pack	Screw-In Hinge Strap and Bottom Gudgeon	
FGP7	FGP7 Fittings Pack	Screw-In Hinge Strap and Bottom Gudgeon	
8910	FGP4 Fittings Pack	Bolt-Thru Hinge Strap and Bottom Gudgeon	
8915	FGP20 Fittings Pack	Bolt-On Brooker Hinge	
KQS2S	32mm Brooker Hinge		
SH8025	SH8025 Hinge		
SH8032	SH8032 Hinge		
8920	DGCLI Double Gate Chain Latch		
8925	CAC1 Screw-In Ring Chain Latch		

8905 - FGP2 Fittings Pack

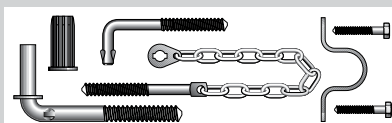

8910 - FGP4 Fittings Pack

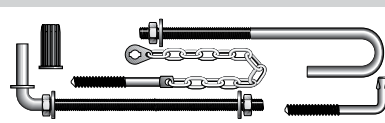

8915 - FGP20 Fittings Pack

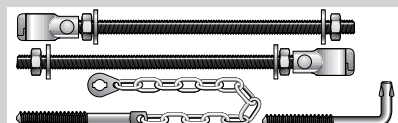

Prices exclude GST and include delivery to your freight depot in Australian state capital cities. For minimum purchase quantities please speak to your Southern Wire representative.

Economy Farm Gates for Western Australia

CODE	PRODUCT	WEIGHT (kg)
ECONOMY FARM GATES – PLAIN - 250mm x 100mm Mesh		
8804E	2.4m (8ft) opening	21
8809E	3.0m (10ft) opening	25
8814E	3.6m (12ft) opening	29
8819E	4.2m (14ft) opening	32
8824E	4.8m (18ft) opening	37
ECONOMY FARM GATES – WITH BROOKER HINGE FITTINGS - 250mm x 100mm Mesh		
8804EB	2.4m (8ft) opening	21
8809EB	3.0m (10ft) opening	25
8814EB	3.6m (12ft) opening	29
8819EB	4.2m (14ft) opening	32
8824EB	4.8m (18ft) opening	40

5 Bar Cattle Gates

CODE	PRODUCT	WEIGHT (kg)
5 BAR CATTLE GATES – PLAIN - 32mm NB, 1200mm High		
8855A	3.0m (14ft) actual	20
8856A	3.6m (12ft) actual	23
8858A	4.2m (14ft) actual	26
8859A	4.8m (16ft) actual	29

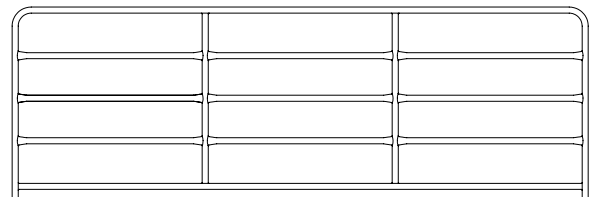

Vermin Exclusion Gates

Southern Wire custom manufacturers heavy duty vermin gates using 25mm galvanised pipe. Choose these gates to complement your vermin exclusion fencing.

CODE	PRODUCT	WEIGHT (kg)
VERMIN GATES – PLAIN - 25mm NB, 1600mm High		
8862	2.4m (12ft) actual	
8868	3.0m (14ft) actual	
8863	3.6m (12ft) actual	
8864	4.2m (14ft) actual	
8865	4.8m (16ft) actual	

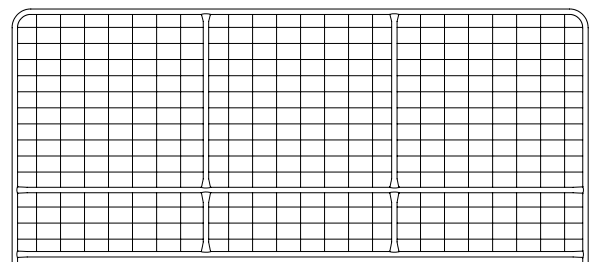

Prices exclude GST and include delivery to your freight depot in Australian state capital cities. For minimum purchase quantities please speak to your Southern Wire representative.

Farm Gates for South Australia, Victoria, New South Wales, Queensland, Northern Territory

Southern Wire manufactures an extensive range of heavy duty galvanised farm gates with 1.2m high fully welded pipe frames, vertical or vee bracing and 150mm x 100mm galvanised weldmesh as standard. Available with a range of Elgate farm gate fittings packs or the popular welded on Brooker galvanised hinge fittings.

Farm Gates provides:

- **Strength** - Profile cut pipe ends for extra strength welds.
- **Quality** - Fully automated fabrication for quality and consistency.
- **Durability** - Australian made to handle Australian conditions.

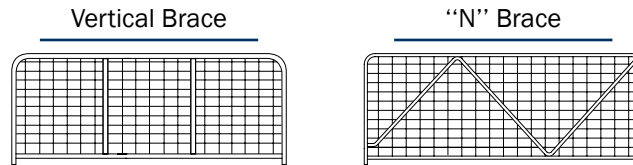

PRODUCT	VERTICAL BRACE		'N' BRACE	
	CODE	WEIGHT (kg)	CODE	WEIGHT (kg)
FARM GATES – PLAIN - 150mm x 100mm Mesh				
1.0m (3ft) actual	8803A	14	-	-
1.2m (4ft) actual	8801A	15	-	-
1.5m (5ft) actual	8802A	16	-	-
1.8m (6ft) actual	8806A	17	-	-
2.4m (8ft) actual	8804A	22	-	-
3.0m (10ft) actual	8809A	27	8808N	30
3.6m (12ft) actual	8814A	31	8813N	34
4.2m (14ft) actual	8819A	34	8818N	37
4.8m (16ft) actual	8824A	38	8826N	41
5.4m (18ft) actual	-	-	8828N	45
6.0m (20ft) actual	-	-	8829N	49

CODE	PRODUCT	WEIGHT (kg)
CATTLE GATES – PLAIN - Heavy Duty 32mm NB Pipe, 1200mm High		
8852A	3.0m (10ft) actual	
8853A	3.6m (12ft) actual	
8823A	4.2m (14ft) actual	
8854A	4.8m (18ft) actual	

Prices exclude GST and include delivery to your freight depot in Australian state capital cities. For minimum purchase quantities please speak to your Southern Wire representative.



Sheeppark Mesh

Quality locally manufactured galvanised sheeppark mesh available in 6.0m sheets.

CODE	PRODUCT	DESCRIPTION	WEIGHT (kg)
SHEEPPARK WELDED MESH SHEETS - Galvanised			
9005	SWSM Red 6.0m x 0.9m	150mm x 100mm – 5.0mm Wire	15.0
9010	SWSM Red 6.0m x 1.1m	150mm x 100mm – 5.0mm Wire	18.0
9015	SWSM Blue 6.0m x 0.9m	250mm x 100mm – 5.0mm Wire	13.5
9020	SWSM Blue 6.0m x 1.1m	250mm x 100mm – 5.0mm Wire	16.0

TieWire

CODE	PRODUCT	WEIGHT (kg)
7000	2.00mm Heavy Galvanised Lacing/Tiewire (40m/kg)	5
7001	2.00mm PVC Black Lacing/Tiewire (31m/kg)	5
7002	2.00mm PVC Green Lacing/Tiewire (31m/kg)	5

CableWire

CODE	PRODUCT	WEIGHT (kg)
7003	3.15mm Heavy Galvanised Cable Wire (16.2m/kg)	5
7004	3.15mm PVC Black Cable Wire (14.5m/kg)	5
7005	3.15mm PVC Green Cable Wire (14.5m/kg)	5

Helicoil

CODE	PRODUCT	WEIGHT (kg)
7006	4.00mm Heavy Galvanised Helicoil (10.2m/kg)	25 or 50
7007	4.00mm PVC Green Helicoil (9m/kg)	25 or 50
7008	4.00mm PVC Black Helicoil (9m/kg)	25 or 50

Prices exclude GST and include delivery to your freight depot in Australian state capital cities.
For minimum purchase quantities please speak to your Southern Wire representative.



Chainmesh

Southern Wire offers a wide range of chainmesh options to suit a variety of fencing applications. This includes galvanised or PVC coated chainmesh, galvanised pipe, gates and the full range of fittings.

3.15mm chainmesh also available on request.

CODE	PRODUCT	ROLL LENGTH (m)	WEIGHT (kg)
HEAVY GALVANISED CHAINMESH			
3190	900 x 50 x 2.50mm	15	21
3111	1050 x 50 x 2.50mm	15	27
3112	1200 x 50 x 2.50mm	15	30
3115	1500 x 50 x 2.50mm	15	37
3118	1800 x 50 x 2.50mm	15	44
3121	2100 x 50 x 2.50mm	15	52
3124	2400 x 50 x 2.50mm	15	57
3130	3000 x 50 x 2.50mm	10	48
3136	3600 x 50 x 2.50mm	10	57
BLACK PVC COATED CHAINMESH			
3290	900 x 50 x 2.50mm	15	26
3211	1050 x 50 x 2.50mm	15	32
3212	1200 x 50 x 2.50mm	15	35
3215	1500 x 50 x 2.50mm	15	43
3218	1800 x 50 x 2.50mm	15	51
3221	2100 x 50 x 2.50mm	15	60
3224	2400 x 50 x 2.50mm	15	68
3230	3000 x 50 x 2.50mm	10	67
3236	3600 x 50 x 2.50mm	10	68

Prices exclude GST and include delivery to your freight depot in Australian state capital cities.
For minimum purchase quantities please speak to your Southern Wire representative.

Galvanised Pipe

PIPE DESCRIPTION	kg/m	1050mm CHAINMESH ONLY		1200mm CHAINMESH ONLY		1500mm CHAINMESH ONLY	
		CODE	LENGTH (mm)	CODE	LENGTH (mm)	CODE	LENGTH (mm)
32mm NB XL Plain End	2.1	G32X16	1600	G32X18	1800	G32X21	2100
32mm NB XL Plain Capped	2.1	G32X16C	1600	G32X18C	1800	G32X21C	2100
40mm NB XL Plain End	2.7	G40X16	1600	G40X18	1800	G40X21	2100
40mm NB XL Plain Capped	2.7	G40X16C	1600	G40X18C	1800	G40X21C	2100
50mm NB XL Plain End	3.4	G50X16C	1600	G50X18C	1800	G50X23C	2300
50mm NB XL Plain Capped	5.0	G50M16C	1600	G50M18C	1800	G50M23C	2300

PIPE DESCRIPTION	kg/m	CHAINMESH ONLY		CHAINMESH plus 3 rows of barbed wire - straight posts		CHAINMESH plus 3 rows of barbed wire - cranked posts	
		CODE	LENGTH (mm)	CODE	LENGTH (mm)	CODE	LENGTH (mm)

1800MM CHAINMESH

32mm NB XL Capped	2.1	G32X24C	2400	G32X29CD	2900	G32X29CDB	2900
32mm NB MED Capped	3.1	G32M24C	2400	G32M29CD	2900	G32M29CDB	2900
40mm NB XL Capped	2.7	G40X24C	2400	G40X29CD	2900	G40X29CDB	2900
40mm NB MED Capped	3.6	G40M24C	2400	G40M29CD	2900	G40M29CDB	2900
50mm NB XL Capped	3.4	G50X26C	2600	G50X32CD	3200	G50X32CDB	3200
50mm NB MED Capped	5.0	G50M26C	2600	G50M32CD	3200	G50M32CDB	3200
80mm NB MED Capped	8.4	G80M26C	2600	G80M32CD	3200	G80M32CDB	3200

PIPE DESCRIPTION	kg/m	CODE	LENGTH (mm)
32mm NB XL Diagonal Strut	2.1	G32X32BB	3200
32mm NB XL Rail	2.1	G32X32	3200
32mm NB XL Rail	2.1	G32X40	4000
32mm NB XL Swaged Top Rail	2.1	G32X65S	6500
32mm NB MED Diagonal Strut	3.1	G32M32BB	3200
32mm NB MED Rail	3.1	G32M32	3200
32mm NB MED Rail	3.1	G32M40	4000
40mm NB XL Diagonal Strut	2.7	G40X32BB	3200
40mm NB XL Rail	2.7	G40X32	3200
40mm NB XL Rail	2.7	G40X40	4000
40mm NB XL Swaged Top Rail	3.4	G40X65S	6500
40mm NB MED Diagonal Strut	5.0	G40M32BB	3200

Prices exclude GST and include delivery to your freight depot in Australian state capital cities.
For minimum purchase quantities please speak to your Southern Wire representative.

Chainmesh Gates

GATE DESCRIPTION (Gap Between Posts)	HEIGHT (mm)	1.8m Galvanised Chainmesh Only	1.8m Black PVC Chainmesh Only
		CODE	CODE
1000mm Personnel Chainmesh Gate	1750	IG1017G	IG1017B
3000mm Opening Double Chainmesh Gate	1750	IG3017G	IG3017B
4000mm Opening Double Chainmesh Gate	1750	IG4017G	IG4017B
5000mm Opening Double Chainmesh Gate	1750	IG5017G	IG5017B
6000mm Opening Double Chainmesh Gate	1750	IG6017G	IG6017B
7000mm Opening Double Chainmesh Gate	1750	IG7017G	IG7017B

GATE DESCRIPTION (Gap Between Posts)	HEIGHT (mm)	1.8m Galvanised Chainmesh plus 3 rows of barbed wire	1.8m Black PVC Chainmesh plus 3 rows of barbed wire
		CODE	CODE
1000mm Personnel Chainmesh Gate	2235	IG1022G	IG1022B
3000mm Opening Double Chainmesh Gate	2235	IG3022G	IG3022B
4000mm Opening Double Chainmesh Gate	2235	IG4022G	IG4022B
5000mm Opening Double Chainmesh Gate	2235	IG5022G	IG5022B
6000mm Opening Double Chainmesh Gate	2235	IG6022G	IG6022B
7000mm Opening Double Chainmesh Gate	2235	IG7022G	IG7022B

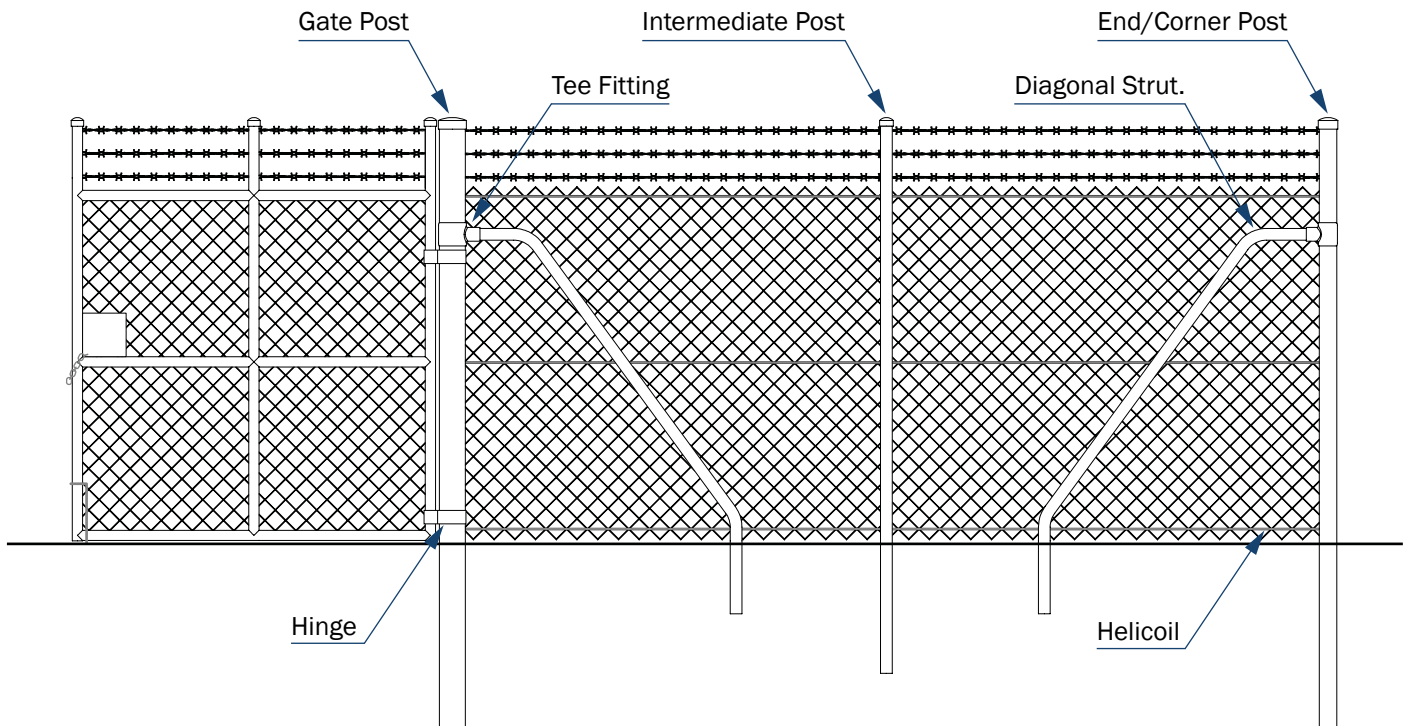

Prices exclude GST and include delivery to your freight depot in Australian state capital cities.
For minimum purchase quantities please speak to your Southern Wire representative.

Hinges & Pipe Fittings



THRU-BUTT	CTN	KG
TEES		
T2525	80	17
T2532	60	22
T2540	50	25
T3225	60	21
T3232	50	22
T3240	40	21
T3250	40	24
T4025	40	17
T4032	40	19
T4040	30	16
T4050	25	16
T5025	40	19
T5032	30	17
T5040	25	16
T5050	25	18
T8025	30	19
T8032	25	25
T8040	25	28
T8050	15	21
T10032	25	25



CODE	CTN	KG
POST CAPS (round)		
K25	400	15
K32	200	12
K40	180	14
K50	120	12
K65	80	11
K80	50	9
K90	40	9
K100	40	11



POST-GATE	CTN	KG
TWO PART HINGES		
TH4025	32	18
TH4032	32	24
TH5025	32	20
TH5032	32	25
SH8025	24	21
SH8032	24	22
SH8040	24	23
SH10025	24	24
SH10032	24	25
SH10040	24	26

CODE	CTN	KG
MULTI-PURPOSE FITTING SYSTEM		
		
MPR32	40	13
MPR40	40	14
MPR50	40	17
MPR65	40	20
MPR80	20	12



MPC25	60	18
MPC32	60	20
MPC40	40	19



MPAC25	30	15
MPAC32	30	17
MPAC40	20	16



THRU-BUTT	CTN	KG
CROSSES		
X2525	50	18
X2532	30	15
X2540	30	14
X2550	25	18
X3232	30	19
X3240	30	22
X3250	20	16
X4040	20	15
X4050	20	17
X5050	15	17



THRU-BUTT	CTN	KG
ADJUSTABLE CORNERS		
AC2525	30	17
AC2532	30	19
AC2540	30	21
AC2550	20	16
AC3232	20	17
AC3240	16	14
AC3250	16	14
AC4040	16	15
AC4050	16	15
AC5050	12	15

Prices exclude GST and include delivery to your freight depot in Australian state capital cities.
For minimum purchase quantities please speak to your Southern Wire representative.

Tools and Accessories

Southern Wire has all the tools and accessories to erect a fence. Please contact us for more information and product details.

CODE PRODUCT

WIRE DISPENSING

8712	3 Arm Folding Wire Jenny with Spike
8715	4 Arm Wire Jenny with Spike
8711	Wire Jenny Stand
8716	4 Arm Double Stacker Wire Jenny with Spike
8713	Double Stacker Wire Jenny Stand
8719	Helix Wire Winding Jenny
8710	Reel Easy Uncoiler



8712



8716



8713



8710

CODE PRODUCT

WIRE JOINING

8744	EzeCrimp 3in1 Fencing Tool
8788	EzePull 5in1 Fencing Tool (with staple remover)
8747	2.50mm Crimp Sleeve (Pottle of 100)
8748	2.50mm Crimp Sleeve (Bucket of 1000)
8749	3.15mm Crimp Sleeve (Pottle of 50)
8786	4.00mm Crimp Sleeve (Pottle of 50)
8789	5.00mm Crimp Sleeve (Pottle of 50)
8839	Electric Crimp Sleeve (Pottle of 50)
8787	Barbed Wire Crimp Sleeve (Pottle of 50)



8744



8788



8747



8839

CODE PRODUCT

WIRE STRAINING

8870	XT1 Ratchet Cliplock Wire Strainer (Box of 25)
8871	Universal Ratchet Handle
8731	Easy Wire Puller
8738	Wire Tension Tester
8730	Fixed Handle Chain Strainer
8881	Removable Handle Chain Strainer
8735	Boundary Strainer D Shackle
8720	0.9m Strainer Board
8721	1.3m Strainer Board
8722	1.9m Strainer Board



8871



8738



8730



8720 & 8721

Prices exclude GST and include delivery to your freight depot in Australian state capital cities. For minimum purchase quantities please speak to your Southern Wire representative.

CODE PRODUCT

WIRE CUTTERS & TOOLS

8742	Knipex Wire Cutters
8741	Maun Pliers
8792	Standard 10" Fencing Plier
8708	Star Post Driver
8732	Post Puller and Chain



8742

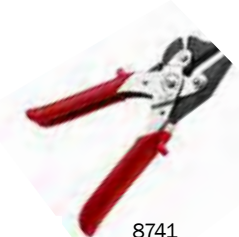

8741



8792



8708

CODE PRODUCT

STAPLES, CLIPS & OTHER ACCESSORIES

8760	30 x 4.0mm Barbed Staples (5kg Bucket)
8760L	30 x 4.0mm Barbed Staples (25kg Bucket)
8761	40 x 4.0mm Barbed Staples (5kg Bucket)
8761L	40 x 4.0mm Barbed Staples (25kg Bucket)
8762	50 x 4.0mm Barbed Staples (5kg Bucket)
8762L	50 x 4.0mm Barbed Staples (25kg Bucket)
9961	Ring Fastener Gun
7010	Ring Fasteners (Box of 1000)
8770	80mm Coupling Clips (Pack 250)
8771	100mm Coupling Clips (Pack 250)
8772	120mm Coupling Clips (Pack 250)
8775	Fencing Post Clips (Pack 300)
8780	Tie Fast (Pack 300)
8781	Tie Fast (Drum 3000)
8785	Yellow Fence Post Cap



8732



8775, 8780, 8770

Prices exclude GST and include delivery to your freight depot in Australian state capital cities.
For minimum purchase quantities please speak to your Southern Wire representative.

PREFABRICATED FENCE WIRE SPACINGS

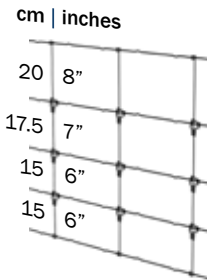

5/70/30
Sheep only

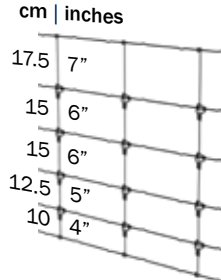

6/70/30
Sheep and Lamb

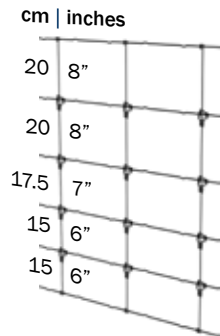

6/90/30
Cattle

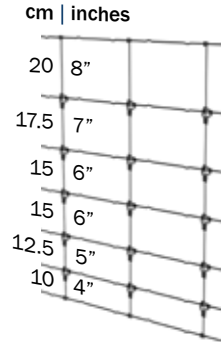

7/90/30
All stock

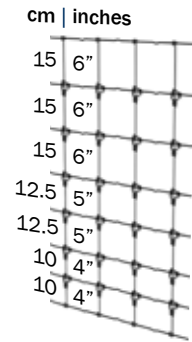

8/90/15
Intensive boundary

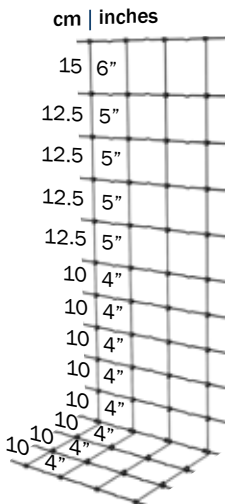

11/115/15
with 30cm
Hinged Apron

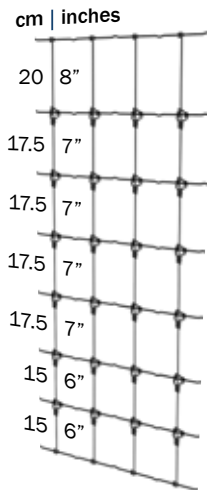

8/120/15
Intensive boundary and
Goat

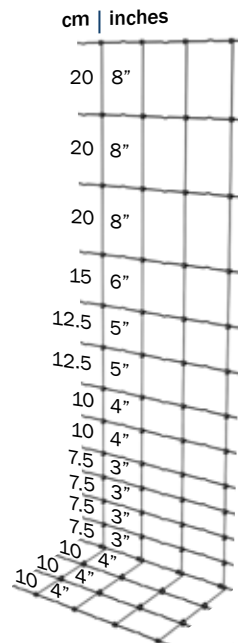

13/150/15
with 30cm
Hinged Apron

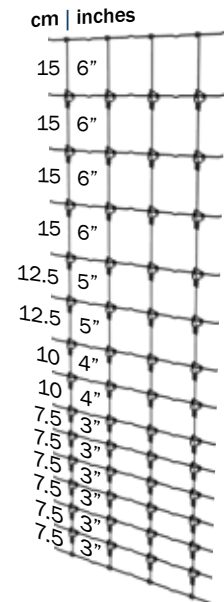

15/150/15
Internal deer/Game/
Vermin

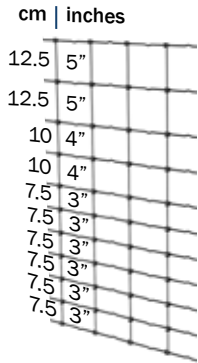

11/90/15
Vermin

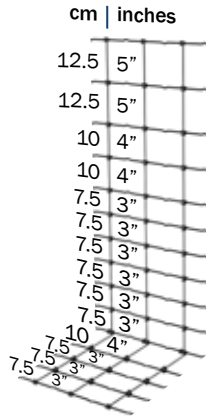

11/90/15
with 32.5cm
Hinged Apron

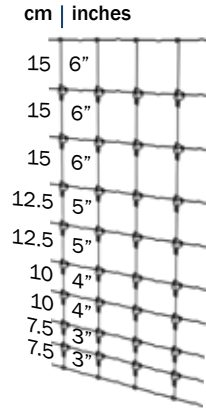

10/110/15
Intensive goat

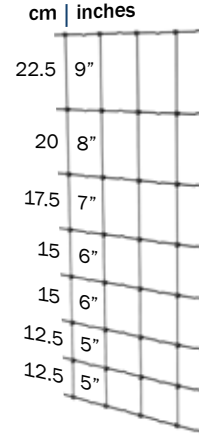

8/115/15
Vermin

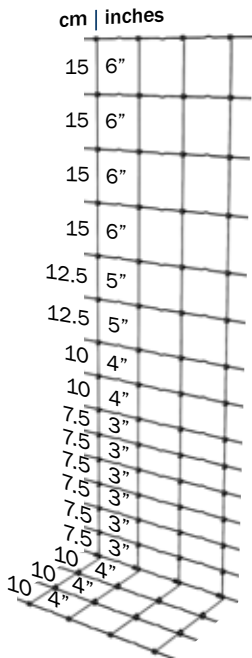

15/150/15
with 30cm
Hinged Apron

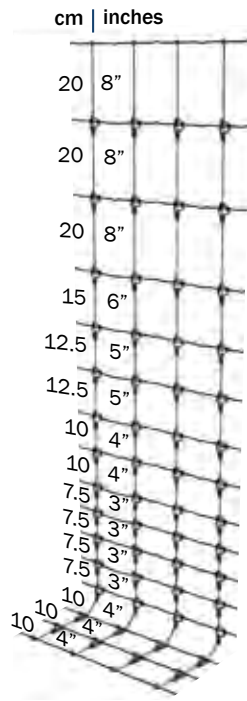

16/180/15
with 30cm
Radius Apron

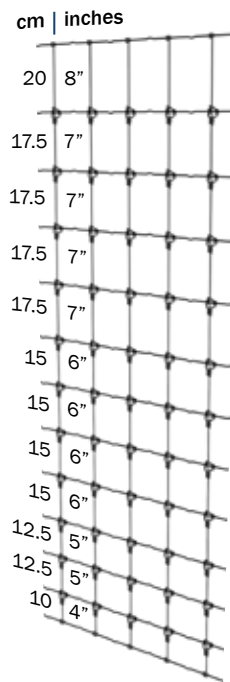

13/190/15
Intensive boundary/Emu

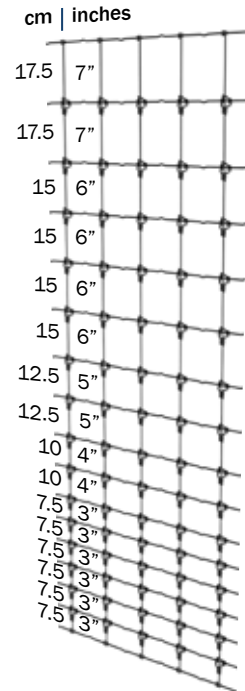

17/190/15
Boundary deer/Game/
Vermin



Southern Wire Pty Ltd

ABN 37 009 150 421

Head Office & Manufacturing

311 Collier Road Bassendean WA 6054

Mailing Address:

PO Box 3232 Bassendean DC WA 6942



Phone: +61 8 9279 9999

Fax: +61 8 9377 3888



Orders:

orders@southernwire.com.au

Enquiries:

enquiries@southernwire.com.au

SA Warehouse

Phone: 1800 627 722

Wingfield SA 5013

VIC Warehouse

Phone: 1800 627 722

Altona North VIC 3025

NSW Warehouse

Phone: 1800 627 722

Campbelltown NSW 2560

QLD Warehouse

Phone: 1800 627 722

Rocklea QLD 4106

www.southernwire.com.au