

2

NAVAL POSTGRADUATE SCHOOL
Monterey, California
AD-A232 422



DTIC
ELECTE
MAR 12 1991
S B D

THESIS

DESIGN AND CONSTRUCTION OF A COMPOSITE
AIRFRAME FOR UAV RESEARCH

by

Jeffrey L. Ellwood

June, 1990

Thesis Advisor: Prof. Richard M. Howard

Approved for public release; distribution is unlimited.

91 3 06 031

REPORT DOCUMENTATION PAGE				Form Approved OMB No 0704-0188	
1a. REPORT SECURITY CLASSIFICATION Unclassified			1b. RESTRICTIVE MARKINGS		
2a. SECURITY CLASSIFICATION AUTHORITY		3. DISTRIBUTION / AVAILABILITY OF REPORT			
2b. DECLASSIFICATION / DOWNGRADING SCHEDULE		Approved for public release: distribution unlimited			
4. PERFORMING ORGANIZATION REPORT NUMBER(S)			5. MONITORING ORGANIZATION REPORT NUMBER(S)		
6a. NAME OF PERFORMING ORGANIZATION Naval Postgraduate School		6b. OFFICE SYMBOL (if applicable) 31	7a. NAME OF MONITORING ORGANIZATION Naval Postgraduate School		
6c. ADDRESS (City, State, and ZIP Code) Monterey, CA 93943-5000			7b. ADDRESS (City, State, and ZIP Code) Monterey, CA 93943-5000		
8a. NAME OF FUNDING / SPONSORING ORGANIZATION		8b. OFFICE SYMBOL (if applicable)	9. PROCUREMENT INSTRUMENT IDENTIFICATION NUMBER		
8c. ADDRESS (City, State, and ZIP Code)			10. SOURCE OF FUNDING NUMBERS		
			PROGRAM ELEMENT NO	PROJECT NO	TASK NO
11. TITLE (Include Security Classification) Design and Construction of a Composite Airframe for UAV Research					
12. PERSONAL AUTHOR(S) Jeffrey L. Ellwood					
13a. TYPE OF REPORT Master's Thesis		13b. TIME COVERED FROM _____ TO _____	14. DATE OF REPORT (Year, Month, Day) 1990, June		15. PAGE COUNT 86
16. SUPPLEMENTARY NOTATION This Thesis expresses the views of the author and do not reflect official policy or position of the Department of Defense or the U.S. Government					
17. COSAT: CODES		18. SUBJECT TERMS (Continue on reverse if necessary and identify by block number)			
FIELD	GROUP	SUB-GROUP	UAV, Composites, AROD, TDF, RPV, Ducted Fan, Vertical Takeoff		
19. ABSTRACT (Continue on reverse if necessary and identify by block number)					
<p>A half-scale Unmanned Aerial Vehicle (UAV) was designed and constructed from composite materials for the Flight Research Lab at the Naval Postgraduate School. The vehicle was designed as a technology demonstrator for two studies. First, the Tilted Ducted Fan (TDF) vertical flight capability engine and its stability and control systems, and second, for the tail configuration testing for longitudinal and lateral-directional stability enhancement of an existing tailless Unmanned Aerial Vehicle. Completion of these research and test objectives should provide the configuration requirements for a full-scale development vehicle with vertical takeoff and landing with transition to the forward flight mode.</p>					
20. DISTRIBUTION / AVAILABILITY OF ABSTRACT <input checked="" type="checkbox"/> UNCLASSIFIED/UNLIMITED <input type="checkbox"/> SAME AS RPT <input type="checkbox"/> DTIC USERS			21. ABSTRACT SECURITY CLASSIFICATION Unclassified		
22a. NAME OF RESPONSIBLE INDIVIDUAL Richard M. Howard		22b. TELEPHONE (Include Area Code) (408) 655-2870		22c. OFFICE SYMBOL 67H0	

Approved for public release; distribution is unlimited.

Design and Construction of a Composite
Airframe for UAV Research

by

Jeffrey L. Ellwood
Lieutenant Commander, United States Navy
B.S., Penn State University

Submitted in partial fulfillment
of the requirements for the degree of

MASTER OF SCIENCE IN AERONAUTICAL ENGINEERING

from the

NAVAL POSTGRADUATE SCHOOL

June, 1990

Author:

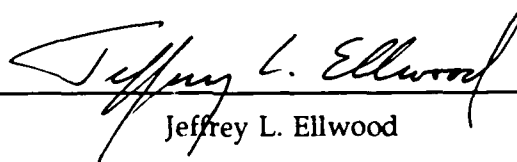
Jeffrey L. Ellwood

Approved by:



Prof. Richard M. Howard, Thesis Advisor

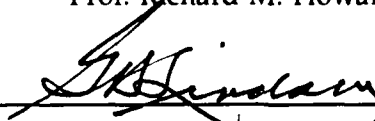

Prof. Gerald H. Lindsey, Second Reader

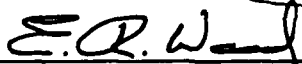

Prof. E. Roberts Wood, Chairman
Department of Aeronautics and Astronautics

ABSTRACT

A half-scale Unmanned Air Vehicle (UAV) was designed and constructed from composite materials for the Flight Research Lab at the Naval Postgraduate School. The vehicle was designed as a technology demonstrator for two studies. First, for the Tilted Ducted Fan (TDF) vertical flight capability engine and its stability and control system; and second, for the tail configuration testing for Longitudinal and Lateral-Directional stability enhancement of an existing tailless Unmanned Air Vehicle. Completion of these research and test objectives should provide the configuration requirements for a full-scale development vehicle with vertical takeoff and landing with transition to forward flight.

Accession For	
NTIS GRA&I	<input checked="" type="checkbox"/>
DTIC TAB	<input type="checkbox"/>
Unannounced	<input type="checkbox"/>
Justification	
By _____	
Distribution/	
Availability Codes	
Dist	Avail and/or Special
A-1	



TABLE OF CONTENTS

I. INTRODUCTION	1
A. ARCHYTAS, MAN OR MACHINE	1
B. NPS UNMANNED AERIAL VEHICLE GOALS	1
C. AQUILA TO ARCHYTAS	12
D. CONCURRENT THESIS	13
II. DESIGN GOALS	14
A. AQUILA DOWNSCALE	14
B. TDF	14
C. TAILBOOM	15
III. DESIGN APPROACH	19
A. WING	19
B. FUSELAGE	21
C. TAILBOOM	32
D. LANDING GEAR	37
E. ENGINE	40
IV. CONSTRUCTION TECHNIQUE	44
A. WING	44
B. FUSELAGE	48
C. TAILBOOM	55
D. LANDING GEAR	62
E. ENGINE	65
V. STABILITY	66
A. LONGITUDINAL	66
B. LATERAL AND DIRECTIONAL	67
VI. CONCLUSIONS AND RECOMMENDATIONS	68
A. CONCLUSIONS	68
B. RECOMMENDATIONS	68
APPENDIX A - EQUATIONS	71
APPENDIX B - SPECIFICATIONS.	73
REFERENCES	74
INITIAL DISTRIBUTION LIST.	76

TABLE OF SYMBOLS AND/OR ABBREVIATIONS

a	Lift-curve slope
a_e	Effective lift-curve slope
a_t	Lift-curve slope of tail
a_w	Lift-curve slope of wing
a_{wb}	Lift-curve slope of wing-body
AR	Aspect ratio
C_{mac} (c)	Mean chord at the aerodynamic center
$C_{l\beta}$	Change in rolling moment coefficient due to sideslip
$C_{l\beta d}$	Change in C_{lB} due to dihedral
$C_{l\beta v}$	Change in C_{lB} due to vertical fin
$C_{l\beta w}$	Change in C_{lB} due to wing sweep
C_l	Lift coefficient
$C_{l\alpha}$	Lift-curve slope
$C_{l\alpha\beta-\beta}$	Three-dimensional lift-curve slope
$C_{l\alpha^2-\beta}$	Two-dimensional lift-curve slope
C_{M_0}	Longitudinal moment coefficient at 0° AOA
$C_{m_{cg}}$	Longitudinal moment coefficient about the C.G.
$\delta C_{m_{cg}}/\delta\alpha$	Change in $C_{m_{cg}}$ with change in AOA
$C_{m_{ac}}$	Moment coefficient about the aerodynamic center
$C_{m\alpha}$	Change in moment coefficient with AOA
$C_{n\beta}$	Change in yaw moment due to sideslip
$C_{n\beta v}$	Change in $C_{n\beta}$ due to vertical fin
$C_{n\beta w}$	Change in $C_{n\beta}$ due to wing sweep

E	Jones edge-velocity factor (Ref 8;p. 11)
f	Modification factor (Ref 8;p. 16)
h_{acwb} (h_{ac})	Location of aerodynamic center as % chord (c)
h_{cg} (h)	Location of center of gravity as % chord (c)
h_n	Location of neutral point as % chord (c)
i_t	Tail incidence angle referenced from 0 lift line
L	Lift force (= weight in level flight)
S	Wing area (ft ²)
S_h	Horizontal tail area (ft ²)
S_v	Vertical tail area (ft ²)
V	Velocity (ft/sec)
V_f/V_∞	Ratio of velocity over vertical fin to freestream
V_{hl}	Tail volume ratio of horizontal tail in long boom configuration
V_{hs}	Tail volume ratio of horizontal tail in short boom configuration
V_{vl}	Tail volume ratio of vertical tail in long boom configuration
V_{vs}	Tail volume ratio of vertical tail in short boom configuration
V'	Vertical tail volume ratio in roll
x_h	Length from C.G. to horizontal tail 1/4 chord position
x_v	Length from C.G. to vertical tail 1/4 chord position
y_{mac} (y)	Span-wise distance from wing root to c_{mac}
z_F	Distance from C.G. to vertical tail center

α	Angle-of-Attack (AOA)
ϵ_0	Downwash angle on tail from wing at 0 lift
$\delta\epsilon/\delta\alpha$	Change in downwash due to change in AOA
γ	Wing dihedral
λ	Taper ratio tip chord / root chord
$\Lambda_{c/4}$	1/4 chord wing sweep
$\delta\sigma/\delta\beta$	Change in sidewash due to sideslip

ACKNOWLEDGMENT

Being part of the start of a new research program can be a difficult and time consuming learning experience. Without the guidance and patience of Professor Rick Howard, the problems encountered through each stage of the program development may have been even more difficult to solve. I thank him for his guidance, his shared knowledge and his dedication to the profession.

A special thanks goes to my wife Tonia and my three boys Nick, Ben and Jeremy. They have been most supportive throughout this tour, and their patience and understanding has contributed immensely to the learning experience.

I. INTRODUCTION

A. ARCHYTAS, MAN OR MACHINE

Legend has it that around 400 B.C., a Greek scientist, statesman and colleague of the philosopher Plato by the name of Archytas conceived of, constructed and successfully flew a mechanical flying bird. Though no trace of the design remains, it is appropriate to adopt this name for the first Unmanned Air Vehicle (UAV) to be designed and built by the UAV Flight Research Laboratory at the Naval Postgraduate School. The unique features of the aircraft reflect the innovation and creativity marked by UAVs since that beginning 2400 years ago.

B. NPS UNMANNED AERIAL VEHICLE GOALS

The purpose of the Unmanned Air Vehicle (UAV) Flight Research program at the Naval Postgraduate School is support of the UAV Joint Project Office (JPO) of NAVAIR. The result is the establishment of a family of diverse testbeds of scaled radio controlled aircraft capable of flight test simulation and aerodynamic modeling of full size manned and unmanned aircraft.

These UAV's are used to support Fleet aircraft flight test requirements for new or potentially hazardous concepts or

in support of entirely new aircraft concepts. These new concepts have unexplored potentials, and bring with them high risk and possibly high payoff. The use of smaller, lighter and less expensively-operated scale UAV's saves money, manpower and time in the flight test process.

The UAV Flight Research Lab (FRL) has established a range of flight test capabilities in UAV research and development, which includes a high Angle-of-Attack (AOA) study capability of scaled F-16 and F-18 airframes (Figure 1). The Lab also possesses rotary wing test capability and is studying Higher Harmonic Control and vibration reduction with two remotely-controlled helicopters (Figure 2). The program maintains a Navy EXDRONE delta-wing vehicle (Figure 3).

Currently, the laboratory operates a 1/2-scaled Pioneer UAV (Figure 4). The Pioneer vehicle is in current fleet use onboard battleships and is a derivative of the Israeli combat-proven Mastiff and Scout airframes. Fleet use of the Pioneer includes multi-mission capabilities of over-the-horizon targeting, communications relay and long-range reconnaissance (Ref 1:p. 38).

The Pioneer program, the most mature of the programs in the UAV FRL, is a good example of the research potential of scaled UAVs for modeling fleet aircraft. Development of new



Figure 1. F-16 Agile Fighter UAV

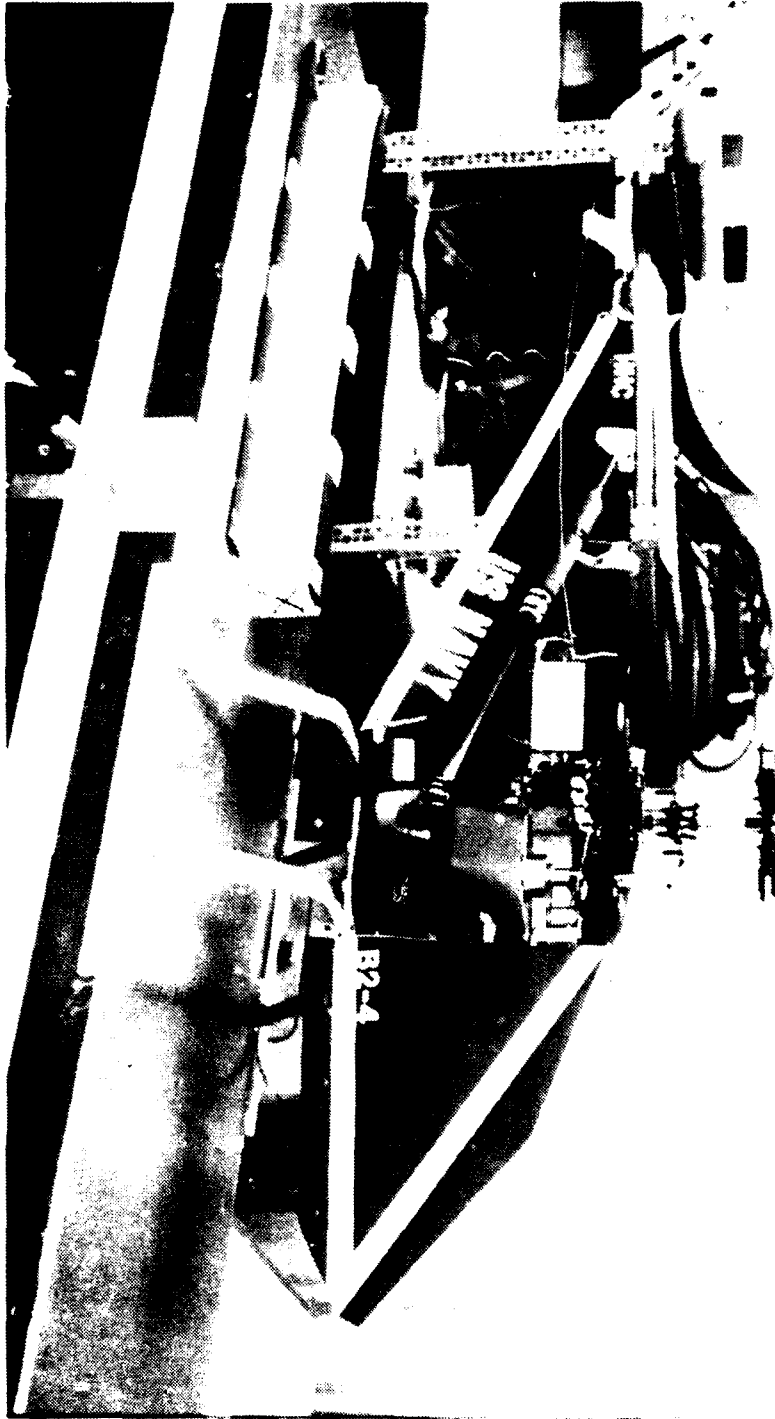

Figure 2. Helicopter UAV



Figure 3. EXDRONE UAV



Figure 4. Pioneer UAV

concepts or flight test of identified problems can be costly and with the price of the full size Pioneer air vehicle upwards of \$600,000, much can be said for the use of a scaled UAV for conducting research.

The 1/2-scaled Pioneer UAV model was built, operated and flight tested at a fraction of the cost of the full scale vehicle. A loss of the UAV airframe in the event of some mishap is substantially less costly than would be the loss of a full size airframe during flight test research.

This scaled Pioneer is currently being instrumented for flight test missions with α and β measurement systems and a pitot-static system. Telemetry capability is currently being installed and tested. In the meantime a seven channel onboard recorder is used to obtain flight test information.

In the past, the Pioneer in the fleet has experienced several operational losses during shipboard recoveries due to the net capture technique as the primary means of recovery. These losses are financially and operationally unacceptable, and another means of recovery needs to be found.

This need led to the next step in the NPS UAV program. The purpose of this thesis was to design and build an airframe for a proof-of-concept study of the use of a Tilted Ducted Fan (TDF) as a means of vertical takeoff and recovery aboard Naval Combatants.

The TDF concept consists of an engine and control system modeled after the Marine AROD (Aerial Remote Operated Device), an advanced hover design (Figure 5) (Ref 2:p.73). Basically a shrouded propeller with a four vane control system mounted at its base, the AROD was developed and proven to have a successful control system but had serious shortcomings as a flight vehicle. The program was cancelled due to the vehicle's lack of forward flight capability.

The school has possession of a full scale Army Aquila airframe (Figure 6). The Aquila airframe possesses many positive attributes; for example, it has a low radar cross section, a simple airframe, and a good range and endurance capability. Early versions of the design, however, demonstrated unacceptable longitudinal stability characteristics at negative AOA and poor lateral-directional stability at low AOA (Ref 3:p.1).

By combining the Aquila airframe and the engine design of the AROD in an advanced hover vehicle, an airframe with a vertical takeoff and landing capability was conceived. With the addition of a tail structure to the airframe, the stability problems should be solved. Two problems lead to one solution, and this solution has the name "Archytas" (Figure 7).

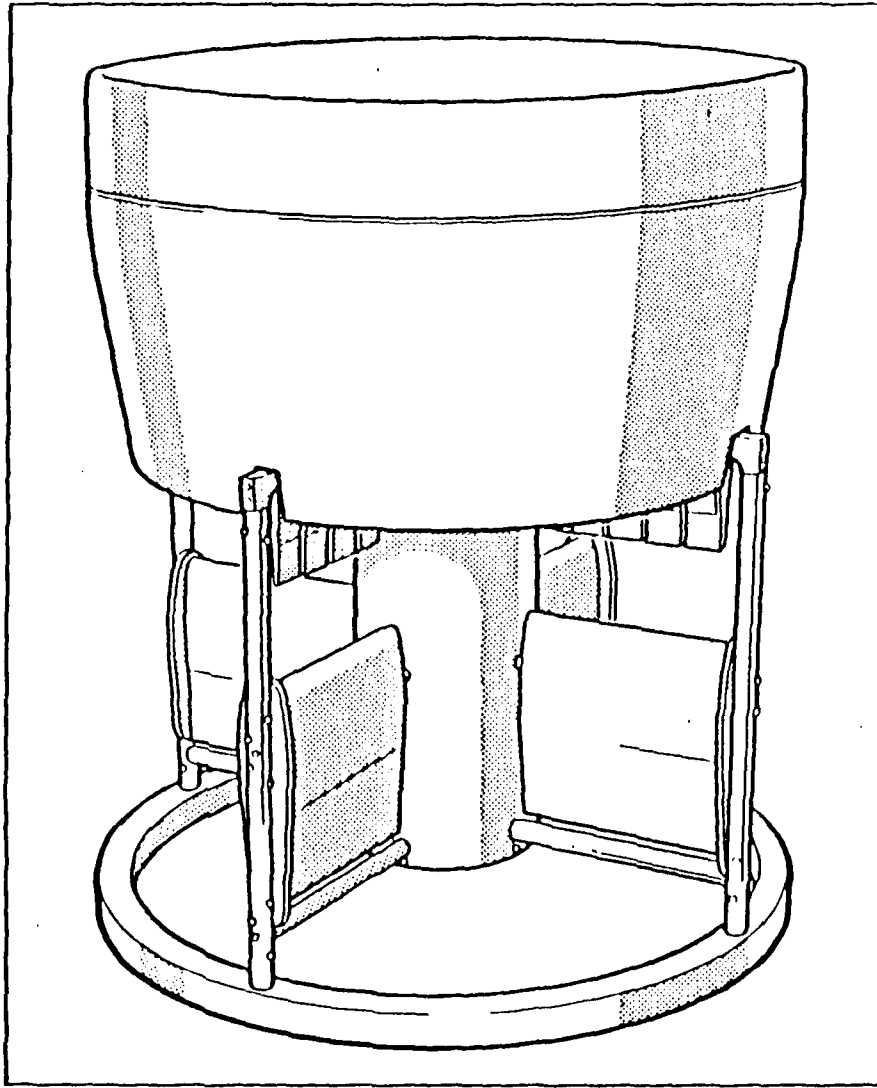

Figure 5. AROD

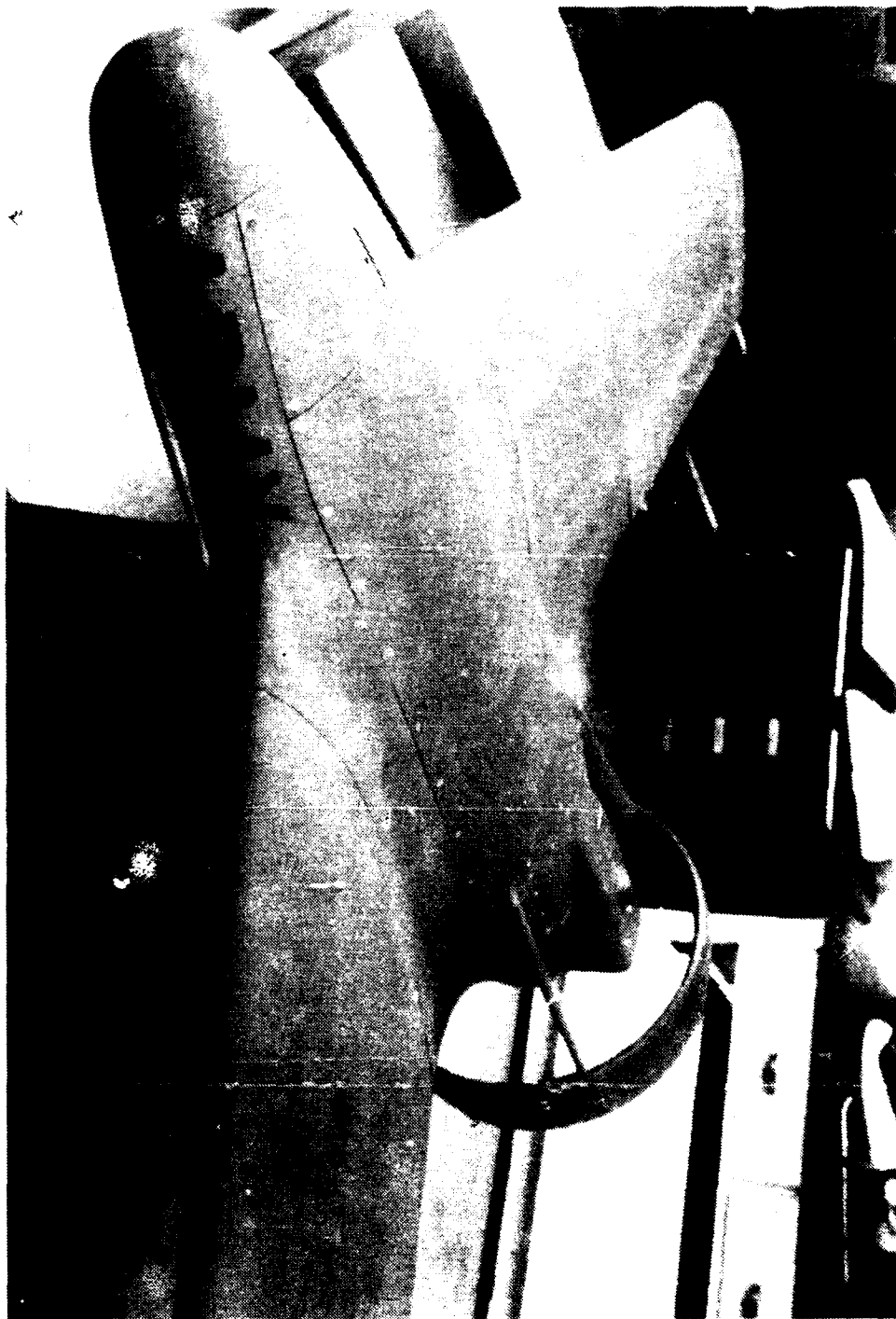

Figure 6. Aquila

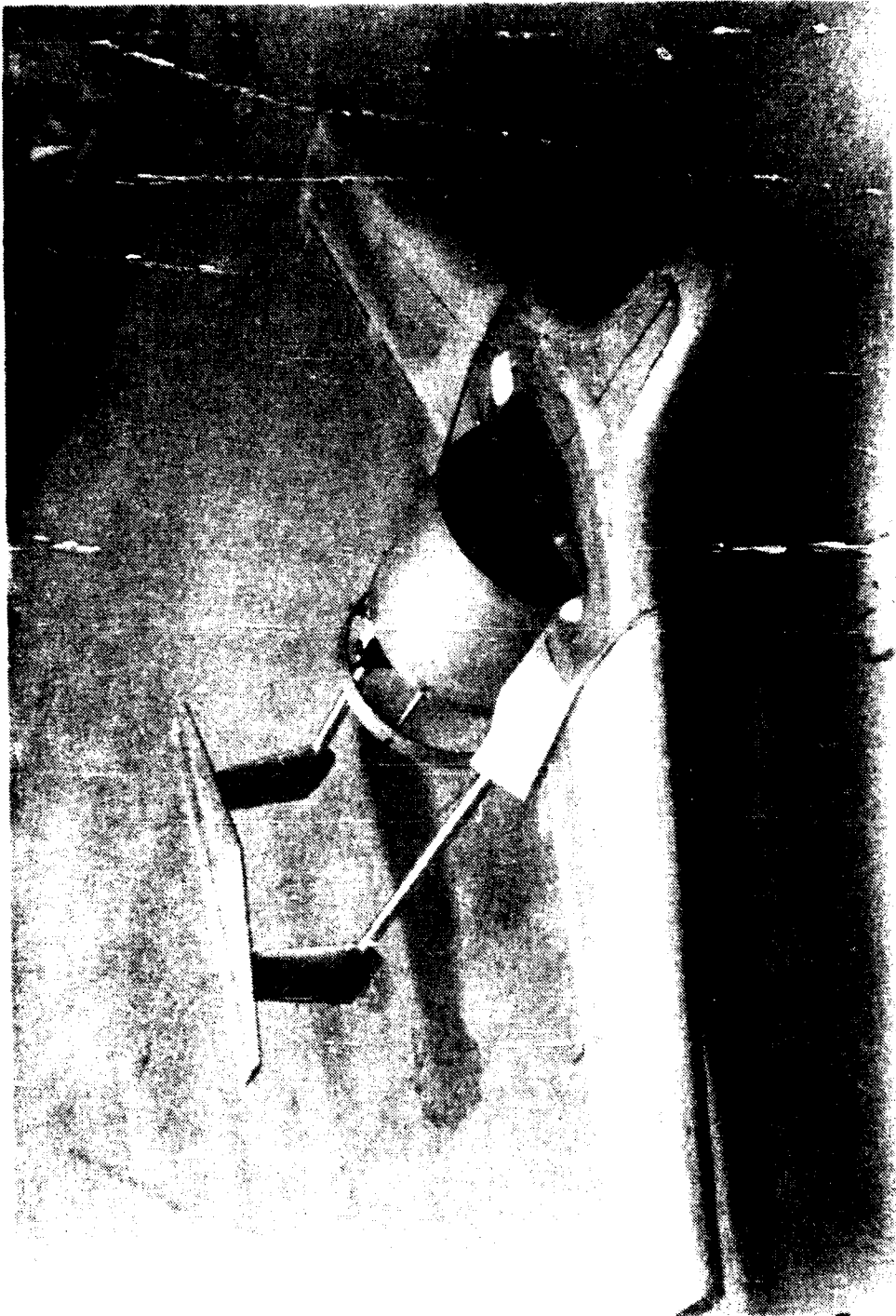

Figure 7. Archytas

C. AQUILA TO ARCHYTAS

The Archytas design accounts for both the instability of the Aquila design and the vertical hover capability obtained by the incorporation of the TDF. To accomplish this in one airframe, several modifications to the basic Aquila airframe design were made. First, the Archytas was 1/2-scaled from the Aquila. Next, the fuselage was modified to contain the engine mid-fuselage for Center of Gravity (C.G.) thrust in the vertical flight phase and to allow installation of the tail and landing gear mounts for the forward flight mode.

Once the TDF and stability requirement proof-of-concepts for the Archytas are complete, the modified full scale Aquila airframe will serve as the testbed for the flight transition to and from the forward flight mode and for full scale flight test and development.

Other vertical takeoff concepts, some saucer-like with counter-rotating props, do not possess the higher dash speeds obtainable in the fixed wing configurations being limited to about 70 knots (Ref 4:p.24). Multi-engine designs with engines for separate horizontal and vertical flight phases carry an unused engine during the flight and therefore lose some payload capability (Ref 5:p.117). These limitations support the proof-of-concept study of the Archytas as a means of meeting all requirements in one airframe.

D. CONCURRENT THESIS

Concurrent thesis work by Blanchette consisted of the initial downscale of the Aquila and the design and construction of the TDF (Tilted Tucted Fan) from the AROD (Ref 6). This downscale resulted in an initial fuselage and wing planform design. Due to several modifications during the design process, only the wing planform remains scaled to its original dimensions.

The design of the TDF, engine mount and control vane system was accomplished concurrently by Blanchette; however, the necessary expertise was not available for the three-axis hover control system, and the controller construction will be carried out in a future project.

II. DESIGN GOALS

A. AQUILA DOWNSCALE

Scaling the Archytas to approximately 1/2 scale of the Aquila was done primarily for the testing of the design concepts quickly and cheaply before full scale development proceeded. Parts and supplies, i.e., the engine, servos, receivers and other components are available from recreational hobby parts suppliers and are far less expensive and more readily available than full scale parts would be.

Modifications made as design problems were solved are fully explained in detail, section by section, in later chapters. Once the concepts are proven, the full scale vehicle will be developed and the transition from vertical to horizontal flight mode accomplished in the full scale modified Aquila.

B. TDF

The design goal of the TDF was to model the AROD for use in the Archytas. This process required determining the engine thrust requirements for the vertical flight mode and designing a control vane system to operate in the wake of the propeller.

The engine chosen was a 2.67 cubic inch, twin-cylinder, ignition engine rated at 4 H.P. This engine develops

approximately 25 pounds of thrust with a 20 inch propeller. The size and vibration characteristics of the engine were ideally suited for our purpose. The engine itself was shrouded with the propeller to contain the airflow back to the control vanes.

The control vane system was modeled directly from the AROD. The sensor package for the controller of the AROD consists of three rate gyros, a vertical accelerometer and a vertical gyro. Limited vertical flight is planned until a suitable control system is installed.

C. TAILBOOM

The tailboom was designed for three configuration studies. The three configurations will study the amount of tail effectiveness required to sufficiently enhance the longitudinal and directional stability characteristics of the Aquila. The tailless configuration will study the addition of vectored thrust and control coupling to the original Aquila (Figure 8). The short boom is a mid-configuration design study for the system should the tailless configuration prove inadequate (Figure 9). The longboom configuration will test the stability of a normal tail configuration (Figure 10). The actual component design is discussed in the next chapter.



Figure 8. Tailless Archytas



Figure 9. Short Boom Archytas

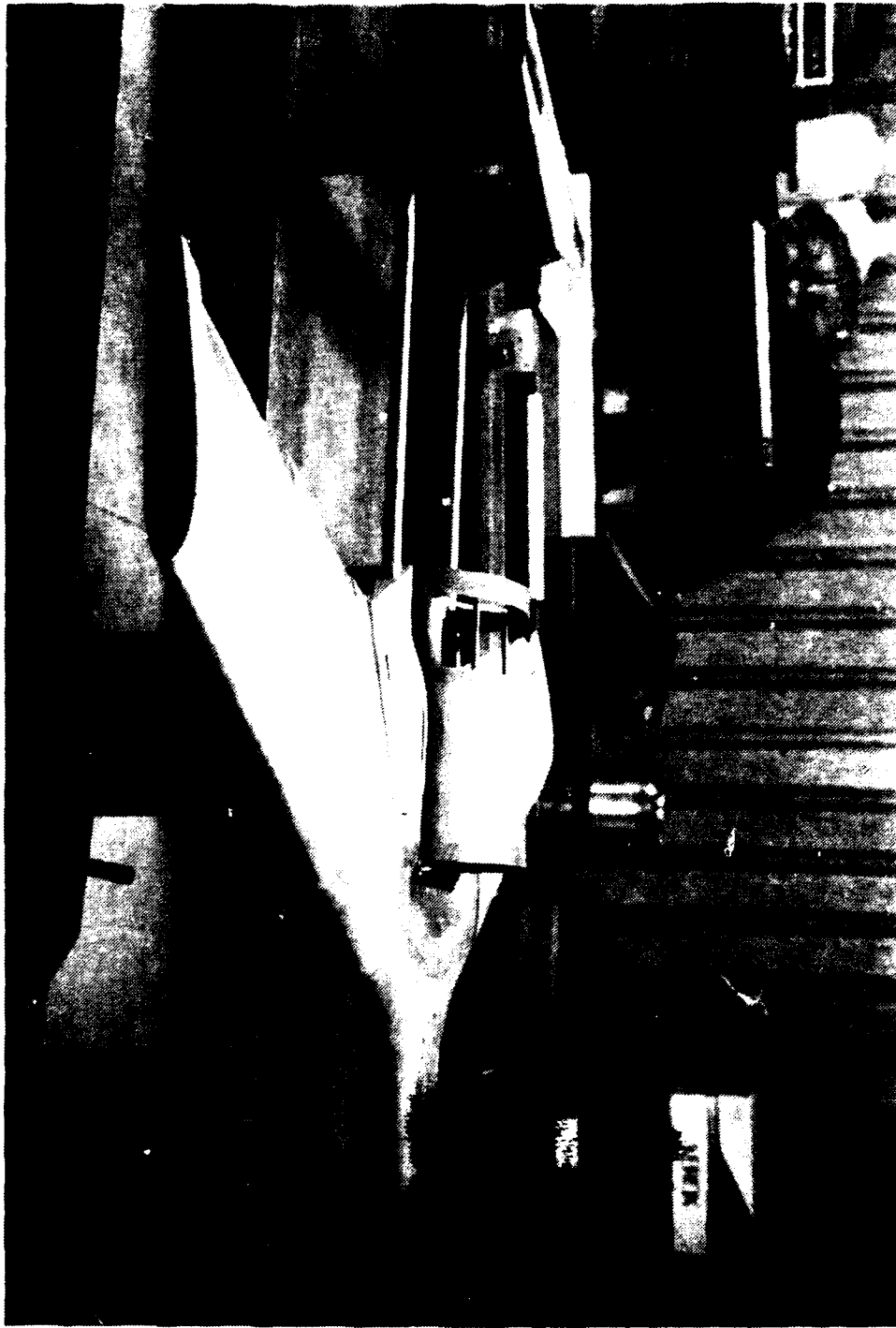

Figure 10. Long Boom Archytas

III. DESIGN APPROACH

The design of the vehicle occurred in five stages with each stage experiencing its own development problems. Therefore each section is discussed individually.

A. WING

The wing of the Archytas is identical in planform, wing sweep and airfoil section to that of the Aquila (Figure 11). The wing was constructed primarily of a urethane foam core which was covered with fiberglass. This technique gives the lightest weight structure necessary for the purpose. The sweep was held at 29° for the leading edge and 16° for the trailing edge. Root and tip section templates from the Aquila provided the basic shape of the wing. A dihedral angle of 2° was designed in as a stability enhancement.

A spar was used in the structure and the use was two-fold: 1) to give added strength to the structure during dynamic loads; and 2) to provide attachment to the fuselage. The spar was designed in an I-beam configuration as a shear web with two spar caps. The structure was designed to withstand 25 G's, as developed in the concurrent thesis. With no pilot limitation on the airframe, the additional strength

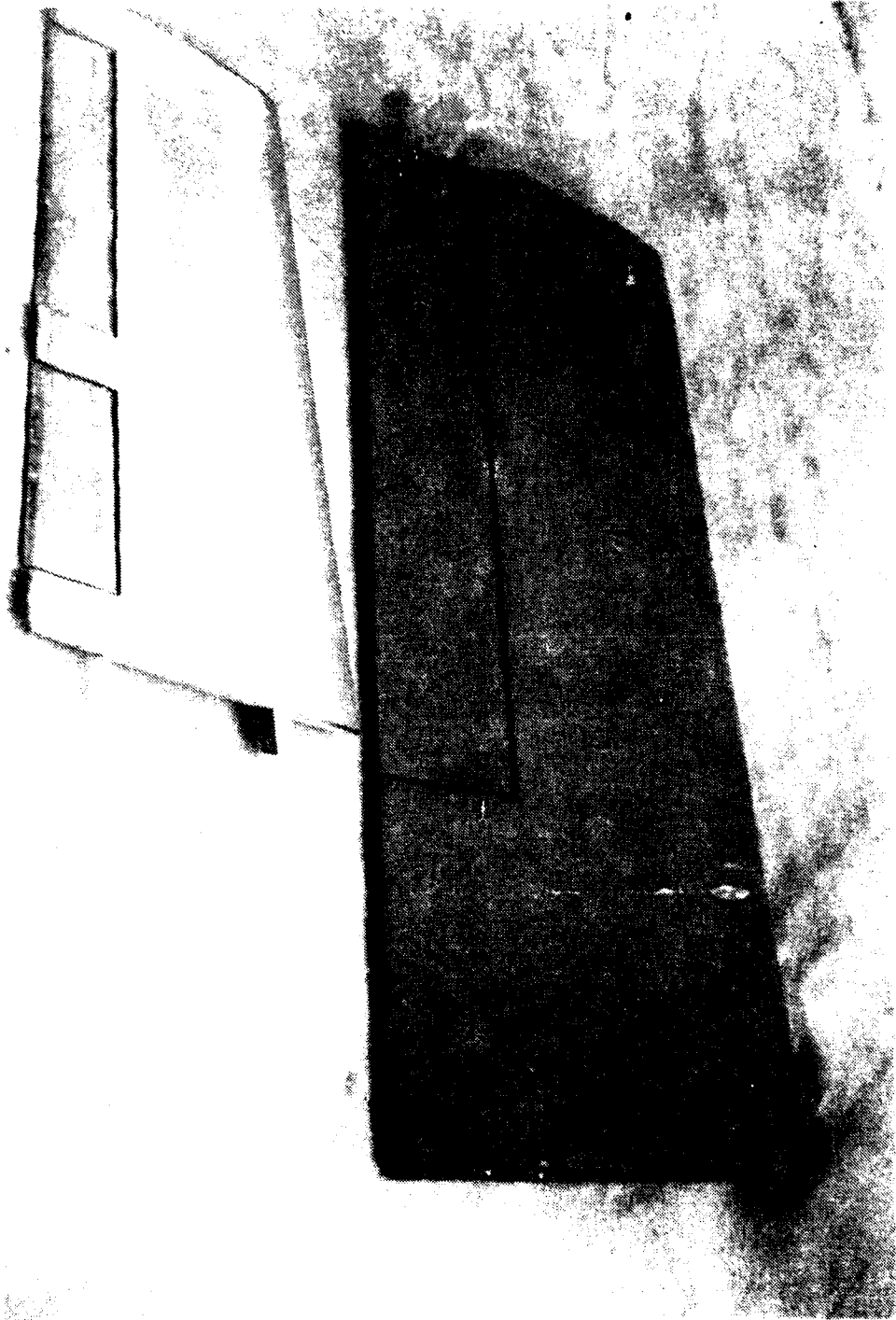

Figure 11. Wing Planforms

provides for additional maneuverability. In the aft portion of the wing planform there is a shear web to provide structural strength for the attachment of the wing control surfaces.

The aileron control surface of the Archytas was decreased to 44% from 62% span to incorporate flaps into the design. The smaller ailerons will be augmented by the control vanes of the TDF. The flaps will be used to decrease landing speeds (Figure 12). This design modification may eventually see its way to the full scale.

B. FUSELAGE

The fuselage was perhaps the most difficult section to design. Paramount in the design process was the expulsion of any unnecessary weight. Upon initial examination of the changes to the Aquila fuselage the first design consideration was to mount the engine at the C.G. of the airframe. This was accomplished by a horseshoe shaped structure (Figure 13).

Next, excess payload volume was removed. The forward portion of the fuselage was flattened to allow for smooth introduction of the freestream airflow into the centrally located engine (Figure 14). This area reduction also minimized the blockage by airframe frontal area.

The large payload area of the Aquila fuselage nose area was unnecessary for our purposes. This reduction in required

WING
PLANFORM

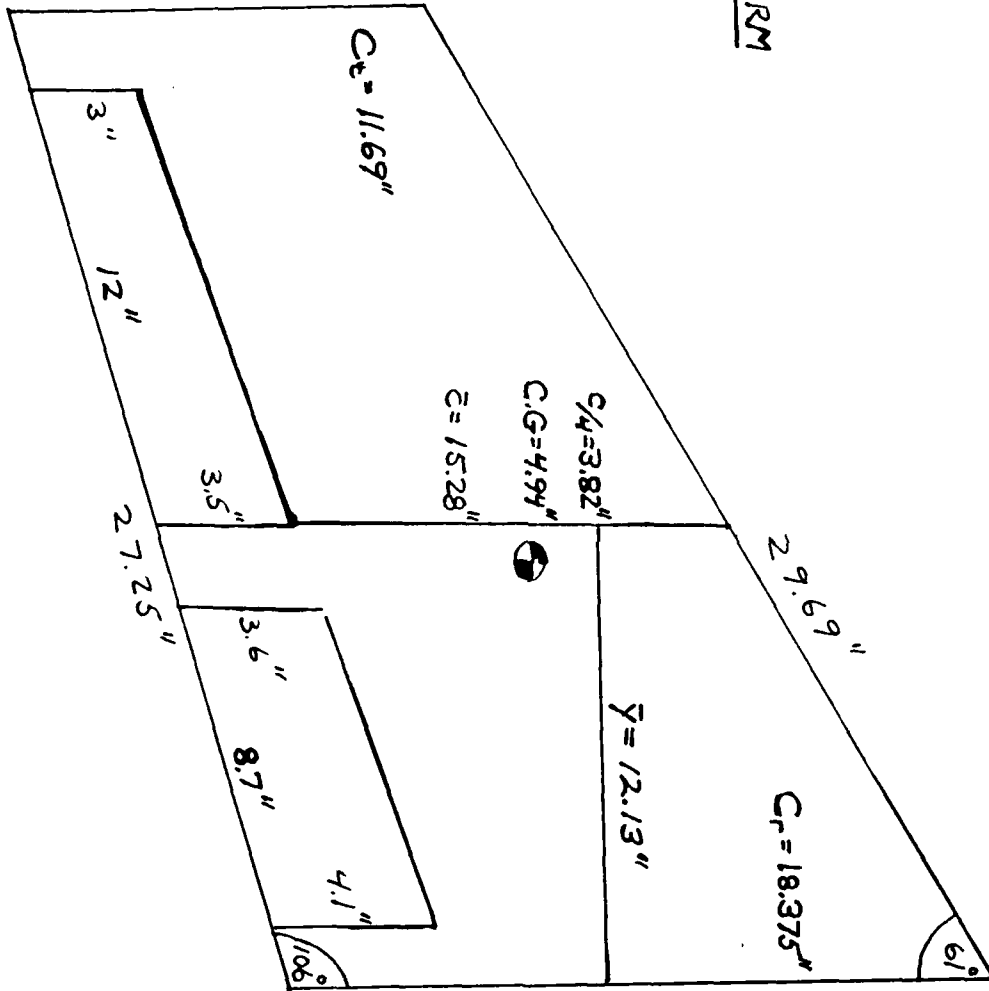

Figure 12. Wing Planform

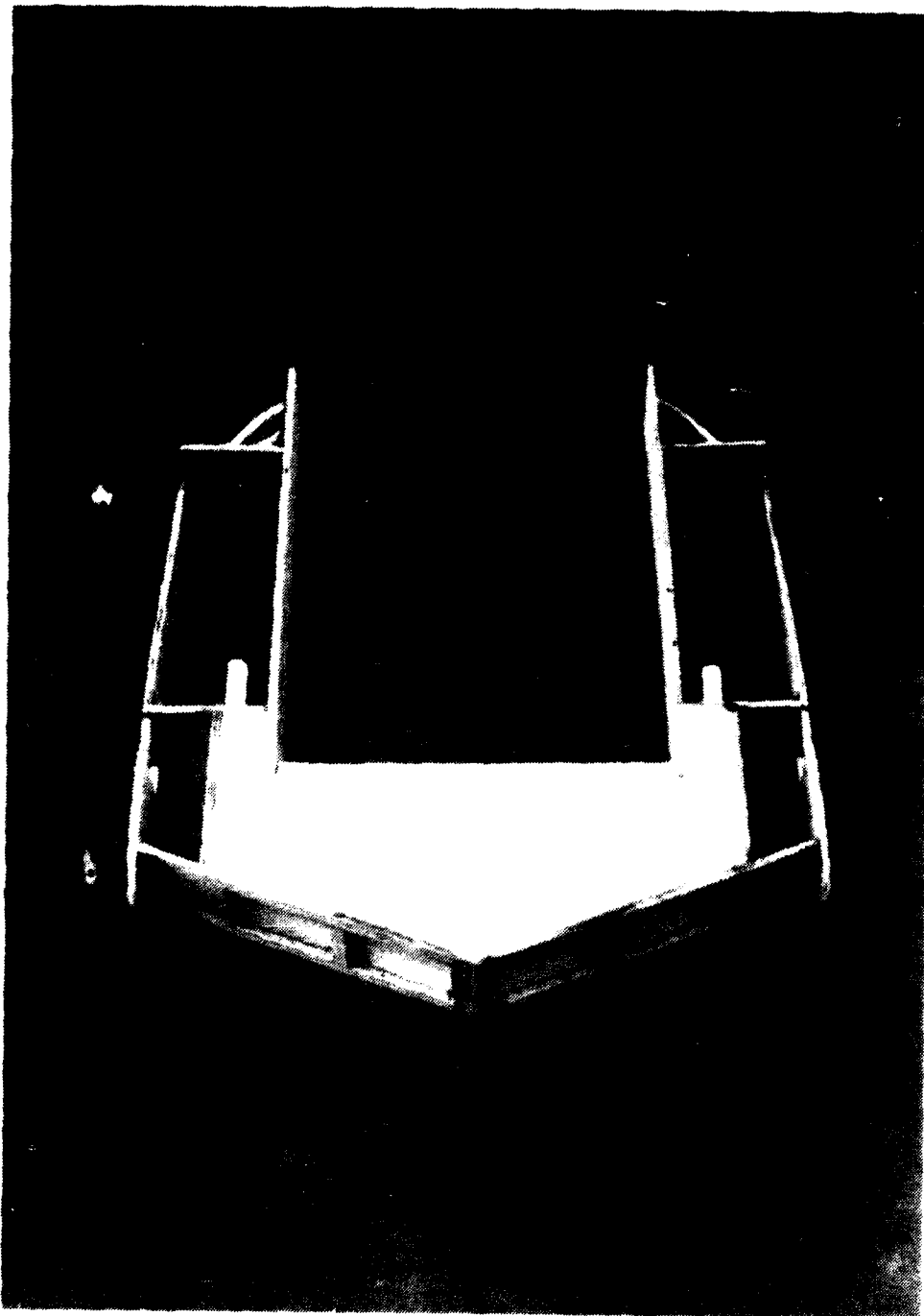

Figure 13. Fuselage Structure



Figure 14. Forward Fuselage Shape

nose size allowed a decrease in the width of the nose to a size required to support the Archytas nose gear unit and its related structures. This area reduction also helped decrease the weight.

The sides of the fuselage flanking the engine were widened to accomodate payload. Widening was necessary to provide room for fuel and airframe structural mounting of the wing and tail. This widening also benefitted the landing gear requirement of the forward flight mode and allowed the gear to be integral to the fuselage.

With the bulk of the fuselage sized and its dimensions somewhat solidified, the task of payload placement and actual fuselage structure was undertaken.

An all important aspect of the fuselage planform was the amount of strength required in the small horseshoe shaped area through which all structural stresses would eventually pass.

Provision was made for mounting of the engine, tailboom, landing gear and wings. By examining other models, it was decided that a 1/4 inch plywood frame skeleton would serve as the backbone of the basic form (Figure 13).

Careful consideration was given to this structure and only those areas which needed this strength and corresponding weight increase received the support. The tailboom mount, inboard fuselage walls for the engine mount, wing sparbox and the forward avionics and nose spar crossmember are all

constructed of 1/4 inch plywood. This laminated wood structure made for a solid structure to which components were mounted and provided the necessary structural strength.

To taper the form smoothly to a minimal area in front of the engine and add strength across the frame, a one inch by one inch laminated plywood cross member served as a fuselage spar. The word "spar" is used in the traditional sense, recognizing the thinness of the fuselage and similiarity to a wing section through the area. The wing attached to the fuselage through a sparbox (Figure 15).

To maintain a minimal body thickness the payload and structure design had several constraints. The largest electronic components that were used dictated a thickness of three inches in those areas which would house avionics and electronics. The wing root thickness, which when inclined to its 4 degree incidence, was only slightly greater than three inches.

The wing incidence angle was arrived at in the following manner. By using Equation 3 and the estimated values of the weight of the airframe and a design cruise speed of 70 KTS the C_L value of 0.278 was determined. From a computer analysis using the New-Panel computer program used in Advanced Aerodynamic Technique course AE 3501, a value for $Cl_{\alpha 2-D}$ of $0.121/^\circ$ was obtained. From equation 4 with the values of $f = 1$ and $E = 1.06$ from Reference 8 page 11, the three dimensional

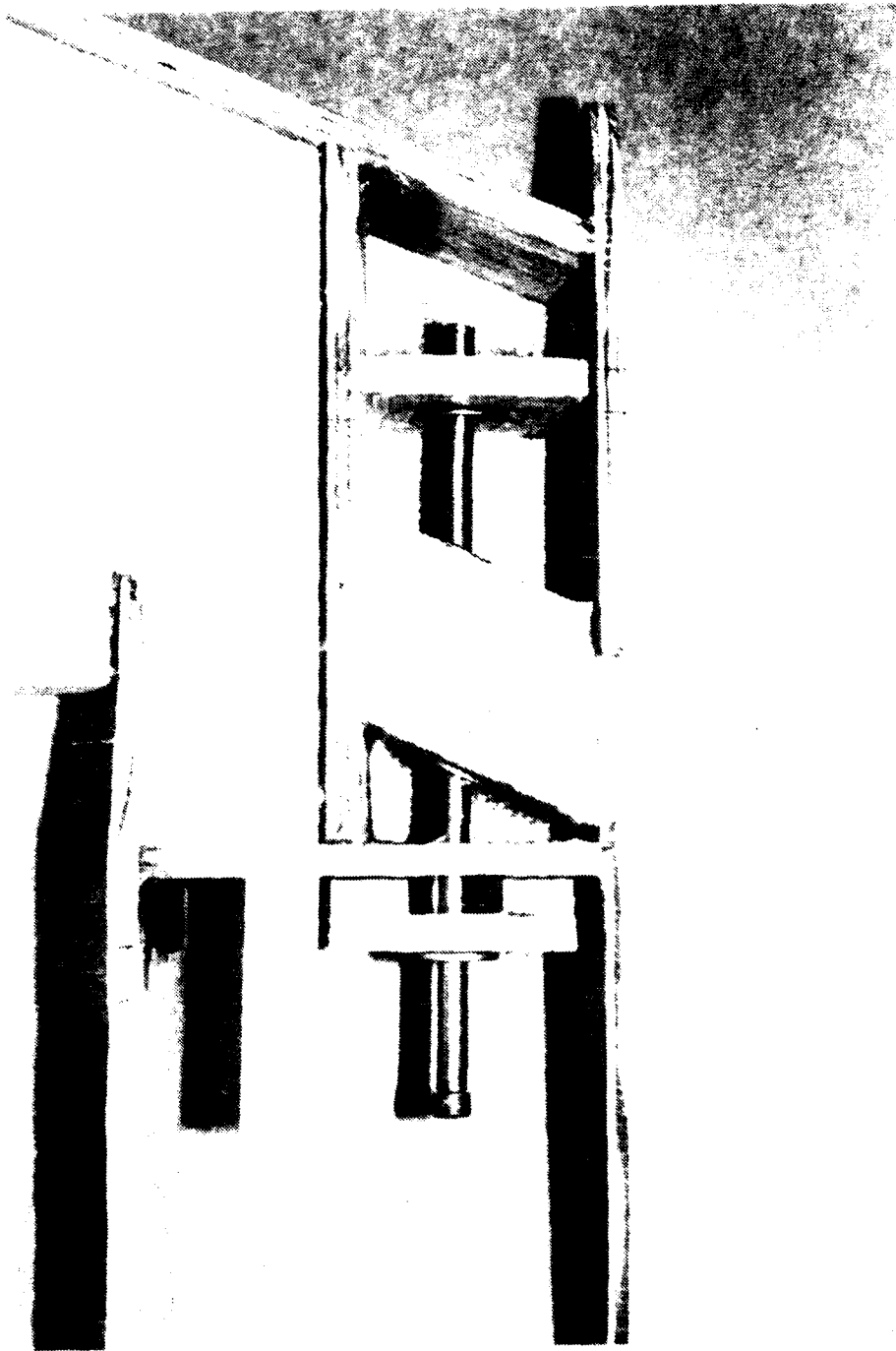

Figure 15. Wing Sparbox

value for Cl_{α} of $0.0715/^{\circ}$ was calculated. This required the wing incidence be set at an AOA of 4° to achieve the required design C_L value of 0.278.

Another area which required 1/4 inch plywood strength was in the forward cross-member of the avionics section. The forward crossmember must allow access through to the nose bay from the avionics section and appropriate access holes were cut (Figure 13). It was also decided should weight become a concern that lightening holes could be made in other sections of the framing if needed. In finishing the design, the components and frame were mated on paper and the basic size, shape and component placement in the fuselage established (Figure 16).

The materials selection for construction purposes was consistent with the light weight requirement. In addition to the light weight plywood skeleton, the fuselage forward of the engine was formed from blue urethane foam billet. The flanks, access panels and sparboxes were covered in 1/8th inch thick balsa wood. It was necessary to glue balsa cover plates to the foam. Balsa provided a solid base for the access panels and tied the structure together, providing more strength than foam could alone.

Once the access panels were sized and marked, the final surface shape was determined and the entire structure was fiberglassed with fiberglass cloth and epoxy resin. To insure

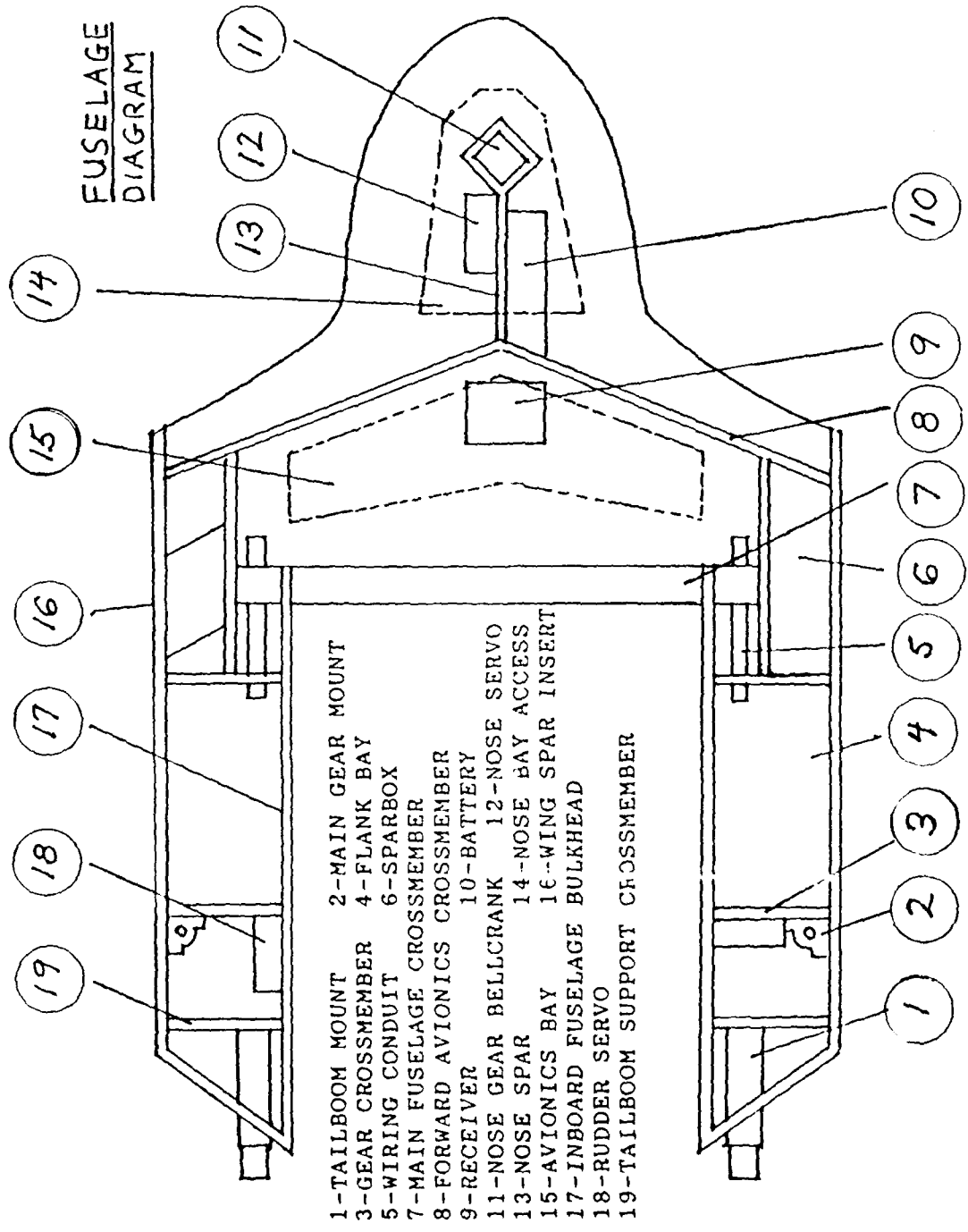

Figure 16. Fuselage diagram

structural integrity under dynamic loading during flight, the load-bearing areas received more layers of fiberglass than non load bearing areas, primarily through the center cross-member as seen in Figure 17.

With the fuselage entirely glassed, the access panels were opened and the layout of the avionics and electronics done. Previous measurements taken for all the electronics and the careful placement of components resulted in almost the entire internal volume being utilized. Mounting of the components was done on existing wood structure where the structure was available. Balsa sheet was applied in those areas which were foam. Wiring access conduits were designed in the sparbox area for wiring to pass from the avionics section to the flanking fuselage instrument bays.

The hollow tail mount carried the control linkages and wiring to the tail. The TDF mounted to the inboard fuselage bulkheads and the main and nose gear to the aft crossmembers and nosespar. The area for the gas tanks was measured and fit for 14 ounce tanks. This fuel required figure was estimated from historical UAV aircraft fuel consumption and desired flight time. Detailed construction processes are explained in the next chapter.

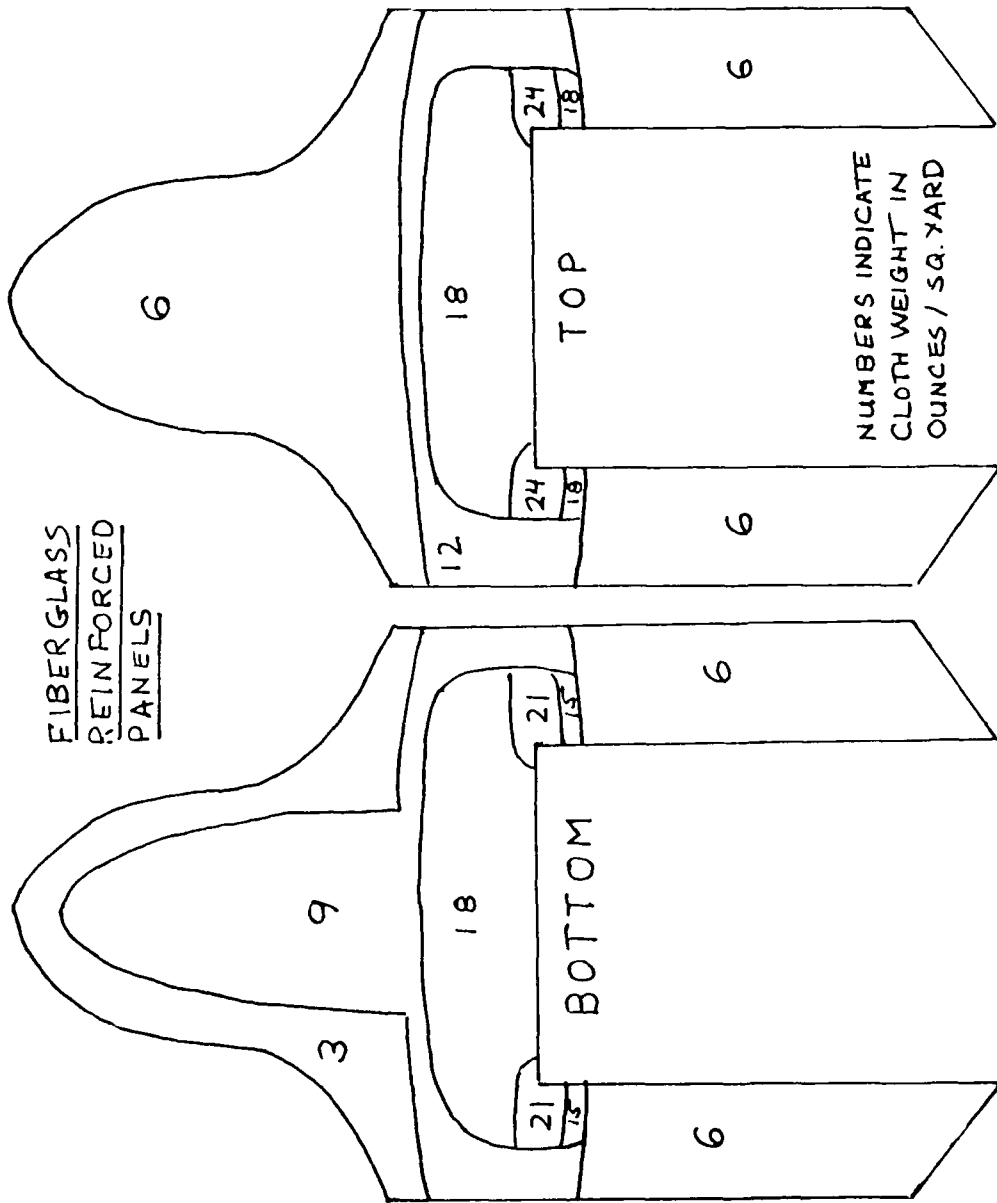

Figure 17. Fiberglass Panels

C. TAILBOOM

The design of the tailboom had as its primary goal the enhancement of directional and longitudinal stability flight characteristics, which were deficient in the tailless Aquila design. A secondary consideration, but of significant importance, was to maintain the stealth characteristics of the original Aquila design. Therefore designing a minimal but functional tailboom meant reaching a compromise in the length (moment arm) and the size (surface area) of the tail structure. This meant obtaining effective horizontal and vertical tail volume ratios.

Considering that a vectored thrust ducted fan-rotor was the propulsion unit, a twin-boom T-tail was chosen to keep the tail surface out of the prop-wash. When designing for the length of the tailboom it was necessary to consider a concurrent design of the vertical gear height. A complete description of the gear design follows in the next section, but several aspects must be mentioned here as they are crucial to the tail design.

When deciding the length of the longboom configuration, the taildown angle of 11° was a compromise of the gear height and the clearances required for tail rotation clearance on takeoff and landing (Figure 18). Next in the design process, it was necessary to consider the size of the tail surface

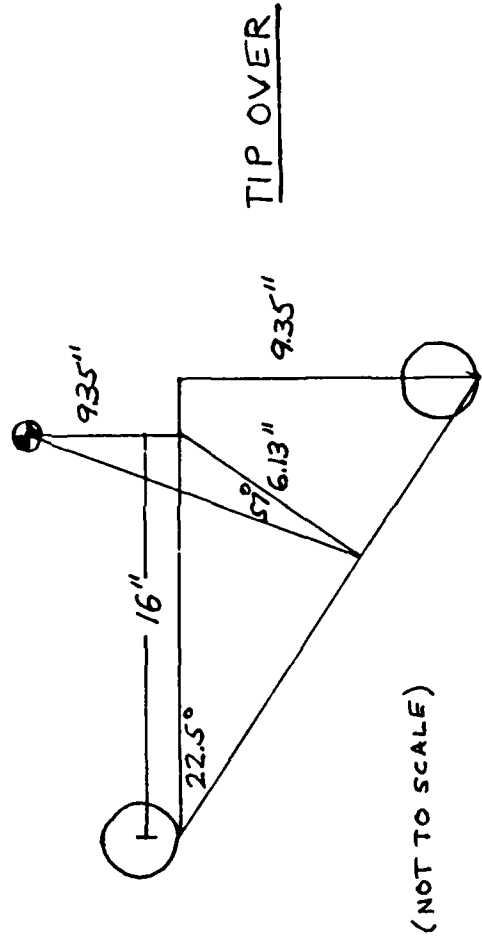
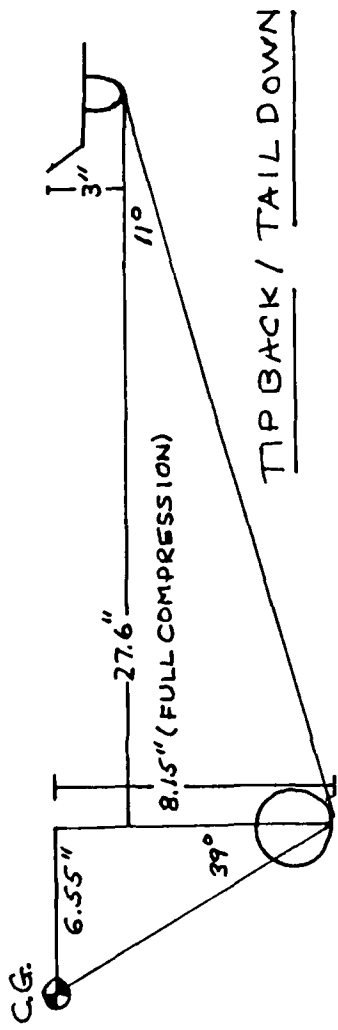

Figure 18. Tail/Gear Geometry

necessary to yield sufficient tail volume and still consider the aesthetics and remain as stealthy as possible.

The horizontal tail sizing resulted from requirements of both the long and short tail configurations. Various tail planforms were examined with the desire to continue in the planform pattern of the wing sweep. A tapered horizontal surface was chosen (Fig 19). To meet both of the tails' sizing requirements, a horizontal surface area (S_h) of 150 in² with a horizontal tail volume ratio of 0.41 for the long and 0.17 for the short configuration was chosen (Eqn 1). This long tail value is about 73% of the historical norm for homebuilts and single-engine propeller driven aircraft (Ref 7:p.191).

The vertical fin was sized to clear the horizontal surface from propwash with a ventral fin for taildown protection. The vertical fins are canted 8° top inward from the vertical to minimize radar return. Tapering the surfaces to meet the structure of the horizontal tail resulted in the planform area of each vertical tail of 56 in². The resultant vertical tail volume ratio was 0.09 for the long boom and 0.039 for the short boom (Eqn 2). This result is a 200% increase (for the long boom) over the historical averages for the single engine propeller driven aircraft value of 0.044 (Ref 7:p.191). This increase was necessary to insure adequate performance in the short tail configuration. The next design step was to chose an airfoil section.



Figure 19. Tail Planforms

For its simplicity and an abundance of experimental data available the NACA 0012 was chosen (Ref 8:p.462). A 12% thickness airfoil allowed for maximum structural benefit from bending stresses while minimizing the section drag. The symmetric airfoil can produce moments in both directions, a requirement of the tail moment arm.

With the tail area sized and the taper set for aesthetics, the calculated horizontal area to wing area ratio of 0.169 compared favorably with recommended values of 0.16 to 0.20. The vertical area ratio of 0.126 was more than the recommended 0.075 to 0.085. (Ref 9:p417)

The control surface areas as a percentage of the respective surface area are 50% for the horizontal and 43% for the vertical. This control surface sizing results from the necessity of a large control surface for the short boom configuration studies later. Recommended values for a ratio of control surface to its respective tail surface are 0.5 to 0.55 for the elevator and 0.5 to 0.6 for the rudder. (Ref 9:p417)

The next task of the tail design was to set the incidence angle of the horizontal surface. The angle was found from Equation 5 (Ref 10;p 382), with the values of C_{macwb} and a_{wb} obtained from the New Panel program, $\delta\epsilon/\delta\alpha$ obtained from Reference 11 page 224 and the calculated values in Appendix B. The tail incidence angle for the longboom horizontal tail was

found to be + 2.0° leading edge up from the fuselage reference line. This angle is a preliminary "best guess", so a provision for changing the angle is built into the horizontal attachment by a balsa wood spacer.

The horizontal section bolts on with nylon bolts with a balsa spacer between the horizontal surface and the top of the vertical. This allows for tail incidence angle adjustment. The tail control surfaces are serviced by electronic servos; the rudders by cable from fuselage mounted servos and the elevator by an internal structure mini-servo.

The boom section itself was made from aluminum tubing with an aluminum plug to make it sectional for use in the short boom configuration and for easy removal for transportation and storage. The detailed construction processes are discussed in the next chapter.

D. LANDING GEAR

To keep the landing gear integral to the fuselage, two design requirements, tipback angle (C.G. to vertical from main gear ground contact) and taildown angle (horizontal to tail bottom from main gear ground contact) both had to be satisfied by gear and tail clearance limits (Figure 18). Aircraft C.G., gear height and gear track are the primary factors in determining the landing gear geometry.

From the figure, the resultant tipback angle (C.G. forward of main support) was 35° . The resulting taildown of 11° allows for takeoff rotation without striking the tail on rotation. This angle was calculated from the horizontal distance of the gear aft of C.G. (obtained from the 25% - 75% weight distribution) and the height of the gear from the ground to C.G.

The taildown angle also provides engine shroud ground clearance on takeoff and landing. The resultant tipback and taildown angles are within design limits of Reference 9 page SAWL-5. The metal runner protruding from the ventral vertical tail will protect the tail and rudder from inadvertant ground contact during T/O and landing.

Another gear geometry feature is tipover angle which is found from an axis of rotation about the main and nose wheel points of ground contact. From Figure 18 this angle is 57° . Wingtip skids provide additional protection in case of an inadvertant tip during taxi or landing.

The structure of the gear assembly itself consists of an aluminum fuselage mount, gear shaft and wheel fork (Figure 20). The shocks and tires were obtained from model suppliers. The axle and shock mount shafts are $3/16$ inch steel rod. All pieces can be easily replaced should failure occur.

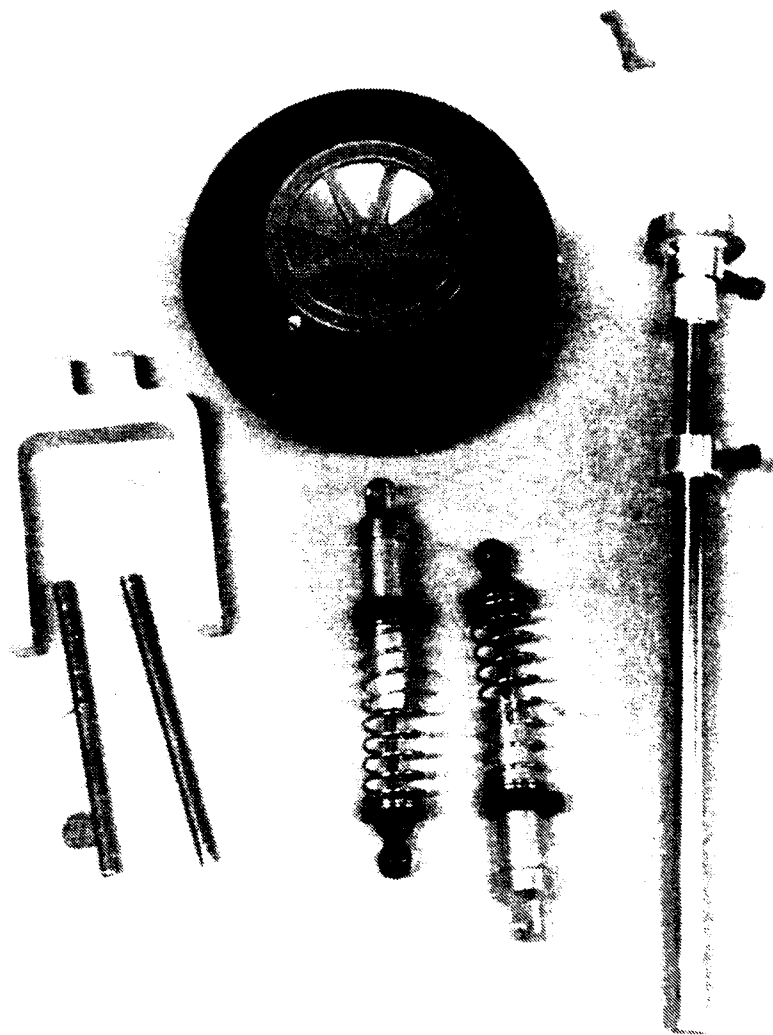

Figure 20. Nose Gear Parts

E. ENGINE

The actual design of the Tilted Ducted Fan was a topic of a concurrent thesis (Ref 6). The engine chosen was a 4 H.P. twin-cylinder, commercially-available design (Figure 21). The engine is mounted to a metal structure which houses the servos used in controlling the TDF control vanes (Figure 22). This structure is surrounded by a propeller shroud to contain the flow back to the control vanes, to increase prop efficiency and to offer some protection from the propeller blades (Figures 23 & 14).

The entire structure is designed to mount at the C.G. of the airframe. The propeller shroud is structurally reinforced for mounting in both the horizontal and vertical position in the fuselage for forward and vertical flight.



Figure 21. TDF Engine

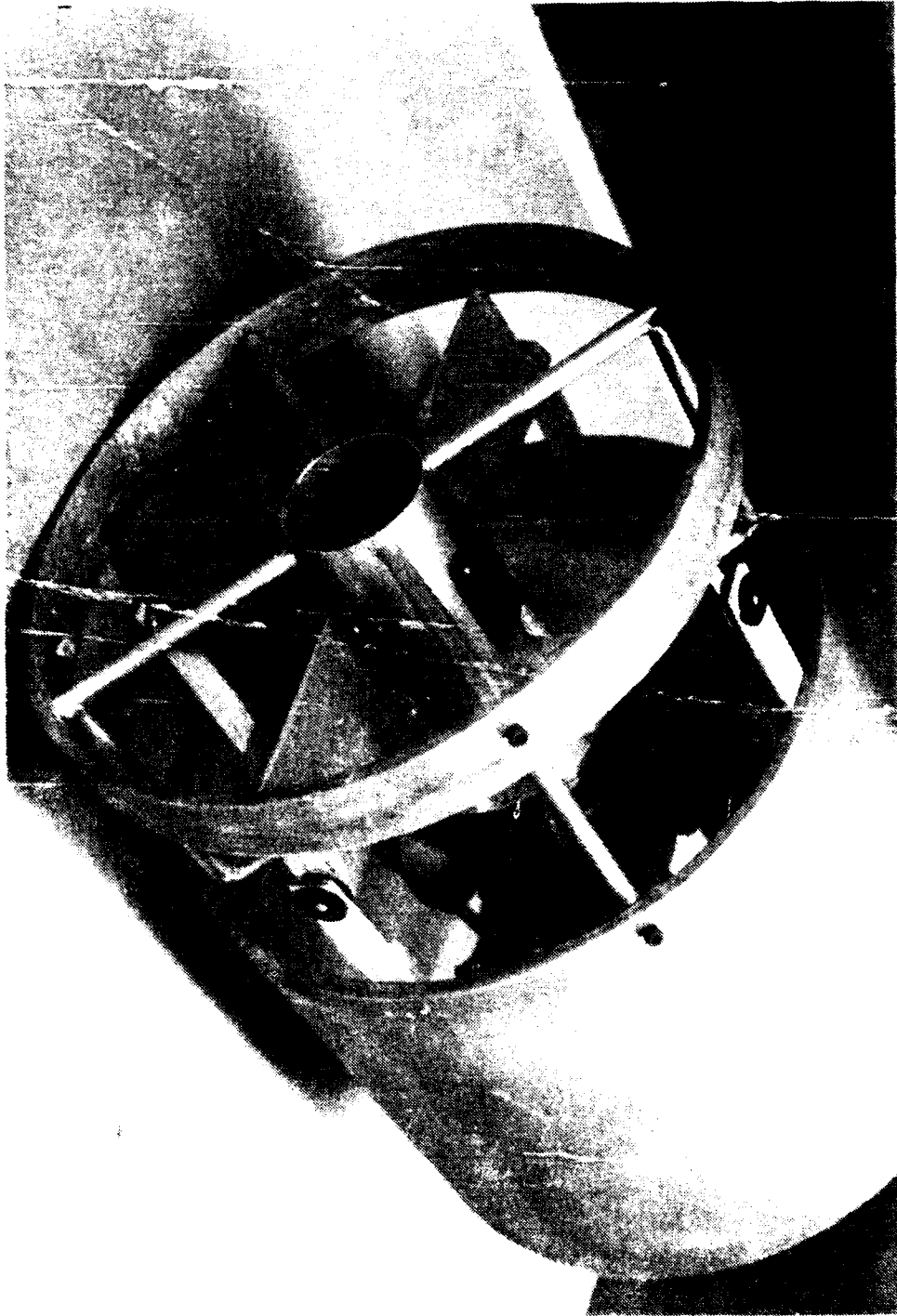

Figure 22. Control Vanes

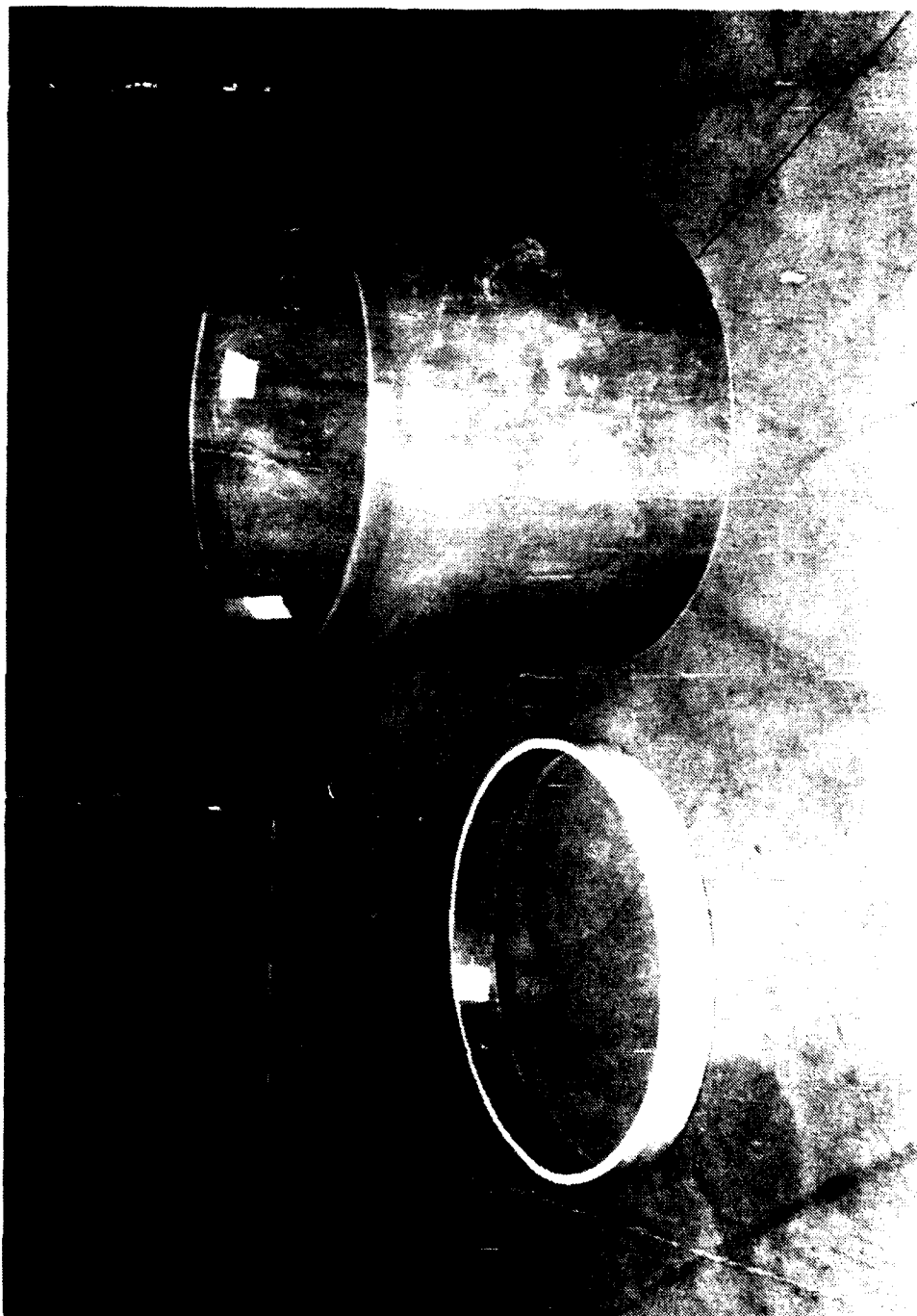

Figure 23 Propeller Shroud

IV. CONSTRUCTION TECHNIQUE

A. WING

The wing began as a urethane foam block (Figure 24). Using the hot-wire foam cutting techniques of Reference 12, the planform was cut for leading and trailing edges and for the root and tip chord. Wing section templates were attached to the root and tip and the section shape cut.

The next step was the insertion of the spars. The foam was removed in the area of the main and aft spar. The shear web (vertical portion) was inserted and epoxied in place. The spar caps were epoxied to the shear web. When finished, the entire structure was hand shaped and sanded using a commercial grade spackling compound to contour and finish the surface. (Figure 25)

The next step was to fiberglass the structure. An epoxy resin matrix was applied to 3-oz. bi-directional fiberglass cloth, covering the foam core. The first layer of fiberglass gave the structure the support and protection necessary while the control surfaces were cut (Figure 26). The control surfaces were faced with a thin 1/16th balsa sheet for structure and for hinge mounting surfaces. When all pieces were fitted and finished, the entire structure was given a

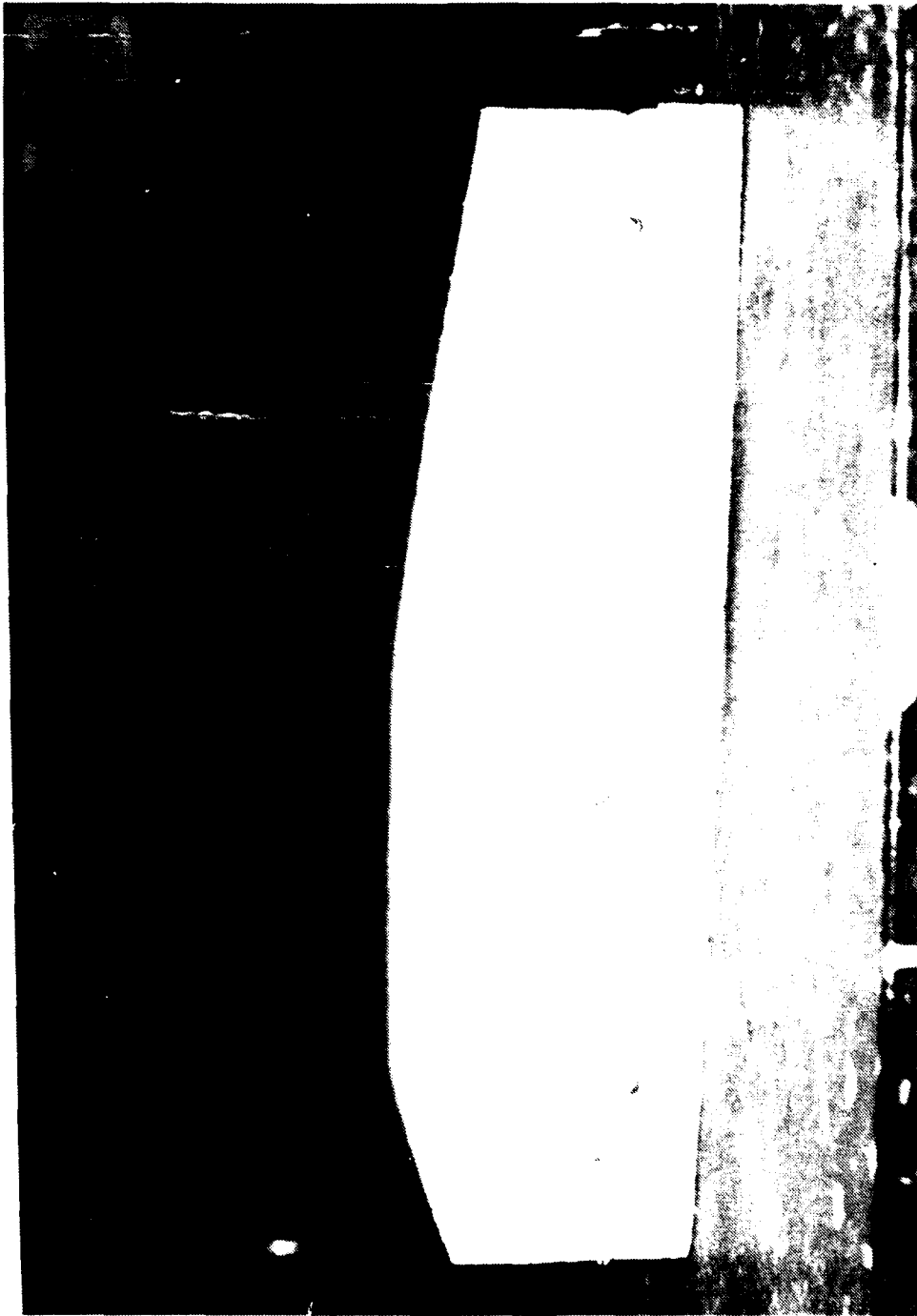

Figure 24. Wing Foam Block

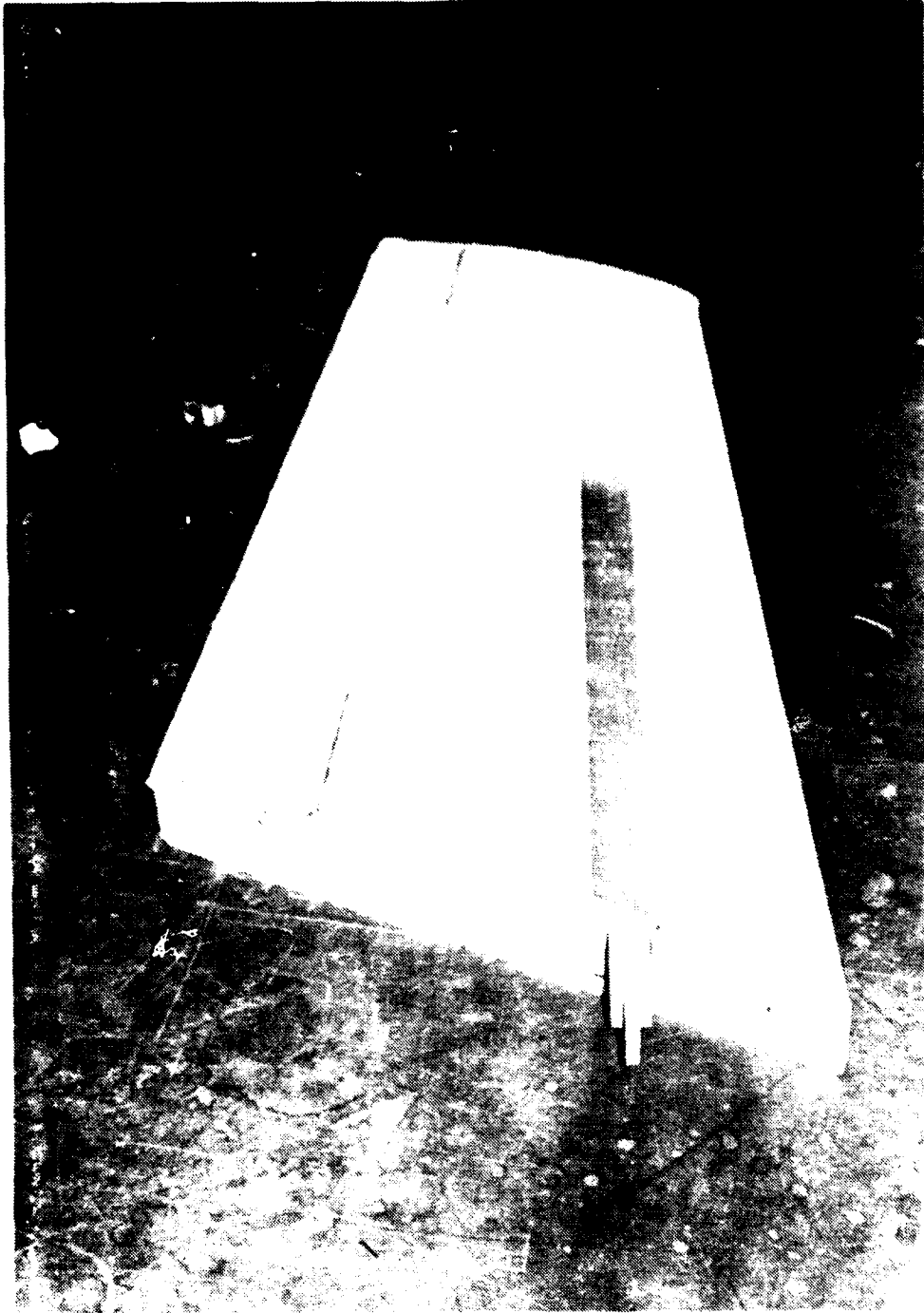

Figure 25. Finished Wing Surface



Figure 26. Wing Control Surfaces Cut

second layer of fiberglass and resin (Figure 27). The control servos for the flaps and ailerons were mounted in cutouts from the bottom surface to minimize airflow disturbance. The control surfaces were mounted on a hinge shaft, which ran through the structure and acted as a bearing surface. The final step was to fit the spar into the spar box and insure a tight mating of the wing root to fuselage. A steel rod secured the spar in the sparbox.

B. FUSELAGE

The fuselage is the central structure of the aircraft and must provide for the transfer of loads from the other load-bearing components. The 1/4 inch plywood frame served to carry this load and provide a form for the basic shape. After the framing was cut to size a foam billet was cut to fit in the avionics section of the fuselage. The same wing section root template was used for the outboard fuselage section of the structure and set at 4° incidence. The entire structure was assembled using cyanoacrylate glue (Figure 13). All joints were reinforced with fiberglass cloth and resin.

With the primary structure laid, the next step was the installation of the various mounts and attachments. Beginning at the aft portion of the structure, the tail boom mount was epoxied and pinned into the exterior frame and a structural cross-member (Figure 28). A hole was drilled in the forward



Figure 27. Finished Wing



Figure 28. Tail Boom Mount

flank bay and a plastic sleeve inserted to act as a wiring conduit to the avionics bay (Figure 29). The wing spar was inserted and a structural box built to shape in the sparbox. (Figures 29 & 15). The nose spar was cut and epoxied into the nose section. Remaining components would be installed after the structure was finished.

The next phase of construction involved the actual shaping of the structure. The leading edge and nose were hand shaped from urethane foam. The initial shape was template cut and epoxied in place. Balsa wood was epoxied to the foam surface in those areas which were to be access panels. Balsa was also used as the form for the fuselage flanks. The surface was finished with spackling compound, the access panels were marked and the surface prepared for fiberglass. (Figure 30)

The fiberglass was laid in several stages to insure that adequate care was given to control the shaping process. Experience aided in the selection of which type cloth to use to meet the different shape requirements. A loose weave 4-oz. cloth was used to make the 90° angles in sharp corner areas and a fine weave 6-oz. cloth was used in panel and structural loading areas (Figure 31).

When the fiberglass was finished curing, the task of sanding began. The entire structure was brought to the desired contour with a talcum powder and resin compound, and

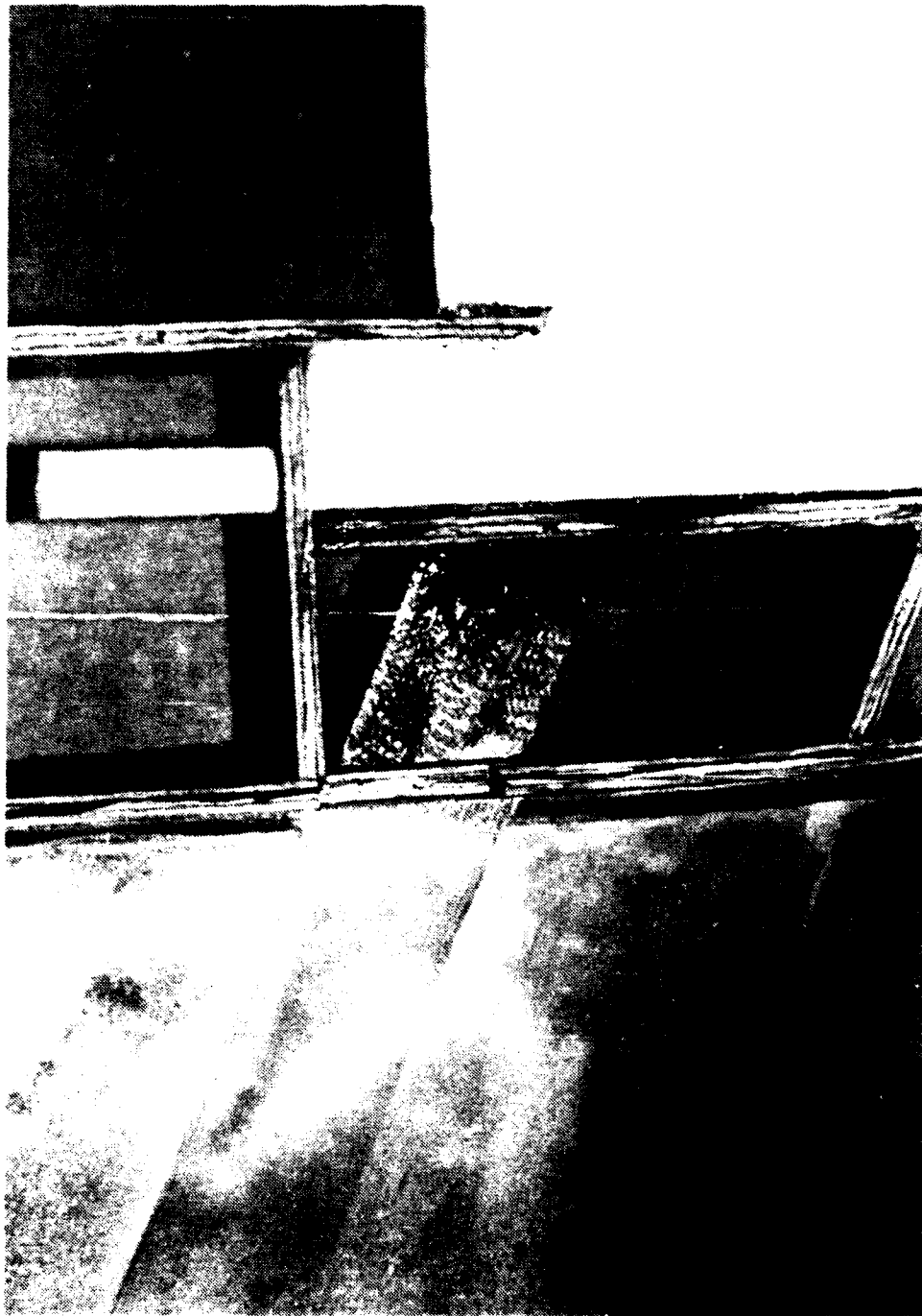

Figure 29. Wing Spar



Figure 30. Contoured Fuselage

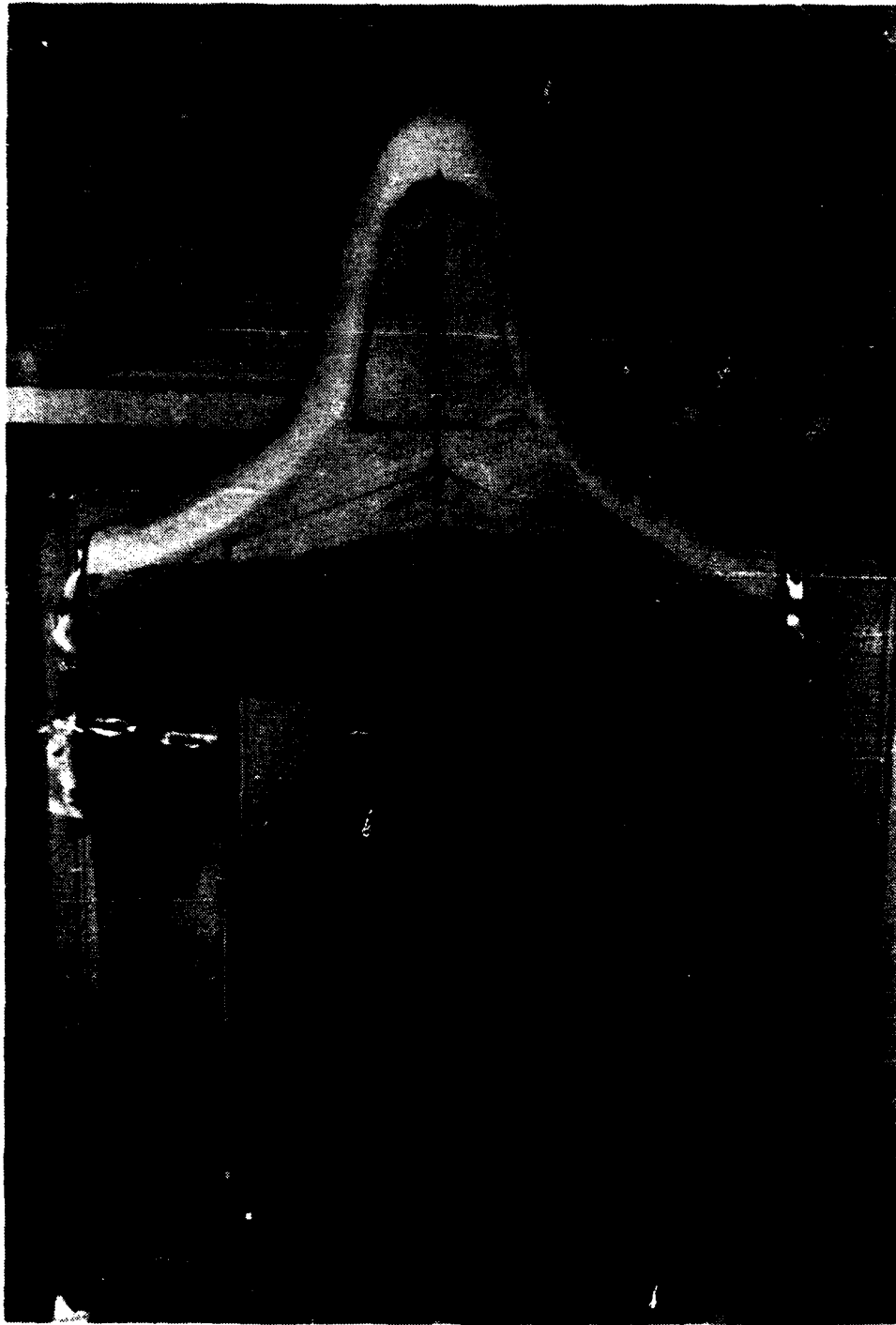

Figure 31. Fiberglassed Fuselage

then sanded and smoothed. The access panels were then cut open and the foam removed for component placement (Figure 32).

Beginning in the aft part of the structure in the flank bay, cross-members for the main gear mount were installed. The aluminum main mount structure was attached by screws. These cross-members also served as mounts for the rudder servos. The fuel tanks were installed in a foam case for ease of removal to access the wing spar pin during disassembly. (Figure 33)

The avionics bay immediately forward of the engine was designed to house the stability control system for the vertical flight mode. The nose bay, aside from the nose gear mount, housed the nose servo, battery pack and receiver (Figure 34).

With all of the components fitted the access panels were reinforced with 1/8th inch plywood. Wooden structural mounts were installed in the fuselage to mount the access panels. Inserts were used to allow for removal of the panels.

With all structures fit and the surface finished, the aircraft was painted high-visibility orange and white.

C. TAILBOOM

The construction of the modular tail was done in two parts: the boom section and the airfoils. The entire



Figure 32. Fuselage Access Panels

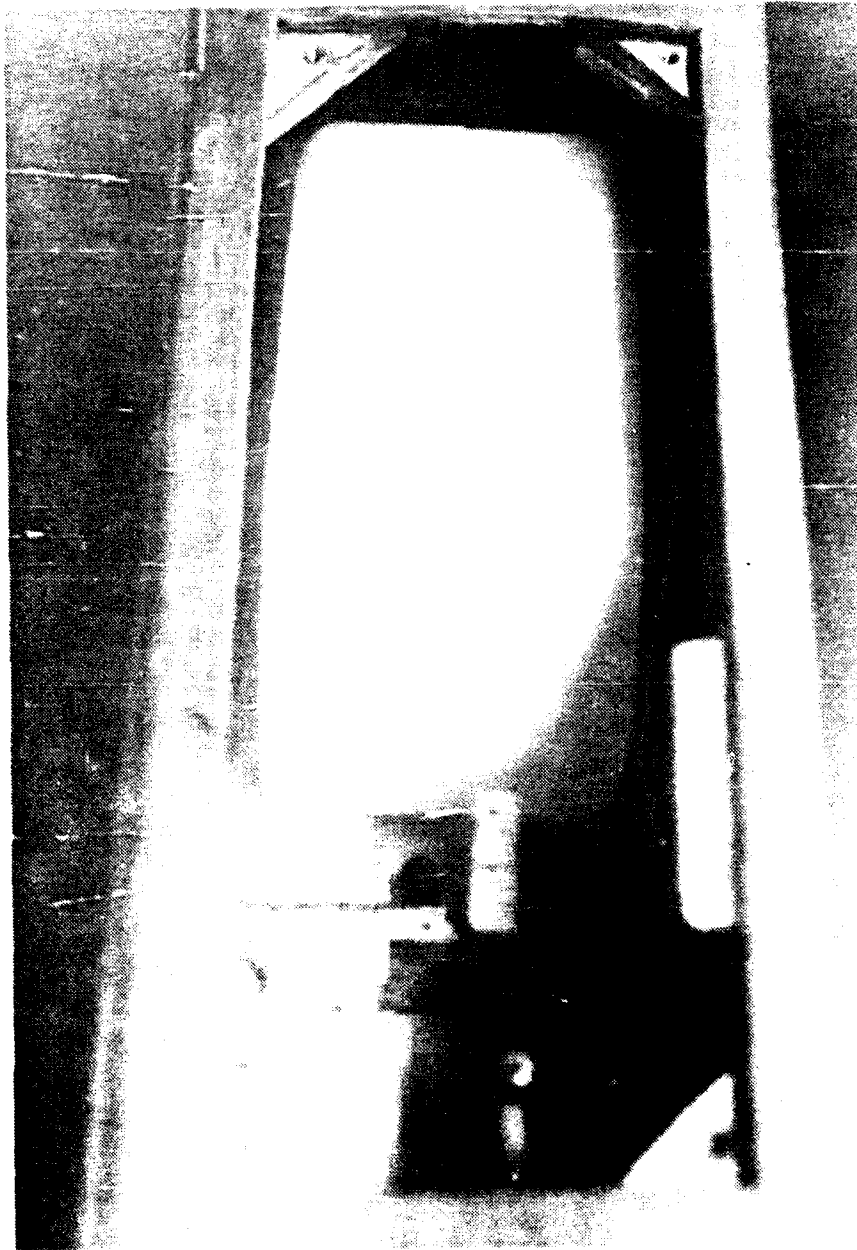

Figure 33. Fuselage Flank Bay



Figure 34. Fuselage Nose Bay

structure is sectional, for the configuration changes and for disassembly.

The tail booms were constructed from thin-walled (0.035 inch), 1 inch O.D. aluminum tubing, which can be broken down to the required lengths. This approach minimizes the weight, yet provides the necessary structural strength where needed. These tubes were cut to the desired lengths to provide structural attachment to the fuselage (3.9 inch), a section for the vertical tail surface attachment (6.5 inch) and a removable section (19.1 inches) for transforming the long tailboom to the short boom (Figure 19).

To join the sections together, an aluminum plug two inches in length and 0.2 inches wall thickness with an O.D. matched to the tubes I.D. was used. This plug provided the necessary strength and also served as a rigid attachment for the nylon screws, which holds the sections together. The 3.9 inch fuselage piece was epoxied and pinned in the fuselage for additional security. The tail-boom longitudinal axis was set incident to the fuselage.

All sections were drilled and tapped for 1/4-20 nylon bolts. The entire boom structure also served as a conduit for the control linkages and wiring path from the fuselage to the tail surfaces. The aluminum section for the vertical tail piece went to the rear vertical face to provide maximum

strength without interfering with the control surface movement.

The airfoils were cut by hot wire from the same urethane foam as the wing. The shape of the surfaces required they all be cut in two pieces because of the root-to-tip taper present in each (Figure 19). Using a NACA-0012 template the airfoils were cut and reassembled as seen in the figure. The wing templates were epoxied to all open section edges and served as structure. Finally the first layer of 3-oz. fiberglass was applied.

Next the control surfaces were cut to their 3 inch width and the cut surfaces faced with 1/16th inch balsa. This balsa facing acted as a lengthwise spar and provided a solid attachment for the hinges.

To attach the vertical fin to the boom tubing, a section of the foam-glass structure was removed while maintaining the original planform dimensions. The section was then sanded to fit with an identical section of tubing covered with sandpaper. This technique insured maximum surface contact of the sanded area for the attachment of the vertical fin to the 6.5 inch boom section.

The foam-glass structure was epoxied onto the tubing at an 8° inboard tilt and any gaps were filled with the epoxy-talc compound to insure a good bond and to provide a smooth continuous aerodynamic shape. When all the surfaces were

finished, the balsa faces and the aluminum tubes were fiberglassed in position. All structures were then sanded to a final surface finish.

The top of the vertical surface was left exposed foam, awaiting mounting hardware for the connection of the horizontal surface and the incidence angle balsa spacer. The tail incidence angle is + 2.0° (leading edge up) from the fuselage reference line, which is incident with the tail boom axis.

To mount the horizontal tail surface one inch nylon 1/4-20 bolts were used. A 1/2 inch hole was drilled in the horizontal surface at the point of attachment to each of the vertical fins. The holes were drilled at an 8° angle, parallel to the axis of the vertical fin, and then a cored wooden dowel sleeve was epoxied in place. A similar 1/4-20 tapped 1/2 inch dowel insert was epoxied in the top of each of the the vertical fins. These inserts were staggered to preclude any accidental mismatch or inadvertently providing a hinge line for twisting in the structure. These sleeves were set securely with a chopped fiberglass, micro balloon and epoxy-resin compound.

Finally, the control surfaces were hinged with 1/4 scale model hinges. A section of 0.047 steel piano wire was used to align the hinges prior to epoxying in place. The control linkage for the rudder was epoxied in the removable mid-

section of the tail-boom. Being epoxied in the middle boom section provided rigidity in the mount, yet allowed for its removal when going to a short-boom or tailless configuration. The linkage can readily be attached at the servo and at the fitting used at the rudder attachment.

The elevator is served by a micro-servo located in the horizontal tail with its linkage hidden in the vertical/horizontal juncture (Figure 35). Once all pieces were fitted (Figure 36), the hinges were epoxied in place and the system checked for freedom of travel. The limits were established at +/- 30° for the rudders and +/-15° for the elevator. A final surface preparation was done prior to painting.

D. LANDING GEAR

The gear are constructed of steel and aluminum shafts, steel axles and commercially available wheels and shocks (Figure 20). The shocks required assembly and allowed for setting the shock damping at one of three settings. The mains were set at the highest damping and the nose shock at the middle damping.

The main gear shafts were made from 1/2 inch O.D. aluminum shafts. One end was tapped for screw mounting into the aluminum fuselage mount. The other end was turned on a lathe to fit the machined wheel forks.

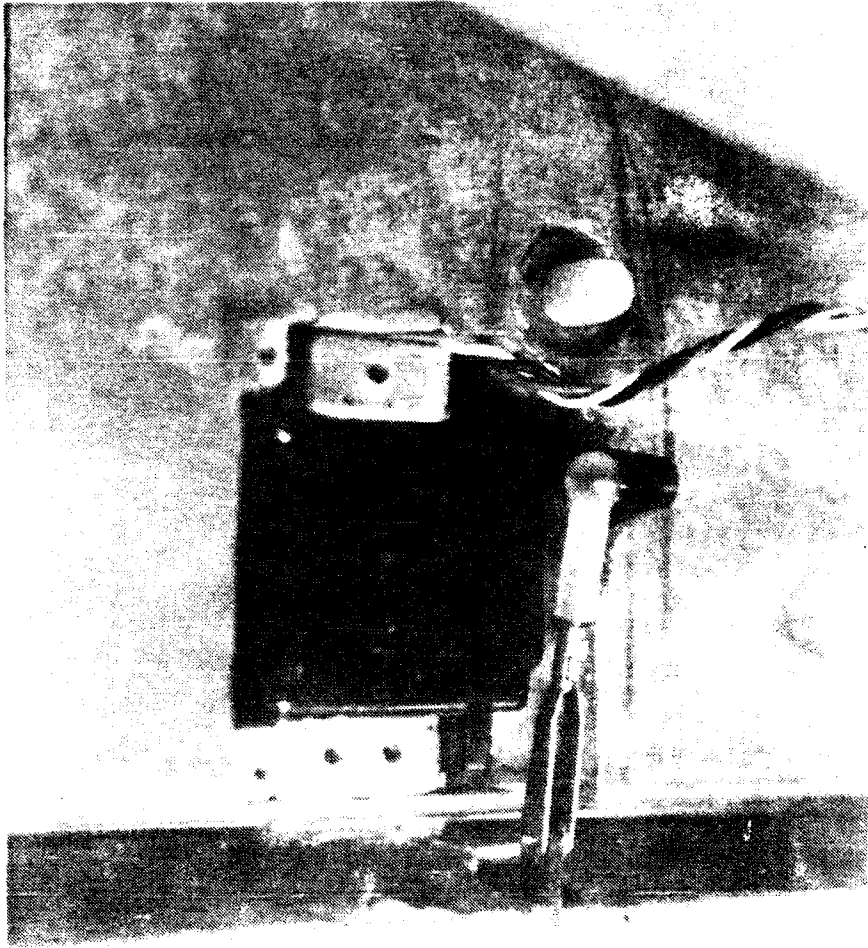

Figure 35. Elevator Microservo

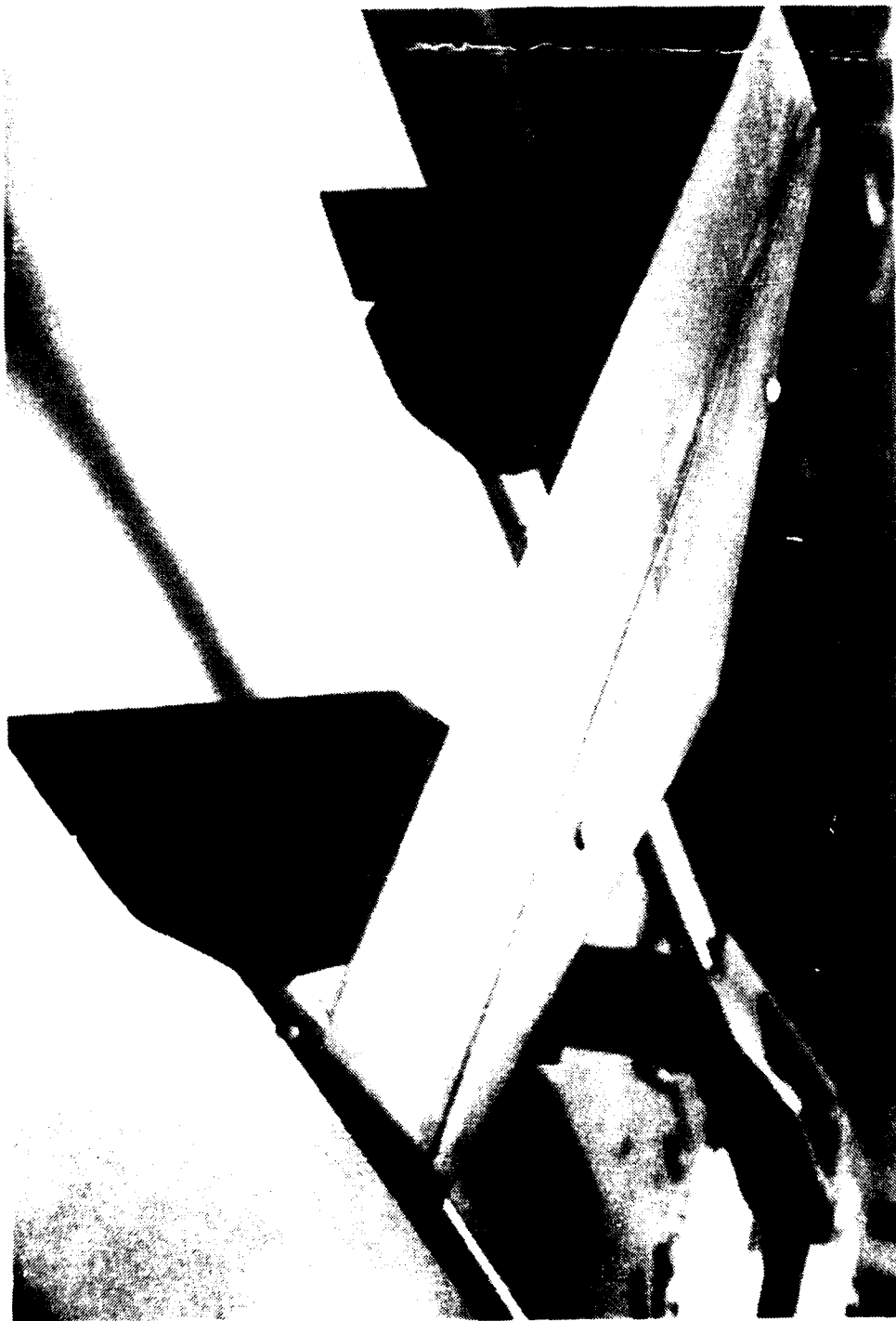

Figure 36. Archytas Tail

The axle holes for the wheel fork and upper shock mount were fixed in geometry by the amount of shock compression at the design weight and the clearance requirement of the gear geometry (Figure 18). When the axles were assembled, aluminum tube spacers were placed on the axles to prevent any inadvertent contact or rubbing.

The nose shaft was a hollow 0.3875 inch stainless steel tube with a wood dowel core added for strength. The wheel, fork and shocks were attached as for the mains. The nose gear design also provided for steering by a bellcrank attachment to an aluminum end cap on the top of the shaft. A phenolic block and plastic sleeve provided a bearing surface for steering.

E. ENGINE

The construction of the engine was accomplished as part of the concurrent thesis. Three main components were built. The engine and propeller shroud was shaped from three layers of laminated 1/16th balsa wood on a circular hardwood form. This balsa shape was covered in fiberglass and resin. An aluminum structure to house the control vanes and servos was bolted to the bottom of the shroud structure, and the engine was mounted internally.

V. STABILITY

The purpose of the tail configuration of the Archytas was to overcome the undesirable stability characteristics of the Aquila.

A. LONGITUDINAL

Three basic requirements for longitudinal static stability are: 1) $C_{M\alpha}$ be negative; 2) C_{M_0} be positive; 3) the C.G. be forward of the neutral point (positive static margin) (Ref 10;p 372).

Using data from the wing analysis the value of C_{M_0} was 0.00857. From equation 6 and the values obtained from the tail incidence angle analysis the value of $C_{M\alpha}$ was $-0.0159/^\circ$ for the long boom configuration and $-0.00367/^\circ$ for the short boom.

The final requirement of a positive static margin was found using equation 8. The neutral point h_n was found to be 0.54 c for the long boom and 0.37 c for the short boom, both being solved from equation 7. The static margin value is 0.22 for the long boom and 0.05 for the short boom. Obviously, the C.G. will be located further forward for the short boom and

the tailless configurations. All three longitudinal stability requirements are satisfied for both configurations.

B. LATERAL AND DIRECTIONAL

For directional stability $C_{l\beta}$ must be negative and $C_{n\beta}$ must be positive. From the National Aeronautic and Space Administration wind tunnel studies, the most favorable Aquila configuration yielded a $C_{l\beta}$ value = $-0.004/^\circ$ for a model with duct fins added. No specific value for $C_{n\beta}$ was disclosed in the article. (Ref 3)

The directional derivative examined was $C_{n\beta}$ and the contributions are from the vertical tail $C_{n\beta v}$ and from wing sweep $C_{n\beta w}$. From equation 9 the value found for $C_{n\beta v}$ was $0.0079/^\circ$. The value of $C_{n\beta w} = 0.0003/^\circ$ from equation 10. The combined value of $0.0082/^\circ$ for $C_{n\beta}$ was positive and is about twice the historical value for a fighter and three times that of a large transport (Ref 13;p.28).

The lateral stability derivative $C_{l\beta}$ gets most of its contributions from the vertical tail $C_{l\beta v}$, from the wing sweep $C_{l\beta w}$ and from the wing dihedral $C_{l\beta d}$. The values obtained from equations 11,12 and 13 are respectively $C_{l\beta d} = -0.00058/^\circ$, $C_{l\beta w} = -0.00045/^\circ$ and $C_{l\beta v} = -0.000179/^\circ$. The estimated $C_{l\beta}$ value is $-0.00121/^\circ$, low compared to the original Aquila derivative, but flight test will yield a more accurate value.

VI. CONCLUSIONS AND RECOMMENDATIONS

A. CONCLUSIONS

The Archytas airframe was designed and constructed to prove the feasibility of applying Tilted Ducted Fan technology to a vertical takeoff and landing vehicle. The airframe was also designed to serve as a testbed for tail configuration studies for an Aquila-like UAV. The tail was designed for three configurations: 1) a long boom for flight test of a normal tail configuration; 2) a short boom for flight test of a second configuration of reduced stability; and 3) a tailless vehicle to flight test the use of the TDF control vanes as a vectored thrust unit.

All the stability derivatives estimated by calculation appear to enhance those characteristics found lacking in the Aquila configuration. Only flight test and evaluation can complete the evaluation.

B. RECOMMENDATIONS

As in any new concept or design, there is a long road and much work to be done to complete the objectives of the Archytas research program. The airframe needs to have its initial flight tests performed to evaluate the design. Once

the airframe proves airworthy, the vertical and horizontal flight testing can begin.

The Archytas needs to be flight tested in the vertical mode to prove the TDF and controller concept. Then it needs to be instrumented with a pitot-static system and α and β measurement systems. Complete flight testing with calibrated instrumentation will include: 1) performance flight test; 2) stall testing; 3) longitudinal static and maneuvering stability; 4) lateral-directional stability tests; and 5) dynamic stability tests. All of these flight conditions need to test both the long and short tail configurations.

The tailless configuration also requires testing since the additional control available from the TDF control vanes can be used as vectored thrust. This vectored thrust may enhance the longitudinal and directional control and act as stability augmentation such that no tail is needed. The tailless configuration will maintain the stealth characteristics of the original vehicle. The addition of the flaps will contribute to control at low speed and can be used as a longitudinal trim device in the tailless configuration.

The Archytas is a stepping stone to implement new developments and airframe requirements into an Aquila-like airframe. The goal is to develop a full scale airframe capable of flight transition from the vertical takeoff and recovery concept to the high dash speeds capable of a high

thrust fixed wing vehicle. A compact stealthy UAV is being realized and is soon to be tested.

APPENDIX A - EQUATIONS

<p># 1 Ref 10; p. 381</p>	$V_h = \frac{x_h S_h}{S \bar{c}}$
<p># 2 Ref 7; p. 190</p>	$V_v = \frac{x_v S_v}{S b}$
<p># 3 Ref 10; p. 229</p>	$C_L = \frac{L}{1/2 \rho V^2 S}$
<p># 4 Ref 8; p. 11</p>	$a_{3-D} = f \frac{a_e}{1 + (57.3 a_e / \pi AR)}$
<p># 5 Ref 10; p. 382</p>	$C_{MCG} = C_{mac} + a_{wb} \alpha_{wb} [(h - h_{acwb}) - V_h \frac{a_t}{a_{wb}} (1 - \frac{\delta e}{\delta \alpha})] + V_h a_t (i_t + e_o)$
<p># 6 Ref 10; p. 384</p>	$\frac{\delta C_{MCG}}{\delta \alpha} = a [(h - h_{acwb}) - V_h \frac{a_t}{a_{wb}} (1 - \frac{\delta e}{\delta \alpha})]$
<p># 7 Ref 10; p. 386</p>	$h_n = h_{acwb} + V_h \frac{a_t}{a_{wb}} (1 - \frac{\delta e}{\delta \alpha})$

# 8 Ref 10; p. 388	static margin = $h_n - h$
# 9 Ref 14; p. 73	$C_{n\beta_v} = a_f V_v \left(\frac{V_F}{V_\infty} \right)^2 \left(1 - \frac{\delta\sigma}{\delta\beta} \right)$
# 10 Ref 14; p. 78	$C_{n\beta_v} = C_d \frac{\bar{y}}{b} \sin 2\Lambda_{c/4}$
# 11 Ref 15; p. 24-4	$C_{l\beta_d} = - \frac{a_w \gamma \bar{y}}{57.3 b}$
# 12 Ref 14; p. 78	$C_{l\beta_v} = - C_L \frac{\bar{y}}{b} \sin 2\Lambda_{c/4}$
# 13 Ref 14; p. 79	$C_{l\beta_v} = - a_f V' \left(\frac{V_F}{V_\infty} \right)^2 \left(1 - \frac{\delta\sigma}{\delta\beta} \right)$
# 14 Ref 15; p. 25-2	$V' = \frac{Z_F S_F}{b S}$

APPENDIX B SPECIFICATIONS

AIRFRAME DATA:

$$S = 788 \text{ in}^2$$

$$b = 52.4 \text{ in}$$

$$\lambda = 0.636$$

$$c_{mac} = 15.28 \text{ in}$$

$$y_{mac} = 12.13 \text{ in}$$

$$V_{hi} = 0.41$$

$$V_{vi} = 0.09$$

$$V_{hs} = 0.17$$

$$V_{vs} = 0.039$$

$$AR_w = 3.5$$

$$h_{ac} = 0.25$$

$$h_{cg} = 0.32$$

$$h_n = 0.54$$

NEW PANEL DATA:

$$C_{mo} = 0.00857$$

$$Cl_{\alpha 2-D} = 0.12076$$

$$Cl_{\alpha 3-D} = 0.0715$$

REFERENCES

1. Gwynne, P., "Remotely Piloted Vehicles Join The Service," High Technology, v. 7, n. 1 January 1987
2. Quantico, VA, "Marines' Remotely Operated Devive Will Use Aerial Fiber-Optic Link," Aviation Week and Space Technology, February 2, 1987
3. Phelps III, Arthur E., *Wind-Tunnel Investigation of an Armed Remotely Piloted Vehicle*, NASA TM-80132 TR-79-41, 1979
4. Kandebo, Stanley W., "Sikorsky Tests Proof-of-Concept RPV That Uses Coaxial Technology," Aviation Week and Space Technology, May 21, 1990.
5. Kandebo, Stanley W., "Grumman Refining Naval Multimission Concept," Aviation Week and Space Technology, May 22, 1987
6. Blanchette, B. M., *The Design and Construction of a Ship Launched Unmanned VTOL*, Master's Thesis, Naval postgraduate School, Monterey, California, June 1990
7. Roskam, J., *Airplane Design- Part II, Preliminary Configuration Design and Integration of the Propulsion System*, Roskam Aviation & Engineering Corporation, Ottawa, KS, 1989
8. Abbott, I. H. and Von Doenhoff, A. E., *Theory of Wing Sections*, Dover Publications, Inc., New York, NY, 1959
9. Stinton, S., *The Design of the Aeroplane*, Van Nostrand Reinhold Company Inc., New York, NY, 1985
10. Anderson J.D., *Introduction to Flight*, McGraw-Hill Book Company, 1985
11. Perkins, C.D. and Haige, R.E., *Airplane Performance Stability and Control*, John Wiley and Sons, Inc., New York, NY 1949
12. Alexander, J., *Foam Wings*, R. C. Modeler Corp. 1971

- 13 Roskam, J., *Airplane Flight Dynamics and Automatic Flight Control - Part 1*, Roskam Aviation & Engineering Corporation, Ottawa, KS, 1982 (Appendix C)
- 14 Etkin, B., *Dynamics of Flight*, Wiley, New York 1972
- 15 Etkin, B., *Aircraft Performance and Static Stability* course notes AE 2036, Naval Postgraduate School, Monterey, CA, spring quarter 1989

INITIAL DISTRIBUTION LIST

	Copies
1. Defense Technical Information Center..... Cameron Station Alexandria, VA 22304-6145	2
2. Library, Code 0142..... Naval Postgraduate School Monterey, CA 93943-5002	2
3. Chairman..... Department of Aeronautics and Astronautics Code AA Naval Postgraduate School Monterey, CA 93943-5000	1
4. Mr. Rick J. Foch..... Naval Research Lab Code 5712 4555 Overlook Avenue, S.W. Washington, D.C. 20375	1
5. Commanding Officer..... Unmanned Aerial Vehicles Joint Project Office Naval Air Systems Command ATTN: Dr. Thomas Killion PDA-14UD Washington, D.C. 20361-1014	1
6. Commanding Officer..... Unmanned Aerial Vehicles Joint Project Office Naval Air Systems Command ATTN: Mr. David Lewis PDA-14UD Washington, D.C. 20361-1014	1
7. Mr. William C. Lindsay..... WRDC/FIGL Wright-Patterson AFB, OH 45433	1

8. Prof. Rick Howard.....5
Department of Aeronautics and Astronautics Code 67Ho
Naval Postgraduate School
Monterey, CA 93943-5000

9. LCDR Jeff Ellwood.....2
520 O'Block Avenue
Pittsburgh, PA 15239