

# Think:Act

navigating complexity

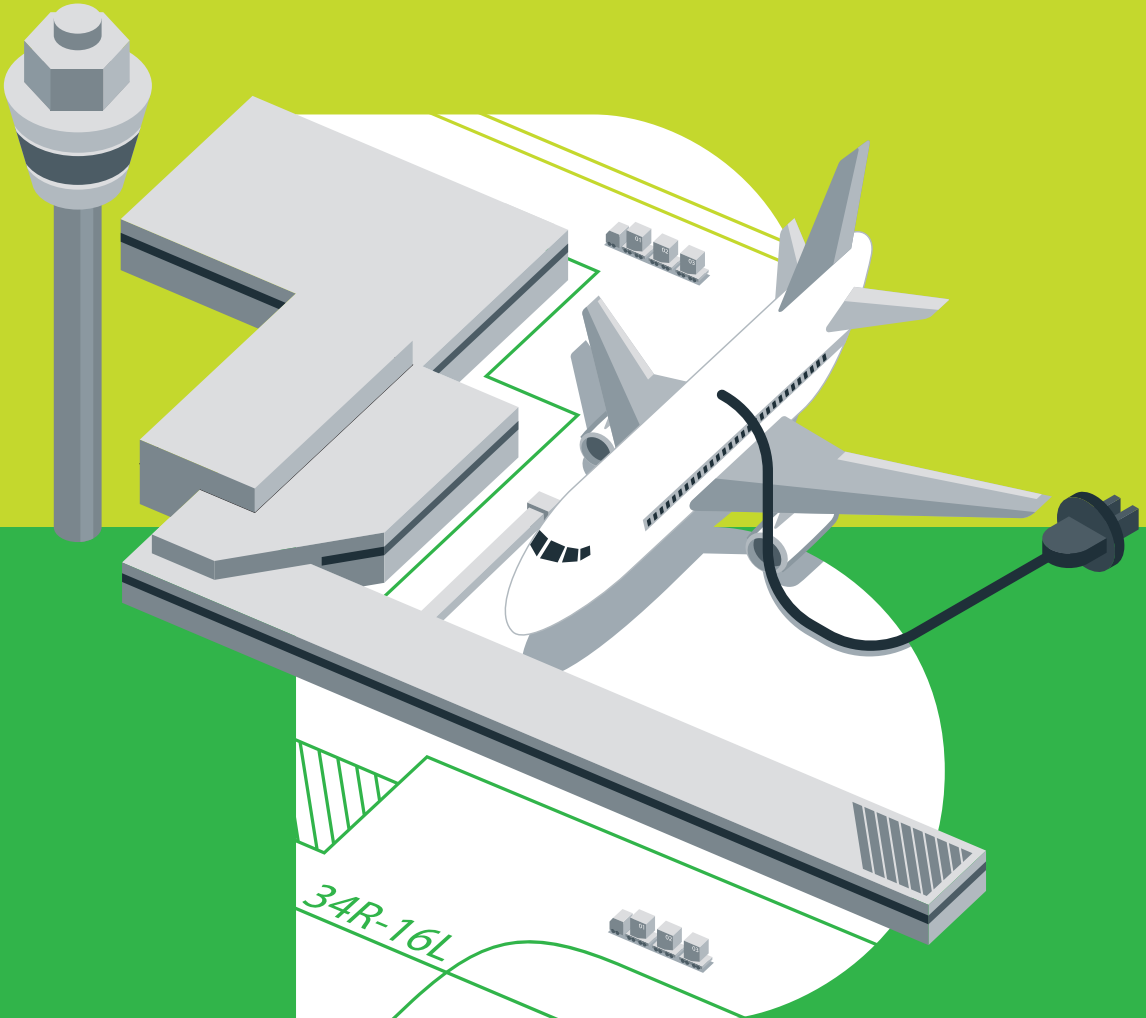

September 2017

## Aircraft Electrical Propulsion – The Next Chapter of Aviation?

It is not a question of if, but when



navigating  
complexity

## THE BIG

# 3

## 1883

is the year the first electrically propelled aircraft was prototyped (a battery-powered airship).

Page 4

## C. 70

electrically-propelled aircraft development programmes were analysed by Roland Berger for this study.

Page 11

## 500 WH/KG

is the minimum gravimetric storage capacity of batteries required for electrical propulsion.

Page 16

# All indications suggest that we may be on the cusp of a revolution in the aerospace and aviation industries.

There have been consistent upward trends in the electrification of aircraft systems, research into Electrical Propulsion, and fundamentally, a greater investment of money and business effort into electric aircraft. Electrification not only offers the capability to reduce emissions, but could also unlock the potential for more energy-efficient aircraft and brand new architectures and use cases. Electrification could also revolutionise the supply base in the aerospace industry, posing an existential threat to incumbent suppliers and facilitating access for new entrants.

In this Think:Act, Roland Berger evaluates the landscape and possible applications of electric aircraft, as well as the many technological and regulatory barriers that need to be overcome before any significant change can occur.

We begin by discussing the history of electric aircraft and the two concurrent technological trends of the More Electric Aircraft and Electrical Propulsion.

We then characterise and evaluate the current landscape of research efforts in Electrical Propulsion, considering developments in General Aviation (GA)/Recreational Aircraft, Urban Air Taxis, Regional/Business Aircraft, and Large Commercial Aircraft.

The barriers – technological, regulatory and market-based – faced by electric aircraft, are then laid out as well as the advances required to pave the way to an electric future.

Potential technological and regulatory changes are then packaged into four scenarios to map the possible future of electric aircraft, and their implications on the overarching aerospace and aviation industries.

Finally, we evaluate what various players in the aerospace & aviation industry should do to adapt to and capitalise on the trend.

# The history of aircraft electrification.

Before the Wright Brothers' Kitty Hawk first flew, the first electrically powered aircraft had already been prototyped. The French chemist and aviator Tissandier – known for his daring meteorological expeditions aboard airships – attached a Siemens electric motor to a dirigible to power its propeller, achieving a first flight in 1883.

The rise of the internal combustion engine and the subsequent invention of the gas turbine quickly moved aviation to these sources of rotative power, fuelled by oil-derivative compounds. However, in many ways, the rise of aerospace in the 20th Century has been paralleled by a similar – if not an even faster – scale up in the electrification of all human activity.

In the aerospace industry, electrification has manifested itself in two ways: the **More Electric Aircraft (MEA)** is an evolutionary trend in which each successive generation of aircraft has typically employed more electrical equipment in place of systems that would previously have been mechanical, hydraulic or pneumatic, and **Electrical Propulsion**, a potentially revolutionary new approach which has gained much recent publicity, and which, if adopted widely, would transform large segments of the aerospace industry, affecting not only propulsion, but also aircraft systems, and leading to radically new aircraft architectures.

In the subsequent section we describe the More Electric Aircraft trend at a high level, before detailing the current state of Electrical Propulsion.

## THE MORE ELECTRIC AIRCRAFT

Since the dawn of the aircraft era, non-propulsive aircraft systems such as actuation, de-icing, and air-conditioning have been dependent on mechanical, hydraulic and pneumatic sources of power. These systems have traditionally been powered by the aircraft engines, with power extracted via a variety of mechanisms – hydraulic and

electric systems receive power via a mechanical transition through the engine gearbox, whilst pneumatic power is generated by engine compressor air bleed systems. In all cases almost all the power generated by the engine is used for thrust, with the non-propulsive systems consuming only c. 5% of the engine's total output. → [A](#)

As modern aircraft evolved, achieving tremendous increases in range, speed and capacity, the complexity of their systems increased accordingly. Whilst hydraulics are robust and can generate large forces, these systems have often suffered from a lack of reliability and high maintenance costs. Pneumatic systems, too, have the drawbacks of low efficiency and, similar to hydraulic systems, miles of complex and heavy pipes and ducting running throughout an aircraft. Leaks in both systems are often difficult to locate and sometimes hard to trace and time-consuming to repair. Any interruption in normal operation may ground the aircraft until the issues are resolved, generating cost and inconvenience for operators and passengers alike.

On the other hand, well-designed electrically powered systems do not suffer from many of the shortcomings inherent in hydraulic, pneumatic and mechanical systems. Electrical systems are relatively flexible and light, and have higher efficiency. Whilst in the 1940s the Boeing B-29 Superfortress had relatively high levels of electrification, including landing gear actuation, the use of electrical systems for non-propulsive commercial aircraft power did not fully emerge until 1967. This was the time of the first Boeing 737 flight, which introduced electrical cabin equipment and avionics; around this period this approach was transformed into a concept now popularly known as the More Electric Aircraft (MEA).

Another key milestone in the trend to move towards the MEA was the introduction of the "Fly by Wire" (FBW) system in the Airbus A320 in the late 1980s, soon followed

by the Boeing 777 in 1994. This technology significantly reduced weight and provided additional space for other aircraft components by enabling the electrical transmission of instructions from the cockpit to the flight control surfaces, eliminating the need for mechanical linkages.

The next big step came with the A380 and the implementation of an electrically actuated thrust reverser, along with hybrid electro-hydraulic actuation systems for wing and tail flight control surfaces. Finally, the 787 was the first Large Commercial Aircraft to have an electrically-powered environmental control (air-conditioning) system, and to employ electrically actuated brakes, as well as electrical de-icing. Furthermore, although the 787 has a relatively conventional hydraulic system, the pressure within the system is generated by electrically-powered hydraulic pumps. In the military sphere the F-35 Joint Strike Fighter (JSF)

employs a fully hybrid electro-hydraulic actuation system, a high voltage direct current electrical distribution system that minimises weight, and has significantly higher electrical power generation capacity than previous generations of fast jets in order to power the aircraft sensors and other systems. → **B**

The electrical generating capacity of each successive generation of aircraft has increased, with the Boeing 787 and Lockheed Martin F-35 representing significant step changes. Another trend has been the switch from constant frequency generation derived from a constant speed gearbox and generator, to variable frequency generation with power electronics to convert the electrical output to the various frequencies and voltages required by different types of electrical equipment. → **C**

# A

## ENGINE POWER OUTPUT FOR A330-SIZED AIRCRAFT [MW]

With Electrical Propulsion, the thrust equivalent to that of the engine would be provided electrically – a c. 25 times step up in power.

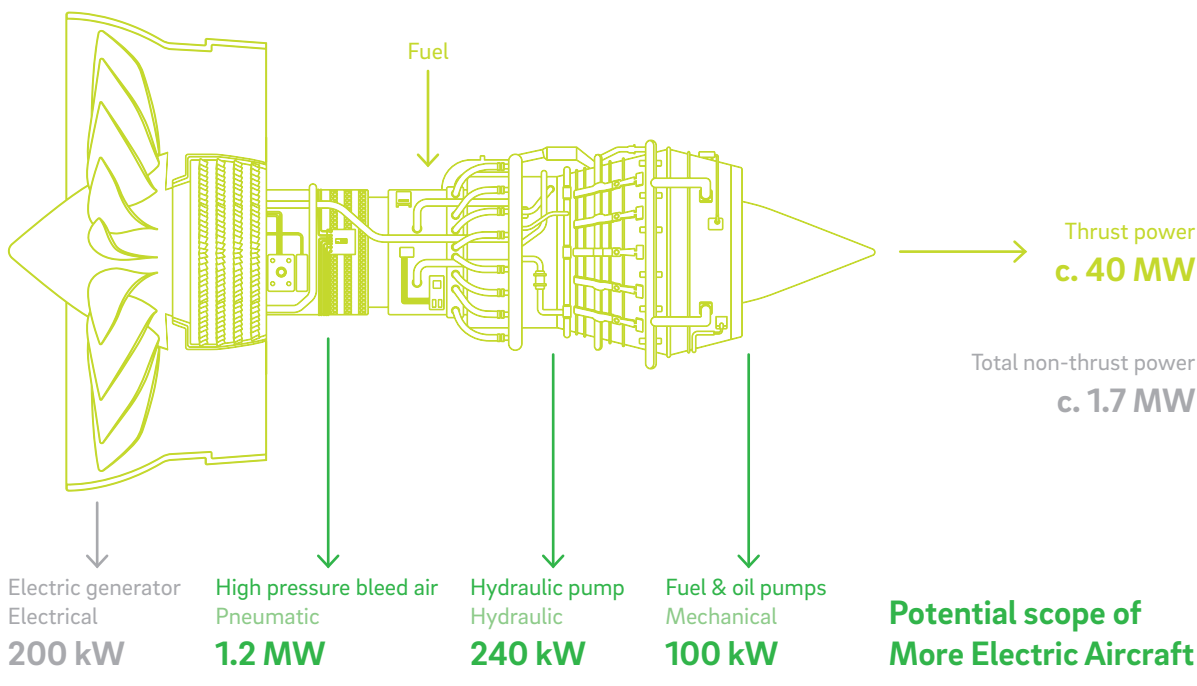

The A380 uses a combination of electro-hydrostatic actuators (EHA), in which electrical power generates local hydraulic pressure to power an actuator, and electrical back-up hydraulic actuators (EBHA)<sup>1</sup>.

Despite these advances, electrical systems do come with the drawbacks of requiring advances in power electronics to handle the ever-increasing loads, and the need to dissipate, or put to use, excess heat created by losses within the electrical power chain. However, as a result of the advantages of increasing electrification in terms of reduced weight, greater reliability, lower maintenance costs and increased efficiency, we expect to see a continuation or

even acceleration of the MEA trend as long as the current higher costs of some electrical systems can be restrained. As safety in aviation is of paramount importance, we expect the changes to be evolutionary, implemented through step-by-step adoption of electrically-powered equipment in additional aircraft systems.

**ELECTRICAL PROPULSION**

Compared to the evolutionary MEA trend, Electrical Propulsion represents a radical change from today's propulsion technologies, although Electrical Propulsion is not without historical precedent.

In the summer of 1884, the year after Tissandier's experimental dirigible flight, the battery-powered La France made its maiden flight. La France, built by Arthur Krebs and Charles Renard, both military officers in the French Army, was the first fully-controlled airship which was able to return to its starting point in good weather conditions.

Whilst many other inventors have tried to use electrical power in aircraft since the first flights, the next major milestone was only achieved in 1973, when the NiCad-battery powered HB ME-1, the first fixed wing manned electrically-propelled aircraft, made its first flight. The next remarkable step was achieved in 1979,

<sup>1</sup> Conventional hydraulic servo-control actuators are also used

**B**

**PENETRATION OF ELECTRICAL SYSTEMS BY AIRCRAFT TYPE**

Many aircraft now employ electric systems, and/or a mix of hydraulic and electric systems.

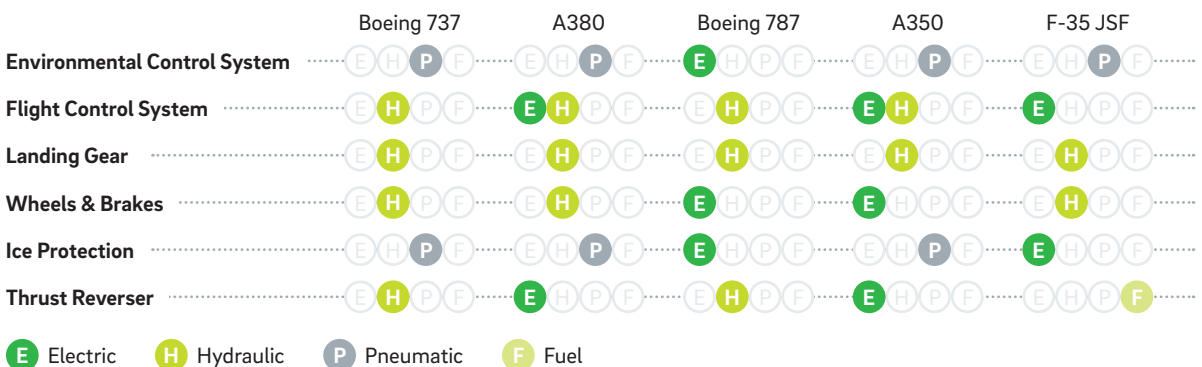

C

# INCREASING ELECTRICAL POWER IN FIGHTERS MATCHES CIVIL AVIATION

Electrical power generating capacity<sup>1)</sup> by introduction year [kVA]

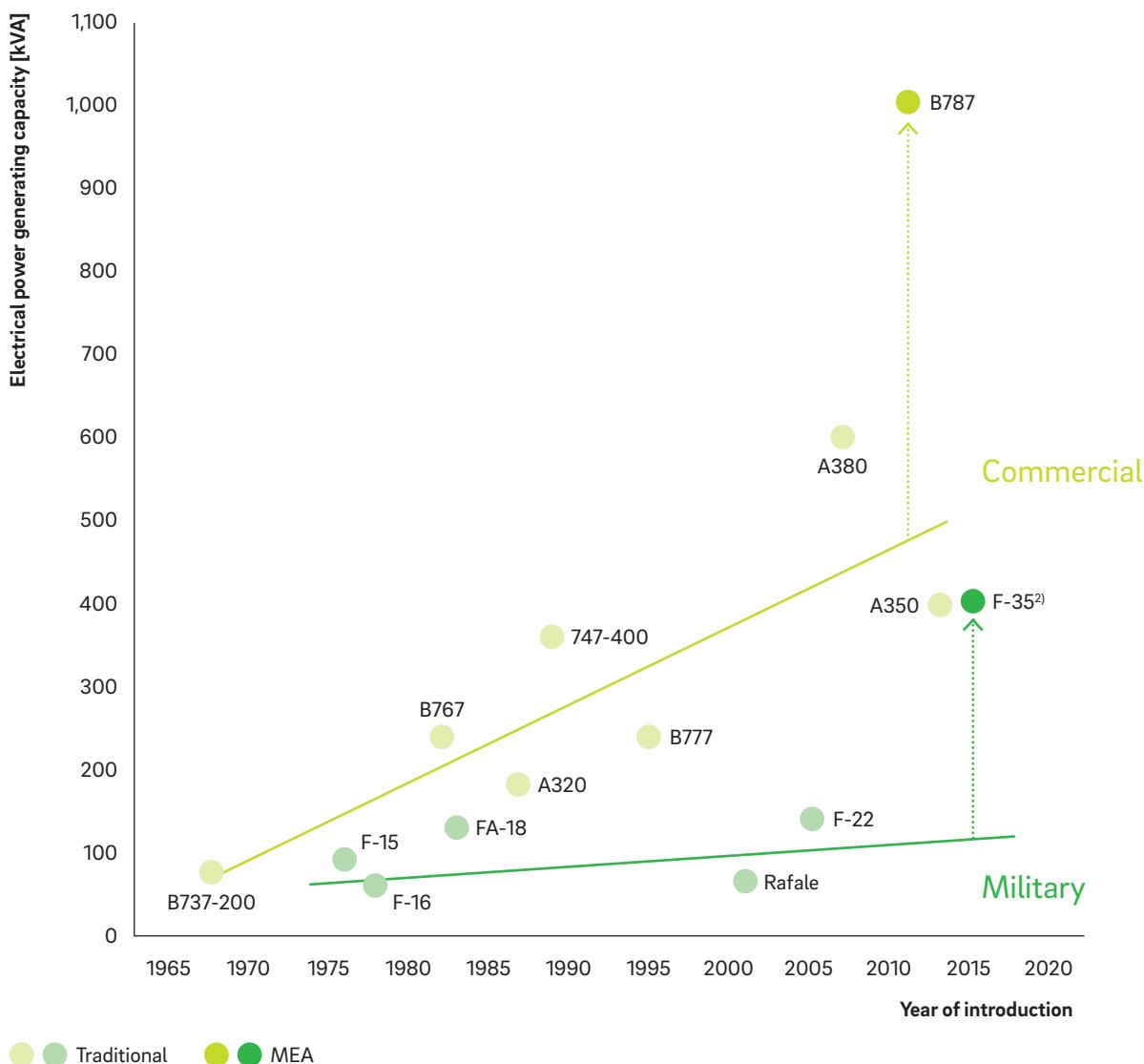

1 Excludes APU generation capacity; 2 F-35 capacity was originally 160 kVA but has increased to 400 kVA to accommodate increasing electrification of loads  
 Source: Press research, Roland Berger

## 8 Think:Act

### Aircraft Electrical Propulsion

when the Mauro Solar Riser, the first manned solar-powered aircraft, took to the air for the first time. In the same year, Bryan Allan successfully crossed the Channel between England and France with the solar-powered Gossamer Albatross.

Since then many electrically powered aircraft have been built, including NASA's solar driven UAVs, the battery-powered Alisport Silent Club and Lange Antares gliders, and development programmes like the Airbus/Siemens E-Fan X. These have been either prototypes, used as demonstrators, or for leisure activities, but the pace of development to date is accelerating.

Within the area of Electrical Propulsion, there are three broad aircraft architecture choices designers can make. → **D**

Hybrid-electric architectures either augment a traditional turbo-fan with an electric motor in a parallel hybrid configuration, or use a turbo-shaft and generators bolstered by a battery to feed a set of electric motor-driven fans in a series configuration. Both types continue to employ a turbo-fan for large parts of the flight envelope due to the current shortcomings of battery capacity, and draw on elec-

trical power either in high thrust parts of the flight envelope such as take-off and climb, or switch entirely to battery power during cruise, when thrust requirements are lower.

A second configuration is a turbo-electric architecture, where kinetic energy from a turbo-shaft is transformed via a generator into electrical energy to drive one (or multiple) distributed electric motor-driven fan(s). This configuration gives the aircraft designer complete freedom over the number and location of the propulsive fan(s), potentially leading to more efficient designs with higher propulsive efficiency.

The third option is all-electrical propulsion, where the sole source is a battery and the gas turbine and associated fuel system present in hybrid-electric and turbo-electric configurations are completely eliminated. Clearly the range of an aircraft with an all-electrical propulsion system will be heavily dependent on battery storage capacity and weight.

The three Electrical Propulsion architectures are similar to those already adopted by the automotive industry, and in many ways aerospace is following the path already set in the automotive sector.

## D

### ELECTRICAL PROPULSION ARCHITECTURES

There are three main architectures for Electrical Propulsion.

#### Hybrid-electric

Hybrid-electric is one of two architectures – Parallel or Series hybrid. Additional electric energy can be used for acceleration and in times of high power demand, and bi-directional flow of power is possible between the generator and battery.

#### Turbo-electric

The kinetic energy of a turbo shaft is transformed into electric energy via a generator to drive multiple, distributed fans, with the fans driven by electric motors.

#### All electric

One, or multiple, fans are driven by electric motors with energy stored in a battery.

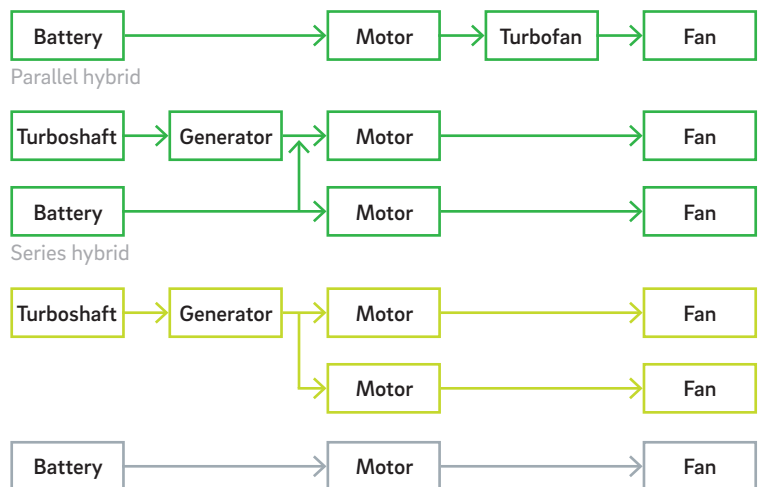



---

# A BRIEF HISTORY OF AEROSPACE "REVOLUTIONS"

Electrification of aircraft has the potential to revolutionise the aerospace and aviation industries. But this is not the first time the industry has been on the cusp of revolution. To fully understand whether the industry is likely to actually change, it is important to reflect on history and place the latest "revolutions" in the context of the constraints of real-world physics and a safety-critical industry.

## **SUPERSONIC FLIGHT**

The year 1969 saw the first flight of the Concorde and commercial supersonic travel was born, with supersonic transatlantic flights quickly becoming a regular occurrence and persisting for three decades. However, concerns around noise, high costs per seat and a deadly crash created a fundamentally poor business case; airlines and aerospace companies were reluctant to take on the large financial and engineering risks required for the development of these aircraft. As a result, commercial supersonic aviation has clearly not become the norm.

However, even before the Concorde retired from service, its potential was limited by regulation. In 1973, the FAA banned the use of commercial supersonic airliners over the contiguous United States due to noise concerns related to its sonic boom, a decision bolstered by movements like the Citizens' League Against the Sonic Boom. The issue with the regulation was not merely its existence, but that it explicitly prohibited travel at speeds greater than Mach 1, rather than setting an achievable goal (such as maximum noise level) for engineers to target. As a result, while Concorde's retirement was ultimately due to high operating costs, its business potential was heavily limited by regulation.

Strong regulation, which controls safety and performance standards, but does not stifle innovation, is thus crucial to the rise of a new technology. How regulators will deal with the new trend of Electrical Propulsion largely remains to be seen.

## **VERY LIGHT JETS**

A more recent phenomenon which captured popular imagination much like Electrical Propulsion was the

Very Light Jet (VLJ) in the early 2000s. These aircraft were initially marketed at a price of USD 1 m, considerably below the then selling price of USD 4-5 m for an entry level jet. Around 10 such programmes were launched by both established aerospace companies (including Cessna and Diamond), and by start-ups (such as Eclipse Aviation).

Despite forecasts that the skies would be darkened by fleets of VLJs, few aircraft were ever produced for four reasons: first, the optimism of the new entrants collided with the physical reality of aerospace technology; second, the idea of inexperienced owner-operators managing fast-flying fleets raised questions about the potential risks to passengers and other airspace users; third, the simple, low cost designs faltered against the rigorous, safety-driven certification processes; and fourth, new working practices imported from the software industry failed to slash development and production costs.

The Very Light Jets trend shares a number of similarities with the current spate of electrically-propelled aircraft launches, such as a new value proposition, funding from information technology investors, new entrants from outside the aerospace industry, and even a reliance on the air taxi business model (air taxi start-ups such as Dayjet, Nimbus and Pogo placed orders for large fleets of VLJs).

Nearly 15 years on, after a litany of programme cancellations and bankruptcies, only the Cessna Mustang limps on in production, although the fully-equipped purchase price of this aircraft is now around USD 3.5 m. Whether history repeats itself with electrically-propelled aircraft remains to be seen.

# The current electrically-propelled aircraft landscape.

In the following section, we lay out the current landscape of development activities in electrically-propelled aircraft. Many – if not most – of the concepts discussed below require significant technological steps to become viable. And, just as with any venture, many – if not most – of these initiatives will probably not bear fruit. However, it is clear that investors and engineers are aligned in the potential of Electrical Propulsion and teams around the world are already making strides towards further electrification.

Roland Berger has created a database of electrical-ly-propelled aircraft programmes in order to identify technological, market and competitive trends. In total, approximately 70 programmes have been launched by companies ranging from incumbent aerospace players to new start-ups – to say the least, the industry is bustling with activity. New programmes launched can be categorised into four types – General Aviation (GA)/Recreational Aircraft, Urban Air Taxis, Regional/Business Aircraft and Large Commercial Aircraft. → **E**

Our database indicates that around half of all new programmes have been launched by start-ups/independents, and 5% are backed by major non-aerospace companies. Only c. 20% are being launched by major airframe OEMs such as Boeing, Cessna and Agusta Westland – but most of the developments in this category are being conducted by Airbus. The geographical distribution of new ventures is split roughly equally between North America and Europe, reflecting the location of current production of most of the world's aircraft. Almost half are only single fan designs, with a third aiming to capture the

propulsive efficiency benefits of Electrical Propulsion through distributed fans.

The current status of development for each category of aircraft is described below.

## **GA/RECREATIONAL AIRCRAFT**

The segment of General Aviation/Recreational Aircraft has been a hotbed of development activity. The up take in this segment has been enabled by existing aircraft architectures already using propellers for propulsion, either allowing a simple substitution of the powerplant or allowing designers of new platforms to draw on a wealth of relevant past experience.

GA incumbents have released retrofitted versions of existing aircraft, such as the electric Cessna 172 and Pipistrel's Taurus Electro or WATTsUP electric trainer. Small independents and start-ups have also entered the field through this segment, such as DigiSky with the SkySpark demonstrator.

This class of aircraft has also proven to be an effective segment as a "test bed" for further development. Siemens' first solo foray into electric aircraft was in this segment with the all-electric demonstrator Extra 330LE which had its first flight in 2016. Airbus' E-Fan program also began with its Cri Cri and E-Fan 1.0-1.2 contingents in this segment. → **E**

## **URBAN AIR TAXIS**

There has been clear acceleration in the launch of development projects for 1-4 passenger Urban Air Taxis. Typical developments in this area are currently targeting a limited range of up to 50 km, with vertical take-off and

E

**ELECTRICALLY-PROPELLED AIRCRAFT DEVELOPMENT PROGRAMMES<sup>1)</sup>, BY DATE OF FIRST FLIGHT**

A large number of Electrical Propulsion developments are under way, with several first flights planned for the coming years.

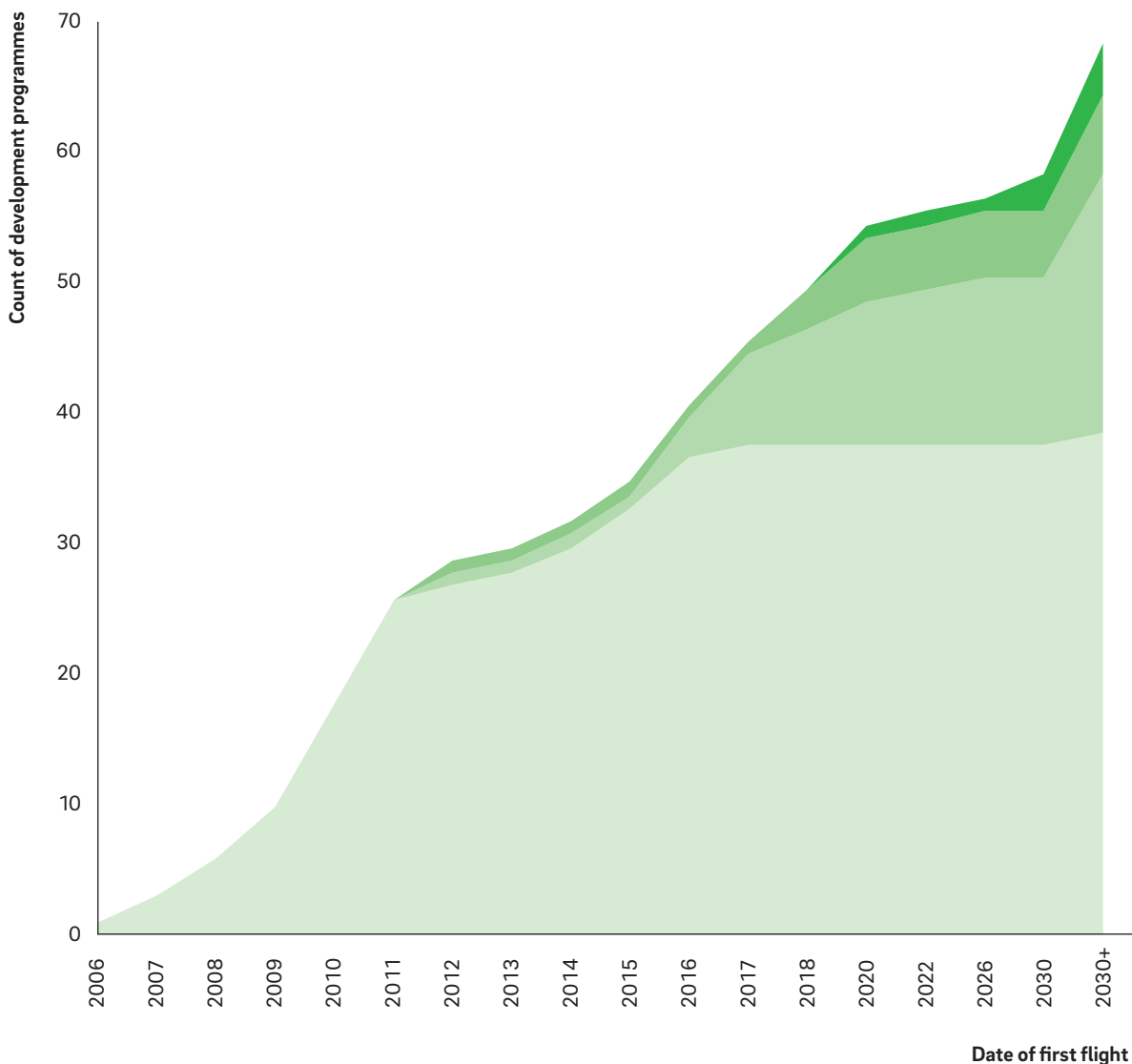

GA/Recreational    Urban Air Taxi<sup>2)</sup>    Regional/Business Aircraft    Large Commercial Aircraft

<sup>1</sup> Includes >70 programmes with first flight dates ranging from 2006-30; <sup>2</sup> Urban Air Taxi developments are 1-4 person transporters (generally VTOL) for urban environments

Source: Roland Berger

## F

## ELECTRICAL PROPULSION DEVELOPMENT PROJECTS, 2006-30+ [YEAR OF FIRST FLIGHT]

The majority of developments are undertaken by independents in traditional aerospace geographies.

### BY AIRCRAFT MAKER TYPE

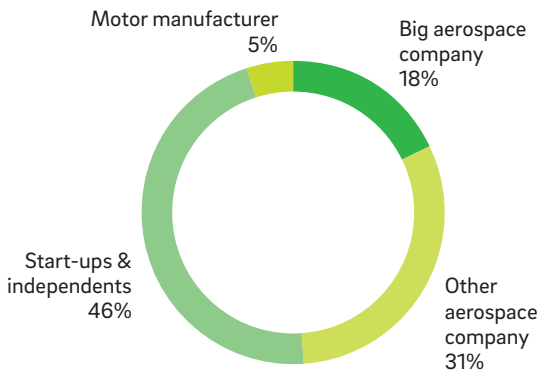

### BY MAKER ORIGIN

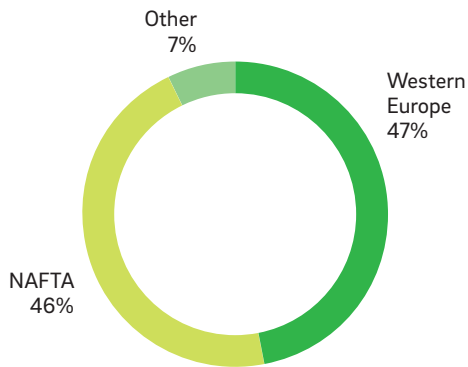

### BY PROPULSION TYPE

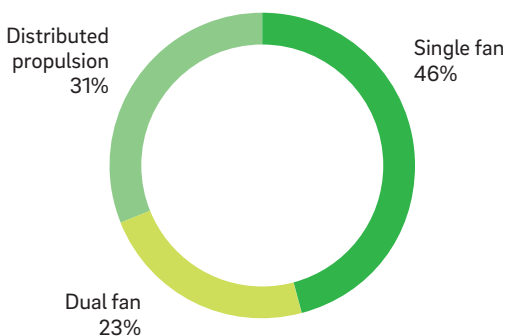

Source: Roland Berger

landing (VTOL) and all-electrical propulsion to give the benefits of low noise pollution and zero emissions.

Many of these developments have advanced and made ground-breaking progress. In Germany, the VoloCopter VC-200 flew as early as 2013. Starting in the fourth quarter of 2017, VoloCopter will be authorised as an Autonomous Air Taxi (AAT) in Dubai, having received clearance from the United Arab Emirates' Roads and Transport Authority (RTA). Lilium Aviation also performed its maiden flight in 2016 and plans a 5-seater taxi for urban mobility, and the Chinese drone company Ehang has also been cleared as of last year to start testing its Ehang 184 in Nevada, beginning its FAA regulatory approval process.

A number of other players are operating in stealth mode without much press or fanfare, but have also made noteworthy progress. Zee Aero's full-scale prototype was recently spotted in flight, while Joby Aviation's S2 is expected to start full-scale prototype testing later this year. Other projects like the DeLorean Aerospace's DR-7 continue to make progress with a VTOL flying car, due for its first flight in 2018.

A further development in these urban mobility concepts actually came from automotive companies like Geely (owner of Volvo) and mobility providers like Uber. The former has entered the aerospace industry by acquiring US-based Terrafugia, with its TF-X "flying car". The latter provided a detailed business case in its "Elevate" white paper published in October 2016, which in turn motivated additional organisations like Bell Helicopter, Mooney Aircraft and Pipistrel to partner with Uber to work on an undisclosed project. While this may just be an early spike of activity before the pace of development settles down, there certainly seems to be a willingness from corporates and investors alike to enter this field.

Aerospace incumbents, not to be undone, are also investing considerable resources into the trend. However, industry giants Airbus and Boeing are taking different approaches. Airbus has taken an holistic approach with an Urban Air Mobility portfolio, not only initiating projects within existing divisions (e.g. Airbus Helicopter and the CityAirbus, a four-seater all-electric multi-rotor VTOL aircraft for urban environments), but also identifying a need for rapidity in development with the creation of a dedicated new organisation, A<sup>3</sup> ("A cubed"), a Silicon Valley-based outpost that is overseeing the development of Vahana, a single-seat autonomous electrically-propelled aircraft which is expected

to carry out its first full-scale demonstration flight by the end of 2017. Concurrently Airbus remains on the lookout for potential investments in start-ups through Airbus Ventures. Boeing, on the other hand, has chosen a largely opportunistic approach by dedicating its venture capital arm HorizonX to finding promising start-ups to invest in, often along with partners, including the Zunum regional aircraft programme.

### REGIONAL/BUSINESS AIRCRAFT

In the next size category up are Regional and Business Aircraft with a range between 500-1,000 km that are targeting both commercial inter-city transport and business/general aviation use by corporations and high net worth individuals. Developments in this segment are evaluating both hybrid- and all-electrical propulsion and have a business case related not only to the replacement of current non-electric aircraft, but also to competing with road- or rail-based transportation, drawing on the benefits of Electrical Propulsion in terms of reduced noise and zero emissions.

New ventures launched in this segment include Eviation's Alice project, a nine passenger all-electric commuter and business aircraft planned to first fly in late 2018, whilst others appear a little further behind in development such as XTI Aviation's TriFan 600 (a six-seat hybrid-electric VTOL business aircraft) and an initial product from Zunum Aero, which is developing commercial aviation platforms of three different sizes, with the smallest and first-to-market variant being a 10-seater regional aircraft.

Regional/Business Aircraft are also being considered by some companies as test beds, subsequently to be scaled up to larger platforms. Existing aerospace and aviation companies are thus also active in this segment. Boeing, for example, has recently partnered with JetBlue to co-invest in the aforementioned Zunum Aero, which plans to eventually scale up its regional development to a 50-seater platform.

### LARGE COMMERCIAL AIRCRAFT

The well-documented barriers to entry in the Large Commercial Aircraft (LCA) segment mean that most of the development activity in electrically-propelled LCAs has focused on the incumbents, Airbus and Boeing.

Airbus has already gone so far as to release a roadmap to the first electric Large Commercial Aircraft – though without a predicted entry into service date – in pursuit of

the company's long-term goal of developing a single aisle aircraft with a hybrid-electric configuration. This size of aircraft would require around 40 MW of power for take-off and 20 MW for cruise, in support of which Airbus is developing a demonstrator aircraft called the E-Fan X in the 2 MW class that is scheduled to fly within the next 3 years. In parallel, Boeing has also released a roadmap to an electrically-propelled aircraft by around 2030, building on the achievements of the More Electric 787 and demonstrating the way in which the More Electric Aircraft technology described earlier is complementary to, and paves the way towards, Electrical Propulsion. → **G**

In a challenge to the incumbents, Wright Electric, a new start-up staffed by a team previously funded by NASA, has a goal that all short-haul flights should be electrically-powered within the next 20 years. In support of this goal, Wright Electric has announced its intention to build a 150-seat electrically-propelled aircraft within a decade to compete with the smaller members of the A320 and 737 families. The company is taking an opportunistic approach to exactly which technologies will be employed, indicating that if battery technology advances with sufficient speed then the aircraft will be all-electric, whilst if progress on batteries is slower, then a hybrid-electric approach will be adopted instead. These technical barriers to Electrical Propulsion are explored in more detail in the next section.

G

# AIRBUS, BOEING AND START-UPS ARE DEVELOPING ELECTRICAL PROPULSION FOR LARGE COMMERCIAL AIRCRAFT

Evolution of electrical power generating capacity by technology



1 Roland Berger estimate

Source: Airbus, Boeing, Roland Berger

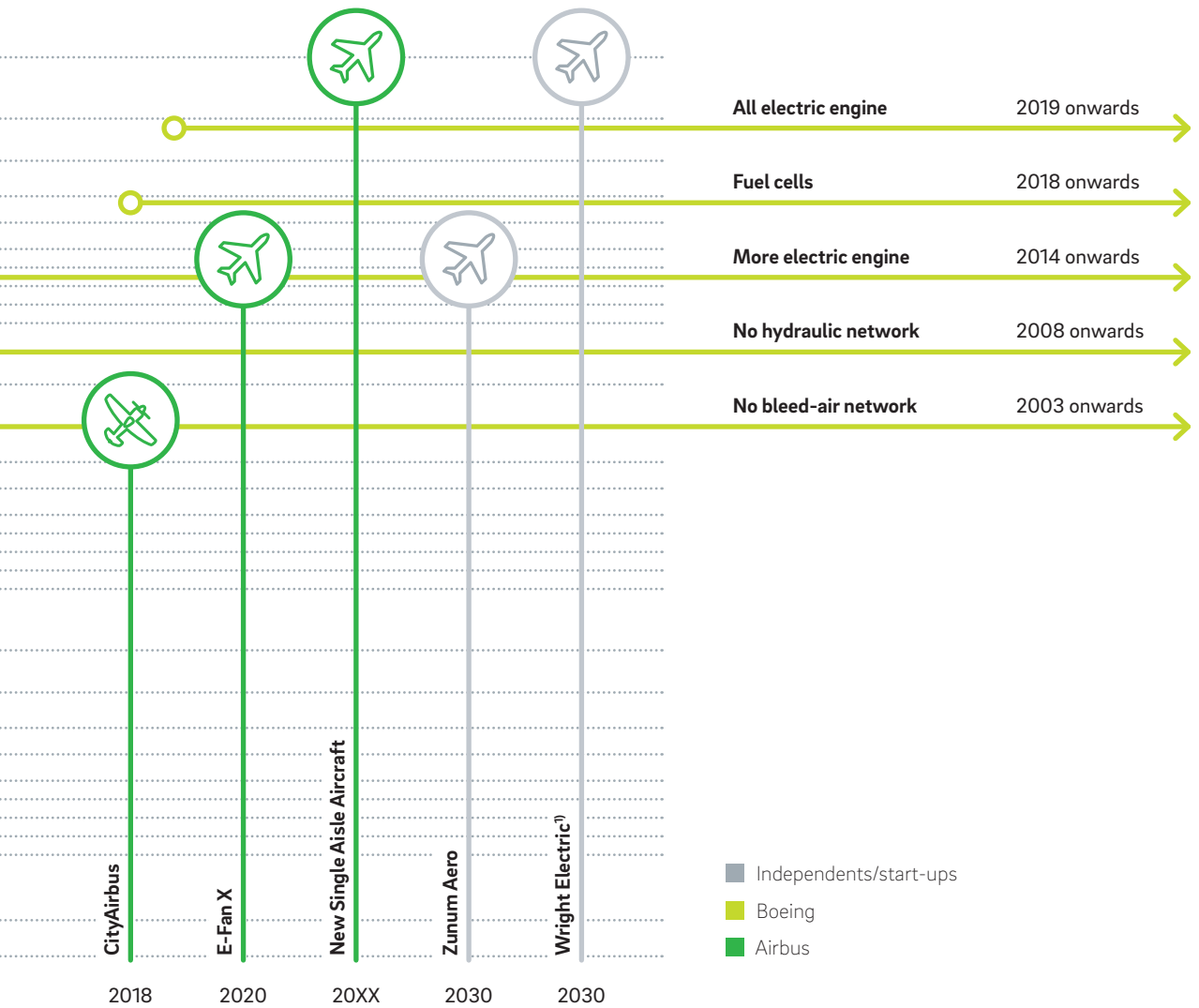

# The barriers to Electrical Propulsion.

Despite the clear enthusiasm for electrically-propelled aircraft demonstrated by the plethora of new development programmes launched, a significant number of barriers remain, spanning market demand, technology, and regulation. In this section we describe some of the barriers that Electrical Propulsion will have to overcome.

## MARKET DEMAND

The first and foremost barrier for applications such as Urban Air Taxis is that of demonstrating whether there is market demand at a price that generates an acceptable return on investment to cover development and operating costs. In many ways the arguments in favour of Urban Air Taxis are reminiscent of those put forward in favour of air taxi companies operating Very Light Jets (see "A brief history of aerospace innovations"). Roland Berger's research from that period demonstrated that the most economical way to satisfy demand for air taxi services would be with a 30 year old piston-engined aircraft that would be very cheap to operate, relatively quiet, have a short take-off run, be capable of operating from secondary airports close to city centres, and only require a single pilot; since such air taxi services do not currently exist, the proposed Urban Air Taxis will have to demonstrate considerable utility over and above zero emissions in order to be viable. Furthermore, Urban Air Taxi programmes will need to break the traditional aerospace cycle of development cost over-runs and schedule delays – but perhaps this is just where the injection of outside experience and flexibility will overcome the traditional aerospace *modus operandi*.

Similar challenges will also exist in the regional aircraft segment. Although the 40-50 seat regional aircraft market was buoyant in the late 1990s and early 2000s, recently airlines have switched to buying larger regional aircraft in the 70-90 seat category owing to the high per-

seat cost of smaller aircraft. As many of the initial set of electrically-propelled regional aircraft appear to be targeted at the moribund smaller end of the regional aircraft market, the manufacturers will have to convince the airlines of the value proposition these new products will offer. Furthermore, regional jets typically fly 6-8 sectors per day, so any all-electric regional aircraft will need either very rapid re-charging capability, or the ability to exchange depleted batteries for freshly-charged batteries within the time of the aircraft's turnaround at the gate.

## TECHNOLOGY

The technical barriers to currently envisaged electrically-propelled aircraft can be grouped into two types: those that relate directly to the electrical system, and those that are linked to the planned applications of the aircraft under development. We discuss the former first, and then touch upon the latter.

## BATTERY PERFORMANCE

High battery storage capacity and low weight are clearly crucial to all-electric and hybrid-electric architectures, and in order to begin to allow the creation of products with commercially viable payload-range characteristics, it is generally accepted that electrical storage systems need an energy density of at least 500 Wh/kg. The highest commercial batteries today range from 150-250 Wh/kg, with Tesla's 21-70 battery having a reported energy density of 250-320 Wh/kg. Roland Berger's analysis suggests that the current trajectory of Lithium-ion battery development will bring gravimetric density to c. 400-450 Wh/kg by the mid-2020s. However, further development or new battery chemistries will need to reach the 500 Wh/kg mark, and even if batteries do reach this level, the energy storage density will still be a factor of 25 lower than the approximately 12 kWh/kg delivered by jet fuel. In addition to high



energy density, high re-charging speeds and long battery life-cycles will be crucial to underpinning the economics of battery-powered aircraft. → **H**

**BATTERY SAFETY/HAZARD CONTAINMENT**

With the Boeing 787 Lithium-ion battery failure still in recent memory, electric aircraft developers will need to develop effective hazard containment systems for batteries – not only to meet airworthiness requirements, but also to satisfy public safety concerns. Whilst hazard containment systems for batteries are arguably less challenging than for volatile aviation fuel, the need for such systems are often overlooked in the race for higher energy densities.

**LIGHT, EFFICIENT, HIGH POWER DENSITY GENERATORS AND MOTORS**

Hybrid-electric, turbo-electric and all-electric aircraft will all require light, efficient and high power density motors to fit in with the weight and size constraints of an aircraft, particularly for configurations that employ multiple distributed fans to achieve high propulsive efficiency. Hybrid-electric and turbo-electric architectures will also require light, efficient and high power density generators to convert shaft power to electricity, along with an intermediate, lightweight gearbox to reduce the turbine's high

Despite the losses in converting the energy contained in jet fuel into useful thrust, the energy density advantage of jet fuel remains a factor of 6-8 times higher than the 500 Wh/kg batteries.

rotational speed to a slower rate suitable for a generator. For generators alone, the power output requirements will be around a factor of 40 higher in an all-electric Large Commercial Aircraft than in the world's most electric aircraft, the 787, which generates 1 MW electrical power from four 250 kW engine-mounted generators, along with c. 40 MW of thrust power.

**H**

**ROADMAP FOR LITHIUM-ION BATTERY TECHNOLOGY [WH/KG]**

Projected automotive roadmaps indicate batteries will only reach the 500 Wh/kg level required for aerospace after 2025.

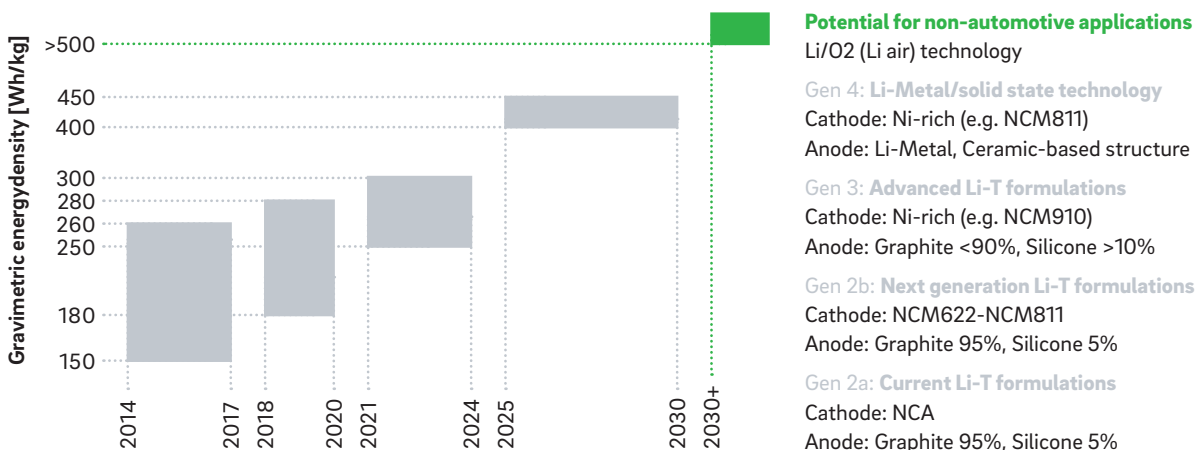

Source: Roland Berger

---

## ANALOGIES WITH THE AUTOMOTIVE INDUSTRY

Over the past 5 years the automotive industry has been undergoing rapid change driven by electrification and digitalisation, leading to the entrance of new players and pushing incumbents rapidly to revise their strategies. Alongside accelerating electrification, automated driving and new mobility business models are transforming the industry.

The automotive industry has been an ideal environment for the development of new electrification technologies encompassing the powertrain, batteries and electronics. Short product development cycles facilitate both faster feedback and iterative/spiral development, while the sheer market size creates economies of scale in R&D (the total value of sales of passenger cars and light commercial vehicles is an order of magnitude larger than sales of civil aircraft). At the same time, regulation in the form of Corporate Average Fuel Emission (CAFE) targets, coupled with specific restrictions in certain areas (e.g. the CARB ZEV regulation, and the banning of diesels manufactured before the year 2000 in Paris), has increased pressure on manufacturers to develop electrically-propelled cars. Finally, some environmentally-conscious consumers have demonstrated their willingness to purchase electric or hybrid cars, despite higher prices than conventional vehicles.

As a result of these mutually reinforcing effects, the adoption of vehicles with all-electric and hybrid-electrical propulsion is accelerating. Forecast adoption is now at the upper end of the 10 year scenarios developed by Roland Berger's Automotive Competence Centre only three years ago – we now expect that over a quarter of new light vehicles will be either all-electric (i.e. battery) or hybrids by 2025. Plug-in hybrid and Battery Electric Vehicles have now reached mass production and soon all the major automotive OEMs will be producing vehicles of these types. Growth in the supply of electrical vehicles is driving research into increasing the performance and reducing the costs of batteries, and developing technologies that may be applicable to the aerospace industry.

Automated driving has been advancing rapidly in parallel with increasing electrification. Although not yet perfected, automated driving is stimulating research into sensors and investment in software control systems. Active safety-critical systems are now commonplace in advanced cars, and significant progress has been made in the way complex systems are developed, risks are identified and mitigated, and redundancy is managed. Tesla, the automotive industry's most well-known new entrant, is at the forefront of these changes, although other new entrants such as Alphabet, Samsung and Uber are also investing heavily.

The combination of electrification and automation is enabling new mobility concepts, such as "robocabs", wholly autonomous, electrically-propelled vehicles that will be sold to fleet operators, operating around the clock in urban environments, and charging around a quarter of the price of traditional taxis. Widespread adoption of robocabs would see new approaches to traffic system management, as well as the replacement of the current fuel network with a system of charging stations. Ultimately, future Urban Air Taxis could share charging infrastructure and build on the approaches developed for ground traffic management, facilitating the introduction of Urban Air Taxis.

Despite similarities, the automotive industry also has some important differences to aerospace: although low weight is important for automotives, it is absolutely critical in aerospace; although concerns over running out of battery charge generate "range anxiety" for car owners, the risk of running out of battery charge is life-threatening for air passengers; and although the automotive industry is regulated strictly to ensure product safety, regulation is even more stringent in aerospace.

## Global light vehicle production [m vehicles]



## POWER ELECTRONICS

In addition to generating quantities of power an order of magnitude larger than current aircraft, electrically-propelled aircraft will need the power electronics to convert, switch and condition this power. As well as performing these functions with minimum electrical loss, the requisite power electronics will also need to operate with the minimum associated heat generation. This factor is particularly important given the multi-MW electrical power systems that will be required for regional and larger commercial aircraft and the resulting need to dump any surplus heat generated. Conventional aircraft can currently use fuel as a reservoir to dump surplus heat, but this option will not be available in electrically-propelled aircraft.

## SAFE AND LIGHT HIGH VOLTAGE DISTRIBUTION

Transmitting large quantities of electrical power around an aircraft (e.g. from batteries or generators to motors providing propulsion) will ideally be done

at high voltages in order to minimise resistive losses; however, transmitting high power at high voltage will inevitably lead to the risk of insulation breakdown and arcing given the limitations imposed by Paschen's Law. At the same time, long cable runs in configurations employing multiple propulsive fans distributed around the aircraft will add further weight, compounding the additional weight already required for on-board batteries.

Two alternative perspectives help to understand the gap between current technology and what will be required for Electrical Propulsion. First, the cumulative effect of inefficiencies in the electrical power chain suggest that over 10% of power would be lost in the generator, power electronics (rectifier, circuit protection and inverter), cabling and motor. At this level of loss, a hybrid-electric architecture is considerably less efficient than a conventional high bypass ratio turbo-fan engine, so fuel-burn on a hybrid-electric aircraft would, *ceteris paribus*, be worse. →!

## EFFICIENCY LOSSES IN THE ELECTRICAL POWER CHAIN FOR HYBRID-ELECTRIC APPLICATIONS

Current electrical power chain inefficiencies remain, so hybrid-electric is unviable except in niche applications.

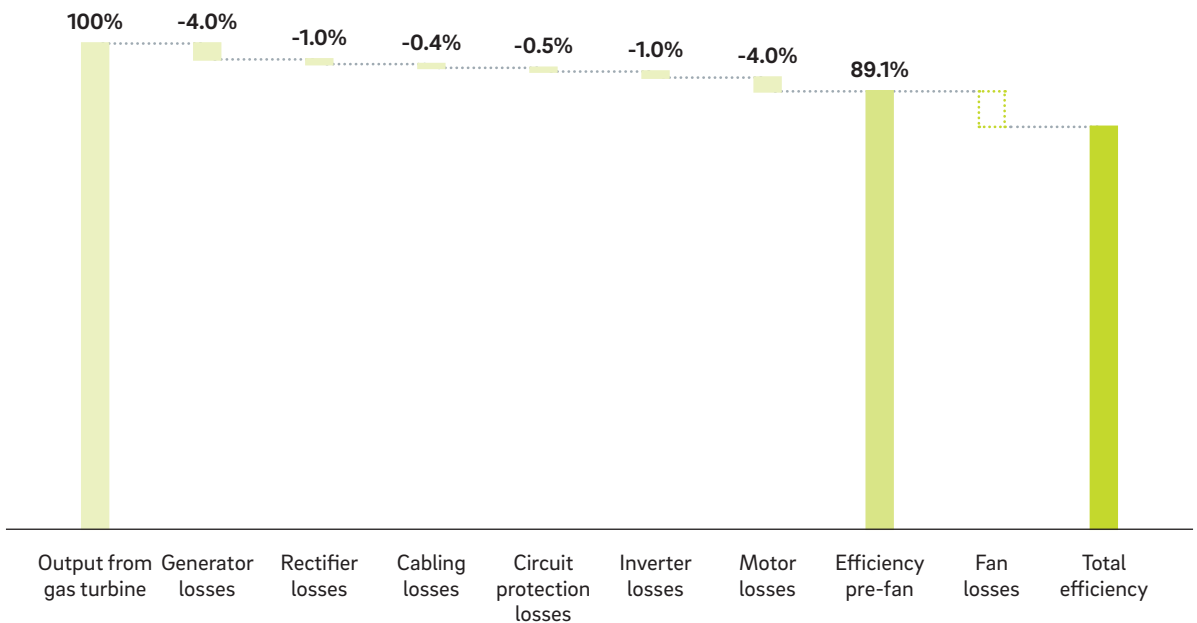

An alternative way of looking at the limitations of current technology is to consider replacing the engines on an existing aircraft with an all Electrical Propulsion system, and seeing what characteristics that system would need to have in order to generate a comparable level of aircraft performance. For example, replacing the existing turbo-prop engines on a Dornier 328 regional aircraft with electric motors and batteries of 180 Wh/kg capacity would reduce the range from 1,200 km to just over 200 km. → J

In order to restore the range to the baseline figure of 1,200 km, the following changes would also be required:

- Drag coefficient reduction of **20%** through aerodynamics
- Increase in wing span of **50%** to reduce induced drag
- Reduction in structural mass of **20%**
- Increase in battery capacity to **500 Wh/kg**

In addition to the technical barriers directly related to the electrical system, two other technical barriers related to proposed applications also need to be overcome:

### AUTONOMOUS FLIGHT

Many of the proposed Urban Air Taxis rely on automated, autonomous aircraft that operate with no human intervention from the occupants. While highly capable autopilot systems already exists in many platforms, these currently remain largely limited to applications without passengers, or operate with pilot supervision. Further developments in autonomous flight – enabled by improved sensor technology (both more capable and higher numbers of sensors) and better autonomous flight software – will be required in the age of commuter air taxis.

### BOUNDARY LAYER INGESTION

One of the potential improvements offered by Electrical Propulsion is the benefit of boundary layer ingestion.

## J

### RANGE OF DORNIER 328 AIRCRAFT UNDER DIFFERENT CONFIGURATIONS [KM]

Current battery technology for an all-electric aircraft in today's configurations would result in a drastic fall in range.

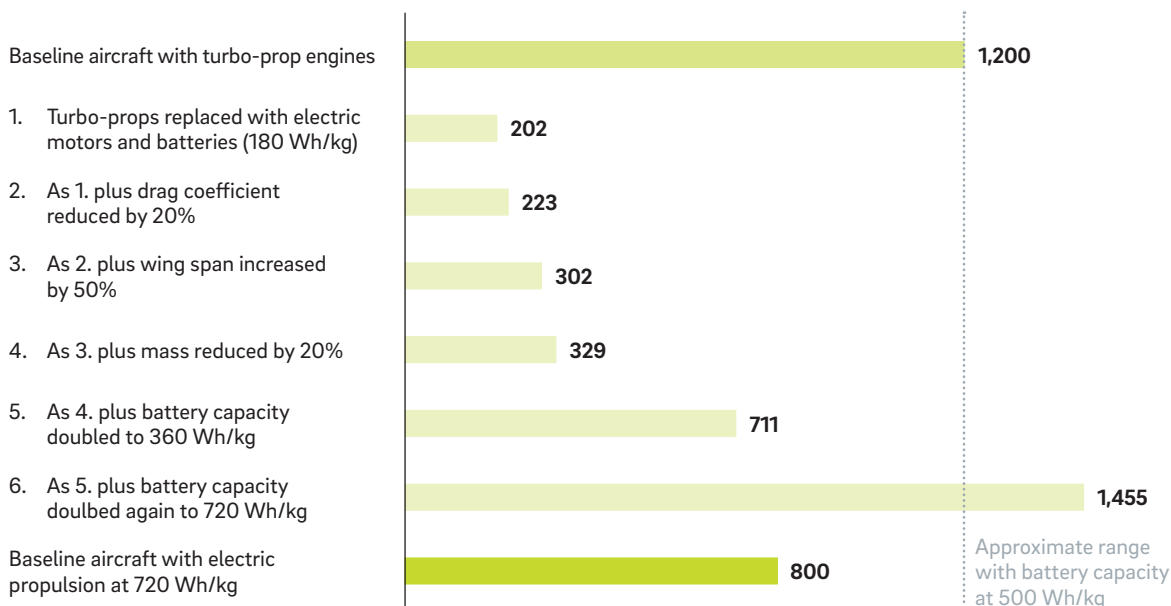

Many of the Regional and Large Commercial Aircraft electric architectures proposed use aft-mounted propulsion systems, positioned such that air coming off the aircraft fuselage (45% or more of which is slower and more turbulent boundary layer air) is "ingested" into the propulsion system. Despite the relatively slower speed of the ingested air, electric fans would suffer from less efficiency loss in the more disturbed air compared to the fan of a conventional turbofan, whilst also benefitting from fewer installation constraints.

## **REGULATION**

To enable the potential of Electrical Propulsion aviation, there will need to be effective new regulations for new technologies, new platforms and new aviation systems.

First, as new technologies are developed in the field of electric aviation, each technology will need to have regulatory backing to be applied. For example, regulation will play a part in verifying and certifying the use of More Electric Aircraft systems, and any progression with Electrical Propulsion will require airworthiness certification, as well as broad regulatory acceptance for enabling technologies such as high-powered batteries, high voltage distribution, and boundary layer ingestion.

Second, regulation will be critical to enable new platforms. Regulation and certification procedures for new architectures such as distributed fans will be required to allow the full potential of Electrical Propulsion to be realised.

Third, if and when technologies and platforms progress to enable Urban Air Taxis, far-reaching regulatory changes would be required to enable entirely new aviation systems, such as for the regulation and control of urban commuter air transportation systems, as well as integration with other urban infrastructure (e.g. electricity grid, buildings, roads and automotive infrastructure) and corresponding regulatory regimes.

At the heart of regulation are the issues of safety and reliability. In an age of increasingly significant cyber-security concerns, the introduction of autonomous flight systems and the potential of urban commuter air transport become even more challenging with the possibility of vulnerable software and systems. Engineers, investors and regulators alike must address two main safety issues. First, air traffic control infrastructure and airspace management will become of paramount importance, necessitating the management of an increasing number of UAVs (especially private drones), and the

management of potential urban commuter air transports, requiring control of an entirely new airspace, coupled with integration into existing air traffic control systems. Second, governments, regulators and private companies alike will have to invest in measures to prevent cyber-security breaches in increasingly software-driven aircraft, for all platform types.

In recent months, both the FAA and EASA have taken meaningful steps to open the doors to Electrical Propulsion. A key change is in FAA Part 23 and EASA CS23: coming into effect in 2017, larger classes of general aviation aircraft will be able to fly non-traditional engine types legally, including electric engines. This not only opens revenue potential for developers in general aviation, but this category of platform is a key stepping stone to even larger architectures. There is, however, a long journey ahead and regulation must keep pace with technological evolution for electric aircraft to realise their potential.

# Future scenarios for aircraft electrification.

Strong technological, regulatory and market demand-based barriers must be overcome in order to enable aircraft electrification. This section focuses on the former two and defines potential future scenarios<sup>1)</sup>:

**Continued evolution:** in which the current trend of increased electrification of aircraft systems carries on, but a lack of major technological breakthroughs prevents further change.

**Niche application:** incremental to Scenario 1, in which technological innovation leads to some niche applications emerging for medium range transports/business jets.

**Small scale revolution:** incremental to Scenario 2, in which the right enabling technologies, regulatory changes and societal acceptance all emerge to create a boom in Urban Air Taxis.

**Large scale revolution:** incremental to Scenario 3, in which all of aerospace is revolutionised, with the innovation of all required technologies to enable at least hybrid electric Large Commercial Aircraft, and the potential for all electric Large Commercial Aircraft.

## SCENARIO 1: EVOLUTION

A continuation of today's steady trend towards More Electric Aircraft systems would be sufficient to enable this scenario. However, this trend would see an increase in electric actuation and electrically powered systems. Electric actuators, such as electric-hydrostatic actuators (EHAs), electro-mechanical actuators (EMA), etc., would see an increase in application in flight control system actuation, landing gear actuation, thrust reverser actuation, etc. Electrically powered systems would increasingly replace hydraulic or pneumatic systems in applications such as environ-

mental control and ice protection, and there would be increased use of components such as MOSFETs, diodes, power modules and hybrids to power and control pumps and air conditioning systems.

Given existing programmes, which already have high levels of electrification, no major regulatory shift would be required to further enable the uptake of electrified systems – and in multiple areas of aviation, this could still represent a substantial increase in electrification. For example, in Large Commercial Aircraft, most current platforms are hydraulically and pneumatically actuated. An increase in electrified systems would result in Tier 1 suppliers and OEMs switching parts and potentially suppliers.

An increase in electrification of aircraft systems would see the market share of EHA/EBHA/EMA suppliers increase, while hydraulic/pneumatic system shares decrease. Aerospace Tier 1s and OEMs, who are downstream in the value chain (and buy and assemble these components), would not see a significant change and are not expected to experience major changes in market share outside of the regular existing cycle of new programme launches and contracting.

The increase in the electrical power systems market would nevertheless be substantial. Roland Berger modelled multiple sub-scenarios of "more electric" platforms being introduced into the market. One such scenario considered a relatively fast, but still evolutionary, uptake in which both major OEMs introduce a new More Electric Aircraft by 2025. According to the Roland Berger model, it was found that the total installed electricity generation capacity would grow at c. 8% into 2030, compared to c. 3% without the introduction of new further electrified platforms. → **K**

<sup>1</sup> These scenarios do not model market demand, support from other important stakeholders such as investors, or specifically how the aerospace landscape may change under each case

## K

**LARGE COMMERCIAL AIRCRAFT ELECTRIC GENERATION CAPACITY UNDER RB "FAST" SCENARIO**

Total electric generation capacity will increase significantly if new More Electric Aircraft are introduced.

Electric generation capacity (2016=100)

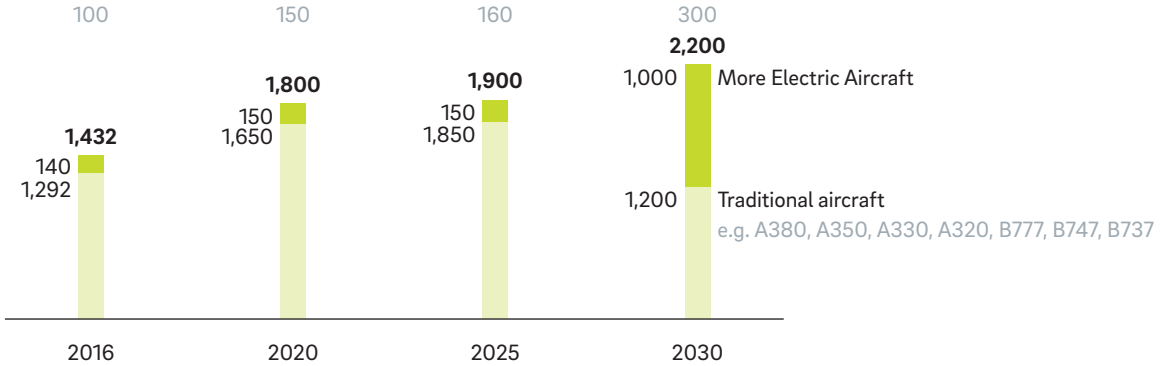

Source: Teal, Roland Berger

**SCENARIO 2: NICHE APPLICATION**

This scenario is incremental to Scenario 1 and considers the adoption of some Electrical Propulsion in niche applications. The potential for the adoption of Electrical Propulsion, in particular, is greatest where a hybrid-electric or all-electric engine offer benefits over traditional jet engine or ultra-high bypass ratio jet engine alternatives – in areas where either noise constraints mean that a UHBR engine exceeds local restrictions, installation constraints (e.g. ground clearance) restrict the size of

the fan that can be employed on a UHBR engine, and/or radical new configurations (e.g. blended wing body) offer aerodynamic improvements that counterbalance the lower propulsion system efficiency.

Several new technologies and regulatory changes would be required to enable this scenario. → [L](#)

Classes of aircraft impacted would be either all-electric or hybrid-electric, able to travel short distances (100-500 mile range) and at slow-medium speeds in an efficient manner with medium levels of battery density. Hybrid-electrical propulsion would make intermediate aircraft sizes viable, such as small-medium sized regional aircraft (up to c. 30 seats). If all-electrical propulsion becomes feasible (especially in light of the 2017 FAA/EASA regulation updates to Part 23 and CS23, respectively), light-medium sized general aviation aircraft would also become possible. In addition, an increase in efficient intercity transport would draw some traffic away from cars and train options, with regional electric aircraft holding the potential to reduce travel time at comparable costs.

**SCENARIO 3: SMALL SCALE REVOLUTION**

This scenario is incremental to Scenario 2, and would represent a sea change in how we experience urban travel, with the introduction of an entirely new platform type into service.

**The Roland Berger model considers 4 More Electric Aircraft scenarios, with new platforms being introduced into the market, with increased levels of electrification and sensing.**





Several new technologies and regulatory changes would be required to enable this scenario. In particular, regulatory acceptance would have to go far beyond the aerospace industry and cover aspects of urban infrastructure such as buildings, roads, the electric power grid, etc. Further, significant measures would be required to prevent issues around cyber-security (though this may benefit from existing efforts to enable autonomous cars), as well as systems to control and manage autonomous flight software.

Significant adoption of such technology around the world would likely be slow, with each city weighing its individual business case before opening up its skies to the innovation. Dubai, with its plan to allow the VoloCopter as a city taxi, is a trailblazer – similar moves by cities at a larger level will be required to experiment with, prove and roll out a full urban commuter air transportation system.

A true emergence of this trend would impact a number of non-core aerospace industries. Urban transportation, which currently consists largely of cars, trains and buses, could be significantly disrupted with an aerial option potentially being faster, (if electric then) cleaner, and over time potentially cheaper. Adding on to the potential upcoming shift to electric automobiles, the commercial oil industry, which draws significant business from fuel retail in and around cities, could see a further drop in revenues, as people move away from oil-based energy sources (though this sector is likely to see greater impact from the switch to electric automobiles in the nearer term). Aerospace maintenance, repair, and overhaul would have an additional segment to service, with potentially much greater volumes than existing business; further, serving this segment may need to take on a different delivery model, such as being located closer to major cities.

#### **SCENARIO 4: LARGE SCALE REVOLUTION**

This scenario represents a step change in Electrical Propulsion technology as well as large-scale adoption into service and could result in a reduction in both cost and emissions per passenger seat. Though not being strictly incremental to it, many of the technologies and regulatory changes required for Scenario 3 are subsets of those for Scenario 4.

Scenario 4 would see all technological and regulatory barriers for large commercial electric aircraft lifted. Such a change would usher in an age of electrically powered aviation, with potentially all new medium-large

sized aircraft programmes (at the Boeing 737/Airbus 320 level) adopting hybrid- or all-electrical propulsion with fully electric systems. All-electrical propulsion would likely also become widespread for all other classes of aircraft. However, due to the longevity of aircraft programmes, switching would potentially take decades (retrofit-ability is not expected due to the vastly different architectures likely required for hybrid-electric and all-electric aircraft). Three classes of aerospace industry players would have to adapt drastically.

First, OEMs such as Airbus and Boeing would be expected to pivot new programmes to hybrid- or all-electric options, with the potential for non-typical OEMs entering the business, such as Siemens which has a greater competence with large electrical systems and has already begun experimenting in the field jointly with Airbus. Airframe and systems suppliers would likely follow suit, with significant new engineering design and development contracts.

Second, the landscape of aircraft engine supply may change drastically, with the core businesses of incumbents such as General Electric, Rolls-Royce and Pratt & Whitney being under direct threat, and once again with the potential entry of newcomers into the mix. Vertically integrated approaches may also occur, with airframers taking on much of the new propulsion design directly or through existing and new joint ventures.

Finally, airports would have to adapt to a ramp down in fuel distribution and a ramp up in electrical infrastructure such as charging stations and potentially localised power stations, while maintenance, repair & overhaul processes would need to be adapted. To ensure airlines can meet airport turnaround time requirements, service providers will also have to make the crucial choice between investing in fast-charging technology versus investing in additional battery inventory (to allow battery replacements).

# The way forward for aerospace.

The strong tailwinds in the aerospace industry due to record order books, successful new product launches and re-engining programmes, and ever-increasing production rates have helped current players to grow and establish strong market positions, often reinforced by mergers and acquisitions. However, the potential shift to Electrical Propulsion poses an existential risk to incumbents that do not have solid plans for how to respond, as well as generating opportunities for new entrants.

Roland Berger has identified four types of organisation that may be impacted by, or could benefit from, both the evolutionary and disruptive scenarios of aircraft electrification – incumbent aerospace companies, new entrants, investors, and governments. There are two steps that all four types of organisation should take, after which the initial responses diverge depending on whether the organisation is a commercial or governmental entity.

## **BUSINESS CASE FOR ELECTRICAL PROPULSION**

The first step which all organisations should take is to conduct a clear-headed, dispassionate evaluation of any new electrically-propelled programme which it is considering backing. This business case evaluation needs to factor in not only the classic components of market demand, achievable market share, pricing policy, operating costs and investment requirements, but also the likely timing as to when the product will realistically enter service. In this context we would recommend a critical analysis of the Programme Management techniques being applied to any new venture (see Roland Berger's publication "Why are so many Aerospace Programmes Late and Over-budget?"), and a scoring of the proposed approach against Roland Berger's Seven Golden Rules of Aerospace Programme Management.

The business case analysis also needs to demonstrate how the innovations resulting from Electrical Propulsion transform the operating economics that are achievable with today's products; for instance, proposed air taxi business models should account for the past failure of previous air taxi ventures based on Very Light Jets, while business cases related to small, electrically-propelled regional jets should take into account that airlines have struggled to operate 40-50 seat regional jets profitably.

We do not discount the fact that some new electrically-propelled aircraft will succeed, but strongly recommend that a rigorous analysis of the business case be a pre-requisite for all organisations.

## **MONITOR PROGRESS TOWARDS OVERCOMING THE BARRIERS**

Previously, we have described some of the technical, regulatory and application-specific barriers to Electrical Propulsion. Drawing on elements of scenario planning described in Roland Berger's publication "Scenario-based Strategic Planning – Developing Strategies in an Uncertain World", we recommend that organisations monitor the key signs ("signposts") that would indicate progress towards overcoming these barriers.

The key technical barriers include: energy storage capacity per unit weight, where the figure of 500 Wh/kg is widely regarded as the minimum required for electric flight with commercially acceptable payload-range characteristics; light, efficient electrical generators and motors in the multi-MW class for aircraft of 10 seats and upwards; power electronics able to convert, condition and switch high voltage power; and autonomous flight control systems required for urban air taxis. Roland Berger, together with our technical partners, has established a clear description of best practices in each technical area, against

which we are able to judge planned (and claimed) new technical developments.

In terms of regulation, we believe that three areas should be monitored most closely.

### NOVEL AIRCRAFT ARCHITECTURE CERTIFICATION

For over 50 years commercial aircraft have consisted of gas turbine-powered tube-and-wings architecture; to reap the full benefits of Electrical Propulsion (e.g. the propulsive efficiency gains of distributed propulsion), airworthiness authorities will have to find approaches to certify novel aircraft architectures for passenger flight.

### EMISSIONS REGULATION

Drawing on the potential parallels with the automotive industry, where much of the impetus towards electrification has come from regulatory changes (e.g. Corporate Average Fuel Emission (CAFE) targets for OEMs, the banning of diesel engines in cities such as Paris from 2020, and the UK's plan to phase out internal combustion engines in all new vehicles from 2040), we believe that any moves to tighten emissions regulation further will accelerate the move towards Electrical Propulsion in aircraft.

### AIRSPACE REGULATION

The introduction of Urban Air Taxis will require the ability to operate these aircraft in complex, urban environments, almost certainly autonomously, and in conjunction with existing airspace users; given the slow progress to date in incorporating UAVs into controlled airspace, air traffic control regulations may inhibit the speed at which Urban Air Taxis can be introduced.

### COMMERCIAL ORGANISATIONS

For commercial organisations, the next step of evaluating the impact of aircraft electrification boils down to traditional challenge of good strategy, although the considerations vary between incumbent aerospace companies and new entrants and investors.

### INCUMBENTS

Existing aerospace suppliers face both the potential revolution from Electrical Propulsion and the ongoing evolutionary change brought about by the More Electric Aircraft (MEA) trend; the latter is continuously increasing electrical content and eroding demand for hydrau-

lic, pneumatic and mechanical systems, leading to the need to develop electrical systems capability that can be deployed both for MEA and for Electrical Propulsion.

### NEW ENTRANTS AND INVESTORS

These organisations need to evaluate the specific projects which they are considering backing, as well as the intrinsic attractiveness of the aerospace sector; compared to many industrial sectors, aerospace offers both higher growth (typically 1.5-1.7x GDP in the long run) and higher margins.

Roland Berger's research indicates that industries undergoing major change often afford greater opportunities for new entrants, since the capabilities developed over many years by the incumbents become devalued, and discontinuities open gaps that fast-moving new entrants can address. Often, these gaps emerge in areas that are relatively lower margin activities that incumbents are less interested in pursuing. Given the current bias of incumbents towards conventional architectures and power sources, new entrants have an opportunity to disrupt the current industry structure, especially by initially targeting these lower margin gaps and building market share, before moving further up the industry.

Within the strategy development process an analysis of the market, customers, competitors and internal capabilities is essential, leading to the development, evaluation and selection of a set of strategic options. Incumbents can then decide whether to watch, wait and attempt to adapt to the upcoming changes, or try to lead the change in the market. If incumbents choose to act now, the most pressing current issue is to develop an effective Research and Development strategy, whilst also preparing their organisations for a potential cultural transformation so as to be able to respond to rapid change. New entrants, be it early stage start-ups or well established players in adjacent industries, need to have a clear market entry strategy, well-adapted to the specific challenges of the aerospace sector.

As usual at times of high uncertainty, scenario planning can help shed additional light on how the industry may evolve, whilst strategic war gaming allows organisations to test their planned strategies against competitor responses in a realistic, simulated environment.

## GOVERNMENTS

Countries can also benefit from the electrification trend. Governments have an opportunity to position their country for the potential long-term gains that aircraft electrification could generate. Governments must evaluate what kinds of benefits they would be able to capture, and work to quantify them to generate the country-level business case.

Potential benefits at a country level could include:

- .....
- Job creation and increased employment in highly skilled sectors (both aerospace and electronics industries, among others) with reputational gains and positive externalities for the entire country
  - Increased long-term GDP growth
  - A potential long-term boost to productivity
- .....

Governments must thus set up new industrial strategies which consist of tax incentives to attract investment from the right companies, and potentially co-invest into public-private partnerships as a vehicle to increase the pace of innovation.

Governments can also position themselves at the cutting edge of regulation to enable technology demonstrators – but also ultimately, enable the certification of new aircraft platforms. In contrast to the regulation of supersonic flight in the US, which deterred innovation by banning supersonic flight over land, regulation must be structured so as to encourage innovation.

Finally, aircraft electrification represents a major opportunity for research institutes and universities.

# Is aircraft electrification the next chapter in aviation? It is not a question of if, but when.

Conventional fossil-fuel based sources of power – though they can last many more decades – are ultimately limited. On the other hand, electric power is future-proof, and potentially more efficient. Many other industries have already completely or partially electrified, from residential power and locomotives, to the ongoing revolution in the automotive industry. With more complex and demanding requirements, aerospace remains a harder nut to crack, but all indications suggest that it will eventually follow suit.

The trend of More Electric Aircraft has already begun to pay dividends for suppliers that acted early within the limitations of current aerospace architectures and within the current ecosystem. The burgeoning trend of Electrical Propulsion promises to completely revolutionise the industry, with brand new architectures and ecosystems becoming tomorrow's reality. Consumers can look forward to cleaner, greener, cheaper and potentially safer flight in the future. Current aerospace companies must now work to identify the crest and figure out how to ride the wave of change; new entrants must decide when and how to enter; investors must decide which ventures to back; and governments should consider how best to facilitate economic and industrial growth.

The next few decades of aerospace are set to be eventful indeed. ◆

# ABOUT US

Roland Berger, founded in 1967, is the only leading global consultancy of German heritage and European origin. With 2,400 employees working from 34 countries, we have successful operations in all major international markets. Our 50 offices are located in the key global business hubs. The consultancy is an independent partnership owned exclusively by 220 Partners.

## Navigating Complexity

For the past 50 years, Roland Berger has helped its clients manage change. Looking at the coming 50 years, we are committed to supporting our clients conquer the next frontier. To us, this means facilitating navigating the complexities that define our times by providing clients with the responsive strategies essential to success that lasts.

## FURTHER READING



### A&D TOP MANAGEMENT ISSUES RADAR 2017

#### **The preparedness paradox and the comeback of strategy**

Since the last edition of the Roland Berger Aerospace and Defense Top Management Issues Radar in 2016, the geopolitical landscape has changed dramatically – more than most would have imagined was possible.



### RISE TO THE CHALLENGE

#### **The risks and opportunities of digitization for airports**

Today's airport industry is awash with buzzwords. Mobile check-in apps, self-service bag drop, indoor geo-location, electronic bag tags, interactive digital displays – everything boils down to one thing: The digital revolution is here and it's transforming the airport industry.

## LINKS & LIKES

**ORDER AND DOWNLOAD**  
[www.rolandberger.com](http://www.rolandberger.com)

**STAY TUNED**  
[www.twitter.com/  
RolandBerger](https://www.twitter.com/RolandBerger)

**LIKE AND SHARE**  
[www.facebook.com/  
RolandBergerGmbH](https://www.facebook.com/RolandBergerGmbH)

## Publisher

### **ROLAND BERGER LTD**

55 Baker Street  
London W1U 8EW  
United Kingdom  
+44 20 3075-1100

### **INTERNATIONAL A&D EXPERTS**

Wilfried Aulbur (India)	Vatche Kourkejian (UAE)
Stephan Baur (Germany)	Mehdi Lalou (Morocco)
Massi Begous (France)	Soosung Lee (South Korea)
Julien Bzowski (France)	Holger Lipowsky (Germany)
Roberto Crapelli (Italy)	Pierpaolo Mamone (Italy)
Rodrigo Custodio (Brazil)	Luz Matres (Spain)
Damien Dujacquier (Singapore)	Maria Mikhaylenko (Russia)
Thibault Dupont (France)	Jens Nackmayr (Great Britain)
Thierry Duvette (France)	Alain d'Oultremont (Belgium)
Rahul Gangal (India)	Michael Pötzl (Germany)
Dominique Gauthier (Canada)	Aurore Provost (France)
Emmanuel Godard (Canada)	Sloka Roy (India)
Francois Guenard (France)	Neranjana de Silva (Great Britain)
Manfred Hader (Germany)	Alex Xu (China)
Oliver Hazimeh (United States)	Jeff Yu (China)
Housseem Jemili (Saudi Arabia)	Artem Zakomirnyi (Ukraine)

## WE WELCOME YOUR QUESTIONS, COMMENTS AND SUGGESTIONS

### **ROBERT THOMSON**

Partner  
+44 20 3075-1100  
robert.thomson@rolandberger.com

### **MAXIM NAZUKIN**

Senior Consultant  
+44 20 3075-1100  
maxim.nazukin@rolandberger.com

### **NIKHIL SACHDEVA**

Senior Consultant  
+44 20 3075-1100  
nikhil.sachdeva@rolandberger.com

### **NICOLAS MARTINEZ**

Senior Consultant  
+49 89 9230-8550  
nicolas.martinez@rolandberger.com

This publication has been prepared for general guidance only. The reader should not act according to any information provided in this publication without receiving specific professional advice. Roland Berger GmbH shall not be liable for any damages resulting from any use of the information contained in the publication.