

BIESSE ROVER J FT

NC processing centre

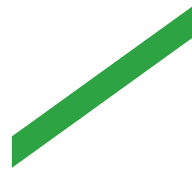

When competitiveness
means accuracy
automated



Made **In** Biesse

The market demands

a change in manufacturing processes, enabling companies to accept the **largest possible number of orders**. This is coupled with the need to maintain high quality standards whilst offering product customisation with quick and defined delivery times.

Biesse reacts

with high-tech, innovative solutions for nesting operations. Rover J G FT is Biesse's Gantry machining center designed for processing wood and wood based panels. It is the ideal machine for craftsmen, who need to automate their production.

- ✓ **Effective during all machining operations.**
- ✓ **High technology for exceptional finish quality.**
- ✓ **Optimal piece locking for working precision.**
- ✓ **User friendly solutions for maximum efficiency.**



Easy to use
and maximum
functionality



ROVER J FT
NC processing centre



Effective during all machining operations

Rover J FT can process Nesting of cabinet doors and furniture elements, carving on solid wood, panels and doors.

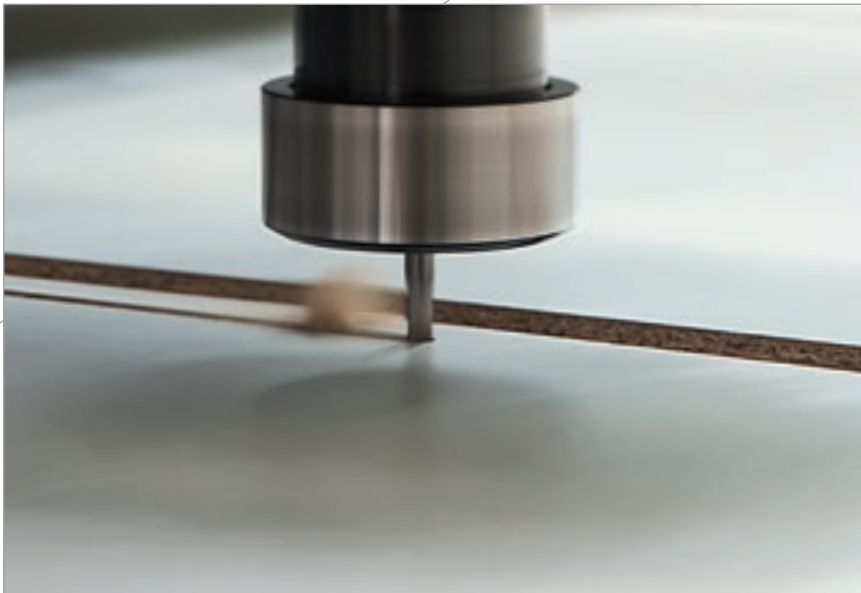



High technology for exceptional finish quality

Biesse uses the same high-tech components for all machines in its product range. The electrospindle, boring head and aggregates are designed and manufactured for Biesse by HSD, the global leader in this sector.



Electrospindles for all the applications:

- 5 kW HSD spindle with manual tool changing 1.000-24.000 rpm (standard),
- 9 kW HSD ISO30 / HSK F63 1.000-24.000 rpm (optional).



Boring head BH5.

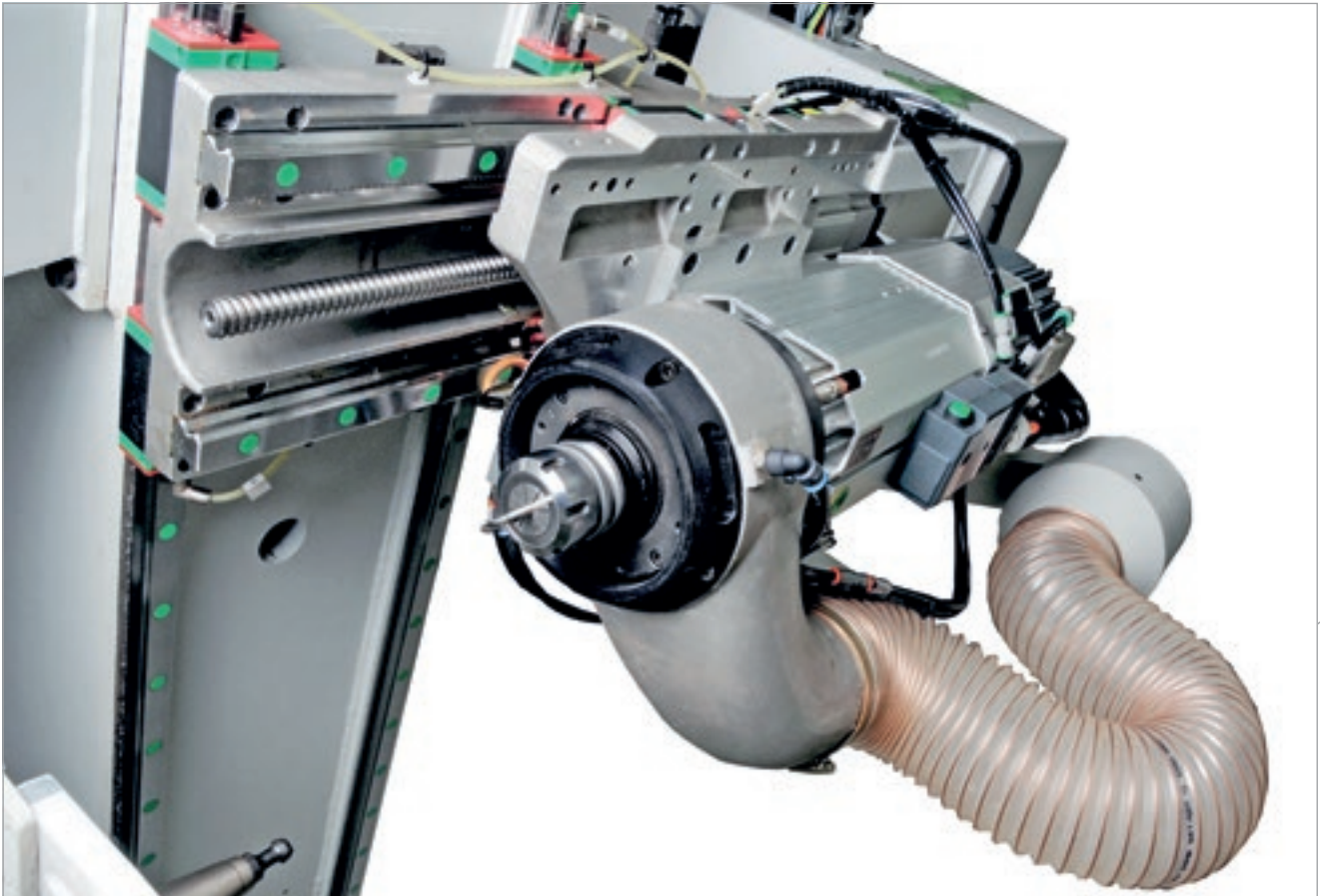

Reduced processing times thanks to rack tool changer with 7 (Rover J FT 1224) or 8 (Rover J FT 1530) positions.

Optimal piece locking for working precision

Universal work table with a solid structure to machine panels with the maximum reliability.



The aluminium working table allows manual locking using T - slots or vacuum locking (optional).



Manual selection of vacuum zones.

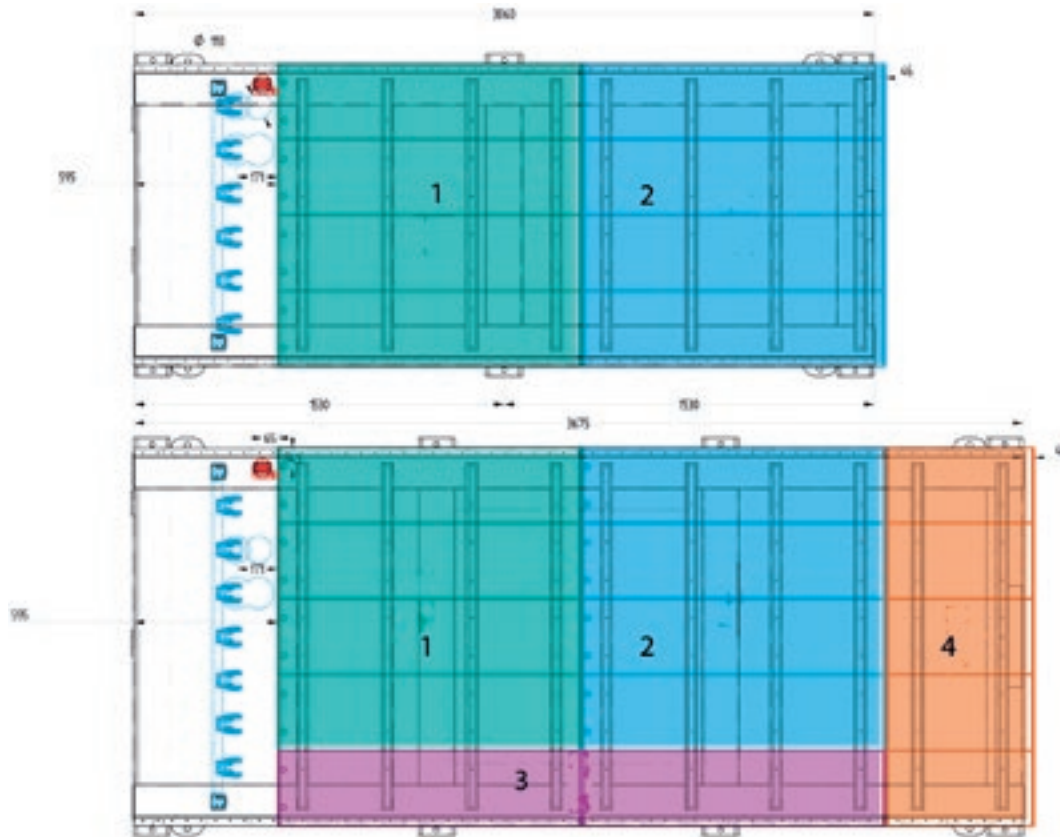

Manual mechanical reference stops for a easy work table set up.

Productive economy

Biesse's processing centres for nesting and carving operations allow to achieve a finished produced machined on a single, compact machine at a competitive price. The robust and well-balanced structure of the machine is ideally suited for withstanding greater processing stresses without compromising the quality of the piece and for ensuring the best finish on different types of materials.

NESTING SOLUTIONS

Productivity and efficiency are increased, while maintaining high quality standards and fast delivery times.

A perfect combination of Biesse optimisation and Italian genius.



User friendly solutions for maximum efficiency

Rover J FT offers cutting edge technology that's easy to use, reliable and guarantees first class results.

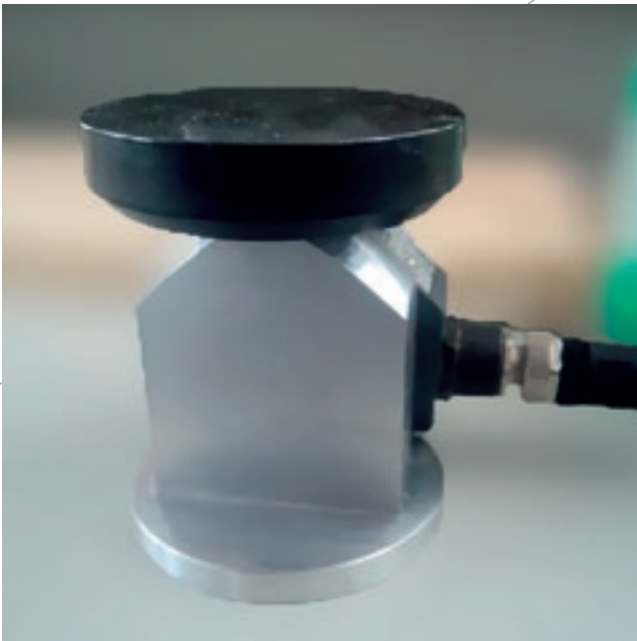

Reduction of tool change set-up time and the possibility of operator error, thanks to the contact pre-setter, which automatically determines the length of the tool.



The double X-axis motorisation supports high speeds and accelerations whilst ensuring high finish precision and quality.



DSP remote control panel for direct and immediate operator control.



Manual or automatic (optional) lubrication to ensure the continuous lubrication of the machine's main moving parts.



PC based BH Control system.

Simple and functional high-tech



The BiesseWorks graphic interface makes full use of the operating methods typical of the Windows operating system:

- ✓ **assisted graphic editor used to program machining operations;**
- ✓ **programming and guided creation of parametric macros;**
- ✓ **import of CAD and other external software files in DXF and CID3 format.**

bNest

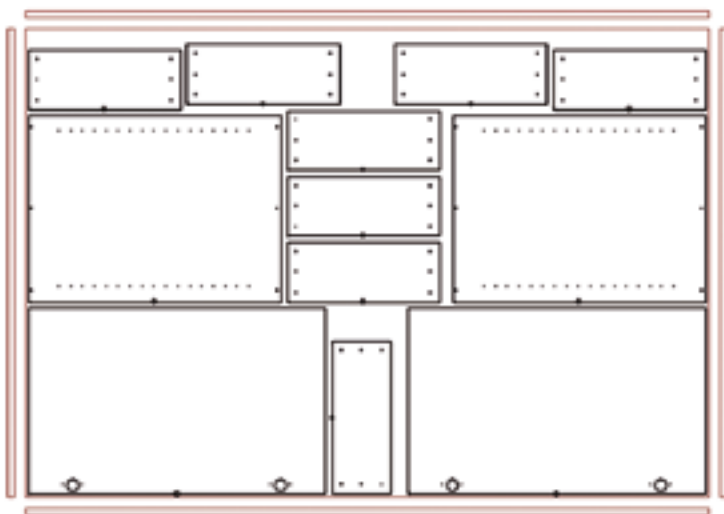

The Biesse entry level software module to prepare and optimize machining diagrams in Nesting mode. Perfectly integrated with BiesseWorks, BiesseNest makes nesting of every kind of shape, while using parametric programs in a simple and effective way.

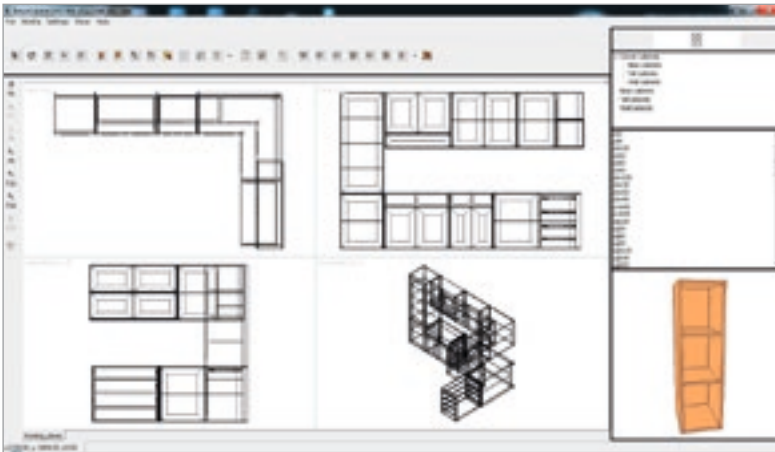

BiesseCabinetEVO is the software solution for the design of the interior cabinet with several possibilities for the visualization of the project and all the required workings (optional).

iCam

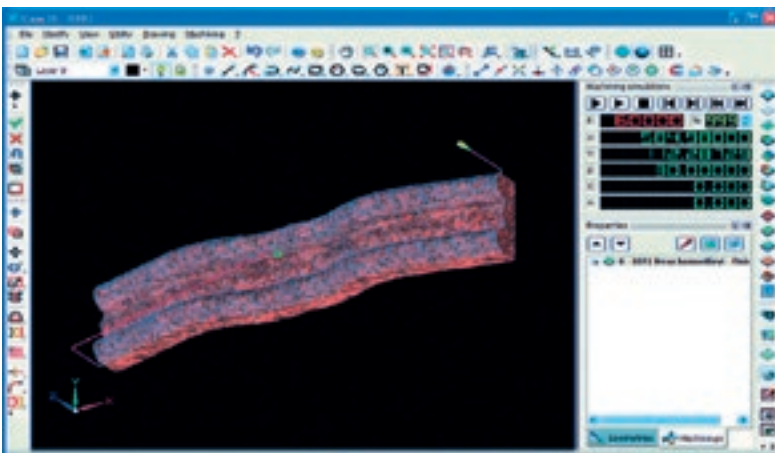

Innovative 3D CAD/CAM running on Windows environment, installable in the office or on the onboard machine PC, user friendly and extremely intuitive to use (optional).

Technical specification

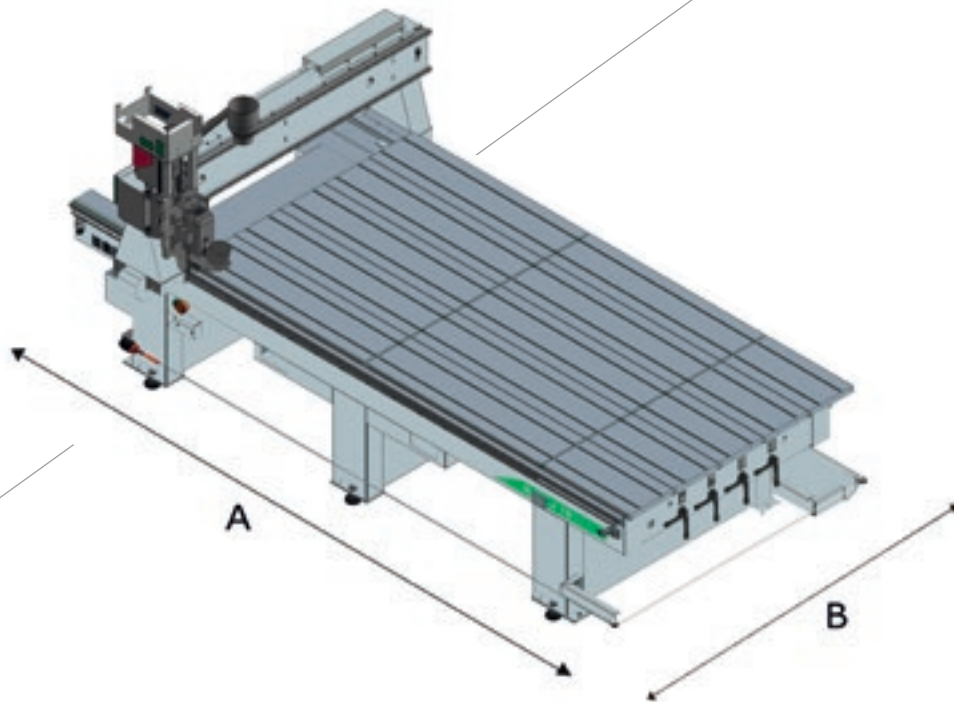

	A	B	HEIGHT (MAX)
	mm / inch	mm / inch	mm / inch
Rover J FT 1224	3584 / 141.1	1456 / 57.3	2210 / 87
Rover J FT 1530	4227 / 166.4	1768 / 69.6	2210 / 87

Loadable piece	200 mm	7.87 inch
Z axis stroke	260 mm	10.23 inch
Axes speed X/Y/Z	22.5 / 22.5 / 15 m/min	73.8 / 73.8 / 49.2 feet/min
Axes speed X/Y/Z (High speed optional)	60 / 60 / 15 m/min	196.8 / 196.8 / 49.2 feet/min

The technical specifications and drawings are non-binding. Some photos may show machines equipped with optional features. Biesse Spa reserves the right to carry out modifications without prior notice.

A weighted sound pressure level (LpA) during machining for operator workstation on vane-pump machine Lpa=79dB(A) Lwa=96dB(A) A-weighted sound-pressure level (LpA) for operator workstation and sound power level (LwA) during machining on cam-pump machine Lwa=83dB(A) Lwa=100dB(A) K measurement uncertainty dB(A) 4

The measurement was carried out in compliance with UNI EN 848-3:2007, UNI EN ISO 3746: 2009 (sound power) and UNI EN ISO 11202: 2009 (sound pressure levels at workstation) during panel machining. The noise levels shown are emission levels and do not necessarily correspond to safe operation levels. Despite the fact that there is a relationship between emission and exposure levels, this may not be used in a reliable manner to establish whether further measures need to be taken. The factors determining the exposure level for the workforce include length of exposure, work environment characteristics, other sources of dust and noise, etc. i.e. the number of other adjoining machines and processes. At any rate, the above information will enable the operator to better evaluate dangers and risks.

Biesse CNC Nesting range

CNC - NESTING



ROVER J FT



KLEVER



ROVER S FT



SKILL FT



ROVER A FT



ROVER B FT



EXCEL LINE

Service & Parts

Direct, seamless co-ordination of service requests between Service and Parts.
Support for Key Customers by dedicated Biesse personnel, either in-house and/or at the customer's site.

Biesse Service

- ✓ Machine and system installation and commissioning.
- ✓ Training centre dedicated to Biesse Field engineers, subsidiary and dealer personnel; client training directly at client's site.
- ✓ Overhaul, upgrade, repair and maintenance.
- ✓ Remote troubleshooting and diagnostics.
- ✓ Software upgrade.

500 / Biesse Field engineers in Italy and worldwide.

50 / Biesse engineers manning a Teleservice Centre.

550 / Certified Dealer engineers.

120 / Training courses in a variety of languages every year.

The Biesse Group promotes, nurtures and develops close and constructive relationships with customers in order to better understand their needs and improve its products and after-sales service through two dedicated areas: Biesse Service and Biesse Parts.

With its global network and highly specialised team, it offers technical service and machine/component spares anywhere in the world on-site and 24/7 on-line.

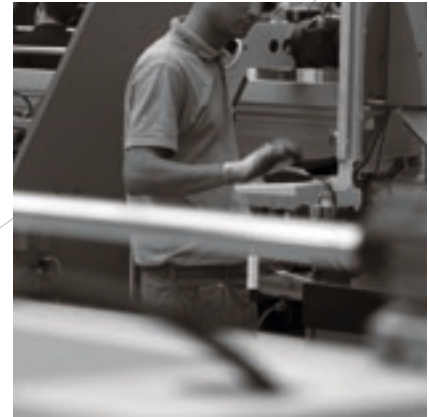

Biesse Parts

- ✓ Original Biesse spares and spare kits customised for different machine models.
- ✓ Spare part identification support.
- ✓ Offices of DHL, UPS and GLS logistics partners located within the Biesse spare part warehouse, with multiple daily pick-ups.
- ✓ Order fulfilment time optimised thanks to a global distribution network with de-localised, automated warehouses.

87% / of downtime machine orders fulfilled within 24 hours.

95% / of orders delivered in full on time.

100 / spare part staff in Italy and worldwide.

500 / orders processed every day.

Made **With** Biesse

Maton and Biesse make music together.

With more than 1200 models of guitars made for thousands of professional musicians, Maton Guitars confirms its worldwide presence, becoming a truly great Australian success story. "The best guitar is the one that the market demands," states Patrick Evans, Head of Product Development at Maton. The evolution in production techniques and research into the most efficient software continues, prompting Maton to hunt for new solutions that can better respond to emerging needs. In 2008, after considering the pros and cons of a range of manufacturers, Maton chose Biesse. Maton's production needs incorporate technological requirements and artisan skills; the right balance of these two allows them to achieve the highest levels of quality and performance. A great guitar is both a work of art and a fine musical instrument. To obtain these results, the right tools are crucial - both for heavy machining operations and delicate processes, to create 3D shapes and work with minimal tolerances. Biesse has provided Maton with a range of advanced solutions for machining processes, not only adding quality to the products, but also providing the skilled craftsmen with more time to devote to manual finishes, ensuring

that every product is unique. In 1995, the company installed their first CNC machine. They now have two nesting centres in tandem. The Rover C is the ideal machine for high-precision nesting operations, but also for creating complex shapes, such as the body of Maton's unique guitars. The machine's newly-designed cabin provides excellent visibility of all working units. Biesse is much more than a manufacturer of machinery for producing kitchens. Their impressive range of machines can process an astounding range of materials and products. "In creative hands," commented Patrick Evans, "Biesse becomes the instrument of a true craftsman. The key is to identify the right machine for the job. We found we can accomplish much more than we thought on a Biesse machine." Maton also uses the two Biesse machines to create new product prototypes; the most complex shapes, and almost every individual part which makes up a Maton guitar. Patrick confirms that Maton uses the Biesse CNC machine at high speeds even on the most complex parts, such as the magnificent fingerboard. "We need enough flexibility to be able to switch from one model to another very quickly, and Biesse allows us to do this

very effectively." Biesse gives users the creative freedom to produce virtually any concept, both quickly and efficiently. "With the Biesse's CNC machine," Patrick continues, "you can turn your ideas into reality much faster. Thanks to the flexibility provided by Biesse machines, we can produce two fingerboard prototypes in seven minutes! If we made them by hand, it would take a whole day. Using Biesse machines has allowed us to create eight new guitar models this year alone." Using Biesse machines has allowed Maton to devote more time to the quality of the finish, wasting less time on processing individual pieces. Each Maton guitar is hand-finished by a dedicated and qualified team of luthiers. Maton has demonstrated that it is possible to produce a guitar in Australia with a worldwide reputation for quality, using Australian timber and technologies. Maton knows exactly how to design and build a unique, one-of-a-kind product, a well-made guitar, and with Biesse as valued partner, the best guitars in the world are brought to life.

Taken from an interview with Patrick Evans, head of Product Development at Maton Guitars - Australia



<http://www.maton.com.au>



Biesse Group

In

1 industrial group, 4 divisions.
and 8 manufacturing sites.

How

€ 14 million p/a in R&D and 200 patents registered.

Where

33 branches and 300 agents/certified dealers.

With

customers in 120 countries, manufacturers of furniture, design items and door/window frames, producers of elements for the building, nautical and aerospace industries.

We

3000 employees worldwide.

Biesse Group is a global leader in the technology for processing wood, glass, stone, plastic and metal.

Founded in Pesaro in 1969, by Giancarlo Selci, the company has been listed on the Stock Exchange (STAR segment) since June 2001.

 **BIESSEGROUP**

 **BIESSE**

 **INTERMAC**

 **DIAMUT**

MECHATRONICS

