

NEOCEMENT[®]

CONCRETE EFFECT



NEOCEMENT® INDUSTRIAL CHIC

Neocement is a seamless, joint free, decorative finish specifically designed for application on interior or exterior walls and floors.

Applied by hand at reduced thicknesses, Neocement finishes are real work of craftsmanship that can be personalized to your own style by playing with color schemes and intensity, texture effects or even stencils and stamping to give any space its own unique character.

This versatility makes Neocement perfect to add depth, harmony and simple sophistication to private homes, businesses, showrooms, restaurants, stores or even shopping centers.

www.neocement.com

Neocement, Colortek, Wall & Floor Fashion and the Colortek Drop Symbol are registered trademarks.

© 2019





INNOVATIVE MATERIAL & SUSTAINABLE DESIGN

Neocement is part of the new generation of smart decorative products meant to transform your space with minimal impact.

Applied on a multitude of surfaces, in any conditions (concrete, ceramics, wood, plasterboard, masonry walls, staircases, bathtubs, showers, etc.), Neocement's formulation is based on a cement and very low VOC water-based polymers blend, allowing it to meet sustainable architectural requirements for adaptability, transformation and change of any surface at a much lower cost than removal and replacement.

Photo Caption 01

Iwan Maktabi Showroom

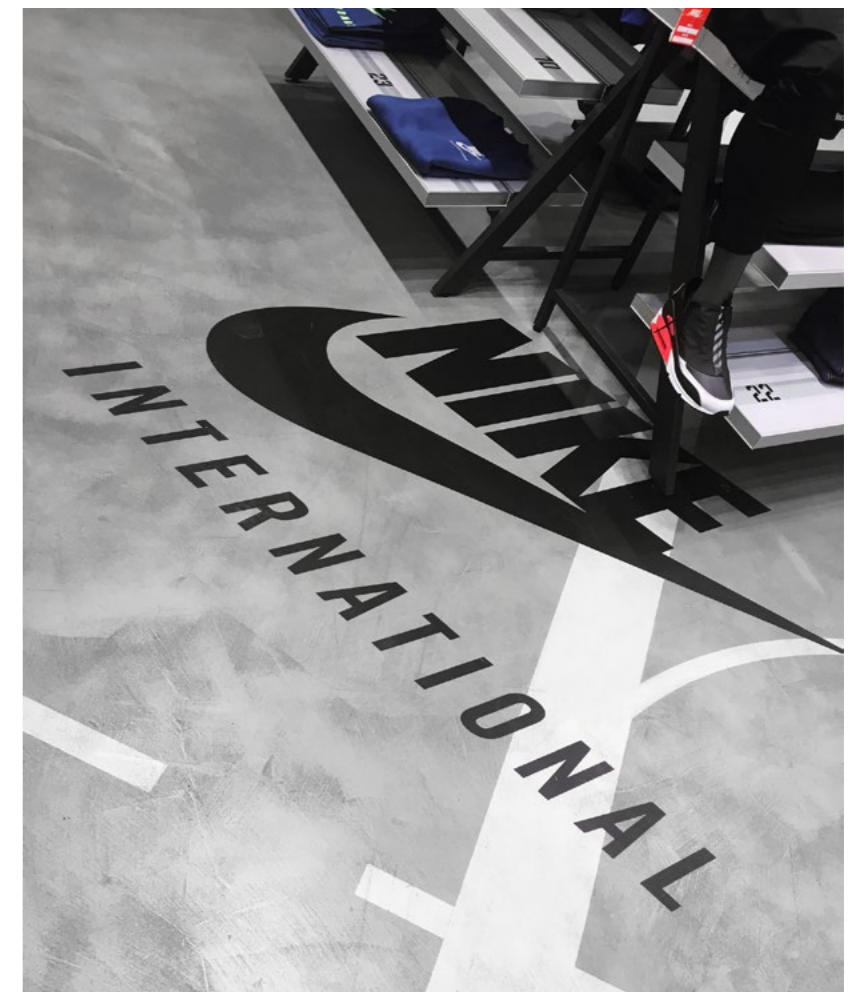

Photo Caption 02

Zaatar W Zeit Franchise

Photo Caption 03

Nike Store





HIGH PERFORMANCE, UTILITY, DURABILITY

With only a thickness of 3 millimeters, Neocement can be applied on horizontal and vertical surfaces, indoors and outdoors and even on objects such as furniture, allowing you to give free rein to your creativity without constraints or limitations.

Extraordinary adhesion, high abrasion and compression resistance, as well as UV and water resistance properties make this product an ideal choice to renovate any type of surface, while reducing to a minimum dust, rubble and all other waste from normal restoration works.

Photo Caption 04

Converse Shop
Beirut - Lebanon

Photo Caption 05

Artists Loft
Beirut - Lebanon
Architect - Bernard Khoury





FLOOR SYSTEM

1. SURFACE PREPARATION

- On concrete, apply SX0 PrimeWell, or SX9 HumiGuard.
- On Glazed floor tiles, apply Neogrip.

2. NEOFILLER BASE COAT APPLICATION

Apply Neofiller in 2 coats and sand with a 40 grid once the surface has hardened.

3. NEOCEMENT APPLICATION

Apply Neocement in two coats.

Once the first coat has dried, apply the second coat, wait for it to harden before sanding the surface with a 150 or 220 grid.

4. PROTECTIVE COAT APPLICATION

Apply the appropriate protective topcoat depending on the intended use of the surface and its location.

Refer to the intended use table of the brochure and technical data sheet for additional details.



WALL SYSTEM

1. SURFACE PREPARATION

- On concrete, apply Colortek Fondo F.
- On glazed tiles, apply the Colortek Putty XT/XF exterior skim coat system.

2. NEOCEMENT APPLICATION

Apply Neocement in two coats.

Once the first coat has dried, apply the second coat, wait for it to harden before sanding the surface with a 150 or 220 grid.

3. PROTECTIVE COAT APPLICATION

Apply the appropriate protective topcoat depending on the intended use of the surface and its location.

Refer to the intended use table of the brochure and technical data sheet for additional details.

IMPORTANT NOTICE

- Cracks and holes should be repaired with Colortek SX2 Epoxy Filler.
- Glazed tiles should be sanded and tiles joints should be treated with SX2 Epoxy Filler.



PROTECTIVE TOP COAT BASED ON INTENDED USE

LOCATION & EXPECTED CONDITIONS		VERTICAL SURFACE	HORIZONTAL SURFACE LIGHT TRAFFIC	HORIZONTAL SURFACE MEDIUM TRAFFIC	HORIZONTAL SURFACE HEAVY TRAFFIC
INTERIOR	Dry conditions	Colortek Wax, Aqua Wax, Colortek 4005, Polylock	Neoshield (2 coats) Polylock (2 coats)	Polylock (2 coats)	Neofiller (3 coats) + Polylock (2 coats)
	Humid conditions	Polylock (2 coats)	Polylock (3 coats)	Polylock (3 coats)	Neofiller (3 coats) + Polylock (3 coats)
	Submerged conditions	Colortek PL1 (2 coats)	Colortek PL1 (2 coats)	Colortek PL1 (2 coats)	Neofiller (3 coats) + Colortek PL1 (2 coats)
EXTERIOR	Dry conditions	Colortek 4005 Polylock	Polylock (2 coats)	Polylock (2 coats)	Neofiller (3 coats) + Polylock (2 coats)
	Humid conditions	Polylock (3 coats)	Polylock (3 coats)	Polylock (3 coats)	Neofiller (3 coats) + Polylock (3 coats)
	Submerged conditions	Neofiller (3 coats) + Colortek PL1 (2 coats)	Neofiller (3 coats) + Colortek PL1 (2 coats)	Neofiller (3 coats) + Colortek PL1 (2 coats)	Neofiller (3 coats) + Colortek PL1 (2 coats)

PRODUCT NOTICE

- PL1 has a glossy finish. If a flat finish is required, apply a final coat of COLORTEK PL1 Low Gloss.
- Polylock is available in flat, gloss and anti-slip versions.

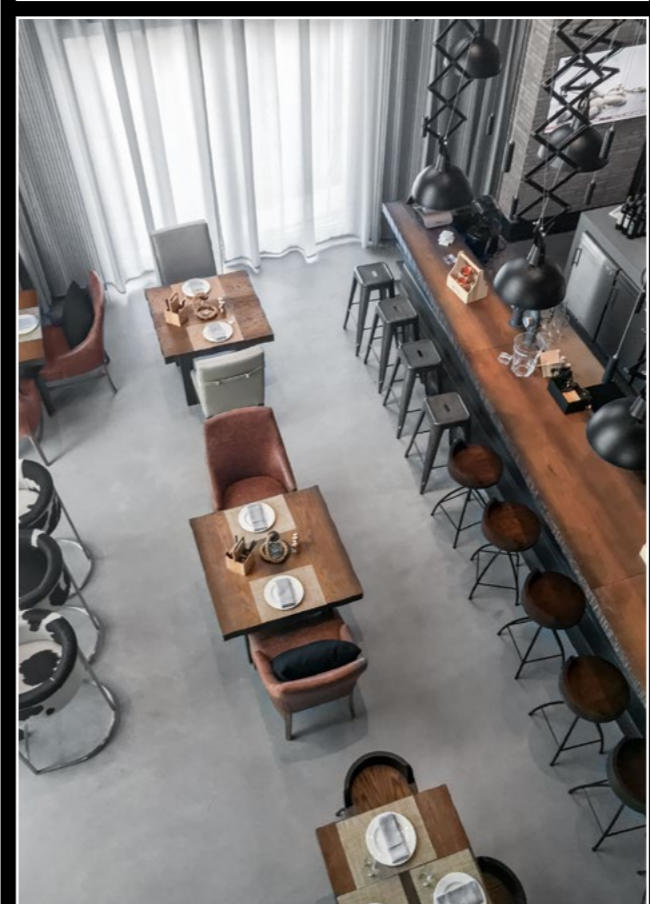
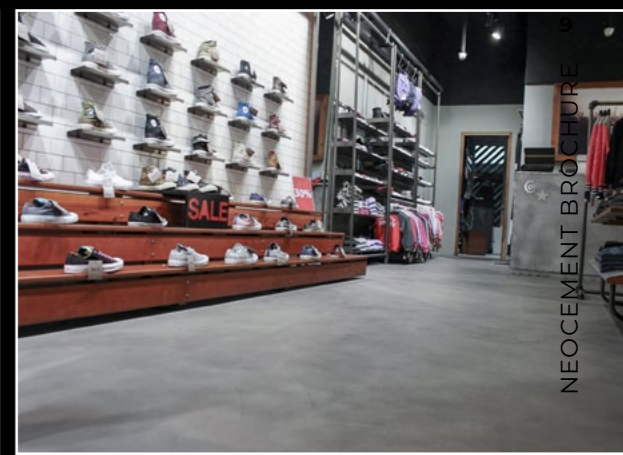
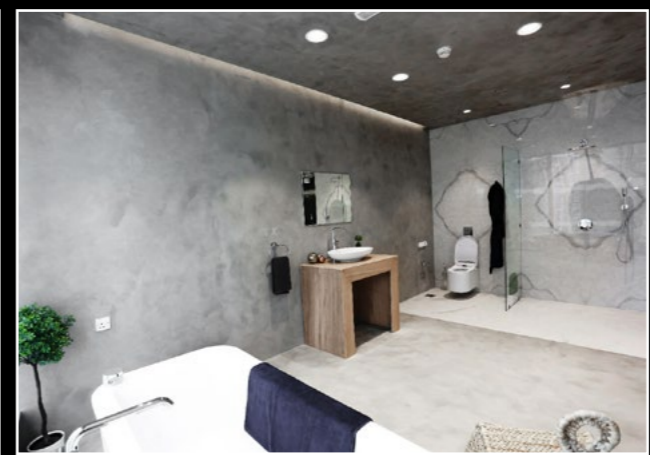
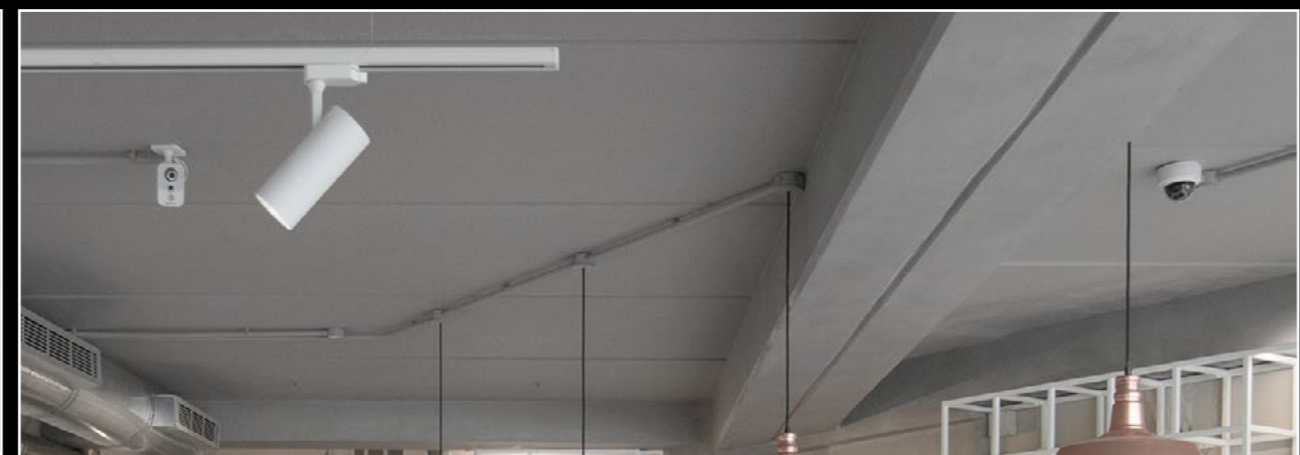
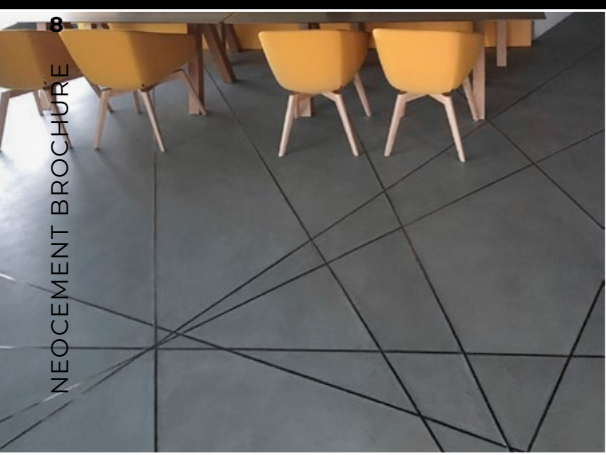
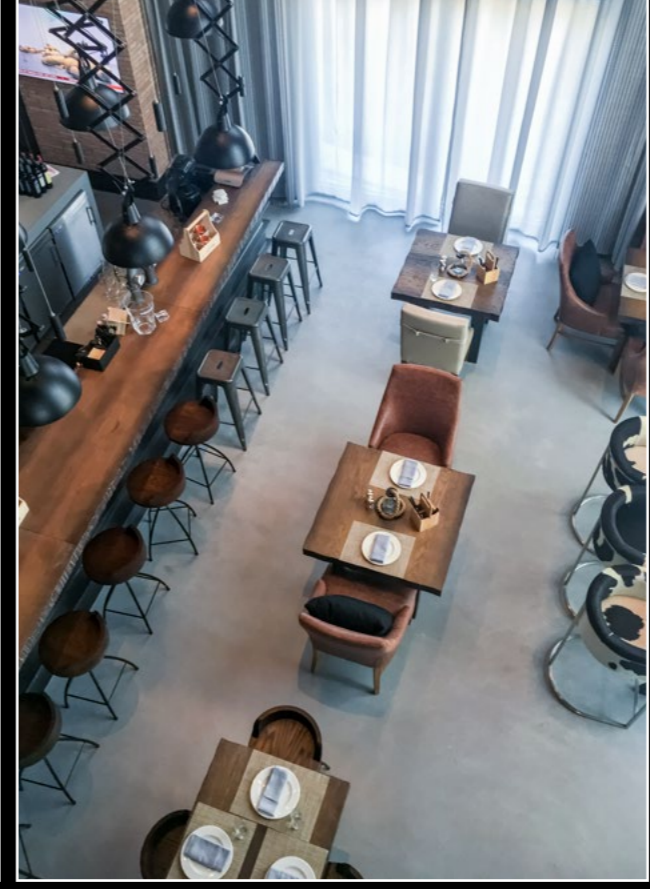

NEOCEMENT BROCHURE

NEOCEMENT BROCHURE



200/00 Castle White 200/103- Vapor 200/106 Canvas 200/106 Canvas + Metallo R Silver 200/109 Paper 200/112 Urban



200/101- Neutral 200/104 Cloud 200/107 Dust 200/107 Dust + Metallo R Silver 200/110 Attic 200/113 Slab

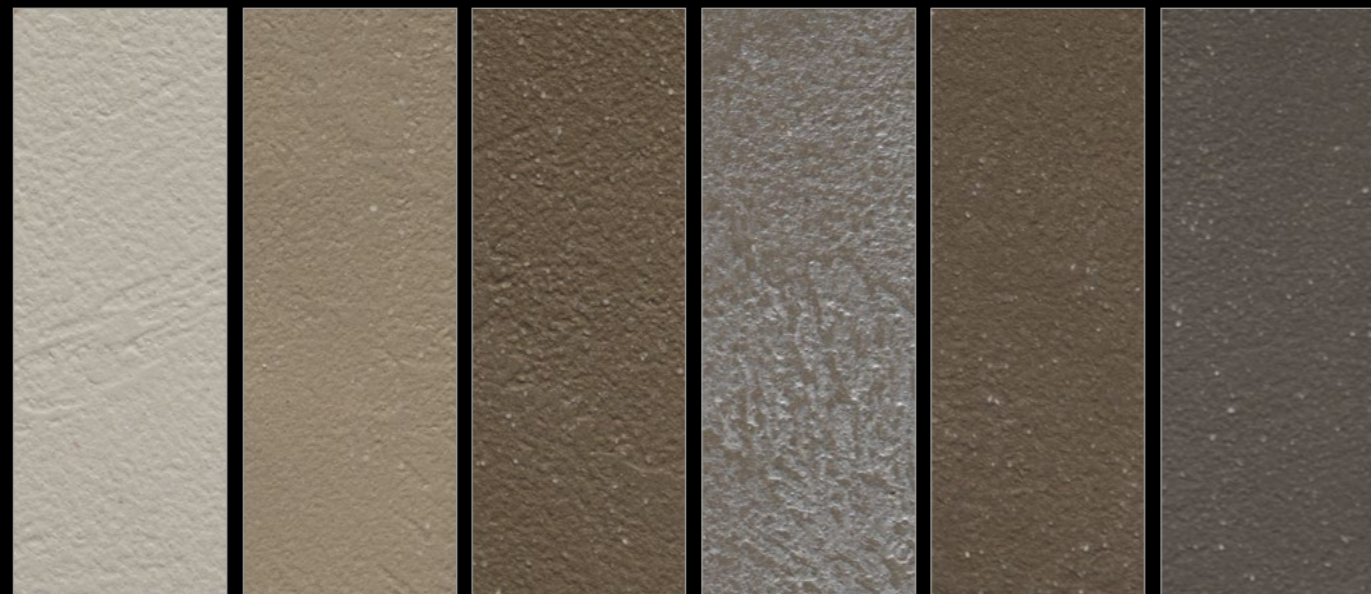

200/102- Raw 200/105 Stone 200/108-Terre 200/108-Terre + Metallo R Silver 200/111 Depth 200/114 Refined



200/115 Steam 200/115 Steam + Metallo R Silver 200/118 Ashes 200/121 Loft 200/124 Horizon 200/124 Horizon + Metallo R Silver

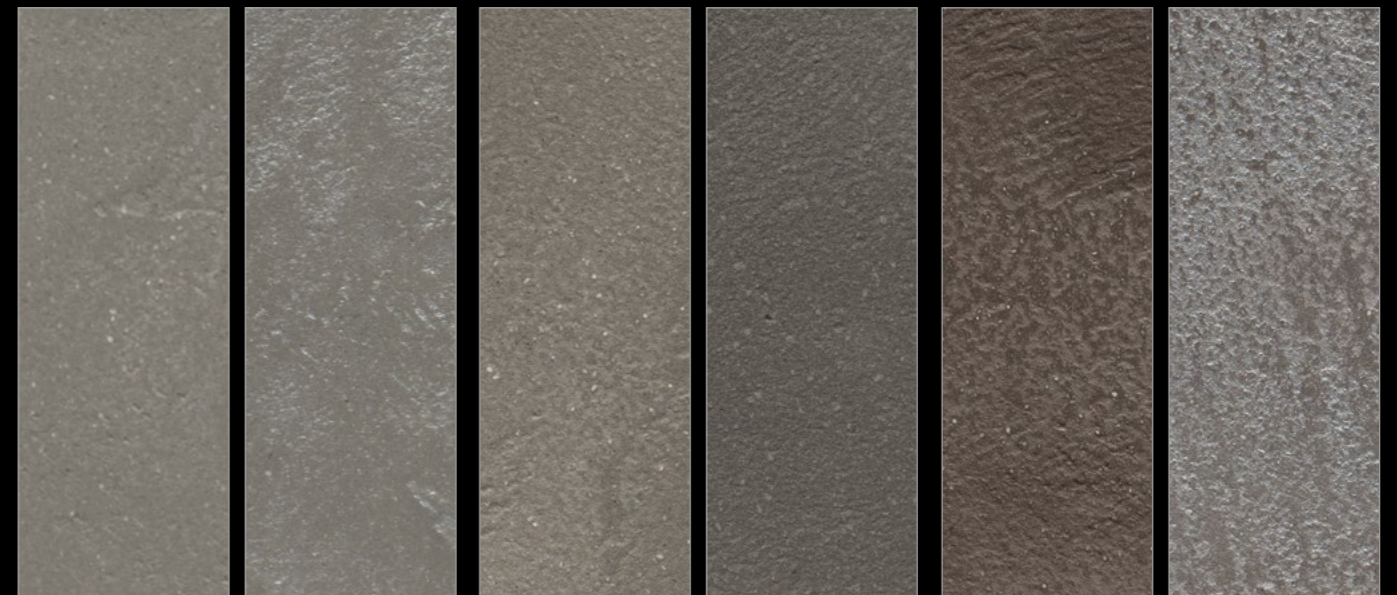

200/116 Sidewalk 200/116 Sidewalk + Metallo R Silver 200/119 Cast 200/122 Fusion 200/125 Cork 200/125 Cork + Metallo R Silver

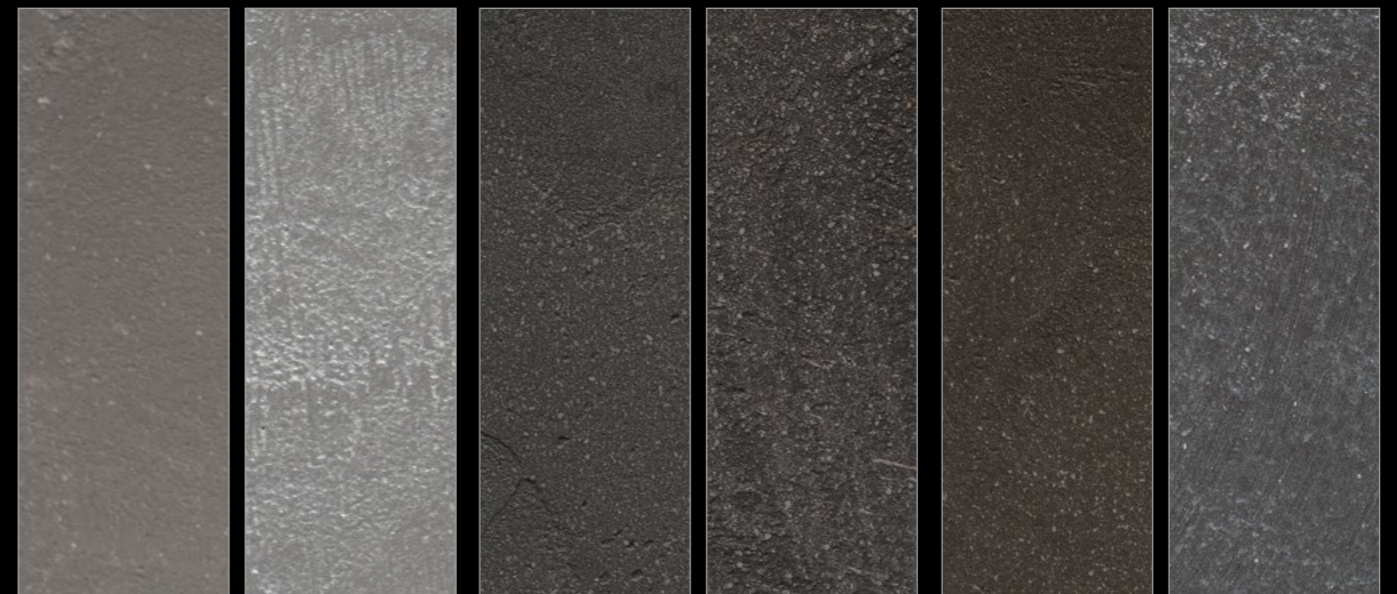

200/117 Wet Cement 200/117 Wet Cement + Metallo R Silver 200/88 Carbon 200/123 Slate 200/126 Onyx 200/126 Onyx + Metallo R Silver



TESTING RESULTS QUESTIONS & ANSWERS

How durable is Neocement?

Applied properly and protected by the adequate topcoat, Neocement should last indefinitely.

Is Neocement difficult to apply?

Proper surface preparation is critical. Fixing the substrates and testing for other possible substrate problems should be done by an expert contractor.

Is Neocement suitable for exterior applications?

Neocement can be used in external areas. The system's protective options provide it with good resistance from water penetration, climatic stress and UV rays.

Is Neocement suitable for commercial and residential spaces?

Neocement is highly resistant to wear and tear and is suitable for any field of interior design.

Is Neocement suitable for wet areas?

Neocement can be used in wet areas. It is the ideal renovation choice as it can be applied over any type of surface, rendering the removal of old tiles unnecessary.

Neocement be used with underfloor heating?

Yes, Neocement can be used with floor heating systems.

Is Neocement stain resistant?

Neocement comes with a range of sealers that meet the requirements of daily life. As long as the liquid is not left stagnant, the protective coating can protect the flooring from spilled liquids.

Can Neocement be customized?

Neocement can be tinted to any color. It is also possible to create different effects or patterns through the use of decorative inserts to form unique, personalized finishes.

Can Neocement be applied on Terrazzo?

Terrazzo tiles differ greatly in their composition with some highly prone to humidity permeability, which is why we recommend the application of SX9 HumiGuard and of an additional coat of Neofiller, a highly efficient humidity blocker.

Can Neocement be applied on glazed ceramics?

Yes, when the glazed tiles have been treated with Colortek Neogrip and slightly sanded or etched to promote adherence.

When applying on ceramic tiles, it is also important to treat the joint tiles with Colortek Epoxy Joint filler SX2 FillWell. Ceramic tiles joints are traditionally filled with cement-based tiling grout which is prone to letting humidity pass and the Epoxy based SX2 will prevent the ghosting effect.

How to avoid water filtration when cleaning?

When applying Neocement, it is important to apply it flush to the wall and to create a virtual skirting that impedes water filtration underneath the decorative coat by applying the protective sealer up to 3 cm vertically.

What is the difference between SX0 and SX9?

Colortek SX9 has additional humidity blocking and grip properties which can help preventing surfacing humidity while providing additional grip to subsequent layers of the Neocement system.

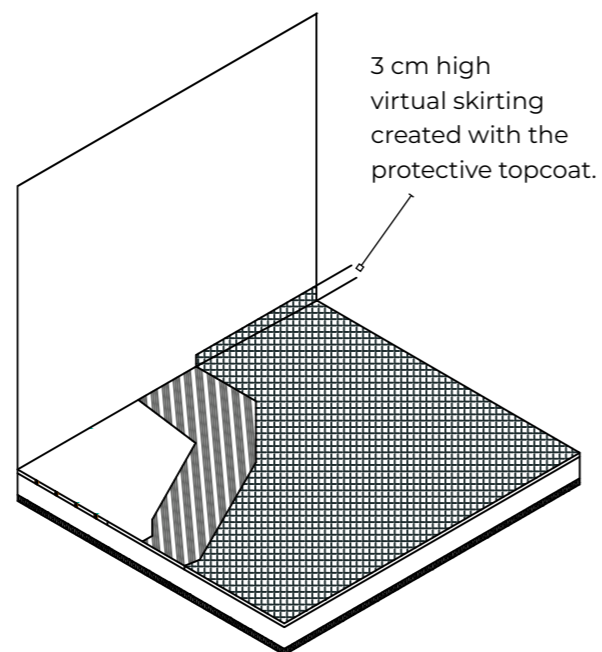

TEST	FEATURE	NORM	RESULT
	Indoor Air Quality	UNI EN ISO 16000-9:2006	A+ For Low VOC Emissions
	Thermal Resistance & Thermal Conductivity	ASTM E1530-11	$\lambda=0,46$ (W/mK)
	Fire Reaction	UNE-EN ISO 1716:2011 UNE-EN ISO 9239-1:2011	A2fl-s1
	Resistance To Chemicals	ASTM D 3260 ASTM D 1308	No alteration & no reduction of Shore
	Water Vapor Permeability	BS2782	203 g/m ² in 24 hours
	Water Absorption	DIN 52617	0,076 kg/m ² X h ^{0,5}
	Adhesion	ASTM D4541	>2 MPa, exceeding FeRFA limits for excellent flooring adhesion
	Abrasion Resistance	ASTM D4060	500 cycles/mil with 1 Kg load using CS-17
	Resistance To Impact	ASTM D2794	Sample intact after collision >1.4m For 1kg ball >0.7m For 2kg ball
	Surface Hardness	ASTM 2240	Shore D >75
	Slip Resistance	ASTM C1028	SRV >70 (R12 for Good Slip Resistance)

“We shape our buildings; thereafter they shape us.”

- Winston S. Churchill

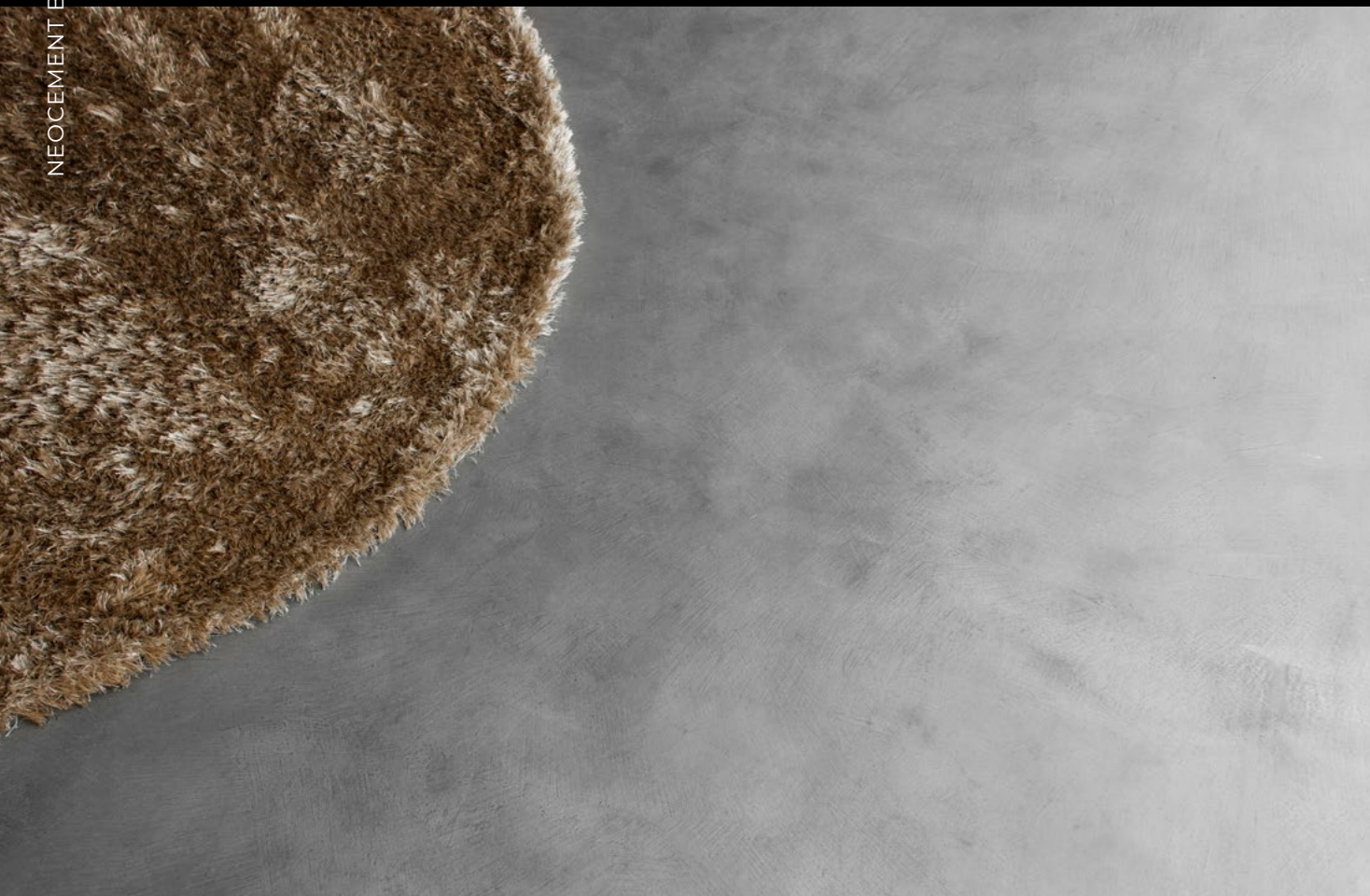

MAINTENANCE RECOMMENDATIONS

General Maintenance

Some elementary precautions and regular care can keep your Neocement Floor in good condition and extend the decorative appearance and life expectancy of any Colortek® Flooring System.

Before cleaning your new floor, you should sweep the area to remove any loose debris using a soft pad mop or a floor scrubber cleaner in combination with protective products based on self-polishing waxes dispersed in water.

If the floor is to be washed

Sweep or vacuum the floor to remove dust and debris using a soft bristle broom or vacuum cleaner.

Dilute a PH neutral detergent in clean water. Apply the solution to the floor, using a soft-medium pad.

It is important that all detergent residue is removed from the surface of the floor, because detergent can become slippery, which affects safety, or may remain sticky which attracts and holds more dirt.

Periodically treat the surface with protective products based on self-polishing waxes dispersed in water.

Precautions

Although Colortek floors have good mechanical resistance, they may be subject as all materials to time related degradation such as scratches, shine loss etc. Fine particles of dust, dirt and loose debris, act as abrasives with traffic unless the floor is cleaned regularly. Elementary precautions should also be taken to properly maintain the floor:

- Provide a doormat at the entrance that can trap dust, sand and abrasive particles.
- Put felt pads under the furniture, especially movable articles like chairs.
- In the event that heavy furniture has to be moved, place woolen cloth at the base of the furniture.
- Before carrying out painting, electrical or plumbing works, protect the floor with woolen blankets and nylon sheets.
- Quickly clean all stagnant spills of aggressive liquids such as wine, oils, vinegar and coffee.

Disclaimer

Failure to maintain a cleaning routine can affect the performance of Neocement. Please ensure you have read the health and safety data sheet for any cleaner you intend to use.