

**WARRANTY
REGISTRATION**
Register online today for a
chance to win a FREE Tripp Lite
product! www.tripplite.com/warranty



Owner's Manual

NetDirector Console KVM Switch (8- or 16-Port) or Rackmount KVM Switch (16-Port)

Models: B020-U08-19-K, B020-U08-19KTAA, B020-U16-19-K or B022-U16



This package should consist of:

- (1) B020-U08-19-K, B020-U08-19KTAA, B020-U16-19-K or B022-U16 KVM Switch
- (8) P778-006 USB/PS2 Combo KVM Cable Kits*
- (2) P778-006 USB/PS2 Combo KVM Cable Kits**
- (1) USB/PS2 Combo Console Cable Kit
- (1) RJ45 to DB9 Firmware Upgrade Cable
- (1) C13 to 5-15P Power Cord*
- (1) AC Power Adapter (Input: 100-240V, 50/60 Hz, 0.5A/Output: 5.3V, 2.4A)**
- (1) CD with Owner's Manual
- (1) Quick Start Guide
- (1) Grounding Wire
- (1) Rackmount Hardware Kit
- (1) Set of Rubber Feet**

*B020-U08-19-K, B020-U08-19KTAA or B020-U16-19-K only

**B022-U16 only

Check to see that the unit arrived undamaged, with all of its contents. Contact your dealer if there is a problem.



1111 W. 35th Street, Chicago, IL 60609 USA
www.tripplite.com/support

Note: Follow these instructions and operating procedures to ensure correct performance and to prevent damage to this unit or to its connected devices.

Copyright © 2010 Tripp Lite. All rights reserved. All trademarks are the property of their respective owners.

Table of Contents

| | | | |
|---|-----------|---|-----------|
| 1. Features | 3 | 7. OSD (On-Screen Display) Operation | 14 |
| 2. System Requirements | 3 | 7.1 OSD Overview | 14 |
| 2.1 Computer | 3 | 7.2 Logging-In for the First Time | 14 |
| 2.2 Console | 3 | 7.3 OSD Invocation Sequence | 14 |
| 2.3 Cables | 3 | 7.4 OSD Navigation | 14 |
| 3. Introduction | 4 | 7.5 OSD Main Screen Headings | 14 |
| 3.1 Front View of Console KVM Switch | 4 | 7.6 OSD Functions | 15 |
| 3.2 Rear View of Console KVM Switch | 5 | 8. Firmware Upgrade Utility | 18 |
| 3.3 Front View of B022-U16 | 5 | 8.1 Before You Begin | 18 |
| 3.4 Rear View for B022-016 | 6 | 8.2 Starting the Upgrade | 19 |
| 4. Installation | 6 | 8.3 Upgrade Succeeded | 19 |
| 4.1 Pre-Installation Safety Instructions | 6 | 8.4 Upgrade Failed | 19 |
| 4.2 Rackmounting Instructions for Console KVMs | 7 | 8.5 Firmware Upgrade Recovery | 20 |
| 4.3 Rackmounting for B022-U16 | 8 | 9. Appendix A | 20 |
| 4.4 Grounding | 8 | 9.1 Specifications | 20 |
| 4.5 Single-Station Installation | 8 | 9.2 OSD Factory Default Settings | 21 |
| 4.6 Multiple-Station (Daisy-Chained) Installation | 8 | 9.3 Keyboard Emulation (Mac & Sun) | 21 |
| 4.7 Multiple Station (Cascaded) Installation | 9 | 10. Appendix B | 22 |
| 4.8 Hot Plugging | 9 | 10.1 FCC Radio/TV Interference Notice | 22 |
| 5. Basic Operation | 9 | 11. Warranty | 22 |
| 5.1 Opening the NetDirector Console KVM | 9 | 12. Warranty Registration | 22 |
| 5.2 Closing the NetDirector Console KVM | 9 | | |
| 5.3 LCD OSD (On-Screen Display) Configuration | 10 | | |
| 5.4 Sharing USB Peripheral Devices | 10 | | |
| 5.5 Powering Off and Restarting | 10 | | |
| 6. Hotkeys | 11 | | |
| 6.1 Invoking the Hotkey Mode | 11 | | |
| 6.2 Port ID Numbering | 11 | | |
| 6.3 Selecting the Active Port | 11 | | |
| 6.4 Auto Scanning | 12 | | |
| 6.5 Starting Auto Scan | 12 | | |
| 6.6 Pausing in Auto Scan | 12 | | |
| 6.7 Skip Mode | 12 | | |
| 6.8 Hotkey Beeper Control | 12 | | |
| 6.9 Computer Keyboard/Mouse Reset | 12 | | |
| 6.10 Quick Hotkey Control | 13 | | |
| 6.11 OSD Hotkey Control | 13 | | |
| 6.12 Port OS Control | 13 | | |
| 6.13 Restore Default Values | 13 | | |
| 6.14 Hotkey Summary Table | 13 | | |

1. Features

- Integrated KVM console with 19" LCD for the B020-U08-19-K, B020-U08-19KTAA and B020-U16-19-K.
- B020-U08-19-K, B020-U08-19KTAA and B020-U16-19-K come with (8) P778-Series USB/PS2 Combo KVM Cable Kits.
- B020-U08-19-K, B020-U08-19KTAA and B020-U16-19-K come with an external console port, allowing an external local console (PS/2 or USB) to be connected. An additional USB port is included on the front panel of the B020-U08-19-K, B020-U08-19KTAA or B020-U16-19-K for use with an external mouse.
- Dual Interface: supports computers with PS/2 or USB keyboards and mice.
- Keyboard and mouse emulation (PS/2 and USB) allows for simultaneous booting of computers even when the console focus is elsewhere.
- External USB port allows for sharing of USB 1.1 peripherals among all ports on the KVM switch*.
- Multiplatform support: supports Windows® (2000, XP, Vista, 7), Linux, Mac® and Sun.
- Supports multimedia USB keyboards for PC, Mac and Sun.
- Daisy-chain up to 31 additional B022-016 or B022-U16 KVM Switches to connect up to 512 computers.
- Daisy-chained station position is automatically sensed—no need for manual DIP switch settings.
- B022-U16 KVM Switches can be cascaded off of B020-008-17-IP and B020-016-17-IP Switches**.
- Station ID LED indicates the switches station position.
- No software required.
- Select a computer via push-buttons, Hotkeys or On Screen Display (OSD) menus.
- Auto-scan feature allows for continuous scanning of multiple computers.
- Hot Pluggable: add/remove computers without powering down the KVM switch.
- Two level password security: only authorized Users can view and control the connected computers. (Up to four Users and one Administrator.)
- Superior video quality: supports resolutions up to 2048 x 1536 for the B022-U16 and 1280 x 1024 for the B020-U08-19-K, B020-U08-19KTAA or B020-U16-19-K.
- Rackmountable in 19" rack system (1U).
- Firmware upgradeable.

*USB 1.1 peripheral sharing function works only when using the USB Cable Kit connections.

**A separate firmware upgrade is required for cascading. (See Firmware Upgrade on Page 18 for details.)

2. System Requirements

2.1 Computer

- A VGA, SVGA or Multisync computer with an HD15 port

Note: The max resolution for the B020-U08-19-K, B020-U08-19KTAA or B020-U16-19-K is 1280 x 1024, and 2048 x 1536 for the B022-U16. The resolutions of the connected computers must not exceed these limits.

Either:

1. A mini DIN 6 (PS/2) keyboard and mouse port.
2. A USB Type-A port.

2.2 Console*

- A VGA, SVGA, or Multisync monitor capable of the highest resolution that you will be using on any system in the installation
- A PS/2 or USB style mouse
- A PS/2 or USB style keyboard

*Optional external console ports are included on the NetDirector Console KVM Switches.

2.3 Cables

This KVM switch requires the following custom-wired premium cables:

| Function | Tripp Lite Part |
|--|---|
| To Connect a PS/2 or USB Computer to the KVM | P778-Series PS/2 or USB Combo KVM Cable Kit |
| Daisy-Chain Cables | P772- Series Daisy-Chain Cables |

2.4 Operating Systems

| OS | Version | OS | Version |
|---------------------------|-----------------|----------------|----------------------|
| Windows | 2000 and higher | UNIX FreeBSD | 4.2 and higher |
| Linux RedHat | 7.1 and higher | UNIX Sun | Solaris 8 and higher |
| Linux SuSE | 9.0 and higher | Novell Netware | 5.0 and higher |
| Linux Mandriva (Mandrake) | 9.0 and higher | Mac | OS 9 and higher |
| UNIX AIX | 4.3 and higher | DOS | 6.22 |

3. Introduction

3.1 Front View of Console KVM Switch

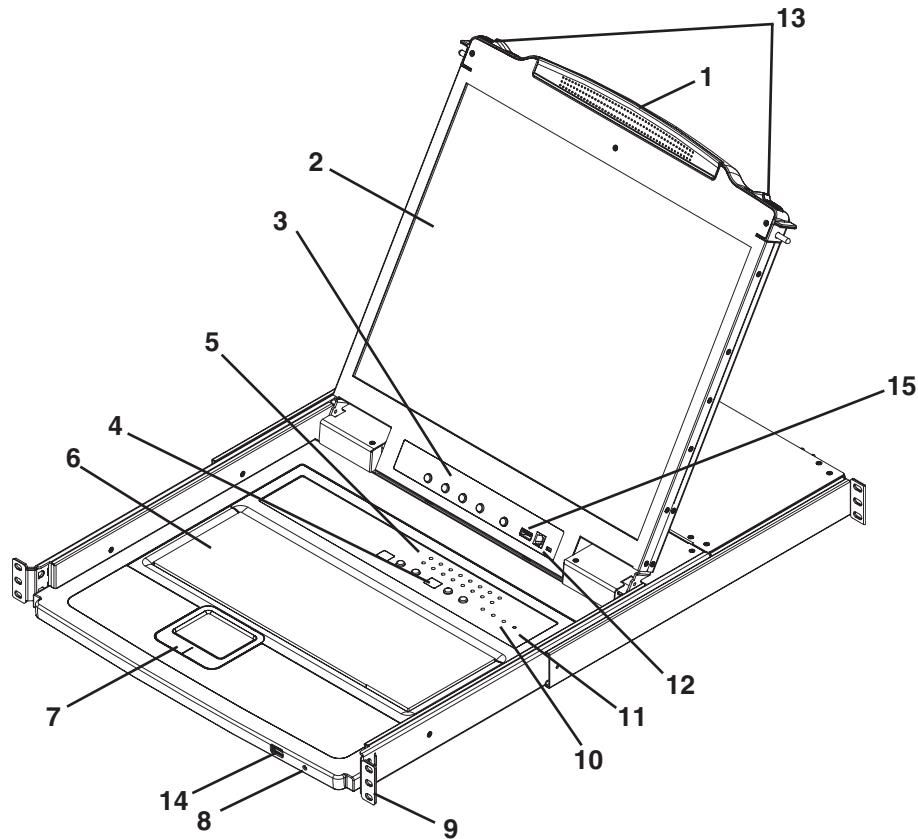

1. Handle

Pull to slide the KVM module out; push to slide the module in (see item 13 in this table).

2. LCD Display

After sliding the KVM module out, flip up the cover to access the LCD monitor.

3. LCD Controls

The LCD On/Off switch is located here, as well as buttons to control the position and picture settings of the LCD display. See page 10 for details.

4. Station/Port Switches

Press the **Port ID** up/down buttons to switch to the port before/after the currently selected port. Press the **Station ID** up/down buttons to switch to the station before/after the currently selected station.

5. LEDs

- **Online Port LEDs** – There are 8 or 16 LEDs (depending on the number of ports) at the top of the key board panel which illuminate orange when a computer is connected and powered-on.
- **Port ID LED** – A numerical LED displays the number of the port which currently has the focus of the KVM switch.
- **Station ID LED** – A numerical LED displays the station number of the KVM switch that currently has the focus of the console.

6. Keyboard

7. Touchpad

8. Power LED

Lights blue to indicate that the unit is receiving power.

9. Rackmounting Tabs

The rackmounting tabs located at each corner of the unit secure the chassis to a system rack. Refer to page 7 for rackmounting details.

10. Lock LEDs

The Num Lock, Caps Lock, Scroll Lock LEDs are located here.

11. Reset Switch

Located to the right of the Lock LEDs. Press this recessed switch in with a thin object to perform a system reset.

12. Firmware Upgrade Section

- **Firmware Upgrade Port:** The Firmware Upgrade Cable that transfers the firmware upgrade data from the Administrator's computer to the Console KVM Switch plugs in here.
- **Firmware Upgrade Switch:** During normal operation this switch should be in the NORMAL position. (See page 18 for firmware upgrading details.)

13. Slide Release

In order to bring the console out, you must first release it by sliding these tabs to the inside. See page 9 for details on sliding the console in and out.

14. External Mouse Port

An additional USB port is provided on the front panel of the keyboard module for an optional external mouse.

15. USB Peripheral Port

A USB 1.1 port is provided for the sharing of USB peripherals among connected computers (e.g. flash drive, CD-ROM drive, etc).

3. Introduction

3.2 Rear View of Console KVM Switch

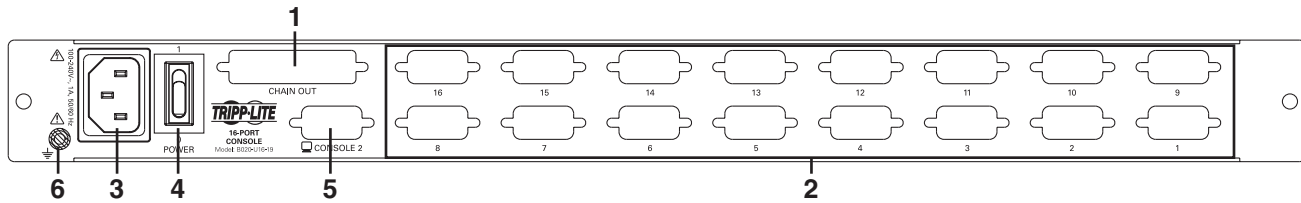

1. Daisy-Chain Port

When daisy chaining units, the cable plugs in here.

2. CPU Port Section

The cables that link to the computers plug in here.

3. Power Socket

This is a standard 3-prong AC power socket. The power cord from an AC source plugs in here.

4. Power Switch

This is a standard rocker switch that powers the unit ON and OFF.

5. External Console Port

This port allows for the optional connection of an external keyboard, mouse and monitor. The included USB/PS2 Combo Console Cable Kit connects to the KVM switch here. Either USB or PS/2 keyboards/mice can be connected.

6. Grounding Terminal

The included grounding wire connects to the KVM switch here.

3.3 Front View of B022-U16

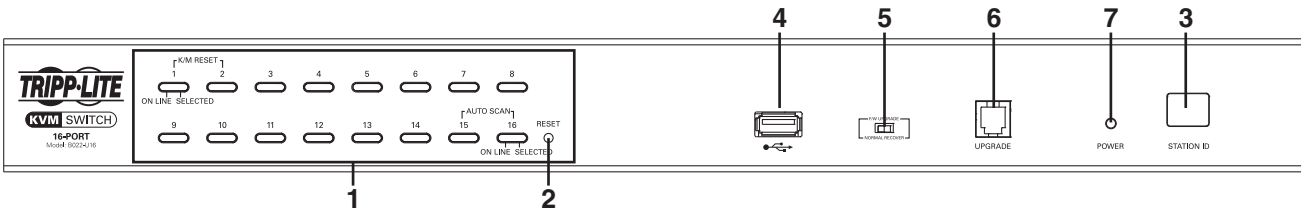

1. Port Push-Buttons/LEDs

There are 16 port selection push-buttons on the front panel, all of which contain an LED.

- Press the push-button of any port to switch the KVM's focus to that port.
- An orange LED illuminates when a computer is connected to the port and powered-on.
- A green LED illuminates when the computer connected to the port has the KVM's focus
- Pressing push-buttons 1 and 2 simultaneously will perform a keyboard and mouse reset.
- Pressing push-buttons 15 and 16 simultaneously will start an Auto Scan (see page 12 for Auto Scan details).

2. Reset Switch

Pressing this switch performs a system reset. This switch is semi-recessed and must be pushed with a thin object, such as the end of a paper clip or a ballpoint pen. Lights turn on to indicate that the KVM is powered up and ready to operate.

3. Station ID LED

The B022-U16's Station ID is displayed here. If this is a Single Station Installation (see page 8), or the first station on a daisy-chained installation (see page 8), the unit has a Station ID of 01. On a daisy-chained installation, the KVM auto-senses its position and displays the Station ID that corresponds to its place in the chain (see *Port ID Numbering*, page 11 for details).

4. USB Peripheral Port

A USB 1.1 port is provided for the sharing of USB peripherals among connected computers (e.g. flash drive, CD-ROM drive, etc).

5. Firmware Upgrade Recovery Switch

During normal operation and while performing a firmware upgrade, this switch should be in the NORMAL position. In the event of a firmware upgrade failure, this switch is set to RECOVER to perform a firmware upgrade recovery (see page 20 for firmware upgrade recovery details).

6. Firmware Upgrade Port

The cable used to perform a firmware upgrade connects to the KVM switch here.

7. Power LED

This LED illuminates when the KVM switch is powered ON.

3. Introduction

3.4 Rear View of B022-U16

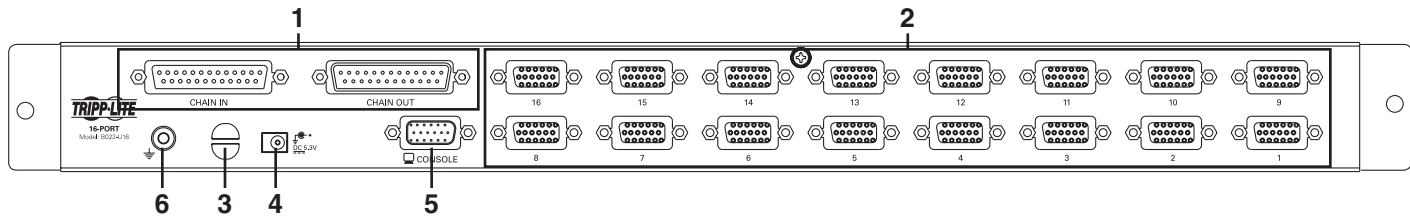

1. Daisy-Chain Port

- **Daisy-Chain In Port** – When daisy-chaining additional KVM switches, the daisy-chain cable from the previous KVM switch in the chain connects here. This port is not used if the KVM switch occupies the first spot in a daisy-chain, or in a single-stage installation.
- **Daisy-Chain Out Port** – When daisy-chaining additional KVM switches, the daisy-chain cable connects this port to the Daisy-Chain In Port on the next KVM switch in the chain.

2. CPU Port Section

Plug the KVM cable for each computer into these ports.

3. Cable Management Slot

A cable tie can be used to gather the cables together and then be tied to this slot to help manage the cables.

4. Power Port

The power adapter cable plugs into this port.

5. Console Port

The included USB/PS2 Combo Console Cable Kit connects to the KVM switch here. A VGA monitor and either USB or PS/2 keyboards/mice can be connected to the cable kit.

6. Grounding Terminal

The included grounding wire connects to the KVM switch here.

4. Installation

4.1 Pre-Installation Safety Instructions

Read all of these instructions and save them for future reference.

General Safety Instructions

- Follow all warnings and instructions marked on the device.
- Do not place the device on any unstable surface (cart, stand, table, etc.). If the device falls, serious damage will result.
- Do not use the device near water.
- Do not place the device near, or over, radiators or heat registers.
- The device cabinet is provided with slots and openings to allow for adequate ventilation. To ensure reliable operation, and to protect against overheating, these openings must never be blocked or covered.
- The device should never be placed on a soft surface (bed, sofa, rug, etc.) as this will block its ventilation openings. Likewise, the device should not be placed in a built in enclosure unless adequate ventilation has been provided.
- Never spill liquid of any kind on the device.
- Unplug the device from the wall outlet before cleaning. Do not use liquid or aerosol cleaners. Use a damp cloth for cleaning.
- The device should be operated from the type of power source indicated on the marking label. If you are not sure of the type of power available, consult your dealer or local power company.
- The device is designed for IT power distribution systems with up to 230V phase-to-phase voltage.
- To prevent damage to your installation it is important that all devices are properly grounded.
- The device is equipped with a 3-wire grounding type plug. This is a safety feature. If you are unable to insert the plug into the outlet, contact an electrician. Do not attempt to defeat the purpose of the grounding-type plug. Always follow your local/national wiring codes.
- Do not allow anything to rest on the power cord or cables. Route the power cord and cables so that they cannot be stepped on or tripped over.
- If an extension cord is used with this device make sure that the total of the ampere ratings of all products used on this cord does not exceed the extension cord ampere rating. Make sure that the total of all products plugged into the wall outlet does not exceed 15 amperes.
- To protect against circuit overloading, you should plug your KVM switch and connected computers into a Tripp Lite SmartPro® or SmartOnline™ UPS System.
- Position system cables and power cables carefully, making sure that nothing rests on any cables.
- Never push objects of any kind into or through cabinet slots. They may touch dangerous voltage points or short out parts resulting in a risk of fire or electrical shock.
- Do not attempt to service the device yourself. Refer all servicing to qualified service personnel.

4. Installation

4.1 Pre-Installation Safety Instructions (continued)

- If the following conditions occur, unplug the device from the wall outlet and bring it to qualified service personnel for repair:
 - The power cord or plug has become damaged or frayed.
 - Liquid has been spilled into the device.
 - The device has been exposed to rain or water.
 - The device has been dropped, or the cabinet has been damaged.
 - The device exhibits a distinct change in performance, indicating a need for service.
 - The device does not operate normally when the operating instructions are followed.
- Only adjust those controls that are covered in the operating instructions. Improper adjustment of other controls may result in damage that will require extensive work by a qualified technician to repair.
- Do not connect the RJ-11 connector marked “UPGRADE” to a public telecommunication network.
- Use of this equipment in life support applications where failure of this equipment can reasonably be expected to cause the failure of the life support equipment or to significantly affect its safety or effectiveness is not recommended. Do not use this equipment in the presence of a flammable anesthetic mixture with air, oxygen or nitrous oxide.

Rack Mounting Safety Instructions

- Before working on the rack, make sure that the stabilizers are secured to the rack, extended to the floor, and that the full weight of the rack rests on the floor. Install front and side stabilizers on a single rack or front stabilizers for joined multiple racks before working on the rack.
- Always load the rack from the bottom up, and load the heaviest item in the rack first.
- Make sure that the rack is level and stable before extending a device from the rack.
- Use caution when pressing the device rail release latches and sliding a device into or out of a rack; the slide rails can pinch your fingers.
- After a device is inserted into the rack, carefully extend the rail into a locking position, and then slide the device into the rack.
- Do not overload the AC supply branch circuit that provides power to the rack.
- The total rack load should not exceed 80 percent of the branch circuit rating.
- Make sure that all equipment used on the rack (including power strips and other electrical connectors) is properly grounded.
- Ensure that proper airflow is provided to devices in the rack.
- Ensure that the operating ambient temperature of the rack environment does not exceed the maximum ambient temperature specified for the equipment by the manufacturer.
- Do not step on or stand on any device when servicing other devices in a rack

4.2 Rackmounting Instructions for Console KVMs

The NetDirector Console KVM Switch is designed for mounting in a 1U rack system. For convenience, a rack mounting kit is included with your KVM for quick installation. The various mounting options are explained in the sections that follow:

Note:

1. It is recommended that the unit be installed by two people; one to hold it in place and the other to attach it to the rack.
2. The rackmounting kit that comes with the unit does not include screws or cage nuts. Contact your rack dealer for this hardware.
3. Allow at least 5.1 cm on each side for proper ventilation, and at least 12.7 cm at the rear of the unit for the power cord and cable kits.

Standard Rackmounting

- 1 Slide out the rear mounting brackets from the console and mount both brackets (separate from the console) to the inside rear of a standard 1U rack system using user-supplied screws.
- 2 Take the console and gently slide it into the two rear-mounted brackets in the rack and secure the console in place by inserting user-supplied screws.

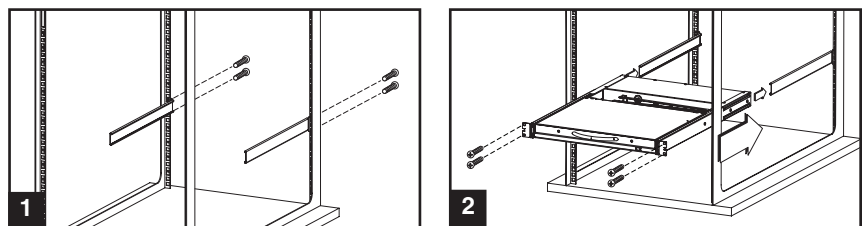

2-Post Rackmounting

The NetDirector Console KVM Switch can also be mounted in a 2-post rack installation using the optional 2-Post Rackmount Kit (model: B019-000). The mounting hardware allows for the console to be opened with the drawer in any position. Heavy-duty 14-gauge steel provides stability and prevents the console frame from twisting. See the B019-000 instructional manual for detailed mounting instructions.

4. Installation

4.3 Rackmounting for B022-U16

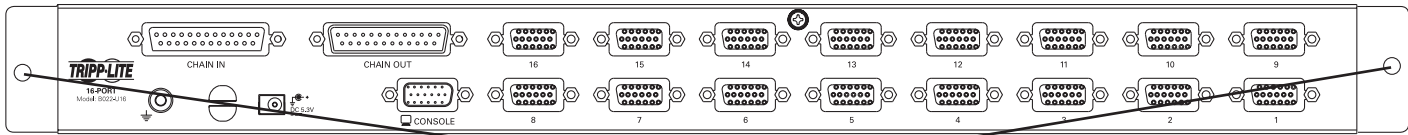

Fasten the rackmount brackets to the rack using user-supplied screws to install in a rack.

4.4 Grounding

To prevent damage to your installation it is important that all devices are properly grounded. Use the included grounding wire to ground the KVM switch by connecting one end of the wire to the grounding terminal on the unit, and the other end of the wire to a suitably grounded object.

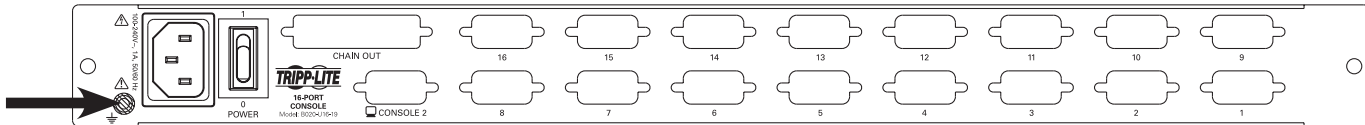

4.5 Single-Station Installation

1. Ensure that power to all the devices to be connected has been turned OFF.
2. Connect the included USB/PS2 Combo Console Cable Kit to the console connector on the back of the unit, and then connect a monitor, mouse and keyboard to the appropriate connectors on the cable kit. The distance between the external console and the KVM switch must not exceed 66 ft (20 m). Note: This step is mandatory for B022-U16 KVM switches, but is optional for Console KVM Switches.
3. Use a P778-Series USB/PS2 Combo KVM Cable Kit to connect each CPU port to a computer/server. The distance between the KVM switch and each connected computer must not exceed 33 ft (10 m).
4. Plug the power cord or power adapter cable into the KVM's power jack, then plug into a UPS, surge or other AC power source. Turn on the power switch for the console KVM. (Not required for the B022-U16.)
5. Turn on the power to the computers.

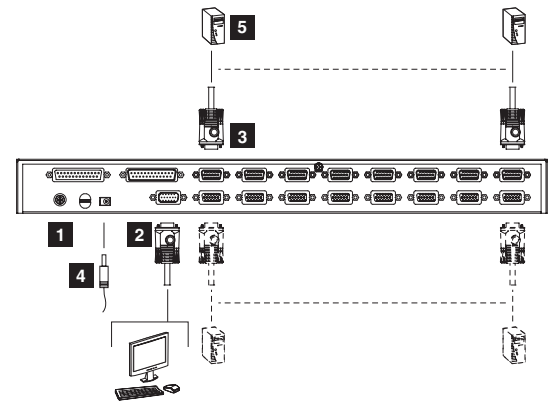

4.6 Multiple Station (Daisy-Chained) Installation

To control even more computers, up to 31 B022-016 or B022-U16 KVM Switches can be daisy-chained down from the first station.

Note: As many as 512 computers can be controlled from the unit's integrated console in a complete installation.

To set up a daisy-chained installation:

1. Ensure that power to all the devices to be connected has been turned OFF.
2. Use a daisy-chain cable (described in the *Cables* section, page 3) to connect the *Chain Out* port of the parent unit to the *Chain In* port of the child unit. The distance between any two KVM switches in a daisy-chain must not exceed 49 ft (15 m). The distance between the first KVM switch and the last KVM switch in a daisy-chain must not exceed 328 ft (100 m), regardless of the number of KVM switches in the entire chain.
3. Use a KVM cable kit (described in the *Cables* section, page 3) to connect the keyboard, video and mouse ports of a computer to any available port on the KVM switch. The distance between the KVM switch and each connected computer must not exceed 33 ft (10 m).
4. Repeat the above steps for any additional KVM switches you wish to add to the chain.
5. Power up the installation according to the following procedure:
 - a. Plug in the power adapter for the first station. Wait a few seconds to allow the unit to determine its Station ID.
 - b. Plug in the power adapters for each subsequent station in the installation in turn (ie. second station, then third station, etc.). Each KVM switch has an LED display on its front panel to indicate its Station ID (the Station ID for the first station is **01**, the ID for the second station is **02**, the ID for the third station is **03**, etc.).

In each case, wait for the Station ID to be displayed on the Station ID LED before plugging in the next station.

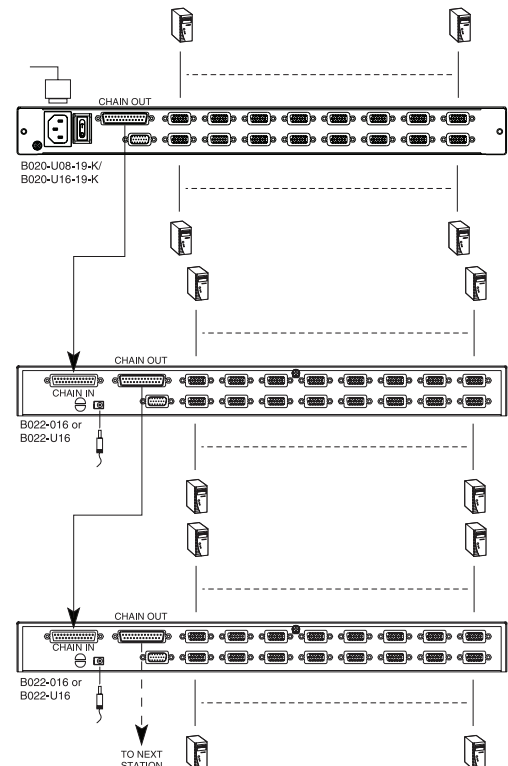

4. Installation

4.7 Multiple Station (Cascaded) Installation

The B022-U16 KVM Switch can be cascaded off of a B020-008-17-IP or B020-016-17-IP Console KVM Switch to expand the number of connected computers. Before you can start a cascaded installation, you must upgrade the B022-U16 firmware to be cascade compatible. (See Firmware Upgrade on page 18 for details.) For cascaded installation details, see the owner's manual of the B020-008-17-IP or B020-016-17-IP Console KVM Switch.

4.8 Hot Plugging

All KVM switches support hot plugging—components can be removed and added back into the installation by unplugging their cables from the ports without having to shut the switch down. However, in order for hot plugging to work properly, these procedures must be followed:

Switching Station Positions

Switch station positions by simply unplugging the daisy-chain cable from the old parent and plugging into a new one. After you do, in order for the OSD menus to correspond to the change, you must reset the Station IDs via the OSD. See page 17 for details.

Hot Plugging CPU Ports

Switch CPU ports by unplugging the KVM cable kit and replugging into the desired port. In order for the OSD menus to correspond to the change made, you must manually reconfigure the OSD information for the new port. See the *F3 SET* (page 15) and *F4 ADM* (page 16), functions for details.

Note: If the computer's Operating System does not support hot plugging, this function may not work properly.

Hot Plugging Console Ports

Keyboard, monitor, and mouse can all be hot plugged. When hot plugging the mouse:

1. You may unplug the mouse and plug it back in again (to reset the mouse, for example), as long as you use the *same* mouse.
2. If you plug in a different mouse, all the stations and all the computers on the installation must be shut down for 10 seconds, then restarted using the Power Up Sequence described on page 8.

5. Basic Operation

5.1 Opening the NetDirector Console KVM

The console is located under the top cover. To access the console, slide the console module out and raise the cover.

Note: As a safety precaution, to keep the console from accidentally sliding out, the console is locked into the in position. Before you can pull the console module out, you must release it by pushing the catches on the unit's front panel toward the center of the switch.

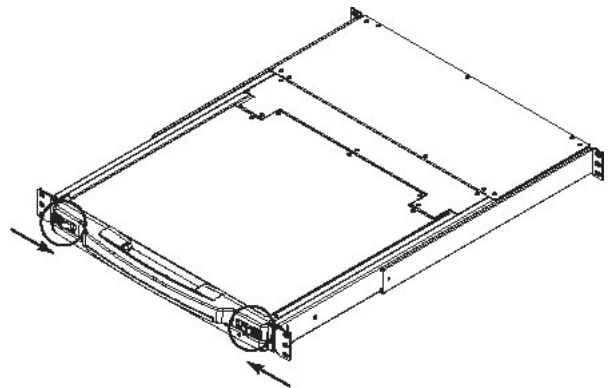

5.2 Closing the NetDirector Console KVM

To slide the console module back in, close the cover and do the following:

1. Pull the safety catches on the unit's side rails toward you and push the module in until it stops.
2. Release the catches; pull the module slightly toward you; then push it all the way in.

Note: The reason for the two-step procedure is to minimize the chances of pinching your fingers when sliding the module in.

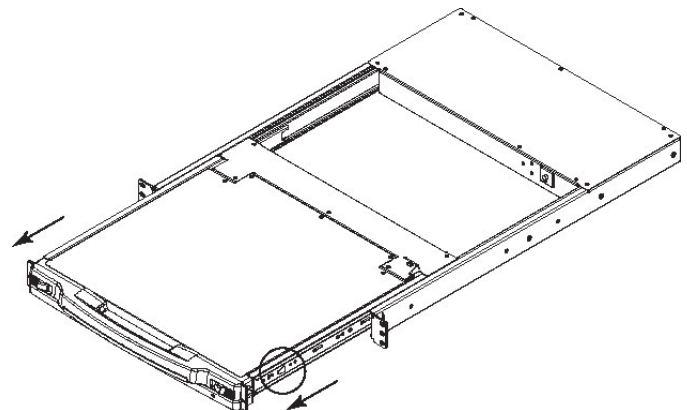

5. Basic Operation

5.3 LCD OSD (On-Screen Display) Configuration

The LCD OSD allows you to set up and configure the LCD display:

- To open up the LCD OSD main menu, press the button marked *Menu*.
- Use the ◀|▼ and ▶|▲ buttons to navigate and make adjustments. After navigating to a setting choice, use the *Menu* button to bring up the adjustment screen.
- When making adjustments, ▶|▲ increases the value; ◀|▼ decreases the value.
- When satisfied, press *Exit* to return to the OSD main menu.
- When all adjustments have been made, press *Exit* to close the LCD OSD.



The following is an explanation of the settings:

| | |
|--------------------------|---|
| Brightness | Adjusts the background black level of the screen image. |
| Contrast | Adjusts the foreground white level of the screen image. |
| Phase | Adjusts the vertical size of the screen image. |
| Clock | Adjusts the horizontal size of the screen image. |
| H-Position | Positions the display area on the LCD panel horizontally (moves the display area left or right). |
| V-Position | Positions the display area on the LCD panel vertically (moves the display area up or down). |
| Color Temperature | Adjusts the color quality of the display between three pre-configured settings; 6500k, 7500k, 9300k. This menu also allows you to customize the individual RGB settings to your preference. |
| Language | Selects the language that the OSD displays its menus in. |
| OSD Duration | Adjust the length of inactivity before the OSD display turns off (between 5 and 100 minutes). The default is 5 minutes. |
| Reset | Resets all of the adjustments in the LCD OSD menus to their factory default settings. |

Note: Pressing the Exit button while not in the LCD OSD Menu will perform an auto-configuration on the monitor.

5.4 Sharing USB Peripheral Devices

The USB 1.1 port on the Console KVM Switch's LCD panel and the B022-U16 front panel can be used to share USB peripherals between connected computers. Simply connect a USB peripheral device to this port, and any connected computer you switch to will have access to the device.

Note: The following limitations apply to the USB peripheral port:

1. This port serves as a 1 port USB 1.1 hub; USB 2.0 devices will not function as designed.
2. USB peripherals can only be shared among computers that are connected to the KVM switch via the USB connectors on the P778-Series USB/PS2 Combo KVM Cable Kit.
3. USB peripherals can only be shared among computers that are connected to the KVM switch that the USB peripheral is plugged into. Computers that are connected to daisy-chained KVM switches will not have access to the USB peripheral device.

5.5 Powering Off and Restarting

If it becomes necessary to power OFF the KVM switch, follow the procedure below:

1. Shut down all computers connected to the KVM switch. If you are powering OFF a daisy-chain installation, shut down all computers connected to each KVM switch in the installation. *Note: It is necessary to unplug any computers that have the Keyboard Power ON function. If left on, the KVM switch will continue to receive power via these computers.*
2. Turn OFF the KVM switch (Console KVM only) and unplug the KVM switch from its power source. Power OFF and unplug each KVM switch in the daisy-chain succession.
3. Wait 10 seconds and then plug the KVM switch, starting with the first station, back into its power source. Turn ON the power to the KVM switch (Console KVM only).
4. Once the first station KVM switch has ascertained its position in the daisy-chain, power ON and plug in the next KVM switch in the installation. Follow this procedure for each KVM switch in the installation.
5. Once all KVM switches in the installation have been powered back ON, turn on the power to all connected computers.

6. Hotkeys

NetDirector KVM Switches can be easily operated using hotkey commands. This chapter discusses the available hotkeys and their functions. Below is a list of the various hotkeys, broken up into hotkeys for port control and hotkeys that perform other functions.

Port Control Hotkeys

- Selecting the active port
- Auto Scan Mode port switching
- Skip Mode port switching

Other Hotkeys

- Computer keyboard and mouse reset
- Setting the Beeper
- Setting the Quick Hotkey
- Setting the OSD Hotkey
- Setting the Port Operating System
- Restoring the OSD default values

6.1 Invoking the Hotkey Mode

All hotkey operations begin by invoking Hotkey Mode. In order for Hotkey Mode to work, it must be activated in the KVM's OSD; it is activated by default. (See page 16 for details on OSD hotkey activation.) There are two sequences that can be used to invoke Hotkey Mode, both of which are explained below. You can toggle between these two sequences using the OSD. (See page 15 for details on switching the Hotkey Mode invocation sequence.) The **[Num Lock]** and **[-]** Minus keys are the default invocation keys.

Num Lock and Minus (-) keys

1. Press and hold down the **[Num Lock]** key.
2. While the **[Num Lock]** key is held down, press and release the **[-]** Minus key.
3. After releasing the **[-]** Minus key, release the **[Num Lock]** key.

Control and F12 keys

1. Press and hold down the **[Ctrl]** key.
2. While the **[Ctrl]** key is held down, press and release the **[F12]** key.
3. After releasing the **[F12]** key, release the **[Ctrl]** key.

When Hotkey Mode has been invoked:

- The monitor goes blank and the hotkey command line is displayed. This is where you will enter in the hotkey commands described in this chapter.
- The **[Caps Lock]** and **[Scroll Lock]** icons will blink in succession.
- Ordinary keystrokes will be suspended until Hotkey Mode is exited. Hotkey Mode is exited by performing a hotkey command or by pressing the **[Esc]** or **[Spacebar]** keys.

6.2 Port ID Numbering

Each CPU port in an installation is assigned a unique Port ID. The Port ID is made up of two parts: a *Station Number*, and a *Port Number*:

- The *Station Number* is a two-digit number that identifies the switch's position in the daisy-chain sequence. This corresponds to the number displayed on the front panel Station ID LED.
- The *Port Number* is a two-digit number which identifies the port number that the computer is connected to.
- The Station Number precedes the Port Number.
- Station and Port Numbers are always 2 digits, so 1 - 9 becomes 01 - 09. Eg., a computer attached to **Port 7** of **Station 15** has a Port ID of **15-07**.

6.3 Selecting the Active Port

You can directly access a port by doing the following:

- 1) Invoke Hotkey Mode.
- 2) Enter the Port ID.
The Port ID numbers appear on the command line as they are entered. To correct a mistake, use **[Backspace]** to erase the wrong number.
- 3) Press **[Enter]**.
Once **[Enter]** has been pressed, the KVM switches to the designated computer and you automatically exit the Hotkey Mode.

6. Hotkeys

6.4 Auto Scanning

Auto Scan allows the connected computers to be monitored automatically, without having to manually toggle between ports. When in Auto Scan Mode, the KVM switch switches through each accessible port at fixed intervals. Only ports that the currently logged-in User has been give access to will be scanned. The default interval is 5 seconds. (See page 15 for details on changing the scan interval.)

6.5 Starting Auto Scan

To start Auto Scanning:

- 1) Invoke Hotkey Mode.
- 2) Key in **[A]** and hit **Enter**. You automatically exit Hotkey Mode and enter Auto Scan Mode.
- 3) An autoscan can be paused at any time (see below).
- 4) To exit Auto Scan Mode, press **[Esc]** or **[Spacebar]**.

Note: While Auto Scan Mode is in effect, ordinary keyboard and mouse functions are suspended - only Auto Scan Mode compliant keystrokes and mouse clicks can be input. You must exit Auto Scan Mode in order to regain normal control of the console.

6.6 Pausing in Auto Scan

While in Auto Scan Mode, the scan can be paused in order to keep the focus on a particular computer either by pressing **P** or with a left click of the mouse. During the time that Auto Scanning is paused, the command line displays: **Auto Scan: Paused**.

In many cases *Pausing* is more convenient than *Exiting* the Auto Scan Mode because when you *Resume* scanning while in *Pause*, you start from where you left off. If you *Exited* and restarted, scanning would start from the very first computer on the installation.

To resume Auto Scanning, press any key or left click. Scanning continues from where it left off.

6.7 Skip Mode

This feature allows you to manually sequence between computers in order to monitor them. This manual version of the Auto Scan Mode lets you dwell on a particular port for as long as you like. To invoke Previous/Next Switching:

- 1) Invoke Hotkey Mode.
- 2) Key in **[Arrow]** refers to any of the arrow keys on the keyboard. After you press **[Arrow]**, you automatically exit Hotkey Mode, and enter Skip Mode where you can switch ports as follows:
 - ←Skips from the current port to the first accessible port previous to it.
 - Skips from the current port to the next accessible port.
 - ↑Skips from the current port to the last accessible port of the previous station.
 - ↓Skips from the current port to the first accessible port of the next station.
- 3) To exit Skip Mode, press **[Esc]**.

Note: 1. Once Skip Mode has been invoked, until you exit, you can keep on skipping simply by pressing an Arrow key.

2. While Skip Mode is in effect, ordinary keyboard and mouse functions are suspended—only Skip Mode compliant keystrokes can be input. You must exit Skip Mode in order to regain normal control of the console.

6.8 Hotkey Beeper Control

The Beeper can be turned ON/OFF via Hotkey or the OSD (see pages 14-18 for OSD details).

To toggle the Beeper, key in the following hotkey combination:

- 1) Invoke Hotkey Mode with the **[Num Lock] + [-]** combination.
- 2) Key in **[B]**.

After you press **[B]**, the Beeper toggles ON or OFF. The command line displays *Beeper On* or *Beeper Off* for one second; then the message disappears and you automatically exit Hotkey Mode.

6.9 Computer Keyboard/Mouse Reset

If the keyboard or mouse ceases to function for a particular port, you can perform a keyboard/mouse reset via the hotkey command below. This performs the same function as unplugging/replugging the keyboard and mouse on the connected computer. To perform a keyboard/mouse reset, do the following:

1. Invoke Hotkey Mode.
2. Press the **[F5]** key.

After pressing the **[F5]** key, you exit Hotkey Mode and the KVM switch performs a keyboard/mouse reset for the currently selected computer. (This may take a few seconds to take affect.) If you fail to regain keyboard/mouse control, perform a system reset. (See page 10 for details on performing a system reset.)

6. Hotkeys

6.10 Quick Hotkey Control

The hotkey sequence to invoke Hotkey Mode can be toggled via hotkey command as well as OSD. (See page 15 for changing the Hotkey Mode invocation sequence via OSD.) To toggle the invocation sequence between **[Num Lock, Minus]** and **[Ctrl, F12]**, do the following:

1. Invoke Hotkey Mode.
2. Press the **[H]** key.

After pressing the **[H]** key, the Hotkey Mode invocation sequence is changed and the text **HOTKEY HAS BEEN CHANGED** briefly appears on the monitor. Hotkey Mode is then exited and you regain normal operation of the KVM switch.

6.11 OSD Hotkey Control

The hotkey sequence to invoke the OSD can be toggled via hotkey command as well as OSD. (See page 14 for changing the OSD invocation sequence via OSD.) To toggle the invocation sequence between **[Scroll Lock, Scroll Lock]** and **[Ctrl, Ctrl]**, do the following:

1. Invoke Hotkey Mode.
2. Press the **[T]** key.

After pressing the **[T]** key, the OSD invocation sequence is changed and the text **HOTKEY HAS BEEN CHANGED** briefly appears on the monitor. Hotkey Mode is then exited and you regain normal operation of the KVM switch.

6.12 Port OS Control

In addition to choosing the Operating System for a connected port via the OSD (see page 17 for details), the Administrator can set the Operating System via hotkey command. To change a ports Operating System via hotkey, do the following:

1. Invoke Hotkey Mode.
2. Key in **[Function]**, where **[Function]** represents one of the following:
 - a. **[F1]** – Sets the Operating System to Windows.
 - b. **[F2]** – Sets the Operating System to Mac.
 - c. **[F3]** – Sets the Operating System to Sun.

After pressing one of these keys, the Operating System will be changed for the selected port and you will exit Hotkey Mode.

6.13 Restore Default Values

This Administrator-ONLY hotkey restores the KVM switch to its default values. (See page 17 for details on restoring the KVM default values via OSD.) To restore the default values via hotkey, do the following:

1. Invoke Hotkey Mode.
2. Press the **[R]** key.
3. Hit the **[Enter]** key.

After hitting the **[Enter]** key, the text **RESET TO DEFAULT SETTING** is briefly displayed, and then Hotkey Mode is exited.

6.14 Hotkey Summary Table

Note: All of the hotkey commands in this table require Hotkey Mode to be invoked to function. (See page 11 for details on invoking Hotkey Mode.)

| Hotkey Command | Function |
|--|--|
| [Station, ID], [Port ID], [Enter] | Switches the focus of the KVM to the computer connected to the Port ID entered (see page 11 for details on Port ID numbering). |
| [A], [Enter] or [Q], [Enter] | Starts Auto Scan Mode. When Auto Scan Mode is in effect, hitting the [P] key or left-clicking pauses the scan. Pressing any key resumes the scan. |
| [B] | Turns the Beeper sound ON/OFF. |
| [Esc] or [Spacebar] | Exits Hotkey Mode. |
| [F1] | Sets the Operating System of the selected port to Windows (Administrator-only). |
| [F2] | Sets the Operating System of the selected port to Mac (Administrator-only). |
| [F3] | Sets the Operating System of the selected port to Sun (Administrator-only). |
| [F5] | Performs a keyboard/mouse reset for the computer connected to the selected port. |
| [H] | Toggles between the [Num Lock, Minus] and [Ctrl, F12] Hotkey Mode invocation sequences. |
| [R], [Enter] | Restores the KVM switches default values (Administrator-only). |
| [T] | Toggles between the [Scroll Lock, Scroll Lock] and [Ctrl, Ctrl] OSD invocation sequences. |
| [←] | Invokes Skip Mode and skips from the current port to the previous accessible port. |
| [→] | Invokes Skip Mode and skips from the current port to the next accessible port. |
| [↑] | Invokes Skip Mode and skips to the last accessible port on the previous station. |
| [↓] | Invokes Skip Mode and skips to the first accessible port on the next station. |

7. OSD (On-Screen Display) Operation

7.1 OSD Overview

The On-Screen Display (OSD) is a text-based interface that allows for control and administration of the KVM switch. When logging onto the KVM switch, the OSD Main Menu is the first screen you will see after entering your username and password.

7.2 Logging In For The First Time

The KVM switch features a two-level security, with one Administrator and four User accounts. If you are an Administrator accessing the KVM switch for the first time, leave the username and password field blank and hit the **[Enter]** key twice to access the OSD Main Menu. Once logged into the KVM switch as Administrator, you will be able to access all OSD features and customize KVM settings. At this point, it is highly recommended that you change the Administrator username and password.

7.3 OSD Invocation Sequence

Once logged into the KVM switch, you will need to use one of two sequences to open the OSD Main Menu; **[Scroll Lock, Scroll Lock]** or **[Ctrl, Ctrl]**. The default OSD invocation sequence is **[Scroll Lock, Scroll Lock]**. *Note: When using the [Scroll Lock, Scroll Lock] OSD invocation sequence, you must hold down the [Fn] key, as the [Scroll Lock] key is part of the [Num Lock] key.*

When you invoke the OSD, a screen similar to the one above appears:

- Note:* 1. The diagram depicts the Administrator's Main Screen. The User Main Screen does not have the F4 and F6 functions, since they can't be accessed by ordinary Users and are reserved for the Administrator.
- OSD always starts in List view, with the highlight bar at the same position it was when it was last closed.
 - Only the ports that have been set accessible by the Administrator for the currently logged in User are visible (see *SET ACCESSIBLE PORTS*, page 16, for details).
 - If the port list is collapsed into stations, simply click on the plus sign next to the desired station number, or highlight the desired station number and hit the **[Enter]** key.

| | | | | |
|---------------|--------|--------|---------------|----|
| F1:GOTO | F3:SET | F5:SKP | F7:SCAN | X |
| F2:LIST | F4:ADM | F6:BRC | F8:LOUT | zZ |
| ADMINISTRATOR | | | | |
| LIST:ALL | | | | |
| SN.PN | QV | * | NAME | |
| 02 • 14 | | | ABC COMP1 | ▲ |
| 02 • 15 | ◀ | * | ABC COMP2 | ▲ |
| 02 • 16 | | * | ABC COMP3 | |
| 03 • 01 | | | WEB SERVER 1 | |
| 03 • 02 | | | WEB SERVER 2 | |
| 03 • 03 | ◀ | * | FAX SERVER 1 | |
| 03 • 04 | | * | FAX SERVER 2 | |
| 03 • 05 | ◀ | * | MAIL SERVER 1 | ▼ |

7.4 OSD Navigation

- To close the menu and deactivate OSD, click the **[X]** at the upper right corner of the OSD Window; or press **[Esc]**.
- To logout, press **[F8]**, or click **F8**, on the OSD Menu Bar or click the **zZ** symbol at the upper right hand corner of the OSD Screen.
- To move up or down one line at a time, click the Up and Down Triangle symbols (▼ ▲) or use the Up and Down Arrow Keys. If there are more entries than appear on the screen, the screen will scroll.
- To move up or down one screen at a time, click the Up and Down Arrow symbols (▲▼), or use the **[Pg Up]** and **[Pg Dn]** keys. If there are more entries than appear on the screen, the screen will scroll.
- To activate a port, double-click it, or move the Highlight Bar to it then press **[Enter]**.
- After executing any action, you automatically go back to the menu one level above.

7.5 OSD Main Screen Headings

| Heading | Explanation |
|---------|---|
| SN | The station number of each KVM in the installation will be displayed in this column. The station number of each KVM switch will be displayed as an expandable folder, which can be expanded to show all of the KVM ports in the station, or collapsed to hide them. |
| PN | The port numbers of each KVM in the installation are displayed in this column. If the individual stations are collapsed, their port numbers will not be displayed. |
| QV | An arrow in this column indicates that the corresponding port is selected for Quick View scanning (see <i>Set Quick View Ports</i> , page 17). |
| * | A Sun symbol in this column indicates that the corresponding computer is both powered ON and On Line. |
| NAME | If a port has been given a name (see <i>Edit Port Names</i> , page 16), its name appears in this column. |

7. OSD (On-Screen Display) Operation

7.6 OSD Functions

OSD functions allow the KVM to be controlled and configured via the OSD. Using these functions you can quickly jump to a port on the installation, start an auto scan, limit the port list that displays when you access the OSD, create/edit port names, etc. To access any of the OSD functions, simply click on their corresponding function number at the top of the OSD or hit their corresponding function number on the keyboard. When in the OSD function submenus, simply hit the **[Esc]** key to exit and return to the previous menu.

F1 Go To (GOTO)

Click the **F1** field or press **[F1]** to activate the GOTO function. GOTO allows you to switch directly to a port either by keying in the port's *Name*, or its *Port ID*.

- To use the Name, enter **[1]**; key in the port's Name; then press **[Enter]**.
- To use the Port ID, enter **[2]**; key in the *Port ID*; then press **[Enter]**.

Note: A partial Name or Port ID can be entered. The screen will show all the computers that match the Name or Port ID pattern AND that the User is allowed to access.

To return to the OSD Main Menu without making a choice, press **[Esc]**.

F2 List Ports (LIST)

This function lets you tailor the list of ports the OSD will display on the Main Screen. The submenu choices and their meanings are given in the table below:

| Choice | Description |
|--------------------|---|
| ALL | Lists all of the ports on the installation that are accessible to the logged-on User. |
| POWERED ON | Lists all of the ports on the installation that are accessible to the logged-on User AND powered ON. |
| QVIEW | This is an Administrator-ONLY option. When selected, it will display only the ports that have been marked as Quick View ports. |
| QVIEW + POWERED ON | This is an Administrator-ONLY option. When selected, it will display only the ports that have been marked as Quick View ports AND are powered ON. |

Move the Highlight Bar to the desired choice and press **[Enter]**. An icon appears next to the choice to indicate that it is currently selected.

F3 Set Environment (SET)

This function allows each User and the Administrator to set up their own working environment. A separate profile for each is stored by the OSD and is activated according to the username that was provided during login.

To change a setting:

- 1) Double-click the item; or move the highlight bar to it and press **[Enter]**.
- 2) After you select an item, a submenu with more choices will appear. To make a selection, either double-click a choice or move the Highlight Bar to the desired place and press **[Enter]**. An icon will appear beside the selected choice to identify it. The settings are explained in the following table:

| Setting | Function |
|--------------------------|--|
| OSD HOTKEY | Select the hotkey that activates the OSD function: use either [Scroll Lock] [Scroll Lock] or [Ctrl] [Ctrl] . Since the [Ctrl] key combination may conflict with programs running on the computers, the default is the [Scroll Lock] combination. |
| PORT ID DISPLAY POSITION | Position the Port ID identifier anywhere on the screen. The default is the upper right corner. Use the Mouse or the Arrow Keys plus [Pg Up] , [Pg Dn] , [Home] , [End] , and [5] (on the numeric keypad with [Num Lock] off), to position the Port ID display, then double-click or press [Enter] to lock the position and return to the set submenu. <i>Note: The position for the ID identifier is set independently for each port on the installation; the choice specified here only applies to the port that is currently active.</i> |
| PORT ID DISPLAY DURATION | This selection gives you the option of displaying the Port ID for 3 seconds, or having the Port ID always off. The default is to display for 3 seconds. |
| PORT ID DISPLAY MODE | Select how the Port ID is displayed: the Port Number alone (PORT NUMBER); the Port Name alone (PORT NAME); or the Port Number plus the Port Name (PORT NUMBER + PORT NAME). The default is (PORT NUMBER + PORT NAME). |
| SCAN DURATION | Determine how long each port is connected as the KVM cycles through the ports in Auto Scan Mode (see F7 SCAN page 18). Key in a value from 1 - 255 seconds, then press [Enter] . The default is 5 seconds; a setting of 0 (zero) disables the Auto Scan Function. |

7. OSD (On-Screen Display) Operation

7.6 OSD Functions

| Setting | Function |
|---------------------|---|
| SCAN/SKIP MODE | Select which ports will be accessed during Auto Scan and Skip Modes. Choices are: <ul style="list-style-type: none"> • ALL – All accessible ports in the installation will be accessible in Auto Scan and Skip Modes. • POWERED ON – All ports that are accessible AND powered on will be accessible in Auto Scan and Skip Modes. • QUICK VIEW – This is an Administrator-ONLY option. When selected, only ports that are set as Quick View ports will be accessible in Auto Scan and Skip Mode. • QUICK VIEW + POWERED ON – This is an Administrator-ONLY option. When selected, only ports that are set as Quick View ports AND powered on will be accessible in Auto Scan and Skip Mode. The default setting is ALL. |
| SCREEN BLANKER | If the console is left idle for the amount of time set with this function, the screen is blanked. Key in a value from 1 - 30 minutes, then press [Enter] . A setting of 0 disables this function. The default is 0 (disabled). |
| HOTKEY COMMAND MODE | Enables/Disables the hotkey command function if a conflict with programs running on the computers occurs. |
| HOTKEY | Toggle between the two Hotkey Mode invocation sequences. Options are [Num Lock, Minus] and [Ctrl, F12] . |
| OSD LANGUAGE | Determines which language the OSD menus are displayed in. Choices are English, Spanish, French, German and Japanese. |
| TOUCHPAD | Enables/Disables the touchpad. |

F4 Administrator (ADM)

F4 is an Administrator-ONLY function. It allows the Administrator to configure and control the overall operation of the OSD. To change a setting double-click it or use the Up/Down Arrow Keys to move the highlight bar to the item and press **[Enter]**.

After an item has been selected, a submenu with additional choices will appear. Either double-click the desired choice, or move the Highlight Bar to it and press **[Enter]**. An icon appears beside the selected choice to identify it. The settings are explained in the following table:

| Setting | Function |
|----------------------|---|
| SET User LOGIN | Sets the username and password for the Users and the Administrator. One Administrator and four User accounts are available. To Add/Edit an account, do the following: <ul style="list-style-type: none"> • Double-click on the desired account, or highlight it and press the [Enter] key. • In the screen that appears, enter in (or edit) the desired username and password for the account. When finished, hit the [Enter] key to save your changes. Text will appear at the bottom of the OSD stating User SETUP OK, letting you know your changes have been saved. Usernames and passwords can be up to 16 characters long, using any combination of letters and numbers (A-Z, 0-9), and the following characters: Asterisk [*], Parentheses (()), Plus [+], Minus [-], Colon [:], Comma [,], Question Mark [?], Period [.] , Forward Slash [/] and Space. Usernames and passwords are NOT case sensitive. They will always display as uppercase in the OSD. To delete a character in the username or password, simply hit the [Backspace] key. |
| SET ACCESSIBLE PORTS | This allows the Administrator to set port access rights for each User. The four User accounts are displayed in columns at the top of the OSD, and the ports are displayed as rows on the left of the screen. Use the arrow keys to move to the desired User and port field, or simply use the touchpad and click on the User and port field you wish to edit. Press the [Spacebar] to toggle between three options: <ol style="list-style-type: none"> 1. F – Full Access. 2. V – View Only Access. 3. [Blank] – No Access. By default, all Users have Full Access to every port. As the Administrator has access to all ports and settings in the KVM, you can not change their access rights. |
| SET LOGOUT TIMEOUT | If there is no input from the console for the amount of time set here, the User will be logged out, requiring them to re-enter their Username and password to regain access to the KVM. This can be set from 0 to 180 minutes, with 0 disabling the function. Simply type in the desired time frame and hit the [Enter] key to save your change. This is disabled (0) by default. |
| EDIT PORT NAMES | This function allows the Administrator to give each port a unique name, making it easier to find the computer you want to access. To add/edit a port name, do the following: <ol style="list-style-type: none"> 1. Select the port by double-clicking on it, or by highlighting it and hitting the [Enter] key. 2. A name field will appear at the bottom of the screen. Add or edit the port name and hit the [Enter] key to save the change. To exit without saving the change, hit the [Esc] key. Port names can have a maximum of 12 characters, including any combination of letters and numbers (A-Z, 0-9), and the following characters: Asterisk [*], Parentheses (()), Plus [+], Minus [-], Colon [:], Comma [,], Question Mark [?], Period [.] , Forward Slash [/] and Space. Port names are NOT case sensitive. They will always display as uppercase in the OSD. |

7. OSD (On-Screen Display) Operation

7.6 OSD Functions

| Setting | Function |
|------------------------|---|
| RESTORE DEFAULT VALUES | This allows the Administrator to restore all OSD settings to their factory default values except for the port names and user-name/passwords. When this function is accessed, prompt will appear asking if you wish to restore the default settings. If yes, type in a Y and hit the [Enter] key. If no, press the [Esc] key to go back to the previous menu. |
| CLEAR THE NAME LIST | This function allows the Administrator to clear all of the port names that have been entered. As with the RESTORE DEFAULT VALUES, you will be prompted upon accessing this function. If you wish to clear the name list, type in a Y and hit the [Enter] key. If not, press the [Esc] key to go back to the previous menu. |
| ACTIVATE BEEPER | Turns the Beeper sound ON or OFF. Type in Y to turn the Beeper sound ON, or N to turn it OFF. You do not need to hit the [Enter] key after typing in Y or N , the change will be made automatically. |
| SET QUICK VIEW PORTS | The Administrator can use this function to mark ports as Quick View ports. This gives the Administrator a way to customize which ports are displayed in the OSD main menu, and which are accessible in Auto Scan and Skip Modes. To set ports as Quick View ports, do the following: <ol style="list-style-type: none"> 1. Highlight the desired port and hit the [Enter] key, or click on it using the touchpad. 2. Press the [Spacebar] to toggle Quick View status ON/OFF. An icon will appear in the QV column next to the selected port when Quick View status is turned ON. <p>Once Quick View ports are set, the Administrator can set up the OSD main page to display only Quick View ports, or only Quick View ports that are powered ON. The Administrator can also set it up so that only Quick View ports, or powered ON Quick View ports, are accessible in Auto Scan or Skip Modes.</p> |
| RESET STATION IDS | This function is used when you change the position of one of the KVM stations in a daisy-chain. When you change the position of the station, the OSD does not recognize the change, and will not automatically update the main menu to display the stations in correct order. When this function is used, the KVM will scan the entire installation and update the station numbers accordingly. The port names of the affected stations will be kept; however, you will need to manually update all other settings (SET ACCESSIBLE PORTS, SET QUICK VIEW PORTS, etc.). |
| SET OPERATING SYSTEM | This allows the Administrator to set the operating system for the port to match that of the connected computer. To set the operating system, do the following: <ol style="list-style-type: none"> 1. Highlight the desired port or click on it using the touchpad. 2. Press the [Spacebar] to toggle between four options; WIN, MAC, SUN and OTHER. Each port is set to WIN by default. 3. You do not need to press the [Enter] key to save this setting. |
| FIRMWARE UP-GRADE | In order to upgrade the KVMs firmware, Firmware Upgrade Mode must be invoked via this setting. (See page 18 for details on performing a firmware upgrade.) When you select this option, the firmware version numbers are displayed on the OSD screen, and a prompt will ask if you wish to continue with a firmware upgrade. If yes, type in Y . If no, type in N . |
| KEYBOARD LANGUAGE | Sets the language for an external keyboard connected to the KVMs external keyboard port. To select a keyboard language, double-click on the desired language or highlight it and hit the [Enter] key. You can choose between US English, UK English, German, Swiss German, French, Hungarian, Italian, Japanese, Korean, Russian, Spanish, Swedish and Traditional Chinese. |
| SET CONSOLE MODE | This allows the Administrator to set which consoles are enabled for use. Press the spacebar to toggle between three choices: <ol style="list-style-type: none"> 1. Mode 0 – Both consoles are enabled. 2. Mode 1 – Only the built-in LCD console is enabled. 3. Mode 2 – Only the external console is enabled. <p>This setting defaults at Mode 0. (Both consoles are enabled.)</p> |

F5 Skip (SKP)

Invokes the Skip (SKP) Mode by clicking the **F5** field or pressing **[F5]**. This function skips backward or forward—switching the console focus from the currently active computer port to the previous or next available one.

- The selection of computers to be available for Skip Mode switching is made with the *Scan/Skip Mode* setting under the **F3 SET** function (see page 15).
- When in the Skip Mode, press:
 - **[←]** to switch to the previous computer in the list
 - **[→]** to switch to the next computer in the list
 - **[↑]** to switch to the last computer on the previous station in the list
 - **[↓]** to switch to the first computer on the next station in the list
- If a port has been selected for *Scan/Skip Mode*, a Left/Right Triangle symbol appears before its Port ID Display (when the focus switches to that port), to indicate so.
- The keyboard and mouse will not function normally in Skip Mode. The only keys you will be able to use are the Arrow keys. The Skip Mode must be exited in order to regain normal control of the keyboard and mouse.
- To exit Skip Mode, press **[Esc]** or **[Spacebar]**.

7. OSD (On-Screen Display) Operation

7.6 OSD Functions

F6 Broadcast Mode (BRC)

F6 is an Administrator-ONLY function. Clicking the **F6** field, or pressing **[F6]**, invokes Broadcast (BRC) Mode. When this function is in effect, commands sent from the console are broadcast to all available computers on the installation.

This function is particularly useful for operations that need to be performed on multiple computers, such as performing a system-wide shutdown, installing or upgrading software, etc.

BRC works in conjunction with the **F2 LIST** function. The LIST function (see page 15) lets you tailor the list of ports the OSD will display on the OSD Main Screen. When a command is broadcast, it is done only to the ports currently displayed on the OSD Main Screen.

- A Speaker symbol appears before the Port ID Display to indicate BRC Mode is in effect.
- The mouse will not function while the BRC Mode is in effect. You must exit the BRC Mode in order to regain control of the mouse.
- To exit BRC Mode, invoke the OSD (with the OSD hotkey), then click the **F6** field, or press **[F6]**.

F7 Scan (SCAN)

Invoke the Auto Scan Mode by clicking the **F7** field or pressing **[F7]**. This function allows you to cycle through available computers at regular intervals so that you can monitor their activity without having to take the trouble of switching yourself.

- The selection of computers to be included for Auto Scanning is made with the Scan/Skip Mode setting under the **F3 SET** function (see page 15).
- The amount of time that each port displays for is set with the Scan Duration setting under the **F3 SET** function (see page 15). When you want to stop at a particular location, press the **[Spacebar]** or **[Esc]** to stop scanning.
- If the scanning stops on an empty port, or one where the computer is attached but is powered off, the monitor screen will be blank, and the mouse and keyboard will have no effect. After the *Scan Duration* time is up, the Scan function will move on to the next port.
- As each computer is accessed, an **S** appears in front of the Port ID display to indicate that it is being accessed under *Auto Scan Mode*.
- While Auto Scan Mode is in effect, the keyboard and mouse will not function. You must exit Auto Scan Mode in order to regain control of the console.
- While in Auto Scan Mode, the scanning can be paused in order to keep the focus on a particular computer either by pressing **P**, or with a left click of the mouse.
- To exit Auto Scan Mode, press the **[Spacebar]** or **[Esc]**.

F8 Log Out (LOUT)

Clicking the F8 field or pressing **[F8]** logs you out of the KVM switch, and blanks the Console screen. This is different from simply pressing **[Esc]** to deactivate the OSD. With this function you must log in again to regain access to the KVM, whereas with **[Esc]**, you are only logged out of the OSD screen.

- Note:*
1. When you reenter the OSD after logging out, the screen stays blank except for the OSD Main Menu. You must input your password before you can continue.
 2. If you reenter the OSD after logging out, and immediately use **[Esc]** to deactivate the OSD without having selected a port from the OSD menu, a Null Port message displays on the screen. The OSD Hotkey will bring up the Main OSD Screen.

8. Firmware Upgrade Utility

8.1 Before You Begin

To prepare for the firmware upgrade, do the following:

1. From a computer that is not part of your KVM installation go to the support section on www.tripplite.com and choose the model name that relates to your device to get a list of available Firmware Upgrade Packages.
2. Choose the Firmware Upgrade file you want to install (usually the most recent), and download it to your computer.
3. Use the Firmware Upgrade Cable (provided with this unit), to connect a COM port on your computer to the Firmware Upgrade Port of your switch.

Note: When daisy-chaining B020-U16 KVM Switches ONLY, a firmware upgrade to station 1 will upgrade all connected KVMs. All B022-016 KVMs will need to be upgraded individually.

4. Shut down all of the computers.
5. From your KVM switch console, bring up the OSD and select the **F4 ADM** function. (See page 16.)
6. Scroll down to **FIRMWARE UPGRADE**. Press **[Enter]**, then press **[Y]** to invoke Firmware Upgrade Mode. For your reference, the current firmware upgrade version displays on the screen.

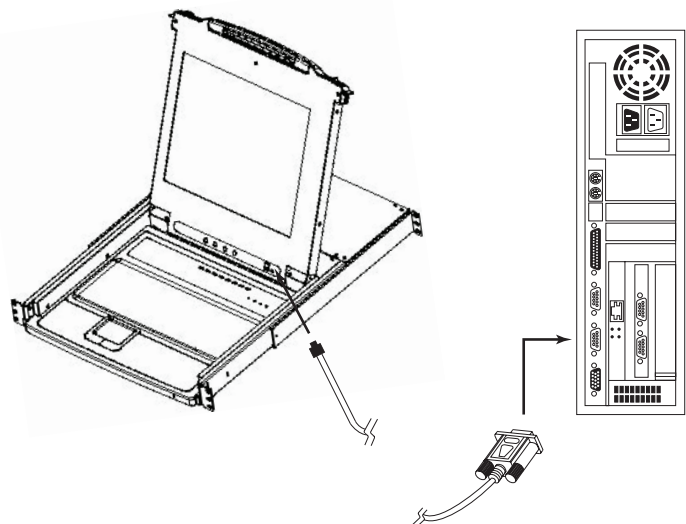

8. Firmware Upgrade Utility

8.2 Starting the Upgrade

To upgrade your firmware:

1. Run the downloaded Firmware Upgrade Utility by double-clicking the file icon or by opening a command line and entering the full path to it. The Firmware Upgrade Utility *Welcome* screen appears.
2. Read and *Agree* to the License Agreement (click the **I Agree** radio button).
3. Click [**Next**] to continue. The Firmware Upgrade Utility main screen appears:

The utility inspects your installation. All the devices capable of being upgraded by the package are listed in the *Device List* panel.

4. As you select devices, a detailed description of each appears in the *Device Description* panel.
5. After you have made your selection(s), click [**Next**] to perform the upgrade. If you enabled *Check Firmware Version*, the utility compares the device's firmware levels with that of the upgrade files. If it finds that the device's version is higher than the upgrade version, it brings up a dialog box informing you of the situation and gives you the option to *Continue* or *Cancel*.

If the *Check Firmware Version* is not enabled, the utility installs the upgrade files without checking whether they are a higher level version.

As the upgrade proceeds, status messages appear in the Status Messages panel, and the progress toward completion is shown on the *Progress* bar.

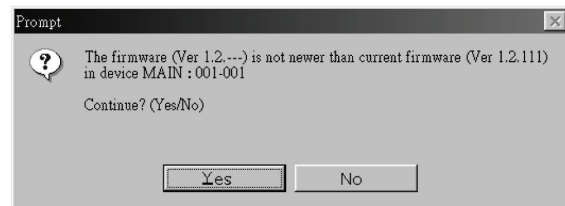
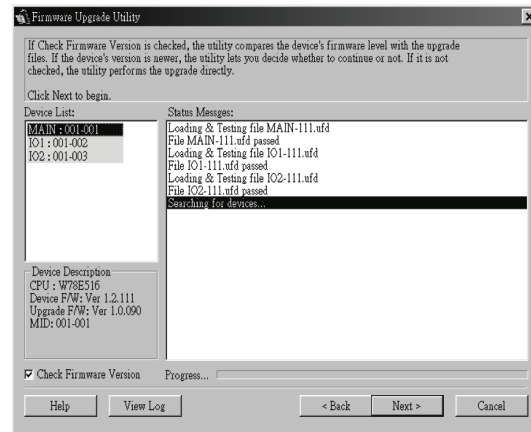

8.3 Upgrade Succeeded

After the upgrade has completed, a screen appears to inform you that the procedure was successful:

Click **Finish** to close the Firmware Upgrade Utility.

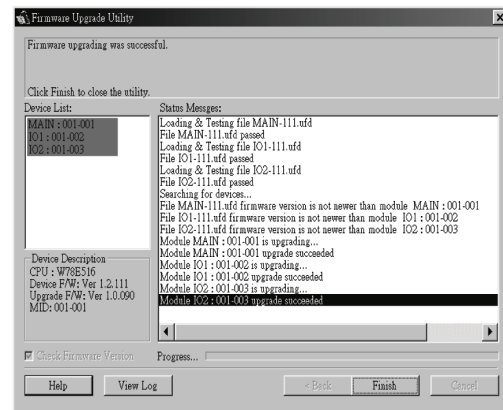

8.4 Upgrade Failed

If the upgrade failed to complete successfully, a dialog box appears asking if you want to retry. Click **Yes** to retry. If you click **No**, the *Upgrade Failed* screen appears:

Click **Cancel** to close the Firmware Upgrade Utility. See the next section, *Firmware Upgrade Recovery*, for how to proceed.

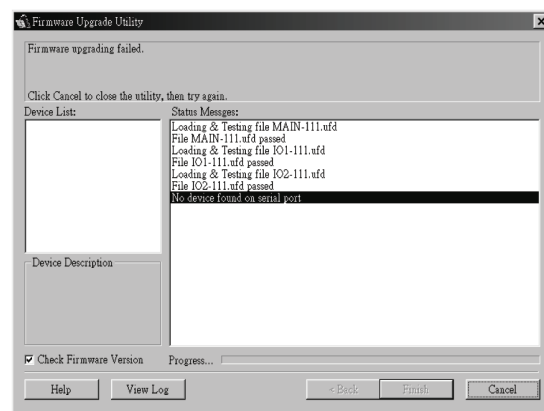

8. Firmware Upgrade Utility

8.5 Firmware Upgrade Recovery

A firmware upgrade recovery is required in any of the following situations:

- When you invoke Firmware Upgrade Mode (see page 18), but decide not to proceed with the upgrade.
- When the main board firmware upgrade fails.
- When the I/O firmware upgrade fails.

To perform a firmware upgrade recovery, do the following:

1. Slide the *Firmware Upgrade Recovery Switch* (see page 4) to the **Recover** position.
2. Power-off and restart the switch according to the instructions below:

- Shut down all the computers that are attached to it.

Note: Unplug the power cord of any computer that has the Keyboard Power On function. Otherwise, the KVM will still receive power from this computer.

- Wait 10 seconds, then plug the KVM switch back in.
- Once the switch is up, the computers can be powered ON.

Note: If you have shut down more than one Station, power up the highest Station first and work your way down to the lowest one.

3. Slide the *Firmware Upgrade Recovery Switch* back to the **Normal** position.
4. Upgrade your firmware using the steps from pages 18-19.

9. Appendix A

9.1 Specifications

| Specification | B020-U08-19-K & B020-U08-19KTAA | B020-U16-19-K | B022-U16 |
|---------------------------------|--|----------------------------------|----------------------------------|
| Port Selection Methods | Push-button, Hotkey, OSD | | |
| CPU Ports | (x8) HD18 Female | (x16) HD18 Female | |
| External Console Port(s) | HD18 Male | | |
| External Mouse Port(s) | USB A Female | | N/A |
| Daisy-Chain Port | DB25 Male | (x1) DB25 Male, (x1) DB25 Female | |
| Max Connections via Daisy-Chain | 504 | 512 | |
| Firmware Upgrade Port | RJ11 Female | | |
| Power Outlet | IEC-320-C14 | | DC Power Adapter Jack |
| Shared Peripheral Port(s) | USB1.1 A Female | | |
| Required KVM Cable Kits | P778-Series USB/PS2 Combo KVM Cable Kits | | |
| Included Cable Kits | (x8) P778-006 6ft KVM Cable Kits | | (x2) P778-006 6ft KVM Cable Kits |
| Online LEDs | (x8) Orange | (x16) Orange | |
| Selected LEDs | N/A | | (x16) Green |
| Port LED | Numerical LED (Orange) | | N/A |
| Station LED | Numerical LED (Orange) | | |
| Power LED | Blue | | Green |
| Keyboard/Mouse Emulation | USB and PS/2 | | |
| Max Video Resolution | 1280 x 1024 @ 75Hz, DDC2B | | 2048 x 1536, DDC2B |
| Auto Scan Interval | User-Definable (1 to 255 seconds) | | |
| I/P Rating | 100-240VAC, 50/60Hz, 1A | | 100-240VAC, 50/60Hz, 0.5A |
| Power Consumption | 120V, 28.5W / 230V, 29.1W | | DC 5.3V, 6.6W |
| Operating Temperature | 0 to 50° C | | |
| Storage Temperature | -20 to 60° C | | |
| Humidity | 0 to 80% RH, Noncondensing | | |
| Weight | 30.6lbs | 31.3lbs | 6.3lbs |
| Dimensions (H x W x D) Inches | 1.75 x 17 x 27 | | 1.75 x 17 x 6 |

9. Appendix A

9.2 OSD Factory Default Settings

The factory default settings are as follows:









| Setting | Default |
|--------------------------|-------------------------------------|
| OSD Hotkey | [Scroll Lock] [Scroll Lock]* |
| Port ID Display Position | Upper Left Corner |
| Port ID Display Duration | 3 Seconds |
| Port ID Display Mode | The Port Number plus the Port Name |
| Scan Duration | 5 Seconds |
| Scan/Skip Mode | All |
| Screen Blanker | 0 (Disabled) |
| Logout Timeout | 0 (Disabled) |
| Accessible Ports | F (Full) for all users on all ports |
| Beeper | Y (Activated) |

*Use of the [Scroll Lock] key requires the [Fn] key to be held down.

9.3 Keyboard Emulation

Mac Keyboard







The PC compatible (101/104 key) keyboard can emulate the functions of the Mac keyboard. The emulation mappings are listed in the table below.

| PC Keyboard | Mac Keyboard |
|--|---|
| [Shift] | Shift |
| [Ctrl] | Ctrl |
|  |  |
| [Ctrl] [1] |  |
| [Ctrl] [2] |  |
| [Ctrl] [3] |  |
| [Ctrl] [4] |  |
| [Alt] | Alt |
| [Print Screen] | F13 |
| [Scroll Lock] | F14 |
|  | = |
| [Enter] | Return |
| [Backspace] | Delete |
| [Insert] | Help |
| [Ctrl]  | F15 |

Note: When using key combinations, press and release the first key (Ctrl), then press and release the activation key.

Sun Keyboard

The PC compatible (101/104 key) keyboard can emulate the functions of the Sun keyboard when the Control key [Ctrl] is used in conjunction with other keys. The corresponding functions are shown in the table below.

| PC Keyboard | Sun Keyboard |
|--|---|
| [Ctrl] [T] | Stop |
| [Ctrl] [F2] | Again |
| [Ctrl] [F3] | Props |
| [Ctrl] [F4] | Undo |
| [Ctrl] [F5] | Front |
| [Ctrl] [F6] | Copy |
| [Ctrl] [F7] | Open |
| [Ctrl] [F8] | Paste |
| [Ctrl] [F9] | Find |
| [Ctrl] [F10] | Cut |
| [Ctrl] [1] |  |
| [Ctrl] [2] |  |
| [Ctrl] [3] |  |
| [Ctrl] [4] |  |
| [Ctrl] [H] | Help |
|  | Compose |
|  |  |

Note: When using key combinations, press and release the first key (Ctrl), then press and release the activation key.

10. Appendix B

10.1 FCC Radio/TV Interference Notice

FCC Notice, Class A

This device complies with part 15 of the FCC Rules. Operation is subject to the following two conditions: (1) This device may not cause harmful interference, and (2) this device must accept any interference received, including interference that may cause undesired operation.

Note: This equipment has been tested and found to comply with the limits for a Class A digital device, pursuant to part 15 of the FCC Rules. These limits are designed to provide reasonable protection against harmful interference when the equipment is operated in a commercial environment. This equipment generates, uses, and can radiate radio frequency energy and, if not installed and used in accordance with the instruction manual, may cause harmful interference to radio communications. Operation of this equipment in a residential area is likely to cause harmful interference in which case the user will be required to correct the interference at his own expense. The user must use shielded cables and connectors with this equipment. Any changes or modifications to this equipment not expressly approved by Tripp Lite could void the user's authority to operate this equipment.

11. Warranty

1-YEAR LIMITED WARRANTY

TRIPP LITE warrants its products to be free from defects in materials and workmanship for a period of one (1) year from the date of initial purchase. TRIPP LITE's obligation under this warranty is limited to repairing or replacing (at its sole option) any such defective products. To obtain service under this warranty, you must obtain a Returned Material Authorization (RMA) number from TRIPP LITE or an authorized TRIPP LITE service center. Products must be returned to TRIPP LITE or an authorized TRIPP LITE service center with transportation charges prepaid and must be accompanied by a brief description of the problem encountered and proof of date and place of purchase. This warranty does not apply to equipment which has been damaged by accident, negligence or misapplication or has been altered or modified in any way. EXCEPT AS PROVIDED HEREIN, TRIPP LITE MAKES NO WARRANTIES, EXPRESS OR IMPLIED, INCLUDING WARRANTIES OF MERCHANTABILITY AND FITNESS FOR A PARTICULAR PURPOSE. Some states do not permit limitation or exclusion of implied warranties; therefore, the aforesaid limitation(s) or exclusion(s) may not apply to the purchaser. EXCEPT AS PROVIDED ABOVE, IN NO EVENT WILL TRIPP LITE BE LIABLE FOR DIRECT, INDIRECT, SPECIAL, INCIDENTAL OR CONSEQUENTIAL DAMAGES ARISING OUT OF THE USE OF THIS PRODUCT, EVEN IF ADVISED OF THE POSSIBILITY OF SUCH DAMAGE. Specifically, TRIPP LITE is not liable for any costs, such as lost profits or revenue, loss of equipment, loss of use of equipment, loss of software, loss of data, costs of substitutes, claims by third parties, or otherwise.

12. Warranty Registration

Visit www.tripplite.com/warranty today to register the warranty for your new Tripp Lite product. You'll be automatically entered into a drawing for a chance to win a FREE Tripp Lite product!*

* No purchase necessary. Void where prohibited. Some restrictions apply. See website for details.

Warning!

Use of this equipment in life support applications where failure of this equipment can reasonably be expected to cause the failure of the life support equipment or to significantly affect its safety or effectiveness is not recommended. Do not use this equipment in the presence of a flammable anesthetic mixture with air, oxygen or nitrous oxide.

Regulatory Compliance Identification Numbers

For the purpose of regulatory compliance certifications and identification, your Tripp Lite product has been assigned a unique series number. The series number can be found on the product nameplate label, along with all required approval markings and information. When requesting compliance information for this product, always refer to the series number. The series number should not be confused with the marking name or model number of the product.

The policy of TRIPP LITE is one of continuous improvement. Specifications are subject to change without notice.

WEEE Compliance Information for Tripp Lite Customers and Recyclers (European Union)

Under the Waste Electrical and Electronic Equipment (WEEE) Directive and implementing regulations, when customers buy new electrical and electronic equipment from Tripp Lite they are entitled to:

- Send old equipment for recycling on a one-for-one, like-for-like basis (this varies depending on the country)
- Send the new equipment back for recycling when this ultimately becomes waste



1111 W. 35th Street, Chicago, IL 60609 USA
www.tripplite.com/support