

**ONKYO**

Network Stereo Receiver

**TX-8140**

# Instruction Manual

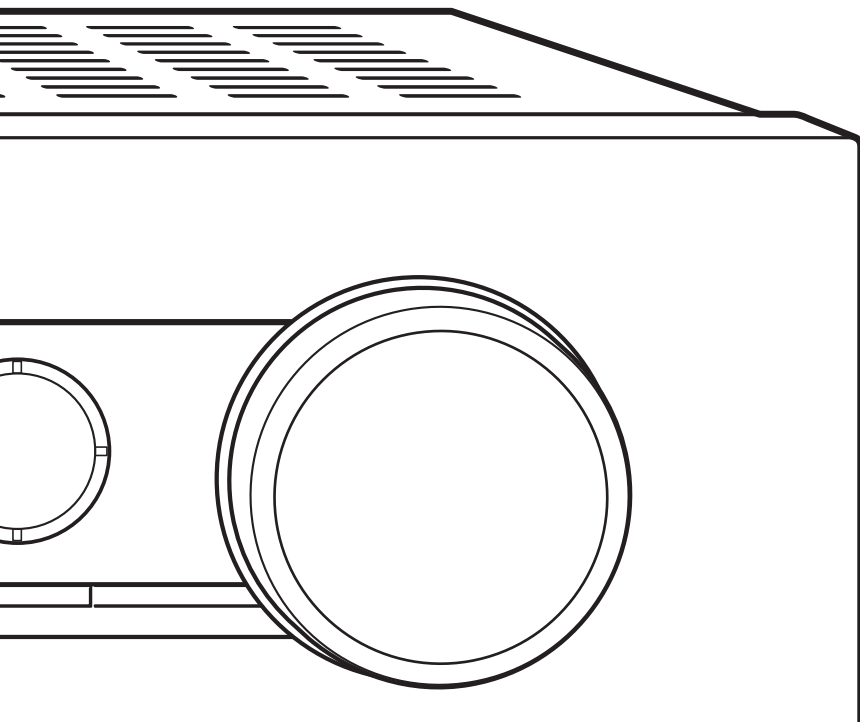

Thank you for purchasing an  
Onkyo product.  
Please retain this manual for future  
reference.

# Contents

<b>Names and functions of parts</b>	<b>7</b>
• Front	7
• Display	8
• Remote control	9
• Rear	10
<b>Connections</b>	<b>11</b>
• Connecting speakers	11
• Connecting a player	12
• AM/FM antenna connections	13
• Network connection	14
<b>Listening to Internet radio</b>	<b>16</b>
<b>Playing music with <i>Bluetooth</i><sup>®</sup> functions</b>	<b>22</b>
<b>Playing music with Spotify</b>	<b>23</b>
<b>Playing tracks stored on a USB storage device</b>	<b>24</b>
<b>Home network functions</b>	<b>25</b>
• Playing music stored on DLNA-compatible devices	25
• Music streaming from a shared folder (Home Media)	26
<b>Listening to the sound from a connected player</b>	<b>28</b>
<b>Listening to AM/FM radio</b>	<b>29</b>
<b>Various settings</b>	<b>32</b>
• Adjusting sound quality, etc.	32
• Sleep timer	32
• Inputting characters	33
• Setup menu	33
• Firmware update	36
<b>Troubleshooting</b>	<b>38</b>
<b>Compatible devices/media/file formats</b>	<b>40</b>

# Supplied accessories

Before use, check the packaging for the main unit and the accessories below.

- Remote control (RC-904S) × 1
- Batteries for remote control (AAA/R03) × 2
- AM loop antenna × 1

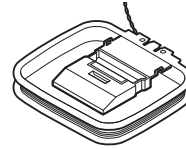

- Indoor FM antenna × 1

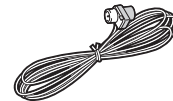

**WARNING:**

TO REDUCE THE RISK OF FIRE OR ELECTRIC SHOCK, DO NOT EXPOSE THIS APPARATUS TO RAIN OR MOISTURE.

**CAUTION:**

TO REDUCE THE RISK OF ELECTRIC SHOCK, DO NOT REMOVE COVER (OR BACK). NO USER-SERVICEABLE PARTS INSIDE. REFER SERVICING TO QUALIFIED SERVICE PERSONNEL.



**WARNING**  
RISK OF ELECTRIC SHOCK  
DO NOT OPEN

**AVIS**  
RISQUE DE CHOC ELECTRIQUE  
NE PAS OUVRIR



The lightning flash with arrowhead symbol, within an equilateral triangle, is intended to alert the user to the presence of uninsulated "dangerous voltage" within the product's enclosure that may be of sufficient magnitude to constitute a risk of electric shock to persons.



The exclamation point within an equilateral triangle is intended to alert the user to the presence of important operating and maintenance (servicing) instructions in the literature accompanying the appliance.

## Important safety instructions

1. Read these instructions.
2. Keep these instructions.
3. Heed all warnings.
4. Follow all instructions.
5. Do not use this apparatus near water.
6. Clean only with dry cloth.
7. Do not block any ventilation openings. Install in accordance with the manufacturer's instructions.
8. Do not install near any heat sources such as radiators, heat registers, stoves, or other apparatus (including amplifiers) that produce heat.
9. Do not defeat the safety purpose of the polarized or grounding-type plug. A polarized plug has two blades with one wider than the other. A grounding type plug has two blades and a third grounding prong. The wide blade or the third prong are provided for your safety. If the provided plug does not fit into your outlet, consult an electrician for replacement of the obsolete outlet.
10. Protect the power cord from being walked on or pinched particularly at plugs, convenience receptacles, and the point where they exit from the apparatus.
11. Only use attachments/accessories specified by the manufacturer.
12. Use only with the cart, stand, tripod, bracket, or table specified by the manufacturer, or sold with the apparatus. When a cart is used, use caution when moving the cart/apparatus combination to avoid injury from tip-over.
13. Unplug this apparatus during lightning storms or when unused for long periods of time.
14. Refer all servicing to qualified service personnel. Servicing is required when the apparatus has been damaged in any way, such as power-supply cord or plug is damaged, liquid has been spilled or objects have fallen into the apparatus, the apparatus has been exposed to rain or moisture, does not operate normally, or has been dropped.

PORTABLE CART  
WARNING



S3125A

### 15. Damage Requiring Service

Unplug the apparatus from the wall outlet and refer servicing to qualified service personnel under the following conditions:

- A. When the power-supply cord or plug is damaged,
- B. If liquid has been spilled, or objects have fallen into the apparatus,
- C. If the apparatus has been exposed to rain or water,
- D. If the apparatus does not operate normally by following the operating instructions. Adjust only those controls that are covered by the operating instructions as an improper adjustment of other controls may result in damage and will often require extensive work by a qualified technician to restore the apparatus to its normal operation,
- E. If the apparatus has been dropped or damaged in any way, and
- F. When the apparatus exhibits a distinct change in performance this indicates a need for service.

### 16. Object and Liquid Entry

Never push objects of any kind into the apparatus through openings as they may touch dangerous voltage points or short-out parts that could result in a fire or electric shock.

The apparatus shall not be exposed to dripping or splashing and no objects filled with liquids, such as vases shall be placed on the apparatus.

Don't put candles or other burning objects on top of this unit.

### 17. Batteries

Always consider the environmental issues and follow local regulations when disposing of batteries.

### 18. If you install the apparatus in a built-in installation, such as a bookcase or rack, ensure that there is adequate ventilation.

Leave 20 cm (8") of free space at the top and sides and 10 cm (4") at the rear. The rear edge of the shelf or board above the apparatus shall be set 10 cm (4") away from the rear panel or wall, creating a flue-like gap for warm air to escape.

# Precautions

- 1. Recording Copyright**—Unless it's for personal use only, recording copyrighted material is illegal without the permission of the copyright holder.
- 2. AC Fuse**—The AC fuse inside the unit is not user-serviceable. If you cannot turn on the unit, contact the dealer from whom you purchased this unit.
- 3. Care**—Occasionally you should dust the unit all over with a soft cloth. For stubborn stains, use a soft cloth dampened with a weak solution of mild detergent and water. Dry the unit immediately afterwards with a clean cloth. Don't use abrasive cloths, thinners, alcohol, or other chemical solvents, because they may damage the finish or remove the panel lettering.

## 4. Power

### WARNING

BEFORE PLUGGING IN THE UNIT FOR THE FIRST TIME, READ THE FOLLOWING SECTION CAREFULLY.

AC outlet voltages vary from country to country. Make sure that the voltage in your area meets the voltage requirements printed on the unit's rear panel (e.g., AC 230 V, 50 Hz or AC 120 V, 60 Hz).

The power cord plug is used to disconnect this unit from the AC power source. Make sure that the plug is readily operable (easily accessible) at all times.

For models with [POWER] button, or with both [POWER] and [ON/STANDBY] buttons:

Pressing the [POWER] button to select OFF mode does not fully disconnect from the mains. If you do not intend to use the unit for an extended period, remove the power cord from the AC outlet.

For models with [ON/STANDBY] button only:

Pressing the [ON/STANDBY] button to select Standby mode does not fully disconnect from the mains. If you do not intend to use the unit for an extended period, remove the power cord from the AC outlet.

## 5. Preventing Hearing Loss

### Caution

Excessive sound pressure from earphones and headphones can cause hearing loss.

## 6. Batteries and Heat Exposure

### Warning

Batteries (battery pack or batteries installed) shall not be exposed to excessive heat as sunshine, fire or the like.

- 7. Never Touch this Unit with Wet Hands**—Never handle this unit or its power cord while your hands are wet or damp. If water or any other liquid gets inside this unit, have it checked by the dealer from whom you purchased this unit.

## 8. Handling Notes

- If you need to transport this unit, use the original packaging to pack it how it was when you originally bought it.
- Do not leave rubber or plastic items on this unit for a long time, because they may leave marks on the case.
- This unit's top and rear panels may get warm after prolonged use. This is normal.
- If you do not use this unit for a long time, it may not work properly the next time you turn it on, so be sure to use it occasionally.

### For U.S. models

#### FEDERAL COMMUNICATIONS COMMISSION DECLARATION OF CONFORMITY

This device complies with part 15 of the FCC Rules. Operation is subject to the following two conditions:

- (1) this device may not cause interference, and
- (2) this device must accept any interference, including interference that may cause undesired operation of the device.

Product Name:	Network Stereo Receiver
Model Number:	TX-8140
Responsible Party Name:	Onkyo U.S.A. Corporation
Address:	18 PARK WAY, UPPER SADDLE RIVER, NEW JERSEY 07458, USA
Phone:	1-800-229-1687

### FCC Information for User

#### CAUTION:

The user changes or modifications not expressly approved by the party responsible for compliance could void the user's authority to operate the equipment.

#### NOTE:

This equipment has been tested and found to comply with the limits for a Class B digital device, pursuant to Part 15 of the FCC Rules. These limits are designed to provide reasonable protection against harmful interference in a residential installation. This equipment generates, uses and can radiate radio frequency energy and, if not installed and used in accordance with the instructions, may cause harmful interference to radio communications. However, there is no guarantee that interference will not occur in a particular installation. If this equipment does cause harmful interference to radio or television reception, which can be determined by turning the equipment off and on, the user is encouraged to try to correct the interference by one or more of the following measures:

- Reorient or relocate the receiving antenna.
- Increase the separation between the equipment and receiver.
- Connect the equipment into an outlet on a circuit different from that to which the receiver is connected.
- Consult the dealer or an experienced radio/TV technician for help.

**For Canadian Models****NOTE:**

CAN ICES-3 B/NMB-3 B

For models having a power cord with a polarized plug:

**CAUTION:**

TO PREVENT ELECTRIC SHOCK, MATCH WIDE  
BLADE OF PLUG TO WIDE SLOT, FULLY INSERT.

**Modèle pour les Canadiens****REMARQUE :**

CAN ICES-3 B/NMB-3 B

Sur les modèles dont la fiche est polarisée :

**ATTENTION :**

POUR ÉVITER LES CHOCS ÉLECTRIQUES,  
INTRODUIRE LA LAME LA PLUS LARGE DE LA FICHE  
DANS LA BORNE CORRESPONDANTE DE LA PRISE  
ET POUSSER JUSQU'AU FOND.

This device complies with Industry Canada licence-exempt RSS standard(s). Operation is subject to the following two conditions: (1) this device may not cause interference, and (2) this device must accept any interference, including interference that may cause undesired operation of the device.

This transmitter must not be co-located or operated in conjunction with any other antenna or transmitter.

**RF Exposure Compliance**

This equipment complies with FCC/IC radiation exposure limits set forth for an uncontrolled environment and meets the FCC radio frequency (RF) Exposure Guidelines in Supplement C to OET65 and RSS-102 of the IC radio frequency (RF) Exposure rules. This equipment has very low levels of RF energy that it deemed to comply without maximum permissive exposure evaluation (MPE). But it is desirable that it should be installed and operated keeping the radiator at least 20 cm or more away from person's body (excluding extremities: hands, wrists, feet and ankles).

**DISCLAIMER**

Through this device you are able to link to other services or websites which are not under the control of any company which has designed, manufactured or distributed/have distributed this device, and its affiliates (collectively, "Company"). We have no control over the nature, content and availability of those services. The inclusion of any links does not necessarily imply a recommendation or endorse the views expressed within them.

All information, content and services available through this device belong to third parties and are protected by copyright, patent, trademark and/or other intellectual property laws of applicable countries.

The information, content and services provided through this device are for your personal, noncommercial use only. Any information, content or services may not be used in any manner other than previously approved by the appropriate content owner or service provider.

You may not modify, copy, republish, translate, exploit, create derivative works, upload, post, transmit, sell or distribute in any manner any information, content or services available through this device, unless expressly permitted by the appropriate copyright, patent, trademark and/or other intellectual property owner, including, without limitation, content owner or service provider.

THE CONTENT AND SERVICES AVAILABLE THROUGH THIS DEVICE ARE PROVIDED "AS IS". COMPANY DOES NOT WARRANT INFORMATION, CONTENT OR SERVICES SO PROVIDED, EITHER EXPRESSLY OR IMPLIEDLY, FOR ANY PURPOSE. COMPANY EXPRESSLY DISCLAIMS ANY WARRANTIES, EXPRESS OR IMPLIED, INCLUDING BUT NOT LIMITED TO, WARRANTIES OF TITLE, NON-INFRINGEMENT, MERCHANTABILITY OR FITNESS FOR A PARTICULAR PURPOSE.

Company makes no representation or warranty of any kind, express or implied, about the completeness, accuracy, validity, legality, reliability, suitability or availability with respect to the information, content or services available through this device. Company shall not be liable, whether in contract or tort, including negligence and strict liability, for any direct, indirect, special, incidental or consequential damages or any other damages arising out of, or in connection with, any information contained in, or as a result of the use of any content or service by you or any third party, even if Company has been advised of the possibility of such damages, nor shall Company be liable for any third party claims against users of this device or any third party. In no event shall Company be responsible nor liable for, without limiting the generality of the foregoing, any interruption or suspension of any information, content or service available through this device. Company is neither responsible nor liable for customer service related to the information, content and services available through this device. Any question or request for service relating to the information, content or services should be made directly to the appropriate content owners and services providers.

# Features

## A wide range of playback possibilities with Network Features

Connect to the router to the network to access a vast store of music. You can connect to the network via a wireless LAN router by Wi-Fi®.

- Many of the major Internet radio services such as Tuneln Radio are preregistered in the menu
- Supports Spotify. Play music from Spotify with high sound quality
- Home network feature that allows you to play music files from your computer (DLNA, Home Media)

## Plays high-quality 192 kHz/24 bit high-res sources



You can play high-res sources in formats such as WAV, FLAC, or DSD files (\*) distributed over the Internet by using the home network feature or connecting a USB storage device.

### • Playback through the home network feature

By connecting this unit to the same router as your computer, you can play the high-res sources you downloaded to your computer using the DLNA or Home Media features with simple operations on the remote control.

### • Playback from connected USB storage devices

By connecting the USB storage device containing high-res sources to this unit, you can play them with simple operations on the remote control.

\* The unit supports WAV and FLAC files up to 192 kHz/24 bit (up to 96 kHz when playing WAV and FLAC files from a USB storage device). The unit can play 2.8 MHz and 5.6 MHz DSD files (only 2.8 MHz when playing from a USB storage device). See "Compatible devices/media/file formats" (⇒ 40) for details.

## High-quality, fully-fledged audio design

- High-powered discrete amplifier that can drive even a large speaker system
- WRAT (Wide Range Amplifier Technology)
- High-power transformer with silicon steel shielding to reduce leakage flux
- Closed loop circuit to stabilize the ground potential
- Heavy duty parts supported from below by the oval chassis
- Direct feature that outputs pure sound as it was intended by bypassing the tone control circuits during play
- Optimum Gain Volume Circuitry
- Two speaker terminal systems, A and B, SUBWOOFER PRE OUT jack
- DIGITAL IN and LINE IN terminals to play external players. PHONO terminal that supports connection to a record player with a MM cartridge

## Other functions

- Front USB port for playing music files on a USB storage device
- *Bluetooth* function
- AM/FM tuner capable of presetting up to 40 stations
- BGM button that gives you access to Internet radio or AM/FM radio at the touch of a button
- Opt1 In Wakeup feature that starts this unit when a player connected with a digital optical cable starts
- A wide variety of music files are supported, including MP3, WAV, FLAC, DSD, WMA, MPEG4 AAC (with the home network feature and connection of a USB storage device)

## Onkyo Remote (smartphone app)

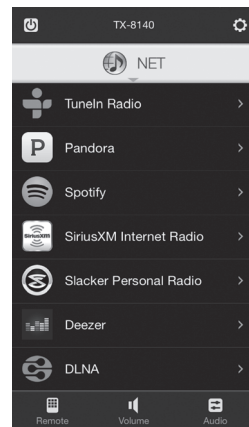

- Input source selection, volume adjustments, and other basic operations possible on your smartphone, which serves as the unit's remote control
- GUI screens that enable intuitive track selection operations on the Internet radio and DLNA
- Streaming of music data stored on your smartphone Supports iOS and Android™ devices. You will need a wireless LAN environment to use apps. The contents of network services are subject to change.

# Names and functions of parts

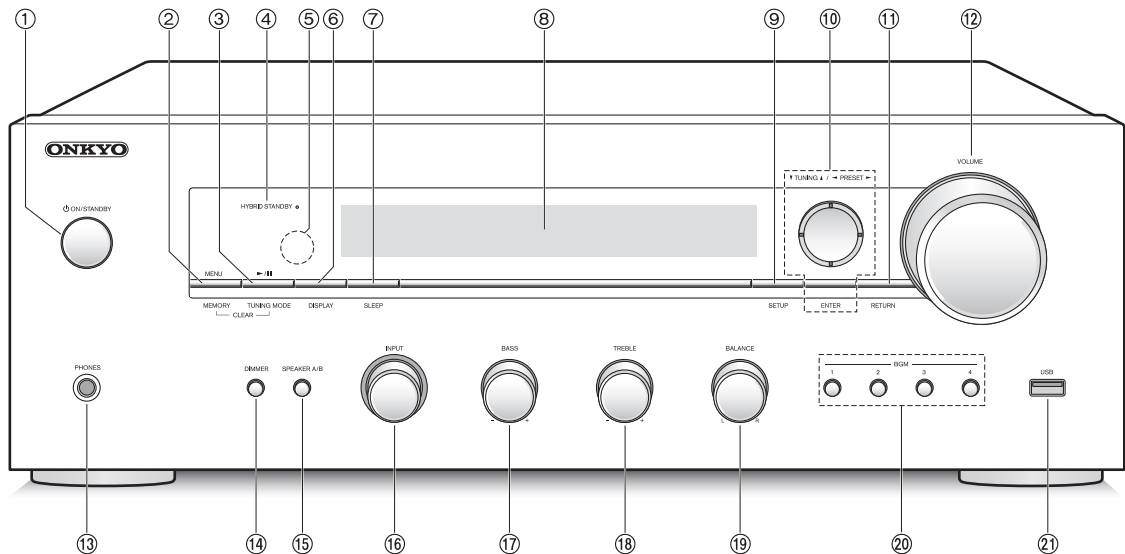

## Front

- ① **ON/STANDBY button:** Press this button to turn the unit on or put it in standby mode.
- ② **MENU/MEMORY button:** Press this button to display the menu or register a AM/FM station.
- ③ **Playback (▶)/Pause (⏸)/TUNING MODE button:** Press this button to playback (\*), pause (\*), or switch the AM/FM tuning mode.
- ④ **HYBRID STANDBY LED:** Lights when any of Network Standby, Bluetooth Wakeup, or Opt1 In Wakeup are on.
- ⑤ **Remote control signal receiver**
- ⑥ **DISPLAY button:** Change the information shown.
- ⑦ **SLEEP button:** Press this button to set the sleep timer.
- ⑧ **Display (⇌ 8)**
- ⑨ **SETUP button:** Used to display the setup menu.
- ⑩ **Direction/▼TUNING▲/◀PRESET▶/ENTER buttons:** Move the cursor and confirms the selection. When listening to AM/FM broadcasting, tune in to the station with ▼TUNING▲ or select the registered station with ◀PRESET▶.
- ⑪ **RETURN button:** Returns the display to the previous state during setting or operation.
- ⑫ **VOLUME control:** Used to adjust the volume.
- ⑬ **PHONES terminal:** Connect headphones with a standard plug.
- ⑭ **DIMMER button:** Use this button to switch the display's brightness between normal, moderately dark and dark.
- ⑮ **SPEAKER A/B button:** Select the terminals to output audio from between SPEAKERS A/B.
- ⑯ **INPUT control:** Selects the source to playback. Turn the control to switch the source in the following order; BD/DVD → CBL/SAT → PC → GAME → CD → PHONO → TV/TAPE → AM → FM → NET → BLUETOOTH
- ⑰ **BASS control:** Adjusts the bass level.
- ⑱ **TREBLE control:** Adjusts the treble level.
- ⑲ **BALANCE control:** Adjusts the audio output balance between the left and right speakers.
- ⑳ **BGM 1/2/3/4 buttons:** Preset your favorite Internet radio or AM/FM radio stations.
- ㉑ **USB port:** A USB storage device is connected so that music files stored in it can be played.

\* Operate with USB storage device play or the home network feature (DLNA, Home Media).

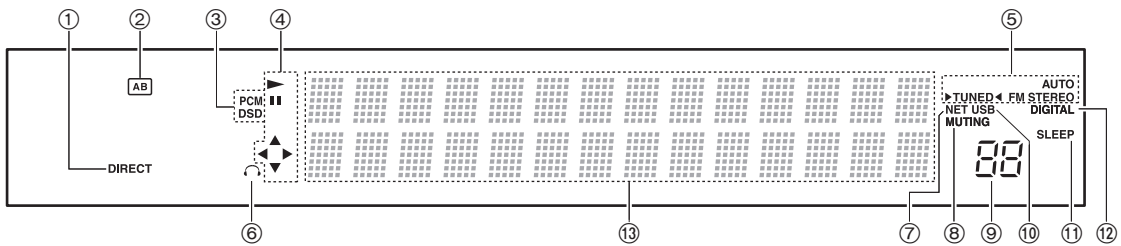

## Display

- ① **DIRECT indicator:** This indicator appears when Direct of the audio quality setup is on.
- ② **Speaker selection display (A/B):** Displays the selected speaker terminals.
- ③ **PCM/DSD:** Lights according to the type of input digital signals.
- ④ **Playback/Pause/Cursor display**
- ⑤ **AM/FM reception statuses**  
**AUTO:** This indicator appears when Auto Tuning Mode is selected.  
**FM STEREO:** This indicator appears when the unit is tuned into a stereo FM broadcast.  
**▶TUNED◀:** This indicator appears when the unit is tuned into a radio station.
- ⑥ **Headphone indicator:** Stays lit when headphones are connected.
- ⑦ **NET:** Lights when “NET” is selected as the input source. It will flash if the connection is not correct.
- ⑧ **MUTING indicator:** This indicator flashes when audio is muted temporarily.
- ⑨ **Volume level**
- ⑩ **USB:** Lights when “USB” is selected as the input source. It will flash if the connection is not correct.
- ⑪ **SLEEP indicator:** This indicator appears when the sleep timer is set.
- ⑫ **DIGITAL:** Lights when the selected input source is digital.
- ⑬ **Message display area:** Track information and menus appear here.  
 The following icons appear.
- : Folder
  - : Track/Broadcast station name
  - : Playing back
  - : Paused
  - : Searching forward
  - : Searching backward
  - : Artist name
  - : Album name
  - : Repeat all tracks
  - : Repeat one track
  - : Repeat tracks in the folder or playlist (DLNA)
  - : Random



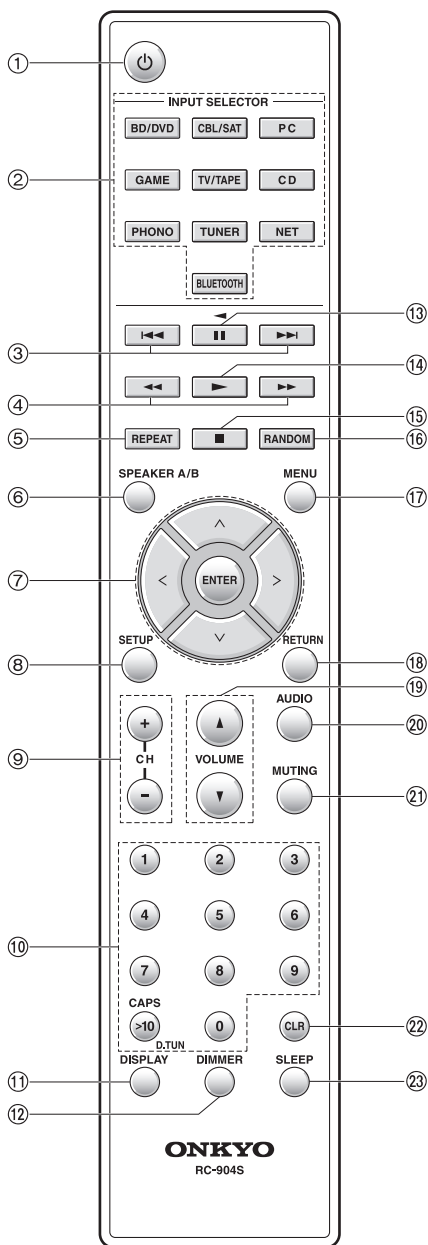

### Remote control

- ① **Power button:** Press this button to turn the unit on or put it in standby mode.
- ② **INPUT SELECTOR buttons:** Use these buttons to select the source to playback.
- ③ **Skip (◀◀/▶▶) buttons (\*)**
- ④ **Search (◀◀/▶▶) buttons (\*)**
- ⑤ **REPEAT button:** Turns repeat play on and off and selects the mode. (\*)
- ⑥ **SPEAKER A/B button:** Select the terminals to output audio from between SPEAKERS A/B.
- ⑦ **Direction (^/∨/◀/▶)/ENTER buttons:** Select items with the direction buttons and press the ENTER button to confirm.
- ⑧ **SETUP button:** Used to display the setup menu.
- ⑨ **CH (+/-) buttons:** Select registered stations.
- ⑩ **Number buttons**
- ⑪ **DISPLAY button:** Change the information shown.
- ⑫ **DIMMER button:** Use this button to switch the display's brightness between normal, moderately dark and dark.
- ⑬ **Pause (||) button (\*)**
- ⑭ **Playback (▶) button (\*)**
- ⑮ **Stop (■) button (\*)**
- ⑯ **RANDOM button:** Plays tracks in the folder or playlist (DLNA) randomly. (\*)
- ⑰ **MENU button:** Press this button to display the menu.
- ⑱ **RETURN button:** Returns the display to the previous state during setting or operation.
- ⑲ **VOLUME ▲/▼ buttons**
- ⑳ **AUDIO button:** Use this button to adjust sound quality, etc.
- ㉑ **MUTING button:** Temporarily mutes audio.
- ㉒ **CLR button:** Use this button to clear the characters that you have input.
- ㉓ **SLEEP button:** Press this button to set the sleep timer.

\* Operate with USB storage device play or the home network feature (DLNA, Home Media).

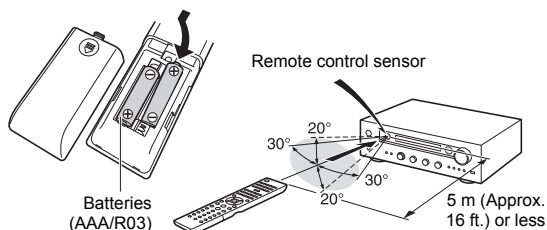

\* If you do not use the remote control for a long time, remove the batteries to prevent leakage. Note that keeping consumed batteries inside may cause corrosion resulting in damage of the remote control.

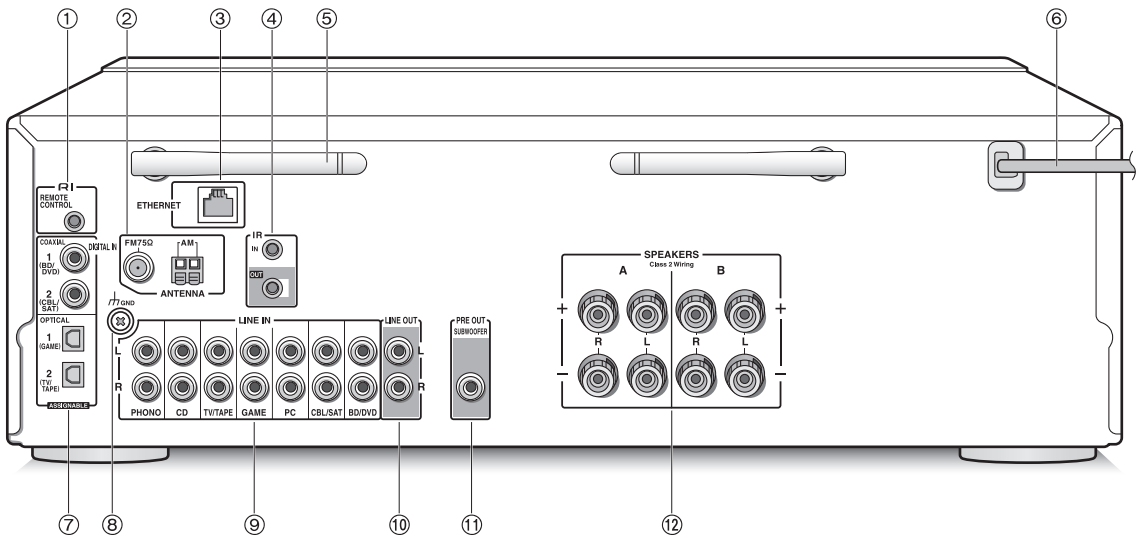

## Rear

- ① **RI REMOTE CONTROL jack:** An Onkyo product with RI jack can be connected and synchronized with this unit.
- ② **FM 75Ω and AM ANTENNA terminals:** The supplied antennas are connected.
- ③ **ETHERNET port:** Connect to the router with an Ethernet cable.
- ④ **IR IN/OUT terminals:** Connected to the multi-room remote control kit. Special devices or cables are necessary. For more information about preparation, contact the specialized stores.
- ⑤ **Wireless antenna:** Used for Wi-Fi connection or when using a *Bluetooth* enabled device. Adjust their angles according to the connection status.
- ⑥ **Power cord:** Connect the power cord to an AC outlet. Disconnect the power cord only after putting the unit into standby mode.
  - \* Turning on the unit may cause a momentary power surge that might interfere with other electrical equipment on the same circuit. If this is a problem, plug the unit into a different branch circuit.
- ⑦ **DIGITAL IN OPTICAL/COAXIAL terminals:** Connected to players. Use a digital optical cable or digital coaxial cable for connection with the digital audio output jack of a player.
- ⑧ **GND terminal:** Connect if the record player has a ground wire.
- ⑨ **LINE IN terminals:** Connected to players. Use an RCA cable for connection with the LINE OUT terminal of a player.
- ⑩ **LINE OUT terminals:** Use when connecting recording devices, such as a cassette tape deck. Use an RCA cable to connect to the LINE IN terminal on a recording device.
- ⑪ **SUBWOOFER PRE OUT jack:** Connect a subwoofer with built-in amplifier to amplify bass output.
- ⑫ **SPEAKERS A/B terminals:** You can connect a set of left and right speakers to each of the A/B terminals.

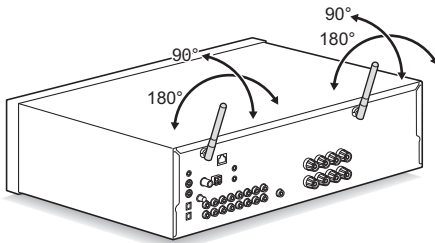

# Connections

- The power cord must be connected only after all other cable connections are completed.

## Connecting speakers

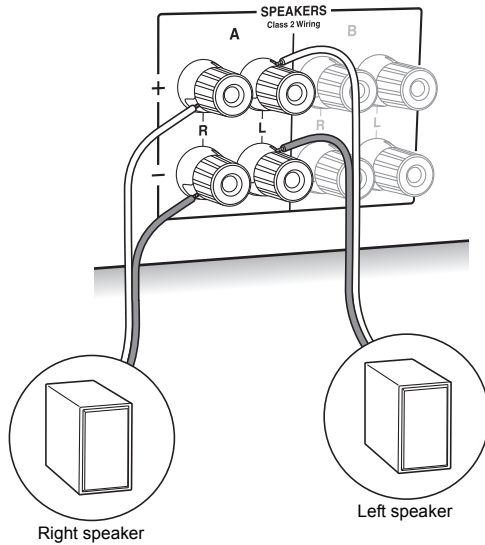

When connecting only one set of speakers, connect to the SPEAKERS A terminals as shown in the illustration. Make correct connection between the unit's jacks and speaker's jacks (+ to + and - to -) for each channel. If connection is wrong, a bass sound may become poor due to reverse phase.

- Connect speakers with  $4\ \Omega$  to  $16\ \Omega$  impedance. You have to change the impedance setting if any of the speakers have  $4\ \Omega$  or more to less than  $6\ \Omega$  impedance. See setup menu "3. Hardware" - "Speaker Impedance" (⇒ 34).

12 - 15 mm (1/2" - 5/8")

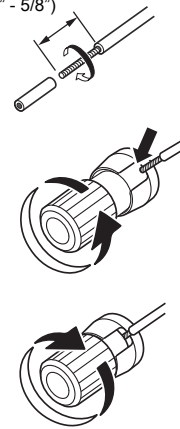

Twist the wires of the speaker cable tightly before inserting into the terminals. After inserting the cables, tighten the terminals firmly by turning to the right. Note that when using commercially available banana plugs, first tighten the speaker terminals and then insert the banana plugs. It is not possible to connect by inserting the core of the speaker cable directly into the hole for a banana plug.

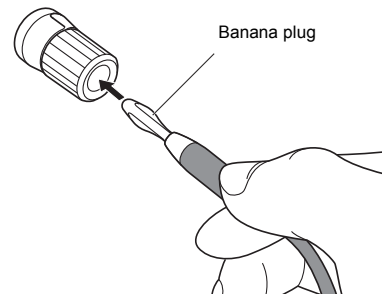

### When also connecting to the SPEAKERS B terminals:

Connect using the same method described for SPEAKERS A. Connect speakers with  $8\ \Omega$  to  $16\ \Omega$  impedance to the both A/B terminals. In this case, change the impedance setting on this unit. See setup menu "3. Hardware"-"Speaker Impedance" (⇒ 34).

- Press the SPEAKER A/B button on the unit or the remote control to switch the speakers. (The selection changes in the order SPEAKER A → SPEAKER B → SPEAKER A+B.)

**When connecting a subwoofer:**

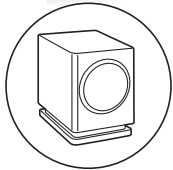
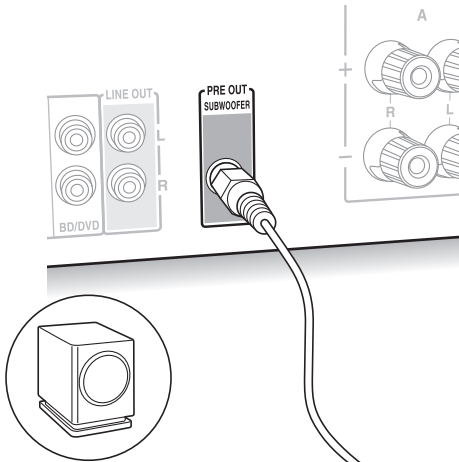

Subwoofer with built-in amplifier

Use a subwoofer cable to connect the SUBWOOFER PRE OUT jack to the LINE INPUT terminal on a subwoofer with built-in amplifier.

- Audio is not output from the SUBWOOFER PRE OUT jack when you set SPEAKER B as the speakers to output audio.

The following connections can cause damage so please be careful.

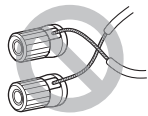

Short-circuiting the + cable and - cable



Contacting the cable core to the rear panel of the unit

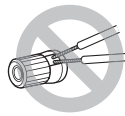

Connecting two or more cables to one speaker terminal of this unit

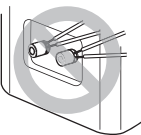

Connecting two or more cables to one terminal of a speaker

**Connecting a player**

You can enjoy the audio from players such as televisions, Blu-ray disc players, and game consoles.

**DIGITAL IN connection**

If the player has an optical or coaxial digital output terminal, connect using either a digital optical cable or digital coaxial cable to one of the DIGITAL IN terminals. To play, select the terminal name with the INPUT SELECTOR.

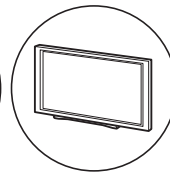
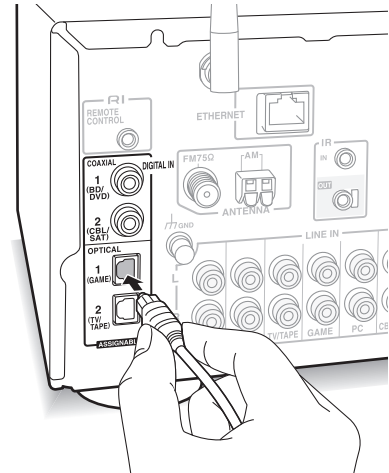

Note that this unit is equipped with an “Opt1 In Wakeup feature” so that when play starts on a player connected to the OPTICAL 1 (GAME) terminal, this unit comes on and the INPUT SELECTOR automatically changes. (⇒ 34)

- The DIGITAL IN terminals can only handle PCM signals.
- As the digital in optical jack of the unit has a cover, push in the cable straight against the cover as it is turned inside.

### LINE IN connection

Use an RCA cable to connect to the LINE OUT terminal on the player to one of the LINE IN terminal on this unit. To play, select the terminal name with the INPUT SELECTOR.

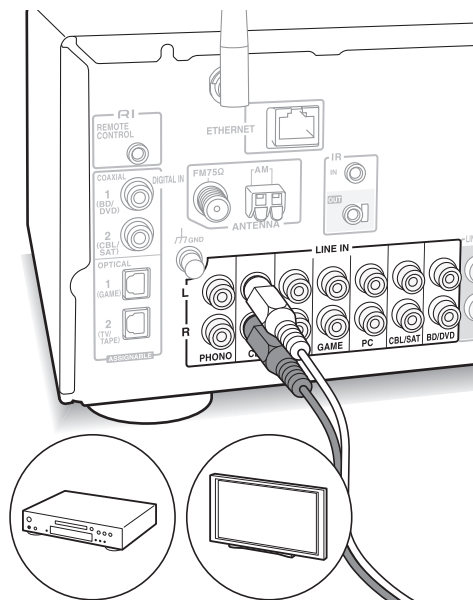

- Connect the record player (MM cartridge) to the LINE IN PHONO terminal. If the record player has a ground wire, connect it to the GND terminal of this unit. Note that if the connected record player has a built-in audio equalizer, connect it to a LINE IN terminal other than PHONO.



### AM/FM antenna connections

Connect the antennas to listen to AM/FM broadcast.

- You may be unable to receive radio transmissions in some areas even if you connect an antenna.

#### AM antenna

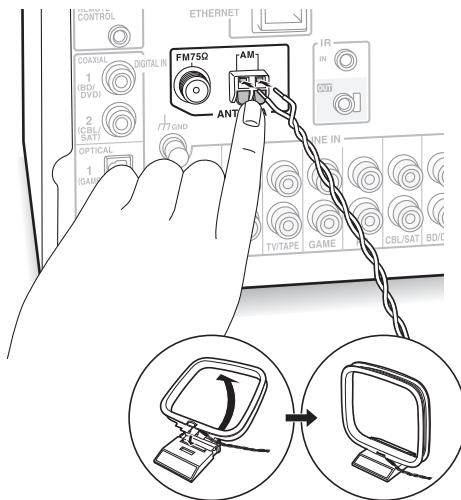

Assemble the AM loop antenna (supplied) and connect it to the AM terminal.

#### FM antenna

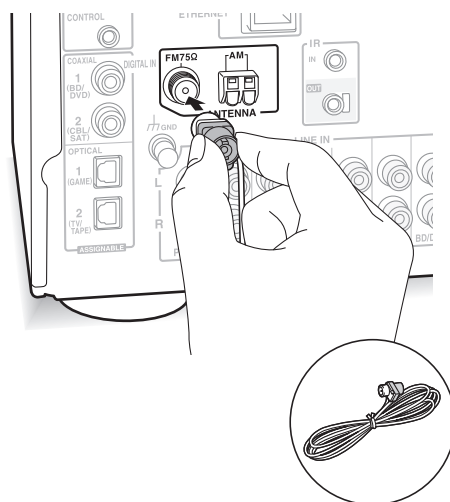

Connect the supplied FM antenna to the FM 75Ω terminal. Make sure the plug is pushed in all the way. Use a tack or similar to fix the antenna to a wall.

### Network connection

This enables you to enjoy Internet radio services (\*), Spotify, and the home network features. Connect to the same router as the smartphone, computer, or NAS you are going to use.

\* You need to be able to connect to the Internet.

### Wired connection

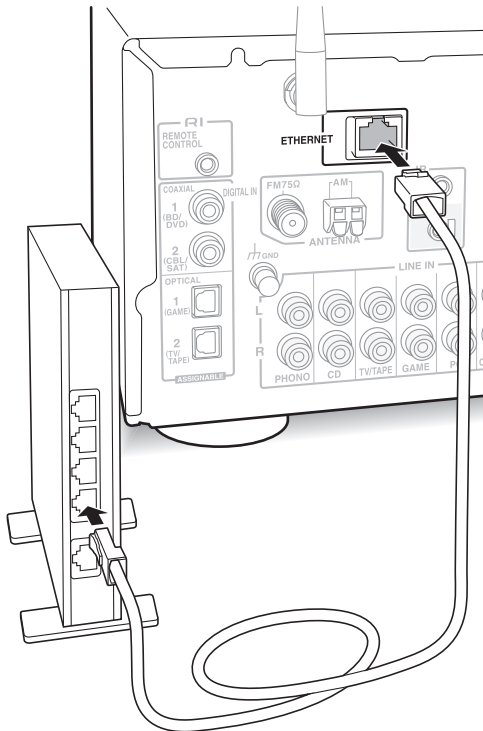

Connect to the router to this unit's ETHERNET port with an Ethernet cable (\*).

\* Use a shielded CAT5 Ethernet cable (straight-type).

### Wi-Fi® connection

Set up the Wi-Fi connection with the access point (a wireless LAN router, for example). Set with the remote control while watching the display on the main unit.

#### Make the following preparations.

Write down the SSID and password (key) of the access point if they are shown in the label of the main body.

\* The unit supports Wi-Fi connection with 2.4 GHz access point.

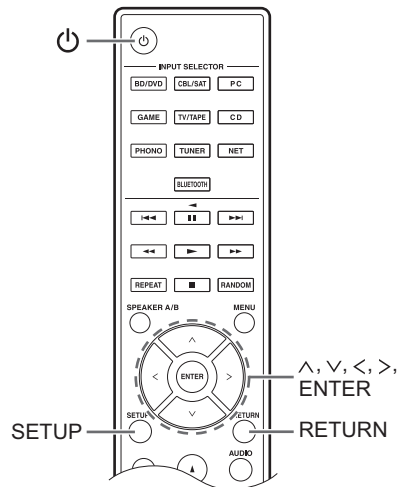

1. Turn on the unit.
2. Press the SETUP button.  
The setup menu appears on the display.
3. Use the direction (∧/∨) buttons to select "5. Network" on the display and press the ENTER button.
  - If it is not displayed, wait for a moment until the network feature starts.

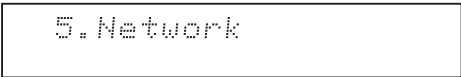

4. Use the direction (∧/∨) buttons to select "Wi-Fi" on the display, and then use the direction (</>) buttons to select "On".

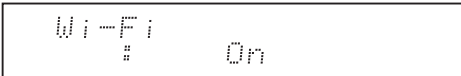

5. Use the direction ( ^ / v ) buttons to select “Wi-Fi Setup”, and then press the ENTER button when “Start” is displayed.

```

Wi-Fi Setup
[Enter]: Start

```

6. Press the ENTER button when “Scan Networks” is displayed.

```

Scan Networks
[Enter]: Next

```

7. Use the direction ( ^ / v ) buttons to select the SSID of the access point and press the ENTER button.

```

      SSID
      |
xxxxxx
[Enter]: Select

```

- If you changed the initial setting of the access point to skip password entry, step 8 is unnecessary.
  - If you changed the initial setting of the access point to hide the SSID, see “When the access point is not displayed”.
8. Press the direction ( ^ / v ) buttons to select an authentication method from the following and press the ENTER button.

**Enter Password:** Enter the password of the access point to establish connection.

Enter the password on the display.

- For information on how to input characters, see “Inputting characters” (⇒ 33) under “Various settings”.

**Push Button:** Use the automatic setting button of the access point to establish connection.

Hold down the automatic setting button of the access point for the necessary seconds, select “OK” on the display and press the ENTER button.

**PIN code:** Select this method when the automatic setting button of the access point is beyond the reach. The 8-digit PIN code is displayed. Register the displayed PIN code to the access point, select “OK” on the display and press the ENTER button. For how to register the PIN code to the access point, refer to its instruction manual.

#### When the access point is not displayed

Use the direction ( > ) button to select the “Other...” on the display and press the ENTER button. Input the SSID. When “Security” is displayed on the display, make the following settings according to the router setting.

- For information on how to input characters, see “Inputting characters” (⇒ 33) under “Various settings”.

#### ■ WPA/WPA2 method

Use the direction ( ^ / v ) buttons to select the “WPA” or “WPA2” on the display and press the ENTER button. Input the password.

#### ■ WEP method

Use the direction ( ^ / v ) buttons to select the “WEP” on the display and press the ENTER button. Input the password. When “Default Key” is displayed on the display, select the Default Key ID and press the ENTER button.

- If encryption setting has not been made on the wireless LAN router, use the direction ( ^ / v ) buttons to select the “None” on the “Security” display and press the ENTER button.

**When connection is successful:** The setup menu ends automatically.

- You can confirm the connection status by pressing the SETUP button and selecting “5. Network”-“Status”.

```

Status
# Connected

```

# Listening to Internet radio

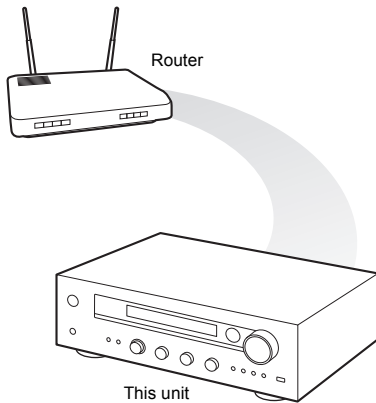

Some Internet radio services are registered to the unit by default. You can display the desired service, menu or radio station on the display and play the radio with simple remote control operation.

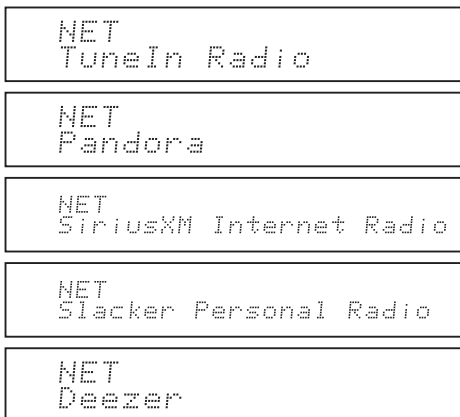

- Services available may vary depending on the region. If service from the service provider stops, use of that network services and contents might cease to be possible.

You can also listen to broadcast stations that are not included in the preset services by registering them to "My Favorites", which appears when you press the NET button.

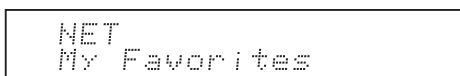

## TuneIn Radio

With the radio stations and the on-demand programs registered, TuneIn Radio is a service where you can enjoy music, sports and news from all over the world.

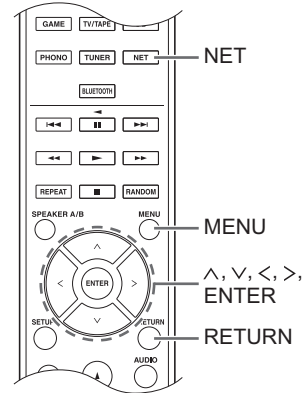

## Playing back

1. Press the NET button.
2. Use the direction ( $\wedge/\vee$ ) buttons to select "TuneIn Radio" on the display and press the ENTER button.

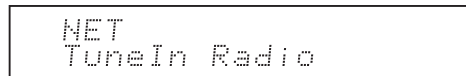

3. Press the direction ( $\wedge/\vee$ ) buttons to select a folder or menu item from the "TuneIn Radio" top list, and press the ENTER button.
  - The folders and menu items displayed on the top list are provided by the Internet radio service and categorised by genre, etc.
4. Use the direction ( $\wedge/\vee$ ) buttons to select a radio station and press the ENTER button. Playback starts.
  - If there are more than 10 items when you select a folder or menu, you can move through the list numbers 10 at a time each time you press the direction ( $\lt/\gt$ ) buttons.



### TuneIn Radio Menu

If you press the MENU button or ENTER button while playing TuneIn Radio, the following TuneIn Radio menu items appear. To use each function, use the direction ( ^ / v ) buttons to select a menu item on the display, and press the ENTER button. Menu items to be displayed differ depending on the broadcast station you are playing.

**Add to My Presets:** Registers radio stations and programs in your "My Presets" folder within TuneIn Radio. (When an item has been registered, the "My Presets" folder will be added to the "TuneIn Radio" top list.)

**Remove from My Presets:** Deletes a radio station or program from your "My Presets" folder.

**Clear recents:** Clears all radio stations and programs from the "Recents" folder within "TuneIn Radio" top list.

**Add to My Favorites:** Registers radio stations and programs in "My Favorites".

- Other menu items include "View Schedule", which displays the program guide of radio stations and "Report a problem".

### Regarding the TuneIn Radio Account

Creating an account on the TuneIn Radio website (tunein.com) and logging in it from the unit allows you to automatically add radio stations and programs to your "My Presets" folder on the unit as you follow them on the website.

**To log in from the unit:** Select "Login" - "I have a TuneIn account" in the "TuneIn Radio" top list on the unit, and then enter your user name and password. If you select "Login" - "Login with a registration code" to display a registration code, access My Info on the TuneIn Radio website, and specify the device identity with the registration code, you will stay logged into the website until you log out from the unit.

- For information on how to input characters, see "Inputting characters" (⇒ 33) under "Various settings".

## Pandora®-Getting Started

Pandora is a free, personalized Internet radio service that plays the music you know and helps you discover music you'll love.

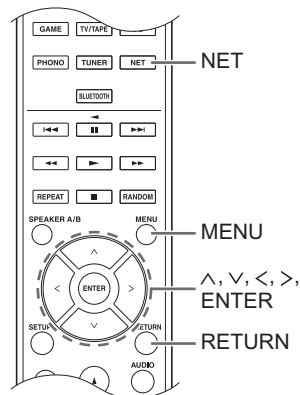

### Playing back

1. Press the NET button.
2. Use the direction ( ^ / v ) buttons to select "Pandora" on the display and press the ENTER button.

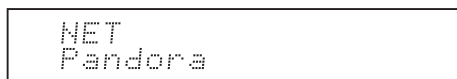

3. Use the direction ( ^ / v ) buttons to select "I have a Pandora Account" or "I'm new to Pandora" and then press the ENTER button. If you are new to Pandora select "I'm new to Pandora". You will see an activation code on the display. Please write down this code. Go to an Internet connected computer and point your browser to [www.pandora.com/onkyo](http://www.pandora.com/onkyo). Enter your activation code and then follow the instructions to create your Pandora account and your personalized Pandora stations. You can create your stations by entering your favorite tracks and artists when prompted. After you have created your account and stations you can return to your Onkyo receiver and press the ENTER button to begin listening to your personalized Pandora.

If you have an existing Pandora account, you can add your Pandora account to your Onkyo receiver by selecting "I have a Pandora Account" and logging in with your email and password.

- For information on how to input characters, see "Inputting characters" (⇒ 33) under "Various settings".
  - If you want to use multiple user accounts, see "Using Multiple Accounts" (⇒ 19). Login can be made from the "Users" display.
4. To play a station, use the direction ( ^ / v ) buttons to select the station from your station list, and then press the ENTER button. Playback starts.

## Create a New Station

Enter the name of a track, artist, or genre and Pandora will create a unique radio station for you based on the musical qualities of that track, artist, or genre.

### Pandora Menu

If you press the MENU button or ENTER button while playing Pandora, the following menu items appear.

**I like this track:** Give a track “thumbs-up” and Pandora will play more music like it.

**I don't like this track:** Give a track “thumbs-down” and Pandora will ban that track from the current station.

**Why is this track playing?:** Discover some of the musical attributes that Pandora uses to create your personal radio stations.

**I'm tired of this track:** If you are tired of a track, you can put the track to sleep and Pandora will not play it for one month.

**Create station from this artist:** Creates a radio station from this artist.

**Create station from this track:** Creates a radio station from this track.

**Delete this station:** This will permanently delete a station from your Pandora account. All of your thumbs feedback will be lost should you choose to re-create the station with the same track or artist.

**Rename this station:** Lets you rename the current radio station.

**Bookmark this artist:** Pandora will bookmark your favorite artist for your profile on [www.pandora.com](http://www.pandora.com).

**Bookmark this track:** Pandora will bookmark the current track and allow you to buy them all from Amazon or iTunes® in one step!

**Add to My Favorites:** Adds a station to My Favorites list.

## SiriusXM Internet Radio

If you want to listen to the service, you must subscribe. To subscribe go to [www.siriusxm.com/internetradio](http://www.siriusxm.com/internetradio) with your computer. When you subscribe, you will be provided with a username and password which has to be entered into the receiver. To use SiriusXM Internet Radio, you must have your receiver connected to the Internet. Using the remote control, follow these steps:

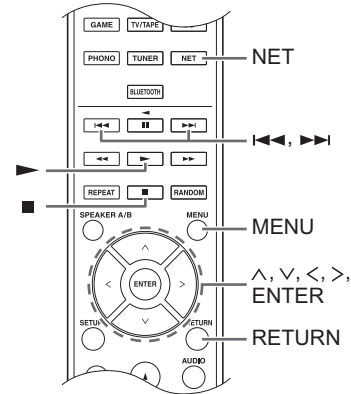

### Playing back

1. Press the NET button.
2. Use the direction ( $\wedge/\vee$ ) buttons to select “SiriusXM Internet Radio” on the display and press the ENTER button.

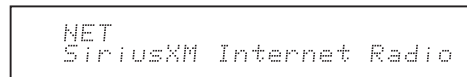

3. Select “Sign In”, and then press the ENTER button. If you have an existing SIRIUS account, you can sign in by selecting “Sign In”. Enter your user name and password on the display, or in Web Setup. If you don't know your username or password, call Sirius XM at (888) 539-7474 for assistance.
  - For information on how to input characters, see “Inputting characters” (⇒ 33) under “Various settings”.
  - If you want to use multiple user accounts, see “Using Multiple Accounts” (⇒ 19). Login can be made from the “Users” display.
4. Use the direction ( $\wedge/\vee$ ) buttons to select the category and then press the ENTER button. The channel list for the selected category appears on the display.
5. Use the direction ( $\wedge/\vee$ ) buttons to select the desired channel and then press the ENTER button. The playback starts and you can listen to SiriusXM Internet Radio. You can control the tracks with the buttons on the remote control.

Enabled buttons:  $\blacktriangleright$ ,  $\blacksquare$ ,  $\lll$ ,  $\lll$

**SiriusXM Internet Radio Menu**

If you press the MENU button or ENTER button while playing SiriusXM Internet Radio, the following menu items appear.

- Add to My Favorites:** Adds a station to My Favorites list.
- Add to Presets:** Adds the currently playing station to presets list.
- Delete from Presets:** Deletes the currently playing station from presets list.

**Slacker Personal Radio**

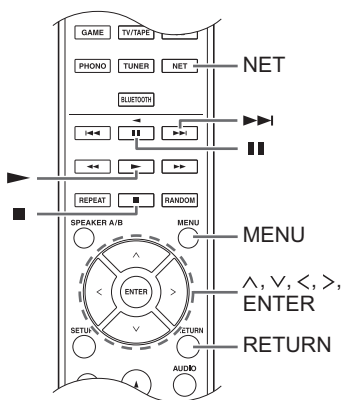

**Playing back**

1. Press the NET button.
2. Use the direction ( ^ / v ) buttons to select "Slacker Personal Radio" on the display and press the ENTER button.

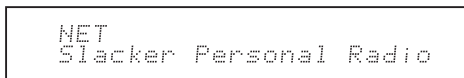

3. If you do not have an account, create one on the Slacker website ([www.slacker.com](http://www.slacker.com)) with your computer. If you already have a Slacker account, select "Sign in to your account" and then press the ENTER button. You can enter information from the remote control.
  - For information on how to input characters, see "Inputting characters" (⇒ 33) under "Various settings".
4. If there are no mistakes in the information you have entered, use the direction ( ^ / v / < / > ) buttons to select "OK" then press the ENTER button. An account information confirmation appears on the display.
5. If you do not have an account, select "Access without Sign In" and press the ENTER button to use a restricted version of the service. Note that use will be restricted.
  - If you want to use multiple user accounts, see "Using Multiple Accounts". Login can be made from the "Users" display.
6. Use the direction ( ^ / v ) buttons to select a menu item and then press the ENTER button. To sign out, use the

direction ( ^ / v ) buttons to select "Sign out" and then press the ENTER button.

7. Use the direction ( ^ / v ) buttons to select a station and then press the ENTER button or the playback ( ▶ ) button to start playback from the station. The playback starts.
8. You can control the tracks with the buttons on the remote control.  
Enabled buttons: ▶, ||, ■, ▶▶

**Slacker Personal Radio Menu**

If you press the MENU button or ENTER button while playing Slacker Personal Radio, the following menu items appear.

- Rate Song as Favorite:** Stores information to server, making it more likely that the song will be played again.
- Ban Song:** Stores information to server, making it less likely that the song will be played again.
- Ban Artist:** Stores information to server, making it less likely that the songs from this artist will be played again.
- Mark Favorite:** Adds the currently playing station to your favorites.
- Unmark Favorite:** Deletes the currently playing station from your favorites.
- Add song to Library:** Adds the currently playing track to your library.
- Delete song from Library:** Deletes the currently playing track from your library.
- Add to My Favorites:** Adds a station or song to My Favorites list.

**Using Multiple Accounts**

The receiver supports multiple user accounts, which means you can freely switch between several logins. After registering user accounts, login is performed from the "Users" display.

Press the MENU button while "Users" is displayed. "Add new user", "Remove this user" menu appear. You can either store a new user account, or delete an existing one.

- Some of the services don't allow the use of multiple user accounts.
- You can store up to 10 user accounts.
- To switch between accounts you must first log out from the current account, and log in again on the "Users" display.

## One touch play with the BGM button

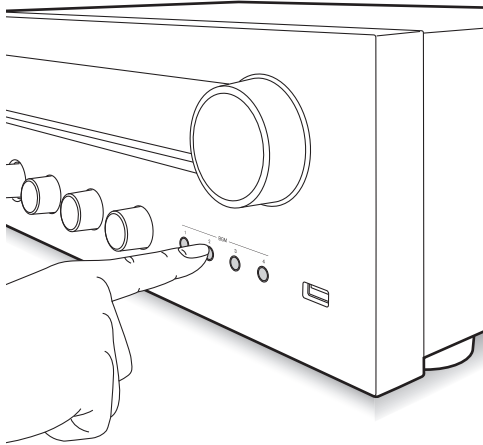

By registering your favorite Internet radio stations to BGM buttons, you can start play with one press of a button.

- To register, press and hold one of the BGM 1 to 4 buttons while playing the station. "Preset Written" appears on the display, and the radio station being played is registered. If there is already a radio station registered, it is replaced.

Preset Written

- Press one of the BGM 1 to 4 buttons to play. If you press these buttons when the unit is in standby mode, it comes on and play starts.

## Registering your favorite radio stations (My Favorites)

You can listen to your favorite radio stations by registering them to "My Favorites", which appears when you press the NET button. "My Favorites" allows you to register up to 40 stations.

NET  
My Favorites

- This unit supports Internet radio stations that use the PLS, M3U and podcast (RSS) formats. Even if an Internet radio station uses one of these formats, playback might not always be possible depending on the type of data and playback format.

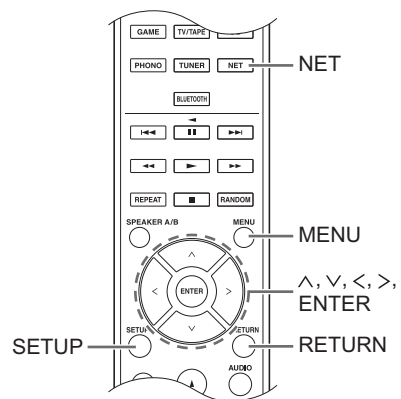

### ■ Registering a station in the "My Favorites"

There are two ways to register your favorite radio stations to "My Favorites": you can either use a PC or operate the unit.

#### Registering a station with PC

You will need the name and URL of the radio station to add during the storing procedure, so check them in advance. You have to connect your PC and this unit to the same network.

Input the IP address of the unit into an Internet browser on the PC to access Web Setup and register a station.

- Press the SETUP button.
- Use the direction ( $\wedge/\vee$ ) buttons to select "5. Network" on the display and press the ENTER button.

5. Network

- Use the direction (∧/∨) buttons to display "IP Address".

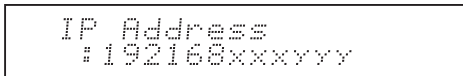

Make a note of the IP address.

- Turn the PC on and open Internet Explorer or another Internet browser.
- Input this unit's IP address into the Internet browser URL field. If the IP address displayed on the unit is "1 9 2 1 6 8 x x x y y", input "192.168.xxx.yyy" into the URL field.

If the IP address is "1 9 2 1 6 8 x x y y", input "192.168.xx.yyy" into the URL field.

If the IP address is "1 9 2 1 6 8 x y y", input "192.168.x.yyy" into the URL field.

This unit's Web Setup information screen will open in the Internet browser.

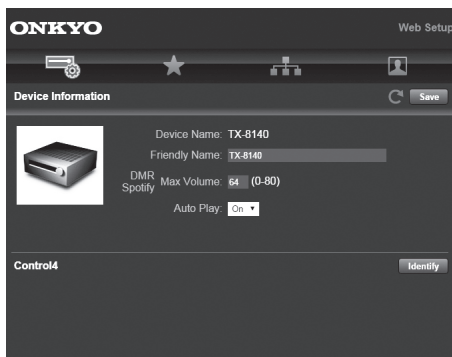

- Click the "★" tab and input the name and URL of the Internet radio station.
- Click "Save" to finish registering that Internet radio station.

### Registering a station by operating the unit

You will need the name and URL of the radio station to add during the storing procedure, so check them in advance.

Input radio station information directly into "My Favorites" of the unit.

- Press the NET button.
- Use the direction (∧/∨) buttons to select "My Favorites" on the display and press the ENTER button.

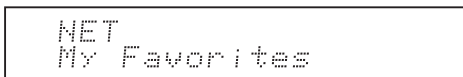

- Press the direction (∧/∨/</>) buttons to select a number to which a radio station is not registered, and press the MENU button.

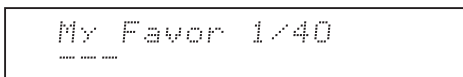

- Use the direction (∧/∨) buttons to select "Create new station" and press the ENTER button.

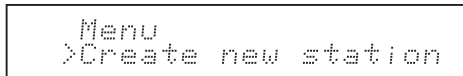

- Input the name of the radio station.
  - For information on how to input characters, see "Inputting characters" (⇒ 33) under "Various settings".
- Input the URL of the radio station.

### ■ Playing a registered radio station

- Press the NET button.
- Use the direction (∧/∨) buttons to select "My Favorites" on the display and press the ENTER button.

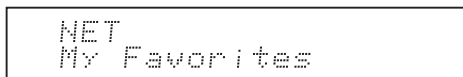

- Use the direction (∧/∨/</>) buttons to select a radio station and press the ENTER button. Playback starts.

### To remove a radio station that has been added:

- Select the radio station in the "My Favorites" and press the MENU button.
- Use the direction (∧/∨) buttons to select "Delete from My Favorites" and press the ENTER button. A message requesting confirmation appears.
- Press the ENTER button.

### To change the name of a radio station that has been added:

- Select the radio station in the "My Favorites" and press the MENU button.
- Use the direction (∧/∨) buttons to select "Rename this station" and press the ENTER button.
- Input the name of the radio station.
  - For information on how to input characters, see "Inputting characters" (⇒ 33) under "Various settings".

# Playing music with *Bluetooth*<sup>®</sup> functions

You can wirelessly enjoy music files stored in a smartphone or other *Bluetooth* enabled device. The coverage area is 48 feet (15 meters).

## Pairing

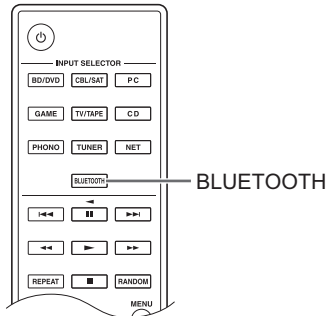

Pairing is necessary when connecting the *Bluetooth* enabled device for the first time. Before starting the procedure, learn how to enable the *Bluetooth* setting function and to connect with other devices on the *Bluetooth* enabled device.

1. Press the BLUETOOTH button of the remote control. The unit begins pairing and "Now Pairing..." is displayed.

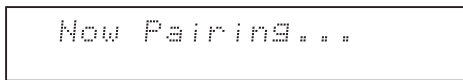

2. While "Now Pairing..." is on the display, complete connection on the *Bluetooth* enabled device in the nearby area within about 2 minutes.

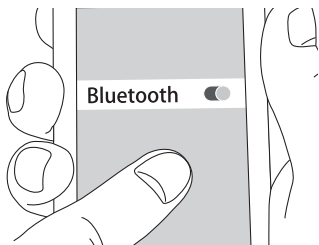

If the name of this unit is displayed on the *Bluetooth* enabled device's display, select this unit. Pairing will end after a short time.

- If a password is requested, enter "0000".
- You can pair with another *Bluetooth* enabled device by pressing and holding the ENTER button of the unit until "Now Pairing..." is on the display. This unit can store the data of up to 8 paired devices.

## Playback

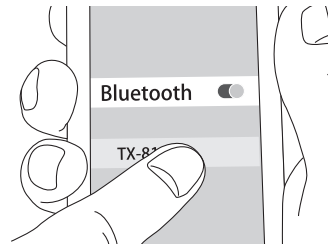

If the unit is on and the *Bluetooth* enabled device is connected, the input will be automatically switched to "BLUETOOTH". Play music in this state.

If the volume setting on the *Bluetooth* enabled device is low, the sound will not be output from this unit, so adjust the volume to an appropriate level.

If "3. Hardware"-*"Bluetooth Wakeup"* (⇒ 34) is set to "On" in the setup menu, then once you start connection on a *Bluetooth* enabled device, this unit switches on automatically.

- It may take about a minute until connection is established when the unit is on since the *Bluetooth* function takes some time to start up.
- Due to the characteristics of *Bluetooth* wireless technology, the sound produced on this unit may slightly be behind the sound played on the *Bluetooth* enabled device.

# Playing music with Spotify

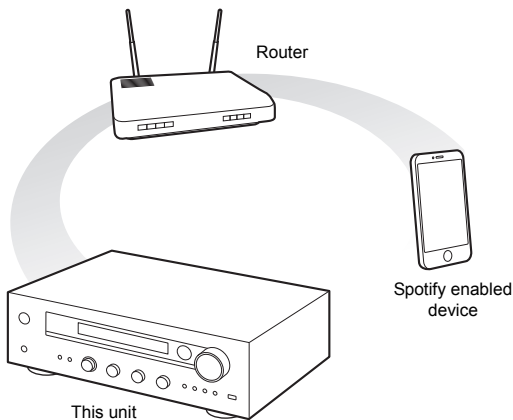

To use Spotify, you must install the Spotify app on your smartphone or tablet and create a Spotify Premium account.

- The unit and smartphone or tablet must be connected to the same router.
- Information on how to set up Spotify can be found here:  
[www.spotify.com/connect/](http://www.spotify.com/connect/)
- The Spotify software is subject to third party licenses found here:  
[www.spotify.com/connect/third-party-licenses](http://www.spotify.com/connect/third-party-licenses)

## Playback

---

1. Switch the Wi-Fi setting on the smartphone or tablet on and start the Spotify app.
2. On the track playback screen, click the Connect icon and select the unit. Spotify's streaming will start.

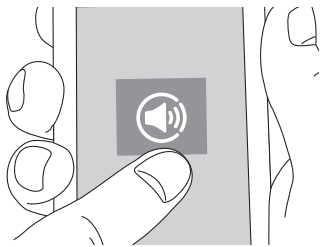

If the volume setting on the Spotify enabled device is low, the sound will not be output from this unit, so adjust the volume to an appropriate level.

If "3. Hardware"- "Network Standby" (⇒ 34) is set to "On" in the setup menu, then once Spotify starts, this unit switches on automatically and the "NET" input source is selected. Even if this setting is "Off", if the unit is already on then the "NET" input source is selected.

# Playing tracks stored on a USB storage device

You can connect a USB storage device to the USB port on the front panel and play music files on it.

- You can play high-res sources in formats such as WAV, FLAC, or DSD files distributed over the Internet. For information on supported devices and file formats, see "Compatible devices/media/file formats" (⇒ 40).

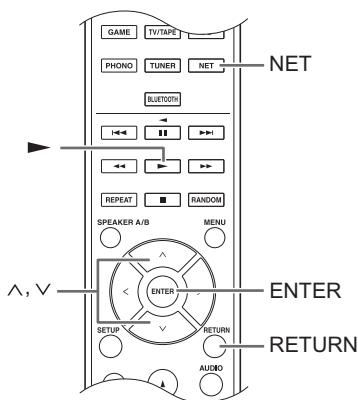
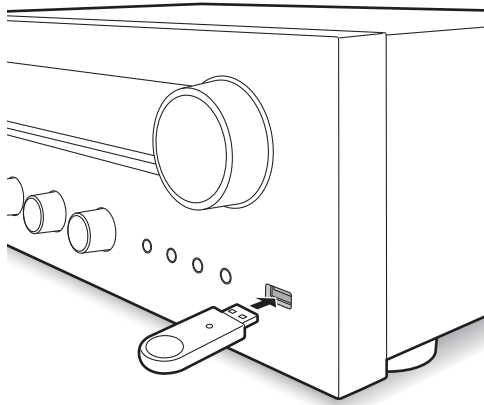

1. Press the NET button.
2. Use the direction ( $\wedge/\vee$ ) buttons to select "USB" on the display and press the ENTER button.

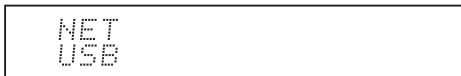

3. Connect a USB storage to the USB port.  
When a USB storage is detected, "USB" appears on the display. If "USB" indicator flashes, check whether the USB storage device is plugged in properly.
  - Depending on the USB storage device, reading data from it may take some time.
  - If the media you connect is not supported or cannot be connected properly, the message "No storage" will be displayed.
4. Press the ENTER button.  
The name of the track or folder appears.

5. Use the direction ( $\wedge/\vee$ ) buttons to select a track and press the playback ( $\blacktriangleright$ ) button.
  - If you have selected a folder, when you press the playback ( $\blacktriangleright$ ) button, play starts from the first track in the folder. You can select tracks inside the folder by pressing the ENTER button.
  - Only the music files in the same level of the folder are played. You can also set repeat playback mode to Full and play all tracks stored on the USB storage device.
  - The USB port of this unit conforms to the USB 1.1 standard. Depending on the content being played, the transfer rate may not be sufficient, which can cause interruptions.



# Home network functions

## Playing music stored on DLNA-compatible devices

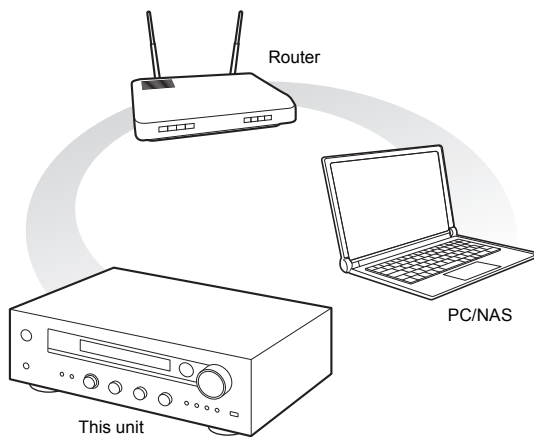

The unit allows you to use DLNA (\*) to play music files stored on a PC or a NAS device. You can play high-res sources in formats such as WAV, FLAC, or DSD files distributed over the Internet. For information on supported devices and file formats, see "Compatible devices/media/file formats" (⇒ 40).

- You must connect the unit and PC or NAS to the same router.

\* Digital Living Network Alliance (DLNA) can be referred to as a technology standard or the industry group to develop the technology standard to interconnect and use AV components, PCs and other devices in a home network.

## ■ Setting up Windows Media® Player

### Windows Media® Player 11

1. Turn on your PC and start Windows Media® Player 11.
2. In the "Library" menu, select "Media Sharing" to open a dialog box.
3. Select the "Share my media" check box and click "OK" to display the compatible devices.
4. Select this unit and click "Allow".
  - The icon of this unit is checked when you click it.
5. Click "OK" to close the dialog box.

### Windows Media® Player 12

1. Turn on your PC and start Windows Media® Player 12.
2. In the "Stream" menu, select "Turn on media streaming" to open a dialog box.
  - If media streaming is already turned on, select "More streaming options..." in the "Stream" menu to list players in the network, and then go to step 4.
3. Click "Turn on media streaming" to list players in the network.
4. Select this unit in "Media streaming options" and check that it is set to "Allowed".
5. Click "OK" to close the dialog box.
6. When using the Play To feature, open the "Stream" menu and check that "Allow remote control of my Player..." is checked.

## ■ Playing music files by operating the unit

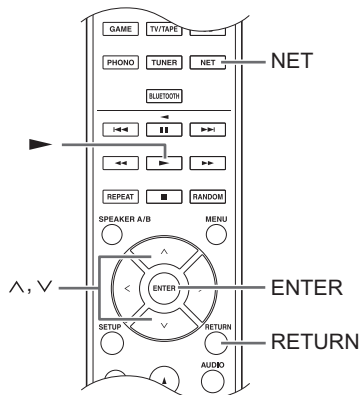

You can play music files stored on a server by operating the unit.

1. Start the server (Windows Media® Player 11, Windows Media® Player 12, or NAS device) containing the music files to play.
2. Press the NET button.
3. Use the direction (^/v) buttons to select "DLNA" on the display and press the ENTER button.



4. Use the direction (^/v) buttons to select the server and press the ENTER button.

The server folder will be shown.

  - You can check the server name of your PC from the PC properties.
  - Depending on server functions or sharing settings, some contents might not be shown.
5. Use the direction (^/v) buttons to select the audio file that you want to play, and press the ENTER button or playback (▶) button.
  - If information cannot be retrieved from a server, "No Item" will appear on the display. If this occurs, check the server and network connections.

## ■ Using the Play To feature

Using a controller device or PC that complies with the DLNA standard, you can play music files stored on a server.

In this section, we explain the steps to perform remote playback with Windows Media® Player 12.

1. Turn this unit on.
2. Turn on your PC and start Windows Media® Player 12.
3. Select the file that you want to play in Windows Media® Player 12 and right-click it.

This opens a pop-up menu.

- To use the Play To feature with audio files on a different server, open that server from the list that appears under “Other Libraries” and select the audio file that you want to play.
4. Click the “Play to” and select this unit from the Play To list.

Open the Windows Media® Player 12 “Play To” dialog box, and start playback from this unit.

Use the “Play To” dialog box to control remote playback.

- Remote playback is not possible when you are performing a different operation that uses the network on the unit or playing a music file stored on a USB storage on the unit.
  - If your PC is running on Windows® 8, click “Play To”, and then select this unit.
5. Adjust the volume using the volume bar on the “Play To” dialog box.
    - The default maximum volume level is 64. You can change the level using Web Setup. For information on how to access Web Setup, see “Registering your favorite radio stations (My Favorites)” (⇒ 20) under “Listening to Internet radio”.
    - Some times, the volume displayed on the “Play To” dialog box may differ from that appeared on the display of the unit.
    - When the volume is adjusted from the unit, the value is not reflected in the “Play To” dialog box.
  - Depending on the version of Windows Media® Player, the names of the items you need to select may differ from the explanation here.

## Music streaming from a shared folder (Home Media)

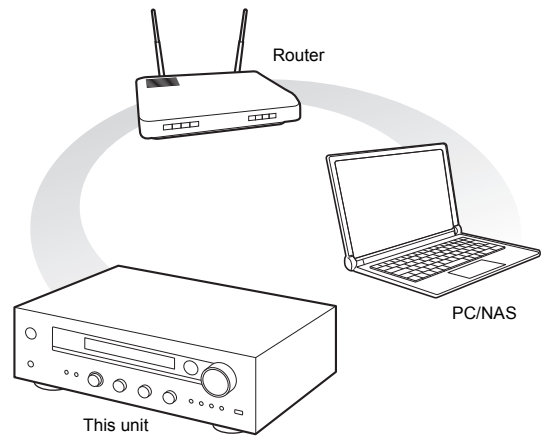

A shared folder is configured in a network device such as a PC or a NAS device for access from other users. You can play music files in a shared folder on your PC or NAS device connected to the same home network as that of this unit. You can play high-res sources in formats such as WAV, FLAC, or DSD files distributed over the Internet. For information on supported devices and file formats, see “Compatible devices/media/file formats” (⇒ 40).

- You must connect the unit and PC or NAS to the same router.
- You must configure the relevant settings of the PC or NAS in advance. For information on the setup, see the instruction manual for each device. In this section, we explain the setup with Windows® 7 and Windows® 8.

## ■ Setting up Windows

### Configuring the sharing options

1. Turn the PC on.
2. Select “Choose homegroup and sharing options” in the “Control Panel”.
  - If the menu is not displayed, check that “View by” is set to “Category”.
3. Select “Change advanced sharing settings”.
4. Check that the following radio buttons are selected in the “Home or Work” (Windows 7) or “Private” and “All Networks” (Windows 8):
  - “Turn on network discovery”
  - “Turn on file and printer sharing”
  - “Turn on sharing so anyone with network access can read and write files in the Public folders”
  - “Turn off password protected sharing”
5. Select “Save Changes” and click “OK” in the dialog box.

## Creating a shared folder

1. Select and right-click the folder to share.
2. Select "Properties".
3. Select "Advanced Sharing" on the "Sharing" tab.
4. Select the "Share this folder" check box and click "OK".
5. Click "Share" for "Network File and Folder Sharing".
6. Select "Everyone" from the pull-down menu. Click "Add" and click "Share".
  - To set a user name and password to a shared folder, set "Permissions" in "Advanced Sharing" in the "Sharing" tab.
  - Check that a workgroup is set.

## ■ Playing back

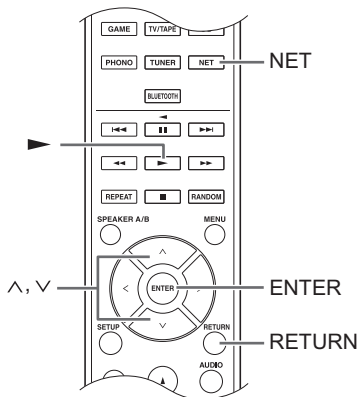

You can play music files in a shared folder stored on each device by operating the unit.

1. Press the NET button.
2. Use the direction (^/v) buttons to select "Home Media" on the display and press the ENTER button.

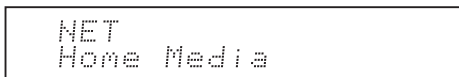

3. Use the direction (^/v) buttons to select the server that you want to use and press the ENTER button.
  - You can check the server name of your PC from the PC properties.
4. Use the direction (^/v) buttons to select the shared folder that you want to use and press the ENTER button.
5. When a user name and password are required, input the necessary account information.
  - For information on how to input characters, see "Inputting characters" (⇒ 33) under "Various settings".
  - Use the account information set when you created the shared folder. After inputting the account information once, it is saved, so you will not need to input it the next time.
6. Press the direction (^/v) buttons to select the music file to play and press the ENTER button or playback (▶) button.

# Listening to the sound from a connected player

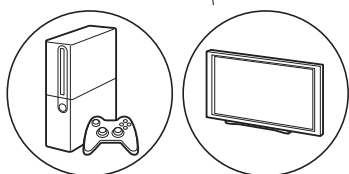
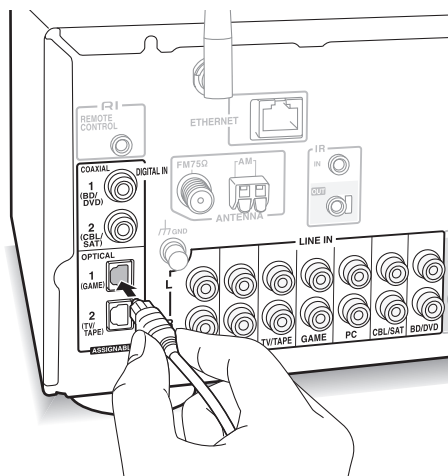

You can enjoy the audio from players such as televisions, Blu-ray disc players, and game consoles. See “Connecting a player” (⇒ 12) for connection.

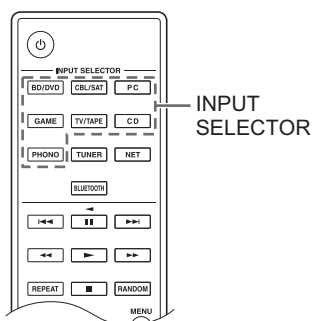

1. Switch the input source with the INPUT SELECTOR button to match the terminals you have connected the players to. (If you connected to the BD/DVD terminal, select “BD/DVD”.)
2. Start play on the player.  
If “3. Hardware”-“Opt1 In Wakeup” (⇒ 34) is set to “On” in the setup menu, then once play starts on a device connected to the OPTICAL1 terminal, this unit switches on automatically and the input source is selected.
  - While playing an analog source, if a digital signal is input to the input source with the same name, play switches to the digital signal.

By connecting an Onkyo component with RI jack to the unit by using an RI cable and an RCA cable, you can link the unit’s power and input selection and enable operation with this unit’s remote control. For details, refer to the instruction manual of the component with the RI jack.

- Part of the function may not operate even if it is connected via RI depending on the equipment.
- To connect to the RI dock and enable the link, you must rename the input selectors on the unit. Turn the INPUT control on the main unit to select “GAME” on the display. Next press and hold the ENTER button for about 3 seconds to change the input source name to “DOCK”.

# Listening to AM/FM radio

## Tuning into a radio station

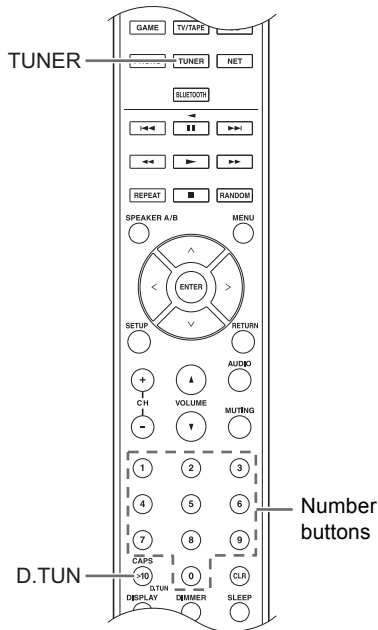
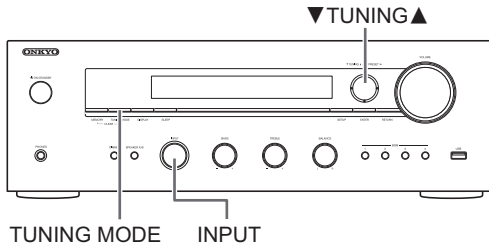

### ■ Tuning into stations automatically

1. Turn the INPUT control on the main unit to select “AM” or “FM” on the display.
2. Press the TUNING MODE button so that the “AUTO” indicator on the display lights.
3. Press the ▼TUNING▲ buttons to start automatic tuning.
  - Searching automatically stops when a station is found. When tuned into a radio station, the “▶TUNED◀” indicator on the display lights. When tuned into a stereo FM radio station, the “FM STEREO” indicator lights.

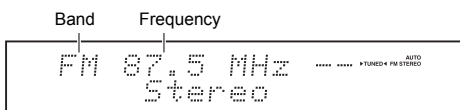

**When the reception of FM broadcasts is poor:** If the radio wave reception is weak or there is excess noise in your location, refer to “Tuning into stations manually” on the next section to change the reception setting to

monaural. This can minimise the noise and audio interruptions.

### ■ Tuning into stations manually

If you tune into an FM radio station manually, it will be received in monaural sound.

1. Turn the INPUT control on the main unit to select “AM” or “FM” on the display.
2. Press the TUNING MODE button so that the “AUTO” indicator on the display goes off.
3. Press the ▼TUNING▲ buttons to select the desired radio station.
  - The frequency changes by 1 step each time you press the button. The frequency changes continuously if the button is held down and stops when the button is released.
  - You can change the frequency step. See “3. Hardware”-“AM / FM FreqStep” (⇒ 34) of the Setup menu.

### ■ Tuning into stations by frequency

It allows you to directly enter the frequency of the radio station you want to listen to.

1. Press the TUNER button of the remote control repeatedly to select either “AM” or “FM” on the display.
2. Press D.TUN button.
3. Using the number buttons, enter the frequency of the radio station within 8 seconds.
  - To enter 87.5 (FM), for example, press [8], [7], [5]. If the entered number is incorrect, press the D.TUN button again and re-enter the number.

### One touch reception with the BGM button

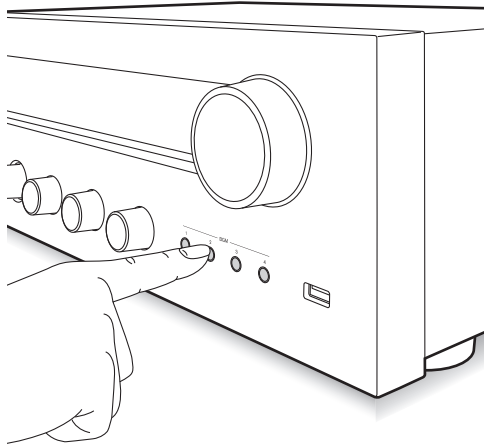

By registering your favorite radio stations to BGM buttons, you can receive it with one press of a button.

1. To register, press and hold one of the BGM 1 to 4 buttons while receiving the station. "Preset Written" appears on the display, and the radio station being received is registered. If there is already a radio station registered, it is replaced.

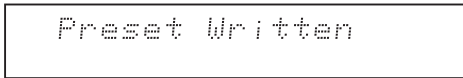

2. Press one of the BGM buttons 1 to 4 to listen to the stations you have preset. If you press these buttons when the unit is in standby mode, it comes on and starts receiving the station.

### Presetting a radio station

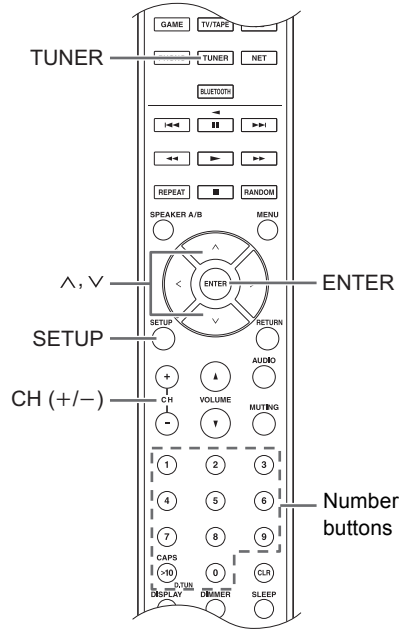
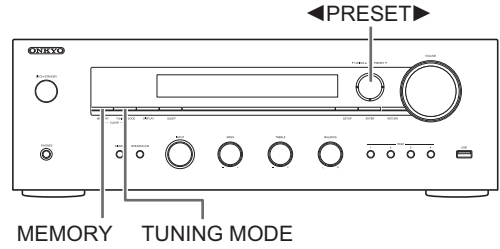

It allows you to register up to 40 of your favorite radio stations. Registering radio stations in advance allows you to tune into your radio station of choice directly.

#### ■ Registering radio stations

1. Tune into the AM/FM radio station you want to register.
2. Press the MEMORY button on the unit.
3. Press the ◀PRESET▶ buttons several times to select a number between 1 and 40 while the preset number is flashing (about 8 seconds).
4. Press the MEMORY button again to register the station.  
The preset number stops flashing and lights to indicate that the station is registered.

**■ Selecting preset stations**

1. Press the TUNER button of the remote control repeatedly to select either "AM" or "FM" on the display.
2. Press CH (+/-) buttons to select a preset number.
  - You can also select by directly entering the preset number with the number buttons. Alternatively you can press the ◀PRESET▶ buttons on the unit.

**Naming a preset radio station:**

1. Press the SETUP button of the remote control while a preset number is displayed, use the direction (^/∨) buttons to select "4. Source", and press the ENTER button.
2. Use the direction (^/∨) buttons to select "Name Edit" and press the ENTER button.
3. Enter a name up to 10 characters long.
  - For information on how to input characters, see "Inputting characters" (⇒ 33) under "Various settings".

**Erasing a preset radio station:**

1. Press and hold the MEMORY button on the main unit and press the TUNING MODE button to delete the preset number.  
The preset number is deleted, and the number on the display goes off.

# Various settings

## Adjusting sound quality, etc.

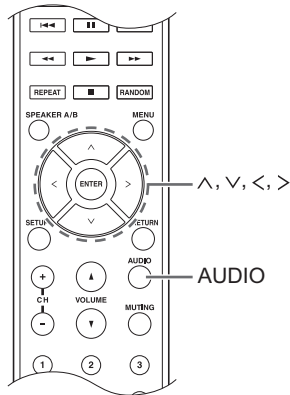

1. Press the AUDIO button.
2. Press the direction ( $\wedge/\vee$ ) buttons to select the setting you want to adjust.
3. Press the direction ( $</>$ ) buttons to adjust the setting.

### ■ Direct

You can use the Direct feature that outputs pure sound as it was intended by bypassing the tone control circuits during play.

#### On

Off (default setting)

- "DIRECT" appears on the display when "On" is selected.
- "Bass" and "Treble" are disabled when "On" is selected.

### ■ Bass

Adjusts the bass level.

Select between **-10 dB** and **+10 dB** in 2 dB increments. (default setting: 0 dB)

### ■ Treble

Adjusts the treble level.

Select between **-10 dB** and **+10 dB** in 2 dB increments. (default setting: 0 dB)

### ■ Balance

Adjusts the audio output balance between the left and right speakers.

Select between **L+10** and **R+10** in 2 steps increments. (default setting: 0)

## Sleep timer

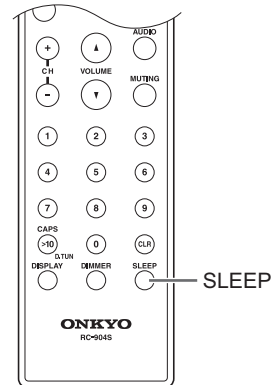

With the sleep timer, you can set the unit so that it automatically turns off after a specified period.

1. Press the SLEEP button repeatedly to select the time.
  - With the SLEEP button, you can set the sleep time from 90 to 10 minutes in 10 minute increments. The setting is complete 5 seconds after you have displayed the desired time.
  - When the sleep timer has been set, "SLEEP" appears on the display.

■ **Checking the remaining time:** If you press the SLEEP button, the remaining time until the unit will be put into standby mode appears.

■ **To cancel the sleep timer:** Press the SLEEP button repeatedly until "SLEEP" disappears.



## Inputting characters

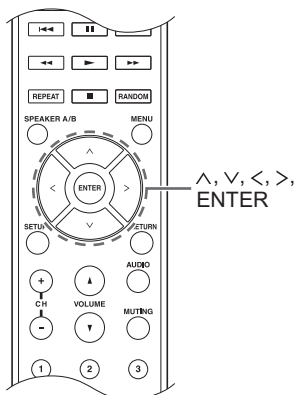

While performing network settings or in the Internet radio menu, etc., when the following appears on the display, you can enter characters. Enter characters using the following procedure.

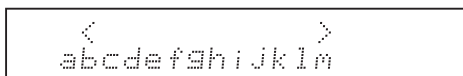

1. Use the direction ( $\wedge/\vee/</>$ ) buttons to select a character or symbol and press the ENTER button. Repeat this procedure to input more. The following characters can be used.

a

a	b	c	d	e	f	g	h	i	j	k	l	m
n	o	p	q	r	s	t	u	v	w	x	y	z
1	2	3	4	5	6	7	8	9	0	-	^	\
,	.	/	:	@	[	]	S	p	a	c	e	
A/a						<-> B S O K						

b

A	B	C	D	E	F	G	H	I	J	K	L	M
N	O	P	Q	R	S	T	U	V	W	X	Y	Z
!	"	#	\$	%	&	'	(	)	_	=	~	
<	>	?	+	*	`	{	}	S	p	a	c	e
A/a						<-> B S O K						

- **A/a\***: Changes the characters shown. (a → b)
  - **Space**: Inputs a blank space that is one character wide.
  - **← (left) / → (right)**: Moves the cursor in the text input area.
  - **BS (backspace)\*\***: Deletes characters to the left of the cursor. Move the cursor left.
  - **ää**: When this is displayed, you can select it to change the characters shown to umlaut characters.
- \* You can also change them by pressing the [ $>$ 10] button.
- \*\* You can press the CLR button to delete all the input characters at once.

2. After completing input, use the direction ( $\wedge/\vee/</>$ ) buttons to select "OK" and press the ENTER button.

## Setup menu

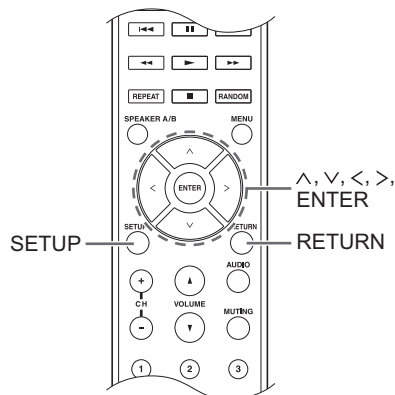

The unit allows you to configure advanced settings to provide you with an even better experience. Set using the following procedure.

1. Press the SETUP button.
2. Use the direction ( $\wedge/\vee$ ) buttons to select the setting you want to change and press the ENTER button.
  - To cancel the operation, press the SETUP button.
3. Use the direction ( $\wedge/\vee$ ) buttons to select the sub menu you want to change.
4. Use the direction ( $</>$ ) buttons to change setting values.
5. After you complete making settings, press the SETUP button to quit the menu.

### ■ 1. Digital Audio Input

You can change input assignment between the input selectors and DIGITAL IN COAXIAL/OPTICAL 1 to 2 jacks. If you do not assign a jack, select "----".

The default setting is as follows:

<b>COAXIAL1</b>	:	<b>BD/DVD</b>
<b>COAXIAL2</b>	:	<b>CBL/SAT</b>
<b>OPTICAL1</b>	:	<b>GAME</b>
<b>OPTICAL2</b>	:	<b>TV/TAPE</b>

- Sampling rates for PCM signals (stereo, mono) from a digital input are 32 kHz, 44.1 kHz, 48 kHz, 88.2 kHz, 96 kHz/16 bit, 20 bit, and 24 bit.

### ■ 2. Main Volume

Make the volume setting.

**Maximum Volume**: Set the maximum volume for the volume control.

**Off** (default setting)  
**30 to 79**

**PowerOn Volume**: Set the volume for when the unit is turned on.

**Last** (default setting): The volume is the same as it was when the unit was last switched to standby.

**Min to Max**

**HeadphoneLevel:** Set the volume level for when headphones are used.

–12 dB to +12 dB (default setting: 0 dB)

### ■ 3. Hardware

**Speaker Impedance:** If any of the connected speakers have 4 Ω or more to less than 6 Ω impedance, or if you have connected a different set of left and right speakers to the SPEAKERS A/B terminals, set the impedance to 4 Ω.

- Reduce the volume to minimum before setting.  
6 Ω (default setting)  
4 Ω

**Auto Standby:** The unit will automatically enter standby mode (\*) if there is no operation for 20 minutes with no audio signal input.

**On**

**Off** (default setting)

- \* Becomes the HYBRID STANDBY mode, which keeps the increase in power consumption to a minimum, when any of Network Standby, Bluetooth Wakeup, or Opt1 In Wakeup are on.

**Network Standby:** You can turn on the power of the unit via network using an application such as Onkyo Remote.

**On**

**Off** (default setting)

- When “Network Standby” is used, the power consumption increases even when the unit is on standby. However, the increase in power consumption is kept to a minimum by automatically entering the HYBRID STANDBY mode, where only the essential circuit is operating.
- If it is not displayed, wait for a moment until the network feature starts.

**Bluetooth Wakeup:** This function wakes up the unit on standby by connecting a *Bluetooth* enabled device.

**On**

**Off** (default setting)

- Setting to “On” increases the power consumption even when the unit is on standby. However, the increase in power consumption is kept to a minimum by automatically entering the HYBRID STANDBY mode, where only the essential circuit is operating.
- This setting is fixed to “Off” if “6. Bluetooth”-“Auto In Change” (⇒ 35) is set to “Off”.
- If it is not displayed, wait for a moment until the network feature starts.

**Opt1 In Wakeup:** When an audio signal is input through the OPTICAL1 terminal while this unit is in standby, this feature automatically detects it.

**Off** (default setting)

**On:** This unit is turned on and outputs the audio.

- When a cable is connected to the OPTICAL1 terminal and this setting is enabled, power consumption increases even when the unit is on standby, however, the increase in power consumption is kept to a minimum by automatically entering the HYBRID STANDBY mode, where only essential circuits are operating.

**AM / FM FreqStep:** Changes the AM/FM radio frequency step.

**9kHz / 0.05MHz:** The frequency is adjusted in increments of 9 kHz/0.05 MHz.

**10kHz / 0.2MHz** (default setting): The frequency is adjusted in increments of 10 kHz/0.2 MHz.

### ■ 4. Source

**IntelliVolume:** Even when the volume control is the same on this unit, there may be differences in the volume depending on the connected devices. Adjust this when you want to alleviate this difference. To set, select each input source.

–12 dB to +12 dB (default setting: 0 dB)

**Name Edit:** Enter a simple name of up to 10 characters in length for the input sources or preset AM/FM stations. To set, select each input source or select the preset number of the registered station.

- For information on how to input characters, see “Inputting characters” (⇒ 33).

### ■ 5. Network

Make the network setting.

- If it is not displayed, wait for a moment until the network feature starts.
- When LAN is configured with a DHCP, set “DHCP” to “Enable” to configure the setting automatically. (“Enable” is set by default) To assign fixed IP addresses to each component, you must set “DHCP” to “Disable” and assign an address to this unit in “IP Address” as well as set information related to your LAN, such as Subnet Mask and Gateway.

**Wi-Fi:** Connect the unit to network via wireless LAN router.

**On:** Wireless LAN connection

**Off (Wired)** (default setting): Wired LAN connection

**Wi-Fi Setup:** You can configure wireless LAN settings by pressing the ENTER button when “Start” is displayed. For details, see “Wi-Fi® connection” (⇒ 14).

**SSID:** The SSID of the connected access point will be displayed.

**Signal:** The signal strength of the connected access point will be displayed.

**Status:** The status of the connected access point will be displayed.

**MAC Address:** View this unit’s MAC address.

**DHCP:**

**Enable** (default setting)

**Disable**

**IP Address:** View/set the IP address.

**Subnet Mask:** View/set the subnet mask.

**Gateway:** View/set the default gateway.

**DNS Server:** View/set the DNS server address.

**Proxy URL:** Set the proxy server address.

**Proxy Port:** Set the proxy port number.

- This only appears when Proxy URL has been set.

**Friendly Name:** Change the name for this unit to a simple one for display on the equipment connected by network. Press the ENTER button and input 31 or less characters.

- For information on how to input characters, see “Inputting characters” (⇒ 33).

**Network Check:** You can check the network connection. Press the ENTER button when “Start” is displayed.

## ■ 6. Bluetooth

Make the *Bluetooth* setting.

- If it is not displayed, wait for a moment until the network feature starts.

**Bluetooth:** Select whether or not to use the *Bluetooth* function.

**On** (default setting)

**Off**

- Select “On” when making following *Bluetooth* settings.

**Auto In Change:** The input of the unit will automatically be switched to “BLUETOOTH” when connection is made from a *Bluetooth* enabled device to the unit.

**On** (default setting)

**Off**

- If the input is not switched automatically, set to “Off” and change the input manually.

**Auto Reconnect:** This function automatically reconnects to the *Bluetooth* enabled device connected last when you change the input selector to “BLUETOOTH”.

**On** (default setting)

**Off**

- This may not work with some *Bluetooth* enabled devices.

**Pairing Info:** The information of the previous pairing stored in this unit will be initialized. Pressing the ENTER button when “Clear” is displayed initializes the pairing information stored in this unit.

- This function does not initialize the pairing information on the *Bluetooth* enabled device. When pairing the unit again with the device, be sure to clear the pairing information on the *Bluetooth* enabled device in advance. For information on how to clear the pairing information, refer to the *Bluetooth* enabled device’s instruction manual.

**Device:** Displays the name of the *Bluetooth* enabled device connected to the unit.

- The name is not displayed when “Status” is “Ready” or “Pairing”.

**Status:** Displays the status of the *Bluetooth* enabled device connected to the unit.

**Ready:** Not paired

**Pairing:** Pairing

**Connected:** Successfully connected

## ■ 7. Firmware Update

Make the firmware update setting.

- If it is not displayed, wait for a moment until the network feature starts.

**Update Notice:** Availability of a firmware update will be notified via network.

**Enable** (default setting)

**Disable**

**Version:** The current firmware version will be displayed.

**Update via NET:** Press the ENTER button to select when you want to update the firmware via network.

- You will not be able to select this setting if you do not have Internet access or there is nothing to update.

**Update via USB:** Press the ENTER button to select when you want to update the firmware via USB.

- You will not be able to select this setting if a USB storage device is not connected or there is nothing to update in the USB storage device.

## ■ 8. Lock

**SetupParameter:** The Setup menu will be locked to protect the settings.

**Locked**

**Unlocked** (default setting)

## Firmware update

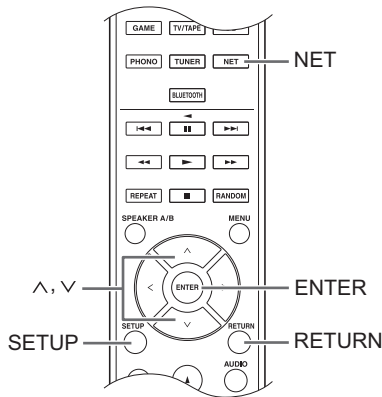

Update the firmware via network or USB connection. Visit our website to download the latest firmware. (If no firmware is listed, no firmware update is available.)

### Limitation of liability

The program and accompanying online documentation are furnished to you for use at your own risk. Our company will not be liable and you will have no remedy for damages for any claim of any kind whatsoever concerning your use of the program or the accompanying online documentation, regardless of legal theory, and whether arising in tort or contract. In no event will our company be liable to you or any third party for any special, indirect, incidental, or consequential damages of any kind, including, but not limited to, compensation, reimbursement or damages on account of the loss of present or prospective profits, loss of data, or for any other reason whatsoever.

### ■ Updating the firmware via network

You can update the firmware by connecting the unit to a network.

#### Precautions when updating the firmware

- Confirm that the unit is on and connected to a network.
- Before starting an update, stop the Internet radio, USB device, server or any other device that is playing audio.
- While updating, never disconnect or turn off this unit.
- While updating, never disconnect and reconnect the Ethernet cable.
- While updating, never disconnect and reconnect the power cord.
- Do not access this unit from a PC while updating.
- Updating takes about 30 minutes to be completed.
- Settings you made are retained after updating.

## Update procedures

1. Press the SETUP button.
2. Use the direction ( $\wedge/\vee$ ) buttons to select "7. Firmware Update" and press the ENTER button.
  - If it is not displayed, wait for a moment until the network feature starts.
3. Use the direction ( $\wedge/\vee$ ) buttons to select "Update via NET" and press the ENTER button.
  - The option does not appear when no firmware update is available.
4. Press the ENTER button with "Update" selected to start update. "Completed!" appears on the display when updating is completed.
5. Press the  $\odot$  ON/STANDBY button on the front panel to put the unit into standby.
  - Do not use the  $\odot$  button on the remote control for this operation.

The update is complete. The unit's firmware has been updated to the latest version.

## When an error message appears

When an error occurs, "\*\* Error!" appears on the display of this unit. (Characters and numbers appear in place of the asterisks.) Refer to the descriptions below to check the meaning.

### Error code

**\*-01, \*-10:** The Ethernet cable could not be recognized. Connect the Ethernet cable properly.

**\*-02, \*-03, \*-04, \*-05, \*-06, \*-11, \*-13, \*-14, \*-16, \*-17, \*-18, \*-20, \*-21:** Internet connection could not be established. Check the following points.

- Whether the router is turned on
- Whether this unit and router are connected to the network

Try to disconnect and then connect again the power to the unit and router. This may solve the problem. If you are still unable to connect to the Internet, the DNS server or proxy server may be temporarily down. Check the service status with your ISP provider.

**Others:** Disconnect and reconnect the power cord, and retry updating.

## ■ Updating the firmware via USB connection

You need a 64 MB or larger capacity USB storage for updating.

### Precautions when updating the firmware

- Before updating, stop playback and disconnect anything connected to the USB port.
- While updating, never put the unit into standby mode, or disconnect the power cord or the USB storage being used for the update.
- Do not access this unit from a PC while updating.
- Updating takes about 30 minutes to be completed.
- Settings you made are retained after updating.

### Update procedures

1. Connect a USB storage to the PC that you are using and delete any files on it.
2. Download the firmware file to the PC from our website. Decompress the downloaded file on the PC. The number of unzipped files and folders varies depending on the model.
3. Copy the decompressed files and folders to the root folder of the USB storage.
  - Do not copy any files other than the decompressed files. Do not copy the compressed file.
4. Press the NET button.
5. Use the direction (∧/∨) buttons to select "USB" on the display and press the ENTER button.
6. Connect the USB storage with the decompressed files to the USB port.
  - Loading the USB storage takes about 20 to 30 seconds.
7. Press the SETUP button.
8. Use the direction (∧/∨) buttons to select "7. Firmware Update" and press the ENTER button.
  - If it is not displayed, wait for a moment until the network feature starts.
9. Use the direction (∧/∨) buttons to select "Update via USB" and press the ENTER button.
  - The option does not appear when no firmware update is available.
10. Press the ENTER button with "Update" selected to start update. "Completed!" is displayed when the update is complete.
11. Disconnect the USB storage from the unit.
12. Press the ⏻ ON/STANDBY button on the front panel to put the unit into standby.
  - Do not use the ⏻ button on the remote control for this operation.

The update is complete. The unit's firmware has been updated to the latest version.

### When an error message appears

When an error occurs, "\*\_\* Error!" appears on the display of this unit. (Characters and numbers appear in place of the asterisks.) Refer to the descriptions below to check the meaning.

#### Error code

- \*-01, \*-10:** USB storage device not found. Check whether the USB storage device or USB cable is correctly inserted to the USB port of the unit. Connect the USB storage device to an external power source if it has its own power supply.
- \*-05, \*-13, \*-20, \*-21:** The firmware file is not present in the root folder of the USB storage device, or the firmware file is for another model. Retry from the download of the firmware file.

**Others:** Disconnect and reconnect the power cord, and retry updating.

# Troubleshooting

## Before starting the procedure

Problems may be solved by simply turning the power on/off or disconnecting/connecting the power cord, which is easier than working on the connection, setting and operating procedure. Try the simple measures on both the unit and the connected device.

## ● Resetting the unit

Resetting the unit to the status at the time of shipment may solve the problem. If the measures mentioned in the troubleshooting do not solve the problem, reset the unit with the following procedure.

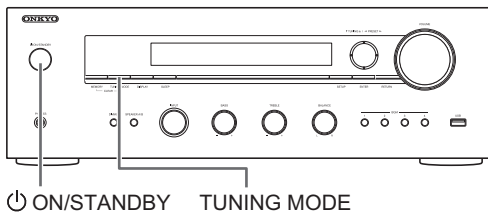

While the unit is on, press and hold the TUNING MODE button and press the ON/STANDBY button. "Clear" is displayed on the display, the unit enters standby mode, and the unit is reset to the state it was in at the time of purchase.

## Cannot turn on the unit.

- Make sure that the power cord is properly plugged into the wall outlet.
- Unplug the power cord from the wall outlet, wait 5 seconds or more, then plug it in again.

## The unit turns off unexpectedly.

- The receiver will automatically enter standby mode when Auto Standby or Sleep Timer is set and launched.

## There is no sound, or it is very quiet.

- Make sure the speaker set A or B is on. (⇒ 11)
- Make sure the correct input source is selected.
- If the MUTING indicator is shown on the display, press the MUTING button of the remote control to unmute the receiver.
- The PCM signal can be input only to digital input terminals. Make sure that PCM is selected on the playback component.
- Check the digital audio output setting on the connected component. On some game consoles, such as those that support DVD, the default setting is off.
- Make sure that the polarity of the speaker cables is correct, and that no bare wires are in contact with the metal part of speaker terminals.
- Make sure that the speaker cables are not shorting.

- If your record player uses an MC cartridge, you must connect either an MC head amp or an MC transformer. Note that if the connected record player has a built-in audio equalizer, connect it to a LINE IN terminal other than PHONO.

## Noise can be heard.

- Using cable ties to bundle audio cables with power cords, speaker cables, etc. may degrade the audio performance, so refrain from doing it.
- An audio cable may be picking up interference. Try repositioning your cables.

## Remote control does not work.

- Make sure that the batteries are installed with the correct polarity.
- If the remote control doesn't work reliably, try replacing the batteries. Don't mix new and old batteries or different types of batteries.
- Do not place obstructions between the main unit and the remote control. The remote control might not work if the remote control signal receiver on the unit is exposed to direct sunlight or bright light. If this occurs, try moving the unit.
- Beware that use of this remote control could cause the unintentional operation of other devices that can be controlled by infrared rays.
- If the unit is installed in a rack or cabinet with colored glass doors or if the doors are closed, the remote control may not work reliably.

## Cannot access to Wi-Fi (Wireless LAN) network.

- Try plugging/unplugging the power supply of wireless LAN router and the unit, check the wireless LAN router power-on status, and try reboot of the wireless LAN router.
- The wireless LAN router setting may be switched to Manual. Return the setting to Auto.
- Try the manual set-up. The connection may succeed.
- When the wireless LAN router setting is at stealth mode (mode to hide the SSID key) or when ANY connection is off, the SSID is not displayed. Change the setting and try again.
- Cannot receive signals due to a bad connection. Shorten the distance from wireless LAN access point or remove obstacles for a good visibility, and try again. Place the unit away from microwave ovens or other access points. It is recommended to place the Wi-Fi router (access point) and the unit in the same room.
- If there is a metallic object near the unit, wireless LAN connection may not be possible as the metal can effect on the radio wave.
- When other wireless LAN devices are used near the unit, several issues such as interrupted playback and communication may occur. You can avoid these issues by changing the channel of your Wi-Fi router. For instructions on changing channels, see the instruction manual provided with your Wi-Fi router.

**Cannot access the Internet radio.**

- Certain network service or contents available through the unit may not be accessible in case the service provider terminates its service.
- Make sure that connecting to Internet from other components is possible. If connecting is not possible, turn off all components connected to the network, wait for a while, and then turn on the components again.
- If a specific radio station is unavailable for listening, make sure the registered URL is correct, or whether the format distributed from the radio station is supported by this unit.

**Bluetooth functions**

- Try plugging/unplugging the power of the unit and try turning on/off the *Bluetooth* enabled device. Re-startup of the *Bluetooth* enabled device may be effective.
- When the audio volume of your *Bluetooth* enabled device is set low, the playback of audio may be unavailable. Increase the volume of the *Bluetooth* enabled device.
- Near components such as microwave oven or cordless phone, which use the radio wave in the 2.4 GHz range, a radio wave interference may occur, which disables the use of this unit.
- If there is a metallic object near the unit, *Bluetooth* connection may not be possible as the metal can effect on the radio wave.
- Depending on the *Bluetooth* enabled device, Send/Receive selector switch may be provided. Select Send mode.
- Depending on the characteristics or specifications of your *Bluetooth* enabled device, playback on the unit is not guaranteed.

**USB storage device is not displayed.**

- Check whether the USB storage device or USB cable is correctly inserted to the USB port of the unit.
- Remove the USB storage device from the receiver once, and then try re-connecting.
- USB storage devices with security functions may not be played.

**Cannot access the network server.**

- This unit needs to be connected to the same router as the network server.
- Make sure your network server has been started up.
- Make sure your network server is properly connected to the home network.
- Make sure your network server is correctly set.
- Make sure that the router LAN side port is properly connected to the receiver.

**Playback stops while listening to music files on the network server.**

- Make sure the network server is compatible with this unit.
- When the PC is serving as the network server, try quitting any application software other than the server software (Windows Media® Player 12 etc.).
- If the PC is downloading or copying large files, the playback may be interrupted.

**WARNING:** If smoke, smell or abnormal noise is produced by the unit, unplug the power cord from the wall outlet immediately and contact the dealer or our support.

The unit contains a microcomputer for signal processing and control functions. In very rare situations, severe interference, noise from an external source, or static electricity may cause it to lockup. In the unlikely event that this should happen, unplug the power cord, wait at least 5 seconds, and then plug it again.

Our company is not responsible for damages (such as CD rental fees) due to unsuccessful recordings caused by the unit's malfunction. Before you record important data, make sure that the material will be recorded correctly.

# Compatible devices/media/file formats

## Compatible devices/media

---

### ■ USB storage device

The unit supports USB storage devices that support the USB Mass Storage Class.

- FAT16 and FAT32 formats are supported for USB storage devices.
- If a USB storage device is divided into multiple partitions, this unit will recognize them as separate volumes.
- This unit supports up to 20,000 files and 16 folder levels within a single folder.
- This unit does not support USB hubs or devices with USB hub functions. Never connect such devices to this unit.
- This unit cannot play back audio files if copyright protection is used.
- If you connect an audio player that supports USB devices to the unit, information on the audio player's screen may differ from information on the unit's display. In addition, the unit does not support management functions provided by the audio player (music file classification, sorting, supplementary information, etc.).
- Do not connect PCs to this unit's USB ports. Audio from PCs cannot be input through this unit's USB ports.
- This unit might not be able to use media that is loaded into a USB card reader.
- Depending on the USB storage device, the unit might not be able to read its data correctly or supply power properly.
- During the use of USB storage devices, please be aware that our company will take no responsibility should data be lost or changed, a USB storage device become damaged or other harm occur.
- We recommend backing up data saved on a USB storage device before using it with this unit.
- Performance of the hard disk that receives power from the USB port of the unit is not guaranteed.
- If your AC adapter is supplied with your USB storage device, connect the AC adapter to an AC outlet to use the device.
- When using an audio player powered by a battery, check that its remaining capacity is sufficient.
- This unit does not support USB flash drives with security functions.

### ■ Network server

This unit supports the following network server.

Windows Media® Player 11  
Windows Media® Player 12  
Servers that comply with DLNA

- This unit supports up to 20,000 files and 16 folder levels within a single folder.
- The Digital Living Network Alliance (DLNA) is a group that is advancing the standardization of reciprocal connections and the exchange of audio, image, video and other data among PCs, game devices and digital household appliances over ordinary home networks (LAN). This unit complies with version 1.5 of the DLNA guidelines.
- Depending on the type of media server, this unit might not recognize it or be able to play audio files saved on it.

## File format

---

This unit can play the following types of audio files over a USB or network connection.

- This unit supports gapless playback of a USB storage device in the following conditions.  
When WAV, FLAC and Apple Lossless files are consecutively played back and they have the same format, sampling frequency, channels and quantization bit rate
- The Play To feature does not support the following:  
Gapless playback  
FLAC, Ogg Vorbis, DSD
- Variable bit-rate (VBR) files are supported. However, playback times may not be displayed correctly.
- For playback via wireless LAN, the sampling rate of 88.2 kHz or higher and DSD are not supported.

### MP3

Extension	.mp3, .MP3
Standard	MPEG-1/MPEG-2 Audio Layer-3
Sampling Frequency	8 k/11.025 k/12 k/16 k/22.05 k/24 k/32 k/ 44.1 k/48 kHz
Bit rate	8 kbps–320 kbps or VBR

### WMA

Extension	.wma, .WMA
Sampling Frequency	8 k/11.025 k/16 k/22.05 k/32 k/44.1 k/ 48 kHz
Bit rate	5 kbps–320 kbps or VBR

- WMA Pro and Voice are not supported.

### WMA Lossless

Extension	.wma, .WMA
Sampling Frequency	44.1 k/48 k/88.2 k/96 kHz
Quantization bit rate	16/24-bit

### WAV

Extension	.wav, .WAV
Sampling Frequency	8 k/11.025 k/12 k/16 k/22.05 k/24 k/32 k/ 44.1 k/48 k/64 k/88.2 k/96 k/176.4 k/ 192 kHz
Quantization bit rate	8/16/24-bit

- WAV files contain uncompressed PCM digital audio.
- For playback from a USB storage device, sampling rates of 176.4 kHz and 192 kHz are not supported.

### AAC

Extension	.aac, .m4a, .mp4, .3gp, .3g2, AAC, M4A, .MP4, .3GP, .3G2
Standard	MPEG-2/MPEG-4 Audio
Sampling Frequency	8 k/11.025 k/12 k/16 k/22.05 k/24 k/32 k/ 44.1 k/48 k/64 k/88.2 k/96 kHz
Bit rate	8 kbps–320 kbps or VBR

### FLAC

Extension	.flac, .FLAC
Sampling Frequency	8 k/11.025 k/12 k/16 k/22.05 k/24 k/32 k/ 44.1 k/48 k/64 k/88.2 k/96 k/176.4 k/ 192 kHz
Quantization bit rate	8/16/24-bit

- For playback from a USB storage device, sampling rates of 176.4 kHz and 192 kHz are not supported.

### Ogg Vorbis

Extension	.ogg, .OGG
Sampling Frequency	8 k/11.025 k/16 k/22.05 k/32 k/44.1 k/ 48 kHz
Bit rate	32 kbps–500 kbps or VBR

- Incompatible files cannot be played back.

### LPCM (Linear PCM)

Sampling Frequency	44.1 k/48 kHz
Quantization bit rate	16-bit

- Playback only supported over DLNA.

### Apple Lossless

Extension	.m4a, .mp4, .M4A, .MP4
Sampling Frequency	8 k/11.025 k/12 k/16 k/22.05 k/24 k/32 k/ 44.1 k/48 k/64 k/88.2 k/96 kHz
Quantization bit rate	16/24-bit

### DSD

Extension	.dsf, .DSF
Sampling Frequency	2.8224 M/5.6448 MHz

- Only sampling rates of 2.8224 MHz is supported for playback from USB.



# Specifications

## ■ Amplifier section

### Rated Output Power (FTC):

With 8 ohm loads, both channels driven, from 20-20,000 Hz; rated 80 watts per channel minimum RMS power, with no more than 0.1 % total harmonic distortion from 250 milliwatts to rated output.

With 6 ohm loads, both channels driven, 1 kHz; rated 110 watts per channel minimum RMS power, with no more than 0.1 % total harmonic distortion from 250 milliwatts to rated output.

### Dynamic Power (\*):

\* IEC60268-Short-term maximum output power

190 W (3 Ω, Front)

170 W (4 Ω, Front)

110 W (8 Ω, Front)

### THD+N (Total Harmonic Distortion+Noise):

0.08 % (20 Hz - 20,000 Hz, half power)

### Input Sensitivity and Impedance:

200 mV/47 kΩ (LINE)

3.5 mV/47 kΩ (PHONO MM)

### Rated RCA Output Level and Impedance:

1 V/680 Ω (SUBWOOFER PREOUT)

Phono Overload: 70 mV (MM 1 kHz 0.5 %)

Frequency Response: 10 Hz - 100 kHz/+1 dB, -3 dB (DIRECT)

Tone Control Characteristics: ±10 dB, 100 Hz (BASS)  
±10 dB, 10 kHz (TREBLE)

Signal to Noise Ratio: 106 dB (IHF-A, LINE IN, SP OUT)  
80 dB (IHF-A, PHONO IN, SP OUT)

Speaker Impedance: 4 Ω - 16 Ω

Headphone Output Impedance: 390 Ω

Headphone Rated Output: 200 mW  
(32 Ω, 1 kHz, 10 % THD)

## ■ Tuner section

FM Tuning Frequency Range: 87.5 MHz - 107.9 MHz

AM Tuning Frequency Range: 530 kHz - 1710 kHz

Preset Channel: 40

## ■ Network section

Ethernet LAN: 10BASE-T/100BASE-TX

Wireless LAN: IEEE802.11 b/g/n standard  
2.4 GHz band: 1 - 11 ch

## ■ Bluetooth section

### Communication system:

Bluetooth Specification version 2.1 +EDR (Enhanced Data Rate)

Frequency band: 2.4 GHz (2.402 GHz - 2.480 GHz)

Modulation method: FHSS

(Freq Hopping Spread Spectrum)

Compatible Bluetooth profiles: A2DP 1.2

AVRCP 1.3

Supported Codecs: SBC

Transmission range (A2DP): 20 Hz - 20 kHz

(Sampling frequency 44.1 kHz)

### Maximum communication range:

Line of sight approx. 15 m (\*)

\* The actual range will vary depending on factors such as obstacles between devices, magnetic fields around a microwave oven, static electricity, cordless phone, reception sensitivity, antenna's performance, operating system, software application, etc.

## ■ General

Power Supply: AC 120 V, 60 Hz

Power Consumption: 2.7 A

0.15 W (Standby)

2.9 W (Hybrid Standby)

50 W (No-sound)

Dimensions (W × H × D): 435 mm × 149 mm × 328 mm

(17-1/8" × 5-7/8" × 12-15/16")

Weight: 8.2 kg (18.1 lbs.)

### Audio inputs

Digital: OPTICAL 1 (GAME), 2 (TV/TAPE)

Maximum Fs: 96 kHz

COAXIAL 1 (BD/DVD), 2 (CBL/SAT)

Maximum Fs: 96 kHz

Analog: RCA (BD/DVD, CBL/SAT, PC, GAME,  
TV/TAPE, CD, PHONO)

### Audio outputs

Analog: SUBWOOFER PRE OUT

LINE OUT L/R

Speaker Outputs: SPEAKERS A: FRONT L/R

SPEAKERS B: FRONT L/R

Phones: PHONES (φ 6.3)

### Others

USB: 1 (USB1.1, 1.0 A)

RI: 1

Ethernet: 1

IR: IN:1, OUT:1

Specifications and features are subject to change without notice.

## License and trademark information



The Wi-Fi CERTIFIED Logo is a certification mark of Wi-Fi Alliance®.

Wi-Fi is a registered trademark of Wi-Fi Alliance®.



The *Bluetooth*® word mark and logos are registered trademarks owned by Bluetooth SIG, Inc. and any use of such marks by Onkyo Corporation is under license. Other trademarks and trade names are those of their respective owners.

Onkyo Corporation does not guarantee *Bluetooth* compatibility between the receiver and all *Bluetooth* enabled devices.

For compatibility between the receiver and another device with *Bluetooth* technology, consult the device's documentation and dealer. In some countries, there may be restrictions on using *Bluetooth* devices. Check with your local authorities.

DLNA®, the DLNA Logo and DLNA CERTIFIED® are trademarks, service marks, or certification marks of the Digital Living Network Alliance.

This product is protected by certain intellectual property rights of Microsoft. Use or distribution of such technology outside of this product is prohibited without a license from Microsoft.

Windows and the Windows logo are trademarks of the Microsoft group of companies.

Android is a trademark of Google Inc.

DSD and the Direct Stream Digital logo are trademarks of Sony Corporation.



The product with this logo is conformed to Hi-Res Audio standard defined by Japan Audio Society. This logo is used under license from Japan Audio Society.

## PANDORA

PANDORA, the PANDORA logo, and the Pandora trade dress are trademarks or registered trademarks of Pandora Media, Inc. Used with permission.



SiriusXM Internet Radio subscriptions are sold separately and are governed by the Sirius Terms and Conditions (see [www.sirius.com](http://www.sirius.com)). Be sure to read this agreement before you purchase your subscription.

Sirius, XM and all related marks and logos are trademarks of Sirius XM Radio Inc. and its subsidiaries. All rights reserved.

"All other trademarks are the property of their respective owners."

# GNU ライセンス

## Important Notice Regarding Software

The software package installed in this product includes software licensed to Onkyo & Pioneer Corporation (hereinafter, called "O&P Corporation") directly or indirectly by third party developers. Please be sure to read this notice regarding such software.

## Notice Regarding GNU GPL/LGPL-appliable Software

This product includes the following software that is covered by GNU General Public License (hereinafter, called "GPL") or by GNU Lesser General Public License (hereinafter, called "LGPL"). O&P Corporation notifies you that, according to the attached GPL/LGPL, you have right to obtain, modify, and redistribute software source code for the listed software.

## ソフトウェアに関する重要なお知らせ

本製品に搭載されるソフトウェアは、オンキヨー・パイオニア株式会社（以下「弊社」とします）が第三者より直接的に又は間接的に使用の承諾を受けたソフトウェアがなされております。これらのソフトウェアに関するお知らせを必ずご確認くださいませようお願ひ申し上げます。

## GNU GPL/LGPL 適用ソフトウェアに関するお知らせ

本製品には、以下の GNU General Public License（以下「GPL」とします）または GNU Lesser General Public License（以下「LGPL」とします）の適用を受けるソフトウェアが含まれております。お客様は添付の GPL/LGPL に従いこれらのソフトウェアソースコードの入手、改変、再配布の権利があることをお知らせいたします。

## Package List

### パッケージリスト

linux	uClibc	busybox
libgcc	libstdc++	libmsm
compat-wireless	wpa_supplicant	dnsmasq
libiconv	bluez	obsm
iperf	faad	

これらのソースコードのご提供に關しましては、コールセンターにお問い合せください。  
なお、ソースコードの自身についてのお問い合わせはご遠慮ください。

## GNU LESSER GENERAL PUBLIC LICENSE

Version 2.1, February 1999

Copyright (C) 1991, 1999 Free Software Foundation, Inc. 59 Temple Place, Suite 330, Boston, MA 02111-1307 USA  
Everyone is permitted to copy and distribute verbatim copies of this license document, but changing it is not allowed.  
[This is the first released version of the Lesser GPL. It also counts as the successor of the GNU Library Public License, version 2, hence the version number 2.1.]

### Preamble

The licenses for most software are designed to take away your freedom to share and change it. By contrast, the GNU General Public Licenses are intended to guarantee your freedom to share and change free software—to make sure the software is free for all users.

This license, the Lesser General Public License, applies to some specially designated software packages—typically libraries—of the Free Software Foundation and other authors who decide to use it. You can use it too, but we suggest you first think carefully about whether this license or the ordinary General Public License is the better strategy to use in any particular case, based on the explanations below.

When we speak of free software, we are referring to freedom of use, not price. Our General Public Licenses are designed to make sure that you have the freedom to distribute copies of free software (and charge for this service if you wish), that you receive source code or can get it if you want it, that you can change the software and use pieces of it in new free programs; and that you are informed that you can do these things.

To protect your rights, we need to make restrictions that forbid distributors to deny you these rights or to ask you to surrender these rights. These restrictions translate to certain responsibilities for you if you distribute copies of the library or if you modify it. For example, if you distribute copies of the library, whether gratis or for a fee, you must give the recipients all the rights that we give you. You must make sure that they, too, receive or can get the source code. If you link other code with the library, you must provide complete object files to the recipients, so that they can link them with the library after making changes to the library and recompiling it. And you must show them these terms so they know their rights.

We protect your rights with a two-step method: (1) we copyright the library, and (2) we offer you this license, which gives you legal permission to copy, distribute and/or modify the library. To protect each distributor, we want to make it very clear that there is no warranty for the free library. Also, if the library is modified by someone else and passed on, the recipients should know that what they have is the original version, so that the original author's reputation will not be affected by problems that might be introduced by others.

Finally, software patents pose a constant threat to the existence of any free program. We wish to make sure that a company cannot effectively restrict the users of a free program by obtaining a restrictive license from a patent holder. Therefore, we insist that any patent license obtained for a version of the library must be consistent with the full freedom of use specified in this license.

Most GNU software, including some libraries, is covered by the ordinary GNU General Public License. This license, the GNU Lesser General Public License, applies to certain designated libraries, and is quite different from the ordinary General Public License. We use this license for certain libraries in order to permit linking those libraries into non-free programs.

When a program is linked with a library, whether statically or using a shared library, the combination of the two is legally speaking a combined work, a derivative of the original library. The ordinary General Public License therefore permits such linking only if the entire combination fits its criteria of freedom. The Lesser General Public License permits more lax criteria for linking other code with the library.

We call this license the "Lesser" General Public License because it does less to protect the user's freedom than the ordinary General Public License. It also provides other free software developers Less of an advantage over competing non-free programs. These disadvantages are the reason we use the ordinary General Public License for many libraries. However, the Lesser license provides advantages in certain special circumstances.

For example, on rare occasions there may be a special need to encourage the widest possible use of a certain library, so that it becomes a de-facto standard. To achieve this, non-free programs must be allowed to use the library. A more frequent case is that a free library does the same job as widely used non-free libraries. In this case, there is little to gain by limiting the free library to free software only, so we use the Lesser General Public License.

In other cases, permission to use a particular library in non-free programs enables a greater number of people to use a large body of free software. For example, permission to use the GNU C Library in non-free programs enables many more people to use the whole GNU operating system, as well as its variant, the GNU/Linux operating system.

Although the Lesser General Public License is less strict of the users' freedom, it does ensure that the user of a program that is linked with the library has the freedom and the wherewithal to run that program using a modified version of the library. The precise terms and conditions for copying, distribution and modification follow. Pay close attention to the difference between a "work based on the library" and a "work that uses the library". The former contains code derived from the library, whereas the latter must be combined with the library in order to run.

### TERMS AND CONDITIONS FOR COPYING, DISTRIBUTION AND MODIFICATION

0. This License Agreement applies to any software library or other program which contains a notice placed by the copyright holder or other authorized party saying it may be distributed under the terms of this Lesser General Public License (also called "this License"). Each licensee is addressed as "you".

A "library" means a collection of software functions and/or data prepared so as to be conveniently linked with application programs (which use these functions and data) to form executables.  
The "Library", below, refers to any software library or work which has been distributed under these terms. A "work based on the Library" means either the Library or any derivative work under copyright law; that is to say, a work containing the Library or a portion of it, either verbatim or with modifications and/or translated straightforwardly into another language. (Hereinafter, translation is included without limitation in the term "modification".)  
"Source code" for a work means the preferred form of the work for making modifications to it. For a library, complete source code means all the source code for all modules it contains, plus any associated interface definition files, plus the scripts used to control compilation and installation of the library.

Activities other than copying, distribution and modification are not covered by this License; they are outside its scope. The act of running a program using the Library is not restricted, and output from such a program is covered only if its contents constitute a work based on the Library (independent of the use of the Library in a tool for writing it). Whether that is true depends on what the Library does and what the program that uses the Library does.

1. You may copy and distribute verbatim copies of the Library's complete source code as you see fit, in any medium, provided that you conspicuously and appropriately publish on each copy an appropriate copyright notice and disclaimer of warranty, keep intact all the notices that refer to this License and to the absence of any warranty, and distribute a copy of this License along with the Library.

You may charge a fee for the physical act of transferring a copy, and you may at your option offer warranty protection in exchange for a fee.

2. You may modify your copy or copies of the Library or any portion of it, thus forming a work based on the Library, and copy and distribute such modifications or works under the terms of Section 1 above, provided that you also meet all of these conditions:

- The modified work must itself be a software library.
- You must cause the files modified to carry prominent notices stating that you changed the files and the date of any change.
- You must cause the whole work to be licensed at no charge to all third parties under the terms of this License.
- If a facility in the modified Library refers to a function or a table of data to be supplied by an application program that uses the facility, other than as an argument passed when the facility is invoked, then you must make a good faith effort to ensure that, in the event an application does not supply such function or table, the facility still operates, and performs whatever part of its purpose remains meaningful.

(For example, a function in a library to compute square roots has a purpose that is entirely well-defined independent of the application. Therefore, Subsection 2d requires that any application-supplied function or table used by this function must be optimal: if the application does not supply it, the square root function must still compute square roots.)

These requirements apply to the modified work as a whole. If identifiable sections of that work are not derived from the Library, and can be reasonably considered independent and separate works in themselves, then this License, and its terms, do not apply to those sections when you distribute them as separate works. But when you distribute the same sections as part of a whole which is a work based on the Library, the distribution of the whole must be on the terms of this License, whose permissions for other licensees extend to the entire whole, and thus to each and every part regardless of who wrote it.

Thus, it is not the intent of this section to claim rights or contest your rights to work written entirely by you; rather, the intent is to exercise the right to control the distribution of derivative works based on the Library.  
In addition, mere aggregation of another work not based on the Library with the Library (or with a work based on the Library) on a volume of a storage or distribution medium does not bring the other work under the scope of this License.

3. You may copy to apply the terms of the ordinary GNU General Public License instead of this License to a given copy of the Library. To do this, you must alter all the notices that refer to this License, so that they refer to the ordinary GNU General Public License, version 2, instead of to this License. (If a newer version than version 2 of the ordinary GNU General Public License has appeared, then you can specify that version instead if you wish.)

Do not make any other change in these notices.

Once this change is made in a given copy, it is irreversible for that copy, so the ordinary GNU General Public License applies to all subsequent copies and derivative works made from that copy.

This option is useful when you wish to copy part of the code of the Library into a program that is not a library.

4. If you copy and distribute the Library (or a portion or derivative of it, under Section 2) in object code or executable form under the terms of Sections 1 and 2 above provided that you accompany it with the complete corresponding machine-readable source code, which must be distributed under the terms of Sections 1 and 2 above on a medium customarily used for software interchange.

If distribution of object code is made by offering access to copy from a designated place, then offering equivalent access to copy the source code from the same place satisfies the requirement to distribute the source code, even though third parties are not compelled to copy the source along with the object code.

5. A program that contains no derivative of any portion of the Library, but is designed to work with the Library by being compiled or linked with it, is called a "work that uses the Library". Such a work, in isolation, is not a derivative work of the Library, and therefore falls outside the scope of this License.

However, linking a "work that uses the Library" with the Library creates an executable that is a derivative of the Library (because it contains portions of the Library), rather than a "work that uses the library". The executable is therefore covered by this License. Section 6 states terms for distribution of such executables.

When a "work that uses the Library" uses material from a header file that is part of the Library, the object code for the work may be a derivative work of the Library even though the source code is not. Whether this is true is especially significant if the work can be linked without the Library, or if the work is itself a library. The threshold for this to be true is not precisely defined by law. If such an object file uses only numerical parameters, data structure layouts and accessors, and small macros and small inline functions (ten lines or less in length), then the use of the object file is unrestricted, regardless of whether it is a derivative work. (Executables containing this object code plus portions of the Library will still fall under Section 6.)

Otherwise, if the work is a derivative of the Library, you may distribute the object code for the work under the terms of Section 6. Any executables containing that work also fall under Section 6, whether or not they are linked directly with the Library itself.

6. As an exception to the Sections above, you may also combine or link a "work that uses the Library" with the Library to produce a work containing portions of the Library, but distribute that work under terms of your choice, provided that the terms permit modification of the work for the customer's own use and reverse engineering for debugging such modifications. You must give prominent notice with each copy of the work that the Library is used in it and that the Library and its use are covered by this License. You must supply a copy of this License. If the work during execution displays copyright notices, you must include the copyright notice for the Library among them, as well as a reference directing the user to the copy of this License. Also, you must do one of these things:

a) Accompany the work with the complete corresponding machine-readable source code for the Library including whatever changes were used in the work (which must be distributed under Sections 1 and 2 above); and, if the work is an executable linked with the Library, with the complete machine-readable "work that uses the Library", as object code and/or source code, so that the user can modify the Library and then re-link to produce a modified executable containing the modified Library. (It is understood that the user who changes the contents of definitions files in the Library will not necessarily be able to recompile the application to use the modified definitions.)

b) Use a suitable shared library mechanism for linking with the Library, a mechanism that is implemented in one of the ways listed in a copy of the library already present on the user's computer system, rather than copying library functions into the executable, and (2) will operate properly with a modified version of the library, if the user installs one, as long as the modified version is interface-compatible with the version that the work was made with.

c) Accompany the work with a written offer, valid for at least three years, to give the same user the materials specified in Subsection 6a, above, for a charge no more than the cost of performing this distribution.

d) If distribution of the work is made by offering access to copy from a designated place, offer equivalent access to copy the above specified materials from the same place.

e) Verify that the user has already received a copy of these materials or that you have already sent this user a copy. For an executable, the required form of the "work that uses the Library" must include any data and utility programs needed for reproducing the executable from it. However, as a special exception, the materials to be distributed need not include anything but the source code for the Library, the linker script for the library, any static or object libraries used in constructing the operating system on which the executable runs, unless that component itself accompanies the executable.

It may happen that this requirement contradicts the license restrictions of other proprietary libraries that do not normally accompany the operating system. Such a contradiction means you cannot use both them and the Library together in an executable that you distribute.

7. You may place library facilities that are a work based on the Library side-by-side in a single library together with other library facilities not covered by this License, and distribute such a combined library, provided that the separate distribution of the work based on the Library and of the other library facilities is otherwise permitted, and provided that you do these two things:

a) Accompany the combined library with a copy of the same work based on the Library, uncombined with any other library facilities. This must be distributed under the terms of the Sections above.

b) Give prominent notice with the combined library of the fact that part of it is a work based on the Library, and explaining where to find the accompanying uncombined form of the same work.

8. You may not copy, modify, sublicense, link with, or distribute the Library except as expressly provided under this License. Any attempt otherwise to copy, modify, sublicense, link with, or distribute the Library is void, and will automatically terminate your rights under this License. However, parties who have received copies, or rights, from you under this License will not have their licenses terminated so long as such parties remain in full compliance.

9. You are not required to accept this License, since you have not signed it. However, nothing else grants you permission to modify or distribute the Library or its derivative works. These actions are prohibited by law if you do not accept this License. Therefore, by modifying or distributing the Library (or any work based on the Library), you indicate your acceptance of this License to do so, and all its terms and conditions for copying, distributing or modifying the Library or works based on it.

10. Each time you redistribute the Library (or any work based on the Library), the recipient automatically receives a license from the original licensor to copy, distribute, link with or modify the Library subject to these terms and conditions. You may not impose any further restrictions on the recipients' exercise of the rights granted herein.

11. You are not responsible for enforcing these terms with respect to third parties with this License.

11. If, as a consequence of a court judgment or allegation of patent infringement or for any other reason (not limited to patent issues), conditions are imposed on you (whether by court order, agreement or otherwise) that contradict the conditions of this License, they do not excuse you from the conditions of this License. If you cannot distribute so as to satisfy simultaneously your obligations under this License and any other pertinent obligations, then as a consequence you may not distribute the Library at all. For example, if a patent license would not permit royalty-free redistribution of the Library by you to those countries to which you are required to distribute the Library, then the only way you could satisfy both it and this License would be to refrain entirely from distribution of the Library.

If any portion of this section is held invalid or unenforceable under any particular circumstance, the balance of the section is intended to apply, and the section as a whole is intended to apply in other circumstances.

It is not the purpose of this section to induce you to infringe any patents or other property right claims or to contest validity of any such claims. This section is intended to make the sole purpose of protecting the integrity of the free software distribution system which is implemented by public license practices. Many people have made generous contributions to the wide range of software distributed through this system in reliance on consistent application of that system; it is up to the author/donor to decide if he or she is willing to distribute software through another system and a licensee cannot impose that choice.

This section is intended to make thoroughly clear what is believed to be a consequence of the rest of this License.  
12. If the distribution and/or use of the Library is restricted in certain countries either by patents or by copyrighted interfaces, the original copyright holder who places the Library under this license may add to this license any particular geographical distribution limitation excluding those countries, so that distribution is permitted only in or among countries not thus excluded. In such case, this License incorporates the limitation as if written in the body of this License.

13. The Free Software Foundation may publish revised and/or new versions of the Lesser General Public License from time to time.

Each new version is similar in spirit to the present version, but may differ in detail to address new problems or concerns. The version number is given a distinguishing version number. If the Library specifies a version number of this License which applies to it and "any later version", you have the option of following the terms and conditions either of that version or of any later version published by the Free Software Foundation. If the Library does not specify a license version number, you may choose any version ever published by the Free Software Foundation.

14. If you wish to incorporate parts of the Library into other free programs whose distribution conditions are incompatible with these, write to the author to ask for permission. For software which is copyrighted by the Free Software Foundation, write to the Free Software Foundation; we sometimes make exceptions for this. Our decision will be guided by the two goals of preserving the free status of all derivatives of our free software and of promoting the sharing and reuse of software generally.

### NO WARRANTY

15. BECAUSE THE LIBRARY IS LICENSED FREE OF CHARGE, THERE IS NO WARRANTY FOR THE LIBRARY, TO THE EXTENT PERMITTED BY APPLICABLE LAW, EXCEPT WHEN OTHERWISE STATED IN WRITING THE COPYRIGHT HOLDERS AND/OR OTHER PARTIES PROVIDE THE LIBRARY "AS IS" WITHOUT WARRANTY OF ANY KIND, EITHER EXPRESSED OR IMPLIED, INCLUDING, BUT NOT LIMITED TO, THE IMPLIED WARRANTIES OF MERCHANTABILITY AND FITNESS FOR A PARTICULAR PURPOSE. THE ENTIRE RISK AS TO THE QUALITY AND PERFORMANCE OF THE LIBRARY IS WITH YOU. SHOULD THE LIBRARY PROVE DEFECTIVE, YOU ASSUME THE COST OF ALL NECESSARY SERVICING, REPAIR OR CORRECTION.

16. IN NO EVENT UNLESS REQUIRED BY APPLICABLE LAW OR AGREED TO IN WRITING WILL ANY COPYRIGHT HOLDER, OR ANY OTHER PARTY WHO MAY MODIFY AND/OR REDISTRIBUTE THE LIBRARY AS PERMITTED ABOVE, BE LIABLE TO YOU FOR DAMAGES, INCLUDING ANY GENERAL, SPECIAL, INCIDENTAL OR CONSEQUENTIAL DAMAGES ARISING OUT OF THE USE OR INABILITY TO USE THE LIBRARY, INCLUDING BUT NOT LIMITED TO LOSS OF DATA OR DATA BEING RENDERED INACCURATE OR LOSSES SUSTAINED BY YOU OR THIRD PARTIES OR A FAILURE OF THE LIBRARY TO OPERATE WITH ANY OTHER SOFTWARE), EVEN IF SUCH HOLDER OR OTHER PARTY HAS BEEN ADVISED OF THE POSSIBILITY OF SUCH DAMAGES.

## END OF TERMS AND CONDITIONS

### How to Apply These Terms to Your New Libraries

If you develop a new library, and you want it to be of the greatest possible use to the public, we recommend making it free software that everyone can redistribute and change. You can do so by permitting redistribution under these terms (or, alternatively, under the terms of the ordinary General Public License).

To apply these terms, attach the following notices to the library. It is safest to attach them to the start of each source file to most effectively convey the exclusion of warranty; and each file should have at least the "copyright" line and a pointer to where the full notice is found:

<one line to give the library's name and an idea of what it does.>

Copyright (C) <year> <name of author>

This library is free software; you can redistribute it and/or modify it under the terms of the GNU Lesser General Public License as published by the Free Software Foundation; either version 2.1 of the License, or (at your option) any later version. This library is distributed in the hope that it will be useful, but WITHOUT ANY WARRANTY; without even the implied warranty of MERCHANTABILITY or FITNESS FOR A PARTICULAR PURPOSE. See the GNU Lesser General Public License for more details.

You should have received a copy of the GNU Lesser General Public License along with this library; if not, write to the Free Software Foundation, Inc., 59 Temple Place, Suite 330, Boston, MA 02111-1307 USA  
Also add information on how to contact you by electronic and paper mail.

You should also get your employer (if you work as a programmer) or your school, if any, to sign a "copyright disclaimer" for the library, if necessary. Here is a sample; alter the names:

Yoodyne, Inc., hereby disclaims all copyright interest in the library 'Frob' (a library for tweaking knobs) written by James Random Hacker.

signature of Ty Coon, 1 April 1990

Ty Coon, President of Vice

That's all there is to it!

## GNU GENERAL PUBLIC LICENSE

Version 2, June 1991

Copyright (C) 1989, 1991 Free Software Foundation, Inc. 59 Temple Place - Suite 330, Boston, MA 02111-1307, USA

Everyone is permitted to copy and distribute verbatim copies of this license document, but changing it is not allowed.

### Preamble

The licenses for most software are designed to take away your freedom to share and change it. By contrast, the GNU General Public License is intended to guarantee your freedom to share and change free software—to make sure the software is free for all its users. This General Public License applies to most of the Free Software Foundation's software and to any other program whose authors commit to using it. (Some other Free Software Foundation software is covered by the GNU Library General Public License instead.) You can apply it to your programs, too.

When we speak of free software, we are referring to freedom, not price. Our General Public Licenses are designed to make sure that you have the freedom to distribute copies of free software (and charge for this service if you wish), that you receive source code or can get it if you want it, that you can change the software or use pieces of it in new free programs; and that you know you can do these things.

To protect your rights, we need to make restrictions that forbid anyone to deny you these rights or to ask you to surrender the rights. These restrictions translate to certain responsibilities for you if you distribute copies of the software, or if you modify it. For example, if you distribute copies of such a program, whether gratis or for a fee, you must give the recipients all the rights that you have. You must make sure that they, too, receive or can get the source code. And you must show them these terms so they know their rights.

We protect your rights with two steps: (1) copyright the software, and (2) offer you this license which gives you legal permission to copy, distribute and/or modify the software.

Also, for each author's protection and ours, we want to make certain that everyone understands that there is no warranty for this free software. If the software is modified by someone else and passed on, we want its recipients to know that what they have is not the original, so that any problems introduced by others will not reflect on the original authors' reputations.

Finally, any free program is threatened constantly by software patents. We wish to avoid the danger that redistributors of a free program will inadvertently obtain patent licenses, in effect making the program proprietary. To prevent this, we have made it clear that any patent must be licensed for everyone's free use or not licensed at all.

The precise terms and conditions for copying, distribution and modification follow.

### TERMS AND CONDITIONS FOR COPYING, DISTRIBUTION AND MODIFICATION

0. This License applies to any program or other work which contains a notice placed by the copyright holder saying it may be distributed under the terms of this General Public License. The "Program", below, refers to any such program or work, and a "work based on the Program" means either the Program or any derivative work under copyright law; that is to say, a work containing the Program or a portion of it, either verbatim or with modifications and/or translated into another language. (Hereinafter, translation is included without limitation in the term "modification".) Each licensee is addressed as "you".

Activities other than copying, distributing and modification are not covered by this License; they are outside its scope. The act of running the Program is not restricted, and the output from the Program is covered only if its contents constitute a work based on the Program (independent of having been made by running the Program). Whether that is true depends on what the Program does.

1. You may copy and distribute verbatim copies of the Program's source code as you receive it, in any medium, provided that you conspicuously and appropriately publish on each copy an appropriate copyright notice and disclaimer of warranty, keep intact all the notices that refer to this License and to the absence of any warranty; and give any other recipients of the Program a copy of this License along with the Program.

You may charge a fee for the physical act of transferring a copy, and you may at your option offer warranty protection in exchange for a fee.

2. You may modify your copy or copies of the Program or any portion of it, thus forming a work based on the Program, and copy and distribute such modifications or work under the terms of Section 1 above, provided that you also meet all of these conditions:

a) You must cause the modified files to carry prominent notices stating that you changed the files and the date of any change. b) You must cause any derivative works to carry prominent notices stating that they are not part of the Program or any part thereof, to be licensed as a whole to all third parties under the terms of this License.

c) If the modified program normally reads commands interactively when run, you must cause it, when started running for such interactive use in the most ordinary way, to print or display an announcement including an appropriate copyright notice and a notice that there is no warranty (or else, saying that you provide a warranty) and that users may redistribute the program under these conditions, and telling the user how to view a copy of this License. (Exception: if the Program itself is interactive but does not normally print such a notice, you may instead cause it to print an announcement.)

These requirements apply to the modified work as a whole. If identifiable sections of that work are not derived from the Program, and can be reasonably considered independent and separate works in themselves, then this License, and its terms, do not apply to those sections when you distribute them as separate works. But when you distribute the same sections as part of a whole which is a work based on the Program, the distribution of the whole must be on the terms of this License, whose permissions for other licensees extend to the entire whole, and thus to each and every part regardless of who wrote it. This is to prevent the intent of the Program from being circumvented by those who would not give you their word, rather, the intent is to exercise the right to control the distribution of derivative or collective works based on the Program.

In addition, mere aggregation of another work not based on the Program with the Program (or with a work based on the Program) on a volume of a storage or distribution medium does not bring the other work under the scope of this License.

3. You may copy and distribute the Program (or a work based on it, under Section 2) in object code or executable form under the terms of Sections 1 and 2 above provided that you also do one of the following:

a) Accompany it with the complete corresponding machine-readable source code, which must be distributed under the terms of Sections 1 and 2 above on a medium customarily used for software interchange; or

b) Accompany it with a written offer, valid for at least three years, to give any third party, for a charge no more than your cost of physically performing source distribution, a complete machine-readable copy of the corresponding source code, to be distributed under the terms of Sections 1 and 2 above on a medium customarily used for software interchange; or

c) Accompany it with the information you received as to the offer to distribute corresponding source code. (This alternative is allowed only for noncommercial distribution and only if you received the program in object code or executable form with such an offer, in accord with Subsection b.)

The source code for a work means the preferred form for the work for making modifications to it. For an executable work, complete source code means all the source code for all modules it contains, plus any associated interface definition files, plus the scripts used to control compilation and installation of the executable. However, as a special exception, the source code distributed need not include anything that is normally distributed (in either source or binary form) with the major components (compiler, kernel, and so on) of the operating system on which the executable runs, unless that component itself accompanies the executable.

If distribution of executable or object code is made by offering access to copy from a designated place, then offering equivalent access to copy the source code from the same place counts as distribution of the source code, even though third parties are not compelled to copy the source along with the object code.

4. You may not copy, modify, sublicense, or distribute the Program except as expressly provided under this License. Any attempt otherwise to copy, modify, sublicense or distribute the Program is void, and will automatically terminate your rights under this License. However, parties who have received copies, or rights, from you under this License will not have their licenses terminated so long as such parties remain in full compliance.

5. You are not required to accept this License, since you have not signed it. However, nothing else grants you permission to modify or distribute the Program or its derivative works. These actions are prohibited by law if you do not accept this License. Therefore, by modifying or distributing the Program (or any work based on the Program), you indicate your acceptance of this License to do so, and all its terms and conditions for copying, distributing or modifying the Program or works based on it.

6. Each time you redistribute the Program (or any work based on the Program), the recipient automatically receives a license from the original licensor to copy, distribute or modify the Program subject to these terms and conditions. You may not impose any further restrictions on the recipients' exercise of the rights granted herein. You are not responsible for enforcing compliance by third parties to this License.

7. If, as a consequence of a court judgment or allegation of patent infringement or for any other reason (not limited to patent issues), conditions are imposed on you (whether by court order, agreement or otherwise) that contradict the conditions of this License, they do not excuse you from the conditions of this License. If you cannot distribute so as to satisfy simultaneously your obligations under this License and any other pertinent obligations, then as a consequence you may

not distribute the Program at all. For example, if a patent license would not permit royalty-free redistribution of the Program by all those who receive copies directly or indirectly through you, then only you could satisfy both it and this License would be to refrain entirely from distribution of the Program.

If any portion of this section is held invalid or unenforceable under any particular circumstance, the balance of the section is intended to apply and the section as a whole is intended to apply in other circumstances.

It is not the purpose of this section to induce you to infringe any patents or other property right claims or to contest validity of any such claims; this section has the sole purpose of protecting the integrity of the free software distribution system, which is implemented by public license practices. Many people have made generous contributions to the wide range of software distributed through this system in reliance on consistent application of that system; it is up to the author/donor to decide if he or she is willing to distribute software through any other system and a licensee cannot impose that choice.

This section is intended to make thoroughly clear what is believed to be a consequence of the rest of this License.

8. If the distribution and/or use of the Program is restricted in certain countries either by patents or by copyrighted interfaces, the original copyright holder who places the Program under this License may add an explicit geographical distribution limitation excluding those countries, so that distribution is permitted only in or among countries not thus excluded. In such case, this License incorporates the limitation as if written in the body of the License.

9. The Free Software Foundation may revise and/or new versions of the General Public License from time to time. Such new versions will be similar in spirit to the present version, but may differ in detail to address new problems or concerns.

10. If you wish to give a distinguishing version number to the Program, you may do so. If the Program specifies a version number of this License which applies to it and "any later version", you have the option of following the terms and conditions either of that version or of any later version published by the Free Software Foundation. If the Program does not specify a version number of this License, you may choose any version ever published by the Free Software Foundation.

11. If you wish to incorporate parts of the Program into other free programs whose distribution conditions are different, write to the author to ask for permission. For software which is copyrighted by the Free Software Foundation, write to the Free Software Foundation; for software which is not, write to the copyright holder. Our decision will be guided by the two goals of preserving the free status of all derivatives of our free software and of promoting the sharing and reuse of software generally.

### NO WARRANTY

11. BECAUSE THE PROGRAM IS LICENSED FREE OF CHARGE, THERE IS NO WARRANTY FOR THE PROGRAM, TO THE EXTENT PERMITTED BY APPLICABLE LAW. EXCEPT WHEN OTHERWISE STATED IN WRITING THE COPYRIGHT HOLDERS AND/OR OTHER PARTIES PROVIDE THE PROGRAM "AS IS" WITHOUT WARRANTY OF ANY KIND, EITHER EXPRESSED OR IMPLIED, INCLUDING BUT NOT LIMITED TO THE IMPLIED WARRANTIES OF MERCHANTABILITY AND FITNESS FOR A PARTICULAR PURPOSE. THE ENTIRE RISK AS TO THE QUALITY AND PERFORMANCE OF THE PROGRAM IS WITH YOU. SHOULD THE PROGRAM PROVE DEFECTIVE, YOU ASSUME THE COST OF ALL NECESSARY SERVICING, REPAIR OR CORRECTION.

12. IN NO EVENT UNLESS REQUIRED BY APPLICABLE LAW OR AGREED TO IN WRITING WILL ANY COPYRIGHT HOLDER, OR ANY OTHER PARTY WHO MAY MODIFY AND/OR REDISTRIBUTE THE PROGRAM AS PERMITTED ABOVE, BE LIABLE TO YOU FOR DAMAGES, INCLUDING ANY GENERAL, SPECIAL, INCIDENTAL OR CONSEQUENTIAL DAMAGES ARISING OUT OF THE USE OR INABILITY TO USE THE PROGRAM (INCLUDING BUT NOT LIMITED TO LOSS OF DATA OR DATA BEING RENDERED INACCURATE OR LOSSES SUSTAINED BY YOU OR THIRD PARTIES OR A FAILURE OF THE PROGRAM TO OPERATE WITH ANY OTHER PROGRAMS), EVEN IF SUCH HOLDER OR OTHER PARTY HAS BEEN ADVISED OF THE POSSIBILITY OF SUCH DAMAGES.

## END OF TERMS AND CONDITIONS

### How to Apply These Terms to Your New Programs

If you develop a new program, and you want it to be of the greatest possible use to the public, the best way to achieve this is to make it free software which everyone can redistribute and change under these terms.

To do so, attach the following notices to the program. It is safest to attach them to the start of each source file to most effectively convey the exclusion of warranty; and each file should have at least the "copyright" line and a pointer to where the full notice is found.

<one line to give the program's name and an idea of what it does.>

Copyright (C) <year> <name of author>

This program is free software; you can redistribute it and/or modify it under the terms of the GNU General Public License as published by the Free Software Foundation; either version 2 of the License, or (at your option) any later version.

This program is distributed in the hope that it will be useful, but WITHOUT ANY WARRANTY; without even the implied warranty of MERCHANTABILITY or FITNESS FOR A PARTICULAR PURPOSE. See the GNU General Public License for more details.

You should have received a copy of the GNU General Public License along with this program; if not, write to the Free Software Foundation, Inc., 59 Temple Place - Suite 330, Boston, MA 02111-1307, USA.

Also add information on how to contact you by electronic and paper mail.

If the program is interactive, make it output a short notice like this when it starts in an interactive mode:

Gnomovision version 69, Copyright (C) year name of author Gnomovision comes with ABSOLUTELY NO WARRANTY; for details type 'show w'. This is free software, and you are welcome to redistribute it under certain conditions; type 'show c' for details.

The hypothetical commands 'show w' and 'show c' should show the appropriate parts of the General Public License. Of course, the commands you use may call something other than 'show w' and 'show c'; they could even be mouse-clicks or menu items—whatever suits your program.

You should also get your employer (if you work as a programmer) or your school, if any, to sign a "copyright disclaimer" for the program, if necessary. Here is a sample; alter the names:

Yoodyne, Inc., hereby disclaims all copyright interest in the program 'Gnomovision' (which makes passes at compilers) written by James Hacker.

signature of Ty Coon, 1 April 1989

Ty Coon, President of Vice

This General Public License does not permit incorporating your program into proprietary programs. If your program is a subroutine library, you may consider it more useful to permit linking proprietary applications with the library; if this is what you want to do, use the GNU Library General Public License instead of this License.

## Notice Regarding Third-party Software

This product includes the following software that is directly or indirectly licensed to O&P Corporation by third-party developers.

1. bfish-ak
2. ixml
3. libcurl
4. libFLAC
5. libjpeg
6. libogg
7. libpng
8. libportis
9. ntp
10. OpenSSL
11. pop3
12. RSA Data Security, Inc. MD5 Message-Digest Algorithm
13. tthtpd 2.5b
14. zlib
15. Apple Lossless
16. Boost
17. Expat
18. FastDelegate
19. Tremolo
20. Tremor
21. Mersenne Twister
22. cURL
23. c-ares
24. LZ4

In response to requests from the copyright owners of each piece of software, O&P Corporation notifies you of the following:

その他第三者ソフトウェアに関するお知らせ  
本製品には本ソフトウェアの第三者より直接的又は間接的に使用の許諾を受けた下記ソフトウェアが含まれております。

1. bfish-ak
2. ixml
3. libcurl
4. libFLAC
5. libjpeg
6. libogg
7. libpng
8. libportis
9. ntp
10. OpenSSL
11. pop3
12. RSA Data Security, Inc. MD5 Message-Digest Algorithm
13. tthtpd 2.5b
14. zlib
15. Apple Lossless
16. Boost
17. Expat
18. FastDelegate
19. Tremolo
20. Tremor
21. Mersenne Twister
22. cURL
23. c-ares
24. LZ4

当該ソフトウェアの著作権者の要求に基づき、弊社以下の内容をお客様に通知いたします。

**(1) bfhsk**

Copyright (c) 2007 Samuel KABAK

Permission is hereby granted, free of charge, to any person obtaining a copy of this software and associated documentation files (the "Software"), to deal in the Software without restriction, including without limitation the rights to use, copy, modify, merge, publish, distribute, sublicense, and/or sell copies of the Software, and to permit persons to whom the Software is furnished to do so, subject to the following conditions:

The above copyright notice and this permission notice shall be included in all copies or substantial portions of the Software. THE SOFTWARE IS PROVIDED "AS IS", WITHOUT WARRANTY OF ANY KIND, EXPRESS OR IMPLIED, INCLUDING BUT NOT LIMITED TO THE WARRANTIES OF MERCHANTABILITY, FITNESS FOR A PARTICULAR PURPOSE AND NONINFRINGEMENT. IN NO EVENT SHALL THE AUTHORS OR COPYRIGHT HOLDERS BE LIABLE FOR ANY CLAIM, DAMAGES OR OTHER LIABILITY, WHETHER IN AN ACTION OF CONTRACT, TORT OR OTHERWISE, ARISING FROM, OUT OF OR IN CONNECTION WITH THE SOFTWARE OR THE USE OR OTHER DEALINGS IN THE SOFTWARE.

**(2) kmli**

Copyright (c) 2000-2003 Intel Corporation All rights reserved.

Redistribution and use in source and binary forms, with or without modification, are permitted provided that the following conditions are met:

- \* Redistributions of source code must retain the above copyright notice, this list of conditions and the following disclaimer.
- \* Redistributions in binary form must reproduce the above copyright notice, this list of conditions and the following disclaimer in the documentation and/or other materials provided with the distribution.
- \* Neither name of Intel Corporation nor the names of its contributors may be used to endorse or promote products derived from this software without specific prior written permission.

THIS SOFTWARE IS PROVIDED BY THE COPYRIGHT HOLDERS AND CONTRIBUTORS "AS IS" AND ANY EXPRESS OR IMPLIED WARRANTIES, INCLUDING BUT NOT LIMITED TO, THE IMPLIED WARRANTIES OF MERCHANTABILITY AND FITNESS FOR A PARTICULAR PURPOSE ARE DISCLAIMED. IN NO EVENT SHALL INTEL OR CONTRIBUTORS BE LIABLE FOR ANY DIRECT, INDIRECT, INCIDENTAL, SPECIAL, EXEMPLARY, OR CONSEQUENTIAL DAMAGES (INCLUDING, BUT NOT LIMITED TO, PROCUREMENT OF SUBSTITUTE GOODS OR SERVICES; LOSS OF USE, DATA, OR PROFITS, OR BUSINESS INTERRUPTION) HOWEVER CAUSED AND ON ANY THEORY OF LIABILITY, WHETHER IN CONTRACT, STRICT LIABILITY, OR TORT (INCLUDING NEGLIGENCE OR OTHERWISE) ARISING IN ANY WAY OUT OF THE USE OF THIS SOFTWARE, EVEN IF ADVISED OF THE POSSIBILITY OF SUCH DAMAGE.

**(3) libcurt**

COPYRIGHT AND PERMISSION NOTICE

Copyright (c) 1998, 2007, Daniel Stenberg, <daniel@haxx.se>.

All rights reserved.

Permission to use, copy, modify, and distribute this software for any purpose with or without fee is hereby granted, provided that the above copyright notice and this permission notice appear in all copies.

THE SOFTWARE IS PROVIDED "AS IS", WITHOUT WARRANTY OF ANY KIND, EXPRESS OR IMPLIED, INCLUDING BUT NOT LIMITED TO THE WARRANTIES OF MERCHANTABILITY, FITNESS FOR A PARTICULAR PURPOSE AND NONINFRINGEMENT. IN NO EVENT SHALL THE FOUNDATION OR CONTRIBUTORS BE LIABLE FOR ANY CLAIM, DAMAGES OR OTHER LIABILITY, WHETHER IN AN ACTION OF CONTRACT, TORT OR OTHERWISE, ARISING FROM, OUT OF OR IN CONNECTION WITH THE SOFTWARE OR THE USE OR OTHER DEALINGS IN THE SOFTWARE.

Except as contained in this notice, the name of a copyright holder shall not be used in advertising or otherwise to promote the sale, use or other dealings in this Software without prior written authorization of the copyright holder.

**(4) libFLAC**

Copyright (c) 2000,2001,2002,2003,2004,2005,2006,2007 Josh Coakson

Redistribution and use in source and binary forms, with or without modification, are permitted provided that the following conditions are met:

- Redistributions of source code must retain the above copyright notice, this list of conditions and the following disclaimer.
- Redistributions in binary form must reproduce the above copyright notice, this list of conditions and the following disclaimer in the documentation and/or other materials provided with the distribution.
- Neither the name of the Xiph.org Foundation nor the names of its contributors may be used to endorse or promote products derived from this software without specific prior written permission.

THIS SOFTWARE IS PROVIDED BY THE COPYRIGHT HOLDERS AND CONTRIBUTORS "AS IS" AND ANY EXPRESS OR IMPLIED WARRANTIES, INCLUDING BUT NOT LIMITED TO, THE IMPLIED WARRANTIES OF MERCHANTABILITY AND FITNESS FOR A PARTICULAR PURPOSE ARE DISCLAIMED. IN NO EVENT SHALL THE FOUNDATION OR CONTRIBUTORS BE LIABLE FOR ANY DIRECT, INDIRECT, INCIDENTAL, SPECIAL, EXEMPLARY, OR CONSEQUENTIAL DAMAGES (INCLUDING, BUT NOT LIMITED TO, PROCUREMENT OF SUBSTITUTE GOODS OR SERVICES; LOSS OF USE, DATA, OR PROFITS, OR BUSINESS INTERRUPTION) HOWEVER CAUSED AND ON ANY THEORY OF LIABILITY, WHETHER IN CONTRACT, STRICT LIABILITY, OR TORT (INCLUDING NEGLIGENCE OR OTHERWISE) ARISING IN ANY WAY OUT OF THE USE OF THIS SOFTWARE, EVEN IF ADVISED OF THE POSSIBILITY OF SUCH DAMAGE.

**(5) libogg**

The authors make NO WARRANTY or representation, either express or implied, with respect to this software, its quality, accuracy, merchantability, or fitness for a particular purpose. This software is provided "AS IS", and you, its user, assume the entire risk as to its quality and accuracy.

This software is copyright (C) 1991-1998, Thomas G. Lane.

All Rights Reserved except as specified below.

Permission is hereby granted to use, copy, modify, and distribute this software (or portions thereof) for any purpose, without fee, subject to these conditions:

- (1) If any part of the source code for this software is distributed, then this README file must be included, with this copyright and no-warranty notice unaltered; and any additions, deletions, or changes to the original files must be clearly indicated in accompanying documentation.
- (2) If only executable code is distributed, then the accompanying documentation must state that "this software is based in part on the work of the Independent JPEG Group".
- (3) Permission for use of this software is granted only if the user accepts full responsibility for any undesirable consequences; the authors accept NO LIABILITY for damages of any kind.

These conditions apply to any software derived from or based on the IJG code, not just to the unmodified library. If you use our work, you ought to acknowledge us.

Permission is NOT granted for the use of any IJG author's name or company name in advertising or publicity relating to this software or products derived from it. This software may be referred to only as "the Independent JPEG Group's software". We specifically permit and encourage the use of this software as the basis of commercial products, provided that all warranty or liability claims are assumed by the product vendor.

ansi2knr.c is included in this distribution by permission of L. Peter Deutsch, sole proprietor of its copyright holder, Aladdin Enterprises of Menlo Park, CA. ansi2knr.c is NOT covered by the above copyright and conditions, but instead by the usual distribution terms of the Free Software Foundation; principally, that you must include source code if you redistribute it. (See the file ansi2knr.c for full details.) Since ansi2knr.c is not needed as part of any program generated from the IJG code, this does not limit you more than the foregoing paragraphs do.

The Unix configuration script "configure" was produced with GNU Autoconf. It is copyright by the Free Software Foundation but is freely distributable. The same holds for its supporting scripts (config.guess, config.sub, Iconfig, ltmain.sh). Another support script, install-sh, is copyright by M.I.T. but is also freely distributable.

It appears that the arithmetic coding option of the JPEG spec is covered by patents owned by IBM, AT&T, and Mitsubishi. Hence arithmetic coding cannot legally be used without obtaining one or more licenses. For this reason, support for arithmetic coding has been removed from the free JPEG software.

(Since arithmetic coding provides only a marginal gain over the unpatented Huffman method, it is unlikely that very many implementations will formally include it.) So far as we are aware, there are no patent restrictions on the remaining code. The IJG distribution formerly included code to read and write GIF files. To avoid entanglement with the Unisys LZW patent, GIF reading support has been removed altogether, and the GIF writer has been simplified to produce "uncompressed GIFs". This technique does not use the LZW algorithm; the resulting GIF files are larger than usual, but are readable by all standard GIF decoders.

We are required to state that "The Graphics Interchange Format (GIF) is the Copyright property of compuserve Incorporated. GIF(sm) is a Service Mark property of Compuserve Incorporated."

**(6) libogg**

Copyright (c) 2002, Xiph.org Foundation

Redistribution and use in source and binary forms, with or without modification, are permitted provided that the following conditions are met:

- Redistributions of source code must retain the above copyright notice, this list of conditions and the following disclaimer.
- Redistributions in binary form must reproduce the above copyright notice, this list of conditions and the following disclaimer in the documentation and/or other materials provided with the distribution.
- Neither the name of the Xiph.org Foundation nor the names of its contributors may be used to endorse or promote products derived from this software without specific prior written permission.

THIS SOFTWARE IS PROVIDED BY THE COPYRIGHT HOLDERS AND CONTRIBUTORS "AS IS" AND ANY EXPRESS OR IMPLIED WARRANTIES, INCLUDING BUT NOT LIMITED TO, THE IMPLIED WARRANTIES OF MERCHANTABILITY AND FITNESS FOR A PARTICULAR PURPOSE ARE DISCLAIMED. IN NO EVENT SHALL THE FOUNDATION OR CONTRIBUTORS BE LIABLE FOR ANY DIRECT, INDIRECT, INCIDENTAL, SPECIAL, EXEMPLARY, OR CONSEQUENTIAL DAMAGES (INCLUDING, BUT NOT LIMITED TO, PROCUREMENT OF SUBSTITUTE GOODS OR SERVICES; LOSS OF USE, DATA, OR PROFITS, OR BUSINESS INTERRUPTION) HOWEVER CAUSED AND ON ANY THEORY OF LIABILITY, WHETHER IN CONTRACT, STRICT LIABILITY, OR TORT (INCLUDING NEGLIGENCE OR OTHERWISE) ARISING IN ANY WAY OUT OF THE USE OF THIS SOFTWARE, EVEN IF ADVISED OF THE POSSIBILITY OF SUCH DAMAGE.

**(7) libogg**

COPYRIGHT NOTICE, DISCLAIMER, AND LICENSE:

If you modify libogg you may insert additional notices immediately following this sentence.

This code is released under the libogg license.

libogg versions 1.2.6, August 15, 2004, through 1.4.0, January 3, 2010, are Copyright (c) 2004, 2006-2007 Glenn Randers-Pehrson, and are distributed according to the same disclaimer and license as libpng-1.2.5 with the following individual added to the list of Contributing Authors:

Coosmin Truta

libogg versions 1.0.7, July 1, 2000, through 1.2.5 - October 3, 2002, are Copyright (c) 2000-2002 Glenn Randers-Pehrson, and are distributed according to the same disclaimer and license as libpng-1.0.6 with the following individuals added to the list of Contributing Authors:

Simon-Pierre Cadieux  
Eric S. Raymond

Gilles Volant

and with the following additions to the disclaimer:

There is no warranty against interference with your enjoyment of the library or against infringement. There is no warranty that our efforts or the library will fulfill any of your particular purposes or needs. This library is provided with all faults, and the entire risk of satisfactory quality, performance, accuracy, and effort is with the user.

libogg versions 0.97, January 1998, through 1.0.6, March 20, 2000, are Copyright (c) 1998, 1999 Glenn Randers-Pehrson, and are distributed according to the same disclaimer and license as libogg-0.96, with the following individuals added to the list of Contributing Authors:

Tom Lane  
Glenn Randers-Pehrson  
Willem van Schaik

libogg versions 0.89, June 1996, through 0.96, May 1997, are Copyright (c) 1996, 1997 Andreas Dilger Distributed according to the same disclaimer and license as libogg-0.86, with the following individuals added to the list of Contributing Authors:

John Bowler  
Kevin Bracey  
Sam Bushell

Magnus Holmgren  
Greg Roelofs  
Tom Tanner

libogg versions 0.5, May 1995, through 0.88, January 1996, are Copyright (c) 1995, 1996 Guy Eric Sinaat, Group 42, Inc. For the purposes of this copyright and license, "Contributing Authors" is defined as the following set of individuals:

Andreas Dilger  
Dave Martindale  
Guy Eric Sinaat  
Paul Schmidt  
Tim Wegner

The PNG Reference Library is supplied "AS IS". The Contributing Authors and Group 42, Inc. disclaim all warranties, expressed or implied, including, without limitation, the warranties of merchantability and of fitness for any purpose. The Contributing Authors and Group 42, Inc. assume no liability for direct, indirect, incidental, special, exemplary, or consequential damages, which may result from the use of the Reference Library, even if advised of the possibility of such damage.

Permission is hereby granted to use, copy, modify, and distribute this source code, or portions hereof, for any purpose, without fee, subject to the following restrictions:

- 1. The origin of this source code must not be misrepresented.
- 2. Altered versions must be plainly marked as such and must not be misrepresented as being the original source.
- 3. This Copyright notice may not be removed or altered from any source or altered source distribution.

The Contributing Authors and Group 42, Inc. specifically permit, without fee, and encourage the use of this source code as a component to supporting the PNG file format in commercial products. If you use this source code in a product, acknowledgment is not required but is appreciated.

**(8) libvorbis**

Copyright (c) 2002-2004 Xiph.org Foundation

Redistribution and use in source and binary forms, with or without modification, are permitted provided that the following conditions are met:

- Redistributions of source code must retain the above copyright notice, this list of conditions and the following disclaimer.
- Redistributions in binary form must reproduce the above copyright notice, this list of conditions and the following disclaimer in the documentation and/or other materials provided with the distribution.

- Neither the name of the Xiph.org Foundation nor the names of its contributors may be used to endorse or promote products derived from this software without specific prior written permission.

THIS SOFTWARE IS PROVIDED BY THE COPYRIGHT HOLDERS AND CONTRIBUTORS "AS IS" AND ANY EXPRESS OR IMPLIED WARRANTIES, INCLUDING BUT NOT LIMITED TO, THE IMPLIED WARRANTIES OF MERCHANTABILITY AND FITNESS FOR A PARTICULAR PURPOSE ARE DISCLAIMED. IN NO EVENT SHALL THE FOUNDATION OR CONTRIBUTORS BE LIABLE FOR ANY DIRECT, INDIRECT, INCIDENTAL, SPECIAL, EXEMPLARY, OR CONSEQUENTIAL DAMAGES (INCLUDING, BUT NOT LIMITED TO, PROCUREMENT OF SUBSTITUTE GOODS OR SERVICES; LOSS OF USE, DATA, OR PROFITS, OR BUSINESS INTERRUPTION) HOWEVER CAUSED AND ON ANY THEORY OF LIABILITY, WHETHER IN CONTRACT, STRICT LIABILITY, OR TORT (INCLUDING NEGLIGENCE OR OTHERWISE) ARISING IN ANY WAY OUT OF THE USE OF THIS SOFTWARE, EVEN IF ADVISED OF THE POSSIBILITY OF SUCH DAMAGE.

**(9) ntp**

This file is automatically generated from htm/copyright.html

Copyright Notice

jgg "Clone me," says Dolly sheepishly

Last update: 20:31 UTC Saturday, January 06, 2007

The following copyright notice applies to all files collectively called the Network Time Protocol Version 4 Distribution. Unless specifically declared otherwise in an individual file, this notice applies as if the text was explicitly included in the file.

Copyright (c) David L. Mills 1992-2007

Permission to use, copy, modify, and distribute this software and its documentation for any purpose with or without fee is hereby granted, provided that the above copyright notice appears in all copies and that both the copyright notice and this permission notice appear in supporting documentation, and that the name University of Delaware not be used in advertising or publicity pertaining to distribution of the software without specific, written prior permission. The University of Delaware makes no representations about the suitability this software for any purpose. It is provided "as is" without express or implied warranty.

The following individuals contributed in part to the Network Time Protocol Distribution Version 4 and are acknowledged as authors of this work.

- 1. [1]Mark Andrews <mark\_andrews@isc.org> Lethic atomic clock controller
- 2. [2]Barb Altmeier <altmeier@atsfsof.de> hopf Elektronik serial line and PCI-bus devices
- 3. [3]Vijal N&v-bais@mailman1.intel.com and [4]Clayton Kirkwood <kirkwood@striderfm.intel.com> port to WindowsNT 3.5
- 4. [5]Michael Barone <michael.barone@lmco.com> GPSVME fixes
- 5. [6]Jean-Francois Boudreau <Jean-Francois.Boudreau@viagenie.qc.ca> IPv6 support
- 6. [7]Ivan Berry <ivar@hawaii.leaf.com> syslog to file option
- 7. [8]Greg Brackley <greg.brackley@bjfinfo.com> Major rework of WINNT port. Clean up revcuf and iosignal code into separate modules.
- 8. [9]Marc Brett <Marc.Brett@westge.com> Magnavox GPS clock driver
- 9. [10]Piete Brooks <Piete.Brooks@ccl.cam.ac.uk> MSF clock driver, Trimble PARSE support
- 10. [11]Reg Clemens <reg@dwf.com> Oncore driver (Current maintainer)
- 11. [12]Steve Cift <scift@nsl.csliso.gov> OMEGA clock driver
- 12. [13]Casey Crellin <casey@cac.co.za> vWorks (Tornado) port and help with target configuration
- 13. [14]Sven Detrich <sven\_detrich@trimble.com> Palisade reference clock driver, NT adj. residuals, integrated Greg's Wintp port
- 14. [15]John A. Dundas III <dundas@saill.jp.nasa.gov> Apple A/UX port
- 15. [16]Torsten Duwe <duwe@immd4.informatica.uni-erlangen.de> Linux port
- 16. [17]Dennis Ferguson <dennis@nrbll.cnet.com> foundation code for NTP Version 2 as specified in RFC-1119
- 17. [18]John Hay <jhay@comtek.csi.csi.csi.gov> IPv6 support and testing
- 18. [19]Glenn Hollinger <glenn@herald.usak.ca> GOES clock driver
- 19. [20]Mike Iglesias <miglesias@uci.edu> DEC Alpha port
- 20. [21]Jim Jagielski <jim@jagubox.gsf.nasa.gov> A/UX port
- 21. [22]Jeff Johnson <jeff@chatham.usdnc.gov> massive prototyping overhaul
- 22. [23]Hans Lambers <hans.lambers@nrc.ca> <H.Lambers@chello.nl> ntpswep
- 23. [24]Paul Henning Kamp <pkh@FreeBSD.org> Oncore driver (Original author)
- 24. [26]Frank Kardel [27]kardel (at) ntp (dot) org> PARSE <GENERICE> driver (-14 reference clocks), STREAMS modules for PARSE, support scripts, syslog cleanup, dynamic interface handling
- 25. [28]William L. Jones <jones@hermes.cpsc.utexas.edu> RS/6000 AIX modifications, HPUX modifications
- 26. [29]Dave Kitz <dkitz@csco.com> RS/6000 AIX port
- 27. [30]Craig Leres <leres@ee.tsl.gov> 4.85SD port, ppsclock, MagnavoxGPS clock driver
- 28. [31]George Lindholm <lindholm@qucs.ubc.ca> SunOS 5.1 port
- 29. [32]Louis A. Mamakos <louie@ni.umed.edu> MDS-based authentication
- 30. [33]Lars H. Mathiesen <thorinn@pfcis.usda.gov> adaptation of foundation code for Version 3 as specified in RFC-1305
- 31. [34]Danny Mayer <mayer@ntp.org> Network I/O, Windows Port, Code Maintenance
- 32. [35]David L. Mills <mills@udel.edu> Version 4 foundation code, authentication, precision kernel, clock drivers: Spectracom, Austron, Arzitek, Health, ATOM, ACTS, KSI/Odetics, audio clock drivers: CHU, WWW/H, IRIG
- 33. [36]Wolfgang Moeller <moeller@gwdg1.dnet.gwdg.de> VMS port
- 34. [37]Jeffrey Mogul <mogul@pa.dec.com> ntptrace utility
- 35. [38]Tom Moore <tmoores@fivel.datonch.nrc.com> i886 svr4 port
- 36. [39]Kamali A. Mostafa <kamal@whence.com> SCO OpenServer port
- 37. [40]Denik Mutsaers <denik@bybox.demon.co.uk> and [41]Damon Hart-Davis <d@hd.net> ARC/RON MSF clock driver
- 38. [42]Rainer Pruy <Rainer.Pruy@informatik.uni-erlangen.de> monitoring/trap scripts, statistics file handling
- 39. [43]Dirce Richards <dirce@z3x.doc.gov> Digital UNIX V4.0 port
- 40. [44]Wilfredo Sanchez <wsanchez@apple.com> add support for NetInfo
- 41. [45]Nick Sayer <mrapple@quack.kfu.com> SunOS streams module
- 42. [46]Jack Sasportas <jack@movial.vintnet.com> Saved a Lot of space on the stuff in the htm/cpl/ subdirectory
- 43. [47]Ray Schindler <rschindl@sunness.com> UnixWare 1 port
- 44. [48]Michael Shields <shields@telmex.org> USNO clock driver
- 45. [49]Jeff Steinman <jss@pebbles.jp1.nasa.gov> Datum PTS clock driver
- 46. [50]Harlan Stenn <harlan@pfcis.com> GNU autohelp/autoconfigure makeover, various other bits (see the ChangeLog)
- 47. [51]Kenneth Stone <ken@esdd.hp.com> HP-UX port
- 48. [52]Ajai Thyagarajan <ajai@ee.udel.edu> IP multicasts/anycast support
- 49. [53]Tomoki TSURUOKA <tsuruoka@nkc.fukuo-u.ac.jp> TRAK clock driver

50.[54]Paul A Vieix <vieix@vix.com> TrueTime GPS driver, generic TrueTime clock driver  
 51.[55]Ulrich Windl <Ulrich.Windl@rz.uni-regensburg.de> corrected and validated HTML documents according to the HTML DTD References

1. mailto: mark\_andrews@isc.org  
 2. mailto: altmeier@atsoft.de  
 3. mailto: vbls@mainman1.intel.com  
 4. mailto: kirkwood@mainman1.intel.com  
 5. mailto: michael.barone@lmco.com  
 6. mailto: Jean-Francois.Boudreault@viagenie.qc.ca  
 7. mailto: kari@owl.HQ.leaf.com  
 8. mailto: greg.brackley@bigfoot.com  
 9. mailto: Marc.Breit@wsgwgo.com  
 10. mailto: Pieter.Brooks@cl.cam.ac.uk  
 11. mailto: reg@dfw.com  
 12. mailto: cliff@ml.csiro.au  
 13. mailto: casey@cs.coc.uo  
 14. mailto: Sven\_Dietrich@trimble.COM  
 15. mailto: dundes@sat.jpl.nasa.gov  
 16. mailto: duwe@immdd4.informatik.uni-erlangen.de  
 17. mailto: dennis@mrbill.canet.ca  
 18. mailto: jhay@comtek.cair.co.za  
 19. mailto: glenn@herald.usask.ca  
 20. mailto: sjeasas@ucj.edu  
 21. mailto: jagbox@gsc.nasa.gov  
 22. mailto: j@chatham.usdesign.com  
 23. mailto: Hans.Lamberton@n1.origin-t.com  
 24. mailto: H.Lamberton@chello.nl  
 25. mailto: phk@FreeBSD.ORG  
 26. http://www.informatik.uni-erlangen.de/%7ekardel  
 27. mailto: kardel@intp.dof.rdg  
 28. mailto: jones@hermes.chpc.uexas.edu  
 29. mailto: dkat@coiso.com  
 30. mailto: leres@ee.tli.gov  
 31. mailto: lindholm@ucs.ucsb.ca  
 32. mailto: loue@lund.edu  
 33. mailto: thorn@dku.dk  
 34. mailto: mayer@ntp.org  
 35. mailto: mils@udel.edu  
 36. mailto: moeller@gwdg.v1.dnet.gwdg.de  
 37. mailto: mog@ipa.econ.cam.ac.uk  
 38. mailto: tmcore@frc.vad.yatpoh.ncr.com  
 39. mailto: kama@whence.com  
 40. mailto: derek@toybox.demon.co.uk  
 41. mailto: d@hd.org  
 42. mailto: Rainier.Fruy@informatik.uni-erlangen.de  
 43. mailto: dircs@h3c.com  
 44. mailto: wsanchez@apple.com  
 45. mailto: mrapple@quack.ktu.com  
 46. mailto: jack@innovativeternet.com  
 47. mailto: schnitz@unipress.com  
 48. mailto: shields@tembel.org  
 49. mailto: pebbles@nasa.gov  
 50. mailto: harlan@rjcs.com  
 51. mailto: ken@sdd.hp.com  
 52. mailto: ajh@ee.ued.edu  
 53. mailto: tsunouka@nc.fukuoaka-u.ac.jp  
 54. mailto: vieix@vix.com  
 55. mailto: Ulrich.Windl@rz.uni-regensburg.de

**(10) OpenSSL**

**LICENSE ISSUES**

-----  
 The OpenSSL toolkit stays under a dual license, i.e. both the conditions of the OpenSSL License and the original SSLeay license apply to the toolkit. See below for the actual license texts. Actually both licenses are BSD-style Open Source licenses. In case of any license issues related to OpenSSL, please contact openssl-core@openssl.org.  
 OpenSSL License  
 -----

-----  
 Copyright (c) 1998-2007 The OpenSSL Project. All rights reserved.  
 Redistribution and use in source and binary forms, with or without modification, are permitted provided that the following conditions are met:

1. Redistributions of source code must retain the above copyright notice, this list of conditions and the following disclaimer.
2. Redistributions in binary form must reproduce the above copyright notice, this list of conditions and the following disclaimer in the documentation and/or other materials provided with the distribution.
3. All advertising materials mentioning features or use of this software must display the following acknowledgment: "This product includes software developed by the OpenSSL Project for use in the OpenSSL Toolkit (http://www.openssl.org)"
4. The names "OpenSSL Toolkit" and "OpenSSL Project" must not be used to endorse or promote products derived from this software without prior written permission. For written permission, please contact openssl-core@openssl.org.
5. Products derived from this software may not be called "OpenSSL" nor may "OpenSSL" appear in their names without prior written permission of the OpenSSL Project.
6. Redistributions of any form whatsoever must retain the following acknowledgment: "This product includes software developed by the OpenSSL Project for use in the OpenSSL Toolkit (http://www.openssl.org)"

THIS SOFTWARE IS PROVIDED BY THE OPENSSL PROJECT "AS IS" AND ANY EXPRESSED OR IMPLIED WARRANTIES, INCLUDING, BUT NOT LIMITED TO, THE IMPLIED WARRANTIES OF MERCHANTABILITY AND FITNESS FOR A PARTICULAR PURPOSE ARE DISCLAIMED. IN NO EVENT SHALL THE OPENSSL PROJECT OR ITS CONTRIBUTORS BE LIABLE FOR ANY DIRECT, INDIRECT, INCIDENTAL, SPECIAL, EXEMPLARY, OR CONSEQUENTIAL DAMAGES (INCLUDING, BUT NOT LIMITED TO, PROCUREMENT OF SUBSTITUTE GOODS OR SERVICES; LOSS OF USE, DATA, OR PROFITS; OR BUSINESS INTERRUPTION) HOWEVER CAUSED AND ON ANY THEORY OF LIABILITY, WHETHER IN CONTRACT, STRICT LIABILITY, OR TORT (INCLUDING NEGLIGENCE OR OTHERWISE) ARISING IN ANY WAY OUT OF THE USE OF THIS SOFTWARE, EVEN IF ADVISED OF THE POSSIBILITY OF SUCH DAMAGE.  
 -----  
 This product includes cryptographic software written by Eric Young (eay@cryptsoft.com). This product includes software written by Tim Hudson (tjh@cryptsoft.com).  
 Original SSLeay License  
 -----

Copyright (c) 1995-1998 Eric Young (eay@cryptsoft.com) All rights reserved.  
 This package is an SSL implementation written by Eric Young (eay@cryptsoft.com).  
 The implementation was written so as to conform with Netscapes SSL.

This library is free for commercial and non-commercial use as long as the following conditions are ashered. The following conditions apply to all code found in this distribution, be it the RC4, RSA, I2D, DES, etc. code; not just the SSL code. The SSL documentation included with this distribution is covered by the same copyright terms except that the holder is Tim Hudson (tjh@cryptsoft.com).

Copyright remains Eric Young's, and as such any Copyright notices in the code are not to be removed. If this package is used in a product, Eric Young should be given attribution as the author of the parts of the library used. This can be in the form of a textual message at program startup or in documentation (online or textual) provided with the package. Redistribution and use in source and binary forms, with or without modification, are permitted provided that the following conditions are met:

1. Redistributions of source code must retain the copyright notice, this list of conditions and the following disclaimer.
2. Redistributions in binary form must reproduce the above copyright notice, this list of conditions and the following disclaimer in the documentation and/or other materials provided with the distribution.
3. All advertising materials mentioning features or use of this software must display the following acknowledgement: "Eric Young (eay@cryptsoft.com)"
4. If you include any Windows specific code (or a derivative thereof) from the apps directory (application code) you must include an acknowledgement: "This product includes software written by Tim Hudson (tjh@cryptsoft.com)"

THIS SOFTWARE IS PROVIDED BY ERIC YOUNG "AS IS" AND ANY EXPRESS OR IMPLIED WARRANTIES, INCLUDING, BUT NOT LIMITED TO, THE IMPLIED WARRANTIES OF MERCHANTABILITY AND FITNESS FOR A PARTICULAR PURPOSE ARE DISCLAIMED. IN NO EVENT SHALL THE AUTHOR OR CONTRIBUTORS BE LIABLE FOR ANY DIRECT, INDIRECT, INCIDENTAL, SPECIAL, EXEMPLARY, OR CONSEQUENTIAL DAMAGES (INCLUDING, BUT NOT LIMITED TO, PROCUREMENT OF SUBSTITUTE GOODS OR SERVICES; LOSS OF USE, DATA, OR PROFITS; OR BUSINESS INTERRUPTION) HOWEVER CAUSED AND ON ANY THEORY OF LIABILITY, WHETHER IN CONTRACT, STRICT LIABILITY, OR TORT (INCLUDING NEGLIGENCE OR OTHERWISE) ARISING IN ANY WAY OUT OF THE USE OF THIS SOFTWARE, EVEN IF ADVISED OF THE POSSIBILITY OF SUCH DAMAGE.  
 -----

**(11) popt**

Copyright (c) 1998 Red Hat Software  
 Permission is hereby granted, free of charge, to any person obtaining a copy of this software and associated documentation files (the "Software"), to deal in the Software without restriction, including without limitation the rights to use, copy, modify, merge, publish, distribute, sublicense, and/or sell copies of the Software, and to permit persons to whom the Software is furnished to do so, subject to the following conditions:  
 The above copyright notice and this permission notice shall be included in all copies or substantial portions of the Software.

THE SOFTWARE IS PROVIDED "AS IS", WITHOUT WARRANTY OF ANY KIND, EXPRESS OR IMPLIED, INCLUDING BUT NOT LIMITED TO THE WARRANTIES OF MERCHANTABILITY, FITNESS FOR A PARTICULAR PURPOSE AND NONINFRINGEMENT. IN NO EVENT SHALL THE X CONSORTIUM BE LIABLE FOR ANY CLAIM, DAMAGES OR OTHER LIABILITY, WHETHER IN AN ACTION OF CONTRACT, TORT OR OTHERWISE, ARISING FROM, OUT OF OR IN CONNECTION WITH THE SOFTWARE OR THE USE OR OTHER DEALINGS IN THE SOFTWARE.

Except as contained in this notice, the name of the X Consortium shall not be used in advertising or otherwise to promote the sale, use or other dealings in this Software without prior written authorization from the X Consortium.  
**(12) RSA Data Security, Inc. MD5 Message-Digest Algorithm**  
 Copyright (c) 1991-2, RSA Data Security, Inc. Created 1991. All rights reserved.  
 License to copy and use this software is granted provided that it is identified as the "RSA Data Security, Inc. MD5 Message-Digest Algorithm" in all material mentioning or referencing this software or this function.

License is also granted to make and use derivative works provided that such works are identified as "derived from the RSA Data Security, Inc. MD5 Message-Digest Algorithm" in all material mentioning or referencing the derived work.  
 RSA Data Security, Inc. makes no representations concerning either the merchantability of this software or the suitability of this software for any particular purpose. It is provided "as is" without express or implied warranty of any kind.  
 These notices must be retained in any copies of any part of this documentation and/or software.  
**(13) lhttpd 2.2.5b**

Copyright c 2000 by Jef Poskanzer <jef@mail.acme.com>. All rights reserved.  
 Redistribution and use in source and binary forms, with or without modification, are permitted provided that the following conditions are met:

- 1.Redistributions of source code must retain the above copyright notice, this list of conditions and the following disclaimer.
- 2.Redistributions in binary form must reproduce the above copyright notice, this list of conditions and the following disclaimer in the documentation and/or other materials provided with the distribution.

THIS SOFTWARE IS PROVIDED BY THE AUTHOR AND CONTRIBUTORS "AS IS" AND ANY EXPRESS OR IMPLIED WARRANTIES, INCLUDING, BUT NOT LIMITED TO, THE IMPLIED WARRANTIES OF MERCHANTABILITY AND FITNESS FOR A PARTICULAR PURPOSE ARE DISCLAIMED. IN NO EVENT SHALL THE AUTHOR OR CONTRIBUTORS BE LIABLE FOR ANY DIRECT, INDIRECT, INCIDENTAL, SPECIAL, EXEMPLARY, OR CONSEQUENTIAL DAMAGES (INCLUDING, BUT NOT LIMITED TO, PROCUREMENT OF SUBSTITUTE GOODS OR SERVICES; LOSS OF USE, DATA, OR PROFITS, OR BUSINESS INTERRUPTION) HOWEVER CAUSED AND ON ANY THEORY OF LIABILITY, WHETHER IN CONTRACT, STRICT LIABILITY, OR TORT (INCLUDING NEGLIGENCE OR OTHERWISE) ARISING IN ANY WAY OUT OF THE USE OF THIS SOFTWARE, EVEN IF ADVISED OF THE POSSIBILITY OF SUCH DAMAGE.  
**(14) zlib**

zlib.h -- interface of the 'zlib' general purpose compression library version 1.1.4, March 11th, 2002  
 Copyright (c) 1995-2002 Jean-loup Gailly and Mark Adler  
 This software is provided 'as-is', without any express or implied warranty. In no event will the authors be held liable for any damages arising from the use of this software.

Permission is granted to anyone to use this software for any purpose, including commercial applications, and to alter it and redistribute it freely, subject to the following restrictions:

1. The origin of this software must not be misrepresented; you must not claim that you wrote the original software. If you use this software in a product, an acknowledgment in the product documentation would be appreciated but is not required.
2. Altered source versions must be plainly marked as such, and must not be misrepresented as being the original software.
3. This notice may not be removed or altered from any source distribution.

Jean-loup Gailly Mark Adler  
 jloup@cpq.org mads@alumni.caltech.edu

The data format used by the zlib library is described by RFCs (Request for Comments) 1950 to 1952 in the files ftp://isis.merimic.net/rfc1950.txt (zlib format), rfc1951.txt (deflate format) and rfc1952.txt (gzip format).

**(15) Apple Lossless**

Apache License  
 Version 2.0, January 2004  
 http://www.apache.org/licenses/

**TERMS AND CONDITIONS FOR USE, REPRODUCTION, AND DISTRIBUTION**

1. Definitions.  
 "License" shall mean the terms and conditions for use, reproduction, and distribution as defined by Sections 1 through 9 of this document.  
 "Licensor" shall mean the copyright owner or entity authorized by the copyright owner that is granting the License.  
 "Legal Entity" shall mean the union of the acting entity and all other entities that control, are controlled by, or are under common control with that entity. For the purposes of this definition, "control" means (i) the power, direct or indirect, to cause the direction or management of such entity, whether by contract or otherwise, or (ii) ownership of fifty percent (50%) or more of the outstanding shares, or (iii) beneficial ownership of such entity.

"You" (or "Your") shall mean an individual or Legal Entity exercising permissions granted by this License.  
 "Source" form shall mean the preferred form for making modifications, including but not limited to software source code, documentation source, and configuration files.  
 "Object" form shall mean any form resulting from mechanical transformation or translation of a Source form, including but not limited to compiled object code, generated documentation, and conversions to other media types.  
 "Work" shall mean the work of authorship, whether in Source or Object form, made available under the License, as indicated by a copyright notice that is included in or attached to the work (an example is provided in the Appendix below).

"Derivative Works" shall mean any work, whether in Source or Object form, that is based on (or derived from) the Work and for which the editorial revisions, annotations, elaborations, or other modifications represent, as a whole, an original work of authorship. For the purposes of this License, Derivative Works shall not include works that remain separate from, or merely link (or bind by name) to the interfaces of, the Work and Derivative Works thereof.

"Contribution" shall mean any work of authorship, including the original version of the Work and any modifications or additions to that Work or Derivative Works thereof, that is intentionally submitted to Licensor for inclusion in the Work by the copyright owner or by an individual or Legal Entity authorized to submit on behalf of the copyright owner. For the purposes of this definition, "submitted" means any form of electronic, verbal, or written communication sent to the Licensor or its representatives, including but not limited to communication on electronic mailing lists, source code control systems, and issue tracking systems that are managed by, or on behalf of, the Licensor for the purpose of discussing and improving the Work, but excluding communication that is conspicuously marked or otherwise designated in writing by the copyright owner as "Not a Contribution."

"Contributor" shall mean Licensor and any individual or Legal Entity on behalf of whom a Contribution has been received by Licensor and subsequently incorporated within the Work.

2. Grant of Copyright License.  
 Subject to the terms and conditions of this License, each Contributor hereby grants to You a perpetual, worldwide, non-exclusive, no-charge, royalty-free, irrevocable copyright license to reproduce, prepare Derivative Works of, publicly display, publicly perform, sublicense, and distribute the Work and such Derivative Works in Source or Object form.

3. Grant of Patent License.  
 Subject to the terms and conditions of this License, each Contributor hereby grants to You a perpetual, worldwide, non-exclusive, no-charge, royalty-free, irrevocable (except as stated in this section) patent license to make, have made, use, offer to sell, sell, import, and otherwise transfer the Work, where such license applies only to those patent claims licensable by such Contributor that are necessarily infringed by their Contribution(s) alone or by combination of their Contribution(s) with the Work to which such Contribution(s) was submitted. If You institute patent litigation against any entity (including a cross-claim or counterclaim in a lawsuit) alleging that the Work or a Contribution incorporated within the Work constitutes direct or contributory patent infringement, then any patent licenses granted to You under this License for that Work shall terminate as of the date such litigation is filed.

4. Redistribution.  
 You may reproduce and distribute copies of the Work or Derivative Works thereof in any medium, with or without modifications, and in Source or Object form, provided that You meet the following conditions:

1. You must give any other recipients of the Work or Derivative Works a copy of this License; and
2. You must cause any modified files to carry prominent notices stating that You changed the files; and
3. You must retain, in the Source form of any Derivative Works that You distribute, all copyright, patent, trademark, and attribution notices from the Source form of the Work, excluding those notices that do not pertain to any part of the Derivative Works; and

4. If the Work includes a "NOTICE" text file as part of its distribution, then any Derivative Works that You distribute must include a readable copy of the attribution notices contained within such NOTICE file, excluding those notices that do not pertain to any part of the Derivative Works, in at least one of the following places: within a NOTICE text file distributed as part of the Derivative Works; within the Source form or documentation, if provided along with the Derivative Works; or, within a display generated by the Derivative Works, if and wherever such third-party notices normally appear. The contents of the NOTICE file are for informational purposes only and do not modify the License. You may add Your own attribution notices within Derivative Works that You distribute, alongside or as an addendum to the NOTICE text from the Work, provided that such additional attribution notices cannot be construed as modifying the License.

You may add your own copyright statement to Your modifications and may provide additional or different license terms and conditions for use, reproduction, or distribution of Your modifications, or for any such Derivative Works as a whole, provided Your use, reproduction, and distribution of the Work otherwise complies with the conditions stated in this License.

5. Submission of Contributions.  
 Unless You explicitly state otherwise, any Contribution intentionally submitted for inclusion in the Work by You to the Licensor shall be under the terms and conditions of this License, without any additional terms or conditions. Notwithstanding the above, nothing herein shall supersede or modify the terms of any separate license agreement you may have executed with Licensor regarding such Contributions.

6. Trademarks.  
 This License does not grant permission to use the trade names, trademarks, service marks, or product names of the Licensor, except as required for reasonable and customary use in describing the origin of the Work and reproducing the content of the NOTICE file.

7. Disclaimer of Warranty.  
 Unless required by applicable law or agreed to in writing, Licensor provides the Work (and each Contributor provides its Contributions) on an "AS IS" BASIS, WITHOUT WARRANTIES OR CONDITIONS OF ANY KIND, either express or implied, including, without limitation, any warranties or conditions of TITLE, NON-INFRINGEMENT, MERCHANTABILITY, or FITNESS FOR A PARTICULAR PURPOSE. You are solely responsible for determining the appropriateness of using or redistributing the Work and assume any risks associated with Your exercise of permissions under this License.

8. Limitation of Liability.

In no event and under no legal theory, whether in tort (including negligence), contract, or otherwise, unless required by applicable law (such as deliberate and grossly negligent acts) or agreed to in writing, shall any Contributor be liable to You for damages, including any direct, indirect, special, incidental, or consequential damages of any character arising as a result of this License or of the use or inability to use the Work (including but not limited to damages for loss of goodwill, work stoppage, computer failure or malfunction, or any and all other commercial damages or losses), even if such Contributor has been advised of the possibility of such damages.

9. Accepting Warranty or Additional Liability.

While redistributing the Work or Derivative Works thereof, You may choose to offer, and charge a fee for, acceptance of support, warranty, indemnity, or other liability obligations and/or rights consistent with this License. However, in accepting such obligations, You may act only on Your own behalf and on Your sole responsibility, not on behalf of any other Contributor, and only if You expressly defend, indemnify and hold harmless for any liability incurred by or claims asserted against such Contributor by reason of your accepting any such warranty or additional liability.

END OF TERMS AND CONDITIONS

APPENDIX: How to apply the Apache License to your work.

To apply the Apache License to your work, attach the following boilerplate notice, with the fields enclosed by brackets [ ] replaced with your own identifying information. (Don't include the brackets!) The text should be enclosed in the appropriate comment syntax for the file format. We also recommend that a file or class name and description of purpose be included on the same "printed page" as the copyright notice for easier identification within third-party archives.

Copyright © 2011 Apple Inc. All rights reserved.

Licensed under the Apache License, Version 2.0 (the "License");

you may not use this file except in compliance with the License.

You may obtain a copy of the License at

http://www.apache.org/licenses/LICENSE-2.0

Unless required by applicable law or agreed to in writing, software distributed under the License is distributed on an "AS IS" BASIS, WITHOUT WARRANTIES OR CONDITIONS OF ANY KIND, either express or implied. See the License for the specific language governing permissions and limitations under the License.

(16) Boost

http://www.boost.org/

Boost Software License - Version 1.0 - August 17th, 2003

Permission is hereby granted, free of charge, to any person or organization obtaining a copy of the software and accompanying documentation prepared by this license (the "Software") to use, reproduce, display, distribute, execute, and transmit the Software, and to prepare derivative works of the Software, and to permit third-parties to whom the Software is furnished to do so, all subject to the following: The copyright notices in the Software and this entire statement, including the above license grant, this restriction and the following disclaimer, must be included in all copies of the Software, in whole or in part, and in all derivative works of the Software, unless such copies or derivative works are solely in the form of machine-executable object code generated by a source language processor.

THE SOFTWARE IS PROVIDED "AS IS", WITHOUT WARRANTY OF ANY KIND, EXPRESS OR IMPLIED, INCLUDING BUT NOT LIMITED TO THE WARRANTIES OF MERCHANTABILITY, FITNESS FOR A PARTICULAR PURPOSE, TITLE AND NON-INFRINGEMENT. IN NO EVENT SHALL THE COPYRIGHT HOLDERS OR ANYONE DISTRIBUTING THE SOFTWARE BE LIABLE FOR ANY DAMAGES OR OTHER LIABILITY, WHETHER IN CONTRACT, TORT OR OTHERWISE, ARISING FROM, OUT OF OR IN CONNECTION WITH THE SOFTWARE OR THE USE OR OTHER DEALINGS IN THE SOFTWARE.

THE SOFTWARE IS PROVIDED "AS IS", WITHOUT WARRANTY OF ANY KIND, EXPRESS OR IMPLIED, INCLUDING BUT NOT LIMITED TO THE WARRANTIES OF MERCHANTABILITY, FITNESS FOR A PARTICULAR PURPOSE AND NON-INFRINGEMENT. IN NO EVENT SHALL THE AUTHORS OR COPYRIGHT HOLDERS BE LIABLE FOR ANY CLAIM, DAMAGES OR OTHER LIABILITY, WHETHER IN AN ACTION OF CONTRACT, TORT OR OTHERWISE, ARISING FROM, OUT OF OR IN CONNECTION WITH THE SOFTWARE OR THE USE OR OTHER DEALINGS IN THE SOFTWARE.

(17) Expat

http://www.jdkark.com/xm/expat.html

Expat License, Copyright (c) 1998, 1999, 2000 The Open Source Software Center Ltd

Permission is hereby granted, free of charge, to any person obtaining a copy of this software and associated documentation files (the "Software"), to deal in the Software without restriction, including without limitation the rights to use, copy, modify, merge, publish, distribute, sublicense, and/or sell copies of the Software, and to permit persons to whom the Software is furnished to do so, subject to the following conditions:

The above copyright notice and this permission notice shall be included in all copies or substantial portions of the Software. THE SOFTWARE IS PROVIDED "AS IS", WITHOUT WARRANTY OF ANY KIND, EXPRESS OR IMPLIED, INCLUDING BUT NOT LIMITED TO THE WARRANTIES OF MERCHANTABILITY, FITNESS FOR A PARTICULAR PURPOSE AND NON-INFRINGEMENT. IN NO EVENT SHALL THE AUTHORS OR COPYRIGHT HOLDERS BE LIABLE FOR ANY CLAIM, DAMAGES OR OTHER LIABILITY, WHETHER IN AN ACTION OF CONTRACT, TORT OR OTHERWISE, ARISING FROM, OUT OF OR IN CONNECTION WITH THE SOFTWARE OR THE USE OR OTHER DEALINGS IN THE SOFTWARE.

(18) FastDelegate

http://www.codeproject.com/KB/cpp/FastDelegate.aspx

THE WORK (AS DEFINED BELOW) IS PROVIDED UNDER THE TERMS OF THIS CODE PROJECT OPEN LICENSE ("LICENSE"). THE WORK IS PROTECTED BY COPYRIGHT AND/OR OTHER APPLICABLE LAW. ANY USE OF THE WORK OTHER THAN AS AUTHORIZED UNDER THIS LICENSE OR COPYRIGHT LAW IS PROHIBITED. BY EXERCISING ANY RIGHTS TO THE WORK PROVIDED HEREIN, YOU ACCEPT AND AGREE TO BE BOUND BY THE TERMS OF THIS LICENSE. THE AUTHOR GRANTS YOU THE RIGHTS CONTAINED HEREIN IN CONSIDERATION OF YOUR ACCEPTANCE OF SUCH TERMS AND CONDITIONS. IF YOU DO NOT AGREE TO ACCEPT AND BE BOUND BY THE TERMS OF THIS LICENSE, YOU CANNOT MAKE ANY USE OF THE WORK.

Definitions.

- a. "Articles" means, collectively, all articles written by Author which describes how the Source Code and Executable Files for the Work may be used by a user.
b. "Author" means the individual or entity that offers the Work under the terms of this License.
c. "Derivative Work" means a work based upon the Work or upon the Work and other pre-existing works.
d. "Executable Files" means, collectively, binary files, configuration and any other required data files included in the Work.
e. "Publisher" means the provider of the website, magazine, CD-ROM, DVD or other medium from or by which the Work is obtained by You.
f. "Source Code" refers to the collection of source code and configuration files used to create the Executable Files.
g. "Standard Version" refers to such a Work if it has not been modified, or has been modified in accordance with the consent of the Author, such consent being in the full discretion of the Author.
h. "Work" refers to the collection of Works distributed by the Publisher, including the Source Code, Executable Files, binaries, data files, documentation, whitepapers and the Articles.
i. "You" is you, an individual or entity wishing to use the Work and exercise your rights under this License.
Fair Use/Fair Use Rights. Nothing in this License is intended to reduce, limit, or restrict any rights arising from fair use, fair dealing, first sale or other limitations on the exclusive rights of the copyright owner under copyright law or other applicable laws.
License Grant. Subjecting You to the terms of this License, the Author hereby grants You a worldwide, royalty-free, non-exclusive, perpetual (for the duration of the applicable copyright) license to exercise the rights in the Work as stated below:
a. You may use the standard version of the Source Code or Executable Files in Your own applications.
b. You may apply bug fixes, portability fixes and other modifications obtained from the Public Domain or from the Author. A Work modified in such way shall still be considered the standard version and will be subject to this License.
c. You may otherwise modify Your copy of this Work (excluding the Articles) in any way to create a Derivative Work, provided that You assert a prominent notice in each changed file stating how, when and where You changed that file.
d. You may distribute the standard version of the Executable Files and Source Code or Derivative Work in aggregate with other (possibly commercial) programs as part of a larger (possibly commercial) software distribution.
e. The Articles discussing the Work published in any form by the author may not be distributed or republished without the Author's consent. The author retains copyright in any such Articles. You may use the Executable Files and Source Code pursuant to this License but you may not repost or republish or otherwise distribute or make available the Articles, without the prior written consent of the Author.
Any subroutines or modules supplied by You and linked into the Source Code or Executable Files this Work shall not be considered part of this Work and will not be subject to the terms of this License.
Patent License. Subject to the terms and conditions of this License, each Author hereby grants to You a perpetual, worldwide, non-exclusive, no-charge, royalty-free, irrevocable (except as stated in this section) patent license to make, have made, use, import, and otherwise transfer the Work.
Restrictions. The license granted in Section 3 above is expressly made subject to and limited by the following restrictions:
a. You agree not to remove any of the original copyright, patent, trademark, and attribution notices and associated disclaimers that may appear in the Source Code or Executable Files.
b. You agree not to advertise or in any way imply that this Work is a product of Your own.
c. The name of the Author may not be used to endorse or promote products derived from the Work without the prior written consent of the Author.
d. You agree not to sell, lease, or rent any part of the Work. This does not restrict you from including the Work or any part of the Work inside a larger software distribution that itself is being sold. The Work by itself, though, cannot be sold, leased or rented.
e. You may distribute the Executable Files and Source Code only under the terms of this License, and You must include a copy of, or the Uniform Resource Identifier for, this License with every copy of the Executable Files or Source Code You distribute and ensure that each recipient of such Executable Files and Source Code agrees that the terms of this License apply to such Executable Files and/or Source Code. You may not offer or impose any terms on the Work that alter or restrict the terms of this License or the recipients' exercise of the rights granted hereunder. You may not sublicense the Work. You must keep intact all notices that refer to this License and to the disclaimer of warranties. You may not distribute the Executable Files or Source Code with any technological measures that control access or use of the Work in a manner inconsistent with the terms of this License.
f. You agree not to use the Work for illegal, immoral or improper purposes, or on pages containing illegal, immoral or improper material. The Work is subject to applicable export laws. You agree to comply with all such laws and regulations that may apply to the Work after Your receipt of the Work.

Representations, Warranties and Disclaimer. THIS WORK IS PROVIDED "AS IS", "WHERE IS" AND "AS AVAILABLE", WITHOUT ANY EXPRESS OR IMPLIED WARRANTIES OR CONDITIONS OR GUARANTEES. YOU, THE USER, ASSUME ALL RISK IN ITS USE, INCLUDING COPYRIGHT INFRINGEMENT, PATENT INFRINGEMENT, SUITABILITY, ETC. AUTHOR EXPRESSLY DISCLAIMS ALL EXPRESS, IMPLIED OR STATUTORY WARRANTIES OR CONDITIONS, INCLUDING WITHOUT LIMITATION, WARRANTIES OR CONDITIONS OF MERCHANTABILITY, MERCHANTABLE QUALITY OR FITNESS FOR A PARTICULAR PURPOSE, OR ANY WARRANTY OF TITLE OR NON-INFRINGEMENT, OR THAT THE WORK (OR ANY PORTION THEREOF) IS CORRECT, USEFUL, BUG-FREE OR FREE OF VIRUSES. YOU MUST PASS THIS DISCLAIMER ON WHENEVER YOU DISTRIBUTE THE WORK OR DERIVATIVE WORKS.

Indemnity. You agree to defend, indemnify and hold harmless the Author and the Publisher from and against any claims, suits, losses, damages, liabilities, costs, and expenses (including reasonable legal or attorneys' fees) resulting from or relating to any use of the Work by You.

Limitation on Liability. EXCEPT TO THE EXTENT REQUIRED BY APPLICABLE LAW, IN NO EVENT WILL THE AUTHOR OR THE PUBLISHER BE LIABLE TO YOU ON ANY LEGAL THEORY FOR ANY SPECIAL, INCIDENTAL, CONSEQUENTIAL, PUNITIVE OR EXEMPLARY DAMAGES ARISING OUT OF THIS LICENSE OR THE USE OF THE WORK OR OTHERWISE, EVEN IF THE AUTHOR OR THE PUBLISHER HAS BEEN ADVISED OF THE POSSIBILITY OF SUCH DAMAGES.

Termination.

a. This License and the rights granted hereunder will terminate automatically upon any breach by You of any term of this License. Individuals or entities who have received Derivative Works from You under this License, however, will not have their licenses terminated provided such individuals or entities remain in full compliance with those licenses. Sections 1, 2, 6, 7, 8, 9, 10 and 11 will survive any termination of this License.

b. If you bring a copyright, trademark, patent or any other infringement claim against any contributor over infringements you claim are made by the Work, your license from such contributor to the Work ends automatically.

c. Subject to the above terms and conditions, this License is perpetual for the duration of the applicable copyright in the Work. Notwithstanding the above, the Author reserves the right to release the Work under different license terms or to stop distributing the Work at any time, provided, however that any such election will not serve to withdraw this License (or any other license that has been, or is required to be, granted under the terms of this License), and this License will continue in full force and effect unless terminated as stated above.

Publisher. The parties hereby confirm that the Publisher shall not, under any circumstances, be responsible for and shall not have any liability in respect of the subject matter of this License. The Publisher makes no warranty whatsoever in connection with the Work and shall not be liable to You or any party on any legal theory for any damages whatsoever, including without limitation any general, special, incidental or consequential damages arising in connection to this license. The Publisher reserves the right to cease making the Work available to You at any time without notice.

Miscellaneous

a. This License shall be governed by the laws of the location of the head office of the Author or if the Author is an individual, the laws of location of the principal place of residence of the Author.

b. If any provision of this License is invalid or unenforceable under applicable law, it shall not affect the validity or enforceability of the remainder of the terms of this License, and without further action by the parties to this License, such provision shall be reformed to the minimum extent necessary to make such provision valid and enforceable.

c. No term or provision of this License shall be deemed waived and no breach consented to unless such waiver or consent shall be in writing and signed by the party to be charged with such waiver or consent.

d. This License constitutes the entire agreement between the parties with respect to the Work licensed hereunder. There are no understandings, agreements or representations with respect to the Work not specified herein. The Author shall not be bound by any additional provisions that may appear in any communication from You. This License may not be modified without the mutual written agreement of the Author and You.

(19) Tremolo

http://www.co.uk/jpinknoise/tremolo

Copyright (c) 2002-2003 Xiph.org Foundation Changes Copyright (C) 2009-2010 Robin Watts for Pinknoise Productions Ltd Redistribution and use in source and binary forms, with or without modification, are permitted provided that the following conditions are met:

- Redistributions of source code must retain the above copyright notice, this list of conditions and the following disclaimer.
- Redistributions in binary form must reproduce the above copyright notice, this list of conditions and the following disclaimer in the documentation and/or other materials provided with the distribution.
- Neither the name of the Xiph.org Foundation nor the names of its contributors may be used to endorse or promote products derived from this software without specific prior written permission.

THIS SOFTWARE IS PROVIDED BY THE COPYRIGHT HOLDERS AND CONTRIBUTORS "AS IS" AND ANY EXPRESS OR IMPLIED WARRANTIES, INCLUDING, BUT NOT LIMITED TO, THE IMPLIED WARRANTIES OF MERCHANTABILITY AND FITNESS FOR A PARTICULAR PURPOSE ARE DISCLAIMED. IN NO EVENT SHALL THE FOUNDATION OR CONTRIBUTORS BE LIABLE FOR ANY DIRECT, INDIRECT, INCIDENTAL, SPECIAL, EXEMPLARY, OR CONSEQUENTIAL DAMAGES INCLUDING, BUT NOT LIMITED TO, PROCUREMENT OF SUBSTITUTE GOODS OR SERVICES; LOSS OF USE, DATA, OR PROFITS; OR BUSINESS INTERRUPTION) HOWEVER CAUSED AND ON ANY THEORY OF LIABILITY, WHETHER IN CONTRACT, STRICT LIABILITY, OR TORT (INCLUDING NEGLIGENCE OR OTHERWISE) ARISING IN ANY WAY OUT OF THE USE OF THIS SOFTWARE, EVEN IF ADVISED OF THE POSSIBILITY OF SUCH DAMAGE.

(20) Tremor

http://wiki.xiph.org/index.php/Tremor

Copyright (c) 2002, Xiph.org Foundation

Redistribution and use in source and binary forms, with or without modification, are permitted provided that the following conditions are met:

- Redistributions of source code must retain the above copyright notice, this list of conditions and the following disclaimer.
- Redistributions in binary form must reproduce the above copyright notice, this list of conditions and the following disclaimer in the documentation and/or other materials provided with the distribution.
- Neither the name of the Xiph.org Foundation nor the names of its contributors may be used to endorse or promote products derived from this software without specific prior written permission.

THIS SOFTWARE IS PROVIDED BY THE COPYRIGHT HOLDERS AND CONTRIBUTORS "AS IS" AND ANY EXPRESS OR IMPLIED WARRANTIES, INCLUDING, BUT NOT LIMITED TO, THE IMPLIED WARRANTIES OF MERCHANTABILITY AND FITNESS FOR A PARTICULAR PURPOSE ARE DISCLAIMED. IN NO EVENT SHALL THE FOUNDATION OR CONTRIBUTORS BE LIABLE FOR ANY DIRECT, INDIRECT, INCIDENTAL, SPECIAL, EXEMPLARY, OR CONSEQUENTIAL DAMAGES INCLUDING, BUT NOT LIMITED TO, PROCUREMENT OF SUBSTITUTE GOODS OR SERVICES; LOSS OF USE, DATA, OR PROFITS; OR BUSINESS INTERRUPTION) HOWEVER CAUSED AND ON ANY THEORY OF LIABILITY, WHETHER IN CONTRACT, STRICT LIABILITY, OR TORT (INCLUDING NEGLIGENCE OR OTHERWISE) ARISING IN ANY WAY OUT OF THE USE OF THIS SOFTWARE, EVEN IF ADVISED OF THE POSSIBILITY OF SUCH DAMAGE.

(21) Mersenne Twister

http://www.math.sci.hiroshima-u.ac.jp/~m-mat/MT/2002/CODES/mt19937arc

Copyright (c) 1997 - 2002, Makoto Matsumoto and Takju Nishimura,

All rights reserved.

Redistribution and use in source and binary forms, with or without modification, are permitted provided that the following conditions are met:

- Redistributions of source code must retain the above copyright notice, this list of conditions and the following disclaimer.
- Redistributions in binary form must reproduce the above copyright notice, this list of conditions and the following disclaimer in the documentation and/or other materials provided with the distribution.

The names of its contributors may not be used to endorse or promote products derived from this software without specific prior written permission.

THIS SOFTWARE IS PROVIDED BY THE COPYRIGHT HOLDERS AND CONTRIBUTORS "AS IS" AND ANY EXPRESS OR IMPLIED WARRANTIES, INCLUDING, BUT NOT LIMITED TO, THE IMPLIED WARRANTIES OF MERCHANTABILITY AND FITNESS FOR A PARTICULAR PURPOSE ARE DISCLAIMED. IN NO EVENT SHALL THE COPYRIGHT OWNER OR CONTRIBUTORS BE LIABLE FOR ANY DIRECT, INDIRECT, INCIDENTAL, SPECIAL, EXEMPLARY, OR CONSEQUENTIAL DAMAGES INCLUDING, BUT NOT LIMITED TO, PROCUREMENT OF SUBSTITUTE GOODS OR SERVICES; LOSS OF USE, DATA, OR PROFITS; OR BUSINESS INTERRUPTION) HOWEVER CAUSED AND ON ANY THEORY OF LIABILITY, WHETHER IN CONTRACT, STRICT LIABILITY, OR TORT (INCLUDING NEGLIGENCE OR OTHERWISE) ARISING IN ANY WAY OUT OF THE USE OF THIS SOFTWARE, EVEN IF ADVISED OF THE POSSIBILITY OF SUCH DAMAGE.

http://ic.ari.haxx.se

COPYRIGHT AND PERMISSION NOTICE

Copyright (c) 1996 - 2011, Daniel Stenberg, <daniel@haxx.se>. All rights reserved.

Permission to use, copy, modify, and distribute this software for any purpose with or without fee is hereby granted, provided that the above copyright notice and this permission notice appear in all copies.

THE SOFTWARE IS PROVIDED "AS IS", WITHOUT WARRANTY OF ANY KIND, EXPRESS OR IMPLIED, INCLUDING BUT NOT LIMITED TO THE WARRANTIES OF MERCHANTABILITY, FITNESS FOR A PARTICULAR PURPOSE AND NON-INFRINGEMENT OF THIRD PARTY RIGHTS. IN NO EVENT SHALL THE COPYRIGHT HOLDER BE LIABLE FOR ANY CLAIM, DAMAGES OR OTHER LIABILITY, WHETHER IN AN ACTION OF CONTRACT, TORT OR OTHERWISE, ARISING FROM, OUT OF OR IN CONNECTION WITH THE SOFTWARE OR THE USE OR OTHER DEALINGS IN THE SOFTWARE.

Except as contained in this notice, the name of a copyright holder shall not be used in advertising or otherwise to promote the sale, use, or other dealings in this Software without prior written authorization of the copyright holder.

(22) c-ares

http://c-ares.haxx.se

Copyright 1998 by the Massachusetts Institute of Technology.

Permission to use, copy, modify, and distribute this software and its documentation for any purpose and without fee is hereby granted, provided that the above copyright notice appear in all copies and that both that copyright notice and this permission notice appear in supporting documentation, and that the name of M.I.T. not be used in advertising or publicity pertaining to distribution of the software without specific, written prior permission. M.I.T. makes no representations about the suitability of this software for any purpose. It is provided "as is" without express or implied warranty.

(24)Lz4

Copyright (c) 2011-2014, Yann Collet All rights reserved.

Redistribution and use in source and binary forms, with or without modification are permitted provided that the following conditions are met:

- Redistributions of source code must retain the above copyright notice, this list of conditions and the following disclaimer.
- Redistributions in binary form must reproduce the above copyright notice, this list of conditions and the following disclaimer in the documentation and/or other materials provided with the distribution.

THIS SOFTWARE IS PROVIDED BY THE COPYRIGHT HOLDERS AND CONTRIBUTORS "AS IS" AND ANY EXPRESS OR IMPLIED WARRANTIES, INCLUDING, BUT NOT LIMITED TO, THE IMPLIED WARRANTIES OF MERCHANTABILITY AND FITNESS FOR A PARTICULAR PURPOSE ARE DISCLAIMED. IN NO EVENT SHALL THE COPYRIGHT HOLDER OR CONTRIBUTORS BE LIABLE FOR ANY DIRECT, INDIRECT, INCIDENTAL, SPECIAL, EXEMPLARY, OR CONSEQUENTIAL DAMAGES INCLUDING, BUT NOT LIMITED TO, PROCUREMENT OF SUBSTITUTE GOODS OR SERVICES; LOSS OF USE, DATA, OR PROFITS; OR BUSINESS INTERRUPTION) HOWEVER CAUSED AND ON ANY THEORY OF LIABILITY, WHETHER IN CONTRACT, STRICT LIABILITY, OR TORT (INCLUDING NEGLIGENCE OR OTHERWISE) ARISING IN ANY WAY OUT OF THE USE OF THIS SOFTWARE, EVEN IF ADVISED OF THE POSSIBILITY OF SUCH DAMAGE.

# ONKYO

2-3-12 Yaesu, Chuo-ku, Tokyo 104-0028 JAPAN  
<http://www.onkyo.com/>

## <U.S.A.>

18 Park Way, Upper Saddle River, N.J. 07458, U.S.A.  
For Dealer, Service, Order and all other Business Inquiries:  
Tel: 201-785-2600 Fax: 201-785-2650  
<http://www.us.onkyo.com/>

For Product Support Team Only:  
1-800-229-1687  
<http://www.us.onkyo.com/>

## <Germany>

Gutenbergstrasse 3, 82178 Puchheim, Germany  
Tel: +49-8142-4401-0 Fax: +49-8142-4208-213  
<http://www.eu.onkyo.com/>

## <UK>

Anteros Building, Odyssey Business Park, West End Road, South Ruislip, Middlesex, HA4 6QQ United Kingdom  
Tel: +44 (0)871-200-1996 Fax: +44 (0)871-200-1995

## <Hong Kong>

Unit 1033, 10/F, Star House, No 3, Salisbury Road, Tsim Sha Tsui Kowloon, Hong Kong.  
Tel: +852-2429-3118 Fax: +852-2428-9039  
<http://www.hk.onkyo.com/>

## <PRC>

302, Building 1, 20 North Chaling Rd., Xuhui District, Shanghai, China 200032,  
Tel: +86-21-52131366 Fax: +86-21-52130396  
<http://www.cn.onkyo.com/>

## <Asia, Oceania, Middle East, Africa>

Please contact an Onkyo distributor referring to Onkyo SUPPORT site.  
<http://www.intl.onkyo.com/support/>

Корпорация Онкьо энд Пи  
2-3-12, Яэсу, Чуо-ку, г. Токио, 104-0028, ЯПОНИЯ

The above-mentioned information is subject to change without prior notice.  
Visit the Onkyo web site for the latest update.

(C) Copyright 2015 Onkyo & Pioneer Corporation Japan. All rights reserved.  
Printed in Malaysia / Imprimé en Malaisie / Напечатано в Малайзии

SN 29402067A

F1510-1



\* 2 9 4 0 2 0 6 7 A \*