



## Introduction to Building Codes

- Codes are minimum requirements to safeguard the public health, safety and welfare of the public and occupants or users of spaces or buildings.



## ICC Code Development Cycle

- New code published every 3 years
- 12 month cycle
- Codes divided into 3 groups
  - IBC, IPC, IMC, IFGC, IPSDC
  - IRC, IFC, IEBC, IECC, IPMC, ISPSC, IWUIC, IZC, ICCPC, Admin.
  - IgCC

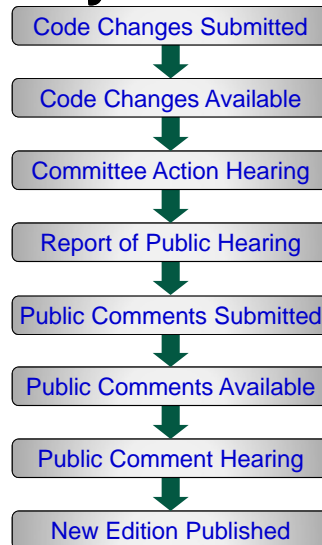

# IRC – International Residential Code

- Regulates of 1- and 2-family dwellings and townhouse structures
- Combines all regulations for building, energy, mechanical, fuel gas, plumbing and electrical into one document



Single-family dwelling



Townhouses



2015 IRC Essentials

Workbook Page 7

5

# Dwellings and Townhouses

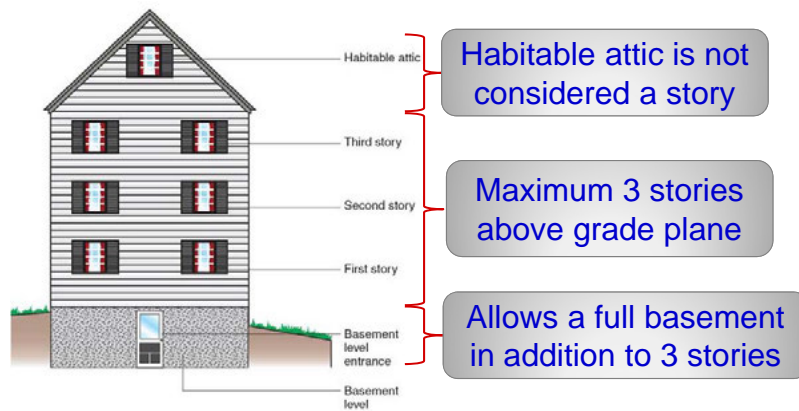

2015 IRC Essentials

Workbook Page 8

6

# Dwellings

- Separate means of egress to the outdoors for each dwelling unit
  - 1 exterior exit door
  - Egress travel distance is not regulated
- No limit on size of dwellings
- 2-family dwellings require fire-resistant separations



# Townhouses

- Minimum of 3 townhouses
- No maximum on the number of townhouses
- Fire-resistant separations between townhouses
- Townhouses open on front and back

Units are not open on 2 sides; cannot be constructed under the IRC

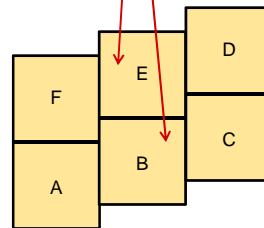
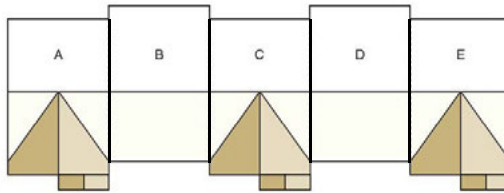

## Accessory Buildings

- The IRC regulates accessory buildings
  - Use incidental and accessory to dwelling
  - On same lot as dwelling
  - Unlimited area
  - ≤ 3 stories AGP



## Existing Buildings

- Existing buildings permitted to continue without change
  - Maintained per code under which they were constructed
- The IRC regulates additions, alterations and repairs to an existing building
- Appendix J offers compliance alternatives for construction on existing buildings
  - Work categorized as repair, renovation, alteration or reconstruction



## Adoption of the IRC

- Adopting by local ordinance includes:
  - Edition and title of the IRC
  - Purpose and scope
  - Effective date for ordinance
  - Insertion of local information and criteria into code text:
    - Name of the jurisdiction
    - Design criteria
    - Building sewer depths



## Appendices

- Developed in the same manner as the main body of code
- May provide some guidelines or examples of recommended practices
- May assist in the determination of alternative materials or methods
- Have no legal status until specifically recognized in the adopted ordinance or legislation



## Building Official Authority and Duties

- Building Official is authorized and directed to:
  - Enforce provisions of code
  - Make interpretations
  - Adopt policies and procedures
  - Approve modifications and alternatives
- Limits on authority:
  - Not authorized to waive code requirements
  - Not authorized to require more than the code

Within  
 intent and  
 purpose of  
 code



## Alternative Methods and Materials

- The IRC does not exclude any material or method
- Alternatives subject to approval by the Building Official
- The Building Official has an obligation to approve alternatives that meet the intent of the IRC
  - Reports issued by the ICC Evaluation Service (ICC-ES) are valuable resources in verifying performance equal to the code requirements
  - [www.icc-es.org](http://www.icc-es.org)
- Reason for disapproval in writing



## Permits

- Construction requires a permit before work begins
- Exempt work:
  - 1-story tool and storage sheds, playhouses, and similar uses  $\leq 200$  ft<sup>2</sup>
  - Decks
    - $\leq 200$  ft<sup>2</sup>
    - $\leq 30$  in. above grade
    - not attached to a dwelling **and**
    - do not serve the required exit door
  - Fences  $\leq 7$  ft. in height



## Fees

- The jurisdiction may charge permit fees to offset the costs of providing associated services to the public
  - Administration costs
  - Plan review costs
  - Inspection costs
- The Building Official develops equitable and consistent procedures for establishing fees





## Required Inspections

- Foundation
- Floodplain
- Plumbing, mechanical, gas and electrical systems
- Frame and masonry
- Fire-resistance-rated construction
- Other inspections as deemed necessary
- Final inspection



## Board of Appeals

- The public has the right of due process to appeal an order, decision or determination of the building official.
- Basis for appeal:
  - The code has been interpreted incorrectly
  - The code does not apply
  - An equivalent alternative was not accepted
- The Board of Appeals has no authority to waive code requirements





Part II

# Site Development

19

## Fire Separation Distance

- Measured perpendicular to the exterior wall
- Measured between the building and:
  - Lot lines
  - Centerline of a street or alley

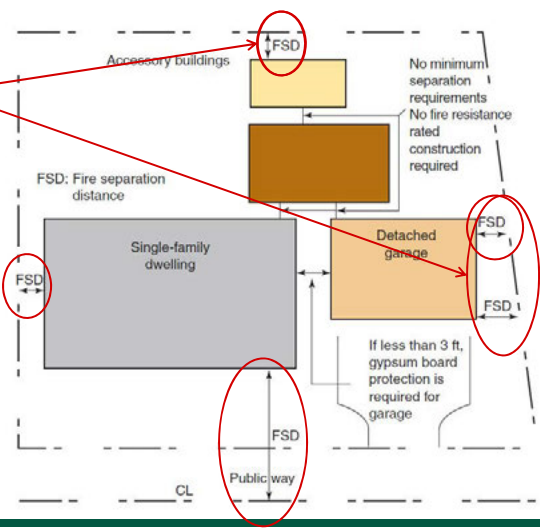

2015 IRC Essentials Workbook Page 29-30 20

## Site Preparation

- Two basic provisions:
  - Soil characteristics as they relate to the support and stability of foundations
  - Grading to provide surface drainage away from foundations



## General Requirements

- Exterior footings
  - Minimum of 12" below the undisturbed ground level
  - Protected against frost
- All footings must bear on:
  - Natural soil; or
  - Compacted engineered fill



## Presumptive Load-bearing Values & Properties of Soils

Unified Soil Classification System Symbol	Soil Description	Load Bearing Pressure (psf)	Drainage Characteristics	Frost Heave Potential	Volume Change Potential Expansion
GW	Well-graded gravels, gravel sand mixtures, little or no fines	3000	Good	Low	Low
GP	Poorly graded gravels or gravel sand mixtures, little or no fines	3000	Good	Low	Low
SW	Well-graded sands, gravelly sands, little or no fines	2000	Good	Low	Low
SP	Poorly graded sands or gravelly sands, little or no fines	2000	Good	Low	Low
GM	Silty gravels, gravel-sand-silt mixtures	2000	Good	Medium	Low
SM	Silty sand, sand-silt mixtures	2000	Good	Medium	Low
GC	Clayey gravels, gravel-sand-clay mixtures	2000	Medium	Medium	Low
SC	Clayey sands, sand-clay mixture	2000	Medium	Medium	Low
ML	Inorganic silts and very fine sands, rock flour, silty or clayey fine sands or clayey silts with slight plasticity	1500	Medium	High	Low
CL	Inorganic clays of low to medium plasticity, gravelly clays, sandy clays, silty clays, lean clays	1500	Medium	Medium	Medium to Low
CH	Inorganic clays of high plasticity, fat clays	1500	Poor	Medium	High
MH	Inorganic silts, micaceous or diatomaceous fine sandy or silty soils, elastic silts	1500	Poor	High	High



## Fill

- Engineered fill is required for:
  - Over-excavation to remove unsuitable soils
  - Additional material to raise the elevation of the footings above the existing undisturbed soil
  
- Engineered fill must be:
  - Designed by a registered design professional
  - Installed as specified in design requirements
  - Tested as specified in design requirements



# Storm Drainage

- Final grade
  - Minimum fall 6" within 10' of foundation
  - Exception for local site conditions
    - Water can be directed to swales or drains
  - Concrete surfaces within 10' of the foundation need 2% slope



# Storm Drainage

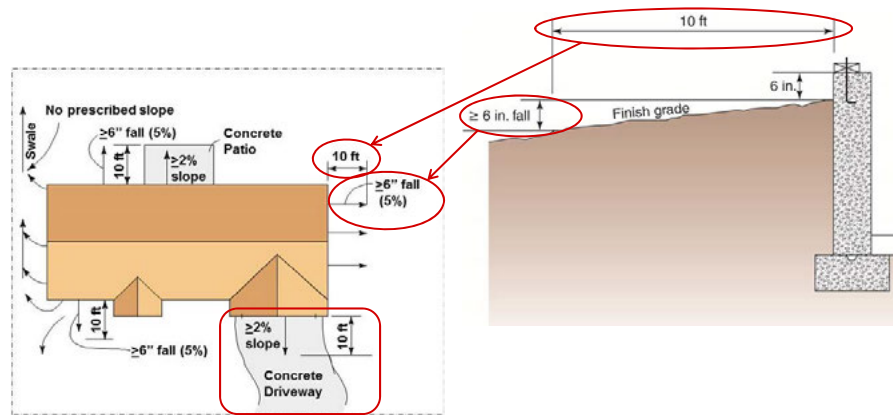



Part III

# Structural

27

## Table R301.2(1) Climatic and Geographic Design Criteria

- IRC adoption: jurisdiction completes table with data applicable to the jurisdiction – for example:

Ground Snow Load	Wind Design			Seismic Design Category	
	Speed (mph) $V_{ult}$	Topographic Effects	Special Wind Region		Wind-borne Debris Zone
30 psf	115 mph	Yes or No	Yes or No	Identify or No	B



## Table R301.2(1) (Continued) Climatic and Geographic Design Criteria

- IRC adoption: jurisdiction completes table with data applicable to the jurisdiction – for example:

Subject to Damage from			Ice Barrier Underlayment Required
Weathering	Frost Line Depth	Termite	
Negligible or Moderate or Severe	42 in.	Yes or No	Yes or No



## Table R301.2(1) (Continued) Climatic and Geographic Design Criteria

Winter Design Temp	Flood Hazards	Air Freezing Index	Mean Annual Temp
2° F	Date NFIP, Etc.	1197	51° F



# Prescriptive and Performance

- Prescriptive requirements
  - A specific set of rules to follow
  
- Performance requirements
  - Expectation that the system will function in a certain way
  - For structural requirements, performance is achieved through engineering



# Prescriptive and Performance

- Conventional construction
  - Engineered design can be used for structural elements that:
    - Exceed the limits in the code; or
    - Are not included in the code
  
- Alternative to wood framing provisions
  - Wood Frame Construction Manual published by the American Wood Council
    - WFCM addresses wind speeds up to 150 mph
    - IRC wind speeds are less than 110 mph



For example, the sizing of wide flange steel beams





# Live Loads

## IRC Table R301.5

### Minimum Uniformly Distributed Live Loads

USE	LIVE LOAD (psf)
Uninhabitable attics without storage	10
Uninhabitable attics with limited storage	20
Habitable attics and attics served with fixed stairs	30
Balconies (exterior) and decks	40
Fire escapes	40
Rooms other than sleeping rooms	40
Sleeping rooms	30



# Live Loads (Continued)

## IRC Table R301.5

### Minimum Uniformly Distributed Live Loads

USE	LIVE LOAD (psf)	
Guardrails and handrails	200	Single concentrated load applied in any direction along the top.
Guardrail in-fill components	50	Horizontally applied normal load of 50 lb. on area of 1 sq. ft.
Passenger vehicle garages	50	2,000-lb concentrated load / 20-sq. in. area.
Stairs	40	300-lb concentrated load / 4 sq. in. of tread



# Dead Loads

- Average dead loads are included in the prescriptive tables for:
  - Footings
  - Floors
  - Walls
  - Roofs

For example, spread footing sizes for conventional frame construction assume average weights for the construction materials being supported



# Deflection

- Allowable deflection in structural framing members:

- Studs
- Joists
- Beams
- Rafters
- Table R301.7
  - L = span length
  - H = span height

Structural Member	Allowable Deflection
Rafters having slopes greater than 3:12 with no finished ceiling attached to rafters	L/180
Interior walls and partitions	H/180
Floors/ceilings with plaster or stucco finish	L/360
All other structural members	L/240
Exterior walls—wind loads with plaster or stucco finish	H/360
Exterior walls with other brittle finishes	H/240
Exterior walls with flexible finishes	H/120
Lintels supporting masonry veneer walls	L/600



**FOR EXAMPLE**

## Example 4-1 Floor Joist Deflection

- Floor joist span is 14'
- Allowable deflection from Table R301.7 is L/360
  - $L = 14' \times 12'' = 168''$
  - $168 \div 360 = 0.47$
  - Allowable deflection is 0.47"



**Note:** a 14' span rafter with 4:12 slope and no ceiling attached has an allowable deflection of L/180, which is twice the deflection allowed for floor joists



2015 IRC Essentials      Workbook Page 43      37

## Wind Loads

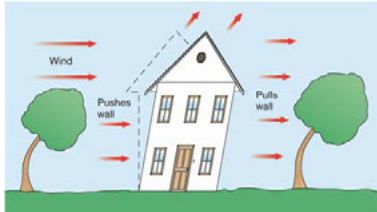
- Wind forces acting on buildings
  - IRC conventional framing limits wind speed to 140 mph  $V_{ult}$  (130 in hurricane prone areas)
  - AWC – *Wood Framing Construction Manual* (WFCM)
  - ICC 600 – *Standard for Residential Construction in High-Wind Regions*
  - ICC – *International Building Code*
  - ASCE 7 – *Minimum Design Loads for Buildings and Other Structures*

2015 IRC Essentials      Workbook Page 44      38

## Wind Exposure Category

- Exposure B
  - Some wind protection with trees and buildings
  - Default
- Exposure C
  - Open terrain with scattered obstructions
- Exposure D
  - Flat, unobstructed areas exposed to open water, smooth mud flats, salt flats and unbroken ice for  $\geq 5,000$  ft



Wind exposure B



Wind exposure C



## Hurricane-prone regions

- **Hurricane-prone regions.** Areas vulnerable to hurricanes, defined as the U.S. Atlantic Ocean and Gulf of Mexico coasts where the ultimate design wind speed,  $V_{ult}$ , is greater than 115 miles per hour, and Hawaii, Puerto Rico, Guam, Virgin Islands and America Samoa.
- **Windborne debris region.** Areas within hurricane-prone regions located in accordance with one of the following:
  - 1. Within 1 mile of the coastal mean high water line where the ultimate design wind speed,  $V_{ult}$ , is 130 mph or greater.
  - 2. In areas where the ultimate design wind speed,  $V_{ult}$ , is 140 mph or greater; or Hawaii.



## Snow Loads

- Snow loads must be considered where applicable
- IRC and WFCM conventional framing tables are limited to snow load <70 psf



## Earthquakes

- The IRC assigns a Seismic Design Category to building sites relative to the anticipated intensity and frequency of earthquakes
- Prescriptive provisions of the IRC are adequate for SDC A and B

Seismic Design Category	1- and 2-Family Dwellings	Townhouses
A & B	No seismic requirements	No seismic requirements
C	No seismic requirements	Seismic Requirements Apply
D <sub>0</sub> , D <sub>1</sub> , D <sub>2</sub>	Seismic Requirements Apply	
E	Engineered Design Required	



# Earthquakes

- Regularly shaped buildings
  - Uniform distribution of forces
  - More predictable response characteristics
- Irregularly shaped buildings
  - Force concentrations
  - Generally less effective in resisting earthquake load effects

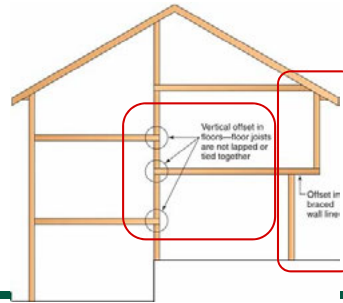
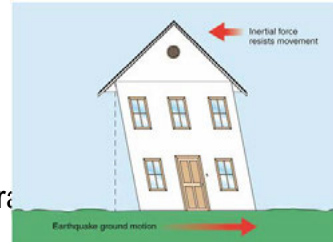

# Foundation Materials

- Concrete
  - Removable forms
  - Stay-in-place insulating concrete forms (ICF)
- Precast concrete
- Masonry
- Wood
- Engineered or alternative designs



# Footings

- Footings must bear on undisturbed ground
- Footings must extend below the frost depth
- Exterior footings 12" below undisturbed ground level
- Detrimental materials removed prior to placing concrete

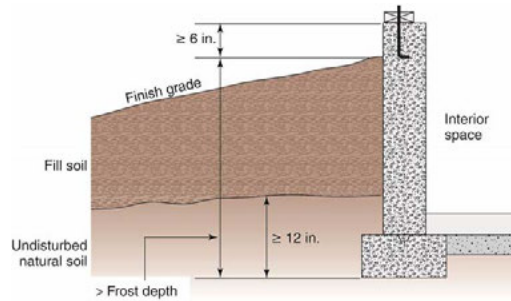

# Size of Concrete Footings

Conventional Light-Frame Construction				
Snow load	Type of foundation	Load bearing value of soil		
30 psf		1,500	2,000	2,500
1-story	Slab-on-grade	12 x 6	12 x 6	12 x 6
	With crawl space	13 x 6	12 x 6	12 x 6
	Plus basement	19 x 6	14 x 6	12 x 6
2-story	Slab-on-grade	12 x 6	12 x 6	12 x 6
	With crawl space	17 x 6	13 x 6	12 x 6
	Plus basement	23 x 6	17 x 6	14 x 6

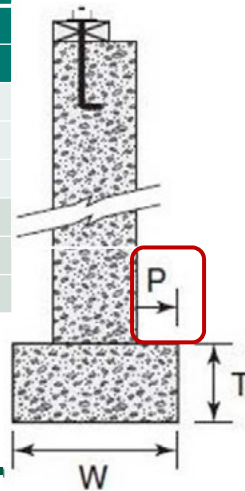

Projection "P" ≥ 2 in. and ≤ T

Thickness "T" ≥ 6 in.

Width "W" per table



**FOR EXAMPLE**

## Example 5-1 Footing Size

- Determine minimum width (W), projection (P) and thickness (T) of a continuous spread footing
- Given:
  - 2-story dwelling with basement
  - 1500 psf assumed soil bearing capacity
  - 30 psf snow load
  - Conventional construction:
    - a) Light-frame construction with siding
    - b) Light-frame construction with brick veneer

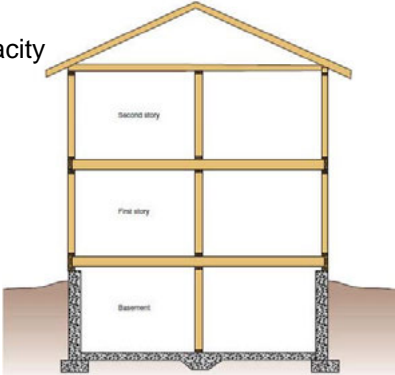

The diagram shows a cross-section of a 2-story dwelling with a basement. The structure is supported by a continuous spread footing. The footing is shown with a width (W), projection (P), and thickness (T). The structure is labeled with 'Second story', 'First story', and 'Basement'.

2015 IRC Essentials Workbook Page 57 47

**FOR EXAMPLE**

## Example 5-1 Footing Size

Snow load	Type of foundation	Load bearing value of soil
30 psf		1,500
<b>Conventional Light-Frame Construction</b>		
2-story	Plus basement	23 x 6
<b>With Brick Veneer</b>		
2-story	Plus basement	27 x 9

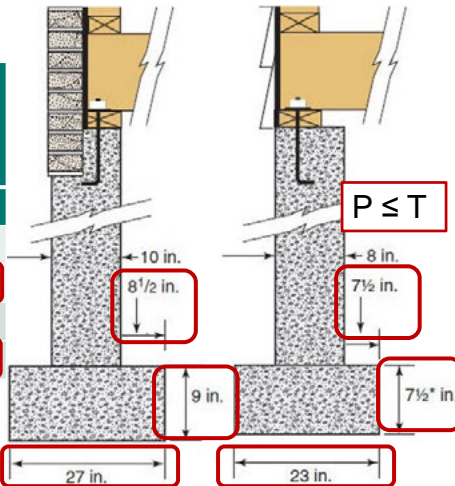

The diagram shows two cross-sections of a footing. The left section is for light-frame construction with siding, showing a footing width of 27 in., a projection of 10 in., and a thickness of 8 1/2 in. The right section is for light-frame construction with brick veneer, showing a footing width of 23 in., a projection of 8 in., and a thickness of 7 1/2 in. A box labeled  $P \leq T$  is shown next to the brick veneer footing.

2015 IRC Essentials Workbook Page 57 48



**FOR EXAMPLE**

## Example 5-2 Isolated Footing Size

- Given:
  - Column supports tributary floor area of 120 ft<sup>2</sup> at 50 psf
  - 1,500 psf assumed soil-bearing capacity
- Determine minimum footing size

Simple tributary load transferred to column and footing  
Excludes roof, wall, or second-floor loads

Floor joists

Footing

Column

Beam

Tributary area = 10 ft x 12 ft = 120 sq. ft.

2015 IRC Essentials Workbook Page 59 49

**FOR EXAMPLE**

## Example 5-2 Isolated Footing Size

- Soil load-bearing capacity
  - 1500 psf
- Tributary column load
  - 120 ft<sup>2</sup> x 50 lbs. = 6,000 lbs.

$6,000 \text{ lbs.} \div 1,500 \text{ psf} = 4 \text{ ft}^2$

- Thickness (T) Min. 6"
- Projection (P) cannot exceed footing thickness

24 in.

24 in.

Plan view

3 in. diameter pipe column

10 1/2 in.

10 1/2 in.

P = Projection

T = Thickness

W = Width

24 in.

Section view

Assumed soil bearing 1,500 PSF

2015 IRC Essentials Workbook Page 60 50

# Foundation Anchorage

- Anchor bolts
  - 1/2-inch diameter
  - 7-inch embedment
  - Middle 1/3 of plate

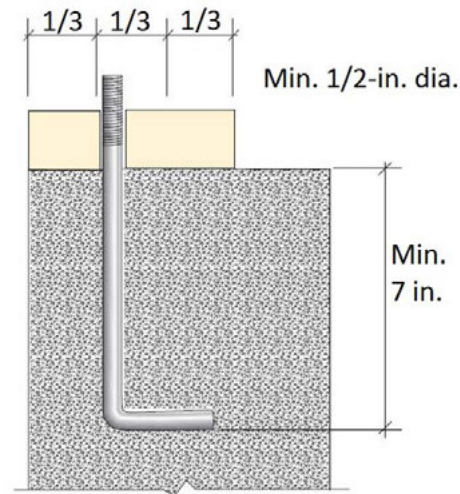
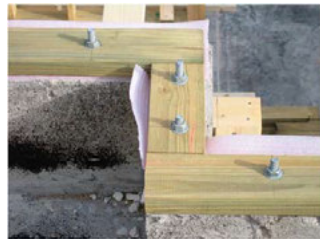

# Foundation Anchorage

- Wood sill plate anchorage to foundation for
  - Dwellings and townhouses in SDC "A" and "B"
  - Dwellings in SDC "C"

Standard washer and nut on each bolt

Note: Offsets  $\leq 24"$  require only one anchor bolt in center third of plate

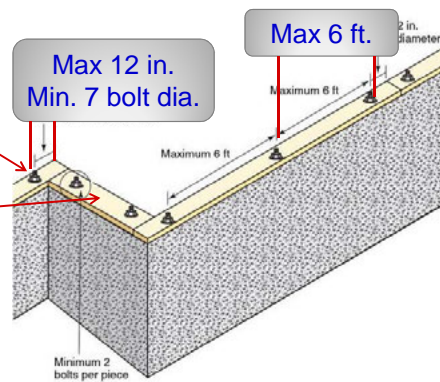

# Foundation Anchorage

- Wood sill plate anchorage Seismic
  - Dwellings and townhouses in SDC D<sub>0</sub>, D<sub>1</sub> and D<sub>2</sub>
  - Townhouses in SDC C

3" x 3" plate washers approximately 1/4" thick

Bolt spacing ≤ 4' for anchorage of 3-story buildings

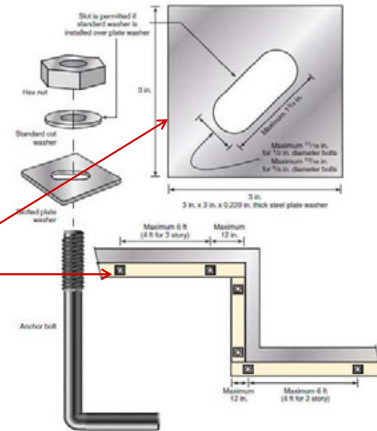

# Concrete Foundation Walls

- Foundation walls must be constructed to resist lateral loads
- Thickness and vertical reinforcement determined by:
  - Soil type
  - Height of foundation
  - Height of unbalanced backfill
    - Difference in height between the exterior finish ground level and the top of the interior basement floor

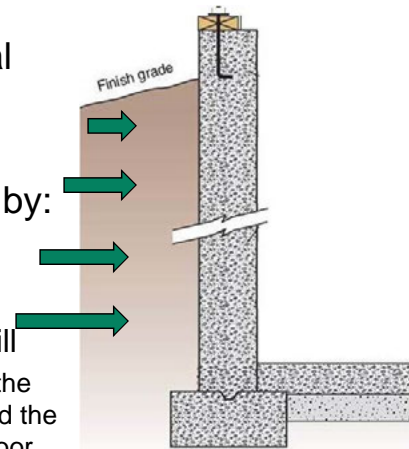

# Concrete Foundation Walls

- Horizontal reinforcing required for basement walls
  - Table R404.1.2(1)

Maximum Unsupported Height of Basement Wall	Location of Horizontal Reinforcement
≤8 feet	One No. 4 bar within 12" of the top of the wall and one No. 4 bar near mid-height of the wall story
>8 feet	One No. 4 bar within 12" of the top of the wall and one No. 4 bar near third points the wall story

- Vertical reinforcing required
  - Tables R404.1.2(2) through R404.1.2(9)



## Horizontal Reinforcing in Concrete Basement Wall

- Table R404.1.2(1)
  - 3 horizontal No. 4 bars
  - One bar within 12" of top
  - Other bars at third points
  - Bars located in center of wall

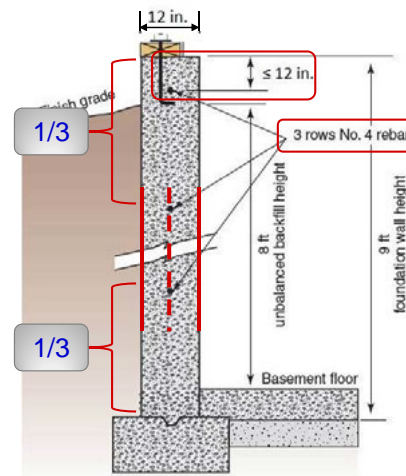

**FOR EXAMPLE**

## Vertical Reinforcing in Concrete Basement Wall

- Soil class = CL inorganic sandy clay
- 10" nominal thickness
- Wall height = 9'
- Unbalanced backfill height = 8'
- Table R404.1.2(8) Vertical Reinforcement
  - No. 6 bars at 39 inches on center

Wall Hgt.	Unbal. backfill	Soil class			
		6"	8"	10"	12"
		SC, ML-CL and inorganic CL			
		6 @ 36	6 @ 39	NR	NR
9	7	6 @ 33	6 @ 38	5 @ 37	NR
	8	6 @ 24	6 @ 29	6 @ 39	4 @ 48

2015 IRC Essentials Workbook Page 69 57

## Height Above Finished Grade

- Concrete and masonry foundation walls must extend above the finished grade adjacent to the foundation
  - Minimum of 4" with masonry veneer
  - Minimum of 6" elsewhere

2015 IRC Essentials Workbook Page 70 58

# Moisture Protection

- Drainage by perforated pipe or other approved drain system
  - Installed at or below the level of the basement or crawl space floor
  - Exception for areas with well-drained soils
- Dampproofing materials applied to the exterior of the foundation
- Waterproofing in areas with a high water table or other known severe soil-water conditions
  - Flexible sealants or other impervious material

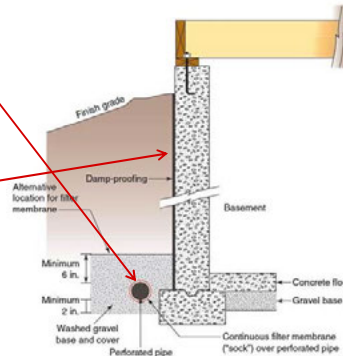

# Underfloor Space

- Ventilation of crawl space required
  - Circulate air
  - Dissipate condensation
- Method of ventilation
  - Foundation openings
  - Mechanical exhaust ventilation
  - Connection to the conditioned air supply of the dwelling
- Access to underfloor spaces
  - 18" x 24" through floor
  - 16" x 24" through perimeter wall

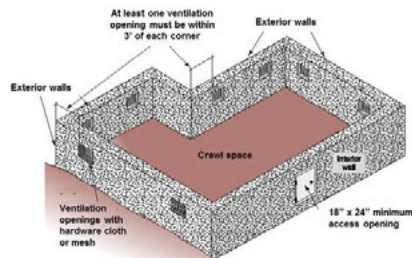

# Framing

- Light-frame construction
  - Wood or cold-formed steel
- Grade mark on wood products
  - Wood structural panels
  - Load-bearing dimension lumber



# Engineered Wood Products

- Plate-connected open web trusses
- I-joists
- Glued-laminated lumber
- Laminated veneer lumber (LVL)
- Other structural composite lumber (SCL)



# Wood Trusses

- Design submitted to building official for approval
- Include:
  - Design loads
  - Slope or depth, span and spacing
  - Required bearing widths
  - Lumber size, species and grade
  - Connection requirements
  - Required permanent bracing location
  - Other information

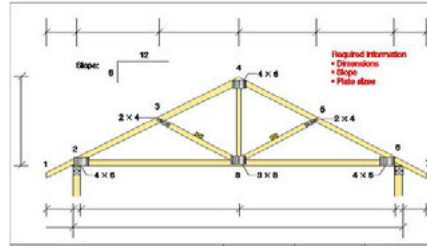

# Wood Treatment

- Wood in locations subject to decay requires:
  - Wood treated with preservatives; or
  - Naturally durable wood
    - Redwood
    - Cedar
    - Black locust
    - Black walnut

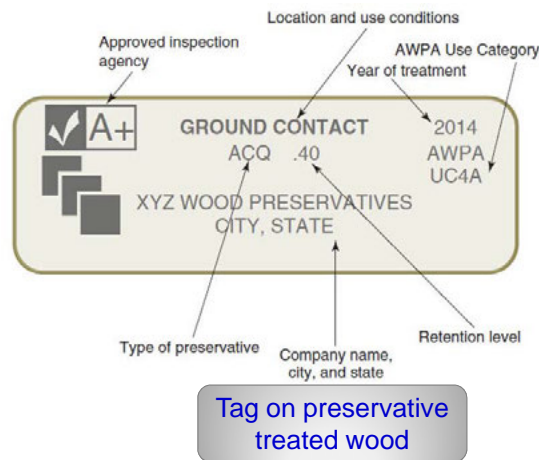



## Protection Against Decay

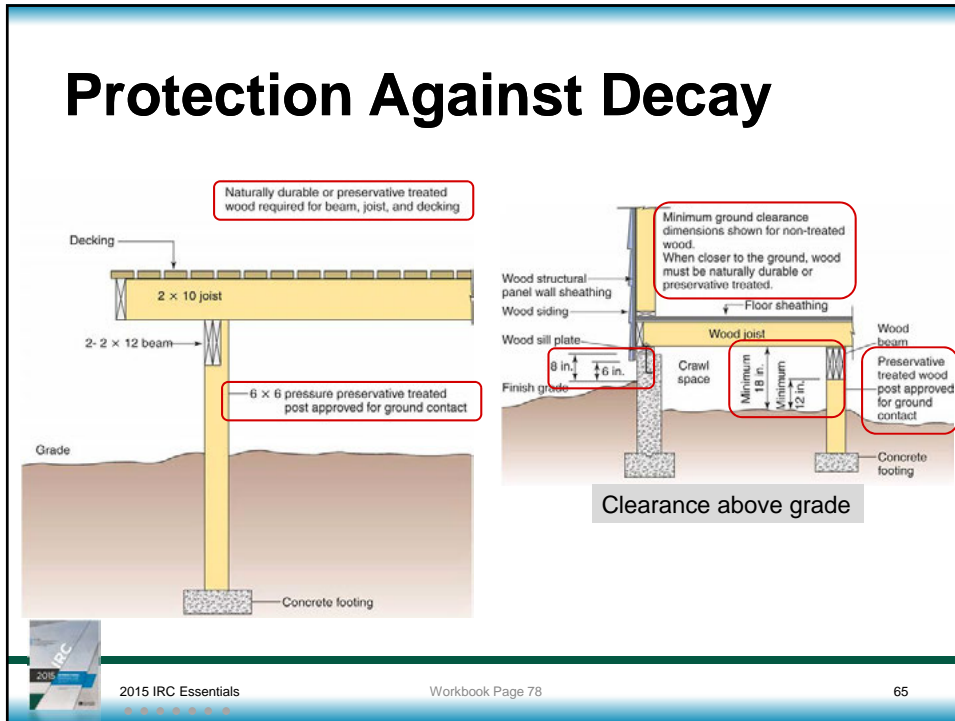

## Boring and Notching Floor and Ceiling Joists

- Boring holes and notching of solid sawn beams, floor joists and ceiling joists

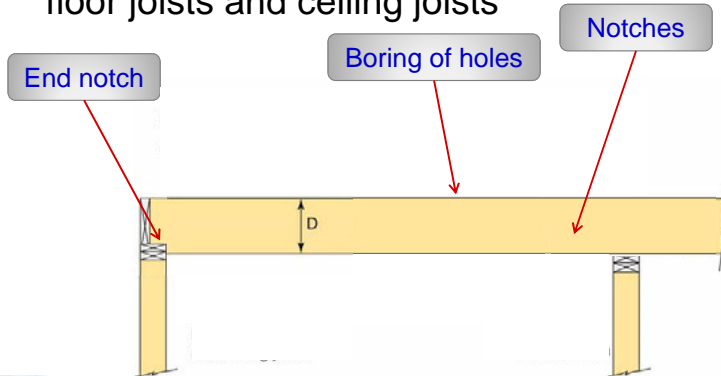

## Boring and Notching Bearing Walls

Notch  
25% of stud  
depth maximum  
Bored holes in single studs  
Maximum diameter 40% of stud depth  
Maximum diameter 60% of stud depth  
Studs must be doubled  
No more than two successive doubled studs so bored  
5/8 in. minimum  
from edge of stud

2015 IRC Essentials
Workbook Page 79
67

## Boring and Notching Nonbearing Walls

Hole size in 2' x 4' stud  
 Stud depth = 3½"  
 Largest hole ≤60%  
 60% x 3½" = 2⅛"  
 5/8" + 2⅛" + 5/8" = 3⅜"

Bored holes may not be in the  
same cross section as notches  
Minimum  
5/8 in. from  
edge of stud  
Notch  
40% of stud  
depth maximum  
Maximum diameter of  
bored holes is 60% of  
stud depth

2015 IRC Essentials
Workbook Page 79
68

## Boring and Notching Top Plate of Bearing Wall

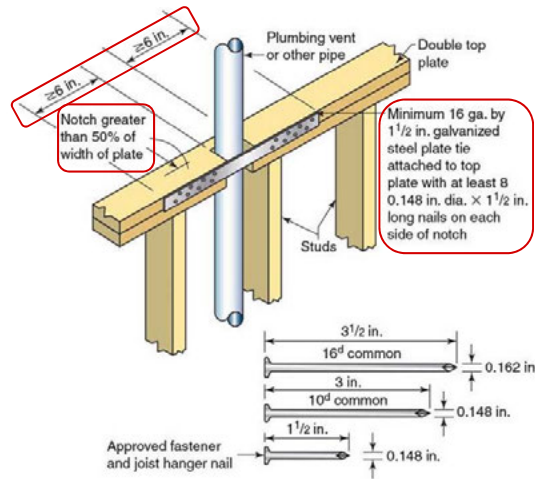

2015 IRC Essentials

Workbook Page 80

69

## Fireblocking

- Designed to stop the spread of fire in concealed spaces of wood frame construction

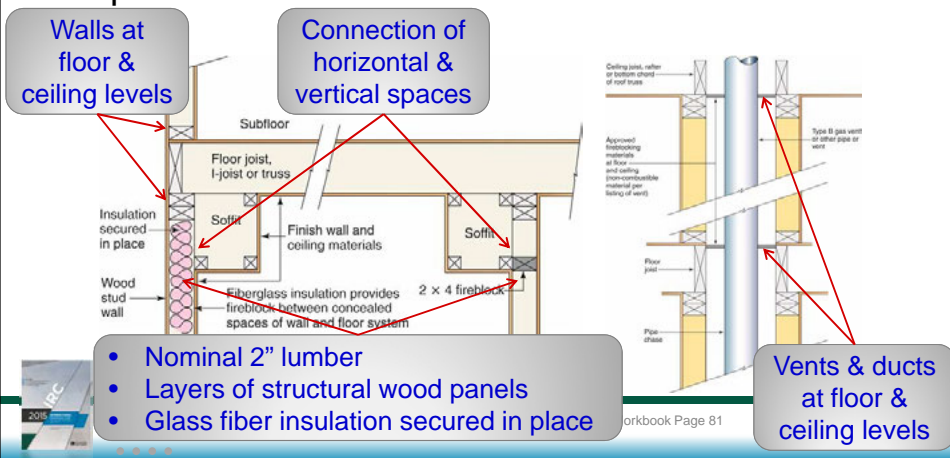

Workbook Page 81

## Draftstopping

- Divide concealed floor assembly spaces into areas of <math><1000\text{ ft}^2</math>
- Materials:
  - 1/2" gypsum board
  - 3/8" wood structural panels
  - Other approved materials



2015 IRC Essentials

Workbook Page 82

71

## Wood Floor Framing

- Prescriptive tables for:
  - Beams and girders
    - No. 2 grade Douglas fir-larch, hem-fir, southern pine and spruce-pine-fir
    - Various support conditions
  - Floor joists
    - Specific grade and species of lumber
    - Live load 30 or 40 psf
    - Dead load 10 or 20 psf



2015 IRC Essentials

Workbook Page 83

72

**FOR EXAMPLE**

### Example 6-1 Beam Size and Bearing Support

- Determine the minimum size and bearing support requirements for an interior beam supporting 2 floors
- #2 hem-fir lumber
- Building width = 28'
- Beam span = 6'

Girder supporting	Size	Building width		
Two floors		20	28	36
		Span	Span	Span
	3-2x10	6-2	5-4	4-10
	3-2x12	7-2	6-3	5-7
	4-2x8	6-1	5-3	4-8
	4-2x10	7-2	6-2	5-6

**Table R602.7(2)**

- Three 2 x 12
- or
- Four 2 x 10

2015 IRC Essentials  
Workbook Page 82  
73

**FOR EXAMPLE**

### Example 6-2 Joist Size and Spacing

- Living area = 40 psf LL
- #2 Douglas fir-larch
- Dead load = 10 psf
- Span = 14'

**Table R502.3.1(2)**

Joist Spacing	Joist Size	Span
12" O.C.	2 x 8	14 - 2
16" O.C.	2 x 10	15 - 7
19.2" O.C.	2 x 10	14 - 3
24" O.C.	2 x 12	14 - 9

Workbook Page 83

## Fastener Schedule for Floor Framing

- IRC Table R602.3(1)  
Fastener Schedule for Structural Members
- Common nails

Description	Nails	Spacing
Rim joist to plate, toe nail	8d	6" O.C.
Joist to sill or girder, toe nail	3 - 8d	—
Joists lapped at bearing support, face nail	3 - 10d	IRC Section R502.6.1
Built-up girders and beams	10d	24" O.C. at top and bottom and staggered. Three nails at ends and at each splice.



2015 IRC Essentials

Workbook Page 84

75

## Deck Attachment

- Deck ledger connection to:
  - 2" band joist; or
  - 1 x 9½ Douglas Fir LVL rim board
- Fasteners
  - ≥½" diameter lag screws or bolts with washers
  - Hot-dipped galvanized or stainless steel
  - Lag screws full-depth through rim joist
  - Fasteners staggered along length of ledger

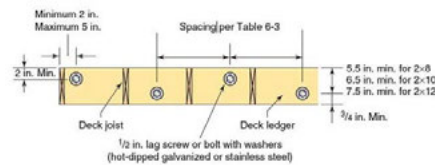
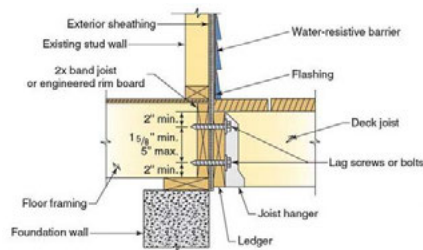

2015 IRC Essentials

Workbook Page 89

76

## Deck Joists and Beams

- Prescriptive methods for joists and beams in deck construction.
  - Spans & bearing requirements

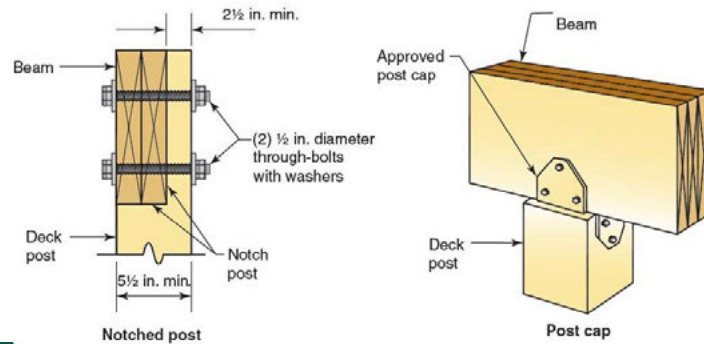

2015 IRC Essentials

77

## Wall Framing

- Size and spacing of studs is related to:
  - Number of floors being supported
  - With or without the additional load of the roof-ceiling assembly

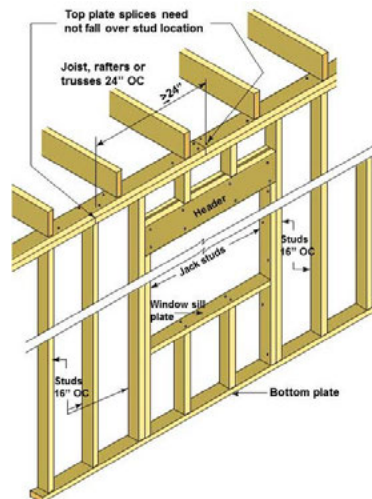

2015 IRC Essentials

Workbook Page 90

78

**FOR EXAMPLE**

## Example 6-3 Stud Size and Spacing

- Determine the minimum size, maximum height and maximum spacing of standard studs in an exterior bearing wall
- Given:
  - 3 stories of wood framing (walk-out basement plus 2 stories)
  - Standard- or stud-grade lumber



2015 IRC Essentials      Workbook Page 92      79

**FOR EXAMPLE**

## Example 6-3 Stud Size and Spacing

- Table R602.3(5)

Stud Size (inches)	Bearing Walls					Nonbearing Walls	
	Laterally Unsupported Stud Height (feet)	Maximum Spacing When Supporting a Roof/Ceiling Assembly or a Habitable Attic Assembly Only	Maximum Spacing When Supporting One Floor Plus a Roof/Ceiling Assembly or a Habitable Attic Assembly	Maximum Spacing When Supporting Two Floors Plus a Roof/Ceiling Assembly or a Habitable Attic Assembly	Maximum Spacing When Supporting One Floor Only	Laterally Unsupported Stud Height	Maximum Spacing
2 x 3	--	--	--	--	--	10'	16"
2 x 4	10 ft	24"	16"	--	24"	14'	24"
3 x 4	10 ft	24"	24"	16"	24"	14'	24"
2 x 5	10 ft	24"	24"	--	24"	16'	24"
2 x 6	10 ft	24"	24"	16"	24"	20'	24"

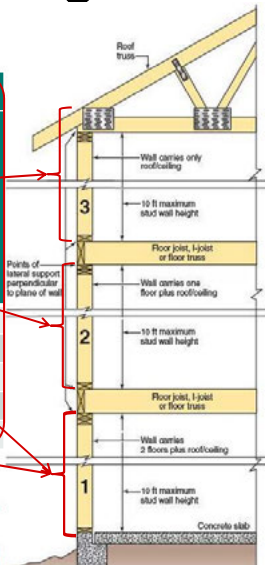

Stud height in bearing walls is generally limited to 10'



2015 IRC Essentials      Workbook Page 92



**FOR EXAMPLE**

## Example 6-4 Header Size in Exterior Walls

- Given:
  - Ground snow load = 30 psf
  - Clear span roof truss
  - Center bearing floor framing
  - Building width = 28'
  - Header span = 7'
  - #2 Douglas fir-larch

2015 IRC Essentials Workbook Page 95 81

## Example 6-4 Header Size in Exterior Walls

**Table R602.7.1**

Ground snow load = 30 psf Building width = 28 feet			
Supporting	Size	Span	Jack studs
Roof & Ceiling	2-2x10	7-3	2
	2-2x12	8-5	2
Roof, ceiling, one center-bearing floor	2-2x10	6-2	2
	2-2x12	7-1	2
Roof, ceiling, two center-bearing floors	3-2x10	6-4	2
	3-2x12	7-4	2

2015 IRC Essentials Workbook Page 95 82

# Wall Bracing

- Wall bracing provides resistance to racking from lateral loads, primarily wind and seismic forces
- Amount and location of bracing is determined by several factors:
  - Number of stories
  - Seismic design category
  - Design wind speed
  - Method of bracing

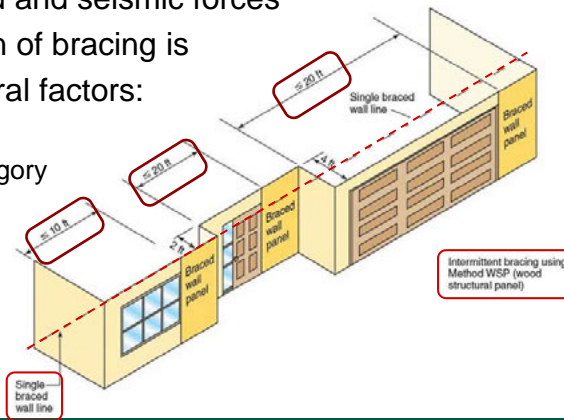

# Method PFH Braced Wall Panels

## Portal Frame with Hold-Downs

- Minimum hold-down capacity 3500 lbs
- Double sill plate
- 5/8-inch anchor bolt

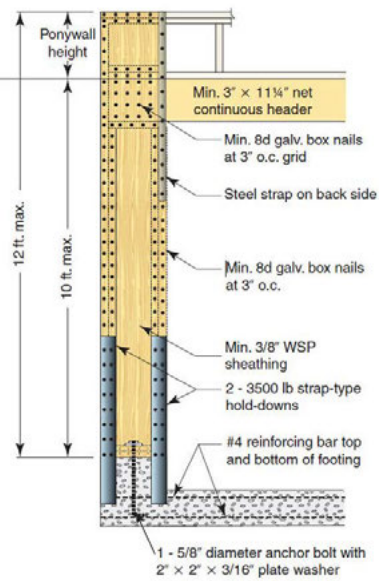

## Ceiling Joists

- Ceiling joists
  - Support ceiling materials
  - Serve as rafter ties to resist the outward thrust of the rafters at the top of the wall
  - Require adequate connection to the rafter and top of wall
- Ceiling joist spans for:
  - Attics without storage
  - Attics with limited storage
    - Attics with fixed stair access require joists sized as floor joists



2015 IRC Essentials

Workbook Page 99

85

## Rafters

- Rafter spans based on:
  - Snow load of the geographic area;
  - Roof live load of 20 psf where snow load <30 psf;
  - Whether ceiling material is attached to the bottom of the rafter
- Connection to ceiling joists
  - Rafters are connected to the ceiling joists at the top plate; or
  - 2 x 4 rafter ties are required to resist the outward thrust forces of the rafters on the wall



2015 IRC Essentials

Workbook Page 99

86

**FOR EXAMPLE**

## Example 6-6 Rafter Size and Spacing

- Given:
  - #2 Spruce-pine-fir lumber
  - Span = 15'
  - Ground snow load = 30 psf
  - Dead load = 10 psf
  - Ceiling not attached to rafters

15 ft rafter span

Ridge board

Minimum 1 × 4 collar ties at 4 ft OC to resist uplift

#2 Spruce-pine-fir

3-10d face nails

Ceiling joist attached to rafters at top of exterior walls

Ceiling

2015 IRC Essentials Workbook Page 100 87

**FOR EXAMPLE**

## Example 6-6 Rafter Size and Spacing

Table 802.5.1(3) - Rafter Spans

Rafter Spacing (inches)	Species and Grade	Dead Load = 10 psf		
		2 x 6	2 x 8	2 x 10
		Maximum rafter spans		
		ft - in	ft - in	ft - in
16	Douglas fir-larch #2	12-1	15-4	18-9
	Southern Pine #2	11-2	14-2	16-10
	Spruce-pine-fir #2	11-11	15-1	18-5
24	Douglas fir-larch #2	9-9	12-4	15-1
	Southern Pine #2	10-2	13-2	15-9
	Spruce-pine-fir #2	9-9	12-4	15-1

2015 IRC Essentials Workbook Page 100 88

**FOR EXAMPLE**

## Example 6-6

15 ft rafter span

2x8 @ 16 in. o.c.  
 or  
 2x10 @ 24 in. o.c.

2015 IRC Essentials Workbook Page 100 89

## Rafter Tie Alternatives

Minimum 1 x 4 collar ties at 4 feet OC to resist uplift installed in upper 1/3 of attic space

Minimum 2 x 4 rafter ties

Ceiling joists perpendicular to rafters

Rafter spans are reduced if rafter ties are located higher in the attic space

- Rafter ties
- Ridge beam

Approved connectors

Beam required

Rafter

Finish ceiling materials applied directly to rafters or furred out for insulation or aesthetic purposes

No ceiling joist or rafter ties to resist outward rafter thrust on walls

2015 IRC Essentials Workbook Page 101 90

**Table R602.3(1)  
 Fastener Schedule for Roof Framing**

Description	Nails	Spacing
Rafter or roof truss to plate, toe nail	3-16d box or 3-10d common	2 toe nails on one side and 1 toe nail on opposite side
Roof rafters to ridge, valley or hip rafters	4-16d toe nail 3-16d face nail	–
Ceiling joists to plate, toe nail	3-8d common	–
Collar tie to rafter, face nail	3-10d common	–
Rafter/ceiling joist heel joint connection	Table R802.5.1(9)	–



## Roof Uplift Connections

- Table provides uplift values based on:
  - Building width
  - Wind speed
  - Exposure category
  - Roof pitch
- For ≤200 lbs. uplift, toe-nail connection is OK
- For >200 lbs. uplift, a connector is required



**FOR EXAMPLE**

## Example Roof Uplift Connection

- Determine uplift forces
- Given:
  - Wind speed = 115 mph
  - Wind exposure B
  - Trusses 24 in. o.c.
  - Building width = 36 ft
  - Roof slope = 5:12

Uplift connector rated for  $\geq 212$  lbs.

Rafter or Truss at 24 in. o.c.

24 in. max.

36 ft

115 MPH wind speed, Exposure B

**Table R802.11 – Rafter or Truss Uplift Connection Forces from Wind**

Rafter or Truss Spacing	Roof Span (feet)	Roof Pitch	
		< 5:12	$\geq 5:12$
24" OC	28	198	176
	32	218	194
	36	240	212

2015 IRC Essentials Workbook Page 103 93

## Attic Ventilation and Access

- Total net free ventilating area must be 1/150 of attic area
  - Reduced to 1/300 when 40% to 50% of ventilating area in upper portion of space
  - Unvented attics may be permitted with certain conditions
- Access to attics required when:
  - Attic area >30 ft<sup>2</sup>, and
  - Attic height >30"
- Access
  - Minimum 22" x 30"
  - 30" headroom above the opening
  - Located in a hallway or other readily accessible location

2015 IRC Essentials Workbook Page 103 94



Part IV

# Finishes and Weather Protection

95

## Interior Finishes

- Minimum installation requirements for:
  - Gypsum board (drywall)
  - Plaster
  - Ceramic tile
  - Wood paneling
- Inspection is not required except when part of a fire-resistance-rated assembly





## Exterior Wall Covering

- 3 components of a weather-resistant exterior wall assembly:
  - Water-resistive barrier required over sheathing of all exterior walls, except for detached accessory buildings
  - Flashing
  - Siding or veneer

1 layer of #15 asphalt saturated felt, or Other approved water-resistant material

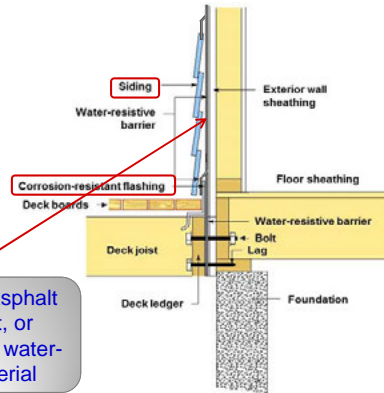

## Masonry and Stone Veneer

- SDC A, B or C
  - < 3 stories
  - < 30 feet above noncombustible foundations
  - Additional 8 feet for gable end walls
  - < 5 inches thick
  - Weight < 50 psf weight
- SDC D<sub>0</sub>, D<sub>1</sub>, or D<sub>2</sub>
  - Reduced height, weight and thickness limitations

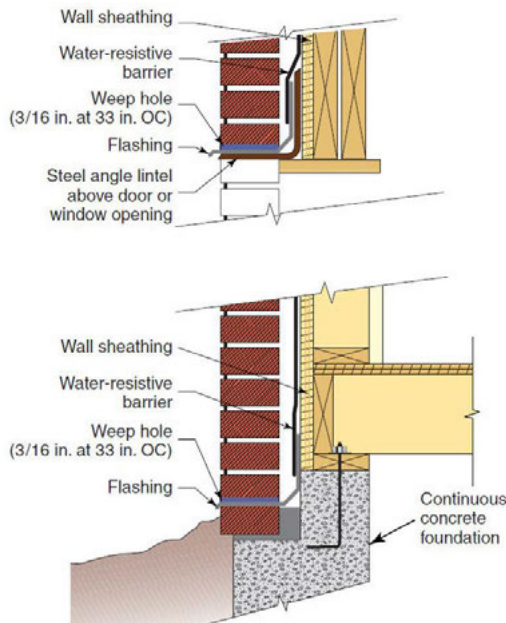

**FOR EXAMPLE**

## Example 7-1 Size of a Steel Lintel

- Determine the minimum size of a steel lintel masonry veneer with **1 story above**

Table R703.8.3.1  
Allowable Spans for Lintels Supporting Masonry Veneer

Stories above = 1  
Span = 6'0"  
Steel angle = 4" x 3" x 1/4"

Long side of steel angle must be in the vertical position

Steel lintel  
Rust-inhibitive shop coat on all surfaces

4 in. minimum bearing

Span 6 ft 0 in.

3 in.

4 in.

1/4 in.

2015 IRC Essentials

Workbook Page 111

99

## Roof Covering

- Weather protection system:
  - Underlayment
  - Ice barriers
  - Flashing
  - Roofing material

Turn-out bottom flashing to direct water away from wall

Minimum flashing size

4" x 4"

Minimum length per shingle manufacturer

Water-resistive barrier laps over flashing

Wall sheathing

Water-resistive barrier

Siding

Underlayment

Asphalt shingles

Flashing

Roof sheathing

2015 IRC Essentials

Workbook Page 114

100

## Underlayment for Asphalt Shingles

**1 layer underlayment** (for slope  $\geq 4:12$ )

**2" horizontal lap** (typical)

**19" horizontal lap** (for slope  $\geq 2:12$  and  $< 4:12$ )

**2 layers underlayment** (for slope  $\geq 2:12$  and  $< 4:12$ )

**No. 15 asphalt felt**

**Offset vertical laps by 6"**

**19" laps provide double coverage**

**Minimum 2" lap typical**

**Minimum 6" lap offset**

**Roof sheathing**

**Rake metal drip edge**

**Eave metal drip edge**

**Slope  $\geq 4:12$**

**Slope  $\geq 2:12$  and  $< 4:12$**

2015 IRC Essentials      Workbook Page 116      101

## Ice Barriers

- Ice barrier is required in areas with a history of water damage to structures from ice dams at roof eaves

**Roof sheathing**

**Roofing**

**No. 15 asphalt felt**

**Self-adhering modified bitumen ice barrier material**

**Minimum 24 in.**

**Drip edge**

2015 IRC Essentials      Workbook Page 117      102



Part V

# Health and Safety

103

## Ceiling Height

- Generally 7 ft. 0 in.
- 6 ft. 8 in.:
  - Bathrooms
  - Toilet rooms
  - Laundry rooms
  - Basements w/o habitable space or hallways
- 6 ft. 4 in. basements:
  - Beams
  - Girders
  - Ducts
  - Other obstructions

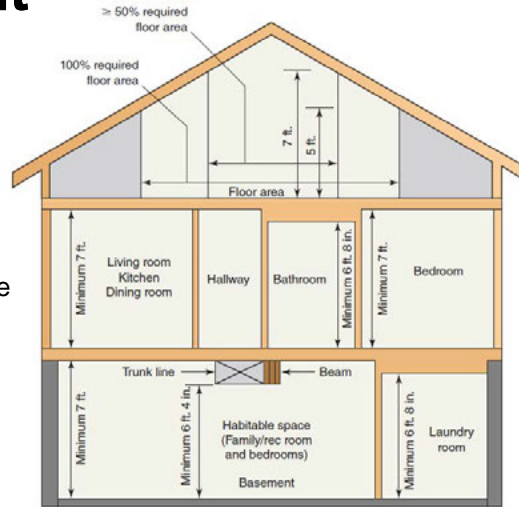

Ceiling height



## Means of Egress

- “Means of egress” describes the path of travel from any location in the dwelling to the exterior
  - Stairways
  - Ramps
  - Hallways
  - Doors
    - One 3 - 0 x 6 - 8 side-swinging egress door to exterior
    - No size or type requirements for other doors
    - No limits on travel distance



## Means of Egress

- Designed to provide a safe path to exterior
  - Does not pass through a garage
  - ½” gypsum board on enclosures under stairs
  - Egress components securely anchored to the structure
  - Required egress door can be opened without a key or special knowledge
  - Access to grade at required egress door



## Landings at Exterior Doors

- Landing or floor on each side of exterior door
  - At least as wide as the door
  - $\geq 36$  in. in the direction of travel
- Max. landing slope =  $\frac{1}{4} / 12$
- No elevation requirements in Section R311.3
- Exception for balconies

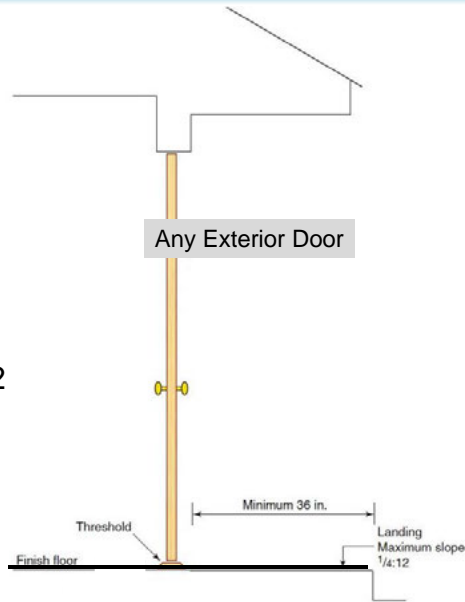

## Landings at Exterior Doors

- Required egress door
- Landings or finished floors  $\leq 1\frac{1}{2}$  in. below top of threshold
- Exception
  - Door swings in
  - Exterior landing can be a maximum of  $7\frac{3}{4}$  inches below top of the threshold
- Access to grade

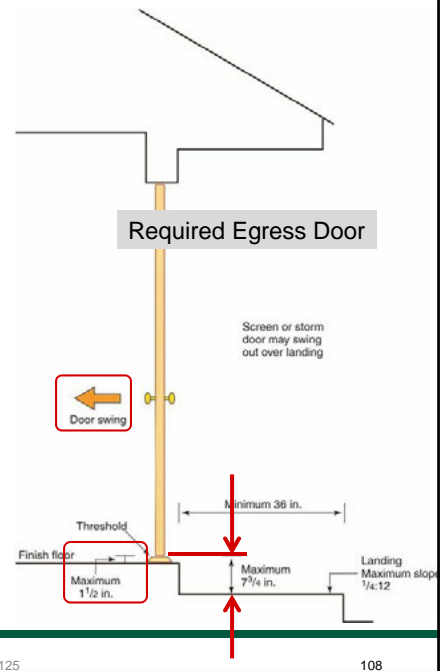

## Landings at Exterior Doors

- Other than required egress door
- Landing on either side:
  - $\leq 7\frac{3}{4}$  in. below top of the threshold
- Door swings either direction

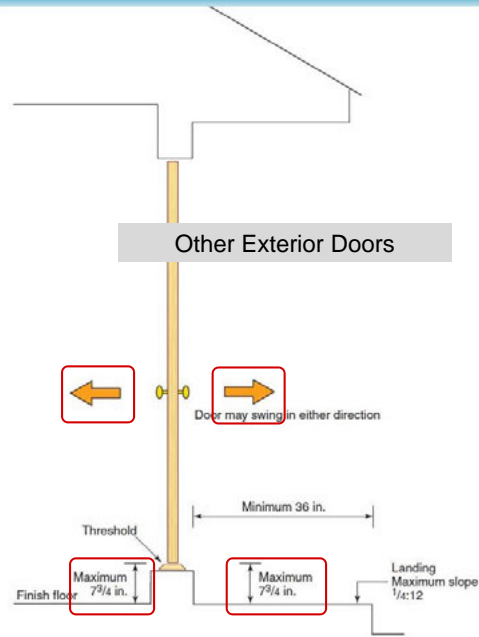

## Stairs at Exterior Doors

- Door other than required egress door
- Exception
  - Stairs allowed on exterior side
    - Door cannot swing out over stairs
    - Stairs can have a maximum of 2 risers

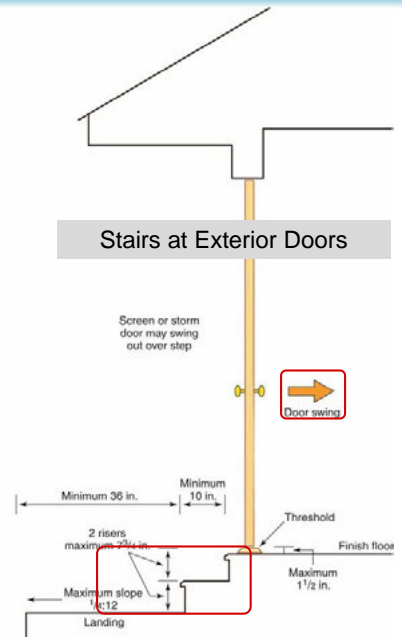

## Stair treads and risers

- Riser  $\leq 7\frac{3}{4}$  in.
- Tread  $\geq 10$  in.
- Variance  $\leq \frac{3}{8}$  in.
- Nosing projection  $\frac{3}{4}$  -  $1\frac{1}{4}$  in.

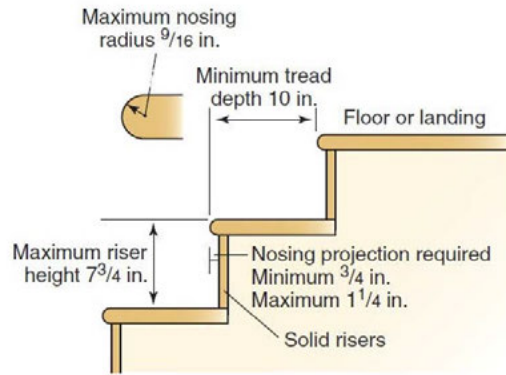

## Stair treads and risers

- Treads  $> 30$  in. above floor or grade
  - Solid risers, or
  - 4-in. diameter sphere cannot pass through

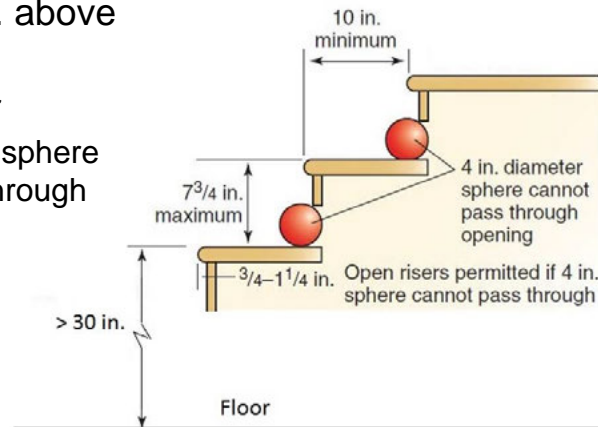



## Stairway Width

- Minimum clear width of 36"
  - Required above the handrail; and
  - Below the required headroom height
  - ≤ 4½" handrail projection either side

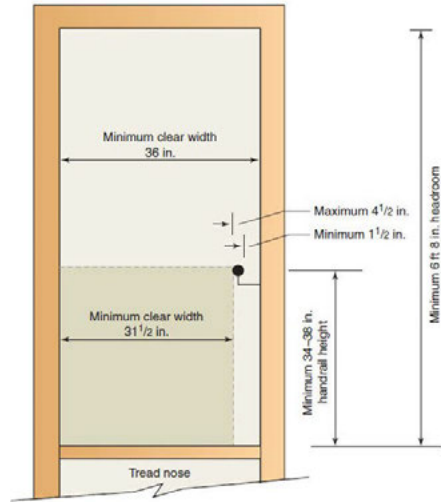

## Stairway Headroom

- Minimum headroom
  - 6 ft. 8 in.
  - Above plane of tread nosings

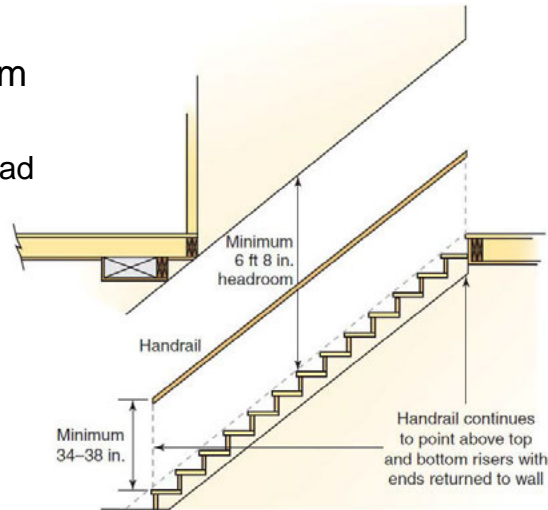

## Winder Stairs

- Nonparallel edges
- Tread depth of 6" at the narrow end
- Tread depth of 10" measured at walk line

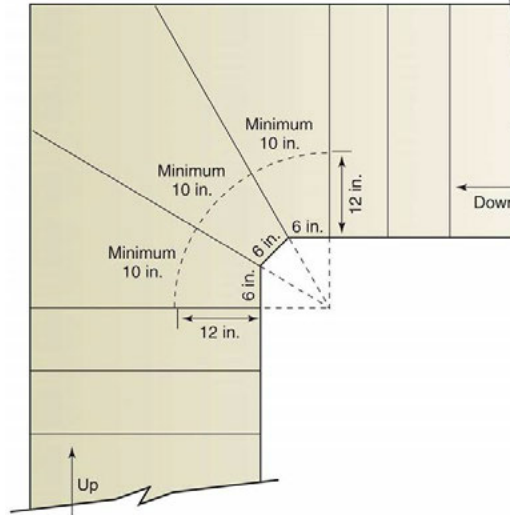

## Landings

- Required at top and bottom of stairs
- Width of stairway
- Minimum 36" in direction of travel
- Maximum 147" vertically between landings
- Exception allows a door at the top of an interior flight of stairs, provided the door does not swing over the step

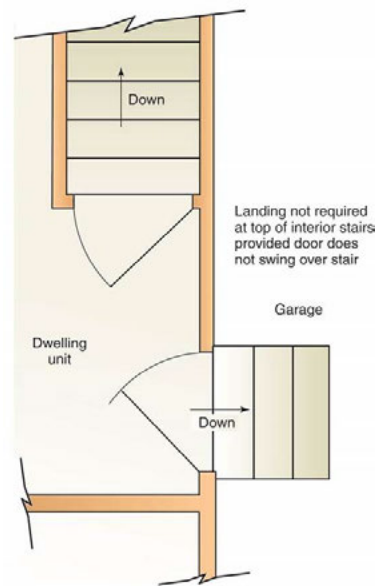

# Handrail

- Max. 4½-inch projection from wall
- Min. 1 ½-inch clearance to wall
- Graspable shape

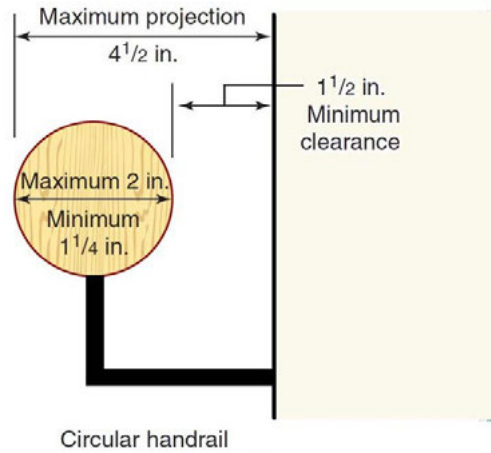

# Handrail continuity

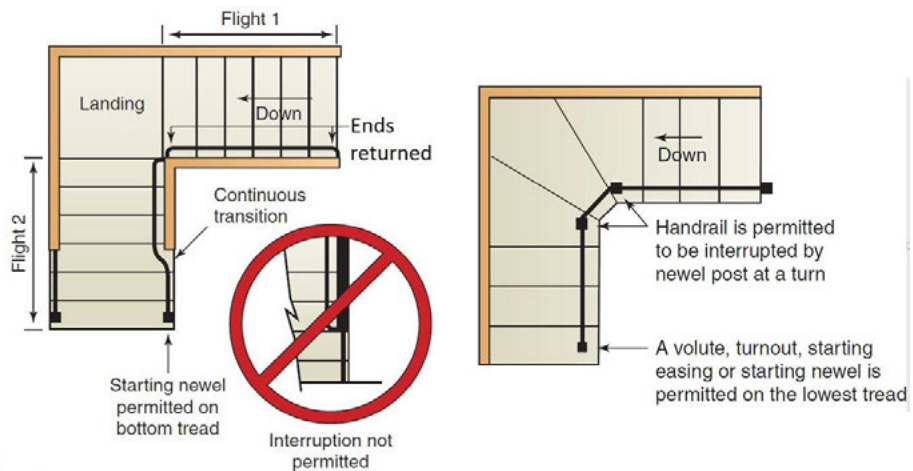

## Guards

- A walking surface >30 inches above any point within 36 inches horizontally
- Min. guard height 36 in.
  - 34 in. at stairs

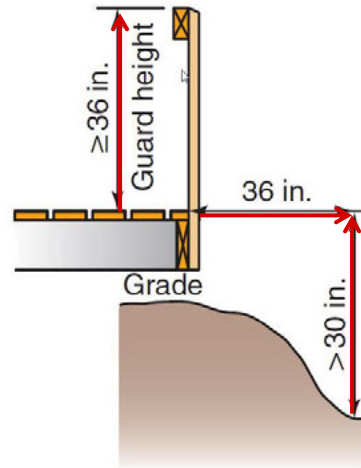

## Guards

- Openings shall not allow a 4-in. sphere to pass through
  - 4 3/8 in. along stairs
- Top rail to resist a single concentrated load of 200 lbs. applied in any direction
- Infill components to resist 50-lb. horizontal load applied to an area of 1 ft<sup>2</sup>

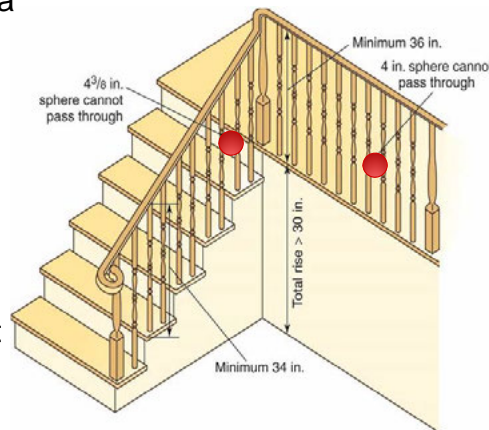

## Windowsill Height

- Window openings >72" above grade must have a sill height of >24"
- Alternatives to 24" sill height
  - Window opening control device
  - Window fall prevention device
  - Fixed glazing

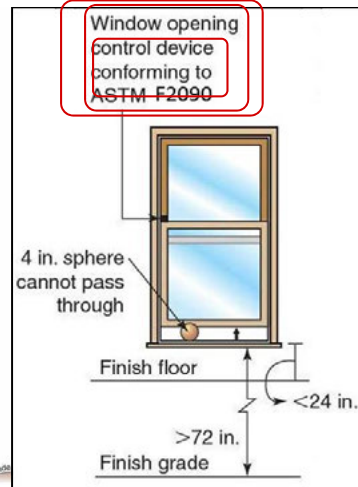

## Emergency Escape and Rescue Openings

- Basements
- Habitable attics
- Sleeping rooms
  - Exceptions:
    - Storm shelters
    - Basements ≤ 200 sq. ft. used only to house mechanical equipment

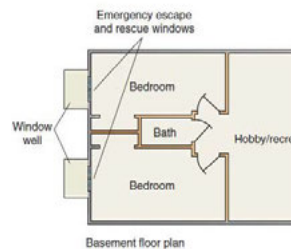

## Emergency Escape and Rescue Openings

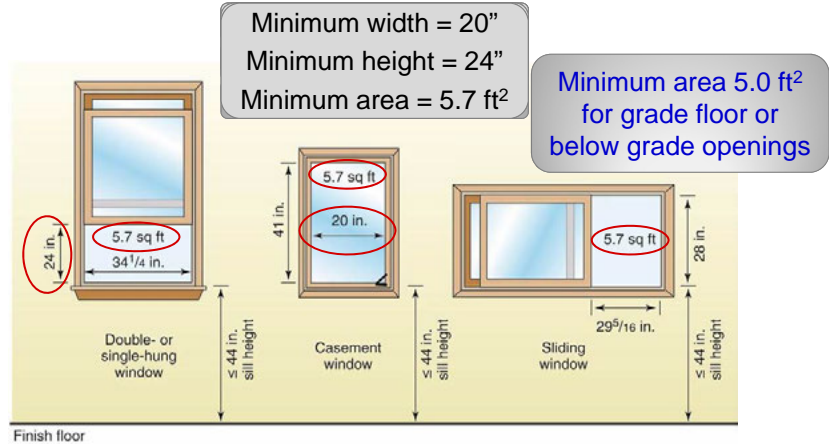

## Safety Glazing – Adjacent Doors

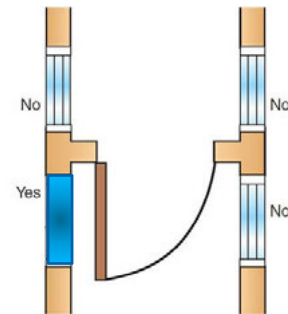
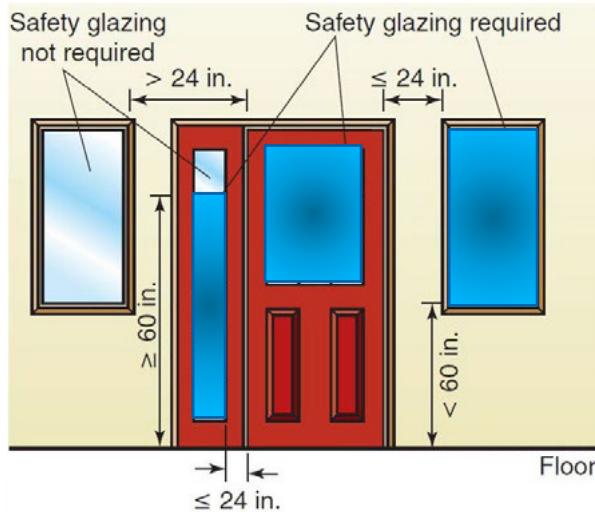

## Safety Glazing – Windows

- Exposed area of an individual pane > 9 sq. ft.
- Bottom edge of glazing < 18 in. above floor
- Top edge of glazing > 36 in. above floor
  - Exception:
    - Horizontal rail installed 34 to 38 in. above walking surface

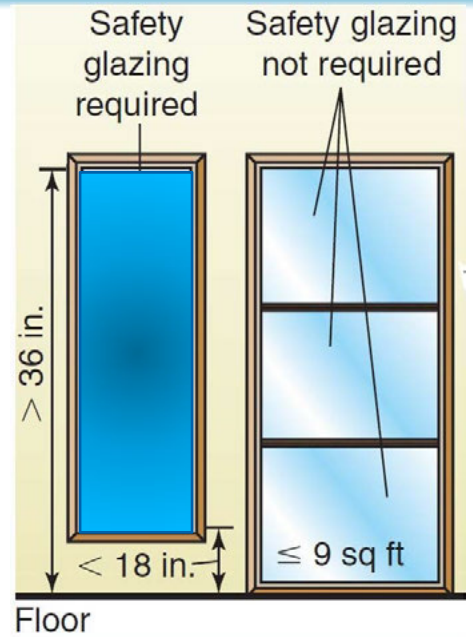

2015 IRC Essentials

125

## Safety Glazing – Wet Surfaces

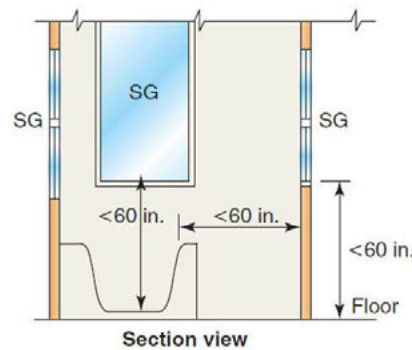
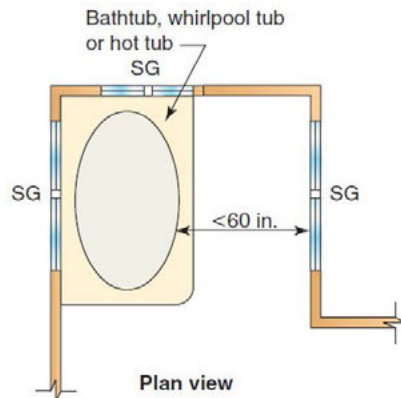

2015 IRC Essentials

126

## Safety Glazing – Adjacent Stairs

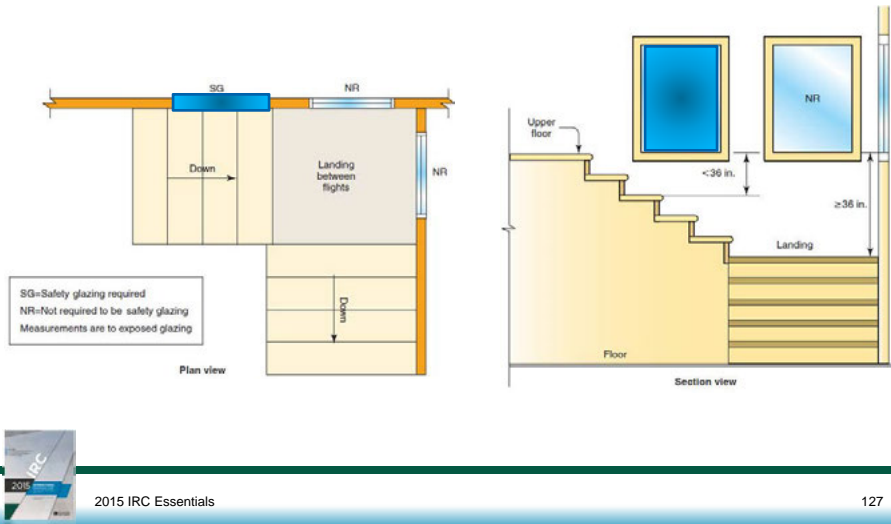

## Safety Glazing – Adjacent Bottom Landing

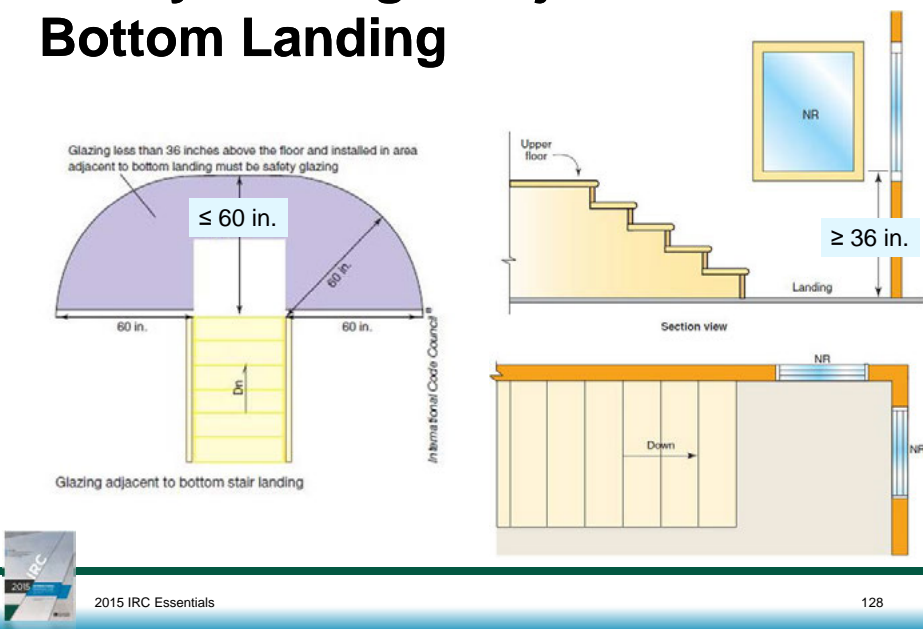



## Smoke Alarms

- In each sleeping room
- Outside each sleeping area
- On each story
- Building wiring system to provide primary power
- Battery backup
- Interconnection

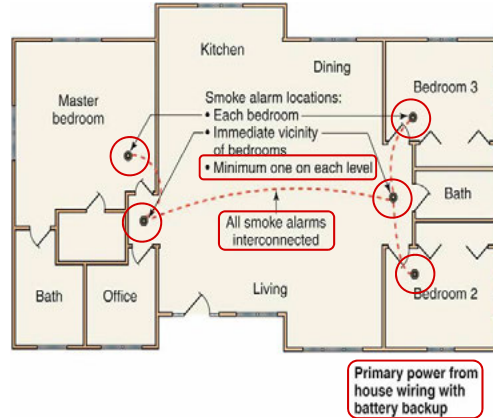

## Smoke Alarms in Existing Dwellings

- Retrofit smoke alarms when a permit is required:
  - Interior alterations or repairs
  - Additions
- Battery-operated smoke alarms
- Exception – provisions do not apply for:
  - Minor work that does not require a permit
  - Exterior work such as roofing or siding
  - Replacing doors or windows
  - Addition of a deck or porch



## Residential Fire Sprinkler Systems

- Required in:
  - New dwellings
  - New townhouses
- Design criteria:
  - IRC Section P2904
  - NFPA 13D
  - Both designs applicable to 1- and 2-family dwellings and townhouses



## Exterior Walls

Dwelling **without** fire sprinklers

Dwelling **with** fire sprinklers

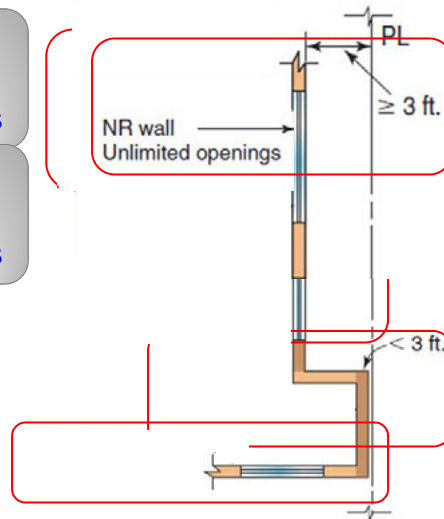

## Eave Projections

**Dwelling without fire sprinklers**

The diagram shows a side view of a house with a gabled roof. A horizontal line labeled "Lot line" is shown to the right of the house. A dimension line indicates the distance from the lot line to the edge of the eave projection, which is labeled as  $\geq 5$  ft. A red circle highlights this dimension. Above the roofline, a dimension line indicates the "Projection" of the eave.

**No protection required**

**1-HR protection**

2015 IRC Essentials Workbook Page 148 133

## Eave Projections

**Dwelling with fire sprinklers**

The diagram shows a side view of a house with a gabled roof, similar to the one above. A horizontal line labeled "Lot line" is shown to the right of the house. A dimension line indicates the distance from the lot line to the edge of the eave projection, which is labeled as  $\geq 3$  ft. A red circle highlights this dimension. Above the roofline, a dimension line indicates the "Projection" of the eave.

**No protection required**

**1-HR protection**

2015 IRC Essentials Workbook Page 148 134

## Two-Family Dwelling Separation

- 1-hour separation
  - Continuous foundation to roof
- Exception
  - 5/8-inch gypsum board ceiling
  - 1/2-inch gypsum board on bearing walls
  - Draft stop in attic

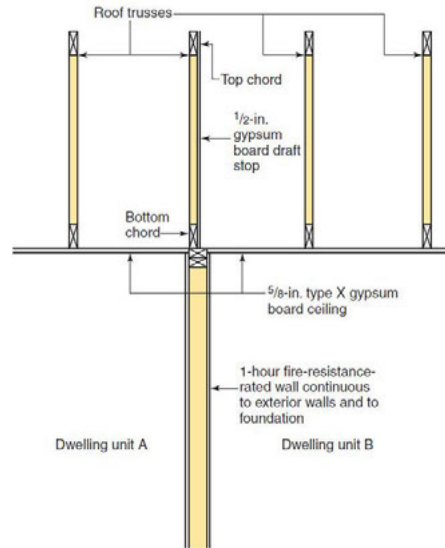

## Townhouse Separation

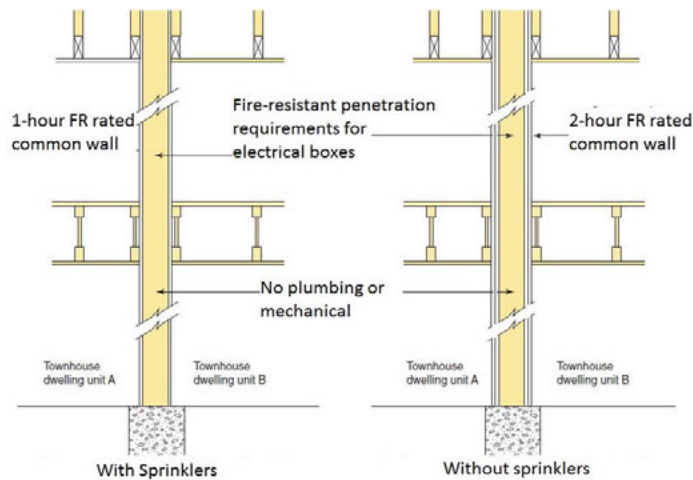

## Parapet Exception

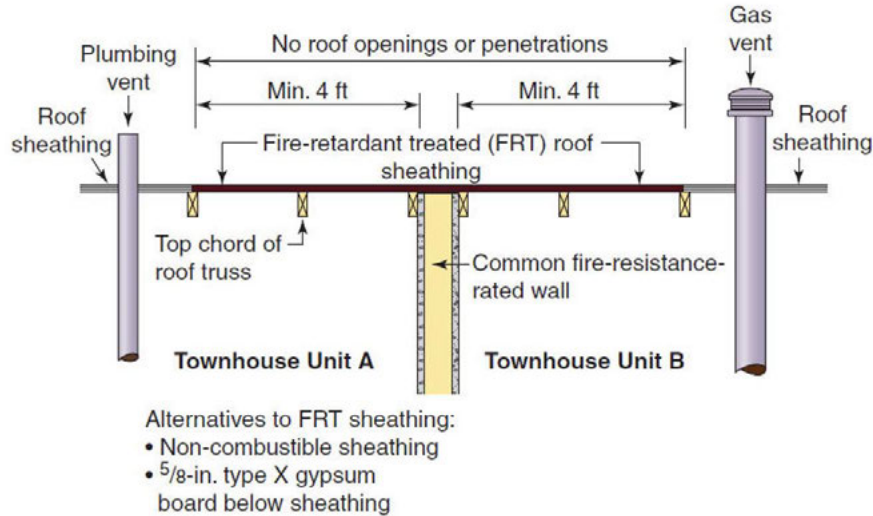

## Dwelling Separation from Garage

- Not a fire-resistance-rated assembly
- 1/2" gypsum board on the garage side provides limited resistance to the spread of fire
- 5/8" Type X gypsum board on ceiling when habitable space above

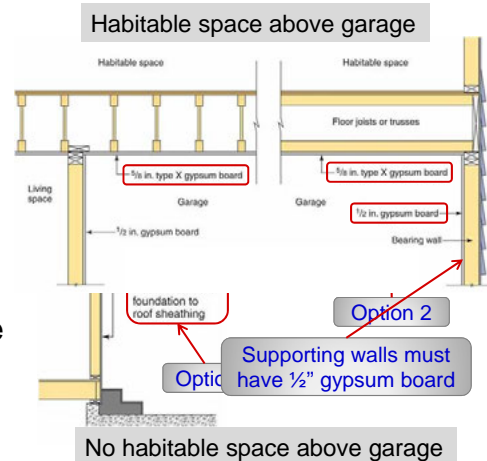

## Dwelling Separation from Garage

- Penetrations not rated
- No openings from garage into a sleeping room
- Self-closing door
  - 1 3/8"-thick solid-core wood
  - 1 3/8"-thick solid-core steel
  - 1 3/8"-thick honeycomb-core steel
  - 20-minute fire-resistance-rated

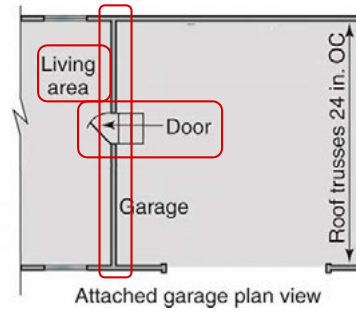

## Fire Protection of Floors

- Underside of floor assembly
  - 1/2" gypsum board
  - 5/8" wood structural panel
  - equivalent material
- Exceptions
  - ≥ 2 x10 dimension or SCL
  - Sprinklers below
  - ≤ 80 ft<sup>2</sup> area
  - Crawl space with no storage or fuel-fired appliances

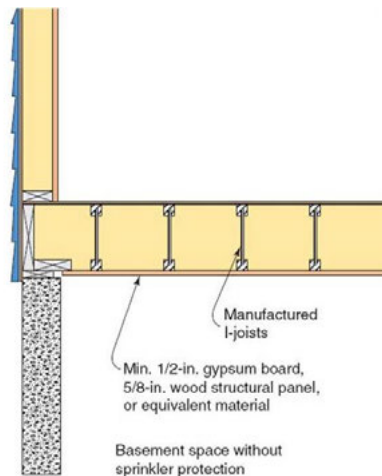

## Light and Ventilation

- Habitable rooms:
  - Glazing  $\geq 8\%$  or lighting  $\geq 6$  footcandles
  - Openings  $\geq 4\%$  or mechanical ventilation
- Bathrooms:
  - Glazing  $\geq 3 \text{ ft}^2$  or electric lighting
  - Openings  $\geq 1.5 \text{ ft}^2$  or mechanical exhaust



2015 IRC Essentials

Workbook Page 163

141

## Whole-house Mechanical Ventilation System

- Required if
  - Blower door test performed and
  - Air infiltration rate  $\leq 5$  ACH
- Prescriptive air flow rate based on
  - Area of dwelling
  - Number of bedrooms
  - Continuous or intermittent operation

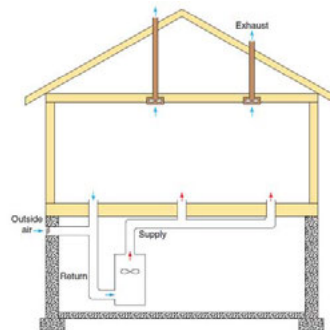

142

## Stairway Illumination

- Interior stairways
  - Treads and landings  $\geq 1$  foot-candle
  - Wall switch at each floor level  $\geq 6$  risers.
- Exterior stairways
  - Light source at top landing
  - Bottom landing providing access to a basement

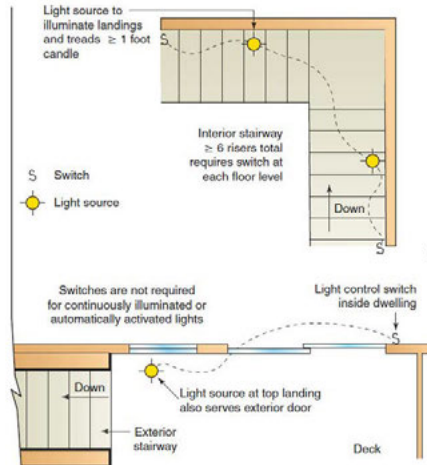

## Carbon Monoxide (CO) Alarms

- Required if
  - Fuel-fired appliance or
  - Attached garage communicating with dwelling unit
- Locations
  - Outside of each separate sleeping area adjacent bedrooms
  - Within bedroom with fuel-burning appliance located within bedroom or attached bathroom
- Power
  - House wiring with battery backup

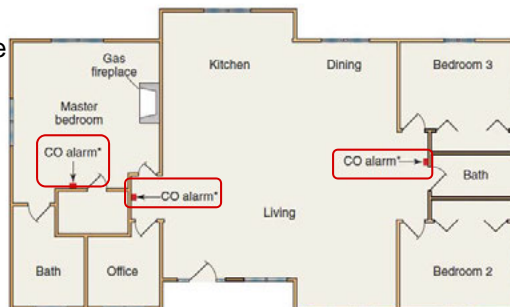

\*CO alarm may be a combination CO and smoke alarm





# Chimneys and Fireplaces

- Masonry fireplaces
  - Masonry chimneys
  - Factory-built fireplaces
  - Factory-built chimneys
  - Exterior Air Supply
- Per manufacturer's instructions



# Masonry Chimney Termination

- 3 feet above roof penetration
- 2 feet higher than any portion of a building within 10 feet
- Flashing to weatherproof the chimney penetration at the roof
- Crickets required for chimneys  $\geq 30$ " wide
- Chimney cap required
- Rain cap optional

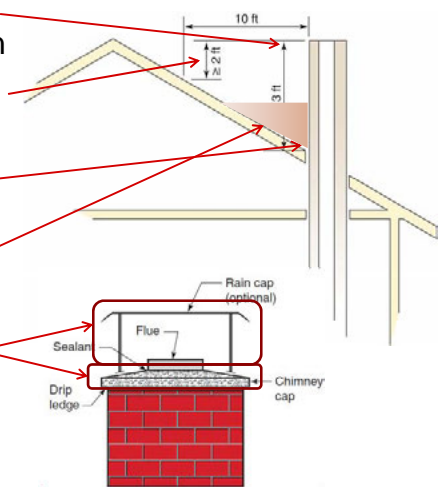



Part VII

# Energy Conservation

147

## Energy Efficiency

- IRC Chapter 11 is extracted from the applicable provisions of the 2015 IECC

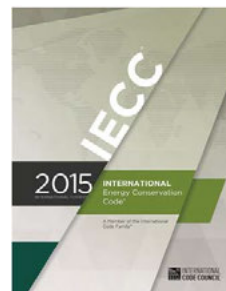
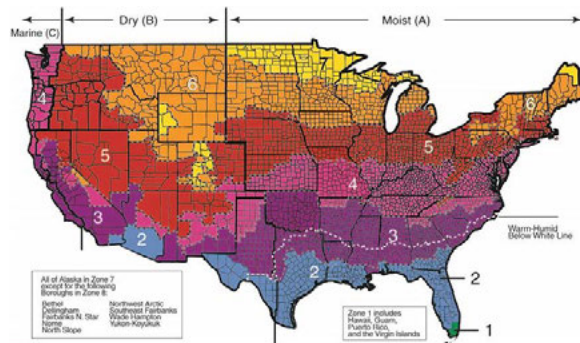

# Compliance Paths

Projects shall comply with one of the following:

1. Sections N1101.14 through N1104.
2. Section N1105 and the provisions of Sections N1101.14 through N1104 labeled "Mandatory."
3. An energy rating index (ERI) approach in Section N1106.

Prescriptive and mandatory provisions

Performance and mandatory provisions



# Building Insulation

- Pieces of insulation >12" in width must have:
  - Visible R-value mark; or
  - Installer certification
    - Insulation type
    - Manufacturer
    - R-value



## Blown-in or Sprayed Insulation

- Attic markers each 300 sq. ft.
- Certificate indicating:
  - Initial installed thickness
  - Settled thickness
  - Settled R-value
  - Installed density
  - Coverage area
  - Number of bags installed

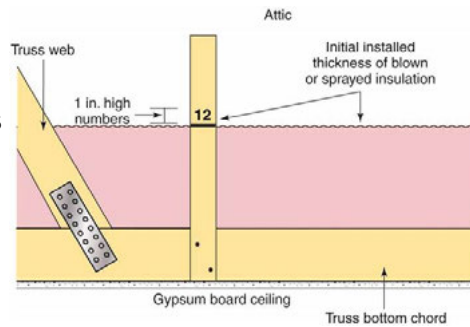

## Insulation Requirements

- Minimum R-values for insulation is based on climate zone
- Exceptions:
  - Energy truss or raised-heel roof truss
  - Reduced R-values in rafter or joist space
  - Cold-formed steel framing requires higher insulation R-values and continuous insulation sheathing to provide a thermal break

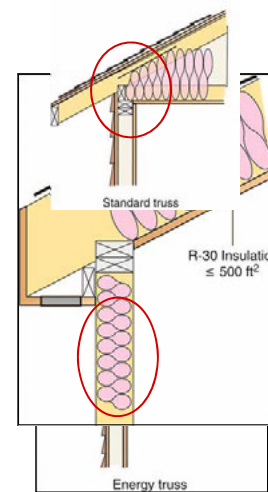

# Insulation Requirements

- Slab on grade
- Crawl spaces
  - Insulation of the floor above the crawl space; or
  - Insulation of the exterior walls
    - When the crawl space is not ventilated to the outside
    - Vapor retarder on exposed earth of unventilated crawl spaces

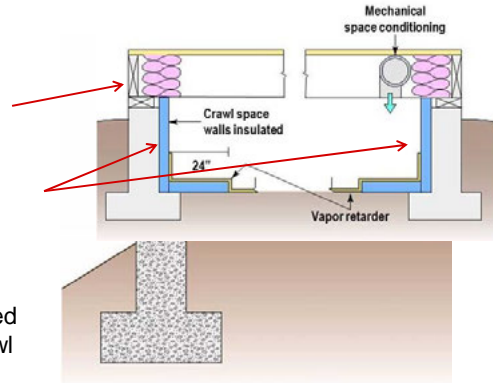

# Windows and Doors

- Fenestration includes:
  - Skylights
  - Roof windows
  - Vertical windows
  - Opaque doors
  - Glazed doors
  - Glass block
- U-factor
- Solar Heat Gain Coefficient (SHGC)

 National Fenestration Rating Council CERTIFIED	<b>World's Best Window Co.</b> Millennium 2000+ Vinyl-Clad Wood Frame Double Glazing • Argon Fill • Low E Product Type: Vertical Slider	
	ENERGY PERFORMANCE RATINGS	
U-Factor (U.S./I-P)	Solar Heat Gain Coefficient	
<b>0.35</b>	<b>0.32</b>	
ADDITIONAL PERFORMANCE RATINGS		
Visible Transmittance	Air Leakage (U.S./I-P)	
<b>0.51</b>	<b>0.2</b>	
Condensation Resistance		
<b>51</b>		
<small>Manufacturer stipulates that these ratings conform to applicable NFRC procedures for determining whole product performance. NFRC ratings are determined for a fixed set of environmental conditions and a specific product size. Consult manufacturer's literature for other product performance information. www.nfrc.org</small>		



## Sealing Against Air Leakage (Mandatory)

- Windows and doors
- Sill plate, rim joist, top plate
- Garage separation
- Tubs/showers
- Attic access opening
- Rim joists
- Recessed lighting
- Electrical boxes

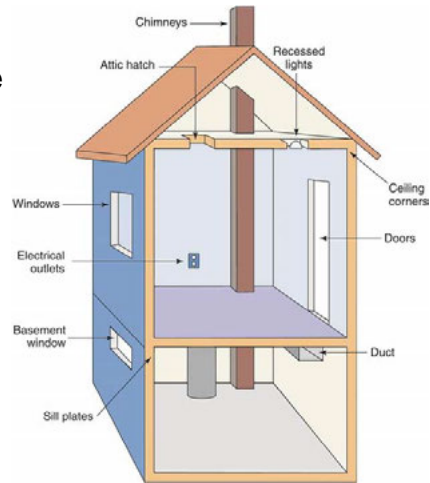

## Testing of Building Thermal Envelope (Mandatory)

- Blower door test required
- Allowable air-leakage rate:
  - Climate Zones 1 – 2:  $\leq 5$  ACH
  - Climate Zones 3 – 8:  $\leq 3$  ACH
- Test results on permanent certificate

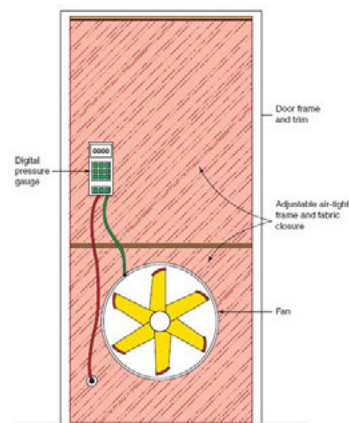

## Duct Insulation and Sealing

- Supply and return ducts in attics >R-8
- Supply and return ducts in other locations >R-6
- No insulation required for ducts within conditioned spaces
- Sealing of all ducts is required
- Air leakage test except when entire system is installed within the thermal envelope
- Building cavities cannot be used as ducts or plenums



2015 IRC Essentials

Workbook Page 246

157

## Hot Water Pipe Insulation (Prescriptive)

- Hot water pipe insulation  $\geq R-3$  for:
  - $\geq \frac{3}{4}$ " diameter pipe
  - Water Heater to distribution manifold
  - Outside conditioned space
  - Under slab or underground
  - Piping in recirculation systems other than demand systems



2015 IRC Essentials

Workbook Page 247

158

## Energy Certificate (Mandatory)

- Completed by:
  - Builder; or
  - Registered design professional
- Listing of
  - Insulation
  - Fenestration
  - Type and efficiency of equipment
  - Results of air testing
- Permanent certificate posted near furnace or approved indoor location

Energy Efficiency Certificate	
<b>Insulation Rating</b>	
Ceiling/roof	
Walls	
Floors	
Ducts	
<b>Air-leakage Test Results</b>	
Blower door	Duct testing
<b>Fenestration Rating</b>	
Window	
Opaque door	
Skylight	
<b>Equipment Performance</b>	
Heating system	
Cooling system	
Water heater	
Designer/builder	

© International Code Council

Permanent energy certificate



Part VI

# Building Utilities

160



## Appliances Installation and Location

- Gas-fired appliances
- Installation and clearances per the appliance listing
- Prohibited locations
  - Sleeping room
  - Bathroom
  - Toilet rooms
  - Storage closets
  - Space that opens only into such rooms or spaces

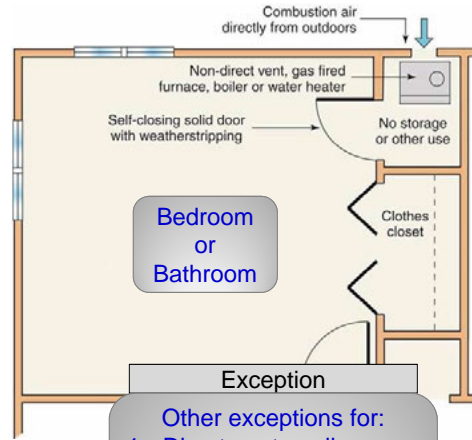

- Exception**
- Other exceptions for:
1. Direct-vent appliances
  2. Vented room heaters
  3. Vented wall furnaces
  4. Vented gas fireplaces



2015 IRC Essentials

Workbook Page 182

## Appliances Installation and Location

- In garages, the ignition source  $\geq 18''$  above the floor
  - Unless the appliance is listed as flammable-vapor-ignition resistant
- In all locations, protected from impact by vehicles

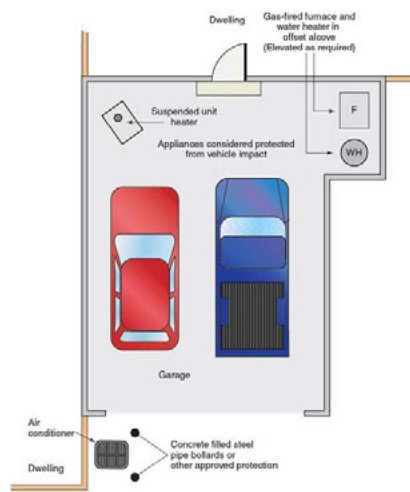

2015 IRC Essentials

Workbook Page 183

162

## Access to Appliances

- Minimum 30" x 30" working space in front of the controls
- Access doors and passageways
  - Minimum 24" wide
  - Large enough to remove the largest appliance
- Clearance
  - Furnace compartments to be >12" inches wider than the appliance
  - Minimum 3" clearance at the sides and back



2015 IRC Essentials

Workbook Page 184

163

## Access Appliances in Attics

- Finish access opening  $\geq 20 \times 30$ 
  - (R807.1 Rough 22 x 30)
- Passageway
  - $\geq 22 \times 30$  h
  - $\geq 24$ -in. wide flooring
  - $\leq 20$ -ft. length
- Exception
  - $\leq 6$ -ft. high x 50 ft. long

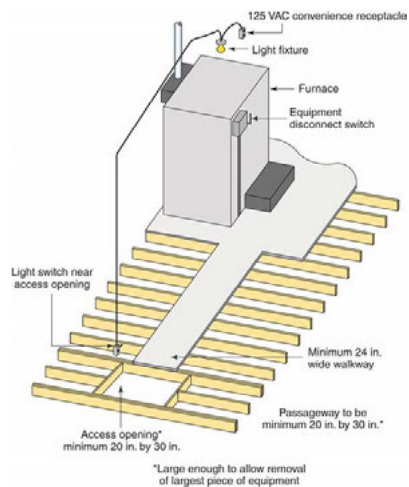

2015 IRC Essentials

Workbook Page 184

164

## Clothes Dryer Exhaust Systems

- Termination
  - Backdraft damper
  - No screen
  - $\geq 3$  ft. from openings
- Length
  - Deductions for fittings
  - Label when  $> 35$  ft.
  - Label  $\leq 6$  ft. from dryer
- Listed transition duct

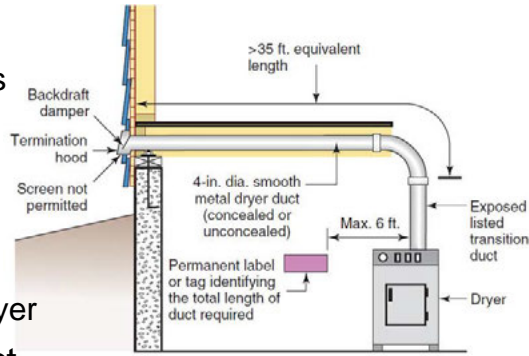

## Clothes Dryer Exhaust Systems

- Dryer Exhaust Duct Power Ventilator (DEDPV)
  - Per manufacturer
- Protection of concealed dryer duct
  - $< 1\frac{1}{4}$  inches
  - $\geq 2$  in. above sole plates, below top plates

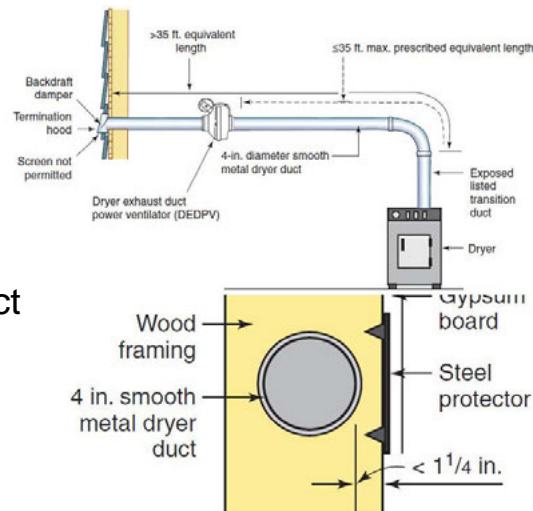

## Dryer Exhaust Duct

- 4-in. smooth metal duct
  - Min. No. 28 gage
- Insert in direction of flow
- Max. 1/8-in. screw penetration

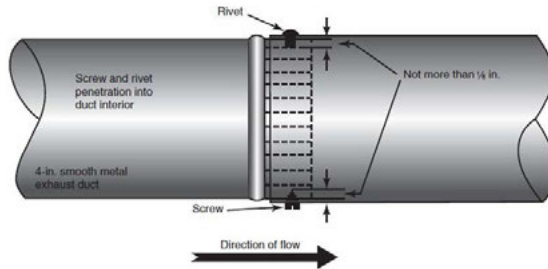

## Whole-house Mechanical Ventilation system

- Prescriptive airflow rate based on:
  - Floor area of dwelling unit
  - Number of bedrooms
  - Continuous or intermittent
- System design
  - One or more supply or exhaust fans, or a combination
  - Outdoor air ducts connected to the return permitted to supply ventilation.

Floor Area	Bedrooms	
	2 – 3	4 – 5
	CFM Airflow	
< 1500	45	60
1501 – 3000	60	75
3001 – 4500	75	90



## Combustion Air from Inside the Building

Furnace = 100,000 Btu/h  
Water heater = 35,000 Btu/h  
Combined input = 135,000 Btu/h

- Combustion air can draw from an adjacent room if:
  - Volume of adjacent space is >50 ft<sup>3</sup> per 1000 Btu/h
  - At least 2 openings provide air from the adjacent room
  - Free area of openings based on:
    - Btu/h input rating of all appliances
    - 1 in<sup>2</sup> per 1000 Btu/h
    - Minimum 100 in<sup>2</sup> per opening

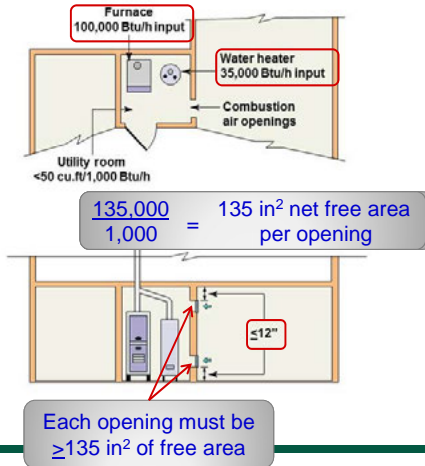

## Combustion Air from Two Outdoor Openings

- Direct opening or vertical duct
  - Free area of ≥1 in<sup>2</sup> per 4000 Btu/h of total input rating
- Direct opening or horizontal ducts
  - Free area of ≥1 in<sup>2</sup> per 2000 Btu/h of total input rating

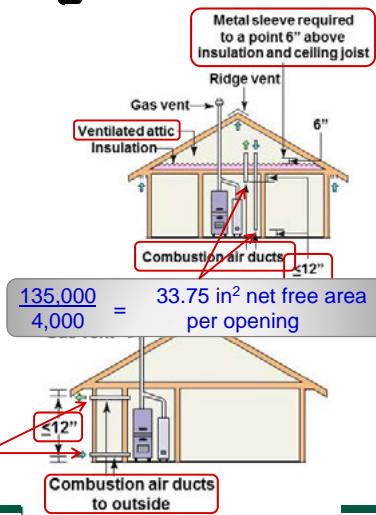

## Combustion Air from Single Outdoor Opening

- Free area of the opening  $\geq 1$  in<sup>2</sup> per 3000 Btu/h
- Free area must equal the sum of the areas of all vent connectors in the space
- Minimum clearances required around the

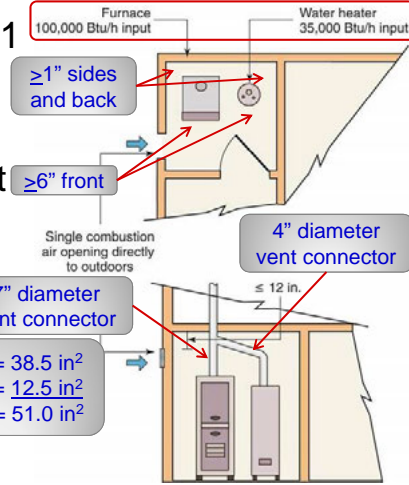

$\frac{135,000}{3,000} = 45$  in<sup>2</sup> net free area per opening

7" diameter = 38.5 in<sup>2</sup>  
4" diameter = 12.5 in<sup>2</sup>  
Combined = 51.0 in<sup>2</sup>

Larger of the two = 51 in<sup>2</sup>

## Gas Vent Roof Termination

- Termination height for gas vents with a cross section <12" and at least 8' from a vertical wall is based on the roof slope

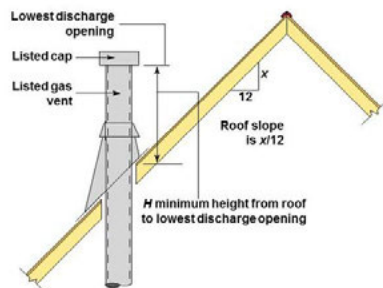

Roof Slope	Minimum Height from Roof to Lowest Discharge Opening (feet)
≤6/12	1.0
>6/12 to ≤7/12	1.25
>7/12 to ≤8/12	1.5
>8/12 to ≤9/12	2.0
>9/12 to ≤10/12	2.5
>10/12 to ≤11/12	3.25
>11/12 to ≤12/12	4.0
>12/12 to ≤14/12	5.0
>14/12 to ≤16/12	6.0
>16/12 to ≤18/12	7.0
>18/12 to ≤20/12	7.5
>20/12 to ≤21/12	8.0

## Gas Pipe Materials

- Schedule 40 steel
- Approved seamless metallic tubing
  - Gas used cannot be corrosive to the material
- Corrugated stainless steel tubing (CSST)
- Exterior underground locations only:
  - Approved plastic pipe, tubing and fittings



2015 IRC Essentials

Workbook Page 197

173

## Prohibited Locations for Gas Piping

- Piping cannot be installed:
  - Within an air duct
  - Within a clothes chute
  - Within a chimney
  - Within a gas vent
  - Through any other townhouse unit
  - Entering a building below grade



2015 IRC Essentials

Workbook Page 197

174

## Gas Piping Protection

- Concealed piping installed through holes or notches in studs, joists, rafters must be:
  - $>1\frac{1}{2}$ " from the nearest edge of the member or
  - Protected by No. 16 Gage nail shield plates
  - Except Schedule 40 black or galvanized steel gas piping
- CSST gas tubing requires protection in accordance with the code and the manufacturer's installation instructions



2015 IRC Essentials

Workbook Page 198

175

## Other Gas Piping Installation Requirements

- Above-ground gas piping outdoors
  - $\geq 3\frac{1}{2}$ " above ground and above roof surface
  - Protection from corrosion for ferrous metal
    - Painting
    - Galvanizing
- Underground gas piping
  - Steel pipe wrapped with approved material for corrosion protection
  - Galvanizing is not approved protection from corrosion
  - Buried  $\geq 12$ " deep



2015 IRC Essentials

Workbook Page 198

176



# Gas Appliance Connections

- Appliance connector materials
- Appliance connector installation
  - Can pass through the appliance
- Rigid metallic piping
- CSST
- Listed and labeled appliance connectors
- Cannot pass through walls, floors, partitions, ceiling
- Shutoff valve
  - ≤6', or
  - <50' when connected to manifold

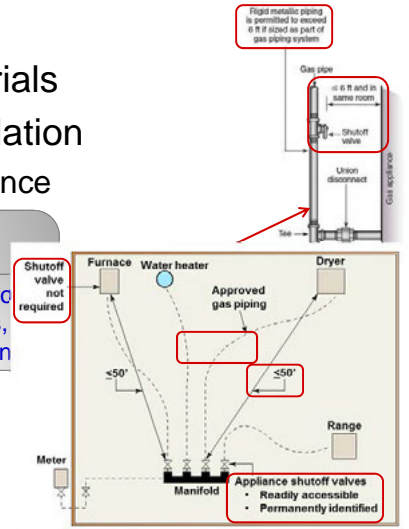

# Plumbing Piping Protection from Damage

- Concealed piping installed through studs, joists or rafters
- < 1 ¼ in. from nearest edge
  - Shield plates ≥ 0.0575" thick steel (No. 16 Gage)
    - Covers area where the pipe passes through
    - Extends ≥ 2" above sole plates and below top plates
- Exception for cast iron and galvanized steel pipe

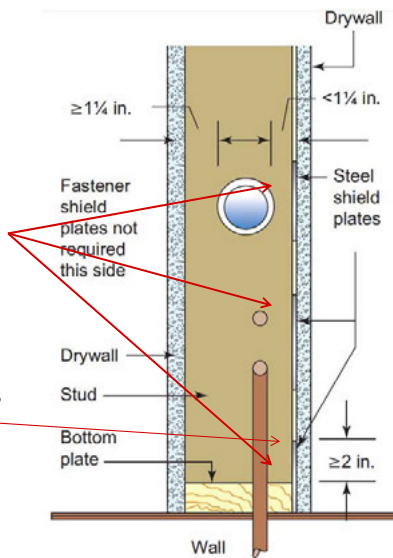

## Protection from Freezing

- Underground water service pipe
  - Buried  $\geq 12$ " deep
  - Buried  $\geq 6$ " below the frost line
- Building sewer pipe
  - Depth determined by the Jurisdiction
  - Stipulated in the adopting ordinance



## Plumbing Piping Support

- Support
  - Maintains alignment and slope
  - Prevents sagging
  - Allows for expansion and contraction
- Underground
  - Continuous support
  - Suitable bedding materials
  - Not supported on rocks or blocks
  - Backfill free of debris, rocks, concrete, and frozen material
  - Protection of footings



## Aboveground Plumbing Piping Support

- Horizontal and vertical support spacing based on the pipe material
- A mid-story guide is required for vertical plastic piping  $\geq$  2-in. diameter

Piping Material	Maximum Horizontal Spacing (ft)	Maximum Vertical Spacing (ft)
ABS pipe	4	10
Cast-iron pipe, <10' lengths	5	15
Cast-iron pipe, 10' lengths	10	15
Copper or copper alloy pipe	12	10
PEX pipe	2.67	10
PVC pipe	4	10



## Water Service

- When pipe for building sewer is listed for underground use within a building:
  - Water service pipe is permitted in the same trench with a building sewer (e.g. cast-iron or schedule 40 PVC DWV )
- For building sewer pipe not approved for underground use within a building:
  - Water service must be separated from sewer pipe:
    - $\geq$  5' of horizontal separation, or
    - Installed on a ledge  $\geq$  12" inches above and to one side of the highest point of the building sewer



## Water Supply System Design Criteria

- Water service at the building entrance
  - 40–80 psi
  - $\geq \frac{3}{4}$ " pipe size
- Distribution system pipe size based on
  - Fixture unit values
  - Developed length of piping
  - Water pressure
- Flow rates and consumption are limited for plumbing fixtures to conserve water
- Valves
  - Main shut-off valve
  - At each fixture other than showers and tubs



## Water Supply Protection

- Backflow prevention devices suitable for the application
  - Hose connections
  - Boilers
  - Heat exchangers
  - Lawn irrigation systems
- Air gap required at
  - Sinks
  - Lavatories
  - Bathtubs

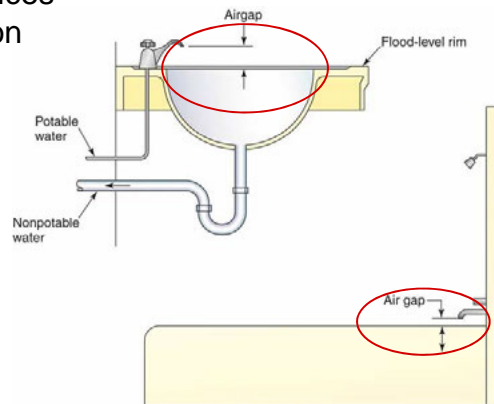

# Sanitary Drainage

- Approved fittings for change in direction

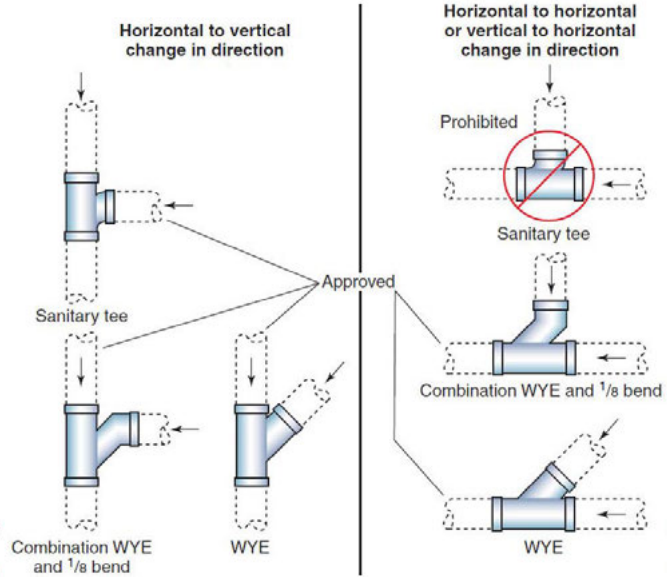

2015 IRC Essentials

# Cleanouts

- Cleanouts required where:
  - Horizontal drain lines change direction  $>45^\circ$
  - Within 10 ft. of building drain / building sewer connection
- Where more than one change of direction occurs, only one cleanout is required in each 40'
- A readily removable fixture, such as a water closet or a fixture trap of a sink, may serve as a cleanout

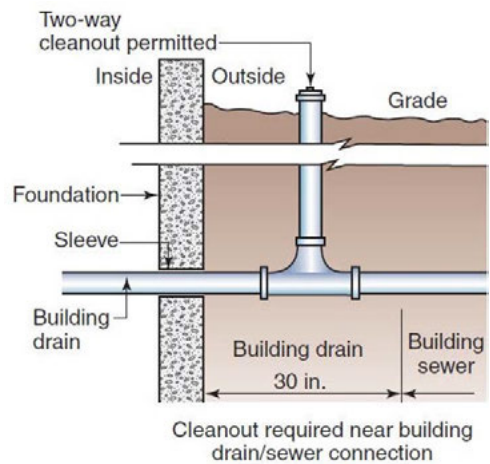

2015 IRC Essentials

Workbook Page 207

186

## Fixture Vents

- The distance from the trap to the vent is limited
  - Self-siphoning fixtures such as water closets are not limited
- Vent connection is not permitted to be below the trap weir

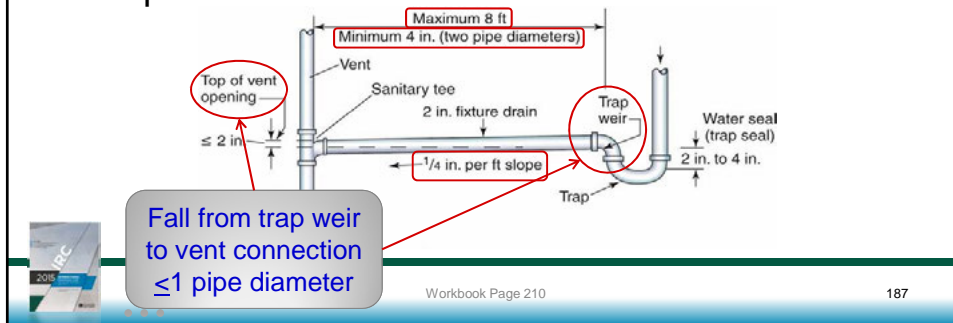

## Vent Pipe

- Horizontal wet venting is permitted for fixtures of one or two bathroom groups located on the same floor
- Diameter of vent piping
  - At least 1/2 of the required diameter of the drain served
  - >1 1/4"
  - For vents >40', increase of one pipe size

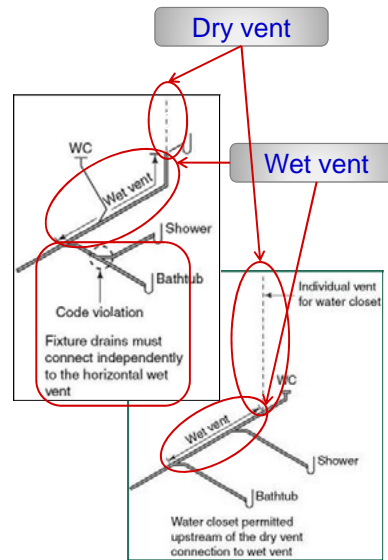

## Vent Termination

- Open vents
  - ≥ 6 in. above roof
  - ≥ 6 in. above anticipated snow accumulation
- Frost closure
  - 97.5% outside design temperature ≤ 0°F
  - Increase to 3 in. at point ≥ 12 in. inside building envelope

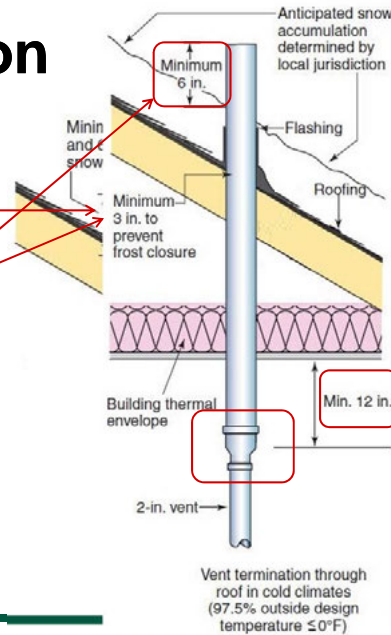

## Protection Against Scalding

- Temperature control devices are required on the water outlets of bathing fixtures and bidets to prevent scalding

Fixture	Maximum Temperature	Approved Device	Standard
Shower or Tub/Shower Combination	120°F	Pressure-balance control valve	ASSE 1016 / ASME A112.1016/CSA B125.1
		Thermostatic-mixing control valve or Combination pressure-balance/thermostatic-mixing control valve	
Bathtub or Whirlpool	120°F	Water-temperature-limiting device	ASSE 1070 or CSA B125.3
Bidet	110°F		



## Fixture Traps

- Traps provide a water seal with a depth of 2” to 4” to prevent sewer gases from entering the building
- Floor drains require a trap-primer or deep-seal design to prevent the loss of their water seal by evaporation

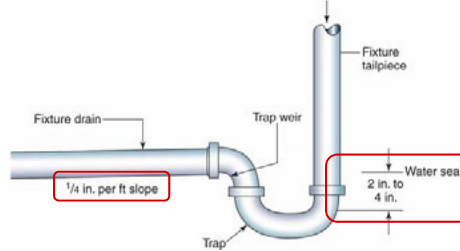

## Water Heaters

- Connection to the water supply
- Drain pan if damage will occur
- Temperature & pressure relief valve
- Ignition sources elevated
  - $\geq 18$ " above garage floor
- Anchorage to walls
  - SDCs D<sub>0</sub>, D<sub>1</sub>, and D<sub>2</sub>
  - Townhouses in SDC C

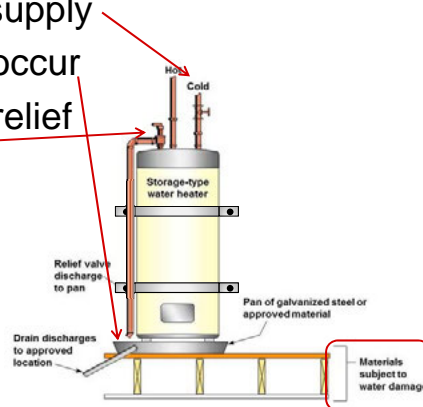



# Electrical Services

- IRC covers:
  - 120/240-volt
  - Single-phase systems
  - <400 amperes
- Main service disconnect
- Service distributes electricity to the premises wiring system
- Only one service is permitted for 1- and 2-family dwellings



# Equipment Location

- Readily accessible service disconnect
- Working space
- Light source nearby
- Spaces above and below the panel are dedicated to the electrical installation
- Not in clothes closets or bathrooms
  - Electrical panels
  - Service disconnects
  - Circuit breakers

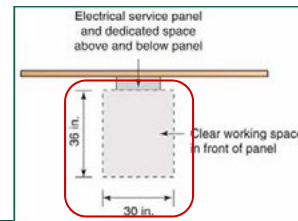
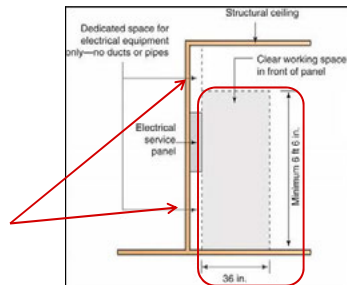

## Electrical Service Size and Rating

- Service rating
  - Minimum 100 amp for single-family dwellings
  - Minimum 60 amperes for other installations
- Ampacity of ungrounded service conductors and service rating must at least match the load served in the structure



## Grounding Electrode System

- Grounding options
  - Underground metal water pipe
  - Concrete-encased reinforcing bar (Ufer ground)
  - Approved ground rods

If a single ground rod has a resistance of >25 ohms, then a 2<sup>nd</sup> ground rod is required

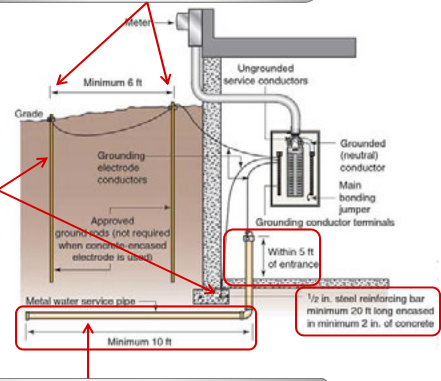

Requires at least one additional electrode



# Bonding

- Main bonding jumper at service equipment
  - Connection of the grounding system to the grounded (neutral) conductors occurs at main service disconnect
- Metal water piping must be bonded to the ground system

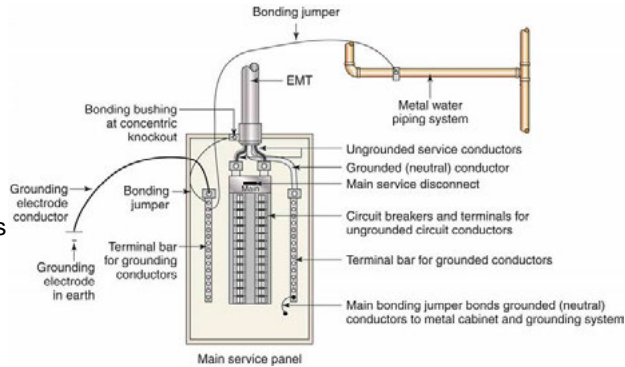

# Conductor Sizing

- Ampacity tables are provided for all wire sizes based on the material and insulation type
- When sizing wires, several variables must be considered:
  - Temperature rating of the conductor insulation
  - Derating for bundled conductors
  - Temperature rating of the terminal

Conductors	Circuit Rating		
	15 amp	20 amp	30 amp
Min. size (AWG) circuit conductors (copper)	14	12	10
Overcurrent-protection device: max. amp rating	15	20	30
Duplex or multiple outlet receptacle rating (amps)	15 max.	15 or 20	30
Single receptacle outlet minimum rating (amps)	15	20	30
Max. load (amps)	15	20	30



## Overcurrent Protection Required

- Circuit breaker or fuse is required to protect all ungrounded branch circuit and feeder conductors
- Overcurrent protective device ratings cannot exceed the allowable ampacity of the conductor

Size (AWG)	Copper	Aluminum or Copper-Clad Aluminum	
	Maximum overcurrent protection device rating (amps)	Size (AWG)	Maximum overcurrent protection device rating (amps)
14			
12			
10			

- Overcurrent devices located:
1. Where the branch circuit conductors receive their supply
  2. At the service panel (typically)
  3. So they are readily accessible
  4. Where not subject to damage
  5. Not in clothes closets or bathrooms
  6. Not located above a step



## Wiring Methods

- Cable and conductors must be approved for the location
- Typically, above-ground wiring is Type NM non-metallic cable
- Protection from physical damage
- Fasteners
  - Approved fasteners
  - Spacing
- Cable support

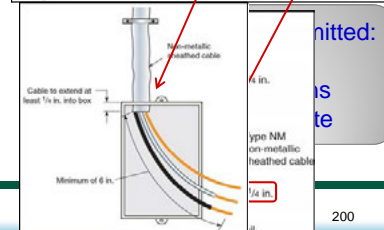
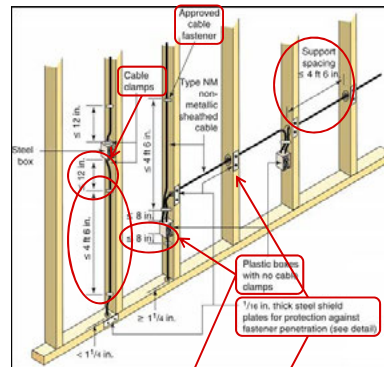

# Receptacle Outlet Locations

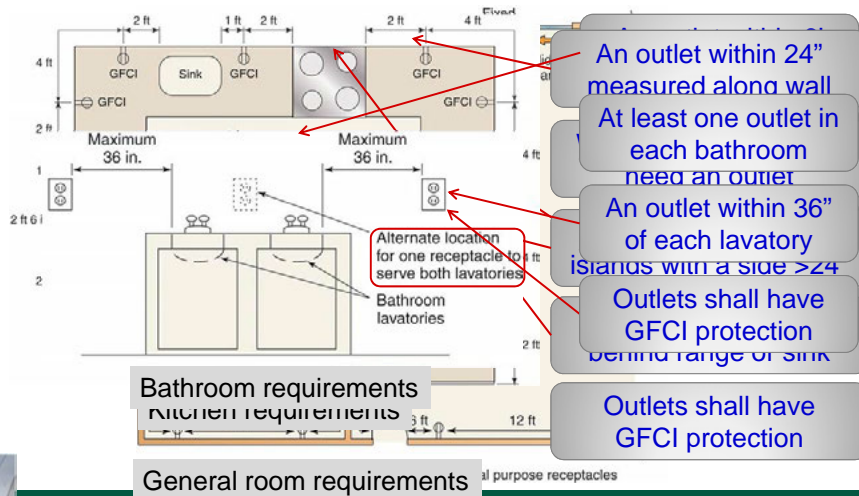

An outlet within 24" measured along wall  
At least one outlet in each bathroom need an outlet

An outlet within 36" of each lavatory  
islands with a side >24"

Outlets shall have GFCI protection  
behind range or sink

Outlets shall have GFCI protection

Bathroom requirements

kitchen requirements

General room requirements

all purpose receptacles



# Receptacle Outlet Locations

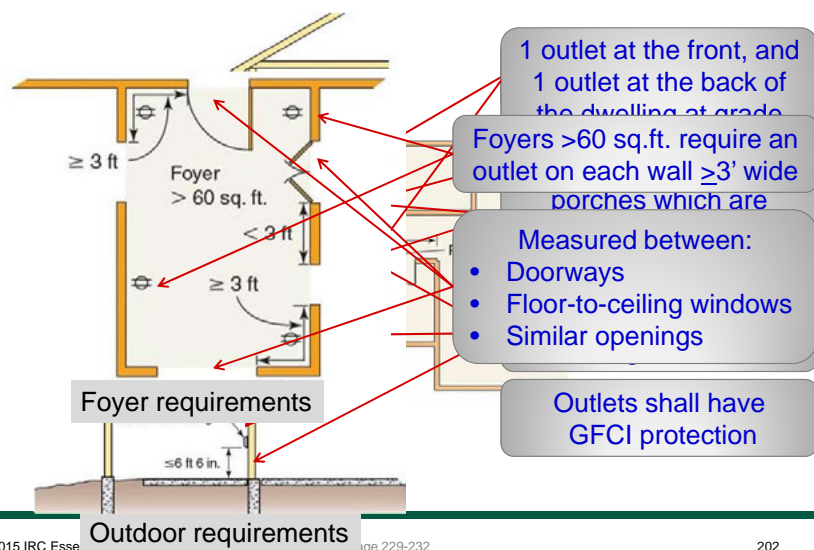

1 outlet at the front, and 1 outlet at the back of the dwelling at grade

Foyers >60 sq.ft. require an outlet on each wall >=3' wide porches which are

Measured between:

- Doorways
- Floor-to-ceiling windows
- Similar openings

Outlets shall have GFCI protection

Foyer requirements

Outdoor requirements



# Lighting Outlets

- Wall switch-controlled lighting outlet
  - Habitable rooms
  - Bathrooms
  - Hallways
  - Storage areas
  - Garages
  - Stairways
  - Outside each exterior door



# Ground-fault Circuit-Interrupter Protection (GFCI)

- GFCI protection required:
  - Bathroom
  - Kitchen counter
  - Unfinished basement
    - Except fire/burglar alarm system
  - Garage
  - <6' from sink
  - Exterior

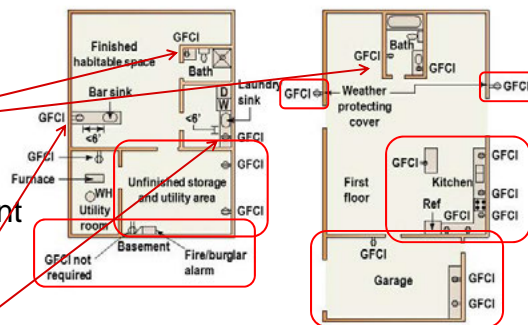

## Arc-fault Circuit Interrupter Protection (AFCI)

- AFCI devices
  - Detect unwanted arcing in the wiring of the branch circuit
  - Open the circuit before excessive heat buildup can cause a fire
- AFCI devices are installed in the service panel or subpanel
- AFCI protection required for:
  - Living areas
  - Hallways
  - Closets



2015 IRC Essentials

Workbook Page 233

205

## Receptacles

- Wet locations
  - Enclosure that is weatherproof
  - when a cord is plugged in
  - Receptacles prohibited within or
    - directly over a bathtub or shower space
- Tamper-resistant receptacle required in locations accessible to children
  - Not required when:
    - >5½' above the floor
    - Part of a luminaire or appliance
    - In a dedicated space for an appliance



2015 IRC Essentials

Workbook Page 233

206

# Luminaires in Clothes Closets

- Type of luminaires
- Minimum clearances
- Clearances are measured from the fixture to the nearest point of the defined storage space

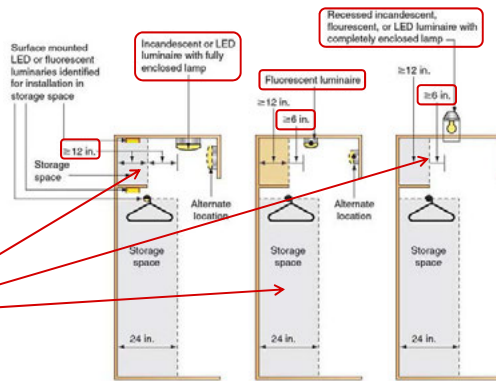

*International Code Council is a Registered Provider with The American Institute of Architects Continuing Education Systems. Credit earned on completion of this program will be reported to CES Records for AIA members. Certificates of Completion for non-AIA members are available on request.*

This program is registered with the AIA/CES for continuing professional education. As such, it does not include content that may be deemed or construed to be an approval or endorsement by the AIA of any material of construction or any method or manner of handling, using, distributing, or dealing in any material or product. Questions related to specific materials, methods, and services will be addressed at the conclusion of this presentation.





## Copyright Materials

This presentation is protected by US and International Copyright laws. Reproduction, distribution, display and use of the presentation without written permission of the speaker is prohibited.

© International Code Council 2015



## Thank you for participating

To schedule a seminar, contact:

The ICC Training & Education Department  
1-888-ICC-SAFE (422-7233) Ext. 33818

or

E-mail: [icctraining@iccsafe.org](mailto:icctraining@iccsafe.org)

