



Our Students. Their Moment.

**New York State Testing Program
Grade 6 Common Core
Mathematics Test**

Released Questions

May 2016

New York State administered the Mathematics Common Core Tests in April 2016 and is now making approximately 75% of the questions from these tests available for review and use.



New York State Testing Program Grade 3-8 Mathematics

Released Questions from 2016 Exams

Background

In 2013, New York State began administering tests designed to assess student performance in accordance with the instructional shifts and rigor demanded by the new New York State P-12 Learning Standards in Mathematics. To help in this transition to new assessments, the New York State Education Department (SED) has been releasing an increasing numbers of test questions from the tests that were administered to students across the State in the spring. This year, SED is again releasing large portions of the 2016 NYS Grade 3-8 Common Core English Language Arts and Mathematics test materials for review, discussion, and use.

For 2016, included in these released materials are at least 75 percent of the test questions that appeared on the 2016 tests (including all constructed-response questions) that counted toward students' scores. Additionally, SED is also providing a map that details what each released question measures and the correct response to each question. These released materials will help students, families, educators, and the public better understand the tests and the New York State Education Department's expectations for students.

Understanding Math Questions

Multiple-Choice Questions

Multiple-choice questions are designed to assess the New York State P-12 Learning Standards for Mathematics. Mathematics multiple-choice questions will be used mainly to assess standard algorithms and conceptual standards. Multiple-choice questions incorporate both the grade-level standards and the "Standards for Mathematical Practices." Many questions are framed within the context of real-world applications or require students to complete multiple steps. Likewise, many of these questions are linked to more than one standard, drawing on the simultaneous application of multiple skills and concepts.

Short-Response Questions

Short-response questions require students to complete tasks and show their work. Like multiple-choice questions, short-response questions will often require multiple steps, the application of multiple mathematics skills, and real-world applications. Many of the short-response questions will cover conceptual and application of the standards.

Extended-Response Questions

Extended-response questions ask students to show their work in completing two or more tasks or a more extensive problem. Extended-response questions allow students to show their understanding of mathematical procedures, conceptual understanding, and application. Extended-response questions may also assess student reasoning and the ability to critique the arguments of others.

The scoring rubric for short and extended constructed-response questions can be found in the grade-level Educator Guides at <http://www.engageny.org/resource/test-guides-for-english-language-arts-and-mathematics>.

New York State P-12 Learning Standards Alignment

The alignment(s) to the New York State P-12 Learning Standards for Mathematics is/are intended to identify the primary analytic skills necessary to successfully answer each question. However, some questions measure proficiencies described in multiple standards, including a balanced combination of procedure and conceptual understanding. For example, two-point and three-point constructed-response questions require students to show an understanding of mathematical procedures, concepts, and applications.

These Released Questions Do Not Comprise a "Mini Test"

To ensure future valid and reliable tests, some content must remain secure for possible use on future exams. As such, this document is *not* intended to be representative of the entire test, to show how operational tests look, or to provide information about how teachers should administer the test; rather, its purpose is to provide an overview of how the test reflects the demands of the New York State P-12 Learning Standards.

The released questions do not represent the full spectrum of the standards assessed on the State tests, nor do they represent the full spectrum of how the standards should be taught and assessed in the classroom. It should not be assumed that a particular standard will be measured by an identical question in future assessments. Specific criteria for writing test questions, as well as additional assessment information, are available at <http://www.engageny.org/common-core-assessments>.

Name: _____



New York State Testing Program

2016 Common Core Mathematics Test Book 1

Grade 6

April 13–15, 2016

Released Questions

Developed and published under contract with the New York State Education Department by Questar Assessment, Inc., 5550 Upper 147th Street West, Apple Valley, MN 55124. Copyright © 2016 by the New York State Education Department.

Book 1



TIPS FOR TAKING THE TEST

Here are some suggestions to help you do your best:

- Read each question carefully and think about the answer before choosing your response.
- You have been provided with mathematics tools (a ruler and a protractor) and a reference sheet to use during the test. It is up to you to decide when each tool and the reference sheet will be helpful. You should use mathematics tools and the reference sheet whenever you think they will help you to answer the question.
- Plan your time.

11

Jason has a coupon for \$2.50 off any electronic book from an online book store. If the original price, in dollars, of an electronic book is p and the discounted price, in dollars, is d , which table shows the relationship between p and d ?

A

p	3.00	4.00	5.00	6.00
d	0.50	1.50	2.50	3.50

B

p	3.00	4.00	5.00	6.00
d	5.50	6.50	7.50	8.50

C

p	3.00	4.00	5.00	6.00
d	2.50	2.50	2.50	2.50

D

p	3.00	4.00	5.00	6.00
d	7.50	10.00	12.50	15.00

GO ON

12 Which pair of expressions below are equivalent?

A $7(2x)$ and $9x$

B $3x + 5x$ and $15x$

C $4(2x - 6)$ and $8x - 24$

D $x + x + x + x$ and x^4

13 An art teacher had $\frac{2}{3}$ gallon of paint to pour into containers. If he poured $\frac{1}{8}$ gallon of paint into each container until he ran out of paint, how many containers had paint in them, including the one that was partially filled?

A 1

B 3

C 5

D 6

GO ON

14

The coordinates of point F are $(1, 0.5)$ and the coordinates of point G are $(-1, -0.5)$. Which coordinate plane below correctly shows the locations of points F and G?

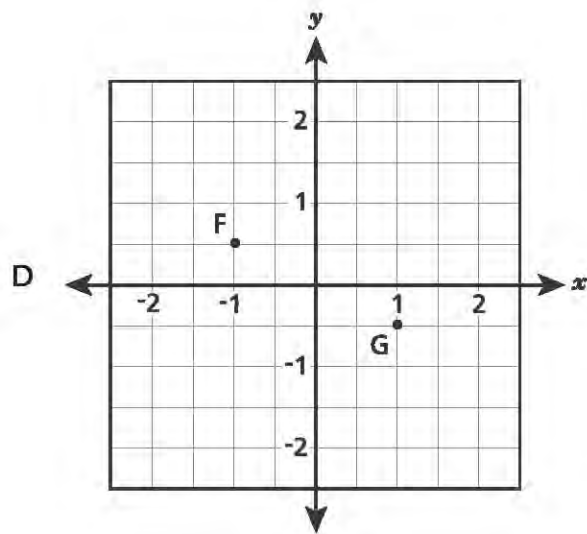
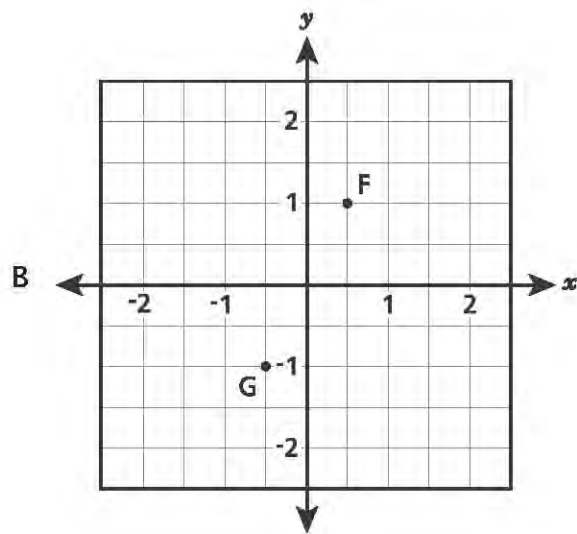
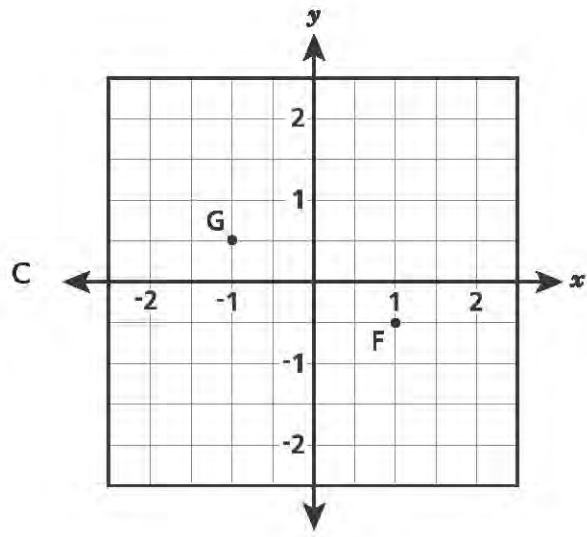
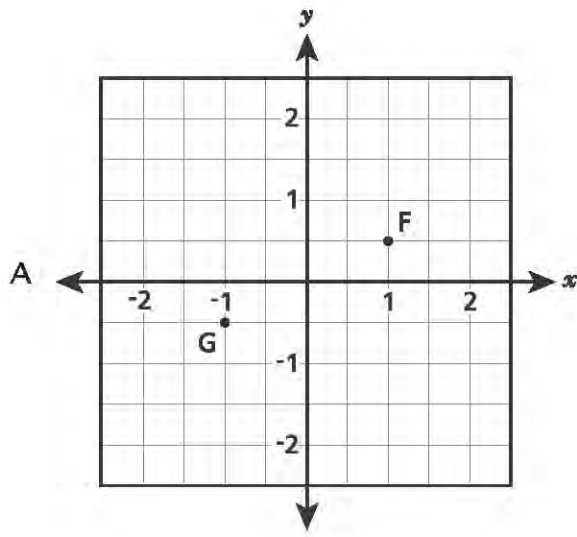

- 15 Last year, Chesa made 32 one-cup servings of soup for a school party. This year, she will make two times the amount of soup that she made last year. How many gallons of soup will Chesa make this year?

A 64
B 16
C 4
D 2

- 16 A shelf has four books on it. The weight, in pounds, of each of the four books on the shelf is listed below.

2.5, 3.2, 2.7, 2.3

Which inequality represents the weight, w , of any book chosen from the shelf?

A $w > 2.3$
B $w < 2.4$
C $w > 3.2$
D $w < 3.3$

GO ON

- 17 The area of the triangle below is $\frac{2}{5}$ square foot.

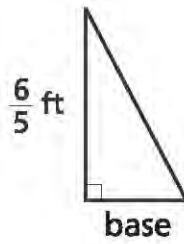

What is the length, in feet, of the base of the triangle?

- A $\frac{24}{25}$
- B $\frac{25}{24}$
- C $\frac{2}{3}$
- D $\frac{3}{2}$

- 18 Point M represents the opposite of $-\frac{1}{2}$ and point N represents the opposite of $\frac{5}{2}$. Which number line correctly shows points M and N?

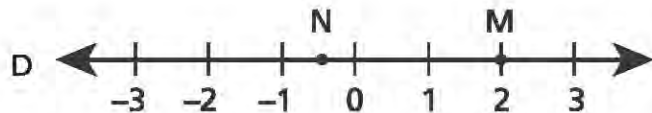
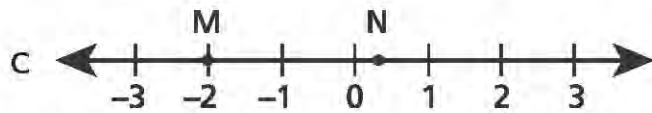
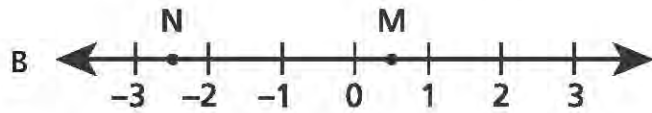
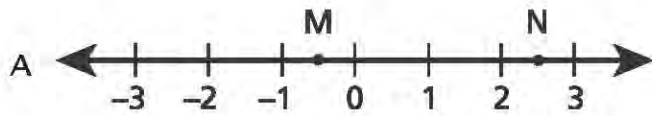

- 19 The weight of an object on the moon, m , is about $\frac{1}{6}$ of the object's weight on Earth, e . Which equation represents the approximate weight of an object on the moon in terms of the object's weight on Earth?

A $m = \frac{1}{6} + e$

B $m = \frac{e}{6}$

C $m = 6 + e$

D $m = 6e$

GO ON

20

The table below shows different possibilities for the number of games a team would need to win to maintain a certain percentage of wins.

**POSSIBLE BASEBALL
GAMES WON**

Number of Games Won	Number of Games Played
6	10
24	40
36	60
42	70

Which ratio of the number of games won to the number of games played could also be included in this table?

- A 18 : 20
- B 30 : 20
- C 18 : 30
- D 50 : 30

- 21 The table below lists the coordinates of four points.

COORDINATES

x	y
1	5
2	7
3	9
4	11

If x represents any number in the first column, which expression can always be used to find the value of y in the second column?

- A $5x$
- B $x + 2$
- C $x + 4$
- D $2x + 3$
- 22 Which expression is represented by the phrase “the square of y decreased by the quotient of 28 and 7”?

- A $\frac{28}{7} - y^2$
- B $y^2 - \frac{28}{7}$
- C $\frac{28}{7 - y^2}$
- D $\frac{28}{y^2 - 7}$

GO ON

Grade 6
2016 Common Core
Mathematics Test
Book 1
April 13–15, 2016

Name: _____



New York State Testing Program

2016 Common Core Mathematics Test Book 2

Grade 6

April 13–15, 2016

Released Questions

Developed and published under contract with the New York State Education Department by Questar Assessment, Inc., 5550 Upper 147th Street West, Apple Valley, MN 55124. Copyright © 2016 by the New York State Education Department.

Book 2



TIPS FOR TAKING THE TEST

Here are some suggestions to help you do your best:

- Read each question carefully and think about the answer before choosing your response.
- You have been provided with mathematics tools (a ruler, protractor, and calculator) and a reference sheet to use during the test. It is up to you to decide when each tool and the reference sheet will be helpful. You should use mathematics tools and the reference sheet whenever you think they will help you to answer the question.
- Plan your time.

27 A recipe for lemonade calls for 1 cup of sugar and 5 cups of water. How much sugar is used per cup of water?

A $\frac{1}{6}$ cup

B $\frac{1}{5}$ cup

C $\frac{1}{4}$ cup

D $\frac{5}{1}$ cup

28 Sam paid \$8.28 for 18 stamps. At this rate, how much would it cost Sam to buy 12 stamps?

A \$2.19

B \$2.28

C \$3.72

D \$5.52

29 John's friend told him that he could earn \$49 for handing out flyers at a local concert. John wants to calculate the hourly rate. If he works a total of 3.5 hours, the equation $3.5x = 49$ can be used to determine his hourly rate. What would John's hourly rate be, in dollars?

A \$1.40

B \$14.00

C \$45.50

D \$171.50

GO ON

- 30 Theo made sails for a model boat. He cut along the diagonal of a rectangular piece of cloth to make two sails, as shown below.

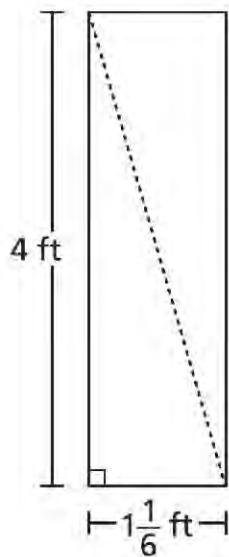

What was the area, in square feet, of one sail?

- A $9\frac{1}{3}$
- B $4\frac{2}{3}$
- C $2\frac{7}{12}$
- D $2\frac{1}{3}$

- 34 The area of an airplane's wings is related to the airplane's lifting force, which holds the airplane in the air. The table below lists several wing areas and the corresponding lifting forces.

AIRPLANE LIFTING FORCE

Area of Wings (square feet)	Lifting Force (pounds)
125	1,875
150	2,250
175	2,625
250	3,750
x	5,625
420	y

The ratio of lifting force to area is equivalent for all pairs in the table. What are the values of x and y ?

- A $x = 375$ square feet and $y = 7,500$ pounds
- B $x = 335$ square feet and $y = 7,500$ pounds
- C $x = 375$ square feet and $y = 6,300$ pounds
- D $x = 335$ square feet and $y = 6,300$ pounds

GO ON

36 Simon used 3 pears and 9 apples to make a fruit salad. What was the ratio of the number of pears to the number of apples in the fruit salad?

- A 1 : 3
- B 1 : 4
- C 1 : 6
- D 1 : 9

37 The summit of a volcano is 10 kilometers (km) above the ocean floor, as shown below.

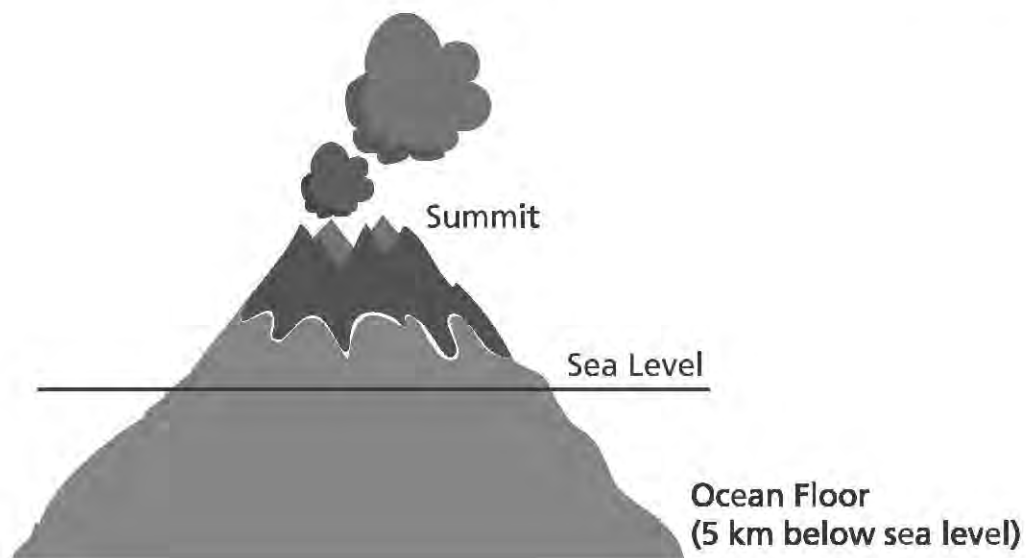

If the ocean floor has an elevation of -5 kilometers, which statement describes the elevation of sea level and the summit?

- A The elevation of sea level is 0 km and the elevation of the summit is 5 km.
- B The elevation of sea level is 5 km and the elevation of the summit is 5 km.
- C The elevation of sea level is 0 km and the elevation of the summit is 10 km.
- D The elevation of sea level is 5 km and the elevation of the summit is 10 km.

38

The Frenchtown Roller Rink charges a \$5 entrance fee and an hourly rate for roller skating. The total cost for roller skating depends on the number of hours a person skates. The table below represents the total cost of skating for different numbers of hours.

ROLLER SKATING COST

Number of Hours (h)	Total Cost in Dollars (c)
0	5
1	8
2	11
3	14
4	17

Which equation represents the relationship between the cost, c , and the number of hours, h ?

A $c = 8h$

B $c = 5h + 3$

C $c = 2h + 7$

D $c = 3h + 5$

39

Fei Yen's dog eats 8 ounces of dog food each day. Fei Yen bought a 28-pound bag of dog food. How many 8-ounce servings are in a 28-pound bag of dog food?

A 14

B 56

C 224

D 448

GO ON

40 Point A and point B are placed on a number line. Point A is located at -20 and point B is 5 less than point A. Which statement about point B is true?

- A It is located at -25 and is to the right of point A on the number line.
- B It is located at -15 and is to the right of point A on the number line.
- C It is located at -25 and is to the left of point A on the number line.
- D It is located at -15 and is to the left of point A on the number line.

41 Chakan worked at the warehouse after school. He earned \$9.25 per hour stacking boxes. Which equation correctly relates Chakan's total earnings, d , to the number of hours he worked, h ?

A $d = 9.25h$

B $h = 9.25d$

C $d = \frac{9.25}{h}$

D $h = \frac{9.25}{d}$

42

Bronson is using a coordinate plane to design a rectangular swimming pool. He will plot points on the coordinate plane to mark the vertices of the rectangular pool bottom. If Bronson plots the first three points at $(5, 3)$, $(5, 13)$, and $(30, 13)$, what would be the coordinates of the fourth point?

- A $(30, 5)$
- B $(20, 13)$
- C $(5, 28)$
- D $(30, 3)$

You may use the grid below to help you solve the problem.

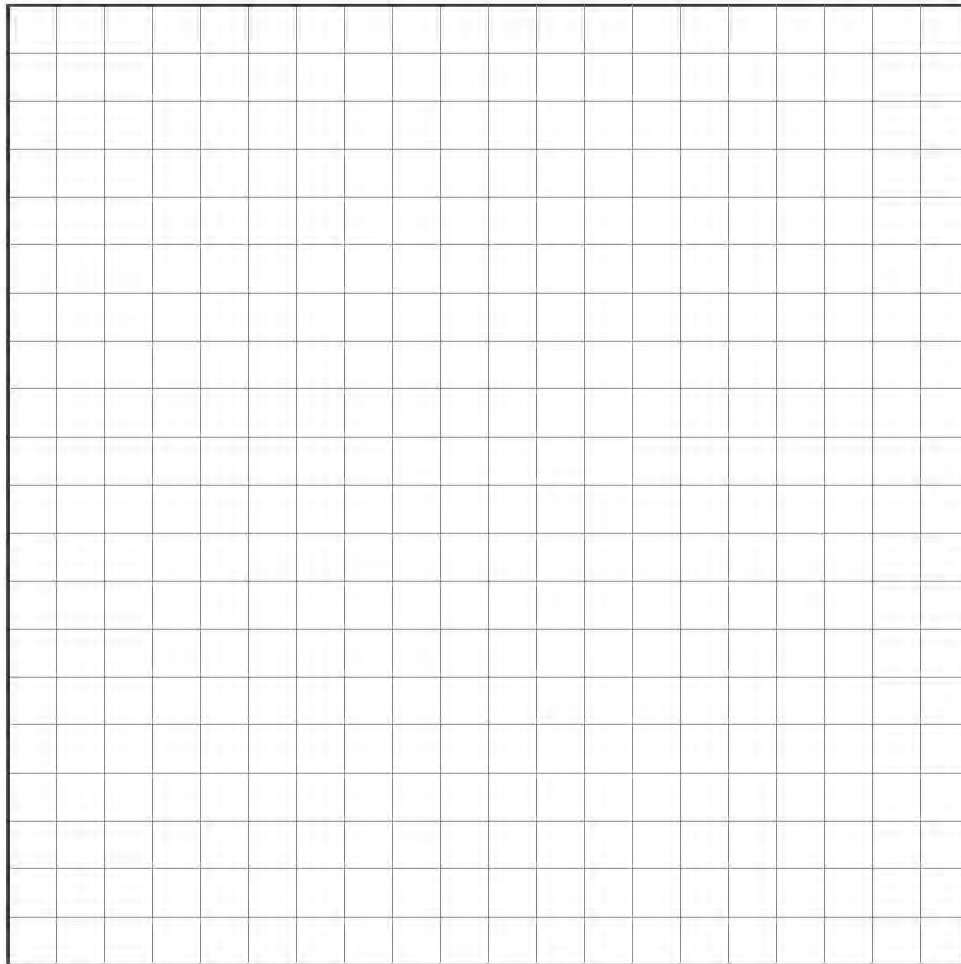

GO ON

43 Residents of a small city voted on whether to allow a developer to build a shopping center. The number of votes in favor of the shopping center was 4,400. The number of votes against the shopping center was 17,600. What percent of the voters were **in favor** of building the shopping center?

- A 20%
- B 25%
- C 40%
- D 44%

44 Maddy had a piece of ribbon that was $3\frac{1}{2}$ yards long. She used this ribbon to make bows. Each bow was made from a piece of the ribbon that was $\frac{3}{4}$ yard long. This situation can be represented by the equation $3\frac{1}{2} \div \frac{3}{4} = 4\frac{2}{3}$. Which statement **best** describes what the quotient $4\frac{2}{3}$ represents in the situation above?

- A Maddy had bows that were each $4\frac{2}{3}$ yards long.
- B Maddy had $4\frac{2}{3}$ yards of ribbon left after making the bows.
- C Maddy made 4 bows from the piece of ribbon and had $\frac{2}{3}$ of a yard left.
- D Maddy made 4 bows from the piece of ribbon and had enough left for $\frac{2}{3}$ of a bow.

- 45 The figure below shows the net of a triangular pyramid. The given height is rounded to the nearest hundredth.

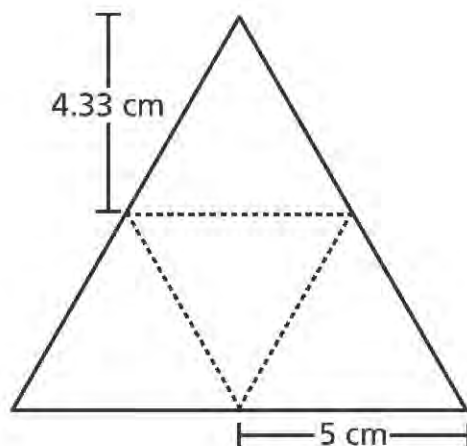

- If all the triangles are equilateral, what is the surface area of the pyramid in square centimeters?
- A 86.6
B 43.3
C 32.48
D 10.83
- 46 Zelma buys p pounds of bananas for 40 cents per pound. She pays the clerk with a twenty-dollar bill. The clerk subtracts the total cost of the bananas from the twenty-dollar bill to determine the amount of change to give Zelma.

Which expression represents the amount of change Zelma should receive?

- A $p - 20$
B $20 - 40p$
C $20 - 0.40p$
D $0.40p - 20$

GO ON

- 47 The table below lists four masses and their corresponding approximate weights on Earth.

**MASSES AND
CORRESPONDING WEIGHTS**

Mass (kilograms)	Weight (Newtons)
20	196
50	490
x	1078
130	1274
140	1372

The ratio of weight to mass is constant. Which statement describes the ratio of weight to mass and the value of x in the table?

- A The ratio is $\frac{98}{10}$; $x = 90$
- B The ratio is $\frac{98}{10}$; $x = 110$
- C The ratio is $\frac{10}{98}$; $x = 90$
- D The ratio is $\frac{10}{98}$; $x = 110$
- 48 What value of y makes the equation below true?

$$y + 2.9 = 11$$

- A 8.1
- B 8.9
- C 9.1
- D 13.9

49 A scientist studied the migration patterns of two types of whales.

- The humpback whales traveled 2,240 miles in 28 days.
- The gray whales traveled 2,368 miles in 32 days.

If the humpback whales had traveled at the same rate for 32 days, how many more miles would they have traveled than the gray whales?

- A 128
- B 192
- C 280
- D 408

GO ON

Grade 6
2016 Common Core
Mathematics Test
Book 2
April 13–15, 2016

Name: _____



New York State Testing Program

2016 Common Core Mathematics Test Book 3

Grade 6

April 13–15, 2016

Released Questions

Developed and published under contract with the New York State Education Department by Questar Assessment, Inc., 5550 Upper 147th Street West, Apple Valley, MN 55124. Copyright © 2016 by the New York State Education Department.

TIPS FOR TAKING THE TEST

Here are some suggestions to help you do your best:

- Read each question carefully and think about the answer before writing your response.
- You have been provided with mathematics tools (a ruler, a protractor, and a calculator) and a reference sheet to use during the test. It is up to you to decide when each tool and the reference sheet will be helpful. You should use mathematics tools and the reference sheet whenever you think they will help you to answer the question.
- Be sure to show your work when asked.
- Plan your time.

52

The coordinate grid below represents a town. Curtis's house is at $(-4, -6)$ and Jean's house is at $(-4, 3)$. Plot the points where Curtis's house and Jean's house are located.

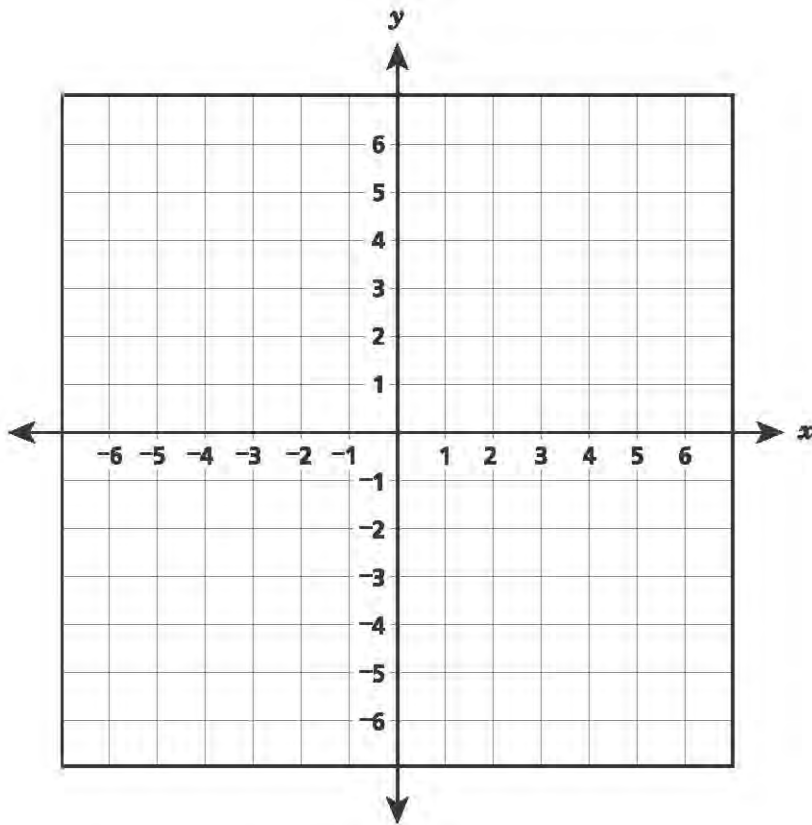

Each unit on the grid represents 1 mile. If Curtis can ride his bike at a constant rate of 12 miles per hour, how many minutes would it take Curtis to ride from his house to Jean's house?

Answer _____ minutes

GO ON

- 53 On Saturday, a minor league baseball team gave away baseball cards to each person entering the stadium. One group received 28 baseball cards. A second group received 68 baseball cards. If **each person** entering the stadium received the same number of cards, what was the **greatest** possible number of baseball cards that each person could have received?

Show your work.

Answer _____ baseball cards

GO ON

- 54 Expressions A , B , and C are shown below.

$$\begin{array}{ccc} A & B & C \\ 20^2 - 18^2 & 8(4^2) + 2^4 & 15^2 - 3^4 \end{array}$$

Which expression or expressions have the same value as 12^2 ?

Show your work.

Answer _____

GO ON

- 55 What is the area, in square centimeters, of the trapezoid below?

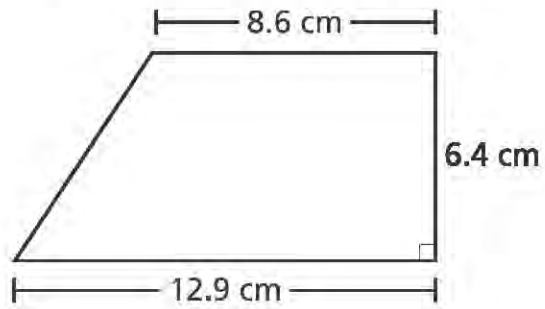

Show your work.

Answer _____ square centimeters

56

A park planner is designing a dog park. He wants to use a metal fence to enclose a kennel at the dog park. The vertices of the fence are shown below. The units on the coordinate plane are yards.

- Point A (4, - 4)
- Point B (- 4, - 4)
- Point C (- 4, 3)
- Point D (1, 3)
- Point E (1, - 1)
- Point F (4, - 1)

The park planner wants to add a gate between points A and F. He will not put metal fencing on that side. What is the total number of yards of metal fencing that will be needed for the kennel at the dog park?

Show your work.

You may use the grid below to help you solve the problem.

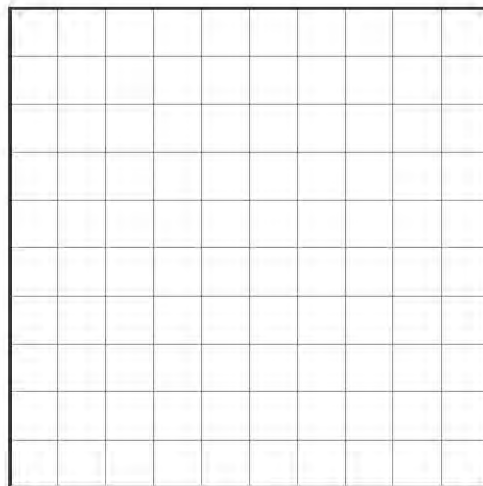

Answer _____ yards

GO ON

57

A farmer stacked hay bales. The length and width of each hay bale are shown below.

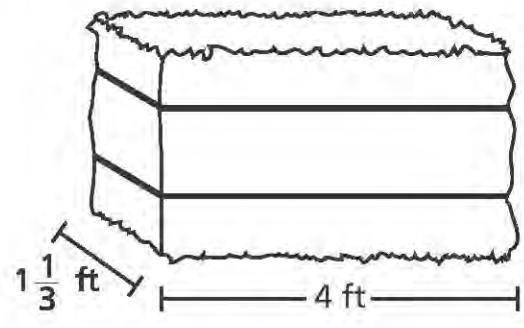

The volume of each hay bale is $10\frac{2}{3}$ cubic feet. The farmer stacked eight hay bales on top of one another. What is the height, in feet, of the stacked hay bales?

Show your work.

Answer _____ feet

GO ON

58

A square with one side length represented by an expression is shown below.

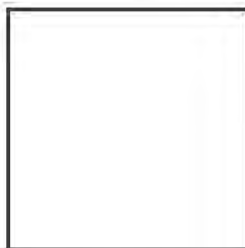

$$6(3x + 8) + 32 + 12x$$

Use the properties of operations to write three different equivalent expressions to represent the lengths of the other three sides of the square. One of your expressions should contain only two terms.

Show your work.

Answer

GO ON

59

A carpenter built three bookcases, A, B, and C, to stand next to each other along a wall. The total length of the wall is 456 centimeters. The carpenter will build two more bookcases, D and E, along the same wall. These two bookcases will have equal widths. The widths of bookcases A, B, and C are shown in the table below.

WIDTHS OF BOOKCASES

Bookcase	Width (centimeters)
A	132
B	94
C	108
D	w
E	w

Write and solve an equation to determine w , the greatest possible width for bookcases D and E.

Show your work.

Answer $w =$ _____ centimeters

GO ON

- 60 Darnell's car used 8 gallons of gasoline to travel 340 miles. After a mechanic worked on the car, it used 7 gallons of gasoline to travel 350 miles. If the price of gasoline was approximately \$4.00 per gallon, how much less, to the nearest cent per mile, did it cost to run the car after the mechanic worked on it?

Show your work.

Answer _____ cent(s) per mile

GO ON

61

The circus had one performance at the Dewey Civic Center and one at the Atlantic Auditorium. The Dewey Civic Center has 1,600 seats. Tickets for 85% of the total number of seats were sold. How many tickets were sold?

Show your work.

Answer _____ tickets

Atlantic Auditorium has 850 seats. Tickets were sold for 816 of the seats. For what percent of the seats were tickets sold?

Show your work.

Answer _____ %

STOP

Place Student Label Here

Grade 6
2016 Common Core
Mathematics Test
Book 3
April 13–15, 2016

THE STATE EDUCATION DEPARTMENT
THE UNIVERSITY OF THE STATE OF NEW YORK / ALBANY, NY 12234

Grades 3-8 Mathematics Tests Map to the Standard

Grade 6 Released Questions Available on EngageNY

Question	Type	Points	Key	Standard	Cluster	Secondary Standard(s)
Book 1						
11	Multiple Choice	1	A	6.EE.C.9	Expressions And Equations	
12	Multiple Choice	1	C	6.EE.A.4	Expressions And Equations	
13	Multiple Choice	1	D	6.NS.A.1	The Number System	
14	Multiple Choice	1	A	6.NS.C.6c	The Number System	
15	Multiple Choice	1	C	6.RP.A.3d	Ratios And Proportional Relationships	
16	Multiple Choice	1	D	6.EE.B.8	Expressions And Equations	
17	Multiple Choice	1	C	6.NS.A.1	The Number System	6.G.A.1
18	Multiple Choice	1	B	6.NS.C.6a	The Number System	6.NS.C.6c
19	Multiple Choice	1	B	6.EE.C.9	Expressions And Equations	
20	Multiple Choice	1	C	6.RP.A.3a	Ratios And Proportional Relationships	
21	Multiple Choice	1	D	6.EE.B.6	Expressions And Equations	
22	Multiple Choice	1	B	6.EE.A.2a	Expressions And Equations	
Book 2						
27	Multiple Choice	1	B	6.RP.A.2	Ratios And Proportional Relationships	
28	Multiple Choice	1	D	6.RP.A.3b	Ratios And Proportional Relationships	
29	Multiple Choice	1	B	6.EE.B.7	Expressions And Equations	6.RP.A.3b
30	Multiple Choice	1	D	6.G.A.1	Geometry	
34	Multiple Choice	1	C	6.RP.A.3a	Ratios And Proportional Relationships	
36	Multiple Choice	1	A	6.RP.A.1	Ratios And Proportional Relationships	6.RP.A.3
37	Multiple Choice	1	A	6.NS.C.5	The Number System	
38	Multiple Choice	1	D	6.EE.C.9	Expressions And Equations	
39	Multiple Choice	1	B	6.RP.A.3d	Ratios And Proportional Relationships	

Grade 6 Math Released Questions Available on EngageNY
Continued

40	Multiple Choice	1	C	6.NS.C.7a	The Number System	
41	Multiple Choice	1	A	6.EE.C.9	Expressions And Equations	
42	Multiple Choice	1	D	6.G.A.3	Geometry	6.NS.C.6c
43	Multiple Choice	1	A	6.RP.A.3c	Ratios And Proportional Relationships	
44	Multiple Choice	1	D	6.NS.A.1	The Number System	
45	Multiple Choice	1	B	6.G.A.4	Geometry	
46	Multiple Choice	1	C	6.EE.A.2a	Expressions And Equations	
47	Multiple Choice	1	B	6.RP.A.3a	Ratios And Proportional Relationships	6.RP.A.1
48	Multiple Choice	1	A	6.EE.B.5	Expressions And Equations	6.NS.B.3
49	Multiple Choice	1	B	6.RP.A.3b	Ratios And Proportional Relationships	6.RP.A.2
Book 3						
52	Constructed Response	2	n/a	6.NS.C.8	The Number System	6.RP.A.3
53	Constructed Response	2	n/a	6.NS.B.4	The Number System	
54	Constructed Response	2	n/a	6.EE.A.1	Expressions And Equations	
55	Constructed Response	2	n/a	6.G.A.1	Geometry	6.NS.B.3
56	Constructed Response	2	n/a	6.NS.C.8	The Number System	6.G.A.3
57	Constructed Response	2	n/a	6.G.A.2	Geometry	6.EE.A.2c
58	Constructed Response	3	n/a	6.EE.A.3	Expressions And Equations	
59	Constructed Response	3	n/a	6.EE.B.7	Expressions And Equations	
60	Constructed Response	3	n/a	6.RP.A.2	Ratios And Proportional Relationships	
61	Constructed Response	3	n/a	6.RP.A.3c	Ratios And Proportional Relationships	

Note: this item map is intended to identify the primary analytic skills necessary to successfully answer each question. However, some questions measure proficiencies described in multiple standards, including a balanced combination of procedural and conceptual understanding.