

NISTIR 7417

General Buildings Information Handover Guide: Principles, Methodology and Case Studies

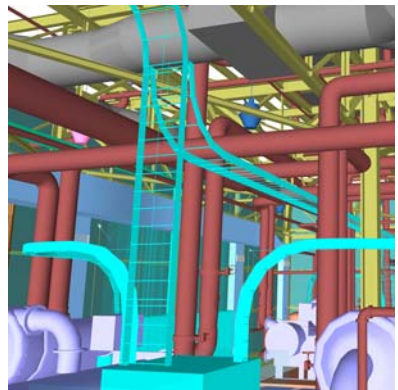
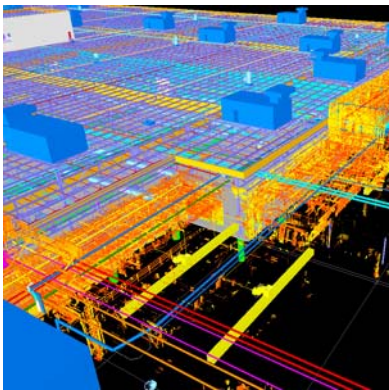
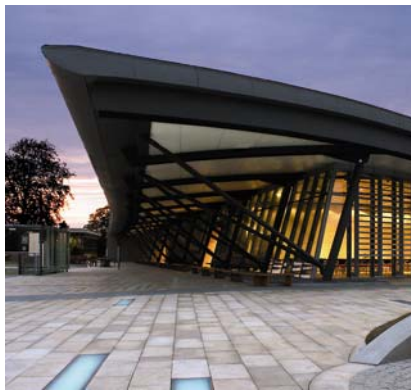
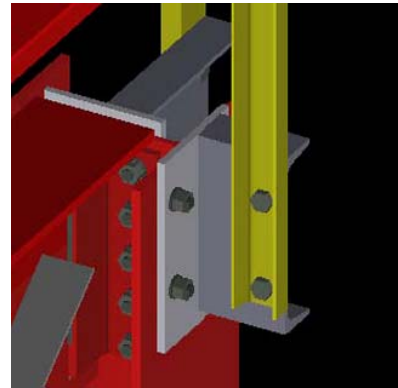
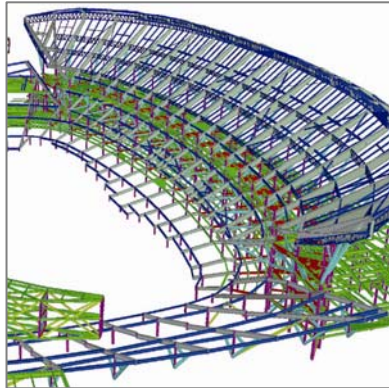

Project Leaders:
Kristine K. Fallon
Mark E. Palmer

In Cooperation with:
FIATECH

FIATECH

NIST
National Institute of
Standards and Technology
U.S. Department of Commerce

NISTIR 7417

General Buildings Information Handover Guide: Principles, Methodology and Case Studies

An Industry Sector Guide of the Information Handover Guide Series

Kristine K. Fallon
Kristine Fallon Associates, Inc.

Mark E. Palmer
*Building and Fire Research Laboratory
NIST*

August 2007



U.S. DEPARTMENT OF COMMERCE
Carlos M. Gutierrez, Secretary
NATIONAL INSTITUTE OF STANDARDS AND TECHNOLOGY
William Jeffrey, Director

Acknowledgments

This document is the result of a number of organizations and individuals cooperating to define information strategies, analyze case studies and document the benefits and pitfalls of electronic information handover in the general buildings sector. The individuals listed below contributed to this work.

General Buildings Advisory Panel

Joseph Burns	Thornton Tomasetti
Rob Dibble	CH2M Hill
Joseph Dietrich	American Institute of Steel Construction
Bill East	U.S. Army Corps of Engineers, Engineer Research and Development Center
Samir Emdanat	GHAFAFI
Luke Faulkner	American Institute of Steel Construction
Stephen Hagan	General Services Administration
Robert Mauck	GHAFAFI
Alex Maxim	NBBJ
David McLean	Thornton Tomasetti, Inc.
Tony Rinella	Anshen+Allen, Architects
Darren Rizza	Skidmore, Owings & Merrill LLP
Dana K. Smith	DKS Information Consulting, LLC

Other Industry Sources

Charles Eastman	Georgia Institute of Technology, Design Computing Group
Richard Jackson	FIATECH
Laird Landis	General Motors

Industry Reviewers

Jim Forester	Newforma, Inc.
Charles Hardy	General Services Administration
Peggy Ho	General Services Administration
Calvin Kam	General Services Administration
Robert Lipman	National Institute of Standards and Technology
Nicholas Nisbet	AEC3
Kent Reed	National Institute of Standards and Technology
Stacy Scopano	Tekla
Richard See	Digital Alchemy
Jeffrey Wix	AEC3

Disclaimer:

Certain trade names or company products are mentioned in the text to specify adequately the procedures and software used. In no case does such identification imply recommendation or endorsement by the National Institute of Standards and Technology, nor does it imply that the software is the best available for the purpose.

TABLE OF CONTENTS

EXECUTIVE SUMMARY	1
1. WHY AN INFORMATION HANDOVER GUIDE?	3
1.1 Advances in Information Technology	3
1.2 Business Case for the Use of Interoperable Building Information Models	3
1.3 Examples of Benefits	4
1.3.1 Daylight and Energy Analysis	5
1.3.2 Cost Analysis	5
1.3.3 Supply Chain Integration	6
1.3.4 3D Coordination	7
1.3.5 Handover to Operations and Maintenance	7
1.3.5.1 IFC Model Based Operations and Maintenance	7
1.3.5.2 Construction Operations Building Information Exchange	8
1.4 Challenges to Achieving Benefits	8
2. GENERAL BUILDINGS INDUSTRY BACKGROUND	10
2.1 Handover Process	10
2.2 Current Process	10
2.2.1 Schematic Design	11
2.2.2 Design Development	11
2.2.3 Construction Documents	11
2.2.4 Bid Phase	11
2.2.5 Construction Phase	11
2.2.6 Closeout/ Commissioning	12
2.2.7 Operations and Maintenance	12
2.3 Changes in Project Delivery	12
2.3.1 Design Optimization	13
2.3.2 Construction Optimization	14
2.3.3 Construction Orchestration	14
2.3.4 Operations and Maintenance	14
2.4 Industry Roadmaps for Implementing Change	15
2.4.1 Steps Toward External Process Integration	16
2.4.2 FIATECH Capital Projects Technology Roadmap	16
2.4.3 ROADCON Roadmap	18
2.4.4 Roadmaps from Multiple Organizations Compared	19
3. KEY CONCEPTS AND TERMS	21
3.1 Interoperability	21
3.2 Information Forms and Formats	22

3.2.1	Unstructured Form	22
3.2.2	Structured Form	22
3.2.3	Proprietary Format	23
3.2.4	Standard Format	23
3.3	Using Standard Structured Formats	24
3.3.1	Defining Model Views	25
3.3.1.1	BLIS	25
3.3.1.2	GSA	26
3.3.1.3	NBIMS	26
3.3.1.4	COBIE	26
3.3.1.5	CIS/2 – IFC Harmonization	26
3.3.1.6	Information Delivery Manuals	27
3.3.1.7	IFC Model View Definition Toolset and Process	28
3.3.2	Other Standard Structured Formats	28
3.3.2.1	AEX	28
3.3.2.2	AGCxml	29
3.3.2.3	gbXML	29
3.3.2.4	ifcXML	29
3.3.2.5	OSCRE	29
3.3.2.6	OGC	29
3.3.3	Additional Information Sources	30
3.4	Classification, Metadata and Dictionaries	30
3.4.1	Classification	30
3.4.2	Metadata	30
3.4.2.1	Descriptive Metadata	30
3.4.2.2	Administrative Metadata	30
3.4.2.3	Structural Metadata	31
3.4.2.4	Standards for Metadata	31
3.4.3	Dictionaries	31
4.	CASE STUDIES OF INFORMATION HANDOVER	32
4.1	Helsinki University of Technology Auditorium Hall 600	32
4.1.1	Benefits Realized	32
4.1.2	Who Benefited	33
4.1.3	Information Packages Exchanged	33
4.1.4	Issues Identified	35
4.1.5	Recommendations for Future Efforts	35
4.2	General Motors Virtual Factory Initiative	35
4.2.1	Benefits Realized	36
4.2.2	Who Benefited	36
4.2.3	Information Packages Exchanged	36
4.2.4	Issues Identified	39
4.2.5	Recommendations for Future Efforts	39
4.3	The Adaptive Re-Use of Soldier Field	39
4.3.1	Benefits Realized	40
4.3.2	Information Packages Exchanged	40
4.3.3	Issues Identified	42
4.3.4	Recommendations for Future Efforts	42
4.4	Harborview Medical Center Expansion	42

4.4.1	Benefits Realized	43
4.4.2	Information Packages Exchanged	43
4.4.3	Issues Identified	45
4.4.4	Recommendations for Future Efforts	45
4.5	Wellcome Trust, UK	45
4.5.1	Benefits Realized	46
4.5.2	Information Packages Exchanged	46
4.5.3	Issues Identified	48
4.5.4	Recommendations for Future Efforts	48
4.6	Buckley Army Aviation Support Facility	48
4.6.1	Benefits Realized	49
4.6.2	Who Benefited	49
4.6.3	Information Packages Exchanged	49
4.6.4	Issues Identified	51
4.6.5	Recommendations for Future Efforts	51
5.	PLANNING, EXECUTING AND MANAGING INFORMATION HANDOVERS	52
5.1	Overview	52
5.2	Information Strategies	53
5.2.1	Information Strategies for the General Buildings Sector	53
5.2.2	Contents of the Information Strategy	55
5.3	Information Handover Requirements	56
5.3.1	Applying an Existing Standard	56
5.3.2	Uses of Information Packages	56
5.4	Project Information Handover Plan	58
5.4.1	Developing the Project Information Handover Plan	58
5.4.2	From General to Specific	58
5.4.3	Balancing Costs and Benefits	59
5.4.4	Handover Plan Contents	60
5.4.5	Information Quality Considerations	60
5.4.6	Information Quality Management	61
5.4.7	Logistics	62
5.4.8	New Project Roles	62
5.4.9	Handover Methods	62
5.4.10	Data Transfer Methods	63
5.4.11	Timing	63
5.4.12	Responsibilities	63
5.4.13	Storing and Preserving Handover Information	64
5.5	Implementation of the Project Information Handover	64
5.5.1	Business Considerations	64
5.5.1.1	Project Information Manager	65
5.5.1.2	Contractual Terms	66
5.5.1.3	Liability and Insurance	66
5.5.2	Technical Implementation	66
5.5.2.1	Configuration Management	67
5.5.2.2	Testing	67
5.5.2.3	Documentation of Best Practices and Project Procedures	67
5.5.2.4	Staffing and Training	67

5.5.2.5	Compliance Checking	68
5.5.2.6	Continuous Improvement Program	68
5.6	Handover Lessons Learned By Early Adopters	68
5.6.1	Challenges	68
5.6.1.1	Commercial Issues	68
5.6.1.2	Expectations	68
5.6.1.3	Change Management	68
5.6.1.4	Immature Technology	69
5.6.1.5	Inadequate Technology Infrastructure	69
5.6.2	Keys to Success	69
5.6.2.1	Human Factors	69
5.6.2.2	Quality of Collaboration	69
6.	CONCLUSION AND RECOMMENDATIONS FOR FUTURE EFFORTS	70
7.	APPENDICES	72
7.1	APPENDIX A – Benefits Chart	72
7.2	APPENDIX B – Glossary	75
7.3	APPENDIX C – Bibliography	80
7.4	APPENDIX D – Links to Information Delivery Specifications and Standards	83
7.5	APPENDIX E – Organizations that Promote Interoperability	88

Executive Summary

The 2004 Construction Users Roundtable (CURT) report, *Collaboration, Integrated Information and the Project Life Cycle in Building Design, Construction and Operation (WP-1202)*, makes clear that there is a compelling need to improve project delivery. “Building owners, particularly those represented within CURT, regularly experience project schedule and cost overruns.” The National Institute of Standards and Technology (NIST) study *Cost Analysis of Inadequate Interoperability in the U.S. Capital Facilities Industry (NIST GCR 04-867)* makes clear that all stakeholders in the capital facilities industry – designers, contractors, product suppliers and owners – are wasting a huge amount of money looking for, validating and/or recreating facility information that should be readily available. For example, the study estimated that operations and maintenance personnel spent US \$4.8 billion during 2002, verifying that documentation accurately represented existing conditions, and another US \$613 million transferring that information into a useful format.

These are two major business drivers that are leading the general buildings industry to adopt a more advanced technological approach to designing, documenting and constructing capital facilities. It is clear from the case studies assembled for this guide and from the input of the General Buildings Advisory Panel that these advanced technologies are yielding the desired results.

So far, major successes have been recorded using highly accurate and complete 3D building models for interference checking and linking to construction schedules. These successes can be attributed to the relative maturity of 3D modeling and viewing technology as well as the availability of tools for accurately translating geometry between proprietary formats and for merging 3D models created in multiple formats in an integration environment.

Some progress has also been made in the area of **intelligent** building modeling, which captures the properties of building components as well as their geometry, permitting direct, machine-interpretable input to other applications, such as analysis programs. A major success in this regard has been the American Institute of Steel Construction’s (AISC) CIMSteel Integration Standards/Version 2 (CIS/2) initiative, which has proven to enhance the quality and speed of information flow throughout the steel supply chain.

Because design and construction operations in the general buildings industry are carried out by project teams comprising multiple organizations, data interoperability across a heterogeneous software landscape is necessary. In order for that interoperability to be achieved, the domain experts in the general buildings industry must reach a consensus on key information-supported work processes and the information required by those processes. Data modeling experts must then develop specifications for how the information should be encoded using structured data standards such as the International Alliance for Interoperability (IAI) Industry Foundation Classes (IFCs). Finally, these specifications must be implemented in commercial software and test cases must be created to determine if software implementations comply with these data exchange specifications.

Recently, a great deal of work has been done to define methodologies and tools for documenting the information requirements of design, construction and facility management processes. Major initiatives in this regard include IAI buildingSMART and the U.S. National Building Information Modeling Standard (NBIMS). There are also efforts on roadmaps for the adoption of building information modeling, e.g., FIATECH, the European Commission, the Associated General Contractors of America, the U.S. General Services Administration (GSA), U.S. Coast Guard, U.S. Army Corps of Engineers, as well as in Denmark, Finland, Norway and Singapore. Leaders in the industry are adopting value stream mapping and information flow analysis. These are the first steps in creating the ability to streamline information flow through each business process while at the same time maintaining and improving the ability to share information between business processes. Research shows that these actions contribute to successful building projects.

For the industry and users of information systems, this is a period of both promise and peril. There are compelling business cases for moving forward with these advanced technologies, but many stumbling blocks remain. The purpose of this guide is to assist users and developers of building information and information systems in the general buildings industry in making good use of advanced technology and avoiding the pitfalls, particularly those encountered in information handovers between parties. To this end, the guide discusses the general buildings industry's need for such assistance, offers background information on the industry's traditional and emerging business processes, provides a primer on the technology concepts and terminology and presents six case studies of the use of advanced design and construction technologies and the attendant information handovers. The guide then elucidates a methodology, developed in its companion publication, the *Capital Facilities Information Handover Guide (CFIHG) Part 1*, for achieving successful and cost-effective information handovers in a heterogeneous environment. It suggests a hybrid approach combining data exchanges in proprietary and standard formats to meet the different requirements of enterprises. The final section offers analysis of the state of the technology and recommendations for the next steps.

1. Why an Information Handover Guide?

Since the late 1990's, there has been increasing pressure on the global capital facilities industry to perform more efficiently. The National Institute of Standards and Technology's (NIST) study, *Cost Analysis of Inadequate Interoperability in the U.S. Capital Facilities Industry* (referred to as **NIST GCR 04-867**) identified and quantified the efficiency losses in the U.S. capital facilities industry attributable to inadequate interoperability. Interoperability is defined as "the ability to manage and communicate electronic product and project data between collaborating firms and within individual companies' design, construction, maintenance, and business process systems." The researchers very conservatively estimated those losses to be US \$15.8 billion in 2002. This figure excludes the losses for residential facilities and transportation infrastructure.

1.1 Advances in Information Technology

At the same time, the early years of the 21st century heralded the introduction of a new generation of software to the general buildings industry. This new generation of software is capable of producing an intelligent building description, or Building Information Model (BIM). Although the BIM concept is not new, technology advances have made it commercially feasible. According to the U.S. National Institute of Building Sciences (NIBS), "Building Information Modeling (BIM) is a digital representation of physical and functional characteristics of a facility. A BIM is a shared knowledge resource for information about a facility forming a reliable basis for decisions during its life-cycle; defined as existing from earliest conception to demolition. A basic premise of BIM is collaboration by different stakeholders at different phases of the life cycle of a facility to insert, extract, update or modify information in the BIM to support and reflect the roles of that stakeholder."

From the perspective of this guide, there are two important aspects of BIM:

1. The single, non-redundant information repository supports a broad range of activities in the building life cycle, including design, analysis, cost estimating, procurement, detailing, construction simulation, construction/ erection, maintenance and operation. Interoperability is a non-negotiable requirement of such a data store.
2. Managing models of this size and complexity cannot be done manually. Thus, BIM data must be structured data, capable of machine-interpretation.

1.2 Business Case for the Use of Interoperable Building Information Models

Based on the experience of early adopters, the use of interoperable building information models:

- Speeds informed design decision-making
- Permits rapid iteration of simulations of building performance and construction sequencing
- Streamlines information flow and reduces time-to-complete in certain supply chains, e.g., steel
- Substantially reduces field problems and material waste during construction

- Makes feasible the off-site fabrication in controlled environments of larger percentages of the building components and assemblies, increasing their quality and longevity, and
- Reduces on-site construction activities and materials staging, creating a less crowded and safer site.

In addition, key owners have recognized the potential for capturing the information needed to fine-tune building system performance, establish appropriate maintenance practices and schedules and evaluate the feasibility of proposed expansions or renovations.

Thus, the adoption of this approach holds benefits for all stakeholders in the full facility life cycle and improves outcomes in three major dimensions of performance: cost, schedule and quality.

Recognizing this, the Construction Users Roundtable (CURT), the Associated General Contractors of America (AGC) and the American Institute of Architects (AIA) established a collaborative working group, the 3xPT Strategy Group, in 2006. The group promotes efforts across traditional industry stakeholder boundaries to leverage the use of 3D, 4D (time) and 5D (cost) modeling and other intelligent technologies. CURT, AGC, and AIA have joined together to work with the industry as a whole to help shape the future as it relates to using available technology, collaborating to the fullest extent and maximizing project productivity.

3xPT's charter is to be a credible voice representing the collaboration of constructors, designers and owners on matters regarding industry process transformation. It carries a vision of a transformed and sustainable construction industry, where each project is designed, developed and delivered to optimize value across its life cycle. 3xPT sees its mission as creating transformational strategies and developing implementation frameworks that:

- Define value sets or criteria
- Engage all stakeholders
- Promote open sharing of information
- Communicate benefits of transformed industry processes

1.3 Examples of Benefits

Appendix A outlines the benefits of BIM throughout different stages of the life cycle of a capital facility, including which specific parties benefit at each stage.

Time and quality benefits during design were documented in a pilot conducted by a collaborative team including Anshen+Allen, Architects, Lawrence Berkeley National Laboratory (LBNL) and Webcor Builders. The focus was in two areas: energy performance and construction costs, which are important and sometimes competing considerations in the design of the building enclosure. The BIM-based collaboration was performed in parallel with a more traditional project documentation and analysis approach used to deliver the project to the client. This provided an opportunity to compare experiences and quantify efficiencies. The team achieved compelling results demonstrating significant efficiency gains through use of interoperable virtual design tools.

1.3.1 Daylight and Energy Analysis

Following the traditional process, the architect forwarded 2D electronic drawings to the façade engineer who interpreted the design documents, constructed a 3D model, analyzed performance, wrote a narrative predicting the performance of the proposed design and also suggested strategies for improvement. The results were presented to the architects in two weeks. Working with the architect's BIM published in the International Alliance for Interoperability's (IAI) Industry Foundation Class (IFC) format, the team at LBNL applied a simulation program, and reported preliminary results the next day. Following design changes, LBNL provided energy and daylight analysis including performance graphs and shading illustrations of the new configuration in two days (see Figure 1-1).

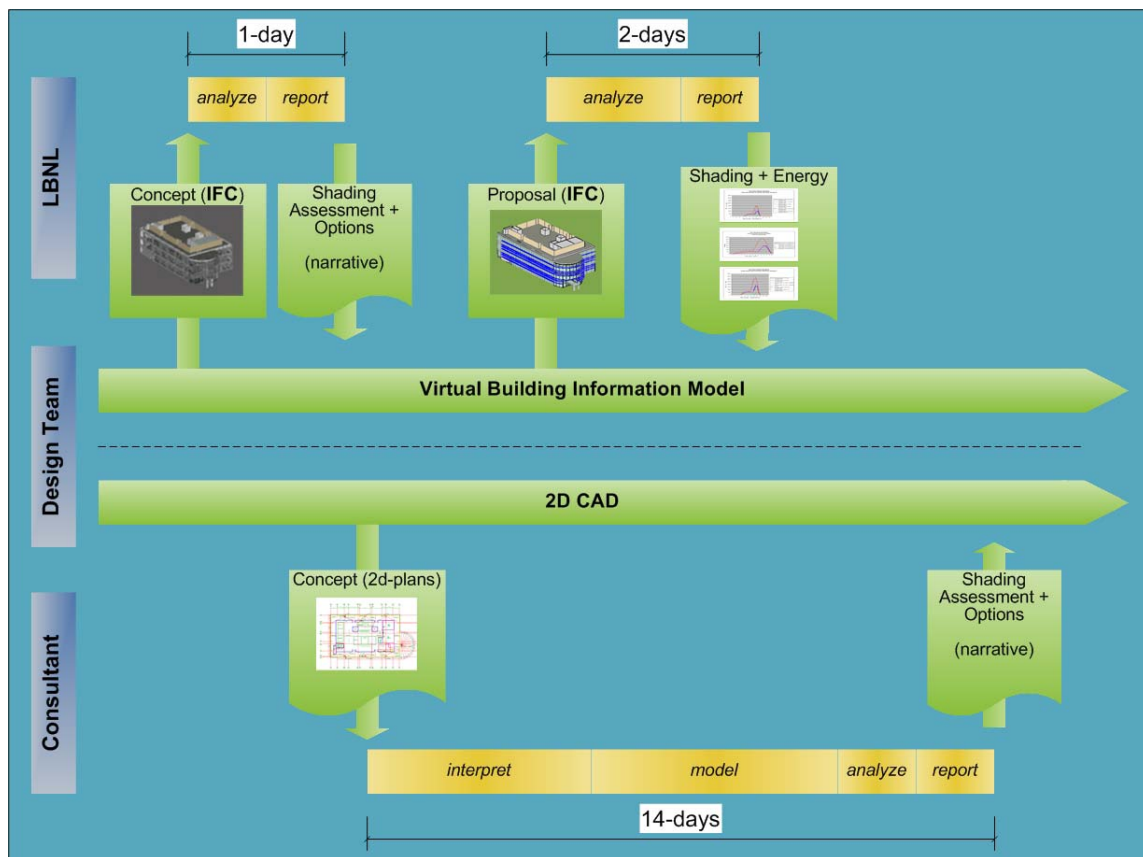

Figure 1-1: Medical Clinic Solar Analysis – Traditional vs. Information Handover Process (Courtesy Tony Rinella, Anshen+Allen, Architects)

1.3.2 Cost Analysis

Using the traditional 2D-based process, the cost consultant delivered a cost estimate three weeks after the architect provided design concept drawings. The virtual building process with Webcor Builders differed in two important aspects. Initially, Webcor Builders generated a preliminary cost estimate by extracting quantities directly from the Anshen+Allen, Architects BIM. They also provided the architect with specific building elements including curtain wall assemblies, columns and floor slabs which were associated directly with their internal proprietary cost

history database. With known components and assemblies incorporated in the BIM, they were able to provide preliminary cost estimates of two design alternatives in one day (see Figure 1-2).

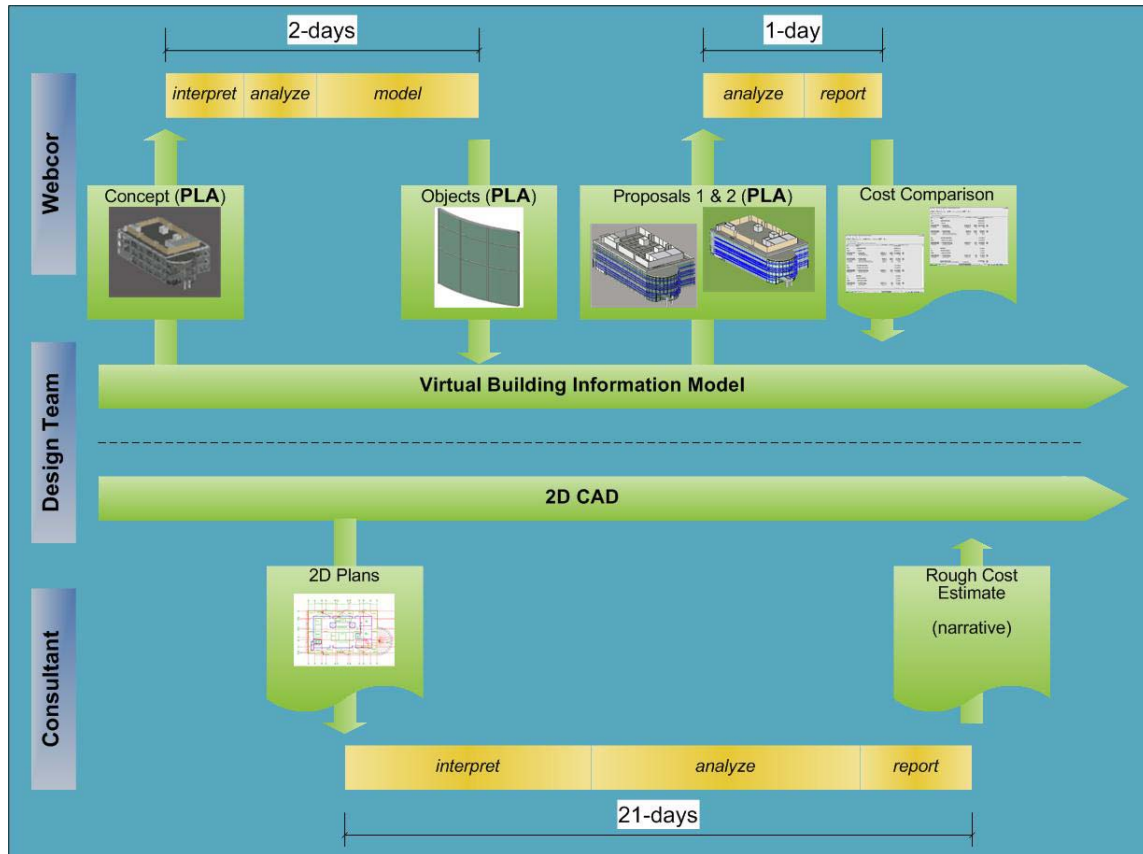

Figure 1-2: Medical Clinic Cost Analysis – Traditional vs. Information Handover Process (Courtesy Tony Rinella, Anshen+Allen, Architects)

The interoperable BIM supported rapid, reliable analysis of design options and encouraged new forms of collaboration between team members. Use of interoperable tools dramatically decreased the wasteful rework required to move models between design and analysis systems and provided more detailed and actionable feedback from those analyses.

1.3.3 Supply Chain Integration

Benefits can also be distributed throughout the supply chain. A leader in this approach is the American Institute of Steel Construction (AISC), which in 1999 launched and funded a multi-year initiative to promote Electronic Data Interchange (EDI) throughout the structural steel industry and thus improve the competitiveness of the material by reducing schedule time needed to get steel in place. AISC built on the work of the European CIMsteel initiative (1987-1998), adopting CIMsteel Integration Standard, Release 2 (CIS/2) for the exchange of structured information for 3D modeling, analysis, interference/ clash detection, detailing, fabrication, erection, procurement, construction planning and scheduling. AISC has also been active in documenting the benefits of EDI.

An early and impressive success story was the Soldier Field reconstruction project. Structural engineers Thornton-Tomasetti undertook a 3D modeling approach with electronic information handovers throughout the steel supply chain to enable the stadium's construction to be completed 17 percent faster than industry best performance. The 3D steel model was used for validating the steel geometry and identifying interferences with other building systems during design, providing quantity take-offs during the bidding phase, being updated with connection design and detailing and passed to Computerized Numerical Control (CNC) fabrication processes. It was also used in digital surveying equipment to position steel during construction.

AISC has documented several projects where the schedule has been compressed through the use of similar electronic information handovers. Avoidance of field interferences through interference checking with architectural elements and building systems has proven to be another major benefit.

1.3.4 3D Coordination

General Motors (GM), assisted by Ghafari Associates as architect/ engineer (AE) and technology integrator, debuted a Virtual Factory initiative in 2004, attempting to apply the principles of Lean Manufacturing to construction. A key element of this strategy was direct electronic interchange of information rather than reliance on drawings. Between 2004 and 2006, GM undertook four projects, pushing the automation envelope with each. By the second project, a 455,000 square foot assembly plant, they achieved zero construction change orders due to building component interferences. That project was also completed five weeks ahead of schedule with no field overtime. Unanticipated benefits were six-figure savings on trash disposal, due to reduced waste, as well as fewer accidents on the job site. The direction emerging from this experience is to build directly from the model, developed to ¼ inch tolerances. By the third project, the team had moved to a 3D-based review process and totally eliminated 2D drawings from the steel design-detail-fabricate-erect process.

1.3.5 Handover to Operations and Maintenance

Since BIM is a relatively new idea in the general buildings industry, there has, as yet, been little opportunity for owners to quantify benefits in the operations and maintenance phase. There are, however, two notable projects that seek to reduce the cost and improve the quality of the information handover to operations and maintenance.

1.3.5.1 IFC Model Based Operations and Maintenance

The U.K. Department of Trade and Industry (DTI) sponsored a project, IFC Model Based Operations and Maintenance (ifc-mBomb), to demonstrate improved information flow throughout design and construction as well as handover to operations and maintenance, through the use of the IFC data format for information exchanges and the maintenance a single data model managed by a model server. A model server is software that enables complete models to be imported and exported, but also supports real-time data sharing among a number of software applications. The goal was to provide proof of concept and encourage commercial software implementations. The project was led by Taylor Woodrow Construction. Technology consultants were AEC3. Results were reported in 2004.

The team used a real world project to demonstrate capability. One targeted result was the elimination of the delay and cost involved in populating a facility management (FM) system. This was estimated for a typical hospital as 6-12 months and more than £200,000.

For the handover to FM system capability presentation, the scenario involved taking room data sheet information created by the client and architect and populating a FM system with the room requirements data. The scenario's "design team" then created the BIM, based on the 2D drawings created by the original design team. They focused primarily on the building services (mechanical, electrical, plumbing) for the two story auditorium within a tertiary (community) college building, iterating the design and detailing with a number of software applications sharing the same common building model. The team then generated a handover package comprising schedules of the spaces and mechanical systems that included instances, types and operational instructions. They were also able to load comprehensive asset information into a commercial Asset Management System. Both of these processes were completed in a few minutes, fully automatically. There was no re-keying whatsoever.

1.3.5.2 Construction Operations Building Information Exchange

The Construction Operations Building Information Exchange (COBIE) project, with funding from the U.S. National Aeronautics and Space Administration (NASA), is creating standardized content and format for information handover to operations and maintenance as part of the U.S. National BIM Standard (NBIMS). The COBIE approach envisions capturing this information incrementally throughout the facility planning, design and construction processes. This approach contrasts to current Unified Facilities Guide Specifications (UFGS 01781), which require project contractors to assemble and scan documents for electronic handover at project closeout. In discussions with the COBIE team, Naval Facilities Command (NAVFAC) estimated the cost of gathering the UFGS data at US \$40,000 per project. By capturing the information in the correct format at the source, the COBIE project aims to eliminate this cost. More information about COBIE can be found in Section 3.3.1.4.

1.4 Challenges to Achieving Benefits

Today, project teams are engaging in information handovers on a daily basis. Many are even exchanging BIM data. However, this process is neither automated nor seamless. It works if a motivated team devotes several manweeks to defining the information to be exchanged and the protocols for doing so. Often, the BIM is incomplete for its intended downstream use and must be augmented by verbal or text explanations and information. There are still technical issues to be overcome, particularly if a two-way exchange of intelligent model data is the goal.

In 2004, the NIST study **NIST GCR 04-867** quantified the cost of these efforts at US \$15.8 billion annually. Costs were categorized as:

- Avoidance – costs incurred to prevent or minimize the impact of technical interoperability problems
- Mitigation – costs of activities responding to interoperability problems, including scrapped materials costs, and
- Delay – costs incurred when interoperability problems delay completion of a project or the length of time a facility is not in normal operation

The goal of the *General Buildings Information Handover Guide* (GBIHG) is to assist organizations involved in the capital facilities information life cycle to develop standardized and repeatable approaches to information handover, avoid major pitfalls and reduce, if not eliminate, the costs of inadequate interoperability.

2. General Buildings Industry Background

2.1 Handover Process

The *Capital Facilities Information Handover Guide (CFIHG) Part 1* describes six major phases in the life cycle:

1. Planning and Programming
2. Design
3. Construction
4. Project Closeout/ Commissioning
5. Operations and Maintenance
6. Disposal

Traditionally, these phases have been seen as sequential (see Figure 2-1), with defined handover points between phases and additional information flows (smaller arrows in Figure 2-1). In the past few years, however, there has been a rethinking of the planning/ design/ construction phases. This has been prompted to a great extent by the realization on the part of all industry players that the delivery of capital projects can and should be improved and also by owner dissatisfaction with project outcomes. These changes to project phasing have been enabled by advances in information technology.

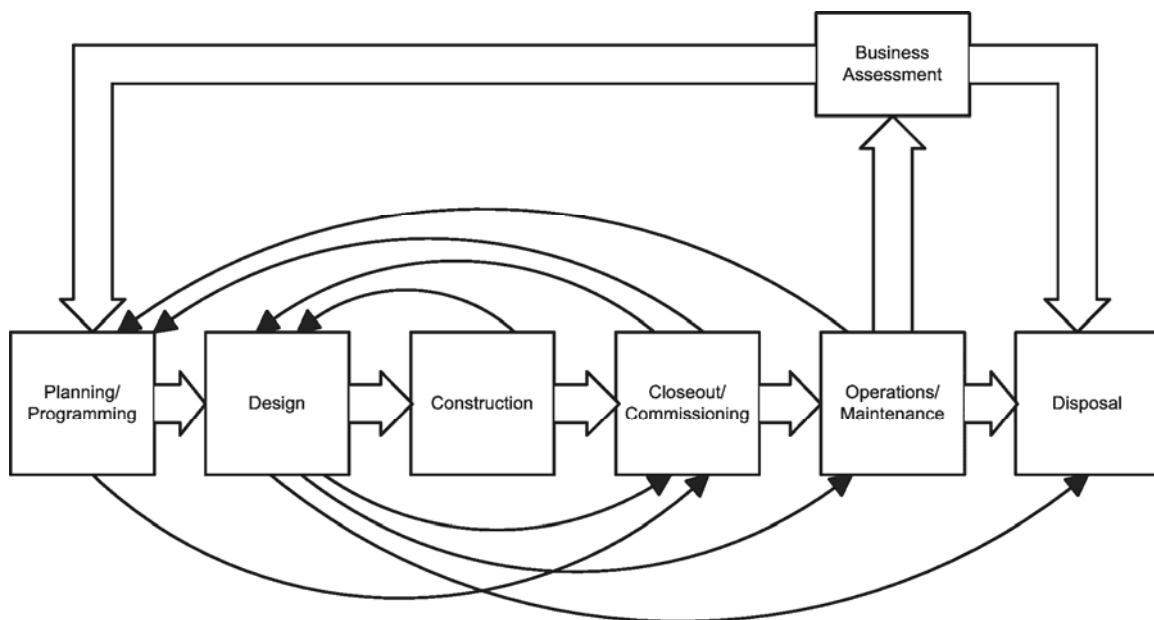

Figure 2-1: Major Phases in the Capital Facility LifeCycle
(Source: *Capital Facilities Information Handover Guide Part 1, NISTIR 7259*)

2.2 Current Process

The traditional sequence of design activities and the deliverables of each step are articulated in

standard contracts between owners and designers. An example is the American Institute of Architects' (AIA) B141 – 1997, which breaks design into four phases: schematic design, design development, construction documents and bidding.

2.2.1 Schematic Design

In schematic design, the owner and designer establish the program, schedule and budget for the project. The facility design is articulated to the extent of determining the size and relationship of project components and the preliminary selection of major building systems and construction materials. The deliverables – “information handover” – of the traditional schematic design phase are drawings and other documents illustrating the scale and relationship of project components.

2.2.2 Design Development

Based on the approved schematic design and the owner's construction schedule and budget, the designer establishes the form, size and character of the project in terms of architectural, structural, mechanical and electrical systems and construction materials. The handover of this phase is traditionally a set of drawings that document size, form and arrangement as well as specifications that identify major materials and systems and establish their general quality level.

2.2.3 Construction Documents

This phase is defined by its handover: the construction documents. Based on the approved design development documents and any further adjustments in the scope or quality of the project or in the construction budget authorized by the owner, the design firm prepares, for owner approval, construction drawings and specifications detailing the requirements for the construction of the project and the quality levels of materials and systems required. The design firm also addresses building codes and other jurisdictional requirements. Under the standard design contract, the design firm defines **what** is to be built but has no responsibility for **how** it can or should be constructed. The **how** is the responsibility of the contractor. Many think that this differentiation introduces inefficiencies and quality problems in project delivery.

2.2.4 Bid Phase

The design firm assists the owner by:

- Establishing a list of prospective bidders or contractors
- Obtaining either competitive bids or negotiated proposals
- Validating and evaluating those bids or proposals

2.2.5 Construction Phase

In traditional design-bid-build project delivery, the lead design firm administers the construction contract between the owner and the contractor and reports to the owner on project progress and quality. However, the design firm has no control over or responsibility for the construction means, methods, techniques, sequences or for site safety. These are solely the contractor's responsibilities. The handovers from the construction phase are the actual constructed facility plus, in traditional project delivery, information about the operation and maintenance of the building's equipment, systems and finishes. The latter information is provided in contractor submittals, which are defined in the specifications.

2.2.6 Closeout/ Commissioning

In the closeout/ commissioning phase, the owner accepts the construction work and processes the contractor's final payment. The contractor hands over all required documentation. The operations and maintenance staff may also receive training on the building systems and equipment.

In a traditional project closeout, information handover focuses on documentation (primarily drawings) of the facility as built, actual project costs and schedule compared to plan, spare parts lists, maintenance products and requirements, equipment and systems training and operations manuals. These handover requirements are defined in the construction documents, which form part of the contract between the owner and the contractor, and the information is handed over, frequently as paper documents, by the construction team.

Commissioning is the systematic process of ensuring and documenting that all systems and assemblies perform according to specification and end user requirements, as well as the owner's operational needs. With facility commissioning, the information requirements derive from earlier facility life cycle phases. The original facility program defines requirements in terms of the functional, environmental and economic needs of the owner and of the persons using the facility. During the design phase, those needs are translated into physical reality and a wealth of information is produced beyond what is handed off to construction. Effective commissioning practices demand that the information requirements of the commissioning phase be considered from the moment of project conception and that those requirements be captured and documented every step along the way.

2.2.7 Operations and Maintenance

The operations and maintenance phase generates its own information base, which can be used to improve facility performance and informs decisions about expanding or disposing of the facility. This information includes production or occupancy levels, service requests, maintenance schedules, inspection reports, work orders, equipment downtime, operating costs and maintenance costs. Computerized Maintenance Management Systems (CMMS) and Enterprise Asset Management Systems (EAMS) are two types of software products that facilitate the management of operations and maintenance information, from the physical and financial views respectively, and make that information accessible to support facility-related decisions.

2.3 Changes in Project Delivery

The Construction Users Roundtable's (CURT) Architectural/ Engineering Productivity Committee concluded in *Collaboration, Integrated Information and the Project Lifecycle in Building Design, Construction and Operation*, "The goal of everyone in the industry should be better, faster, more capable project delivery created by fully integrated, collaborative project teams. Owners must be the ones to drive this change, by leading the creation of collaborative, cross-functional teams comprised of design, construction and facility management professionals."

A major tenet of an improved project delivery approach is to bring procurement construction and operations expertise into the early stages of design decision-making. The AIA has termed this approach "Integrated Practice" and in 2005 launched a multi-prong initiative to encourage and

support this approach. Integrated practice does not so much change the roles and responsibilities of the various parties (i.e., owner, designer, contractor) but rather brings forward the construction and operations points of view early in design decision making so that concerns such as life cycle costs, maintainability, material availability, constructability, construction sequencing and staging are taken into account.

This approach has been endorsed by CURT in their publication *Optimizing the Construction Process: An Implementation Strategy (WP 1003)* as well as by the Associated General Contractors of America (AGC) in *The Contractor's Guide to BIM, Edition 1*.

The basic tenets of this approach echo the principles of reengineering defined by Hammer and Champy in *Reengineering the Corporation: A Manifesto for Business Revolution*, particularly:

- **Capture information once; avoid redundant data entry.** The use of the intelligent building model to provide input to multiple analyses facilitates a higher degree of design optimization by eliminating the need to constantly re-enter the same basic building information into each program. This improves quality as well, ensuring that all analyses are performed on the same building information.
- **Link parallel activities instead of integrating their results.** Producing rapid, iterative cost estimates from the design model and merging the 3D geometry with the proposed construction schedule to visualize and optimize construction sequencing are examples of concurrent activities that were never before possible.
- **Let one person perform a work process from beginning to end.** Allowing the suppliers and subcontractors who will provide and install the components to actually develop the virtual building components to be included in the construction model gives them the greatest flexibility in meeting requirements and improves the dimensional accuracy of the model.
- **Build control into the process.** The use of 3D review sessions to highlight interferences before components are fabricated reduces the cost and time required for resolution in the field. Some projects using this technique have reported zero change orders due to clashes between building system components encountered in the field.

The emerging project delivery process compresses the design/ construction into three major, collaborative and integrated activities: Design Optimization, Construction Optimization, and Construction Orchestration.

2.3.1 Design Optimization

The first phase in the new process involves an intensive and iterative period of deciding what should be built. The use of advanced analysis software in all areas – structures, energy consumption, lighting and daylighting analysis, air flow (CFD) analysis to determine thermal comfort, cost estimating and life cycle cost analysis – all deriving the project description from an intelligent building model, leads to an optimized design solution. Contractor- or subcontractor-developed components may be incorporated into the model at this point to ensure more accurate cost estimates and analyses. Because the Building Information Model (BIM) includes comprehensive 3D geometric definitions, it also allows visualization of facility appearance, function and context. This visualization capability has proven extremely powerful in expediting design decisions and communicating with all stakeholders, including the public.

The information handed over from this design process is a model, or series of related, discipline-specific models, that describe(s) the facility form, structure and building systems. Very specific materials, products and assemblies may be incorporated in the model(s).

2.3.2 Construction Optimization

The next phase is determining how to build the facility. This involves contractors, subcontractors and fabricators in a computer-based virtual construction process. The time-consuming process of shop drawing review is replaced by electronic submittals and a 3D review process. Supply chain or cost considerations may prompt changes in systems or components, which are fed back to design analysis. During this phase, the spatial aspects of the model are of greatest interest. If multiple, discipline-specific models have been created for analysis, their geometry is merged. Design elements in the model are replaced by the actual components proposed by fabricators and subcontractors. Interferences are resolved; 4D techniques allow for construction sequence planning and avoidance of construction interferences. When both the detailed definition of building components is complete and the process for erecting and installing them have been choreographed, the physical construction begins.

The handover from this preconstruction phase is a completely detailed geometric model of the building, with each physical component identified and defined. The level of definition is such that many components can be fabricated from the model data. In addition, each component is sequenced in the construction schedule.

2.3.3 Construction Orchestration

The construction planning described above, combined with high-precision dimensional control on-site, leads to a highly predictable physical construction phase. Many more components can be shop-fabricated in a controlled environment, improving quality. Supply chain information is available to inform the project team of the status of the various components – have they been fabricated? Shipped? Delivered? There is little rework, reducing costs and improving morale. The results are significantly less waste, reduction in the number and duration of on-site activities, less requirement for laydown space and improved site safety.

This approach is seen in the General Motors/ Ghafari projects, with excellent outcomes. It clearly changes the tidy packages of phased design deliverables to which the industry has become accustomed. The process demonstrates much concurrency and blurring of roles. For example, the steel fabricator may suggest member sizes with shorter lead times, with the structural engineers adjusting the design to accommodate those sizes. This new project delivery approach has often been undertaken in conjunction with a Lean Construction initiative. Lean Construction identifies and attempts to eliminate the seven forms of waste (see Section 3.2).

2.3.4 Operations and Maintenance

The information handed over from the construction phase includes the detailed geometric facility model, which has been updated throughout the construction process to reflect any changes. As of this writing, the model does not typically encapsulate the operations and maintenance information that traditionally is handed over in manuals, in either electronic or print format. A number of organizations are seeking to establish standards for non-proprietary and interoperable versions of the data needed for operations and maintenance. These organizations include

FIATECH, the U.S. National BIM Standard (NBIMS), the International Alliance for Interoperability (IAI) and the Open Standards Consortium for Real Estate (OSCRE). The Construction-Operations Building Information Exchange (COBIE) effort, described further in Section 3.3.1.4, is the NBIMS component addressing this issue. The COBIE specification defines the information handover requirements for describing the physical materials, products and equipment that create the facility, including equipment locations and serial numbers, warranties and spare parts lists.

2.4 Industry Roadmaps for Implementing Change

In 2002, Uitgebreid Samenwerkingsverband Procesindustrie, Nederland (USPI-NL) laid out a Roadmap for reaching the goal of a fully integrated facility life cycle data repository, based on structured information standards. This Roadmap was documented in the *Capital Facilities Information Handover Guide (CFIHG) Part 1*. The Roadmap (see Figure 2-2) distinguishes between internal and external “data readiness.” The two are interdependent. A company must have achieved internal process integration before it can successfully achieve external process integration. At the same time, the market must provide the tools and standards to support external integration. This has frequently been called a “chicken and egg” problem.

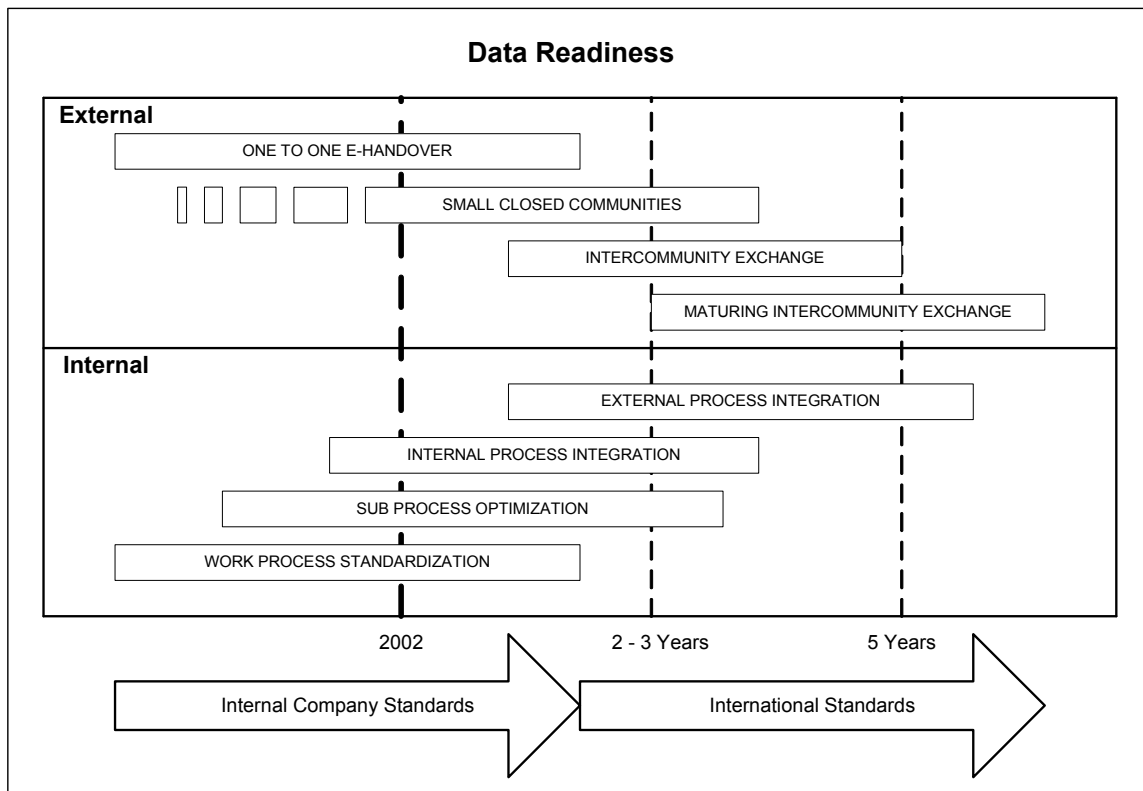

Figure 2-2: USPI-NL Roadmap for Reaching the Goal of a Fully Integrated Facility Life Cycle Data Repository

2.4.1 Steps Toward External Process Integration

Note that, on the external data readiness side, the emergence of “small closed communities” engaged in electronic information handovers precedes general intercommunity data exchange. The American Institute of Steel Construction’s (AISC) CIMsteel Integration Standard, Release 2 (CIS/2) initiative is an excellent example of such a step. The general buildings industry is now beginning to demonstrate a desire to tightly integrate the steel information model with the architectural and building systems models.

The first steps in intercommunity information exchange in the general buildings industry revolve around 3D geometry. This makes sense, since tools for exchanging geometry between Computer-Aided Design (CAD) systems have developed over a period of 20 years and are quite mature. Also, software has emerged that allows the loading of 3D geometry created in multiple CAD or BIM systems into an integration environment, without an intermediate translation step, where interferences between building systems and elements can be identified. This is the capability used by GM design/ build teams to achieve zero construction change orders due to building component interferences.

The next step has been the addition of the element of time to the combined 3D model and this is called “4D”. 4D permits the animation of sequences such as project phasing, tenant moves and construction sequencing. The latter is achieved by linking elements of the 3D models to a construction schedule. 4D capability allows the detection of dynamic interferences, i.e., conditions where scheduled activities will get in each other’s way or temporary site conditions will block access.

In the general buildings industry, the move to the exchange of true BIM intelligence is just beginning. This is where the external data readiness is not fully in place.

2.4.2 FIATECH Capital Projects Technology Roadmap

The U.S. National Institute of Standards and Technology (NIST) and the Construction Industry Institute (CII) created FIATECH in 1999. FIATECH’s mission is to achieve significant cycle-time and life cycle cost reductions and efficiencies in capital projects from concept to design, construction, operation, decommissioning and dismantling of facilities. The idea of Fully Integrated and Automated Project Processes (FIAPP) is key to the formation and mission of FIATECH.

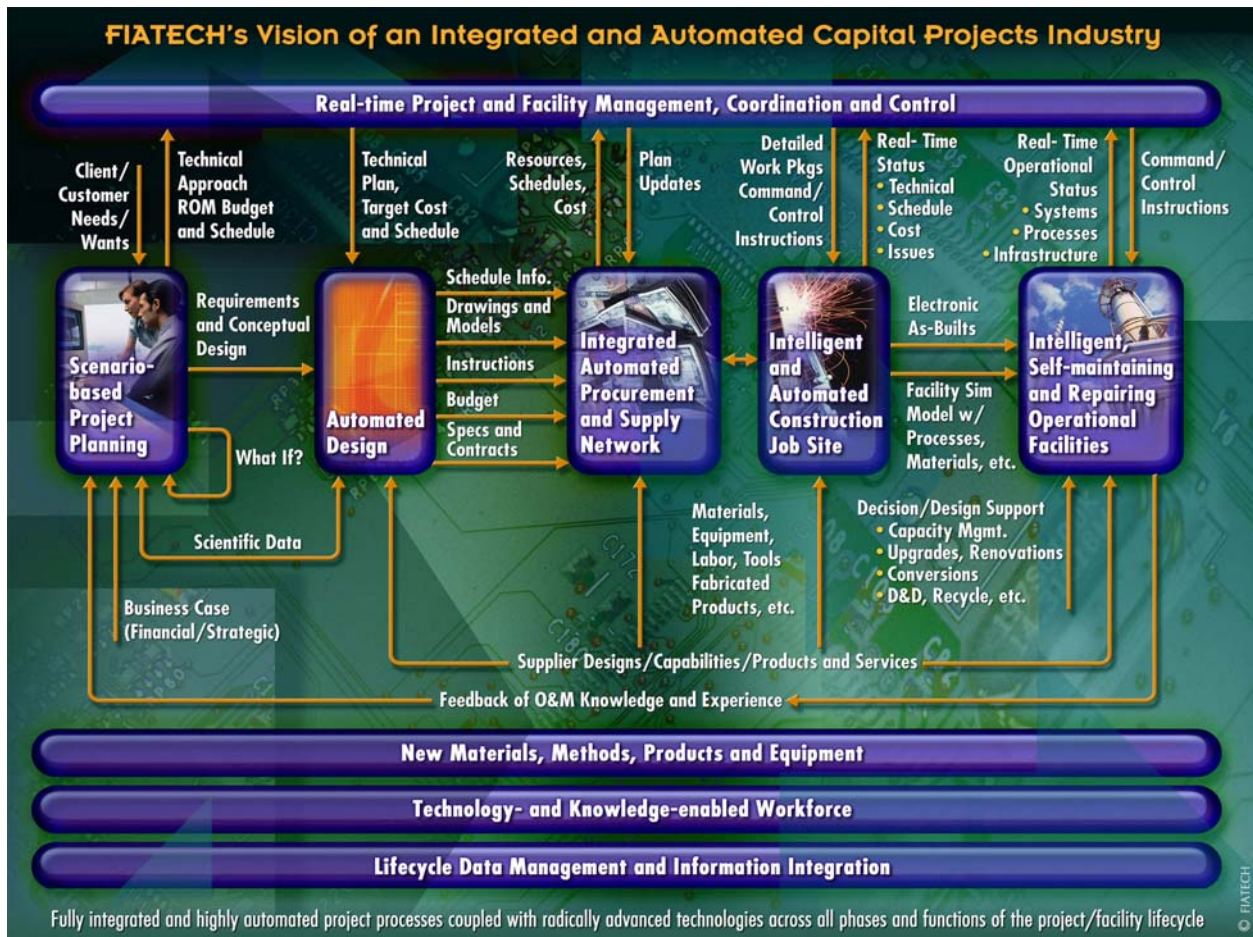

Figure 2-3: FIATECH Capital Projects Technology Roadmap

The FIATECH consortium launched the Capital Projects Technology Roadmap in 2001, and published a first draft in 2002. The generation of the roadmap was a result of a structured process with strong industry participation. The process was designed to:

- Document a “current state assessment” of the industry from technology and business perspectives
- Develop a “future state vision” that addressed the needs identified in the current state assessment
- Develop a broad slate of technology-oriented goals and requirements to achieve the vision
- Prioritize the goals and identify an initial set of near-term actions to initiate progress towards those goals

The result was a broad roadmap, comprising “9 Elements” for transforming the delivery of capital facilities projects:

- Element 1: Scenario-based Project Planning
- Element 2: Automated Design
- Element 3: Integrated and Automated Procurement & Supply Networks

- Element 4: Intelligent and Automated Construction Job Site
- Element 5: Intelligent Self-maintaining and Repairing Operational Facility
- Element 6: Real-time Project and Facility Management, Coordination and Control
- Element 7: New Materials, Methods, Products & Equipment
- Element 8: Technology- & Knowledge-enabled Workforce
- Element 9: Lifecycle Data Management & Information Integration

FIATECH is working with other organizations on portions of the tactical plans of that roadmap. So far, no dates have been set for achieving the specified capabilities.

2.4.3 ROADCON Roadmap

ROADCON is one of the nearly 30 strategic research and technology development (RTD) roadmap projects on "New Methods of Work and Electronic Commerce" launched by the European Commission in 2002. The aim of ROADCON was to develop a vision for an agile, model-based/ knowledge-driven construction industry and to prepare a roadmap towards achieving that vision. Like FIATECH, ROADCON documents a current state and a future vision for a dozen aspects of technology, process, human resources and legal/ contractual governance.

ROADCON TOP LEVEL ROADMAP	
Current State	Vision
Customized Solutions	Adaptive Systems
LAN and Web	Ambient Access
Project Websites	Collaborative Virtual Teams
Mobile Phones	Digital Site
File-based Data Exchange	Flexible Interoperability
Technology Illiteracy	Technology Skills and Awareness
Re-invention	Knowledge Sharing
Paper-based Contractual Practice	Legal and Contractual Governance
Document-based Technology	Model- and Object-based Technology
Cost-driven Process	Performance-driven Process
Physical Products	Smart Buildings and Products
Stand-alone Applications	Total Life Support

ROADCON presents a series of high level roadmaps for transitioning from the current state to the vision for each element. Each roadmap recognizes four major innovation stages and associates with each a timeframe:

- Emerging: Exploring RTD needs and opportunities for potential solutions (11-20 years)
- Research: Prototyping is required to move forward (6-10 years)
- Development: Clearly defined RTD to achieve exploitable results (3-5 years)
- Take-up: Adopt, deploy and demonstrate mainly existing technologies (0-2 years)

The *Construction ICT (Information and Communications Technology) Roadmap* (ROADCON: IST 2001-37278, WP5/ D52) declares, "...this needs to be done in a holistic manner without

gaps in the evolutionary process. New technologies should not be introduced to industry at a premature stage.”

Figure 2-4 below incorporates the roadmap for moving construction from document-based to model- and object-based information and communications technology.

2.4.4 Roadmaps from Multiple Organizations Compared

Figure 2-4 compares the USPI-NL roadmap to those produced by organizations that have projected timeframes for achieving interoperability.

	2001	2002	2003	2004	2005	2006	2007	2008	2009	2010	2011	2012	2019	2020
CFIHG Part 1: USPI-NL Roadmap														
<i>External</i>														
One to One E-Handover		■	■	■										
Small Closed Communities		■	■	■	■									
Intercommunity Exchange			■	■	■	■	■							
Maturing Intercommunity Exchange					■	■	■	■						
<i>Internal</i>														
External Process Integration			■	■	■	■	■							
Internal Process Integration		■	■	■	■									
Sub Process Optimization		■	■	■	■									
Work Process Standardization		■	■	■										
U.S. General Services Administration														
GSA PBS OCA Established the National 3D-4D-BIM Program			■											
OCA issued an RFI to companies providing 3D-4D-BIM services					■									
GSA publishes 3D-4D-BIM Guide Volume I: Spatial Validation							■							
A Spatial Program BIM becomes min. req. for all major new and modernization projects								■						
Anshen + Allen														
<i>Pilot Project</i>														
Internal BIM Production				■	■	■								
Initial BIM Collaboration						■	■	■						
Mainstream BIM Collaboration							■	■	■					
Construction to Operations Building Information Exchange Project Plan														
<i>Intelligent Electronic Submittals</i>														
Capture Spatial Requirements						■	■							
Capture Equipment Performance Specifications							■	■						
Capture Metrics for Equipment Performance								■	■					
U.S. Army Corp of Engineers														
<i>Initial BIM Capability</i>														
90% Internal BIM Adoption							■	■	■					
BIM Contract Requirement									■	■	■			
Automation of Life-Cycle Tasks											■	■	■	
European Union RoadCon Road Map														
<i>Take-Up</i>														
Data Exchange Standards		■	■	■										
Object-Based CAD Tools		■	■	■										
Structured Documents - XML		■	■	■										
Document Management & PDM		■	■	■										
3D		■	■	■										
File-Based Process/ Workflow Management		■	■	■										
<i>Develop</i>														
Translators				■	■	■								
Enhanced Standard Scope				■	■	■								
Object Databases				■	■	■								
Model & Document Linking				■	■	■								
Model Driven User Interfaces				■	■	■								
4D (=3D + time)				■	■	■								
5D (=4D + cost)				■	■	■								
Legal & Contractual Governance of Models				■	■	■								
<i>Research</i>														
Model Mapping							■	■	■	■				
Integrated Model-Based Standard							■	■	■	■				
Model Servers							■	■	■	■				
Model-Based Applications & Interfaces							■	■	■	■				
Intellectual Property Rights of Model Data							■	■	■	■				
<i>Emerging</i>														
Extensible & Adaptive Models												■	■	■
Model Checking												■	■	■
Model-Based Services												■	■	■
Model Driven Process												■	■	■

Figure 2-4: Building Industry Roadmaps

3. Key Concepts and Terms

Case studies presented in this guide demonstrate that higher levels of productivity and quality can be achieved through more integrated project delivery supported by electronic information handovers. The Construction Users Roundtable (CURT) suggests in *Optimizing the Construction Process: An Implementation Strategy* that the necessary component to transform a collaborative project approach into integrated project delivery is technology.

Currently, the management of electronic information exchanges is a technically difficult and time consuming activity. This presents an obstacle to widespread adoption of the target technologies, especially Building Information Modeling (BIM). What can be done to facilitate the general building industry's ability to achieve user-friendly, reliable and low cost information handovers?

3.1 Interoperability

A layered data model to support capital facility life cycle information was shown in the *Capital Facilities Information Handover Guide (CFIHG) Part 1* (see Figure 3-1).

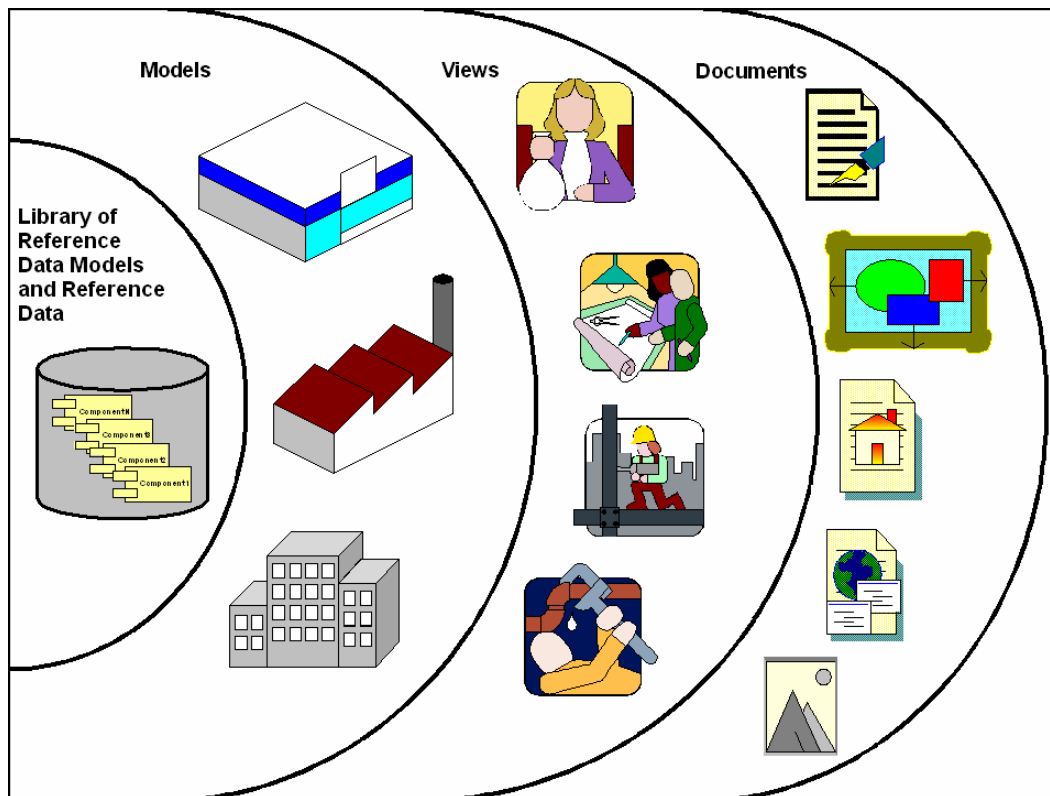

Figure 3-1: Layered Data Model

Key to the ability to exchange intelligent building information across organizational and system boundaries is agreement on the types, hierarchy and content of the data objects that make up the building model. There must be broad agreement on the information required about a door, a

space, a window, a chair, a piece of mechanical equipment and so forth. This is a necessary step for the interoperability of applications using intelligent building models. It permits producers of building products and equipment to create and publish libraries of their components according to a standard framework. Objects from the reference library can then be combined to create any number of truly intelligent BIMs. Each BIM is an assembly of specific components with their properties (height, width, fire rating, and so forth) assigned. Next, software must provide the capability to extract from the BIM the information required for specific purposes, such as energy analysis, structural analysis, cost estimating, procurement, fabrication, erection and maintenance. These are called Model Views. This is a somewhat circular process, since the information requirements of the views are really what define the information that must be associated with each object type. The process through which model views can be proposed, agreed to by the full range of stakeholders, standardized and software implementations certified is very immature in the general buildings industry. This section discusses current approaches and initiatives to create this critical information infrastructure.

Finally, there is the need to extract numerous, coordinated documents from the BIM. “Documents” in this sense include 2D drawings, 3D renderings, quantity takeoffs, formatted cost estimates, schedules and so forth. This step requires development of rules for extracting and formatting subsets of the information contained in the model. This is an area that is fairly well understood and currently supported by software.

3.2 Information Forms and Formats

Understanding the following terms is helpful in planning and executing information handovers.

3.2.1 Unstructured Form

Increasingly facility information is produced and managed electronically. Examples include memos, cost estimates, purchase orders, analyses, and drawings. However, much electronic information is still held in documents that do not have a formal structure. Most correspondence, including project reports and drawings, fall into this category. For these documents, the only way to interpret the contents or to check their quality is for someone to actually read them.

Unstructured data of this type cannot be truly interoperable, although it might be compatible with multiple software products. Some human effort will be required to interpret the data for the receiving system. A good example is the work firms do to reach agreement on Computer-Aided Design (CAD) layering for a particular project. This creates the appearance of structure in the CAD files. However, the structure is not intrinsic: a user can place a furniture item on the wall layer. For this reason, quantity take-offs from unstructured CAD files have always been subject to error.

3.2.2 Structured Form

Some software, particularly BIM authoring tools, creates information in a structured form that is immediately machine-interpretable. This improves productivity and reduces errors. It permits the use of computer tools to assist in managing, using and checking the data. Structured data are needed if the goal is to eliminate the cost of manipulating and interpreting the data in the receiving system each time information is handed over to another application for analysis. Structured form is the key to highly optimized design, supply chain streamlining and the ability

to use information captured during design and construction in downstream operations and maintenance applications without additional cost. Section 1 of this guide cites Anshen+Allen, Architects' use of Industry Foundation Classes (IFCs), a structured data form, to transfer building information to the Lawrence Berkley National Laboratory (LBNL) for energy and daylighting analysis, resulting in much more rapid turnaround of analysis results.

3.2.3 Proprietary Format

This is any data format defined and owned by a specific software company. Most software outputs data in a proprietary format, sometimes referred to as the “native” format. Proprietary is the more significant term, however, because it means that the format is the property of a single software vendor. At any time, the vendor can modify the format. If this happens, archived data maintained in that format may no longer be usable in current versions of the application. Also, a vendor may cease doing business or discontinue the products that output the format. Either of these circumstances threatens to render the proprietary data unusable.

Very often, the client organization uses a particular software application and requests information in that application's proprietary file format. This approach permits reuse in the authoring software but may limit the ability to share the information with other organizations or additional applications, such as analysis, or to use the information when the current generation of software is replaced.

Proprietary formats may have structured or unstructured form. BIM authoring products, for example, create structured data in proprietary formats. As this new generation of design software produces information-rich models, there is the potential for reuse of that information in an increasing number of parallel and downstream processes. Proprietary formats, under these circumstances, become problematic.

However, among products from a single software vendor, users find that proprietary format exchanges can be quickest, easiest and most reliable. It would be appropriate to permit the iterative data exchanges that take place during the design or construction phase to use proprietary formats, particularly if those exchanges needed to be two-way. Ghafari, for example, has reported that some applications that support the CIMsteel Integration Standard, Release 2 (CIS/2) standard structured format do not maintain each object's globally unique ID. This is not a shortcoming of the CIS/2 standard but of vendor implementations of that standard. The result is that a structural member's ID can be changed in a receiving application and sent back with the new ID to the originator. This creates problems in model management. Using the proprietary format under these circumstances will improve quality, reduce model management effort and speed the iterations. However, if the steel model will be maintained and updated throughout the life cycle of the facility, a standard format (CIS/2 or IFC) is preferable for the handover to operations.

3.2.4 Standard Format

There are two types of standard formats:

- “*De facto* standards” refer to formats that may have originated with a single vendor, but have been made publicly available and are supported by multiple vendors and products. A good example of a *de facto* standard format is DXF. Since the format specification is published,

anyone can write an application to access data stored in that format. The organization can be assured that their data will be retrievable. However, Autodesk decided not to extend the DXF format to include its complete product data structure. One can anticipate that there will be fewer and fewer commercially available programs that read and write DXF files over time and that the DXF format will not be extended to BIM objects.

- “*De jure* standards” are those maintained by a standards development organization, such as the International Organization for Standardization (ISO), the International Alliance for Interoperability (IAI) or the Open Geospatial Consortium (OGC). In addition to the advantages of data longevity described above, *de jure* standards are typically developed through a consensus process that considers the information requirements of many organizations. Thus, *de jure* standard formats may be more flexible and useful. Also, the consensus process ensures that there are multiple organizations that have an interest in the standard. Thus, a unilateral decision by one vendor will not halt support for or the extension of the standard. In addition, standards bodies typically have an organization that handles activities such as supporting software vendors attempting to implement the standard and developing test cases for verifying implementations. They may even create certification programs for software implementations.

The downside to *de jure* standards is that the consensus process is slower. This has become a particular issue with BIM standards.

Standard formats are preferred for any data that will be archived for an extended period.

3.3 Using Standard Structured Formats

Currently, there exist multiple standard structured formats to support electronic information exchanged in the general building industry. Two that have already been discussed in this guide are CIS/2 and the IAI IFCs.

CIS/2 was developed using the ISO STEP modeling technology. Targeted at building structural steel, it supports the structural steel life cycle, from design and analysis, through detailing, fabrication and erection. It was developed over a 10-year period by Leeds University and the Steel Construction Institute (SCI) in the UK and partially funded by the European Union EUREKA Project. Version 1 was released in 1995, Version 2 (CIS/2) in 1999. The American Institute of Steel Construction (AISC) has endorsed and supported the CIS/2 standard since 1999, advocating for its use in the structural steel supply chain. Technical assistance has been provided by the Georgia Tech Design Computing group.

The IAI’s IFCs address a much broader range of potential information exchanges than CIS/2. The IAI is a global alliance of organizations in Architecture/ Engineering/ Construction (AEC) and other industries whose goal is to develop a universal standard for information sharing and interoperability of intelligent digital building models developed in object-based systems throughout all phases of the building life cycle. The IFCs are specifications that define a comprehensive object-based data model for the AEC industry. The IFC core concepts have been endorsed by the ISO as a Publicly Available Specification (PAS) under the ISO label “ISO/ PAS 16739” (http://www.tc184-sc4.org/SC4_Open/Projects/maindisp.cfm).

The IFCs provide a rich and extensive language that allows multiple ways to define geometry and to name and measure properties. It is quite possible for two systems to have IFC import/export capabilities but be unable to exchange information successfully due to different mappings of their native objects to the IFC classes. There are now a number of efforts underway to eliminate this problem.

3.3.1 Defining Model Views

What are necessary to move standard formats such as the IFCs into industry-wide use are agreed-upon mappings of the information requirements of specific information exchanges to the entities and properties of the standard formats, as discussed at the beginning of this section. This effort requires a combination of domain knowledge (i.e., knowledge of design and construction processes and products) as well as deep understanding of the standard format data structures for conveying this information. Since it is extremely rare that a single individual has both the domain expertise and the data modeling knowledge, a great deal of work is underway to define methods of capturing domain information and documenting data structures in ways that allow the two knowledge groups to communicate effectively.

An established technique is to define specific workflows and information use cases for model exchange. An example of a use case would be the handover of building information to the contractor for cost estimating. Each use case may require multiple information exchanges. For each exchange, it is necessary to detail the information to be exchanged and define the entities in the standard format that are required for the exchange. This creates a Model View. This proven approach derives from the “application protocol” concept that was first used by the Initial Graphic Exchange Specification (IGES) committee in the 1980’s and was a basis for the development of ISO 10303 (STEP) as well as for the development of the Information Delivery Manual (IDM) methodology discussed in Section 3.3.1.6 below.

3.3.1.1 BLIS

The Building Lifecycle Interoperable Software (BLIS) initiative was the first to apply a use case approach to defining Model Views of the IFCs. The goal was to encourage consistent IFC implementations by software vendors. Defining views of the IFC model, appropriate to specific uses, was a way to ensure that similar applications that implemented a part of the IFC model did so in a consistent manner. Software companies participating in the BLIS initiative defined a small set of use cases and committed to supporting them flawlessly. In order to achieve this, these use cases and associated object sets were defined in great detail. Beginning in 1999, BLIS companies defined IFC views and demonstrated software interoperability via IFCs for the following use cases:

- Design to/ from Design (geometry view)
- Client briefing/ space planning to Architectural design
- Architectural design to/ from Heating, Ventilating, and Air-Conditioning (HVAC) design
- Arch/ HVAC Design to Quantities take off/ cost estimating
- Arch/ HVAC Design to Thermal load calculations/ HVAC system design
- Arch/ HVAC Design to Construction management/ scheduling

Thanks mainly to the BLIS effort, these are the most widely used and dependable information handovers using IFCs. The BLIS website can be viewed at <http://www.blis-project.org>.

3.3.1.2 GSA

In 2006, the U.S. General Services Administration (GSA) Public Building Services (PBS) Office of the Chief Architect (OCA) released *GSA BIM Guide For Spatial Program Validation*, which documents in detail specific information handover requirements from Preliminary Concept Design and Final Concept Design. GSA targeted spatial program validation as a high-priority use case and thus was able to identify clearly the information required, and then define a subset of the IFC model to convey that information. In addition, GSA worked with all major BIM software vendors to assist them in supporting the IFC Model View that GSA created through this mapping. GSA's BIM Guide Series also provides modeling guidance to end users, including product-specific instructions. More information can be viewed at <http://www.gsa.gov/bim>.

3.3.1.3 NBIMS

The U.S. National BIM Standard (NBIMS) Project Committee formed in 2005 under the National Institute of Building Sciences (NIBS) Facility Information Council. Its mission, as identified in its charter, is to improve the performance of facilities over their full life cycle by fostering a common, standard and integrated life cycle information model for the industry, which will allow for the free flow of graphic and non-graphic information among all parties to the process of creating and sustaining the built environment. The NBIMS is based on the methodologies and object class libraries defined by the IAI and is being developed using the IFCs. The committee plans to collect and coordinate IFC use cases created to date and make them more readily accessible. The committee will also work to coordinate U.S. efforts with related activities taking place internationally.

3.3.1.4 COBIE

The Construction Operations Building Information Exchange (COBIE) project is a component of the NBIMS sponsored by the U.S. National Aeronautics and Space Administration (NASA). It addresses the handover of information between the construction and operations phases of the facility life cycle. COBIE's goal is to capture complete electronic construction product, equipment, system, and warranty information as the project progresses and automatically transfer this information to the facility's work order management systems. COBIE is producing the data exchange format and specifications to support this. The first phase will rely on electronic submittals from construction contractors. These submittals will consist of documents in PDF format with document metadata as well as warranty, parts and equipment data entered into a database. Computerized Maintenance Management System (CMMS) vendors will be required to support a standard import format, which is IFC-compliant, into their applications. There were commercial technology demonstrations for this first phase in 2006. Future phases will extend the data exchange format and specifications to equipment performance specifications and metrics for equipment performance.

3.3.1.5 CIS/2 – IFC Harmonization

Georgia Tech, supported by AISC, and the National Institute of Standards and Technology (NIST) both undertook efforts to harmonize CIS/2 with the IFCs and create mappings between the two standard structured formats. NIST developed a CIS/2 to IFC translator that is being actively used in industry to export CIS/2 files from several steel analysis, design, and detailing

software packages and import them into architectural modeling systems for coordination and other tasks. Georgia Tech also produced software that translates CIS/2 to IFC and IFC to CIS/2.

The harmonization effort identified deficiencies in the IFC model in the handling of structural steel. Currently, NIST is working with the IAI Modeling Support Group to implement new constructs in the IFC model to handle structural steel and improve the mapping between CIS/2 and IFC. In addition, NIST and Georgia Tech are working together to define use cases for the structural steel supply chain. The use cases will look at information exchanges between architect, engineer, designer, detailer, fabricator, erector, mill, and so forth. The end result should be an Information Delivery Manual which will drill down to the IFC entities necessary for a particular information exchange.

3.3.1.6 Information Delivery Manuals

The Norwegian buildingSMART initiative and the NBIMS committee have built upon the use case approach with the Information Delivery Manual (IDM) methodology. This approach allows for a set of ‘functional parts’ to be defined that can be re-used to meet different sets of exchange requirements. It also accommodates information packages that have multiple sources over time. For example, the designer specifies the performance requirements of building products and systems, while the actual products, their characteristics and their installation and operation are defined in submittals during the construction phase. Both sets of information are required for operations and maintenance. The COBIE initiative has adopted the IDM approach and simplifies the development of a specification for the collection of incremental, process-based information packages. This allows the data subsets to be captured at the source throughout the design/construction process, rather than recreated at project closeout.

The NBIMS committee is actively gathering effective techniques and requirements, including many of those documented here, to reformulate them as IDMs. The goal is to create an ever growing, Internet-accessible and searchable library of use cases and IDMs. In addition, the NBIMS Project Committee is developing end-user templates for defining use cases and their information requirements.

3.3.1.6.1 Contents of a buildingSMART IDM

A buildingSMART IDM defines the key information handover points, identifies the data required and specifies how an application should exchange or share data in the handover transaction. In an IDM, each process is described individually and each description consists of three parts: process map, exchange requirement and functional part. The Norwegian buildingSMART effort has documented this methodology in detail (<http://www.iai.no/idm/index.html>), including the following definitions:

- **Process Map:** The Process Map (PM) is an overview of the process, describing its objective and the phases in a project when the business process is expected to be relevant. It also identifies all the sub-processes.
- **Exchange Requirement:** Each requirement for information exchange is described individually. An Exchange Requirement (ER) is a non-technical description of the information needed by a business process to be executed, as well as the information produced by that business process. An ER attempts to break down information

requirements into concepts which can be easily understood. ERs can be referenced by one or more PMs.

- **Functional Part:** A Functional Part (FP) describes an information handover in sufficient technical detail for software implementation. Whereas an exchange requirement describes information in non-technical terms, functional parts describe the use of every entity, every attribute, every property set and every property. A functional part identifies the specific IFC capabilities supporting the information handover and prescribes the values of attributes where appropriate. Functional parts can also be broken down into other functional parts. Functional parts are therefore reusable, defining commonly occurring sets of data that may be used by any number of processes and ERs.

3.3.1.6.2 IDM Toolset and Process

The IDM toolset and process is intended to be used by industry professionals to describe a business process that requires an information exchange between two project stakeholders, such as the architect and the structural engineer. The end result is a clear definition of the information to be exchanged, the timeframe in the project life cycle, and ideally, the application types to be used by the sender and the receiver.

3.3.1.7 IFC Model View Definition Toolset and Process

The IFC Model View Definition (MVD) toolset and process take one or more exchange requirements from IDMs and merge them to define a View of the entire IFC model schema to be implemented by the sending and receiving application types, such as architectural design application and structural design application. This merging of many IDM exchange requirements by application type is a pragmatic way to reduce the number of Views of the IFC model schema that must be supported by a given application. MVDs also define exactly which IFC objects, relationships and data formats will be used to exchange the information. This specificity ensures absolute consistency in implementations by different vendors. Conformance can be tested and verified by third parties, a necessary set for ensuring interoperability.

3.3.2 Other Standard Structured Formats

In addition to CIS/2 and IFC formats, there are a number of Extensible Markup Language (XML) schemas that have been defined to support standard information exchanges in the general buildings industry.

3.3.2.1 AEX

The FIATECH-sponsored Automating Equipment Information Exchange (AEX) Project developed XML schemas for automating the information exchange for the design, selection and procurement of engineered equipment, e.g., pumps, compressors and heat exchangers and also produced guidance - the *XML Schema Development Guidelines* - on developing such schemas. These guidelines summarize the background, rationale and guiding principles that the FIATECH program is using to produce XML domain schemas for automating information exchanges in the capital facilities industries and over the life cycle of equipment used in capital facilities. The AEX Project works with industry organizations in the development, validation, interoperability demonstration and standardization of these XML schemas. Industry associations are now adopting these XML schemas as industry standards. The Hydraulic Institute (HI) and the American Petroleum Institute (API) are two recent examples of including AEX into their equipment standards.

3.3.2.2 AGCxml

The Associated General Contractors of America (AGC) and NIBS are sponsoring development of AGCxml XML schemas for exchanging construction project information between software applications. AGCxml is targeted specifically for project information such as owner/contractor agreements, change orders, and requests for information. The goal is to create a unified document exchange standard to allow construction business data interoperability between software applications such as those for generating construction contracts, project management and accounting.

3.3.2.3 gbXML

The Green Building XML schema (gbXML) was developed by Green Building Studio, Inc. to facilitate the transfer of building information stored in CAD building information models, enabling interoperability between building design models and a wide variety of energy analysis tools. gbXML is an XML schema that allows for a detailed description of a single building or a set of buildings for the purposes of energy and resource analysis. These analyses can be used for determining a building's cost of operation, pollution produced, energy requirements, and health issues. It allows for data interoperability between 3D CAD applications and building analysis programs such as DOE-2.2.

3.3.2.4 ifcXML

ifcXML is an XML representation of the IFC EXPRESS model developed by the IAI. It adheres to the IFC content.

3.3.2.5 OSCRE

The Open Software Consortium for Real Estate (OSCRE) pursues the use case approach in defining XML schemas for information handovers. OSCRE's goal is to develop a set of definitions and protocols to facilitate a seamless automated transfer of data between disparate types of software packages that are used regularly by real estate owners, managers, service providers and their advisors. The OSCRE standard seeks to establish the methodologies for content payload and transport mechanisms to enable the technology systems of multiple trading partners to exchange information regardless of operating system or software application. OSCRE has a very well-defined methodology for the definition, development and harmonization of these XML schemas.

3.3.2.6 OGC

The Open Geospatial Consortium (OGC) is a non-profit, international, voluntary consensus standards organization that is leading the development of standards for geospatial and location based services. While not directly engaged in defining views of building information, OGC members have understood that buildings exist in a geospatial context and that building information must be accessible through geospatial and location based services. The OGC has entered into Memoranda of Understanding (MOU) with NIBS and the IAI to foster synergy and harmonization among the various organizations. A development in Germany known as CityGML was adopted as an OGC White Paper in 2006 and is now being considered for formal OGC standardization. CityGML is an open data model and XML-based format for storing and exchanging virtual 3D city models. Its developers have collaborated with other information modeling activities including the IAI IFC and this collaboration will continue in the framework of the OGC-IAI MOU.

3.3.3 Additional Information Sources

There are many organizations working on the development of data exchange standards for the capital facility industry. The American Institute of Architects (AIA) Technology in Architectural Practice (TAP) Knowledge Community maintains a website (<http://www.building-connections.info>) that lists many of these organizations and the areas in which they are working. It also provides links and contact information for these groups.

FIATECH also provides a Data Standards Clearinghouse as part of its website: <http://www.fiatech.org/projects/idim/dscdata.htm>. This Data Standards Clearinghouse provides summary information about the listed standards as well as links to the underlying sponsor organizations and standards efforts.

3.4 Classification, Metadata and Dictionaries

Common classification systems, metadata and terminology are also necessary for interoperability.

3.4.1 Classification

Information is organized and classified differently in each life cycle stage by different participants and by the various industry sectors. In order for information handed over to be useful, end users must be able to organize, extract and present it flexibly. A good classification framework is critical to managing and providing access to the information.

ISO 12006-2 provides a framework for the classification of information about construction works. Implementations of 12006-2 include Uniclass in the U.K. and OmniClass™ in the U.S. OmniClass, developed by the IAI/ Construction Specifications Institute (CSI) Overall Construction Classification System (OCCS) Committee, has been adopted for the NBIMS.

3.4.2 Metadata

Metadata are defined as data about other data. Metadata are used to organize the information and to search for particular items. A comprehensive metadata approach is necessary for long-term data access and preservation through the facility life cycle phases. There are three basic types of metadata, described as follows.

3.4.2.1 Descriptive Metadata

Descriptive metadata identify and describe the information with fields such as phase, discipline, material and so forth. ISO 12006-2 provides a framework for the classification of information about construction works and for this type of metadata.

3.4.2.2 Administrative Metadata

Administrative metadata are used to manage the information and include such fields as intellectual property status, file format, file size, creating system, archiving date, archiving expiration date and archiving refresh interval. This type of metadata is critical to implementation of a long-term facility life cycle information strategy. The Open Archival Information System (OAIS) Reference Model, ISO 14721:2003, defines an archival system dedicated to preserving and maintaining access to digital information over a long term. OAIS separates the details of format and preservation metadata from the other administrative metadata and places them in a separate Format Registry, which is designed to aid in data preservation and to monitor formats.

The Format Registry identifies all file formats stored in the archive and their properties, and automates the assignment of preservation strategies.

3.4.2.3 Structural Metadata

Structural metadata describe the internal structure of the information and relationships between its components. They can be used to track the relationship between a single drawing and the set to which it belongs, multiple revisions of the same document and the relationships among files in a compound electronic document (e.g., reference files making up a CAD drawing, or a spreadsheet linked to a document). They can also be used to describe the documents that derive from a particular information package in structured form.

3.4.2.4 Standards for Metadata

ISO 12006-2 provides a framework for descriptive metadata about construction works, as discussed above. For document metadata, there is ISO 82045-5:2005 *Document Management – Part 5: Application of Metadata for the Construction and Facility Management Sector*. It specifies elements and methods for sharing and exchanging metadata for documents in the architecture, engineering, construction and facility management domains. It is designed for use with both electronic and paper-based document management systems and includes all three types of metadata described above.

3.4.3 Dictionaries

There is a need for common terminology for both metadata and object properties. There have been a number of national efforts to develop dictionaries of common building terms and their definitions. The International Framework for Dictionaries (IFD), based on ISO 12006-3, is the leading multi-national effort. At a 2006 IAI meeting, the CSI and their Canadian counterparts agreed to join with the IFD partners to develop a common dictionary of standard terminology for the capital facilities industry.

4. Case Studies of Information Handover

It is helpful to learn from the experience of project teams that have undertaken information handovers the benefits actually achieved, the issues encountered and their advice for improving the process. The section below documents actual project experience. Please note that the diagrams illustrate the primary direction of workflow. There are often many iteration loops.

4.1 Helsinki University of Technology Auditorium Hall 600

Product Model 4D CAD (PM4D) Final Report (CIFE Technical Report Number 143), published in 2002 by Martin Fischer and Calvin Kam, presents the findings from the design and construction of the Helsinki University of Technology Auditorium Hall 600 (HUT-600) in Finland. This study was one of the first to document the process and quantify the effectiveness of intelligent modeling combined with data sharing across a broad range of applications (i.e., information handovers).

Running simultaneously with the design and construction of the HUT-600 project, an international research team, funded by the Finnish National Technology Agency (TEKES) applied the product modeling approach, tested the Industry Foundation Classes (IFC 1.5.1) interoperability standards, and used an expanded set of design, visualization, simulation, and analysis tools on the 17-month, US \$5-million capital project. The ultimate goal of this effort was to make a lasting and positive effect on the facility over its total life span. Thus, the effort represents an owner-driven strategy to optimize facility life cycle value and operational costs.

The team actively engaged in the PM4D effort included the property owner, Senate Properties, design consultants A-Konsultit Oy (architecture), Magnus Malberg Consulting Engineers Ltd. (structural) and Insinööri Olof Granlund Oy (building systems). The construction manager/ general contractor, YIT Corporation, was also involved beginning with concept development. Researchers were the Center for Integrated Facility Engineering (CIFE), Stanford University. Data from product manufacturers was also incorporated in information handovers.

Electronic copies of the study can be obtained at <http://cife.stanford.edu/Publications/index.html>.

4.1.1 Benefits Realized

The three areas of technology explored were:

- Intelligent, object-oriented modeling (structured data)
- Use of IFCs (standard format) for data exchanges, and
- Use of an expanded number of computer simulations and analyses, supported by the availability of a structured and comprehensive electronic building description.

Benefits realized on HUT-600 included improved design quality, life cycle facility performance, near and long-term costs, budget control, and the design and construction process. The project was able to shorten design cycle times and minimize data re-entry. The use of structured (machine-interpretable) information exchanges was responsible for both the reduction in data re-entry and the ability to run many more analyses than is typically possible. In spite of the schedule

constraints of a fast-track approach, the project team was able to generate three design and two life cycle alternatives. The time savings were quantified as approximately 50 percent in design documentation.

4.1.2 Who Benefited

The PM4D Approach assisted the building owner in aligning the building design with the strategic plan and long-term facility considerations. Pertinent decision factors and project alternatives were available early during the schematic design phase, when making a decision had a relatively high impact and low cost. Consultants were able to optimize the design, thus providing enhanced service. The construction manager/ general contractor was able to produce an accurate cost estimate and use 4D techniques to plan construction sequences.

4.1.3 Information Packages Exchanged

The following information packages were exchanged via IFC 1.5.1 format:

- Building geometry, material types to COVE software for cost estimating
- Building geometry, Heating, Ventilating and Air-Conditioning (HVAC) system geometry to Common Point for 4D animation
- Building geometry, material types, construction assemblies, HVAC system geometry to ArchiCAD
- Wall types, surface areas to BSLCA software for life cycle environmental impact analysis
- Building geometry, space IDs to RIUSKA software for energy analysis, and
- Design temperature, air flow rate to MagiCAD for HVAC system sizing.

The following diagram shows the information packages in all formats exchanged during the project.

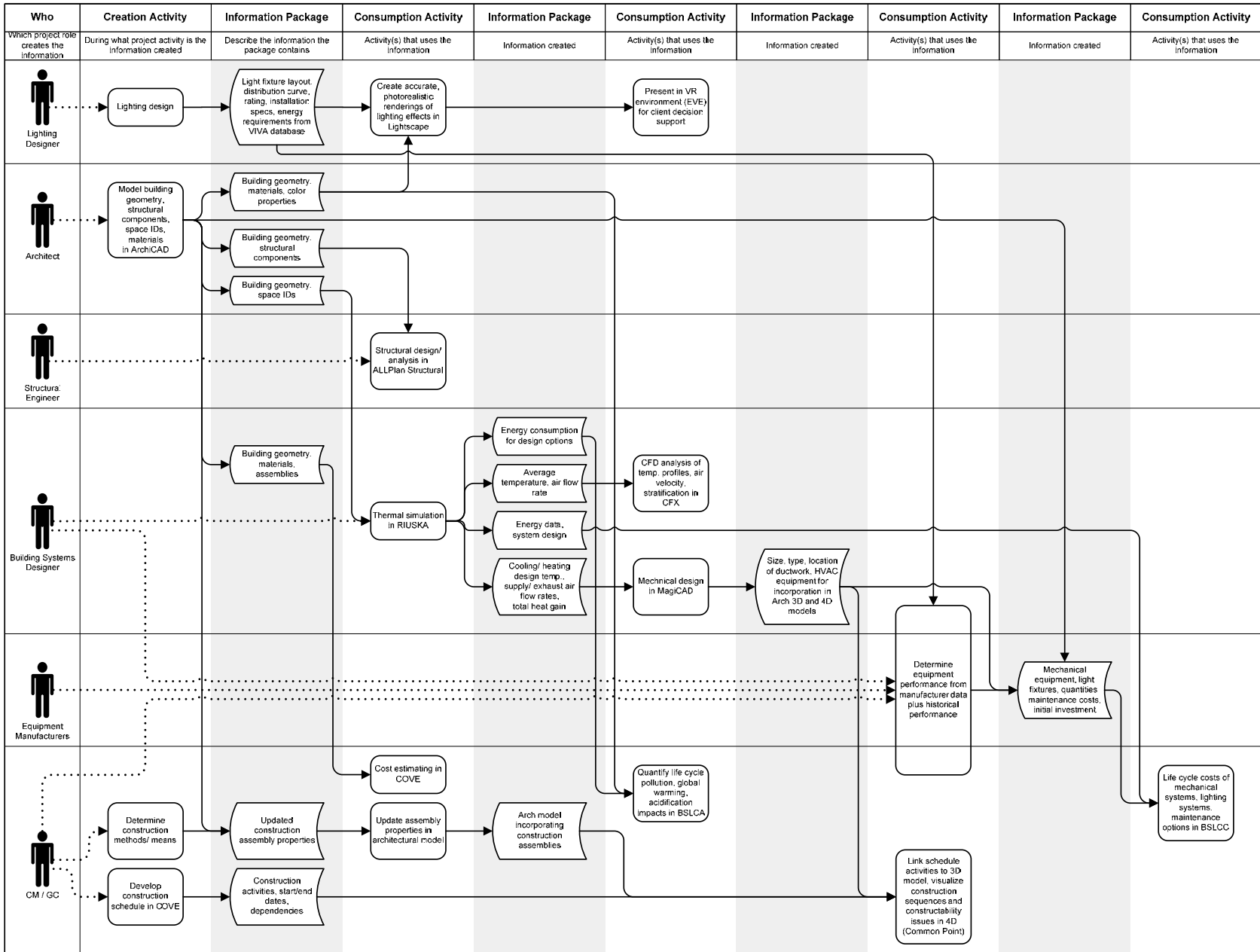

Helsinki University of Technology Auditorium Hall 600

4.1.4 Issues Identified

From the technical perspective, the PM4D researchers identified a number of issues:

- Large file sizes
- Lack of model revision management tools
- Need for interventions and mappings to support data exchanges
- Bugs, instability and lack of IFC write capabilities in authoring software, and
- Need to create new definitions of architectural elements, cost items and construction resources.

4.1.5 Recommendations for Future Efforts

They also made a number of recommendations for future projects:

- Develop multiple models
 - Core model
 - Discipline-specific models
- Use partial data exchanges
- Develop and adopt interoperability standards to reduce the requirement for mappings and intervention in data exchanges
- Improve scalability and extensibility by referencing external data, and
- The industry needs to develop better model management tools – most standard extranet products provide file management but models must be managed at the component level.

4.2 General Motors Virtual Factory Initiative

The General Motors (GM) Worldwide Facilities Group's Virtual Factory Initiative is an example of an owner-initiated strategy to improve project delivery. With capital construction on the critical path to product delivery, GM was determined to apply lessons learned in manufacturing – particularly Lean techniques - to its capital facilities projects.

Lean Construction defines seven forms of waste:

1. **Correction:** Rework on some tasks because of errors in the design process discovered after work was started
2. **Overproduction:** Performing work ahead of schedule, causing interferences with other planned work or additional material ordered due to inability of suppliers to provide quality
3. **Motion:** Construction teams returning back to “office” to pick up plans, tools or materials not available at the site
4. **Material Movement:** Moving materials from one staging to another, handing off work between crews
5. **Waiting:** People waiting for equipment, plans or instructions on how to proceed, or waiting for material because of ineffective supply chains
6. **Inventory:** Material staged on site too far in advance of when needed, and
7. **Processing:** Redundant or unnecessary reporting, expediting material orders, or excessive coordination between suppliers.

GM decided to pursue Lean Construction through a 3D/4D technology-enabled design/build project delivery process. Between 2004 and 2006, GM completed four automotive plants, extending the use of these technologies with each. This decision was more time-driven than cost-driven.

Key team members actively engaged in the Virtual Factory Initiative included GM Worldwide Facilities Group (owner), Barton Malow Design (architecture), Ghafari Associates (AE plus 3D/Lean integrator), Ideal Contracting (GC) and multiple subcontractors: John E. Green (piping and fire protection), Douglas Steel (steel fabricators), Superior Electric (electrical) and Dee Cramer (HVAC). Team members were pre-qualified based on experience with 3D delivery. Throughout all projects, Ghafari filled the role of model manager.

The GM approach is to develop a 100 percent complete 3D model incorporating all architectural, structural, mechanical and electrical elements, including shop drawing-level details provided by the subcontractors and fabricators. Using NavisWorks Clash Detector, the team identifies and resolves all interferences before the start of construction. Then the construction team builds to the model, without deviations.

4.2.1 Benefits Realized

GM has achieved excellent results. The Virtual Factory approach has resulted in a higher degree of off-site fabrication and just-in-time delivery. By the second project, design/ construction time was reduced by 24 weeks (28 percent). This is 60 percent faster than a traditional design-bid-build approach. Also by the second project, the design/build team resolved every interference in the computer model before starting construction. Change orders historically were 8 to 10 percent of project cost. Based on these four projects, change orders due to building component interferences and rework have been reduced to less than 0.5 percent. Unanticipated benefits have included six-figure reductions in waste removal charges and improved site safety.

4.2.2 Who Benefited

GM believes strongly that all project participants benefit from the Virtual Factory approach. AE firms and contractors who master Lean and 3D gain competitive advantage in pursuing work as well as lower structural costs. GM benefits from:

- Lower cost
- Higher quality
- Faster delivery, and
- Improved safety

4.2.3 Information Packages Exchanged

In the initial two projects, the focus was on creating and interference checking the 3D models. The information handed over was therefore 3D geometry in proprietary Computer-Aided Design (CAD) formats. Each company created the information relevant to its project role. Model ownership transitioned from engineers to subcontractors at what would normally be considered detailed design. The subcontractors created the installation-level 3D models, accurate to ¼ inch tolerances. Ghafari augmented some subcontractors' capabilities in this regard. An additional handover was from detailed design to fabrication for steel and HVAC components.

In the third project, the complete steel supply chain was integrated – design, analysis, detailing, fabrication, erection. Steel shop drawing review was replaced by a 3D review process. The CIMsteel Integration Standard, Release 2 (CIS/2) was employed for some steel data exchanges:

- Data exchanges from analysis to modeling or detailing systems used direct application-to-application interfaces
- Data exchanges from detailing to modeling systems used CIS/2 translators to check geometry and maintain some intelligence
- For review of shop drawings the team used the native detailing system authoring functionality to review/approve the detailed models.

The fourth project introduced quantity take-offs for cost estimating and the handoff of 3D building components to a 4D application (NavisWorks Timeliner) for animating construction sequences.

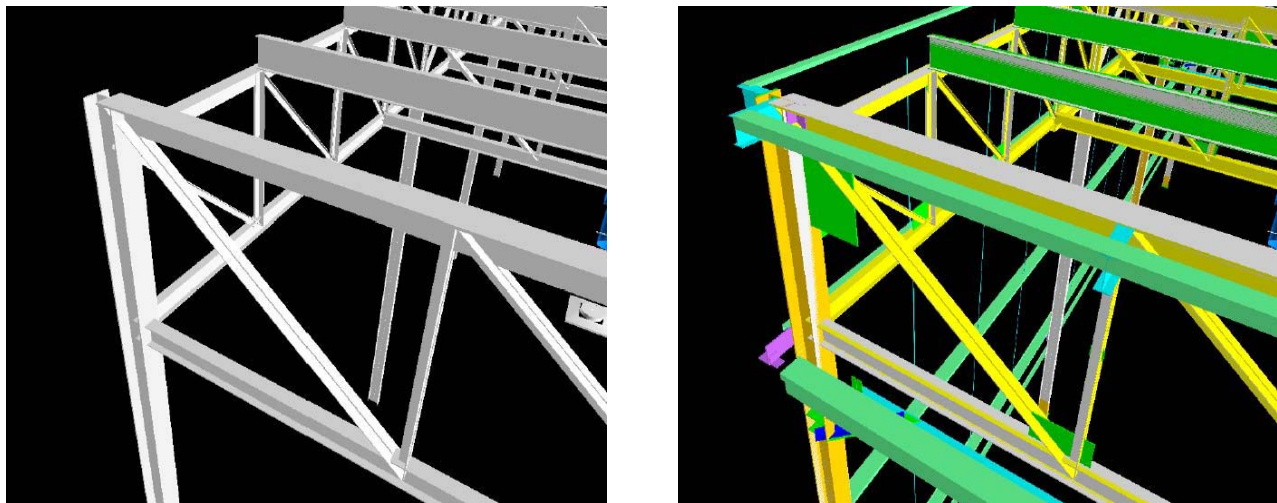
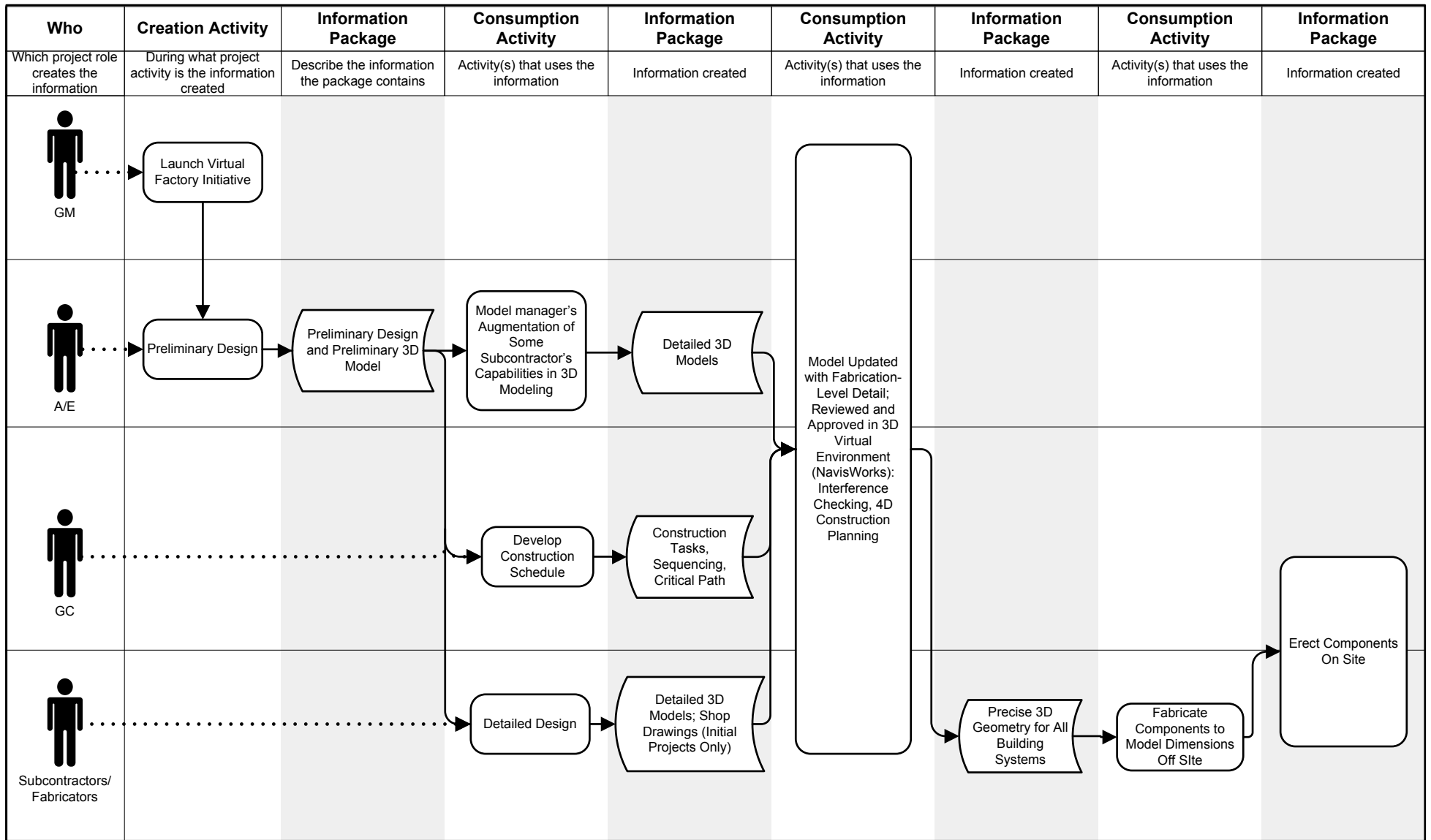

Figure 4-1: The model on the left is the preliminary design model. The model on the right is the model produced by the steel fabricator.

The following diagram shows the information packages in all formats exchanged during the project.



General Motors: Virtual Factory Initiative

4.2.4 Issues Identified

Due to the presence of a supportive owner and a team pre-qualified on the basis of their 3D capabilities, the Virtual Factory Initiative has progressed smoothly. The fact that the multiple projects were undertaken in rapid succession allowed a building of expertise and a continuous improvement. Nevertheless, some issues were identified:

- Initial reluctance to “trust” the 3D model
- Necessity to modify the International Organization for Standardization (ISO) quality procedures to maximize benefits of 3D delivery, and
- Poor software management of unique object IDs: although the CIS/2 standard provides for unique and permanent IDs, the available CIS/2 software applications do not necessarily support or maintain that ID. Some analyses redefine the model as completely new elements, severing the link to the original model components from the analysis results.

4.2.5 Recommendations for Future Efforts

Model management was the area identified for future technical development. A continuity of information is required. Based on experience with CIS/2 implementations that did not support the maintenance of Globally Unique Identifiers (GUID), it is recommended that IFC software certification require the maintenance of the unique object IDs. There is also the question of versioning model components: if the component is modified, the ID should either be versioned or, if the change is major, somehow related to the precedent component.

4.3 The Adaptive Re-Use of Soldier Field

The Chicago Bears wanted a major reconstruction of the Soldier Field stadium without playing away from home for more than one season. This required construction of the US \$600 million project to be completed in twenty months, 17 percent faster than industry best performance. Nevertheless, the partly publicly-funded project was initiated with a traditional design-bid-build delivery approach.

Multiple owner organizations were involved. The Chicago Bears were the developers and the Chicago Park District was owner. The Illinois Sports Facilities Authority provided 2/3 of the funding. Hoffman Management Partners was the developer’s representative, holding all design and construction contracts.

Thornton-Tomasetti, the structural engineers, suggested that the steel be modeled in 3D and that the 3D model be used for bidding, fabrication and erection. This would streamline information flow from design through analysis, detailing, fabrication and erection to eliminate lag time and redundancies. The motivation for using these electronic information handovers was that the stadium simply could not be finished on schedule using the traditional process.

This was, therefore, a supply chain strategy initiated by the structural engineers.

The project team included consultants Wood-Zapata Architects and Lohan Caprile Goettsch. (architecture), Thornton Tomasetti (structural engineering) and Ellerbe Becket (MEP). The Construction Manager (CM) was Turner Barton Mallow Kenny Joint Venture (TBMK) and

subcontractors included Hirschfeld Steel, Danny's Erectors, Area Erectors, JW Peters, Concrete Structures, and Permasteelisa/Gartner.

Only the steel supply chain and the curtainwall subcontractor used 3D modeling techniques.

4.3.1 Benefits Realized

This was a very focused use of electronic information handovers in structured form to shorten the construction schedule and that goal was achieved. The exchange of electronic data was primarily responsible for shortening the construction schedule by four months and meeting the Chicago Bears' occupancy deadline. Interference checking between steel structure and the precast seating risers permitted modifications to those risers.

4.3.2 Information Packages Exchanged

The project was a mix of 2D and 3D methods, with traditional design phasing. Through Schematic Design, all techniques were 2D. In Design Development, Thornton Tomasetti produced the first 3D Xsteel model. In addition, the following information was exchanged:

- The architects received and coordinated all consultants' 2D AutoCAD files
- Thornton-Tomasetti produced quantity takeoffs from Xsteel model for pricing by CM
- Thornton-Tomasetti exported 3D images in JPG format from Xsteel to architects to clarify certain conditions
- Xsteel model was issued in native format as a construction document to the steel fabricator and the curtainwall subcontractor, and
- Steel shop drawings were submitted as 3D models with erection plans.

The following diagram shows the information packages in all formats exchanged during the project.

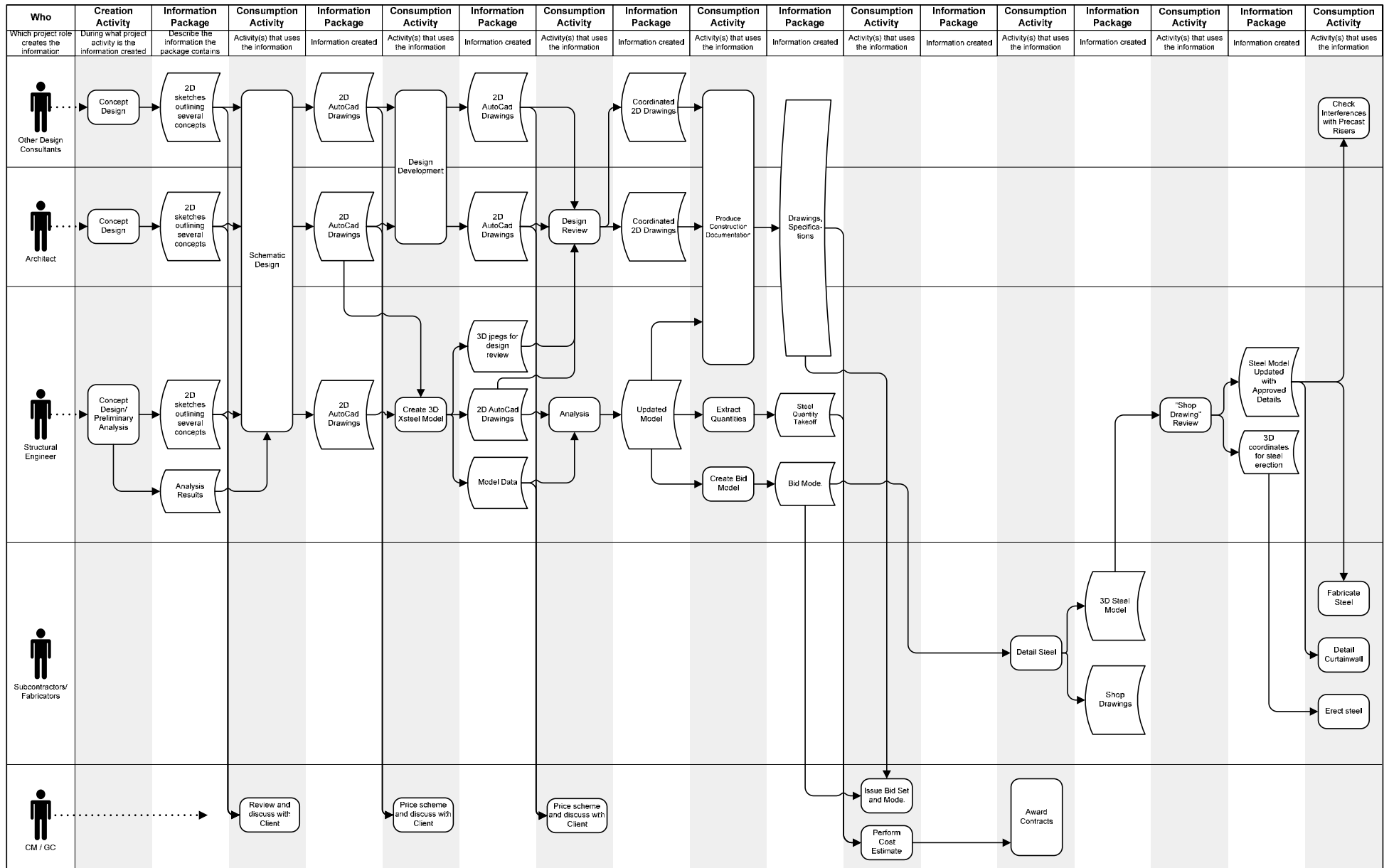

The Adaptive Re-Use of Soldier Field

4.3.3 Issues Identified

The decision to use 3D modeling and electronic information handovers for steel was made once the project was already underway. Thus, project planning had not anticipated this approach. This led to a number of issues:

- Most team members were skeptical of the 3D model. This skepticism extended to refusal to fund the performance of interference checks between steel structure and precast seat risers for the entire stadium
- Architects and MEP engineers did not change their methods to facilitate the 3D process. Biweekly exporting of 2D AutoCAD drawings from 3D steel models was cumbersome, time-consuming and redundant
- Similarly, the owner required the delivery of both traditional steel shop drawings and the 3D Xsteel models, also requiring redundant information and effort, and
- The design-bid-build delivery approach prevented working with fabricators and subcontractors during design.

4.3.4 Recommendations for Future Efforts

Despite the challenges encountered, this supply chain information strategy was successful in meeting the owner's requirement for a dramatically compressed construction schedule. Thornton Tomasetti offered some comments and suggestions to build upon this success:

- The process of modeling a structure in 3D saves a large amount of time
- The 3D model has to be 100 percent accurate
- Choosing the subcontractors early and allowing them to have design input would save time and redundant effort to match specifications
- The major portion of the design/coordination is typically done too late in the project schedule
- The practice of issuing 2D drawings from a 3D model should be discontinued
- Project roles must change with a 3D approach, and
- There should be incentives for teamwork. The best value to the owner comes from the most efficient team: all parties involved in the design/ construction process working towards the overall success of the project and not solely for their own interests.

4.4 Harborview Medical Center Expansion

The Harborview Medical Center Expansion consists of an Inpatient Expansion Building and a clinic/ laboratory with five parking levels. The project delivery approach was a negotiated bid with the contractor on board from the beginning of the project.

On this project, NBBJ, the architects, used intelligent building modeling techniques. NBBJ's Design Technology Lead (DTL) was responsible for establishing the work processes and standards, and providing BIM training. NBBJ handed over the model data to Turner Construction at the bid phase. Turner took NBBJ's Bentley TriForma BIM files, and although they imported them into NavisWorks, Turner remodeled the building to better suit their construction sequences and needs.

Turner Construction Company embraced the use of 3D models for identifying conflicts and understanding construction sequences, aggressively using dual overhead illuminated wall projection screens to coordinate the construction work with the client, subcontractors, consultants and the architect. During construction, NBBJ updated the model to reflect any changes resulting from RFIs or Change Orders.

Additional integration was achieved at the project controls level with NBBJ's interfacing their internal construction administration system, CATools, with the owner-mandated Prolog system.

This project is a good example of an architect- and contractor-led information strategy of enhancing their own project delivery performance.

The client in the Harborview Medical Center Expansion is the University of Washington. The owner is King County of Washington state. The owner's rep is the University of Washington's Capital Projects Office (CPO). The lead design consultant is NBBJ, Seattle (architecture), with MKA (structural and civil) and Sparling (electrical). Turner Construction Company is the general contractor.

4.4.1 Benefits Realized

The Harborview Medical Expansion project is still in construction at this time, so it is not possible to quantify owner benefits in terms of schedule or cost savings. Turner Construction quickly realized coordination benefits and time savings from the 3D process. NBBJ and Turner intend to use this approach on future joint projects.

This was an early Building Information Modeling (BIM) effort for NBBJ. It provided the opportunity to establish and test the firm's BIM standards. Also, technical details modeled for this project have already been applied to other healthcare projects.

4.4.2 Information Packages Exchanged

Like the Soldier Field Renovation, this project used a mixture of 2D and 3D data exchanges:

- Design consultants exchanged primarily 2D data in DGN and DWG format, and
- Bentley TriForma BIM files produced by the architects to NavisWorks for use by the contractor

The following diagram shows the information packages in all formats exchanged during the project thus far.

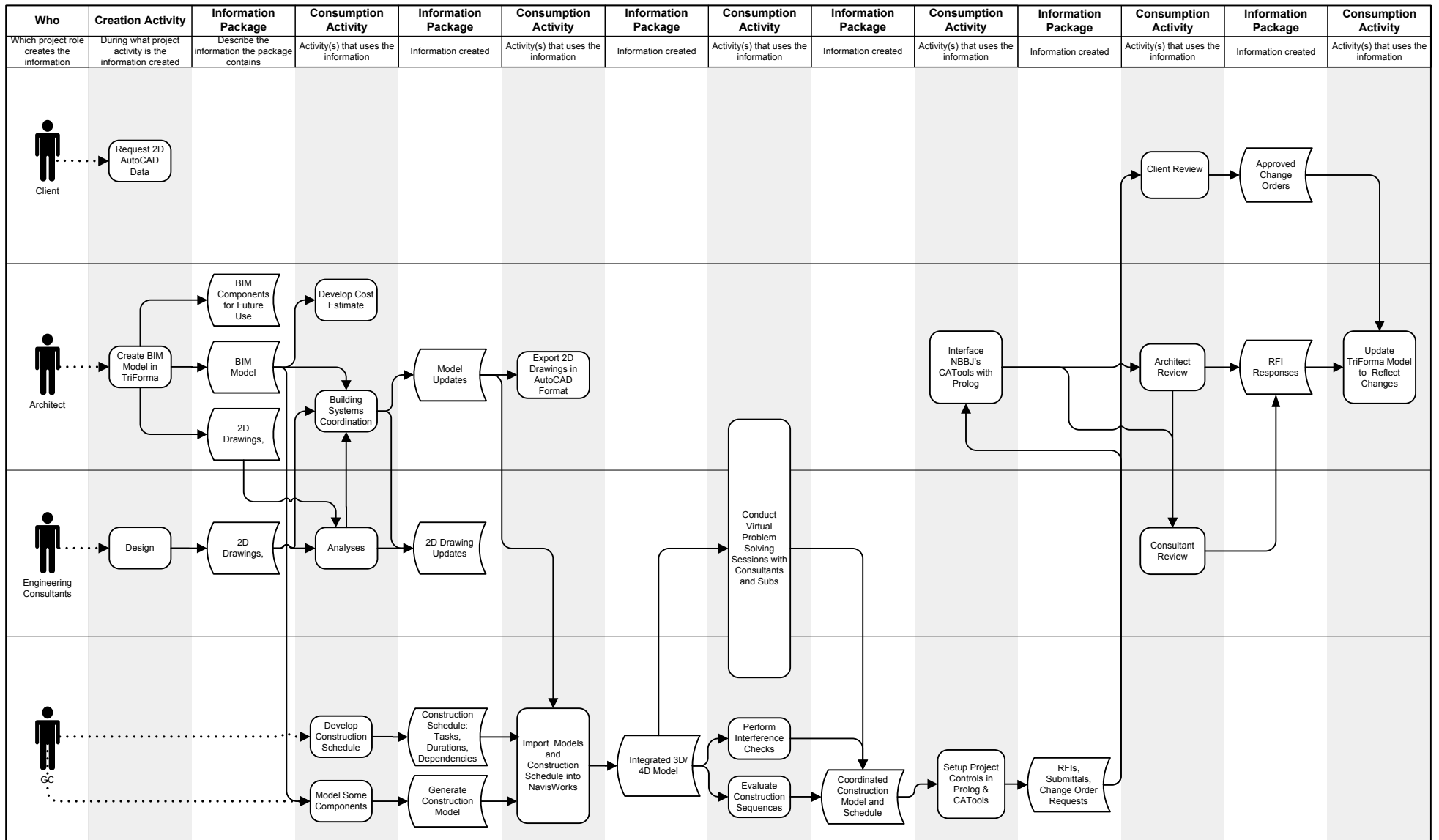

Harborview Medical Center Expansion

4.4.3 Issues Identified

This was an early BIM effort for NBBJ and one in which the structural and MEP consultants would not adopt 3D techniques. This created some challenges:

- Project started using early version of TriForma and there were some software problems
- Senior staff members required TriForma training; some would not change from 2D techniques
- MEP consultant promised 3D capability but did not deliver, and
- There was an unanticipated request from the client and consultants to translate data to AutoCAD format.

4.4.4 Recommendations for Future Efforts

This 3½-year design project suffered from the immaturity of BIM software and limited industry understanding of how BIM should be used. However, it benefited from a sufficient duration to climb the learning curve and maximize the software potential for 3D design and construction planning integrated with scheduling and cost estimation. Recommendations from NBBJ to other teams include:

- Determine the model integrator at project outset
- Allow the model integrator to visit and train other team members
- Have the BIM conversations as early as possible to work together and avoid re-modeling and
- Expect stumbling blocks and potentially higher production costs on the first project.

4.5 Wellcome Trust, UK

The Wellcome Trust facility is a world-class genome research facility located in Cambridge, UK. It includes a laboratory, laboratory support space and a data center. Its total size is approximately 20,350 square meters. This project was designed and constructed under a very non-standard and forward-thinking contractual and risk sharing arrangement that created an environment of collaboration, cooperation and trust. Subcontractors participated in finalizing the technical design of the project, resulting in better coordination and quality.

The client was the Wellcome Trust and the owner was Wellcome Trust Construction Ltd. NAI Fuller Peiser was the owner's representative. The lead design firm was NBBJ, London. The CM was Mace, which issued trade contract packages to subcontractors selected jointly with the client. The procurement process was non-confrontational and the owner self-insured the construction phase. All trade contractors executed contracts directly with the owner. The commissioning consultant was Commissioning Management Ltd. (CML).

There were a number of special considerations in the design of and information handovers for the project. The building was designed to achieve an "Excellent" rating for a science facility according to the BREEAM standards (UK standard similar to U.S. LEED). The commissioning consultant required electronic handovers for the client's operations and maintenance activities. Comprehensive commissioning practices ensured cost savings and better coordination. In addition, the client requested electronic handovers for the Building Management System (BMS).

The information strategy for this project was owner-driven, with dual emphases on project delivery and optimizing life cycle operations.

4.5.1 Benefits Realized

The project delivery achieved goals in all dimensions: budget adherence, schedule adherence and quality of the facility. The value of information handovers to operations and maintenance and to the BMS has not yet been quantified. Although the owner benefited most, all parties performed profitably and valued the opportunity to work in a collaborative, non-confrontational environment. NBBJ received ISO 9001 Quality Management System certification based on the standards and procedures they developed for this project.

4.5.2 Information Packages Exchanged

During the project process, files were shared collaboratively using the BWI Electronic Documentation Systems. Information creation software included TriForma, AutoCAD and X-Steel. NBBJ shared TriForma model data with all parties: consultants, client, construction manager, trade contractors and the metal and curtainwall fabricators.

Additional information handovers were to:

- Operations and maintenance, and
- Building management system

The following diagram shows the information packages in all formats exchanged during the project.

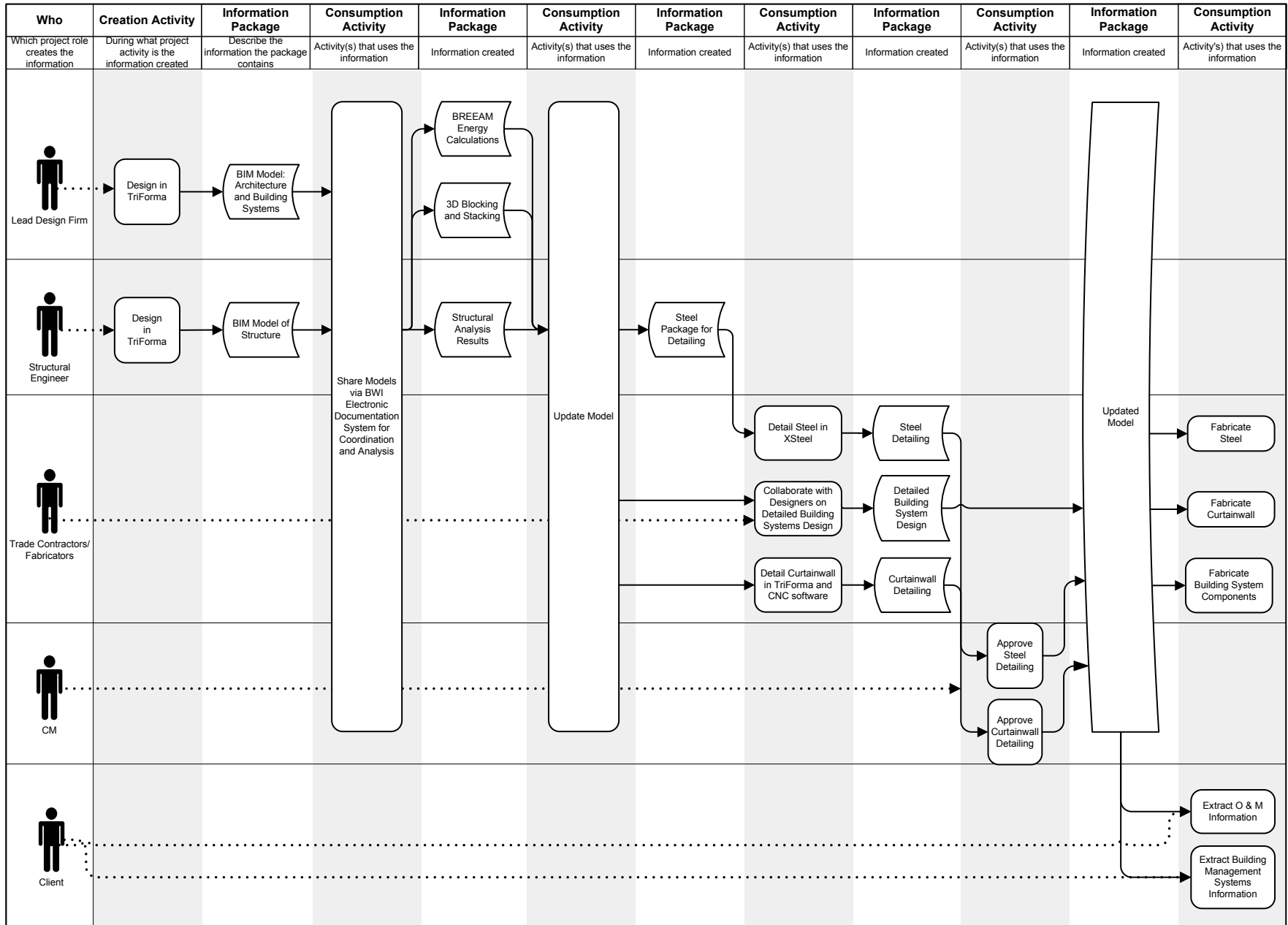

Wellcome Trust, UK

4.5.3 Issues Identified

This was NBBJ London's first major project. The office needed to develop system standards and templates that conformed to jurisdictional standards and regulations. Creating these system standards and templates was an expense, but they were instrumental in NBBJ's achieving ISO 9001 Quality Management System certification.

4.5.4 Recommendations for Future Efforts

NBBJ believes that this project serves as a positive model in several areas:

- Commercial terms
 - Create trusted partnerships and create alliance contracts with those trusted partners
 - Build language into the contract that as many trades as possible will be involved as soon as possible
 - Share the risks
- Communication
 - Visioning workshops with 40 users to understand, synthesize and prioritize goals, aspirations and constraints
 - Intensive User Representative Meetings focused on clarity of process and deliverables
 - Periodic reviews during production phase to keep user groups informed of project status developments and changes
- Project "Change Control Procedures" and "Zero Defects Program" involved weekly meetings with the client, facility manager, contractor and engineers for 6 months after project closeout to quickly identify, evaluate and resolve any operational issues.

4.6 Buckley Army Aviation Support Facility

The Buckley Army Aviation Support Facility was a mixed use project:

- 6040 square meters of helicopter maintenance hanger
- 2320 square meters of shop and storage space, and
- 2320 square meters of office space for administration and flight operations.

The project was delivered via a traditional design-bid-build approach. Design took place 2003 to 2004 and construction 2005 to 2006. CH2M Hill, Corvallis, Oregon was the lead Architectural/Engineering (AE) firm. The firm established a collaborative electronic environment where 3D design models provided a vehicle for visual communication with the client and among team members. Information was also stored and shared via a non-graphic project database.

The client for this project was the Colorado Army National Guard. Consultants included Coover-Clark and Associates, Paragon (for land surveying), GEOCAL (for geotechnical engineering), and Rolf Jensen and Associates (fire suppression systems). The General Contractor was PCL Construction Services and the CM was Troy. There were approximately 36 subcontractors on this project.

Although the client defined the information requirements for the project, the Buckley Army Aviation Support Facility project is an example of a design firm-led information strategy

directed at enhancing the firm's project delivery performance. CH2M Hill has invested in developing a standardized four-phase design process that defines a uniform scope and set of deliverables for each phase. In addition, the firm has developed a number of proprietary software tools to support this design approach.

4.6.1 Benefits Realized

The major business driver for this project was schedule. By creating 3D models that could be shared and reviewed with the client via Live Meeting sessions, communication was improved and decision-making expedited. In addition, analyses such as structural and lighting were performed using the design models. The technology was deployed in response to this specific project schedule requirement.

4.6.2 Who Benefited

All parties – owner, consultants and contractor – benefited from the ability to deliver the project on time. The contractor was a major beneficiary since the contract provided for liquidated damages if construction extended beyond 2006. However, the model was not deemed sufficiently accurate for the extraction of quantities for cost estimating.

4.6.3 Information Packages Exchanged

The primary information package exchanged was 3D geometry. This was communicated via an Oracle application, CADView-3D. This tool was used throughout the design process to provide virtual walk-throughs. Design review comments were logged in DR Checks (Design Review and Checks System).

Building geometry, materials and light fixture locations and types were exchanged with lighting analysis programs.

Structural member dimensions, locations and sizes were extracted from the model for structural analysis. This information exchange was two-way, with the analysis program updating the structural model.

Non-geometric data were stored in a project database. They could be queried from within the model or via SQL and exported to Microsoft Word or Microsoft Excel format for sharing with other team members.

The following diagram shows the information packages in all formats exchanged during the project.

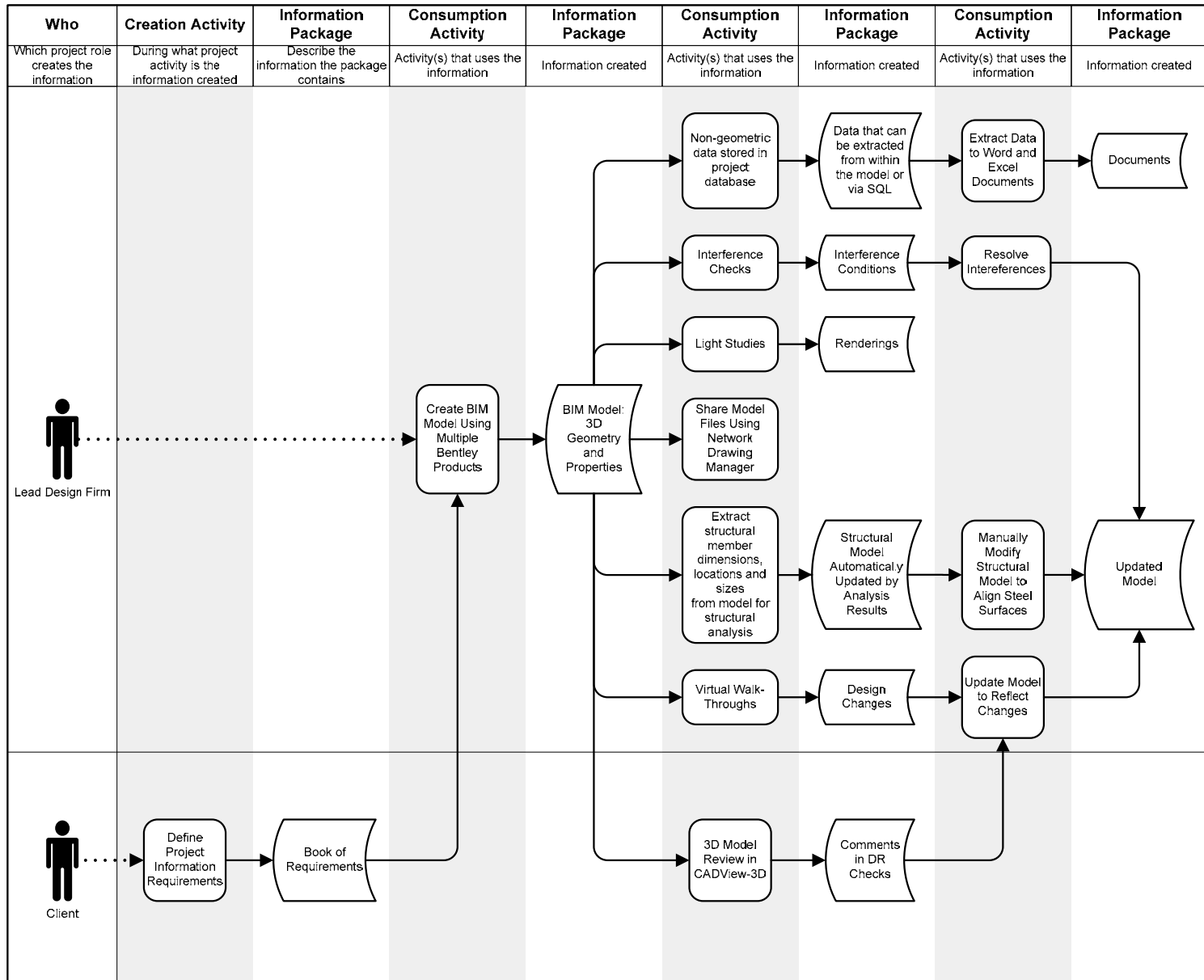

Buckley Army Aviation Support Facility

4.6.4 Issues Identified

CH2M Hill's standard project delivery approach was at odds with the flow of information and decision-making necessary to support the 3D modeling approach. As a result, model production fell behind schedule. This prompted the team to take shortcuts that proved problematic. Specific issues included:

- Modeling began before there was an opportunity to define project procedures so that quantities could be extracted consistently and accurately. This prevented the use of automated quantity take-offs
- Details developed without referencing the model were inconsistent with the design, and
- The team attempted to use a two-way interface between the Bentley Structural and the structural analysis program (Midas). The promise was that the analysis would update the member sizes in the model and load model information into the analysis tool if members were changed in the model. However, every update to the model from Midas required manual intervention because the analysis program always resized members around their centerlines. The model then needed to be manually updated to align steel surfaces. This proved to be very cumbersome. The team used the automated approach through design development and then abandoned it.

4.6.5 Recommendations for Future Efforts

The introduction of a building modeling approach changes the way the design team must work. Specific recommendations in this regard include:

- Spend more time setting up the project before the work begins
- Do more model work in the concept phase
- Schedule engineering decisions sooner, and
- Strictly enforce that details are generated from model extractions.

Software capabilities for two-way exchanges between the design model and structural analysis require further development.

Because this is a change in work process, it is critical to engage the team in the change process and win their endorsement.

5. Planning, Executing and Managing Information Handovers

Figure 5-1 illustrates the steps in a successful information handover.

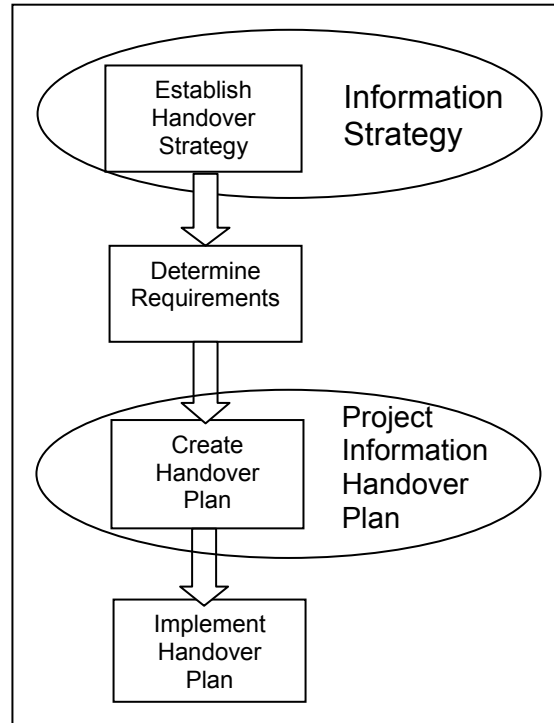

Figure 5-1: Information Handover Steps

5.1 Overview

The following is a summary description of each step.

- **Information Strategy:** Every organization involved in the design, procurement, construction or operation of capital facilities should develop an information strategy. The strategy will be driven by business purpose. The information strategy should prioritize information and assign a business value to various information packages. The strategy should also be consistent with the organization's data security policies.
- **Information Handover Requirements:** The organization must define the contents as well as the appropriate information form and format for each information package required and also consider the associated metadata. This step will inform the Project Information Handover Plan.
- **Project Information Handover Plan:** This plan not only covers the information handover requirements, but also covers responsibilities and implementation methods. In particular, the originator of each information package must be identified. Conflicting handover requirements of the various team members, particularly format preferences, must be resolved.

- **Implementation:** This step includes technical implementation as well as establishment of project procedures, contractual responsibilities and training programs.

5.2 Information Strategies

The organization's information strategy should cover the following topics:

1. What facility information is important
2. When this information is created and by whom
3. Contractual, legal and regulatory issues related to this information
4. Who within the organization will be responsible for capturing, checking and maintaining the information
5. How the organization's data management and security policies will be applied to this information

5.2.1 Information Strategies for the General Buildings Sector

The *Capital Facilities Information Handover Guide (CFIHG) Part 1* suggests that an information handover approach must derive from a facility life cycle information strategy defined by the owner. In the general buildings sector, however, there appear to be at least four different and effective information strategies:

1. **Owner Strategy to Optimize Facility Life Cycle Value:** The first is the strategy envisioned by the CFIHG *Part 1*. Owners endeavor to improve facility life cycle operations and reduce total life cycle costs by first identifying the information packages critical to both project and long-term facility management and then defining information handover requirements. In the general buildings sector, major owners taking this approach include U.S. federal government agencies, particularly the U.S. National Aeronautics and Space Administration (NASA) and the Department of Defense (DoD). The Construction Operations Building Information Exchange (COBIE) project, which is funded by NASA and executed by the Engineer Research and Development Center at the Construction Engineering Research Laboratory (CERL), is the most current effort.
2. **Owner Strategy to Improve Project Delivery:** Another owner-initiated strategy focuses on improving construction project delivery. In 2004, the Construction Users Roundtable (CURT) released a white paper (**WP-1202**), *Collaboration, Integrated Information and the Project Lifecycle in Building Design, Construction and Operation*. This paper was produced by CURT's Architectural/ Engineering (AE) Productivity Committee, which was convened to address the perception of inadequate, poorly coordinated AE drawings that result in difficulties in the field, leading to cost and schedule overruns. CURT directed this committee to evaluate how alternative processes, particularly the use of information technology combined with changes in project structure and delivery methods, might address these issues. Starting in 2004, General Motors (GM) Corporation, a CURT member, assisted by Ghafari Associates as AE and technology integrator, undertook a series of capital projects that have moved progressively toward full virtual design and construction before any activity begins on-site. They have progressively eliminated 2D drawing submissions in favor of direct electronic data exchanges and 3D reviews. GM's goal is to reduce waste, non value-added work and rework on the construction site, thereby achieving lower cost, higher quality, improved schedule and greater safety.

3. **Consultant or Contractor Strategy to Improve Project Delivery:** A very different strategy, often with similar results, is a designer- or contractor-led effort to optimize building design and/or construction in one or more performance dimensions (building performance, systems coordination, cost, schedule, quality) and thus create a competitive advantage for the company or team. Major design firms, including Anshen+Allen, Architects, CH2M Hill and SOM have embarked on path toward increased building performance simulation and design validation in areas such as lighting, thermal performance and sustainability. In addition, firms such as Anshen+Allen, Architects, Ghafari Associates and NBBJ now develop design models that can be handed over for purposes such as cost estimating, interference checking, constructability reviews and 4D simulations. Holder Construction, Webcor Builders and Mortenson Construction are examples of construction companies that seek to work with design firms to achieve bidirectional transfers of building and systems geometry and assemblies.
4. **Supply Chain Strategy:** Perhaps the most well-developed information strategy in the general building segment is a supply chain strategy. Supply chain strategies seek to streamline information flow from design through analysis, detailing, fabrication and erection to eliminate lag time and redundancies. The goal is to deliver product better, faster and at a lower cost, creating competitive advantage for the entire supply chain. The American Institute of Steel Construction (AISC) began an Electronic Data Interchange (EDI) initiative in 1999. Very quickly, users of the CIMSteel Integration Standards Release 2 (CIS/2) data exchange standard were able to reduce the time it takes to design, procure and erect a steel structure, at the same time reducing field interferences and waste, and thus cost. Structural engineers, Thornton Tomasetti, first engaged in bidirectional data exchange with steel detailers and fabricators for the Soldiers Field project and succeeded in shortening the construction schedule by 4 months. The steel supply chain initiative was quickly followed by a precast concrete effort led by an ad hoc organization, the Precast Concrete Software Consortium.

In establishing an information strategy, each organization examines its facility-related business regulations, decisions and processes and defines the information required by each, known as an “information package.” It prioritizes information packages based on business value. For example, a comprehensive inventory of light fixtures might be helpful, but that information may have lower business value than knowing the rentable area of the building. If a certain information package is used in many business processes, its value increases. Another way to identify high-priority information packages is by looking at businesses processes that are inefficient and/or costly due to lack of information.

Once the organization has identified its high-priority information packages, it then determines when in the facility life cycle those information packages are created and by whom. Some information packages may be created across multiple life cycle phases and by several different organizations. This is typically the case with commissioning information, for example.

Information developed in one project phase may not be used at all in the next sequential phase, but may have great value in downstream processes. For example, although it may not be important for the contractor to know the reserve capacity of a facility’s cooling system, that information will be important if the facility is ever expanded or converted to another use.

Therefore, that information should be required at the handover point from design to construction. It will be critical to identify the next user of each information package as well as the party responsible for receiving each information package, ensuring its completeness and maintaining its integrity until its next use.

By defining the contents of high-value information packages, as well as when, how and by whom those packages are utilized, and when and by whom the information is created, the strategy provides guidance to all participants in capital facility projects on appropriate information handover requirements and also informs the issue of appropriate data forms and formats

5.2.2 Contents of the Information Strategy

It is critical that those making day-to-day decisions on capital projects understand the high-level purpose of information handover. By communicating the ultimate use and relative importance of various information packages, the information strategy permits designers, project managers and contractors to make appropriate decisions about handovers on their projects. In addition, the information strategy serves as the source document for detailed handover requirements and project-specific handover plans and for integration with enterprise applications.

The major sections of the facility life cycle information strategy should include, at a minimum:

- Management policy statement, stressing the business importance of successful information handover
- Identification of major information packages with:
 - Explanation of their business purpose and importance
 - Life cycle phases in which they are created
 - Who creates each information package, in terms of project or facility role? Is this an internal or external role? The precise individual and external organization will be identified in the project information handover plan.
 - Business processes in which they are used
- Conformance of information handovers with company policies regarding:
 - Contracts and procurement policies
 - Legal and regulatory compliance
 - Security
 - Allocation and management of information technology resources
- Assigning responsibilities for:
 - Establishing appropriate contractual and procurement terms to ensure that required information packages are handed over
 - Ensuring that security policies are enforced during information handovers
 - Seeing that information handovers occur on a specific project
 - Establishing the system infrastructure for receiving information handovers
 - Assuring the quality of information handed over
 - Maintaining and managing handover information over time

5.3 Information Handover Requirements

The purpose of an information strategy is to communicate the ultimate use and relative importance of key information packages from the perspective of the organization creating the strategy. The next step is to define the contents of those key information packages, select an appropriate form and format for their handover and determine metadata requirements.

5.3.1 Applying an Existing Standard

Most organizations are able to describe the information they need at a summary level. Defining the exact contents of each information package is more challenging. The best approach is to apply a model view or use case that has already been defined, if one exists. Examples are the U.S. General Services Administration's (GSA) Spatial Program view of the Industry Foundation Classes (IFC) model (www.gsa.gov/bim) and the use cases defined for CIS/2 information exchanges in the steel supply chain. In these cases, multiple software vendors have already developed implementations. The COBIE specification discussed earlier and the Early Design Information Exchange specification originally initiated under the International Alliance for Interoperability (IAI) and now continuing under the U.S. National BIM Standard (NBIMS) both detail the contents and format for certain information packages but are not yet broadly implemented in commercial software packages. Both are included in the NBIMS (www.nbims.org).

There is no single standard that currently addresses all of the general building industry's handover requirements. In fact, there are gaps where no standards exist and other solutions must be used. However, not every information package has the same level of interoperability requirements. It is important to focus on the highest priority packages and those for which a standard format is most critical. Begin by understanding the uses of each prioritized information package.

5.3.2 Uses of Information Packages

Information packages have different uses. Understanding the uses of your organization's prioritized information packages allows you to maximize the utility of the information while minimizing the complexity and cost of its capture and management.

Questions that should be answered include:

- Who and what system(s) will use the information and where will it need to be accessed? Which users and systems will view only and which, if any, will update? Obviously, the information package needs to be in a consumable format for its intended downstream users.
- Will this information be updated? Some percentage of the information packages will be static; i.e., they will be "frozen" at a specific point in time. An example would be an occupancy permit or a test report. Static information can be captured in a standard archival format such as PDF/A (ISO 19005-1:2005, *Document management - Electronic document file format for long-term preservation - Part 1: Use of PDF 1.4*) and should be protected from alteration. Good metadata will be required to permit the searching and retrieval of static information in unstructured form.

- Which and how many versions of the information package need to be handed over? For example, does the owner need both the as-designed and the as-constructed information? A common owner mistake is requesting so many handovers of evolving information that it is unclear, after the project is complete, which information package is the final, accurate one. If multiple versions are to be handed over, then data management and configuration control (i.e., tracking which analysis run produced which handover package and which changes within the model) will be critical.
- Is this information handover iterative? An example would be information handed over for design review and coordination. This type of handover must be executed quickly and efficiently. Often it is preferable to use proprietary formats for this type of handover.
- Is this information handover two-way? In other words, will the recipient be revising or adding to the information package and sending it back? A two-way information exchange is technically more difficult and also requires the ability to distinguish what has changed and to maintain an audit trail of which party created and/or changed which information when. Some proprietary solutions work better for this.
- How long will the information be retained? There are multiple factors that contribute to this assessment, including:
 - Regulatory and legal requirements
 - Importance of the information to business functions
 - When in the facility life cycle the information will be needed
 - Intended life span of the facility
- How frequently will the information be accessed or updated? Data that are in constant use can be expected to be converted to new formats as the organization's IT environment evolves. Data that are seldom used, however, risk being forgotten. Monitoring should be put in place to flag any data in proprietary formats threatened with obsolescence. These are the information packages for which a standard format is most desirable.

There are four major categories of information forms and formats. Figure 5-2 identifies their comparative longevity and reusability. The terms structured, unstructured, standard and proprietary are defined and discussed in detail in Section 3.

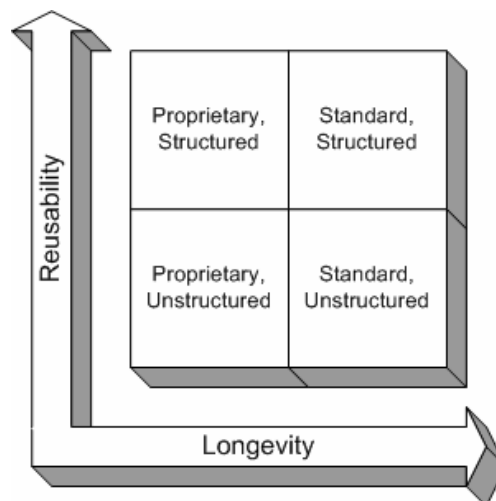

Figure 5-2: Longevity and Reusability of Information Forms and Formats

In deciding on a standard format one must assess the level of adoption, the availability of reliable implementations and the cost of using the standard. Also, who will be the downstream users of the data? Will these users have access at a reasonable cost to software that supports the standard? It is also critical to consider the level of technological expertise of the potential information providers. Assuming that a standard format is available and well-supported by commercial application software, are the potential consultants, contractors and suppliers capable of creating a complete and accurate information package in that format? If it is unlikely that the level of technological expertise in the marketplace will support the optimal information handover approach, the facility owner must either provide training or modify the information strategy. Careful thought should be given to whether the short-term cost of providing training outweighs the long-term benefits of having the facility information in structured form and standard format.

5.4 Project Information Handover Plan

The information strategy:

- Specifies information required for decision-making, work processes and regulatory compliance (information packages)
- Prioritizes these information packages
- Identifies by whom and when in the facility life cycle these information packages are created, and
- Identifies by whom or what process and when in the facility life cycle these information packages are used.

The handover requirements define, for each information package:

- Content
- Uses
- Preferred form and format
- Metadata requirements, and
- Retention.

The project information handover plan brings together the information handover content, format and metadata requirements and the project-specific conditions to ensure that the required information handovers can be executed.

5.4.1 Developing the Project Information Handover Plan

The information strategy and the handover requirements are generalized for any number of locations, facility types, project scopes and delivery methods. The challenge of the project information handover plan is to apply these general requirements to the specific project so that high-priority, correct and properly formatted information packages are dependably, timely and cost-effectively handed over by the originating members of the project team.

5.4.2 From General to Specific

Important considerations in tailoring the general guidance to the specific project include:

- Jurisdiction-specific requirements. Since the built environment is typically regulated at

the local level, pay attention to requirements that vary based on locale, including:

- Retention
 - Hard copy
 - Wet signatures or physical stamps
 - Digital signatures/ transmission, and
 - Information handover(s) to the jurisdiction.
- Each team member's responsibility for work processes that create priority information packages. This is an area of great variability, since many companies play multiple roles on some projects and entirely different roles on others. For example, some owners may self-perform some construction work and a firm that is the design engineer on one project may be the construction manager on another. Whether key information handovers are occurring within a single organization or across multiple companies affects the legal complexity and the need for data management at the overall project level. Typically, a firm will manage its own data and data exchanges until that data is released to outside companies.
 - Specific software products in use by team members. Until the general building industry achieves much better software interoperability, this will be a constant question, exacerbated by the increasing prevalence of the use of multiple analysis programs for design optimization. What capabilities do the software packages have for reading/writing data in formats compatible with applications used by other project team members? These data exchanges will require testing and documentation of required user practices to ensure that non-exchangeable data types are not used.
 - Requirements for information sharing among team members within the project, as well as for handoff to downstream processes. The concept of information handover seems to imply relinquishing ownership and management of that data, similar to the handing over of as-built drawings at project closeout. However, many data handovers during project planning, design and construction are iterative, with information added, reviewed, updated and then further developed. Iterative exchanges are perhaps the most difficult to manage inasmuch as they require tracking versions of data sets. They are particularly challenging when a model developed by one team member is handed off to an analysis application that modifies the model and the modified model is then returned to the original author. In this circumstance, tracking who is responsible for each change is critical.
 - Each organization's experience and capacity to work with data standards and structured data forms. The teams most successfully using BIM consider BIM expertise in selecting project team members. Many organizations launching a BIM project are frustrated by a key team member's inability or refusal to participate in the electronic process.

5.4.3 Balancing Costs and Benefits

There will be some cost associated with both the project information planning process and the project team members' compliance with the plan. Based on the case studies documented in this guide, these costs are more than offset by benefits. Benefits do not accrue evenly to all stakeholders, however, and are not necessarily proportionate to costs incurred. The compensation model for the project participants should recognize this fact and create appropriate incentives for all team members.

5.4.4 Handover Plan Contents

The project information handover plan should define a comprehensive approach to the consistent creation, management, use and exchange of all information related to both the execution of the project and the priority information packages identified as deliverables at project closeout. The plan should document:

- Project-specific information package sources and when produced
- All uses of priority information packages generated during the project in subsequent life cycle phases
- Format for each information package
- Required metadata
- Handover method, and
- Clear assignment of responsibility for all information creation, handover, quality and compliance monitoring activities

The following topics should be considered when developing the project information handover plan.

5.4.5 Information Quality Considerations

Processes must be agreed upon and put in place at project startup to ensure the quality of the information to be handed over. These should be part of the project's overall quality plan.

Properties of information for which quality requirements should be assessed include:

- **Clarity/ Consistency:** Clear and shared definitions: do creators and users of information use the same codes and terms with the same meaning? Is information received from different sources consistent in terms of naming, units and relationships? Be thorough about developing and enforcing standard terminology.
- **Accessibility:** Where, how and to whom the information is or is not available: is the information easily accessible? Adequately secured? This will, at a minimum, require the designation of a team member to be responsible for managing information handovers. Hopefully, automated systems can be used to assist team members in delivering and logging their handovers and accessing the information they require.
- **Usability:** Can the information be organized and presented differently for different users? For example, a cost estimator or specification writer views facility information much differently than the design engineer who created it. Are there multiple copies or versions of this information? If so, is there a master copy from which the others are derived? With BIM, there is frequently a considerable difference in the way the design team models the building compared to how the construction team models it. For example, the designers may model a large slab as a single object. The contractor may model it as a number of smaller slabs, defined by his pours. One way to handle these differences is to have the contractor, assuming he is involved during design, provide his objects for the design team to incorporate into the model. The second approach is to create a second construction model. This would then require some way of referencing the design model to ensure maintenance of design intent.
- **Completeness:** How much of the required information is available: is the full content of

each information package supplied? Is all the required information routinely created by the project team in their normal course of activities, or do they need to do something special? Another issue here is that an information package may be generated by multiple organizations and/or in multiple phases. Thus the handover is not a single deliverable, but two or more deliverables that must be merged in some fashion to create the required information package.

- **Timeliness:** The availability of the information at the time required: is the current version of the information team members require available, and is it available when they need it? The project schedule should accurately reflect when information handovers are required. However, the transfer of data, particularly if it must be translated or checked, may add time that is not reflected in the schedule. A second issue is when in-progress information should be communicated to other team members. Sharing in-progress work too transparently may result in other team members' scrambling to accommodate a change that really is not a change; it is just a "what-if" study.
- **Accuracy:** How close to the truth the information is: is the accuracy of the information known and does it meet requirements? It is important to determine both the level of detail and the level of precision expected at various points in the project process. Clearly the "build it first digitally" approach requires a very complete and very precise model for all systems included before the project enters physical construction. However, this is not the level of accuracy required in conceptual design. Some organizations, such as the U.S. Coast Guard, have defined levels of model detail required at project milestones based on the Unifomat levels.
- **Cost:** The cost incurred in obtaining the information and making it available for use: is the information supplied in a form and format that means the cost of maintaining it throughout the life of the asset has been minimized? What about the costs of managing and quality assuring the information handovers during the project process? Information management may be a new cost item for many organizations. It is important that business managers understand that there is a cost to this activity when they determine project staffing and fees.

5.4.6 Information Quality Management

The project information handover plan should provide an information quality management framework that describes the information handover in terms of scope, contents, constraints, coding, timing and procedures.

The information quality management framework should address:

- What is to be handed over and in what format
- Required metadata
- How the information is to be handed over and receipt acknowledged
- Time period allowed for verification of transfer and checking
- Quality metrics for the information and the process to ensure that the information is of the required quality, and
- The procedure to be followed if and when incorrect or incomplete data is found.

5.4.7 Logistics

The project information handover plan should make clear:

- Who will produce each required information package
- When they will deliver the information package
- How they will deliver the information package
- Who will receive the information handover
- Where the handover information be stored, and
- Who will be responsible for its management and integrity.

5.4.8 New Project Roles

Managing data exchanges during the project process is typically the responsibility of the project team. As the AISC suggested in the *2005 Code of Standard Practice*, the responsibility for managing the model and the data exchanges should be assigned to a specific organization on the team. The owner should also designate responsibility within its IT group for receiving the appropriate information handovers at project closeout, archiving and maintaining the data and making it accessible to downstream users.

5.4.9 Handover Methods

The method of handover will depend to a certain extent on the form of the information to be handed over. Owners may continue to require information to be handed over as paper records, most often in conjunction with digital surrogates. Where this is required, it should be clearly noted in the project information handover plan.

For electronic handover, there are a number of approaches that can be adopted. Efforts should be made to provide the entire project team controlled access to a shared repository of accurate project information and to minimize redundancy, data re-entry and the effort required to conform multiple versions of the same information. There are a number of possible approaches to doing this and these are somewhat dependent on the information strategy:

- **Owner System:** The owner implements an information system and provides controlled access to all project participants, internal and external. Based on project role, the various participants upload deliverables to the information system at the required handover points and/or retrieve the information required for their activities. This approach is designed for an owner-driven strategy of optimizing facility life cycle costs and operations. The challenge with this type of system is that it may not support all information exchanges necessary between project team members.
- **Third Party System Based on Owner Requirements:** A consultant, construction manager or contractor establishes a system to capture the information packages required by the owner and then hands over the populated system to the owner at the end of the project. This approach can be used where the outside organization already has a well-established infrastructure, but the owner does not. It is useful in providing a framework within which the owner will be able to manage key information packages over the long term. It is consistent with an owner-driven strategy to optimize facility life cycle costs and operations but, again, may not support information handovers between team members during design and construction.

- **Cross-Organizational System:** A consultant, application service provider, construction manager or contractor implements and manages a shared information system that is populated with information throughout the project by all participants. This approach is consistent with a supply chain or project delivery optimization strategy and is the approach recommended by AISC. In this approach, the information to be handed over to the owner will likely be a subset of all information accumulated. The current lack of robust data management tools means that the selection and transfer of the owner-required handover data to the owner's system may require additional effort.
- **Information Handover as Discrete Project Closeout Task:** Each organization participating in the project uses its own in-house systems to assemble the information and then exchanges information periodically on a one-to-one basis with other team members or the owner. At project closeout, some team member is designated to go back and assemble the owner-required information packages. Experience with Operations and Maintenance Support Information (OMSI), which is an example of this approach, indicates that the information gathering and formatting (not in structured form) effort to produce a modest group of information packages costs US \$40,000 for a typical Naval Facilities Engineering Command (NAVFAC) facility. In addition, this approach fails to support a high level of project collaboration and integration. This unmanaged type of data exchange with an add-on task of assembling information packages after the fact is undesirable under any strategy.

5.4.10 Data Transfer Methods

In the past, data were usually transferred on magnetic or optical media, such as 3.5-inch floppy disks, magnetic tapes or CD-ROMs. Today, such transfers are usually accomplished by electronic transfer across a public or private data network.

The method of data transfer should be agreed by the parties prior to the exchange of any information. Security issues must be addressed. It may be necessary to hand over certain design or contractual information on paper to meet with legal requirements. The requirements for paper documents need to be carefully considered in relation to the ability to create verifiable copies of information from electronic storage and the legal admissibility of such information.

5.4.11 Timing

The frequency and timing of information handovers must be settled. Issues to be covered include:

- Will there be a specific milestone at which various players deliver information packages, or will the information be built up throughout the project?
- Will trial handovers be required? It is advisable to test the handover technique and participants' understanding of the requirements early on to avoid reworking large quantities of data.
- If data conversion is required, how long will that take?

5.4.12 Responsibilities

Once the required handover information has been specified and documented, the participants in the project need to agree responsibilities for:

- Creation of information
- Security of information
- Quality assurance of information
- Gathering third party information (e.g., equipment vendor documentation)
- Getting information into the right format
- Assigning metadata
- Implementation of the information management systems
- Managing the information through the project duration, and
- Assuming responsibility for the information upon project closeout.

5.4.13 Storing and Preserving Handover Information

Data preservation is a highly complex issue. Paper-based preservation focuses on preserving the physical entity. With digital data, preserving the physical media on which the data is stored solves only part of the problem. Digital preservation requires not only refreshing the physical media and ensuring that it can be read, but also ensuring that the digital data is not changed or corrupted and that programmatic access to the data is maintained.

Media refreshing ensures that data will not be lost due to deterioration of the media on which it is stored. An example of this would be copying data archived on one storage media to new storage media on a scheduled basis. Ensuring that the file is not changed or corrupted can be handled by techniques such as a checksum or digital signatures. This is called “bit preservation.” With the rapid turnover of devices, processes and software, the more difficult issues are the availability of hardware that can read the media and of software that can display the content.

Archiving the data in active, online storage rather than on external media best solves the media problem. Requiring information to be handed over in formats that are defined by *de jure* standards organizations such as the International Organization for Standardization (ISO) is the best protection against format obsolescence.

5.5 Implementation of the Project Information Handover

Implementation requires the alignment of work processes and software tools to produce and deliver the required handover information. The greatest efficiency will be achieved if the handover process is integrated with the information creation process. This will provide a streamlined flow of information.

Handover requirements (content, format and metadata) should be defined in the contract between parties. Unless the information is originally created in the desired form, it may be difficult and expensive to convert. Therefore, it is essential that the information strategy and the handover requirements be established before project initiation so that contractual requirements for information handover can be defined. It is also advisable to clarify the minimum hardware, software and communications requirements for each team member.

5.5.1 Business Considerations

Over the last ten years, many businesses in the design and construction industry have developed two separate IT groups. The first is more traditionally focused, addressing issues of system capacity planning, uptime and performance, communications infrastructure, data security and

internal systems management. The second group merges domain expertise with IT savvy to assist the firm in evaluating and deploying client-facing systems such as Building Information Modeling (BIM), project management and collaboration. This second group typically has at least two tiers: project-focused individuals who provide front-line expertise, technology training and support to the teams working on projects and the more strategically focused technology visionaries responsible for proposing, evaluating and deploying new technologies and products. Large firms may have an additional tier of experts in specific products or technologies. This tier is typically involved in customizing solutions for specific markets, clients or projects to create competitive advantage. Many businesses are finding it valuable to include this second, domain-focused IT group in proposal/ bid preparation to help business managers assess the staffing, training and hard cost impacts of client electronic collaboration and information handover requirements.

5.5.1.1 Project Information Manager

Although each company participating in the project is responsible for the content, timely delivery and management of the information it creates, there is a need to integrate, check, coordinate and manage the information received from all parties. Beyond understanding the issues of coordinating building systems, this model management activity requires expertise in data structures, configuration control and information management. A single entity should be designated to serve this function. This entity can be dedicated exclusively to this activity or be a team member that is providing other services. The following is a commentary from the AISC's 2005 *Code of Standard Practice for Steel Buildings and Bridges, Appendix A: Digital Building Product Models*:

When a project is designed and constructed using EDI, it is imperative that an individual entity on the team be responsible for maintaining the LPM [Logical Product Model]. This is to assure protection of data through proper backup, storage and security and to provide coordination of the flow of information to all team members when information is added to the model. Team members exchange information to revise the model with this Administrator. The Administrator will validate all changes to the LPM. This is to assure proper tracking and control of revisions. This Administrator can be one of the design team members such as an Architect, Structural Engineer or a separate entity on the design team serving this purpose. The Administrator can also be the Fabricator's detailer or a separate entity on the construction team serving this purpose.

As an example, for the Hamilton Building of the Denver Art Museum, the contractor, Mortensen Construction, acted as the project information manager. Mortensen executed model sharing agreements with other team members. In addition to the 3D architectural model, all major shop drawings were submitted in 3D form. Throughout the pre-construction period, many different software products were used to create system-specific models that were shared through a project website. Mortensen staff linked the design model and the manufacturing (shop drawing) models used to build the project. The BIM models became the catalyst for collaboration. They conducted interference checks and 4D construction sequence simulations. They used the model data to ensure proper placement and tolerancing during construction.

5.5.1.2 Contractual Terms

Integrated practice and the replacement of physical documents by information handovers raise questions about standard contracts, liability, risk management and insurability. Although there is little litigation case history, the emerging consensus is that these changes in when and how information is communicated do not alter the basic roles and responsibilities of the team. The AE is responsible for the design; the contractor is responsible for constructability issues, construction means and methods and shop drawings. What is important is that all parties understand, at each handover, the accuracy of the model and its intended uses.

Commonly used standard contracts do present an obstacle to a collaborative information sharing environment. These contracts are based on a legal differentiation between design, a professional service, and construction, a contractual and warranty obligation. Design information is conveyed via “instruments of professional service” to be used by the contractor. Even when information is exchanged electronically, most contracts denote the hard copy as the controlling design information. When the project delivery approach eliminates drawings and requires the development and use of a shared model, such contractual terms must be changed. Organizations such as the American Institute of Architects (AIA) and the Associated General Contractors of America (AGC) are currently working on revised language for standard contracts, but these updated standard contracts are not yet available. Businesses must therefore work with legal counsel to develop and negotiate special contract clauses that include:

- Allocation of responsibility for creating information
- Appropriate access to, reliance on and use of electronic information handed over
- Responsibility for the updating and security of the data
- Ownership and downstream uses of the information, and
- Compensation for team members that recognize the costs and risks they incur and the value they deliver.

The presence of a proposed project information handover plan will greatly facilitate the negotiation of these terms.

5.5.1.3 Liability and Insurance

Although the AE’s professional liability coverage does not extend to technology-based risks such as lost data, virus corruption, or software malfunctions, it does cover broadly defined design services, regardless of the means of communication or the form of the instruments of service. A new development may be the incorporation of elements designed by team members other than the AE. These team members will be legally responsible for their own design negligence and should consider insuring themselves appropriately. The model manager plays a critical role in tracking the source of each design element and incurs some special liability for data mismanagement, corruption or loss.

5.5.2 Technical Implementation

The technical implementation must align the hardware, software, data communications and IT operations to ensure timely creation and delivery of quality information in the proper form and format. It must also establish the proper access controls, data backup and security provisions.

5.5.2.1 Configuration Management

For all dynamic information, both standard and proprietary formats, configuration management will be very important. The information content of a given model or document will evolve over the course of the project, and many will continue to evolve through operations and maintenance. However, there may be a need to preserve and access “snapshots” at key points along the facility life cycle timeline and know who was responsible for each change. During design and construction, configuration management will be the responsibility of the model manager.

5.5.2.2 Testing

Initial testing should be performed to ensure that all software selected correctly reads and writes the preferred format. Time required for translations and data transfers should be measured. Additional testing is required for the software or technique that will be used to maintain an audit trail of changes to the model.

5.5.2.3 Documentation of Best Practices and Project Procedures

Following the testing, it is important to document any specific user practices necessary to achieve the desired outcome. A good example for BIMs is to advise users not to delete a model element and add a new one, which will also delete that element’s unique ID, but rather modify the element. This will permit the maintenance of the element’s unique ID and allow the tracking of changes to that element.

Documenting project procedures related to information handovers will help clarify new roles and responsibilities. The best approach is to write step-by-step work instructions specific to the software products(s) in use. The *GSA BIM Guide for Spatial Validation*, available at www.gsa.gov/bim, provides an excellent example of such documentation.

5.5.2.4 Staffing and Training

It is advisable to request a contact person on each company’s project team responsible for communications concerning information handovers, changes to the system or procedures and user training and support. This individual should also be responsible for initiating new users.

Whether or not all project team members have experience with the software to be used, they all require training in the project information handover plan, associated procedures and best practices. All persons involved in information generation and handover should understand the following:

- Purpose and use of the information involved
- Life cycle aspect of information (in particular, the need for information to satisfy future life cycle requirements as well as its immediate use)
- Quality assurance issues (how to verify information)
- How to create and use the information, and
- Security issues such as confidentiality, virus checking and backup.

Project staffing is never static; people will come and go. Provide mechanisms for identifying and training new users.

5.5.2.5 Compliance Checking

There is a natural reluctance to change the way one works. In order to ensure the stated project procedures are followed, compliance checks should be performed periodically.

5.5.2.6 Continuous Improvement Program

A Lessons Learned or other continuous improvement program that periodically solicits feedback from users will be very effective both in encouraging compliance with project procedures as well as in identifying better ways to work.

5.6 Handover Lessons Learned By Early Adopters

The advisory panel for this guide contributed a number of insights concerning the potential pitfalls and keys to success.

5.6.1 Challenges

There were challenges encountered in a number of areas, including: commercial issues, entrenched expectations, resistance to change, immature technology and inadequate technology infrastructure.

5.6.1.1 Commercial Issues

Commercial issues encountered included conflicting business models of different project team members. This led to an individual company's attempting to optimize its own outcome rather than the project outcome.

Another issue that arose was model ownership. A related issue was the expectation on the part of some clients that, because a model existed, it could be readily reused for other, not necessarily intended, purposes. This raises the need for clarification of the specific information packages to be handed over.

5.6.1.2 Expectations

Aligning expectations in general was an issue. Persistence of a 2D mentality and insistence on traditional project process, phasing and deliverables reduced the effectiveness of streamlined computer-based workflows and electronic information handovers. There were problems defining deliverables appropriate for the new project approach.

5.6.1.3 Change Management

There was also active resistance within project teams to change. A number of advisors reported that key project team members promised but failed to work in 3D or simply refused to believe the information handed over. In one case, the construction manager insisted on doing a manual quantity take-off even though they were supplied with a detailed take-off from the structural model by the engineers. Even where there was no active resistance, it was still challenging to find staff who could work and problem-solve in new ways. Project team members had different levels of IT capability and understanding. There was often a need for continuous training that was not always budgeted for or met. The consensus was that these issues are best resolved when the client assumes a leadership role and project team members are selected partially based on their 3D/ BIM capability.

5.6.1.4 Immature Technology

Early adopters encountered a number of challenges that were related to the immaturity of the technology. These included:

- Lack of standard model views
- Software incompatibility
- Limited data re-usability and machine interpretability, and
- High level of effort required to make the electronic information usable by others. This was particularly pronounced in two-way exchanges of information (e.g., the results of the analysis update the model).

The root causes of these issues are discussed in Section 3. There is still much work needed to develop use cases and model views and develop standard terminology so that advanced software systems can fully interoperate. There is also the need for test cases that will permit both software vendors and end users to know whether specific products can interoperate effectively. This is the area that is being investigated by the IAI buildingSMART initiative internationally and the NBIMS project committee in the United States.

5.6.1.5 Inadequate Technology Infrastructure

In addition, advisors cited inadequate technology infrastructure in several areas:

- Wireless access and speed (processing time, bandwidth)
- Appropriate viewing devices
- Collaborative tools, and
- Model repository/model management software.

5.6.2 Keys to Success

Advisors were also able to identify common factors that led to success. These focused more on human factors and the quality of collaboration.

5.6.2.1 Human Factors

Perhaps the greatest success factor was strong leadership, either by the client or executive leadership within their own company. Also important were grassroots leadership and buy-in by the team. The availability of personnel with process flexibility and skills with the technology tools was also a factor.

5.6.2.2 Quality of Collaboration

The greater the number of team members who can share project information with confidence, the greater the level of efficiency and automation and the more successful the approach. Thus, key success factors also included:

- Transparency and accessibility of electronic information for more people
- Ability to use the information across the design/ construction team
- Appropriate quality assurance methods and procedures
- Collaboration that includes the trades
- Mutual trust, and
- Recognition of new project roles, such as information manager.

6. Conclusion and Recommendations for Future Efforts

There is no doubt that the use of the advanced technologies described in this guide is yielding business results that are needed and valued by the general buildings industry. However, the information flow among the parties is still far from seamless. Currently, project teams spend weeks of effort working out common modeling practices and data exchange techniques on a project-by-project basis. The goal of the information handover methodology defined in Section 5 is to minimize this effort as the general buildings industry moves to true interoperability.

Currently, most organizations in the general buildings industry quantify neither the cost of the effort involved in data exchanges nor cost reductions attributable to improved processes and technologies. One recommendation going forward is for all organizations to begin to collect these metrics.

The ability to hand over electronic information predictably and with little or no human intervention is key to the general buildings industry's reaping the full benefits of advanced facility design, analysis and management software. In order to achieve this ability, the industry must reach a common understanding of what information is necessary to the performance of each major business activity. Although standard data formats capable of encoding this information exist, particularly the International Alliance for Interoperability (IAI) Industry Foundation Classes (IFCs), needed usage guidance, mappings, test suites, conformance testing methods and metrics have yet to be defined.

Recent work by a number of organizations has provided methodologies, templates and examples of successful use case and model view development. This work represents a major step forward in that it describes the path along which the industry can progress.

What are needed now are champions and sponsors for the development of the priority model views and test suites necessary for robust interoperability. Once the necessary model views are developed, the next challenge will be encouraging software vendors to implement them. The U.S. General Services Administration (GSA) was very successful in this regard because their design and construction program is so large and they targeted viable increments for adoption in their program. Companies with less clout must combine their efforts with industry initiatives to create the critical mass necessary to spur implementations.

Industry and professional organizations are the logical hosts of these collaborative efforts. The American Institute of Steel Construction (AISC) serves as a role model. Over a period of five years, they invested U.S. \$1 million in technical, stakeholder communication, education and marketing efforts to support the use of CIMSteel Integration Standards Release 2 (CIS/2) for data exchanges in the structural steel supply chain. A major measure of their success was that fourteen software products, used throughout the steel supply chain, supported the standard at the end of five years. Additional software products have added CIS/2 support since.

An additional challenge is managing models that are used in cross-organizational workflows. Although very robust software tools for managing electronic project documents and workflows exist, these tools have not yet been extended to handle models at the component level. The need

remains to apply security at the component level and to maintain an audit trail of who accessed or changed which components when. There are some early implementations of such “model management” software but these are not as yet broadly available commercially.

Finally, the impact of commercial issues – contracts, liability, insurance, and so forth – cannot be underestimated. Fortunately, the Construction Users Roundtable (CURT), the American Institute of Architects (AIA) and the Associated General Contractors of America (AGC) have all acknowledged these issues and begun to address them.

There are a number of current initiatives, discussed in this guide, that are addressing parts of the problem. These initiatives, if properly resourced, could contribute to a comprehensive solution. Businesses, industry and professional organizations in the general buildings sector must provide those resources.

7. APPENDICES

7.1 APPENDIX A – Benefits Chart

This chart appears courtesy of Paul King, Bentley Systems, Inc.

Project stage	Benefit area	Design team	Main contractor	Sub contractor	Operator	Key	Description	Benefits	Cost benefit
						<input checked="" type="checkbox"/> Principal beneficiary <input type="checkbox"/> Secondary beneficiary			
Preliminary, concept and detail design	Visualisations, animations, and virtual reality	<input checked="" type="checkbox"/>	<input checked="" type="checkbox"/>	<input type="checkbox"/>	<input type="checkbox"/>		Animations, visualisations and virtual reality materials are produced as a by-product of the model. Simulations can help to improve health safety by considering aspects such as working at height - for construction and subsequent facilities management.	<ul style="list-style-type: none"> - More effective promotion of a scheme and stakeholder awareness - A more effective and transparent design process - Improved health and safety management 	
	Coordination and clashing	<input checked="" type="checkbox"/>	<input checked="" type="checkbox"/>	<input type="checkbox"/>			The virtual model provides an effective and efficient means of coordinating the design elements on a scheme. Although design teams claim to perform coordination and clash detection it is often left to second- and third-tier supply chain partners.	<ul style="list-style-type: none"> - Clash free, fully coordinated design model - Lower design cost (design is done once only, and done right) - Less burden on the design team during construction 	5% saving in design cost
	Design analysis	<input checked="" type="checkbox"/>					Data from the 3D model can be exported quickly and easily to design analysis packages and the resultant design data can then be imported seamlessly back into the model.	<ul style="list-style-type: none"> - Faster design analysis - Error-free transfer of data between analysis and modelling packages - Lower design cost and the ability to consider more design options 	
	Material schedules	<input checked="" type="checkbox"/>	<input checked="" type="checkbox"/>	<input type="checkbox"/>			Component and material schedules are generated automatically and accurately from the 3D model, and can be transferred easily to and from proprietary databases or spreadsheets to help estimators, purchasers and designers.	<ul style="list-style-type: none"> - Quick production of error-free schedules - Smaller estimating teams - Better awareness of costs as the design develops 	1% saving in design cost
	Bills of quantities	<input checked="" type="checkbox"/>	<input type="checkbox"/>				Bills can be produced to any standard and format by exporting appropriate data from the model.	<ul style="list-style-type: none"> - Quick production of correctly formatted bills with fewer errors - Lower cost of production 	
	2D drawings	<input checked="" type="checkbox"/>	<input type="checkbox"/>	<input type="checkbox"/>			2D drawings are extracted quickly, easily and efficiently from the model. As supply chains adopt a model centric approach, the need for drawings will diminish.	<ul style="list-style-type: none"> - More cost effective drawing production, with fewer errors - Fully coordinated design deliverables - Accurate and consistent plans, sections and elevation 	
	Links to project documents	<input checked="" type="checkbox"/>	<input type="checkbox"/>	<input type="checkbox"/>	<input type="checkbox"/>		The virtual model can be linked to project documents (such as specifications, risk assessments, etc) and to suppliers' product information, either on or off the Web.	<ul style="list-style-type: none"> - Easier access to project information for all stakeholders - Better management of component data - More efficient design process 	
	Stakeholder awareness	<input checked="" type="checkbox"/>	<input checked="" type="checkbox"/>	<input type="checkbox"/>	<input type="checkbox"/>		The virtual model is a powerful tool that helps to convey complicated design aspects to stakeholders, and information can be tailored easily to suit the audience.	<ul style="list-style-type: none"> - Improved stakeholder awareness - Easier to secure buy-in earlier in a project - More likely to encourage a good response from potential tenderers 	1% saving in design cost
	Design efficiency	<input checked="" type="checkbox"/>	<input type="checkbox"/>	<input type="checkbox"/>	<input type="checkbox"/>		A model centric approach makes it more realistic for designers to 'do it right first time', and to consider more design options. It also enables more effective and better integrated decision making.	<ul style="list-style-type: none"> - Greater design efficiency - Better value for the client - More profit for the designers and no erosion of margin in construction 	3% saving in design cost

Procurement, construction & commissioning	Trade packages		■	■		Using the virtual model, site teams can produce trade package information easily and accurately for tendering and managing subcontractors. Armed with a better understanding of the project, trade contractors are more likely to 'get it right first time'.	<ul style="list-style-type: none"> - Easier compilation of tender information - Tenderers receive information that is correct, complete and consistent - Lower tender risk contingencies 	1% reduction in build cost
	Construction planning		■	□		Virtual models can be linked to master and sub-project programmes using proprietary software tools, enabling the works (and changes) to be conveyed graphically via the model.	<ul style="list-style-type: none"> - Improved project programming and better understanding of activities - Better informed stakeholders - Improved health and safety training of site teams 	0.25% reduction in build cost
	Buildability & logistics	□	■	■		Buildability and construction logistics checks are performed in the virtual world during the design phase to prevent problems from ever reaching site.	<ul style="list-style-type: none"> - More efficient site activities leading to lower construction costs - Greater programme certainty - Improved planning of site laydown areas and materials logistics 	
	Clash management	■	■	■	□	Design coordination helps to prevent clashes reaching site, thereby eliminating both construction waste and the associated disruption. Fewer queries have to be referred back to the design team because there are fewer errors in the design and the construction team can interrogate the model to resolve queries.	<ul style="list-style-type: none"> - Clash free, fully coordinated design and construction - Lower construction cost because of less waste and less disruption - Less burden on the design team during construction - Better certainty of project programme 	5% reduction in build cost
	Stage payment		■	□		By monitoring planned and actual progress with a virtual model, payment mechanisms can be more accurate and more efficient.	<ul style="list-style-type: none"> - Better payment mechanisms - Fewer contractual disputes - Improved transparency of processes 	
	2D drawings	■	■	■		Site teams can produce drawings quickly and easily from the model if required, but the need to generate drawings on site is reduced.	<ul style="list-style-type: none"> - Less burden on the design team during construction - Quicker access to better design information by site teams - More effective interaction with specialist suppliers and subcontractors 	
	Awareness of works		■	■	□	The virtual model can be used to convey elements of the project to stakeholders, and to simulate the impact of, for example, incidents that cause congestion on site. It can also help to clarify key interfaces between FM management and games operations.	<ul style="list-style-type: none"> - Improved understanding of matters affecting health and safety on site - Greater transparency of site activities - Less disruption to programme 	0.25% reduction in build costs
	As built information		■	□	■	As-built information can be produced easily and more accurately because the model is kept current through the construction period, ensuring that the facilities manager will receive high quality data.	<ul style="list-style-type: none"> - Easier to produce high quality as built data for handover - Lower cost of producing as built information 	0.05% reduction in build costs

Operations, FM & legacy	Population of FM database		<input type="checkbox"/>		■	The virtual model can be used to automatically populate a facilities management asset database at the end of construction, generating a large saving in staff resources and cost.	- Swift, accurate population of the FM database with good quality data - Lower cost of establishing the FM system	£k one-off saving	
	Managing operations				■	The model can be linked to an FM system to help manage space, assets, building maintenance, property and lease details, cable infrastructure and telecommunications. Model data can be loaded onto handheld devices for mobile audits and maintenance work.	- More efficient facilities management - Staff have easy access to high quality record information - Lower cost of operations (including auditing, benchmarking, etc)		
	Managing new works and change	<input type="checkbox"/>	<input type="checkbox"/>			■	Provision for maintenance can be built into the design more easily, building systems can be viewed using the model, and access by maintenance workers can be simulated.	- More efficient design and implementation of new works - Improved health and safety - Lower cost of managing the facility as it evolves over time	Annual saving
	Links to product information					■	The virtual building can be linked to project documents and to suppliers' product information, either on or off the Web.	- Easier and quicker access to product information - Lower cost of sourcing data	
	Links to BMS systems					■	Environmental controls, sprinkler systems, lifts etc. can be link to the model so that these can be managed graphically	- More effective facilities management	
	Links to security systems					■	The model can be linked to security systems to assist with access control, closed circuit TV and fire detection.	- More effective facilities management	
	Links to stock control system					■	Stock control items, such as office partitions and furniture, can be managed by linking them to the model.	- More effective facilities management	
	Hazardous material location	<input type="checkbox"/>	<input type="checkbox"/>	<input type="checkbox"/>		■	The construction industry does not use hazardous materials but if future legislation were to require, say, all glass fibre insulation to be located in a building, then the model could be interrogated to show its position.	- Lower cost of complying with legislation	
	Building cloning	■				<input type="checkbox"/>	The model contains all of the information needed to build and manage a facility, and it could be used to easily duplicate that facility (or parts of it) elsewhere.	- Much reduced cost or providing similar facilities in future	
	Knowledge management	<input type="checkbox"/>				■	The model is a valuable repository of project knowledge, comprising data on design, construction and operation. Such data could be shared with potential purchasers of a facility, or used to assist with due diligence processes when it changes ownership.	- Easy referencing of project knowledge - Lower cost of due diligence activities	
	Sustainability	<input type="checkbox"/>				■	The model contains data relating to sustainability, such as the location, quantity and quality of reusable materials.	- Quick access to high quality sustainability data - Efficient sustainability reporting, auditing and management	
Decommissioning	<input type="checkbox"/>	<input type="checkbox"/>	<input type="checkbox"/>		■	The virtual model contains important data about items such as structural walls that decommissioning contractors can use to minimise the risk of, for example, uncontrolled collapse.	- Safe decommissioning - Lower risk contingencies in decommissioning tenderers' quotations.		

7.2 APPENDIX B – Glossary

2D: Two Dimensional

3D: Three Dimensional

4D: Incorporating time (schedule)

Administrative Metadata: Metadata used to manage the information and includes such fields as: intellectual property status, file format, file size, creating system, archiving date, archiving expiration date and archiving refresh interval

AE: Architecture and Engineering

AEC: Architecture, Engineering and Construction

AEX: Automating Equipment Information Exchange

AGC: Associated General Contractors of America

AGCxml: A suite of XML schemas for exchanging construction project information between software applications used by facility owners and AEC firms

AIA: American Institute of Architects

AISC: American Institute of Steel Construction

Avoidance Costs: Costs incurred to prevent or minimize the impact of technical interoperability problems

BIM: Building Information Modeling

Bit Preservation: Process by which one can ensure that a file is not changed or corrupted and can be handled by techniques such as checksum or digital signatures

BLIS: Building Life Cycle Interoperable Software

BMS: Building Management System

BREEAM: BRE Environmental Assessment Method – British standard used to assess the environmental performance of both new and existing buildings

buildingSMART: An initiative of the International Alliance for Interoperability to accelerate achieving the dynamic and seamless exchange of accurate, useful information on the built environment among all members of the building community throughout the lifecycle of a facility.

CAD: Computer-Aided Design

CCITT: Comite Consultatif International Telephonique at Telegraphique (now ITU)

CERL: Construction Engineering Research Laboratory

CFIHG: Capital Facilities Information Handover Guide

CIFE: Center for Integrated Facility Engineering

CII: Construction Industry Institute

CIM: Canadian Institute of Mining, Metallurgy and Petroleum

CIMSTEEL: Computer Integrated Manufacturing of Constructional Steelwork

CIS/2: CIMSteel Integration Standards, Release 2

CityGML: An open data model and XML-based format for storing and exchanging virtual 3D city models

CM: Construction Manager

CMMS: Computerized Maintenance Management Systems

CNC: Computerized Numerical Control

COBIE: Construction Operations Building Information Exchange

Configuration Control: Information that moves through a project as its status changes. For example a drawing may start as “Issued for comment,” change to “Issue for construction” and be updated to “As built.”

CSI: The Construction Specifications Institute

CURT: Construction Users Roundtable

De facto Standards: Formats that may have originated with a single vendor but have been made publicly available and are supported by multiple vendors and products

De jure Standards: Standards maintained by an official standards organization, such as ISO or ITU

Delay costs: Costs incurred when interoperability problems delay completion of a project or the length of time a facility is not in normal operation

Deliverables: The physical information in an information handover

Descriptive Metadata: Metadata that identify and describe the information with fields such as creator, title, subject matter, responsible organization

DoD: Department of Defense

DoE: Department of Energy

DTI: U.K. Department of Trade and Industry

DXF: Data Exchange File

EAM: Enterprise Asset Management

EAMS: Enterprise Asset Management Systems

EDI: Electronic Data Interchange

ebXML: Electronic Business using eXtensible Markup Language is a modular suite of specifications that enables enterprises to conduct business over the Internet.

Exchange Requirement (ER): A non-technical description of the information needed by a business process to be executed, as well as the information produced by that business process

EXPRESS: A data modeling language and standardized as ISO 10303-11

FIAPP: Fully Integrated and Automated Project Process

FM: Facility Management

Format Registry: Identifies all file formats stored in the archive and their properties, and automates the assignation of preservation strategies

Functional Part (FP): An information handover in sufficient technical detail for software implementation

GBIHG: General Buildings Information Handover Guide

GCR: Governance Resource Center

Green Building XML (gbXML): An XML schema developed by Green Building Studio, Inc. to facilitate the transfer of building information stored in CAD building information models, enabling integrated interoperability between building design models and a wide variety of energy analysis tools

GSA: U.S. General Services Administration

GUID: Globally Unique Identifiers

HUT-600: The Helsinki University of Technology Auditorium Hall 600

HVAC: Heating, Ventilating and Air-Conditioning

IAI: International Alliance for Interoperability

ICF: The International Centre for Facilities

IDM: Information Delivery Manual

IFC: Industry Foundations Classes - Data elements that represent the parts of buildings or elements of the process and contain the relevant information about those parts. IFCs are used by computer applications to assemble a computer readable model of the facility that contains all the information of the parts and their relationships to be shared among project participants.

ifc-mBomb: IFC Model Based Operations and Maintenance project

ifcXML: An XML representation of the IFC EXPRESS model developed by the IAI

IFD: International Framework for Dictionaries

IGES: Initial Graphics Exchange Specification

Information Packages: Facility information required by each step in the information strategy process

Interoperability: Ability to manage and communicate electronic product and project data between collaborating firms and within individual companies' design, construction, maintenance, and business process systems

ISO: International Organization for Standardization

ITU: (Formerly CCITT) International Telecommunications Union - Committee of the United Nations that makes sure all telecommunications devices (like telephones, fax machines, modems and so on) can talk to each other, no matter what company makes them or in what country they're used

LBNL: Lawrence Berkley National Laboratory

Lean Construction: An initiative that identifies and attempts to eliminate the seven forms of waste: Correction, Overproduction, Motion, Material Movement, Waiting, Inventory, and Processing

LEED: Leadership in Energy and Environmental Design – standard American accepted benchmark for the design, construction, and operation of high performance green buildings

MEP: Mechanical, Electrical and Plumbing

Metadata: Metadata is a component of data which describes the data. It is "data about data."

Mitigation costs: Costs of activities responding to interoperability problems, including scrapped materials costs

Model Views: BIM information required for specific purposes, such as energy analysis, structural analysis, cost estimating, procurement, fabrication, erection and maintenance

MOU: Memoranda of Understanding

MVD: Model View Definition

NASA: U.S. National Aeronautics and Space Administration

NAVFAC: Naval Facilities Engineering Command

NBIMS: The U.S. National Building Information Modeling Standard

NIBS: National Institute of Building Sciences

NIST: National Institute of Standards and Technology

OAIS: Open Archival Information System

OCA: GSA's Office of the Chief Architect

OCCS: IAI/CSI Overall Construction Classification System Committee

OGC: Open Geospatial Consortium

O & M, OM: Operations and Maintenance

OMSI: Operations and Maintenance Support Information

OSCRE: Open Standards Consortium for Real Estate

PAS: Publicly Available Specification

PBS: GSA's Public Building Services

PDF: Portable Document Format

Process Map (PM): An overview of the handover process, describing its objects and the phases in a project at which the business process is expected to be relevant and identifies all the sub-processes

Proprietary Format: The format created by specific software applications such as CAD, word processing or BIM programs

RTD: Research and Technology Development

STEP: Standard for the Exchange of Product Model Data

Structural Metadata: Metadata that describe the internal structure of the information and relationships between its components

Structured Information Form: Data in a structured form that are machine-interpretable without human intervention

TAP: The AIA's Technology in Architecture Practice group

TEKES: Finnish National Technology Agency

UFGS: Unified Facilities Guide Specifications

Unstructured Information Form: Data that cannot be machine interpreted

USPI-NL: Uitgebreid Samenwerkingsverband Procesindustrie Nederland - Dutch Process and Power industry association that promotes and supports the development and implementation of international standards for exchange, sharing and management of life cycle plant data and related documents

XML: Extensible Markup Language

7.3 APPENDIX C – Bibliography

AEC3 Ltd. *OMSI Report: Overview of OMSI Information in IFC*. Pp. 151 – 158.

American Institute of Architects. *Document B141-1997: Standard Form of Agreement Between Owner and Architect with Standard Form of Architect's Services*. Washington, D.C., 1997.

American Institute of Steel Construction (AISC). *2005 Code of Standard Practice for Steel Buildings and Bridges – Appendix A*. 18 March 2005.

Associated General Contractors of America (AGC). *The Contractor's Guide to BIM, Edition 1*. 2006.

Bazjanac, Dr. Vladimir. International Alliance for Interoperability (IAI) Technical Advisory Group. *IAI Blueprint for the Start of the 21st Century*. PowerPoint Presentation. 25 October 2000.

Construction Industry Institute. *Technology Needs Assessment*. February 2003. CII Research Summary 173-1.

Construction Users Roundtable (CURT) Architectural/ Engineering Productivity Committee. *Collaboration, Integrated Information and the Project Lifestyle in Building Design, Construction and Operation (WP-1202)* August 2004.

Construction Users Roundtable (CURT). *Optimizing the Construction Process: An Implementation Strategy (WP-1003)*. July 2006.

Eastman, C., F. Wang, S.-J. You, and D. Yang. "Deployment of an AEC Industry Sector Product Model." *Computer-Aided Design* 37 (2005): 1214 – 1228.

Fallon, Kristine K. and Mark E. Palmer in cooperation with FIATECH and USPI-NL. *The Capital Facilities Information Handover Guide, Part 1 (NISTIR 7259)*. January 2006.

Federal Facilities Council (FFC) Board on Infrastructure and the Constructed Environment, National Research Council. *Linking the Construction Industry: Electronic Operation and Maintenance Manuals: Workshop Summary*. Washington, D.C.: National Academy Press, 2000. Available at <http://www.nap.edu/catalog/9904.html>.

FIATECH. Information Flow Map – First Release. In *Lifecycle Data Management Project*.

FIATECH. Element 9: Lifecycle Data Management & Information Integration. In *Capital Projects Technology Roadmap*. 2004.
<http://www.fiatech.org/projects/roadmap/workforce.html>.

- Fisher, Martin. *Framework to Measure the Implementation and Benefits of 3D/4D Modeling* PowerPoint Presentation. 2005.
- Fisher, Martin and Calvin Kam. *PM4D Final Report – CIFE Technical Report Number 143*. Stanford, CA: Center for Integrated Facility Engineering, Stanford University, 2002.
- Gallaher, Michael P., Alan C. O'Connor, John L. Dettbarn, Jr., and Linda T. Gilday. *Cost Analysis of Inadequate Interoperability in the U.S. Capital Facilities Industry (NIST GCR 04-867)*. 2004
- Hammer, Michael and James Champy. *Reengineering the Corporation: A Manifesto for Business Revolution*. HarperBusiness, 1993.
- Hannus, Matti, et al. *Construction ICT (Information and Communications Technology) Roadmap (ROADCON: IST 2001-37278, WP5/D52)*. September 2003.
- Khemlani, Lachmi. *The IFC Building Model: A Look Under the Hood*. 30 March 2004. Internet. Available at <http://www.aecbytes.com/feature/IFCmodel.htm>. Accessed 26 May 2005.
- Leibich, Thomas, Jeffrey Wix, AEC3 with contribution by all WP4 partners. European Network for IT in Architecture, Engineering and Construction (prodAEC). *Standard Analysis – Current AEC Situation – Building Models*. 2002. Internet. <http://www.prodAEC.com>.
- Lipman, Robert R. “Mapping between the CIMSteel Integration Standards and Industry Foundation Classes Product Models for Structural Steel.” Presented at the *International Conference on Computing in Civil and Building Engineering*, June 14-16, 2006, Montreal, Canada.
- Sacks, Rafael (Ph.D.), Charles M. Eastman, Ghang Lee, Ph.D. and David Orndorff, P.E. “A Target Benchmark of the Impact of Three-Dimensional Parametric Modeling in Precast Construction.” *PCI Journal*. July-August 2005. Pp. 126 – 139.
- Stephens, Jeff (Editor), et al. *IFC Model Based Operation and Maintenance of Buildings (ifc-mBomb)*. D41 Assessment Study (WP4-T41-D41). February 2005.
- Teague, Tom. FIATECH Automating Equipment Information Exchange (AEX) Project. *Contents - Using XML Schemas for Facilities Equipment, Version 1.0*. 19 July 2004. Available at <http://www.fiatech.org/pdfs/deliverables/AEX/Contents.pdf>.
- Teague, Tom, Mark Palmer and Marty Burns. FIATECH Automating Equipment Information Exchange (AEX) Project. *Using XML Schemas for Facilities Equipment, Version 2.0*. 19 July 2004. Available at http://www.fiatech.org/pdfs/deliverables/AEX/Using_XML.pdf.

Teague, Tom, Mark Palmer and R.W. Turton. FIATECH Automating Equipment Information \ Exchange (AEX) Project. *XML Schema Development Guidelines*. 3 February 2004. Available at <http://www.fiatech.org/pdfs/deliverables/AEX/XMLSchemaDevelopmentGuidelines.pdf>.

U.S. General Services Administration (GSA). GSA Public Buildings Service and Office of the Chief Architect. *GSA BIM Guide Series 01 - Overview*. Version 0.85. 2006.

U.S. General Services Administration (GSA). GSA Public Buildings Service and Office of the Chief Architect. *GSA BIM Guide Series 02 - GSA BIM Guide For Spatial Program Validation*. Version 0.90. 2006.

U.S. General Services Administration (GSA). GSA Public Buildings Service. *Strategic Plan and Framework for Project Information*. November 2000.

White, Stephen A. *Introduction to BPMN*. IBM Corporation. May 2004. Available at <http://www.bpmn.org/Documents/Introduction%20to%20BPMN.pdf>.

7.4 APPENDIX D – Links to Information Delivery Specifications and Standards

2005 Code of Standard Practice for Steel Buildings and Bridges, 2005.

<http://www.aisc.org/ContentManagement/ContentDisplay.cfm?ContentID=27714>

Accessed on 5 January 2007

Building Lifecycle Interoperable Software (BLIS)

<http://www.blis-project.org>

Accessed on 5 January 2007

CIMsteel Integration Standards, Release 2 (CIS/2), 2003.

<http://www.cis2.org>

Accessed on 5 January 2007

CIS/2@GT: Design Computing group in College of Architecture of Georgia Institute of Technology (Georgia Tech) is a technical support group in CIS/2 based electronic data interchange in structural steel industry. CIS/2@GT is an online technical resource hosted by Georgia Tech.

<http://www.arch.gatech.edu/~aisc/>

Accessed on 1 March 2007

National Institute of Standards and Technology (NIST) CIS/2 resources

This website provides a brief overview of CIS/2 and IFC with links to many useful resources, papers, and articles. There are also many examples of VRML and IFC models generated from the NIST CIS/2 to VRML and IFC Translator.

<http://cis2.nist.gov/>

Accessed on 6 March 2007

EPISTLE Data Handover Guide, 1998.

Part 1 – http://www.uspi.nl/tiki-download_file.php?fileId=164

Part 2 – http://www.uspi.nl/tiki-download_file.php?fileId=165

Accessed on 5 January 2007

European CIMSTEEL initiative (1987 – 1998),

<http://www.engineering.leeds.ac.uk/civil/research/cae/past/cimsteel/cimsteel.htm>

Accessed on 5 January 2007

FIATECH's Automating Equipment Information Exchange (AEX): XML schemas for the exchange of equipment information, Version 1.0, 2004.

<http://www.fiatech.org/links.htm#aex>

Accessed on 5 January 2007

FIATECH's Data Standards Clearinghouse: Provides summary information about the listed standards as well as links to the underlying sponsor organization and standards effects.

<http://www.fiatech.org/projects/idim/dscdata.htm>

Accessed on 5 January 2007

Green Building XML (gbXML): Developed to facilitate the transfer of building information stored in CAD building information models, enabling integrated interoperability between building design models and a wide variety of engineering analysis tools and models available.

<http://www.gbxml.org>

Accessed on 5 January 2007

International Alliance for Interoperability (IAI) ifcXML: A representation of the IFC EXPRESS model developed by the IAI.

[http://www.iai-international.org/Model/IFC\(ifcXML\)Specs.html](http://www.iai-international.org/Model/IFC(ifcXML)Specs.html)

Accessed on 5 January 2007

Industry Foundation Classes – Release 2x (IFC 2x), IFC Technical Guide, Enabling Interoperability in the AEC/ FM, 2000.

http://www.iai-international.org/Model/documentation/IFC_2x_Technical_Guide.pdf

Accessed on 5 January 2007

IGES (Initial Graphics Exchange Specification), 1996.

<http://www.itl.nist.gov/fipspubs/fip177-1.htm>

Accessed on 5 January 2007

International Centre for Facilities

<http://www.icf-cebe.com/>

Accessed on February 23, 2007

International Organization for Standardization (ISO) 10303 Standard for the Exchange of Product Model Data (STEP): Multi-part standard
Published and under development.

http://www.tc184-sc4.org/SC4_Open/SC4%20Legacy%20Products%20%282001-08%29/STEP_%2810303%29/

Accessed on 5 January 2007

International Organization for Standardization (ISO) 12006-2 provides a framework for the classification of information about construction works implementations of 12006-2, particularly Uniclass in the U.K. and OmniClass in the U.S.

Published Standard, 2001.

<http://www.iso.org/iso/en/CatalogueDetailPage.CatalogueDetail?CSNUMBER=35333&ICS1=91&ICS2=10&ICS3=1>

Accessed on 5 January 2007

International Organization for Standardization (ISO) 12006-3: 2007 specifies a language-independent information model which can be used for the development of dictionaries used to store or provide information about construction works. It enables classification systems, information models, object models and process models to be referenced from within a common framework.

Under Development

<http://www.iso.org/iso/en/CatalogueDetailPage.CatalogueDetail?CSNUMBER=38706&scopelists=PROGRAMME>

Accessed on 28 February 2007

International Organization for Standardization (ISO) 14721: 2003 Defines an archival system dedicated to preserving and maintaining access to digital information over the long term
Published Standard, 2003.

<http://www.iso.org/iso/en/CatalogueDetailPage.CatalogueDetail?CSNUMBER=24683&ICS1=49&ICS2=140&ICS3=>

Accessed on 5 January 2007

International Organization for Standardization (ISO) 15926: Integration of Life-Cycle Data for Process Plants Including Oil and Gas Production, designed to provide a comprehensive standard for the description of process plant facilities

Part 1, Published Standard, 2004.

<http://www.iso.org/iso/en/CatalogueDetailPage.CatalogueDetail?CSNUMBER=29556&ICS1=75&ICS2=20&ICS3=>

Accessed on 5 January 2007

Part 2, Published Standard, 2003.

<http://www.iso.org/iso/en/CatalogueDetailPage.CatalogueDetail?CSNUMBER=29557&ICS1=25&ICS2=40&ICS3=40>

Accessed on 5 January 2007

Part 4, Under Development

<http://www.iso.org/iso/en/CatalogueDetailPage.CatalogueDetail?CSNUMBER=41329&scopelists=PROGRAMME>

Accessed on 5 January 2007

International Organization for Standardization (ISO)/ Publicly Available Specification (PAS) 16739: 2005. This standard covers the general building type.
Published Standard, 2005.

<http://www.iso.org/iso/en/CatalogueDetailPage.CatalogueDetail?CSNUMBER=38056&scopelists=PROGRAMME>

Accessed on 5 January 2007

International Organization for Standardization (ISO) 17799

Information technology -- Security techniques -- Code of practice for information security management

Edition 1, Withdrawn Standard, 2001.

<http://www.iso.org/iso/en/CatalogueDetailPage.CatalogueDetail?CSNUMBER=33441&ICS1=35&ICS2=40&ICS3=>

Accessed on 5 January 2007

Edition 2, Published Standard, 2005.

http://www.iso.org/iso/en/CatalogueDetailPage.CatalogueDetail?CSNUMBER=39612&scopelis_t=PROGRAMME

Accessed on 5 January 2007

International Organization for Standardization (ISO) 19005-1:2005, Document Management – Electronic Document File Format for Long-Term Preservation – Part 1: Use of PDF 1.4
Published Standard, 2005.

<http://www.iso.org/iso/en/CatalogueDetailPage.CatalogueDetail?CSNUMBER=38920&ICS1=37&ICS2=100&ICS3=99>

Accessed on 5 January 2007

International Organization for Standardization (ISO)/DIS 82045-5: 2005

Document management – Part 5: Application of metadata for the construction and facility management sector.

Published Standard, 2005.

http://www.iso.org/iso/en/CatalogueDetailPage.CatalogueDetail?CSNUMBER=34952&scopelis_t=PROGRAMME

Accessed on 5 January 2007

National Building Information Model Standard (NBIMS)

<http://www.nbims.org>

Accessed on 5 January 2007

National Institute of Standards and Technology (NIST)

<http://www.bfrl.nist.gov/top/Whatwedo.htm>

Accessed on 6 March 2007

Unified Facilities Guide Specification (UFGS) 01781 *Operations and Maintenance Support Information (OMSI)*

<http://www.wbdg.org/ccb/DOD/UFGS/UFGS%2001%2078%2023.pdf>

Accessed on 5 January 2007

U.S. General Services Administration (GSA). GSA Public Buildings Service and Office of the Chief Architect. *GSA BIM Guide Series 01 - Overview*. Version 0.85. 2006.

Draft

http://www.gsa.gov/gsa/cm_attachments/GSA_DOCUMENT/GSA_BIM_01_v05_R2C-a3-1_0Z5RDZ-i34K-pR.pdf

Accessed on 5 January 2007

U.S. General Services Administration (GSA) Public Buildings Service and Office of the Chief Architect. *GSA BIM Guide Series 02 - GSA BIM Guide For Spatial Program Validation*. Version 0.90, 2006.

Draft

http://www.gsa.gov/gsa/cm_attachments/GSA_DOCUMENT/GSA_BIM_02_Main_v09_R2C-a3-1_0Z5RDZ-i34K-pR.pdf

Accessed on 5 January 2007

Whole Building Design Guide (WBDG)

<http://www.wbdg.org>

Accessed on 9 February 2007

7.5 APPENDIX E – Organizations that Promote Interoperability

AIA – American Institute of Architects

<http://www.aia.org>

<http://www.aia.org/IP>

<http://www.aia.org/TAP>

<http://www.building-connections.info>

AISC - American Institute of Steel Construction

<http://www.aisc.org>

BLIS - Building Lifecycle Interoperable Software

<http://www.blis-project.org>

Building Connections

www.building-connections.info

CABA - Continental Automated Buildings Association

<http://www.caba.org>

CURT - Construction Users Roundtable

<http://www.curt.org/>

FIATECH

<http://www.fiatech.org>

gbXML - Green Building XML

<http://www.gbxml.org>

IAI - International Alliance for Interoperability

<http://www.iai-na.org>

ICF – International Centre for Facilities

<http://www.icf-cebe.com>

IFMA - International Facility Management Association

<http://www.ifma.org>

MIMOSA - Machinery Information Management Open Systems Alliance

<http://www.mimosa.org>

NBIMS - National BIM Standard

<http://www.nbims.org>

NFRC - National Fenestration Rating Council

<http://www.nfrc.org>

NIBS - National Institute of Building Sciences

<http://www.nibs.org>

NIST - National Institute of Standards and Technology

<http://cic.nist.gov>

OGC - Open Geospatial Consortium

<http://www.opengeospatial.org>

OSCRE - Open Standards Consortium for Real Estate

<http://www.oscre.org>

PISCES - Property Information Systems Common Exchange Standard Limited

<http://www.pisces.co.uk>

SABLE - Simple Access to Building Lifecycle Exchange

<http://www.blis-project.org/~sable/>