



NK Series Compact Routers User Guide

Thank You for Choosing Ross

You've made a great choice. We expect you will be very happy with your purchase of Ross Technology. Our mission is to:

1. Provide a Superior Customer Experience
 - offer the best product quality and support
2. Make Cool Practical Technology
 - develop great products that customers love

Ross has become well known for the Ross Video Code of Ethics. It guides our interactions and empowers our employees. I hope you enjoy reading it below.

If anything at all with your Ross experience does not live up to your expectations be sure to reach out to us at solutions@rossvideo.com.



David Ross
CEO, Ross Video
dross@rossvideo.com

Ross Video Code of Ethics

Any company is the sum total of the people that make things happen. At Ross, our employees are a special group. Our employees truly care about doing a great job and delivering a high quality customer experience every day. This code of ethics hangs on the wall of all Ross Video locations to guide our behavior:

1. We will always act in our customers' best interest.
2. We will do our best to understand our customers' requirements.
3. We will not ship crap.
4. We will be great to work with.
5. We will do something extra for our customers, as an apology, when something big goes wrong and it's our fault.
6. We will keep our promises.
7. We will treat the competition with respect.
8. We will cooperate with and help other friendly companies.
9. We will go above and beyond in times of crisis. *If there's no one to authorize the required action in times of company or customer crisis - do what you know in your heart is right. (You may rent helicopters if necessary.)*

NK Series · User Guide

- Ross Part Number: **9807DR-0100-03**
- Release Date: December 4, 2017.

The information contained in this Guide is subject to change without notice or obligation.

Copyright

©2017 Ross Video Limited, Ross®, and any related marks are trademarks or registered trademarks of Ross Video Limited. All other trademarks are the property of their respective companies. PATENTS ISSUED and PENDING. All rights reserved. No part of this publication may be reproduced, stored in a retrieval system, or transmitted in any form or by any means, mechanical, photocopying, recording or otherwise, without the prior written permission of Ross Video. While every precaution has been taken in the preparation of this document, Ross Video assumes no responsibility for errors or omissions. Neither is any liability assumed for damages resulting from the use of the information contained herein.

Patents

Patent numbers US 7,034,886; US 7,508,455; US 7,602,446; US 7,802,802 B2; US 7,834,886; US 7,914,332; US 8,307,284; US 8,407,374 B2; US 8,499,019 B2; US 8,519,949 B2; US 8,743,292 B2; GB 2,419,119 B; GB 2,447,380 B; and other patents pending.

Notice

The material in this manual is furnished for informational use only. It is subject to change without notice and should not be construed as commitment by Ross Video Limited. Ross Video Limited assumes no responsibility or liability for errors or inaccuracies that may appear in this manual.

Trademarks

- Microsoft, Encarta, MSN, and Windows are either registered trademarks or trademarks of Microsoft Corporation in the United States and/or other countries.
- Oracle and Java are registered trademarks of Oracle and/or its affiliates. Other names may be trademarks of their respective owners.
- All other product names and any registered and unregistered trademarks mentioned in this guide are used for identification purposes only and remain the exclusive property of their respective owners.

Safety Notices

Refer to the “**Important Regulatory and Safety Notices**” document that accompanied your product.

Statement of Compliance

This product has been determined to be compliant with the applicable standards, regulations, and directives for the countries where the product is marketed.

Compliance documentation, such as certification or Declaration of Compliance for the product is available upon request by contacting techsupport@rossvideo.com. Please include the product; model number identifiers and serial number and country that compliance information is needed in request.

EMC Notices

US FCC Part 15

This equipment has been tested and found to comply with the limits for a class A Digital device, pursuant to part 15 of the FCC Rules. These limits are designed to provide reasonable protection against harmful interference when the equipment is operated in a Commercial environment. This equipment generates, uses, and can radiate radio frequency energy and, if not installed and used in accordance with the instruction manual, may cause harmful interference to radio communications. Operation of this equipment in a residential area is likely to cause harmful interference in which case the user will be required to correct the interference at his own expense.



Notice — *Changes or modifications to this equipment not expressly approved by Ross Video Limited could void the user's authority to operate this equipment.*

Canada

This Class A device complies with Canadian ICES-003 rules.

Cet appareil numérique de la classe "A" est conforme à la norme NMB-003 du Canada.

European Union

This equipment is in compliance with the essential requirements and other relevant provisions established under regulation (EC) No 765/2008 and Decision No 768/2008/EC referred to as the "New Legislative Framework".



Warning — *This equipment is compliant with Class A of CISPR 32. In a residential environment this equipment may cause radio interference.*

Australia/New Zealand

This equipment is in compliance with the provisions established under the Radiocommunications Act 1992 and Radiocommunications Labeling (Electromagnetic Compatibility) Notice 2008.

Korea

This equipment is in compliance with the provisions established under the Radio Waves Act.

Class A equipment (Broadcasting and communications service for business use).

This device is a business-use (Class A) EMC-compliant device. The seller and user are advised to be aware of this fact. This device is intended for use in areas outside home.

Type of Equipment	User's Guide
A급 기기 (업무용 방송통신기자재)	이 기기는 업무용(A급) 전자파적합기기로서 판매자 또는 사용자는 이 점을 주의하시기 바라며, 가정외의 지역에서 사용하는 것을 목적으로 합니다.
Class A Equipment (Industrial Broadcasting & Communication Equipment)	This equipment is Industrial (Class A) electromagnetic wave suitability equipment and seller or user should take notice of it, and this equipment is to be used in the places except for home.

International

This equipment has been tested under the requirements of CISPR 22:2008 or CISPR 32:2015 and found to comply with the limits for a Class A Digital device.

Notice — *This is a Class A product. In domestic environments, this product may cause radio interference, in which case the user may have to take adequate measures.*

Warranty and Repair Policy

The NK Series system is backed by a comprehensive one-year warranty on all components.

If an item becomes defective within the warranty period Ross will repair or replace the defective item, as determined solely by Ross.

Warranty repairs will be conducted at Ross, with all shipping FOB Ross dock. If repairs are conducted at the customer site, reasonable out-of-pocket charges will apply. At the discretion of Ross, and on a temporary loan basis, plug in circuit boards or other replacement parts may be supplied free of charge while defective items undergo repair. Return packing, shipping, and special handling costs are the responsibility of the customer.

This warranty is void if products are subjected to misuse, neglect, accident, improper installation or application, or unauthorized modification.

In no event shall Ross Video Limited be liable for direct, indirect, special, incidental, or consequential damages (including loss of profit). Implied warranties, including that of merchantability and fitness for a particular purpose, are expressly limited to the duration of this warranty.

This warranty is TRANSFERABLE to subsequent owners, subject to Ross' notification of change of ownership.

Extended Warranty

For customers that require a longer warranty period, Ross offers an extended warranty plan to extend the standard warranty period by one year increments. For more information, contact your regional sales manager.

Environmental Information

The equipment may contain hazardous substances that could impact health and the environment.

To avoid the potential release of those substances into the environment and to diminish the need for the extraction of natural resources, Ross Video encourages you to use the appropriate take-back systems. These systems will reuse or recycle most of the materials from your end-of-life equipment in an environmentally friendly and health conscious manner.

The crossed-out wheeled bin symbol invites you to use these systems.



If you need more information on the collection, reuse, and recycling systems, please contact your local or regional waste administration. You can also contact Ross Video for more information on the environmental performances of our products.

Company Address



Ross Video Limited

8 John Street
Iroquois, Ontario
Canada, K0E 1K0

Ross Video Incorporated

P.O. Box 880
Ogdensburg, New York
USA 13669-0880

General Business Office: (+1) 613 • 652 • 4886

Fax: (+1) 613 • 652 • 4425

Technical Support: (+1) 613 • 652 • 4886

After Hours Emergency: (+1) 613 • 349 • 0006

E-mail (Technical Support): techsupport@rossvideo.com

E-mail (General Information): solutions@rossvideo.com

Website: <http://www.rossvideo.com>

Contents

Introduction	11
Related Publications	11
Documentation Conventions	12
Interface Elements	12
User Entered Text	12
Referenced Guides	12
Menu Sequences	12
Important Instructions	12
Contacting Technical Support	12
Getting Started	13
NK-16, NK-32, and NK-34 Series Routers	13
NK-64 and NK-72 Router Formats	14
Possible Matrices	14
NK Series Power Supplies	15
Routers Hardware Overview	17
Front Panel	17
NK-16, NK-32, and NK-34 Rear Panels	17
AES/EBU Digital Audio Level	18
Analog Video Level	19
Stereo Analog Audio Level	20
Machine Control/Data Level	21
NK-64 and NK-72 Router Formats	21
NK-S, NK-MD, and NK-3G Series	21
AES/EBU Digital Audio Level	22
Stereo Analog Audio Level	23
Control Panel Hardware Overview	25
RCP-NK1	25
RCP-NKM	26
RCP-NKQ	27
Interfaces and Connectivity	29
Communication Interfaces	29
T-Bus Control System	29
DashBoard Overview	29
Walkabout Overview	29
NK Series Communication Devices	29
NK-VRC	29
NK-IPS	30
NK-HUB	30
NK-3RD	31
NK-SCP Series	31
NK-GPI	31
Physical Installation	33
Before You Begin	33
Unpacking and Pre-installation	33
Connecting NK Components Overview	33

Linking the Components	33
Power	35
Video Referencing	36
Connecting the NK-SCP/A	37
Connecting the NK-SCP/K2	37
Parallel to Serial Converter	37
Connecting the NK-GPI	38
Pinouts	39
Connecting GPI Inputs	39
Connecting GPI Outputs	39
Customizing RCP-NK1 Control Panels	40
Localizing the Panel	40
Customizing the RCP-NK1 Button Labels	42
Default Configurations	43
RCP-NK1 Control Panel Default Key Assignment	43
NK Series Router Levels Default	45
RCP-NKM/Q Control Panel Default Key Assignments	45
RCP-NKM Defaults	45
RCP-NKQ Defaults	45
Breakaways Default	45
Router Levels Default	46
Configuring a Panel	47
Configuring Breakaways	47
Breakaway Reset	47
Breakaway Warning Mode	47
Assigning Functions to Keys	47
Configuring the Cut Bus Destinations	48
Setting the Brightness for the ON State	48
Setting the Brightness for the OFF State	50
Enabling Machine Control	50
Machine Control Level	50
Specifying a Communication Retry Delay	50
Linking the Control Panels	51
Locking the Panel	51
Configuring the NK-SCP Series	53
Configuring the Breakaway Levels	53
NK-SCP/K2 Configuration	53
Configuring via the NK-IPS	53
Configuring the NK-GPI	55
Configuring the NK-GPI	55
Configuring the GPI Inputs	55
Setting the GPI Inputs	55
Selecting the GPI In Mode	55
Configuring the GPI Outputs	55
Selecting the GPI Out Mode	55
Specifying a Panel Link Address	55
NK Series Operation	57
Start-up Process	57
Router Start-up	57
Control Panel Start-up	57

Single Panel RCP-NK1 Operation	57
Selecting a Destination	58
Selecting a Source	58
Using the Shift Keys	59
Using the Crosspoint Keys	59
Selecting a Level	59
Using the Breakaway Keys	59
Using Macros	60
Using the Protect Key	61
Using the Panel Lock	62
Using the TAKE Key	62
Using the Chop Key	62
Linked Panel RCP-NK1 Operation	62
Analog Audio Router Levels	65
NK-A64 Control Layer	65
Control Layer Operation via RCP-NK Panels	66
Mixing the Output Audio Signal	66
Examples	67
Router Interfaces Overview	69
Device Properties Interface Overview	69
Device Properties Fields	69
Configuration Fields	69
Status Fields	71
Submit and Upgrade Firmware Fields	72
RCP Interfaces Overview	73
Device Properties Interface Overview	73
Device Properties Fields	73
Configuration Fields	73
Protect Alarm	74
Submit Settings	74
Upgrade Firmware	74
NK-SCP/A Overview	75
Using the ASCII Protocol with the NK-SCP/A	75
Fixed Parameters	75
Commands	75
NK-SCP/K2 Operation	77
NKP-SCP/A Device Properties Interface Overview	77
Device Properties Fields	77
Configuration Fields	78
Submit Settings	78
Upgrade Firmware	78
NKP-SCP/K2 Device Properties Interface Overview	78
Device Properties Fields	78
Configuration Fields	79
NK-GPI Interfaces Overview	81
NKP-GPI Device Properties Interface Overview	81
Device Properties Fields	81
Configuration Fields	81
Submit Settings	82
Upgrade Firmware	82

Connectors and Pinouts	83
DB-25 Pinouts for Analog and Digital Audio Routers	83
NK-A16 and NK-D32/110 Wiring (16x16 Routers)	83
NK-A16 Unbalanced Wiring	83
NK-A32 and NK-D32/110 Wiring (32x32 Routers)	84
NK-A32 Unbalanced Wiring	84
NK-A64 Wiring (64x64 Routers)	85
NK-D64/110 Wiring	86
DB-9 Power Connector (All NK-16 and NK-32 Routers)	86
Machine Control DB-9 Pinouts (NK-M16 and NK-M32)	87
GPI Alarm Pinouts (NK-64 and NK-72)	88
T-BUS RJ-45 Connector	88
NK-SCP/A DB-9 Pinouts	88
NK-SCP/K2 DB-9 Pinouts	89
Technical Specifications	91
NK-16, NK-32, and NK-64 Routers	91
NK-S, NK-MD, and NK-3G Series	91
AES/EBU Digital Audio Level Routers	92
Analog Video Level Routers	93
Stereo Analog Audio Level	94
Machine Control/Data Level	95
NK-64 and NK-72 Routers	95
NK-S, NK-MD, and NK-3G Series	95
AES/EBU Digital Audio Level	96
Stereo Analog Audio Level	97
Control Panels	98
RCP-NK1	98
Glossary	99

Introduction

This guide is for system administrators, installers, and operators of the Ross Video NK Series Routing System. It provides instructions on how to connect and configure the routing switcher system. It assumes that you are experienced with general broadcast concepts, and that you are familiar with the planning requirements for a routing switcher system.

- “**Introduction**” summarizes the guide and provides important terms, and conventions.
- “**Getting Started**” provides an overview for creating a routing system with NK Series, and general information to keep in mind before installing and configuring your NK Series panel.
- “**Routers Hardware Overview**” provides a basic introduction to the NK Series front and rear panels.
- “**Control Panel Hardware Overview**” provides a basic introduction to the front and rear panels of the NK Series remote control panels.
- “**Interfaces and Connectivity**” summarizes the interfaces and NK series devices used for communication across a routing system.
- “**Physical Installation**” provides instructions for the basic physical installation of the NK Series products.
- “**Default Configurations**” summarizes the default configurations for NK routers and control panels to be used straight out of the box.
- “**Configuring a Panel**” provides information for configuring the RCP-NK1 to control NK Series routers.
- “**Configuring the NK-SCP Series**” provides information to enable NK routers to be interfaced by the NK-SCP/A.
- “**Configuring the NK-GPI**” provides information for using the NK-GPI as a universal GPI interface for the NK Series of routers.
- “**NK Series Operation**” provides a brief summary of operating the NK Series products.
- “**Analog Audio Router Levels**” describes the Analog Audio control layers for NK Series products.
- “**Router Interfaces Overview**” summarizes the DashBoard interfaces for the NK Series routers.
- “**RCP Interfaces Overview**” summarizes the DashBoard interfaces for the NK Series remote control panels.
- “**NK-SCP/A Overview**” summarizes the interfaces for the NK-SCP/A.
- “**NK-GPI Interfaces Overview**” summarizes the interfaces for the NK-GPI.
- “**Connectors and Pinouts**” provides additional information on the pinout assignments and connector details for the NK Series products.
- “**Technical Specifications**” provides the specifications for the NK Series products.
- “**Glossary**” provides a list of terms used throughout this guide.

Related Publications

It is recommended to consult the following Ross documentation before installing and configuring your NK Series:

- *DashBoard User Guide*, Ross Part Number: 8351DR-004
- *NK-NET User Guide*, Ross Part Number: 2201DR-002
- *NK-IPS User Guide*, Ross Part Number: 9807DR-1020

A separate user guide is available for the following products:

- NK-3G320 Routing Switcher
- NK-3G144 Routing Switcher
- NK-IPS Internet Protocol Server
- NK-VRC Virtual Routing Core

- NK-3RD Third Party Interface
- RCP-NKM Remote Control Panel
- RCP-NKQ Remote Control Panel

Documentation Conventions

Special text formats are used in this guide to identify parts of the user interface, text that a user must enter, or a sequence of menus and sub-menus that must be followed to reach a particular command.

Interface Elements

Bold text is used to identify a user interface element such as a dialog box, menu item, or button. For example:

In the **Edit** dialog, click **Insert Above**.

User Entered Text

Courier text is used to identify text that a user must enter. For example:

In the **Language** box, enter **English**.

Referenced Guides

Italic text is used to identify the titles of referenced guides, manuals, or documents. For example:

For more information, refer to the *DashBoard User Guide*.

Menu Sequences

Menu arrows are used in procedures to identify a sequence of menu items that you must follow. For example, if a step reads “**File > Save As**,” you would click the **File** menu and then click **Save As**.

Important Instructions

Star icons are used to identify important instructions or features. For example:

- ★ Contact your IT department before connecting to your facility network to ensure that there are no conflicts. They will provide you with an appropriate value for the IP Address, Subnet Mask, and Gateway for your device.

Contacting Technical Support

At Ross Video, we take pride in the quality of our products, but if problems occur, help is as close as the nearest telephone.

Our 24-hour Hot Line service ensures you have access to technical expertise around the clock. After-sales service and technical support is provided directly by Ross Video personnel. During business hours (Eastern Time), technical support personnel are available by telephone. After hours and on weekends, a direct emergency technical support phone line is available. If the technical support person who is on call does not answer this line immediately, a voice message can be left and the call will be returned shortly. This team of highly trained staff is available to react to any problem and to do whatever is necessary to ensure customer satisfaction.

- **Technical Support:** (+1) 613-652-4886
- **After Hours Emergency:** (+1) 613-349-0006
- **E-mail:** techsupport@rossvideo.com
- **Website:** <http://www.rossvideo.com>

Getting Started

Ross Video's NK Series Routing Systems are a comprehensive family of routing solutions with a wide variety of matrix sizes and types to choose from, several flexible control panels, and a powerful control system tying it all together.

NK-16, NK-32, and NK-34 Series Routers

The NK Series routers are available in a variety of sizes and signal types.



Figure 2.1 16x4 Utility Switchers and 16x16 Routers (1RU) — NK-3G164



Figure 2.2 32x32 Routers (2RU) — NK-3G34



Figure 2.3 64x64 and 72x72 Routers (3RU) — NK-3G64

NK-S Series

The SDI level of the NK-16 and NK-34 range conforms to SMPTE standard 259M and is available in 16x4 (NK-S164), 16x16 (NK-S16), and 34x34 (NK-S34) sizes.

NK-MD Series

The Multi-Definition (MD) level of the NK-16 and NK-34 range conforms to SMPTE standards 259M, 292M and 344M, 16x4 (NK-MD164), 16x16 (NK-MD16), and 34x34 (NK-MD34) sizes. All NK Multi-Definition level routers have a selectable output rise and fall times, via on-board DIP switches.

NK-3G Series

The 3G level of the NK-16 and NK-34 range conforms to SMPTE standards 259M-C, 292M, 424M, and DVB-ASI, and is available in 16x4 (NK-3G164), 16x16 (NK-3G16), and 34x34 (NK-3G34).

AES/EBU Digital Audio Level

The AES/EBU level of the NK-16 and NK-32 range conforms to AES/EBU standards for digital audio. It is available in 16x4 (NK-D164), 16x16 (NK-D16), and 32x32 (NK-D32) sizes. The NK-D16, NK-D164, and NK-D32 models are available in 75ohm BNC models or 110ohm DB-25 models.

Analog Video Level

The Analog Video level of the NK-16 and NK-32 range is a wide bandwidth, high performance router available in 16x4 (NK-V164-HQ), 16x16 (NK-V16-HQ), and 32x32 (NK-V32-HQ) sizes.

Stereo Analog Audio Level

The Stereo Analog Audio level of the NK-16 and NK-32 range is a wide bandwidth, high performance router, available in 16x4 (NK-A164-HQ), 16x16 (NK-A16-HQ), and 32x32 (NK-A32-HQ) sizes. All Analog Audio level routers have selectable +4 / -10dBu input and output levels, via on-board solder links.

Machine Control / Data Level

The Machine Control level of the NK-16 and NK-32 range is capable of routing RS-422 signals for reciprocal switches. It is available both 16x16 (NK-M16), and 32x32 (NK-M32) models.

NK-64 and NK-72 Router Formats

NK-S Series

The SD level conforms to SMPTE 259M.

NK-MD Series

The Multi-Definition (MD) level conforms to SMPTE 259M, 292M and 344M. All NK Multi-Definition level routers have a selectable output rise and fall times, via on-board DIP switches.

NK-3G Series

The 3G level of the NK-64 and NK-72 support SMPTE 259M, 292M, 424M and DVB-ASI, with output reclocking. The input EQ and reclocker are by-passable through the control system. The output slew rates are automatically set.

AES/EBU Digital Audio Level

The AES/EBU level conforms to AES/EBU standards in digital audio streaming. The NK-D64 is available in 75ohm BNC models or optional 110ohm DB-25 models.

Stereo Analog Audio Level

All Analog Audio level routers have selectable +4 / -10dBu input and output levels, via on-board solder links,

Possible Matrices

Any matrix type can be built into a system with any combination of other NK matrices under one control system.

Table 2.1 NK Series Router Family

	1RU		2RU		3RU	
	16x4	16x16	32x32	34x34	64x64	72x72
3G/HD/SD	NK-3G164(-RCP)	NK-3G16(-RCP)	NK-3G34	NK-3G34	NK-3G64	NK-3G72
AES/EBU Audio	NK-D164(-RCP)	NK-D16(-RCP)	NK-D32		NK-D64	
Analog Audio	NK-A164	NK-A16	NK-A32		NK-A64	
Analog Video	NK-V164	NK-V16	NK-V32			
Data (RS-422)		NK-M16	NK-M32			

NK Series Power Supplies

Each NK Series router, control panel and control device comes standard with a single external AC/DC power supply. The exceptions to this are devices that are powered from the T-Bus, such as the RCP-NK1, NK-SPC/A, and NK-GPI. Redundant external power supplies are also available. Contact Ross Video for details.

★ The NK-RP1/P (a 100W rack mount redundant power supply) is also available to power up to four devices.

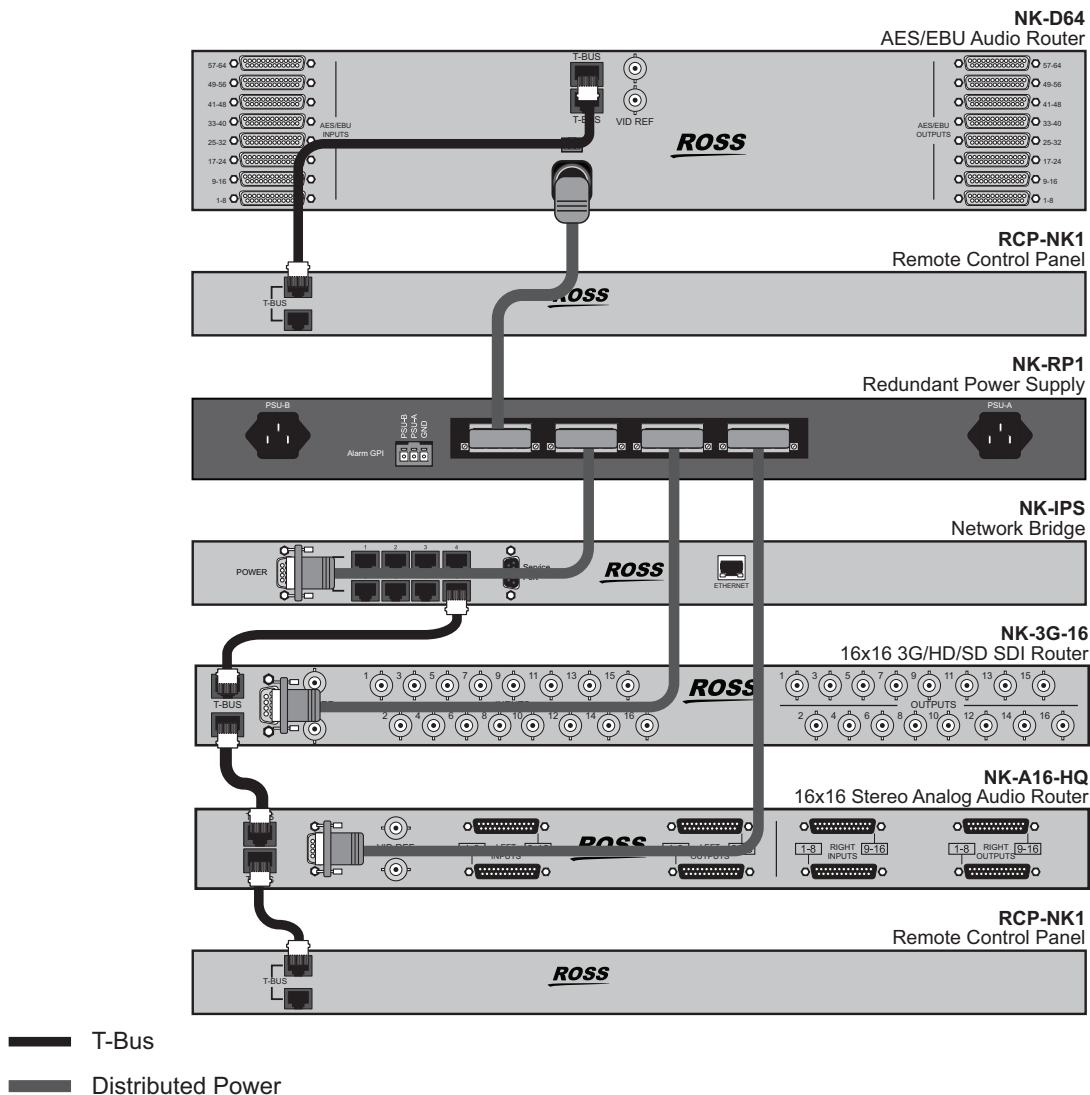

Figure 2.4 Example of NK-RP1/P Power Connections

Routers Hardware Overview

This chapter presents information on the NK Series front and rear panels.

Front Panel

The NK Series front panel provides product identification and a status LED.



Figure 3.1 NK Series — Front Panel

The NK Series routers indicate their status by a pulsating LED, called a heartbeat.

Heartbeat Behavior	Display and Description
Flickers	A switch message is handled by the router
Dims	Indicates a handled message that did not result in a switch
Flashes rapidly	An error condition is reported by the power supply

NK-16, NK-32, and NK-34 Rear Panels

The NK Series rear panel provides three series of routers:

- **NK-S Series** — The SD Level of the NK-16 and NK-34 range conforms to SMPTE 259M and is available in 16x4 (NK-S164), 16x16 (NK-S16), and 34x34 (NK-S34) sizes.
- **NK-MD Series** — The Multi-definition level of the NK-16 and NK-34 range conforms to SMPTE 259M, 292M, and 344M and is available in 16x4 (NK-MD164), 16x16 (NK-MD16), and 34x34 (NK-MD34) sizes. All NK-MD series level routers have a selectable output rise and fall times, via on-board DIP switches.
- **NK-3G Series** — The 3G level of the NK-16 and NK-34 range conforms to SMPTE 259M-C, 292M, 424M, and DVB-ASI, and is available in 16x4 (NK-3G164), 16x16 (NK-3G16), and 34x34 (NK-3G34).

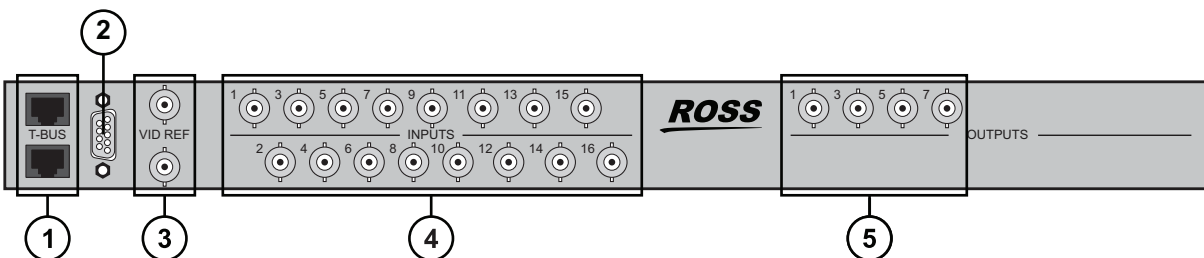

Figure 3.2 NK-S164, NK-MD164, and NK-3G164 — Rear Panel Example

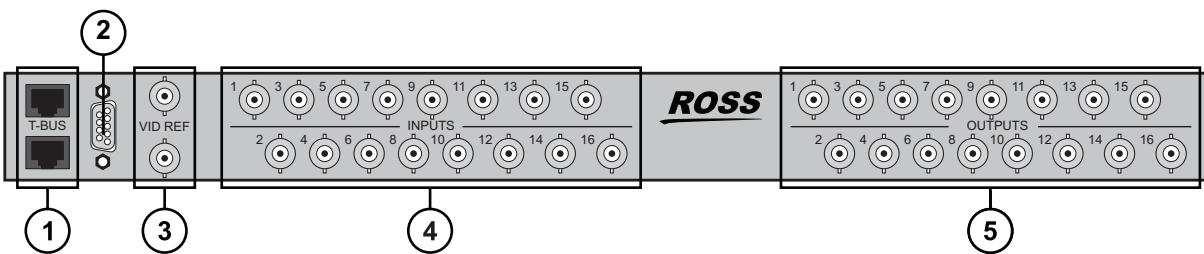

Figure 3.3 NK-S16, NK-MD16, and NK-3G16 — Rear Panel Example

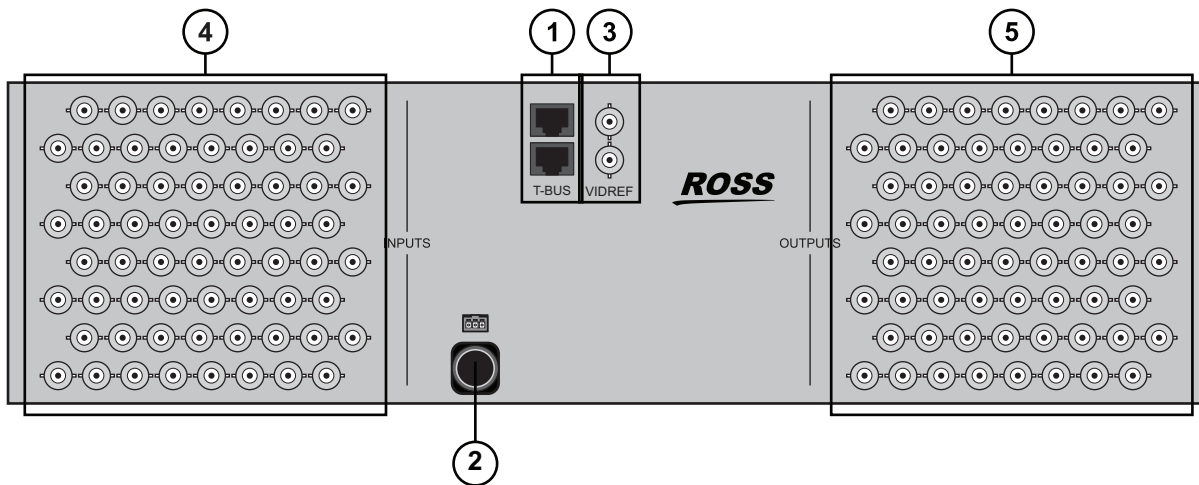

Figure 3.4 NK-S34, NK-MD34, and NK-3G34 — Rear Panel Example

- | | | |
|---------------------|-------------------------|----------------|
| 1) T-BUS Ports | 3) Video Reference BNCs | 5) OUTPUT BNCs |
| 2) POWER Connection | 4) INPUT BNCs | |

AES/EBU Digital Audio Level

The AES/EBU level of the NK-16 and NK-32 range conforms to AES/EBU standards for digital audio. It is available in 16x4 (NK-D164), 16x16 (NK-D16), and 32x32 (NK-D32) sizes.

NK-D16, NK-D164, and NK-D32 models are available in 75ohm BNC models or 110ohm DB-25 models.

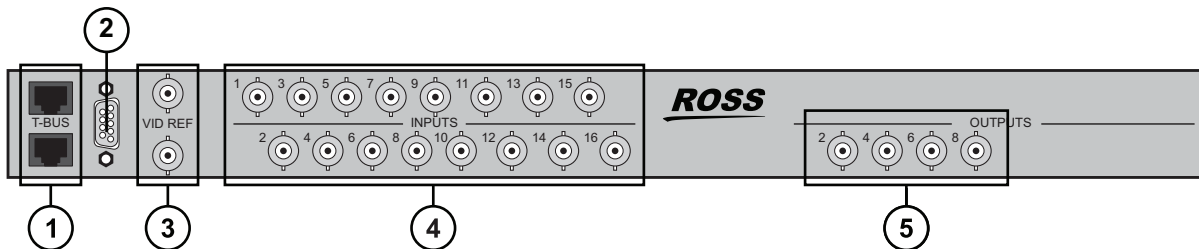

Figure 3.5 NK-D164/75 — 75ohm, 16x4 Rear Panel Example

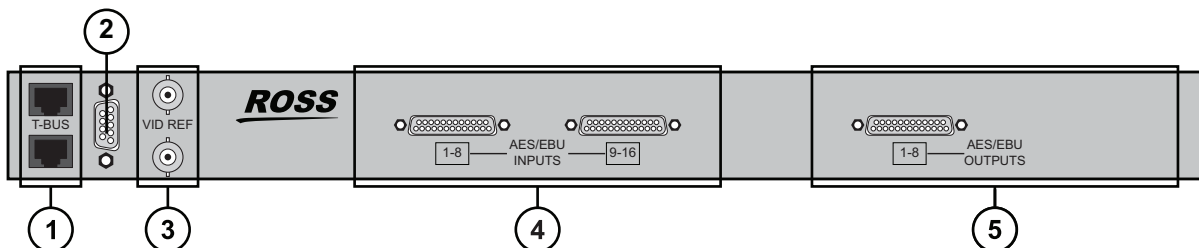

Figure 3.6 NK-D164/110 — 110ohm, 16x4 Rear Panel Example

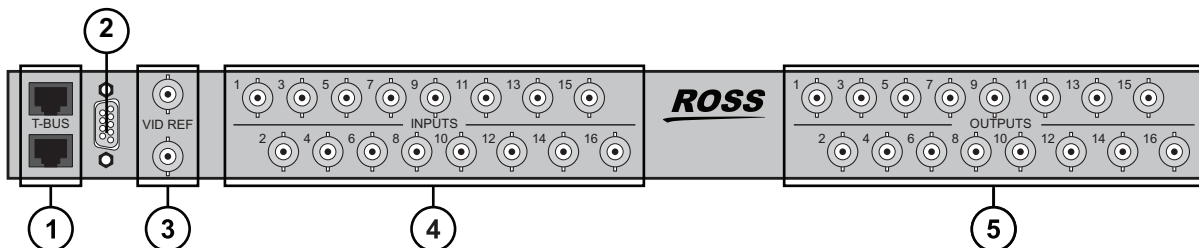

Figure 3.7 NK-D64/75 — 75ohm, 16x16 Rear Panel Example

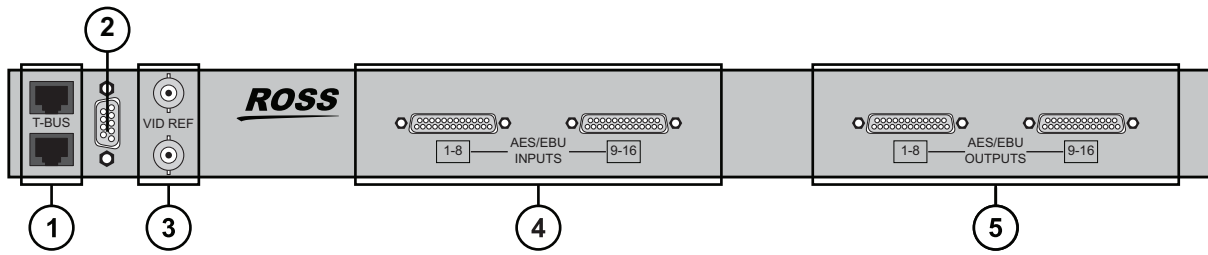

Figure 3.8 NK-D16/110 — 110ohm, 16x16 Rear Panel Example

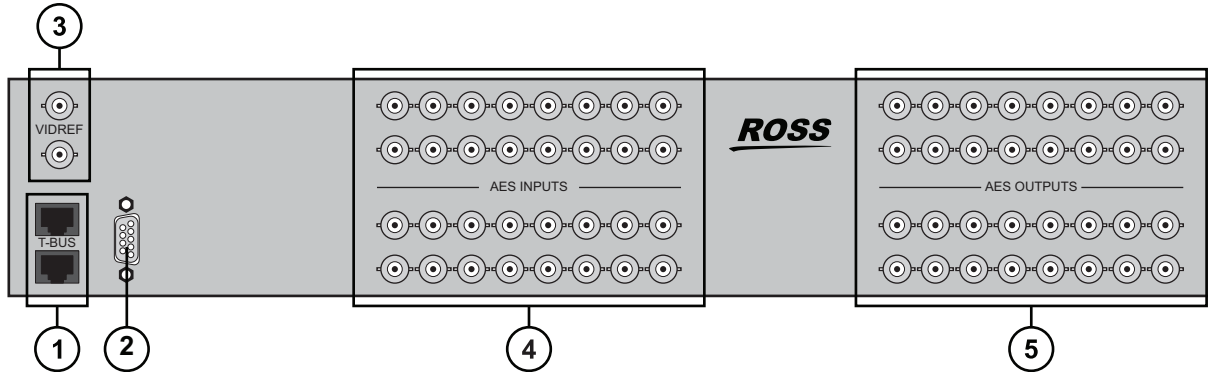

Figure 3.9 NK-D32/75 — 75ohm, 32x32 Rear Panel Example

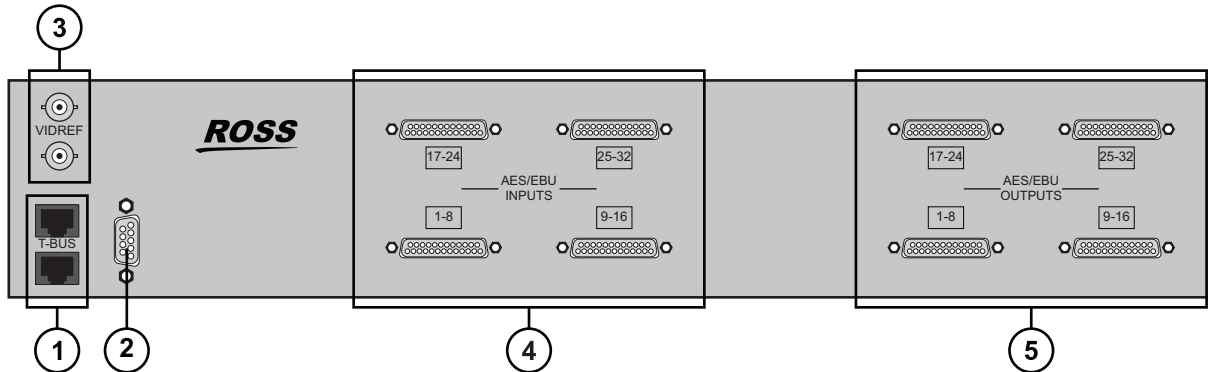

Figure 3.10 NK-D32/110 — 110ohm, 32x32 Rear Panel Example

- | | | |
|---------------------|-------------------------|-----------------------|
| 1) T-BUS Ports | 3) Video Reference BNCs | 5) OUTPUT Connections |
| 2) POWER Connection | 4) INPUT Connections | |

Analog Video Level

The Analog Video level of the NK-16 and NK-32 range is a wide bandwidth, high performance router available in 16x4 (NK-V164-HQ), 16x16 (NK-V16-HQ), and 32x32 (NK-V32-HQ) sizes.

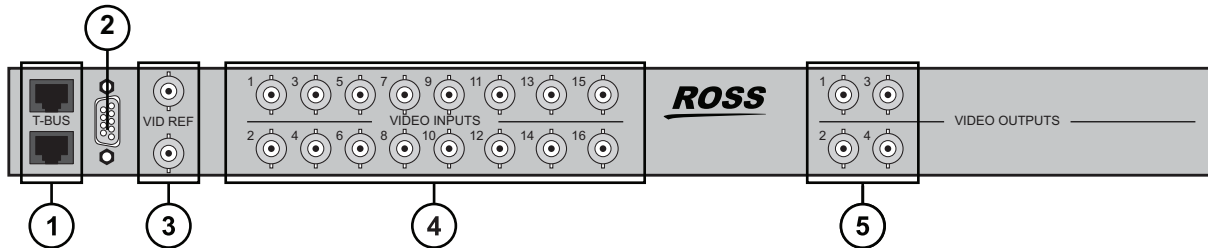

Figure 3.11 NK-V16-HQ — 16x4 Rear Panel Example

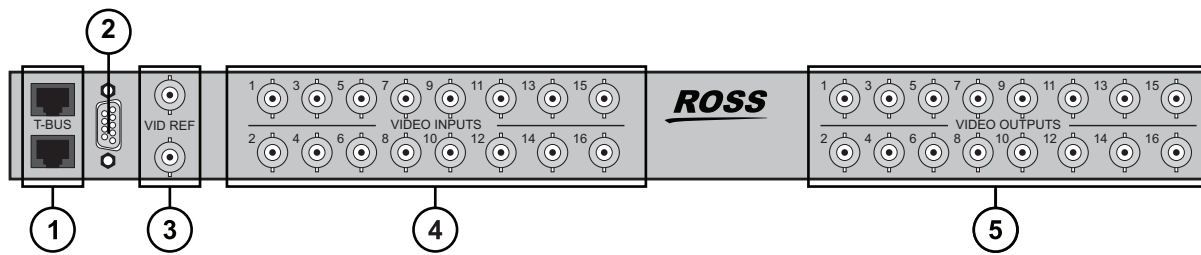

Figure 3.12 NK-V16-HQ — 16x16 Rear Panel Example

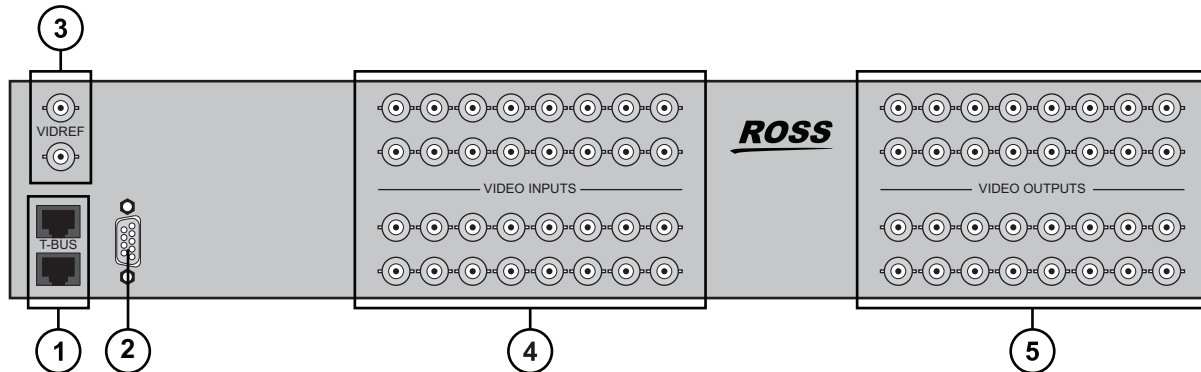

Figure 3.13 NK-V32-HQ — 32x32 Rear Panel Example

- | | | |
|---------------------|----------------------------|-----------------------------|
| 1) T-BUS Ports | 3) Video Reference BNCs | 5) VIDEO OUTPUT Connections |
| 2) POWER Connection | 4) VIDEO INPUT Connections | |

Stereo Analog Audio Level

The Stereo Analog Audio level of the NK-16 and NK-32 range is a wide bandwidth, high performance router, available in 16x4 (NK-A164-HQ), 16x16 (NK-A16-HQ), and 32x32 (NK-A32-HQ) sizes.

All Analog Audio level routers have selectable +4/-10dBu input and output levels, via on-board solder links.

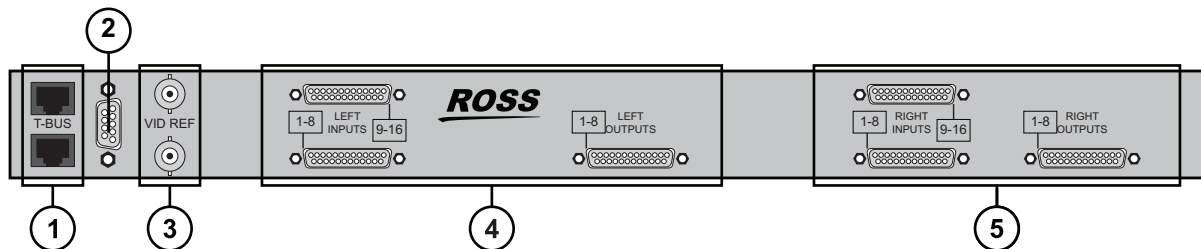

Figure 3.14 NK-A164-HQ — 16x4 Rear Panel Example

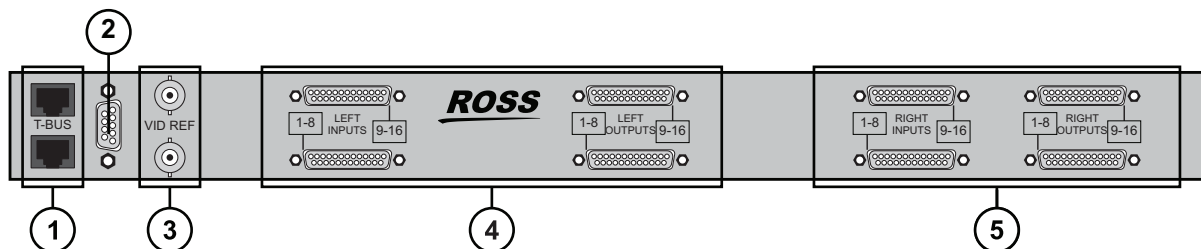

Figure 3.15 NK-V16-HQ — 16x16 Rear Panel Example

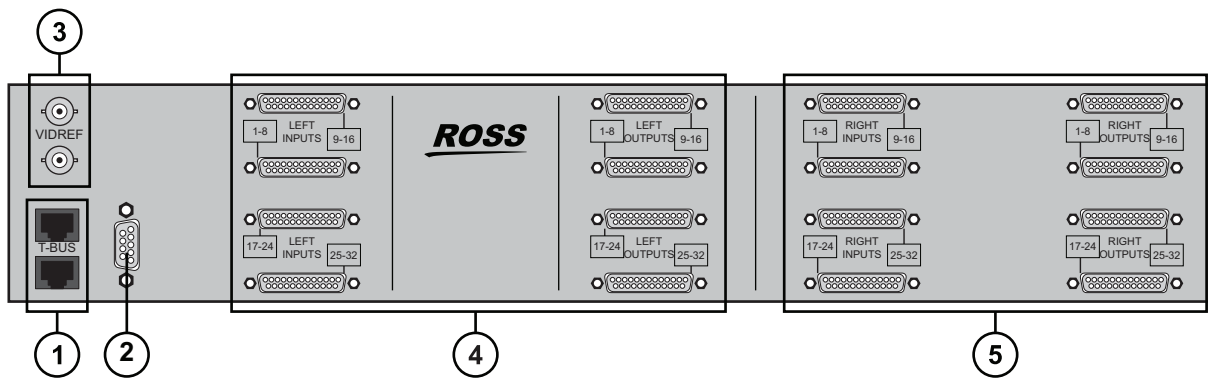

Figure 3.16 NK-A32-HQ — 32x32 Rear Panel Example

- | | | |
|---------------------|-----------------------------|------------------------------|
| 1) T-BUS Ports | 3) Video Reference BNCs | 5) Right Channel Connections |
| 2) POWER Connection | 4) Left Channel Connections | |

Machine Control/Data Level

The Machine Control level of the NK-16 and NK-32 range is capable of routing RS-422 signals for reciprocal switches. It is available both 16x16 (NK-M16), and 32x32 (NK-M32) models.

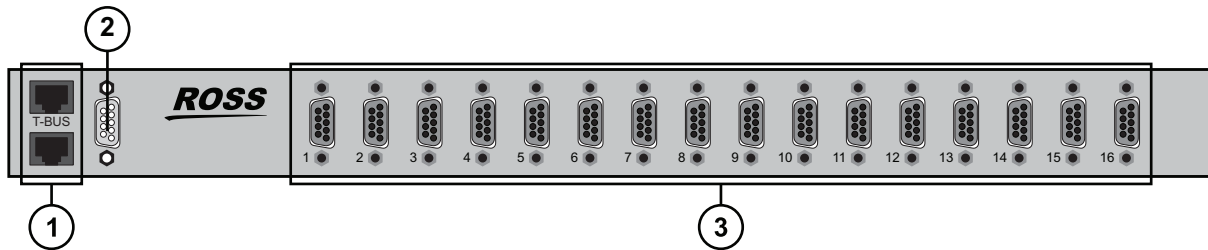

Figure 3.17 NK-M16 — 16x16 Rear Panel Example

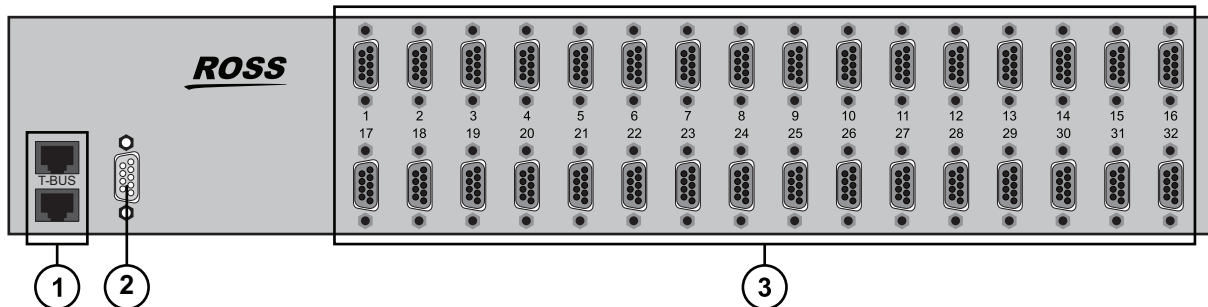

Figure 3.18 NK-M32 — 32x32 Rear Panel Example

- | | | |
|----------------|---------------------|--------------------------------|
| 1) T-BUS Ports | 2) POWER Connection | 3) Bi-directional RS-422 Ports |
|----------------|---------------------|--------------------------------|

NK-64 and NK-72 Router Formats

NK-S, NK-MD, and NK-3G Series

There are three types of SDI routers:

NK-S Series — The SDI level conforms to SMPTE standard 259M.

NK-MD Series — The Multi-Definition (MD) level conforms to SMPTE standards 259M, 292M and 344M. All NK MD level routers have a selectable output rise and fall times, via on-board DIP switches.

NK-3G Series — The NK-3G72 supports SMPTE standards 424M, 344M, 259M, and 292M with output reclocking. The input EQ and reclocker are bypass-able through the control system. The output slew rates are automatically set.

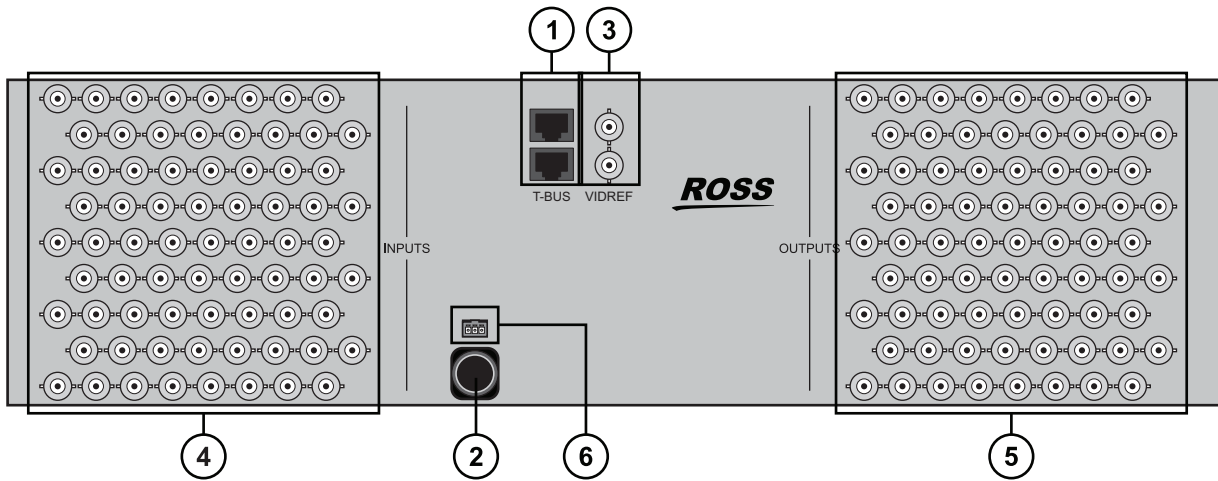

Figure 3.19 NK-S72, NK-MD72, and NK-3G72 — 72x72 Rear Panel Example

- | | | |
|---------------------|-------------------------------------|------------------------|
| 1) T-BUS Ports | 3) Video Reference Loop Connections | 5) OUTPUTS Connections |
| 2) POWER Connection | 4) INPUTS Connections | 6) GPI Alarms |

AES/EBU Digital Audio Level

The AES/EBU level conforms to AES/EBU standards in digital audio streaming. The NK-D64 is available in 75ohmBNC models or optional 110ohm DB-25 models.

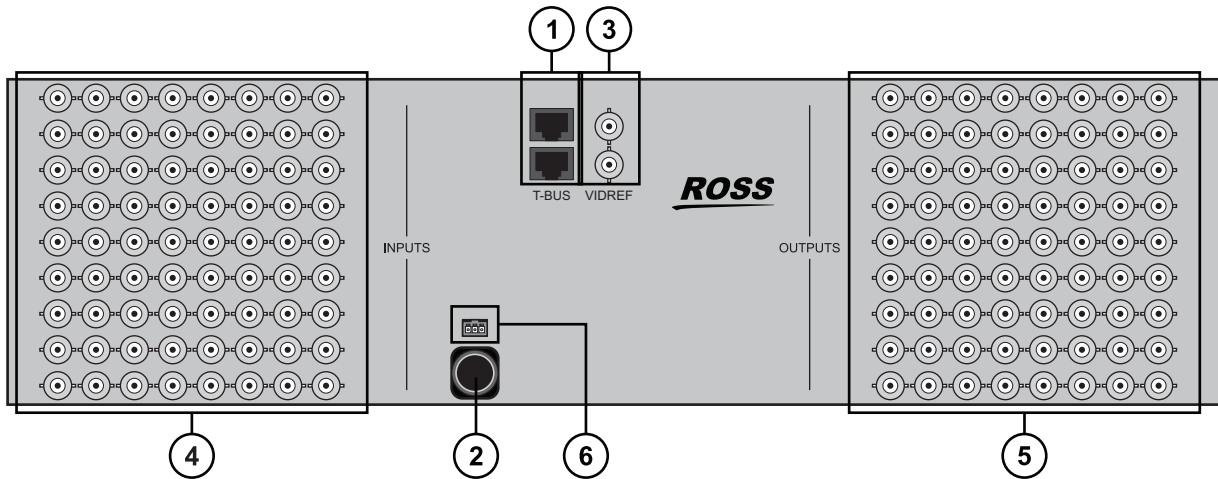

Figure 3.20 NK-D64/75 — 75ohm, 64x64 Rear Panel Example

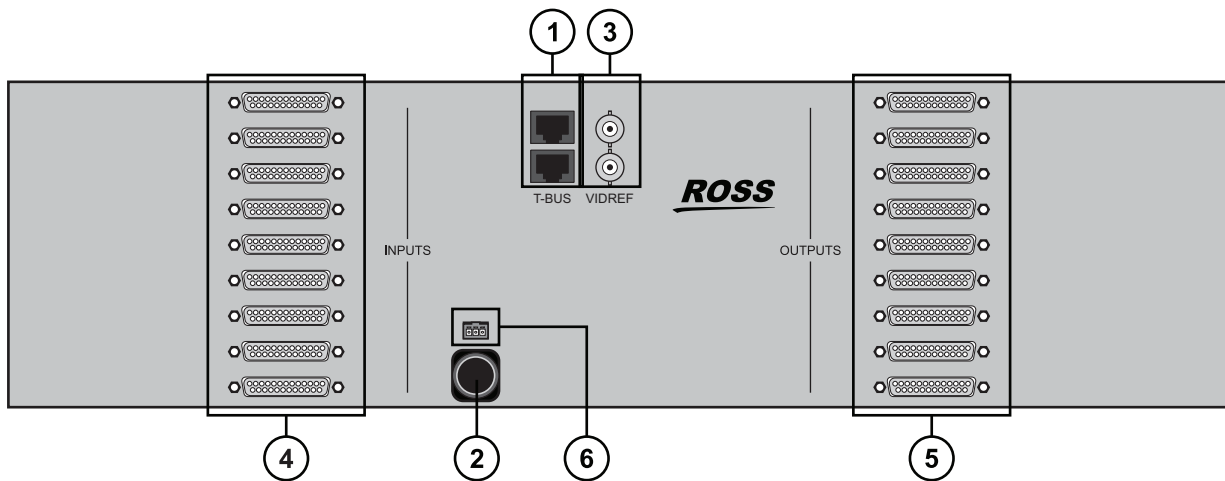

Figure 3.21 NK-D64/110 — 110ohm, 64x64 Rear Panel Example

- | | | |
|---------------------|-------------------------------------|------------------------|
| 1) T-BUS Ports | 3) Video Reference Loop Connections | 5) OUTPUTS Connections |
| 2) POWER Connection | 4) INPUTS Connections | 6) GPI Alarms |

Stereo Analog Audio Level

All Analog Audio level routers have selectable +4/-10dBu input and output levels, via on-board solder links.

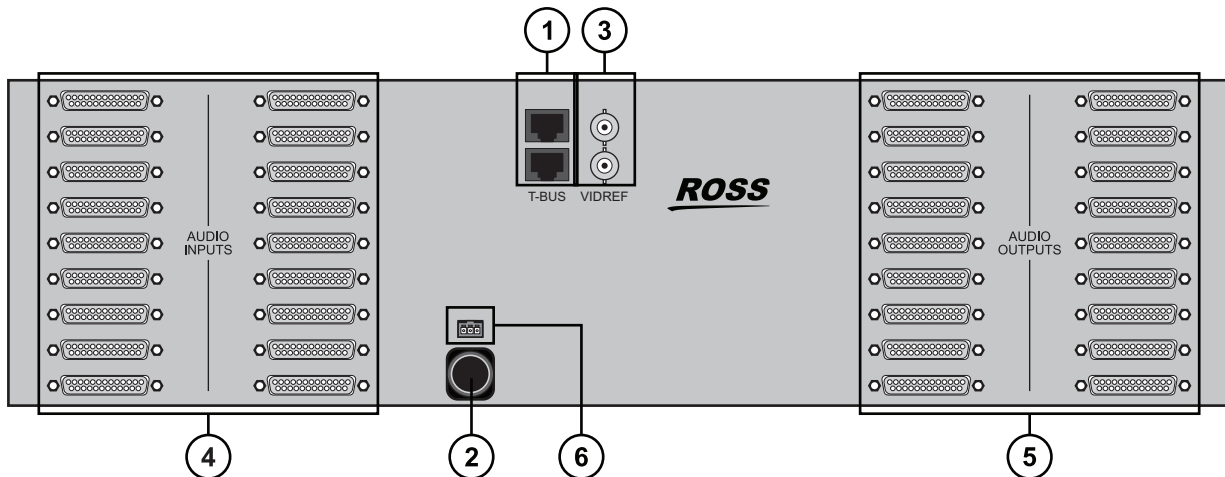

Figure 3.22 NK-A64 — 64x64 Rear Panel Example

- | | | |
|---------------------|-------------------------------------|------------------------------|
| 1) T-BUS Ports | 3) Video Reference Loop Connections | 5) Audio Outputs Connections |
| 2) POWER Connection | 4) Audio Inputs Connections | 6) GPI Alarms |

Control Panel Hardware Overview

The NK Series offers three highly flexible, yet simple and intuitive remote control panels that can be configured to operate as a menu driven source/destination switching, cut-bus or multi-cut-bus panel. Every control panel in the system can be independently configured to meet the needs of the particular operator position at which it is deployed.

Control of the routers can be done using a variety of methods, including:

- RCP-NK1 — a 40 button remote control panel
- RCP-NKM — a 40 Button and LCD display remote control panel
- RCP-NKQ — 17 LCD button remote control panel
- DashBoard Control System for setup and control
- 10/100 Ethernet Interface
- Virtual routing
- Third-party RS-422 serial control
- RS-232 and GPI/Tally interface

RCP-NK1

The RCP-NK1 is a simple and cost-effective control panel that controls NK Series Routers, switches and protects outputs, and also display router status. It has 40 soft, programmable back-lit buttons, arranged in a 32+8 configuration for convenient function layout. The RCP-NK1 is ideally suited as a menu driven source / destination switching control panel for small routers or as a cut-bus or multi-cutbus control panel for any sized router,

Panel layout is designed with 2 rows of 16 buttons on the left-hand side, and 2 rows of 4 keys on the right-hand side for users who wish to keep function keys separated from their source, destination, and breakaway buttons. The LED brightness can be set through the NK-IPS for both on and off states.

Each button can be configured to operate as a source, destination, breakaway, level select or macro function. Additionally protect, take and panel lock functions can be programmed to any button. Using source and destination shift buttons, a single RCP-NK1 can access up to 48 sources or destinations.



Figure 4.1 RCP-NK1 — Front Panel

Connected via the T-Bus Control System, with CAT5 cables, the RCP-NK1 is phantom powered by the router it is connected to. Multiple control panels can be linked together and powered from one router.



Figure 4.2 RCP-NK1 — Rear Panel

Multiple RCP-NK1 panels can be tied together to operate as a single, larger panel. By doing this, the tied RCP-NK1 panels can operate as a larger menu driven source / destination switching panel, or a larger cut bus panel with a single button per source access.

Features

- Full function programmable control panel
- Configurable as cut-bus, multi-cut-bus or menu driven source / destination switching control panel
- Control up to 8 levels, across 16 breakaways
- Removable key-caps for labeling of button functions using transparent inserts
- Can be mounted on the front of any NK-16 router, providing an integrated 1RU routing and control solution
- Phantom-powered via T-Bus

Applications

Figure 4.3 illustrates one RCP-NK1 panel and one NK-A16-HQ router. In this application, the panel acts as the menu driven source/destination switching controller for a router up to 16x16.



Figure 4.3 Workflow Example — One Panel with One Router

Figure 4.4 illustrates two linked RCP-NK1 panels with one NK-D32-75 router. The two linked panels can be used as menu driven source/destination switching control for a router up to 32x32.

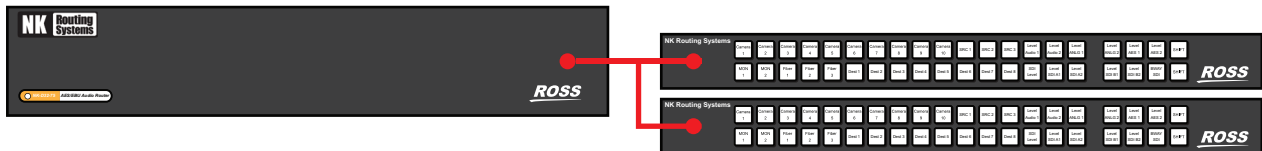

Figure 4.4 Workflow Example — Two Panels with One Router

Figure 4.5 illustrates four RCP-NK1 panels in a system with one NK-3G72 router. The first RCP-NK1 is a satellite panel to control a limited number of sources and destination for any router. The second RCP-NK1 is a macro panel to quickly restored saved configurations or commonly made switches. The two linked panels can be used as a larger cut bus panel.

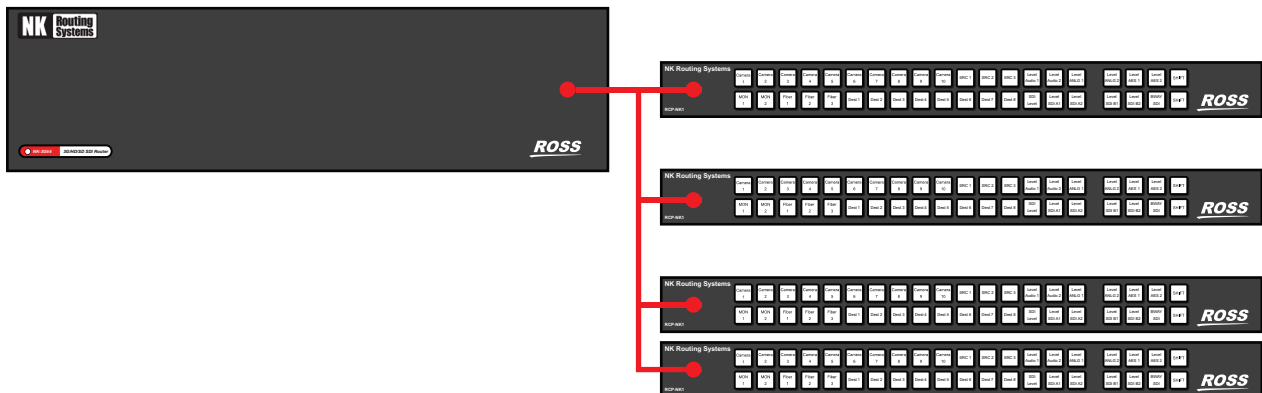

Figure 4.5 Workflow Example — Four Panels and One Router

RCP-NKM

The RCP-NKM panel controls NK Series Routers, has a variety of assignable functions, and it can also be used for virtual routing. It has 40 programmable back-lit buttons, a 16 character by 2 line back-lit LCD screen, and can control up to 32 router levels. Refer to the *RCP-NKM Remote Control Panel User Guide* for more information.



Figure 4.6 RCP-NKM — Front Panel

RCP-NKQ

The RCP-NKQ control panel has a variety of assignable functions and it can also be used for virtual routing. It has 17 programmable back-lit buttons, panel linking with other remote control panels, and can control up to 32 router levels. Refer to the *RCP-NKQ Remote Control Panel User Guide* for more information.



Figure 4.7 RCP-NKQ — Front Panel

Interfaces and Connectivity

This chapter summarizes the interfaces and NK series devices used for communication across a routing system.

Communication Interfaces

The NK Series communicates using the following systems.

T-Bus Control System

NK routers and panels are linked via the T-Bus Control System, a multi-drop RJ-45 control system supporting collision detection and half-duplex communication. The T-Bus Control System minimizes cable connections between devices, acting as both a reliable means to phantom power selected devices and as the communications line.

The T-Bus Control System's collision detection support ensures that if two devices transmit messages at the same time they will not send incorrect data to other devices on the line. All components that utilize the T-Bus Control System are able to monitor communication on the line to ensure that no two devices are transmitting at the same time.

The Heartbeat

NK Series routers indicate their status by a pulsating LED, called a heartbeat. The heartbeat flickers when a switch message is handled by the router. It dims slightly to indicate a handled message that did not result in a switch.

The heartbeat is also connected to the alarm status. It monitors the status of the power supply and signifies a problem by pulsating at a noticeably faster rate.

DashBoard Overview

The DashBoard client software allows configuration and monitoring of some NK Series devices, and provides access to other devices in your routing system. DashBoard communicates with devices in your routing system through the NK-IPS.

DashBoard must be run on a computer that has a physical wired ethernet connection. Wireless connections do not allow device discovery.

For More Information on...

- downloading and installing the DashBoard client software, refer to the *DashBoard User Guide*.

Walkabout Overview

The Walkabout configuration software is used to configure the basic network communication settings for the NK-NET

For More Information on...

- downloading and installing the DashBoard client software, refer to the *DashBoard User Guide*.

NK Series Communication Devices

The following NK Communications devices are available.

NK-VRC

The NK Virtual Routing Core (NK-VRC) provides virtual routing for complex NK Series routing switcher systems.

The NK-VRC, accessible using the DashBoard Control System via the NK-IPS, enables users to map inputs and outputs from routing switchers through to the NK-VRC for control via any remote control panel. These parameters can be saved in a configuration document and sent to an NK-VRC at any time using DashBoard. Therefore, if an NK-VRC is used in a number of different operating scenarios, the configuration can be changed easily and quickly.

Refer to the *NK-VRC Virtual Routing Core User Guide* for all configuration and functionality details for the NK-VRC.

NK-IPS

The NK-IPS (Internet Protocol Server) is the device used for configuration of NK Series devices including routers, control panels and control interface devices. Connection of the NK-IPS to either a single computer or a network allows configuration of the NK routers and panels using DashBoard or a web browser, further enhancing the capability of any installation of NK Series products by providing access to the entire range of functions. The NK-IPS also enables users to configure T-Bus enabled Ross Video devices.

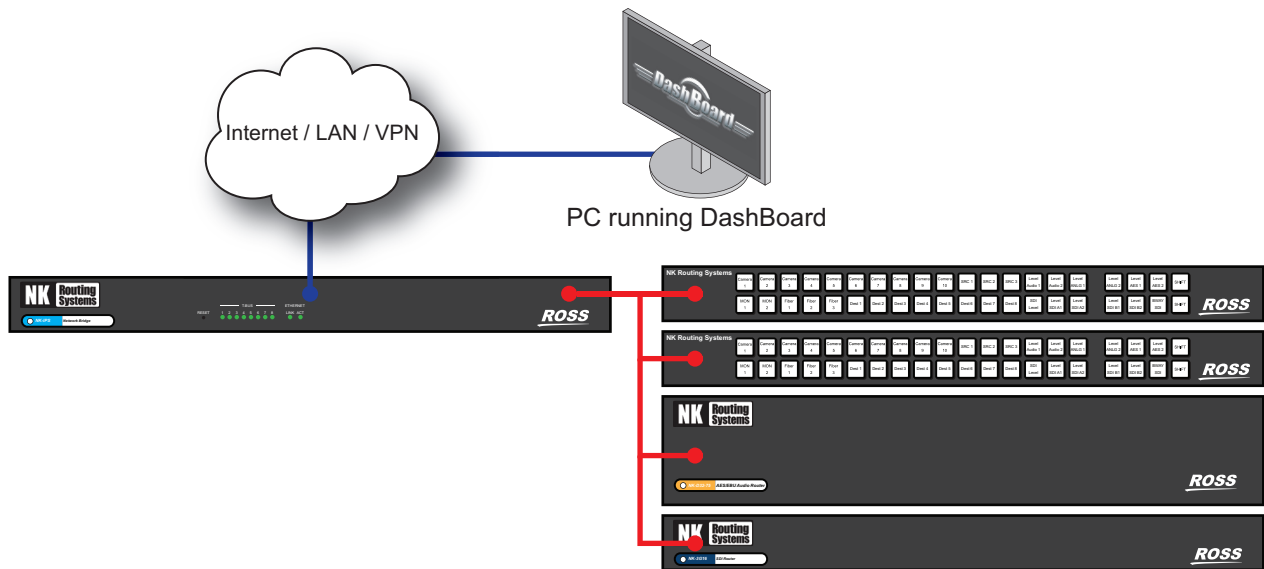

Figure 5.1 Example of the NK-IPS Connection

The NK-IPS is also required for use of the NK Hub, for information and usage of this software component, refer to the *NK-IPS Internet Protocol Server User Guide*.

The NK-IPS does not require Internet access for operation, only DashBoard or an Internet browser is required for operation and configuration. For further information, refer to the *NK-IPS Internet Protocol Server User Guide*.

NK-HUB

The NK-HUB, accessible only through the NK-IPS, is a software component used to connect two or more NK-IPS devices, enabling NK Series protocol and switch communication between NK Series components connected to each NK-IPS. Internet Protocol Servers can be locally or remotely connected allowing NK Series components to respond to status requests, switch requests and protect requests.

A local connection enables two NK-IPS devices within the same network to communicate with NK Series components connected to each. A remote connection, via an Internet connection or Virtual Private Network (VPN), allows two or more Internet Protocol Servers to communicate over longer distances.

The NK-HUB is built with Java® technology, enabling flexibility and cross-platform control. Users are advised to have installed the latest version of the Java Runtime Environment (JRE) before using the NK Hub. For further information on the NK-HUB and the Java Runtime Environment, refer to the *NK-IPS Internet Protocol Server User Guide*.

Note that as NK-HUB connection and usage requires the NK-IPS, all configuration and functionality details are outlined in the *NK-IPS Internet Protocol Server User Guide*.

NK-3RD

The NK-3RD Third-Party Interface enables a third-party control system to control an NK Series routing switcher system using the SW-P-08 protocol. The NK-3RD works with any NK Series router and supports crosspoint switch commands and crosspoint status requests. Up to 1024 inputs and 1024 outputs can be controlled and it supports up to 16 levels.

Refer to the *NK-3RD Third-Party Control Interface User Guide* for more information.

NK-SCP Series

The NK-SCP Serial Control Port allows an NK Series routers to be controlled via the Kondor 2 or an external RS-232 device. It is available in RS-232 (NK-SCP/A) and RS-485 (NK-SCP/K2) models. Configuration of either the NK-SCP/A or the NK-SCP/K2, as well as router configuration and partitioning, requires the NK-IPS.

NK-SCP/A – RS-232 Control

The NK-SCP/A model allows an RS-232 device, such as an automation system or computer terminal, to control NK routers using the Ross Video EOS ASCII protocol. Any combination of NK routers can be controlled with a maximum size of 255 inputs and 255 outputs with up to 8 levels. The bidirectional protocol incorporates both crosspoint status monitoring and crosspoint switching. Crosspoint switching can be performed using individual levels or through user-defined breakaway mapping.

NK-SCP/K2 – RS-485 Control

The NK-SCP/K2 allows Kondor 2 routers to be extended by utilizing NK routers as additional levels. Any combination of NK routers can be added to a Kondor 2 system with a maximum size of 255 inputs and 255 outputs with up to 8 levels. Kondor 2 router inputs, outputs and levels are directly mapped to NK Series router inputs, outputs and levels, requiring no user mapping.

NK-GPI

The NK-GPI is a universal GPI interface for the NK family of routers. Providing both GPI inputs and outputs, the NK-GPI allows flexible GPI control, configured from the NK-IPS Device Properties pages. The NK-GPI also supports both GPI input return and latch modes.

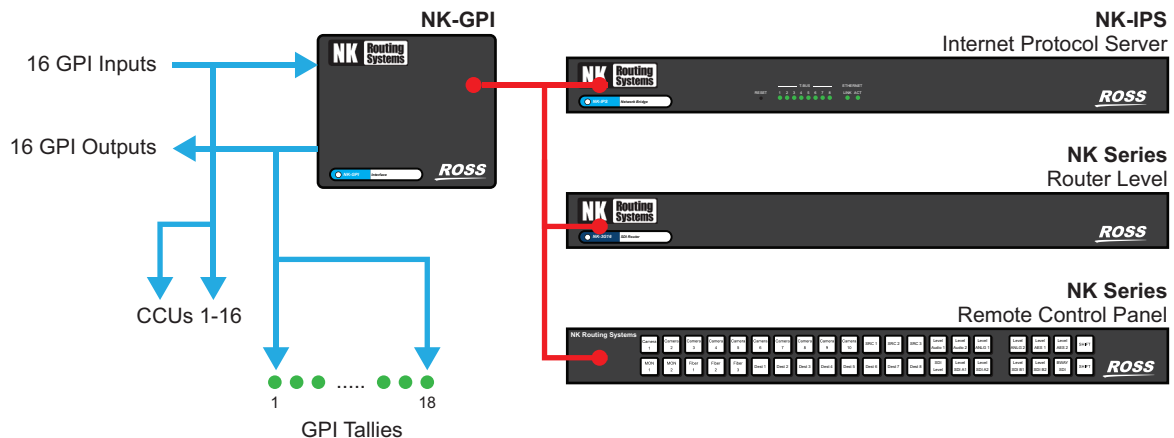

Figure 5.2 Example of the NK-GPI Connection

NK-GPI configuration, via the NK-IPS and a PC connected to a network, allows users to customize GPI inputs and outputs, as well as the input mode (Latch or Return), and a Panel Link Address, configuring the NK-GPI to be controlled from a connected NK Control Panel.

Physical Installation

If you have questions pertaining to the installation of NK Series, contact us at the numbers listed in the section “**Contacting Technical Support**”. Our technical staff is always available for consultation, training, or service.

Before You Begin

These installation guidelines assume the following:

- The relevant Ross equipment is installed into a ventilated rack frame. The relative humidity in the environment of the equipment should be <70% (non-condensing). The ambient temperature of the air entering the front panel should not exceed 30°C (86°F), and should not fall below 0°C (32°F). It is recommended to leave a 1RU gap between each module.
- Ensure that adequate space exists in front and behind the NK Series chassis and on both sides of the chassis for airflow.
- The install location of the router should be accessible, dry, and dust-free.
- The power socket/outlet shall be installed near the equipment and shall be easily accessible.
- The routing system is well planned and designed. Consideration must be given to inputs and outputs across multiple router levels and typical operating scenarios for breakaways.
- A valid IP address is reserved for each device in the routing system.
- A computer for the DashBoard client software is available on the same network as your routing system.

Static Discharge

Throughout this chapter, please heed the following cautionary note:



ESD Susceptibility — *Static discharge can cause serious damage to sensitive semiconductor devices. Avoid handling circuit boards in high static environments such as carpeted areas and when synthetic fiber clothing is worn. Always exercise proper grounding precautions when working on circuit boards and related equipment.*

Unpacking and Pre-installation

After unpacking NK components, inspect all NK Series components for any signs of damage that may have occurred during transportation. In the event of such damage, notify a Ross Video representative immediately.

NK Series components should be installed in an adequately ventilated rack frame, ideally in an appropriate environment for audio visual equipment. Relative humidity should be no more than 70% (non-condensing) and temperatures should not exceed 30°C or 86°F.

If the above conditions are not attainable for operation, it is advised that NK Series routers be installed with 1RU space between them before use.

Connecting NK Components Overview

NK Series components are connected via the T-Bus multi-drop control system by a single CAT5 Ethernet cable.

Linking the Components

Routers are supplied with their own power supply, the NK1 panels are phantom powered by the routers they are connected to via the CAT5 cable. Each control panel has two RJ-45 ports for phantom power and communications. When connecting devices, either port may be used to connect panels or routers to each other.

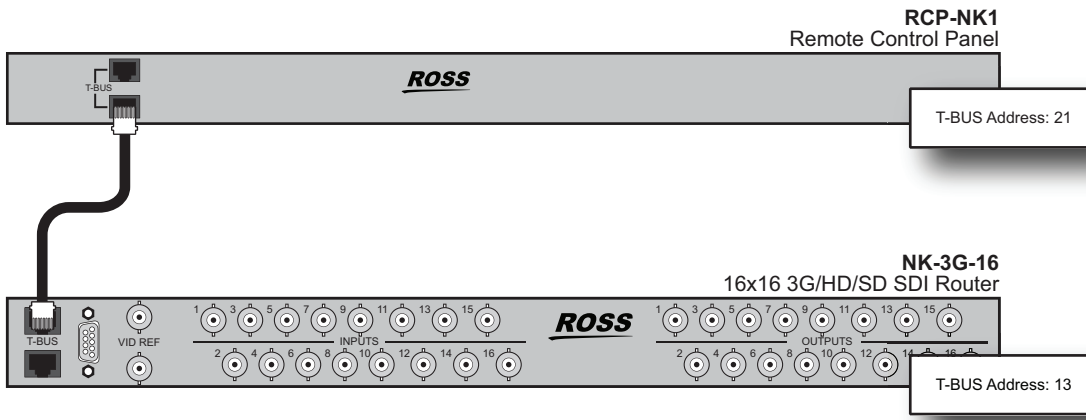

Figure 6.1 Single Panel Connection Example

Panels can be linked together to expand the number of available buttons. Panels are linked if they have the same address and a different device link address that is not 0 (zero). Linked panels behave exactly as if they were one larger panel except that macros can not be appended or added across panels.

★ The NK-IPS is required to configure linked panels and also for changing individual component addresses.

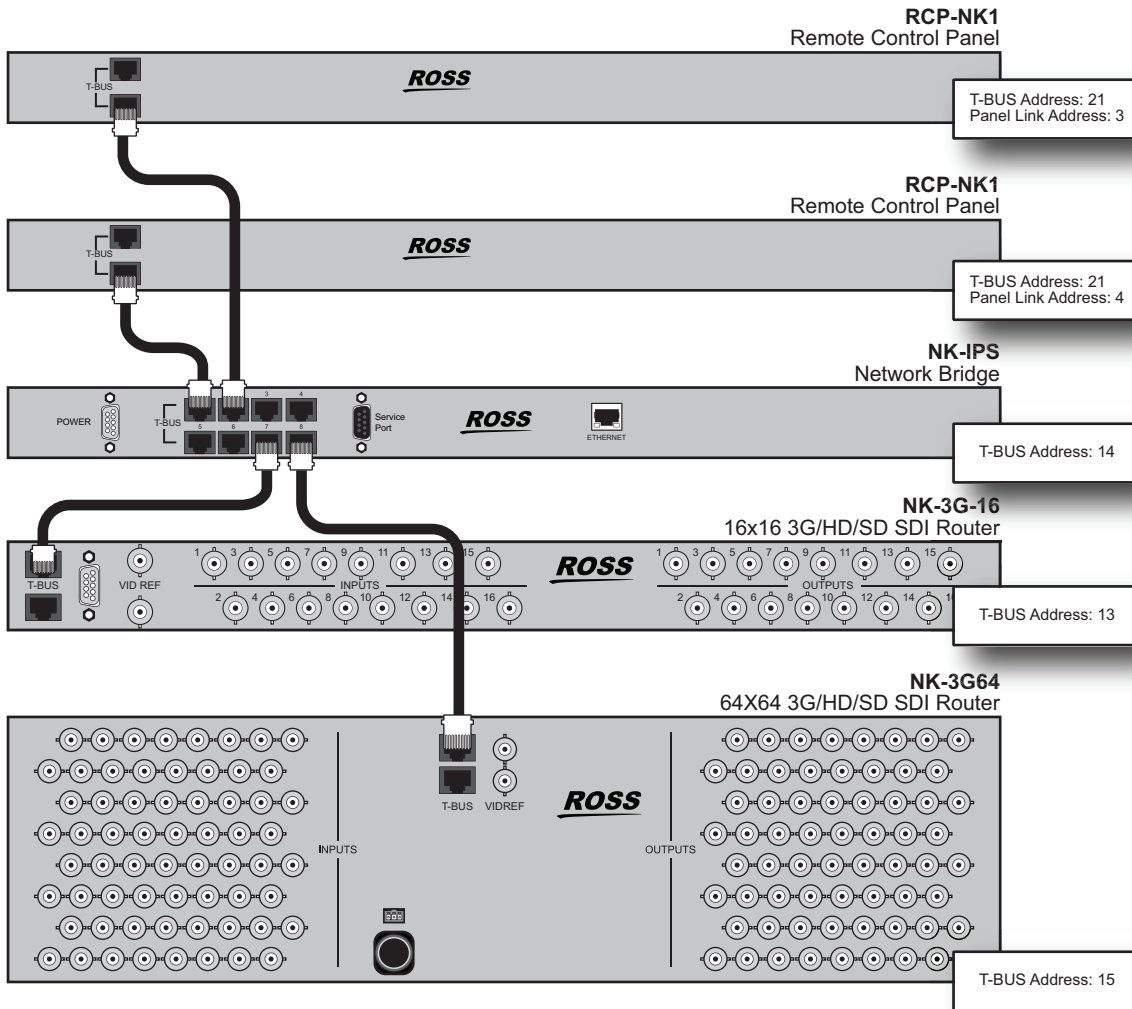

Figure 6.2 Linked Panel Connection Example

Power

A maximum of four RCP-NK1 control panels may be connected (daisy-chain) to an individual router at any one time; and a maximum of seven RCP-NK1 control panels to one NK-IPS. Adding other power sources to the same system will contribute further power to the T-Bus connection if required.

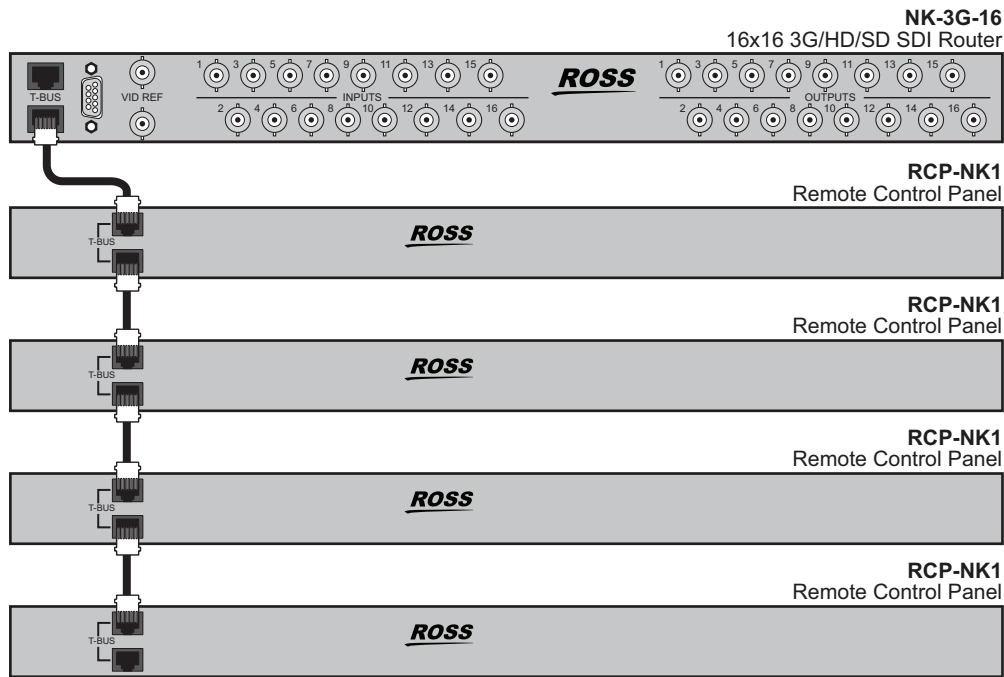

Figure 6.3 Daisy-Chain Connection Example

Power may also be distributed evenly throughout an NK system by way of direct connections between phantom powered connections (control panels, NK-SCP and NK-GPI) from a common power source (NK Series routers or the NK-IPS), or by daisy chaining components. Daisy chaining components allows several phantom powered components to be connected to the one router.

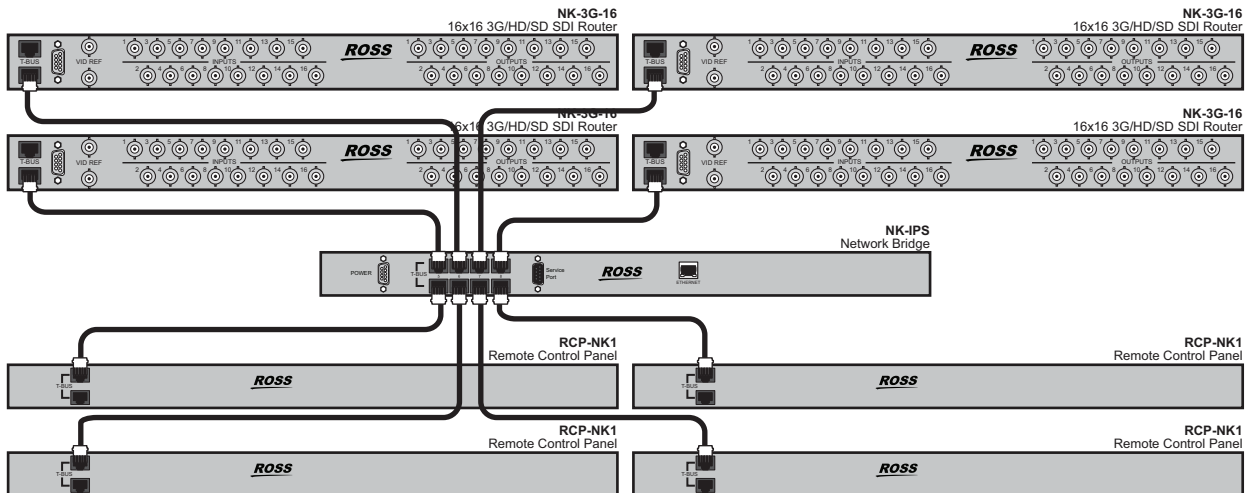

Figure 6.4 T-Bus Distributed Power Example

Each NK router, control panel and control device comes standard with a single external AC/DC power supply. The exceptions to this are devices that are powered from the T-Bus, such as the RCP-NK1, NK-SCP/A and NK-GPI.

- ★ Redundant external power supplies are available. Contact Ross Video for details. Optionally, a 100W rack mount redundant power supply, is available to power up to 4 devices. Refer to the *NK-RP1/P User Guide* for additional information.

Video Referencing

All NK Video and Audio routers are fitted with a video switching reference input to ensure that switching occurs in the vertical interval across all levels. Normally, the reference input signal is a color black (Black burst) composite signal, however it may be any normal composite signal. The NK router will automatically detect the signal as being either 625/50 (PAL) or 525/60 (NTSC) and automatically adjust the switching pulse to comply with RP 168, line 6 for PAL and line 10 for NTSC.

The NK router switches on frame boundaries. There are two 75ohm BNC reference input BNCs on each NK router arranged as a passive loop-through pair. Normally, a single Black Burst signal is looped through each of the routers which are located together and a 75ohm terminator is connected to the last BNC socket. An individual Black Burst signal should be wired to routers which are more than a few meters apart.

If the reference signal is absent, the NK router will generate a free-running switching pulse over 40ms. The status of the switching reference may be monitored on the router's Device Properties page via the NK-IPS, one of three conditions may be reported via the NK-IPS: Local, PAL reference present or NTSC reference present.

★ When using a video reference with any of the NK router components, users must remember to terminate the last video reference that is not looped with a 75ohm BNC terminator.

When only video referencing one router, the other BNC connector of the video reference loop needs to be terminated, as in **Figure 6.5**.

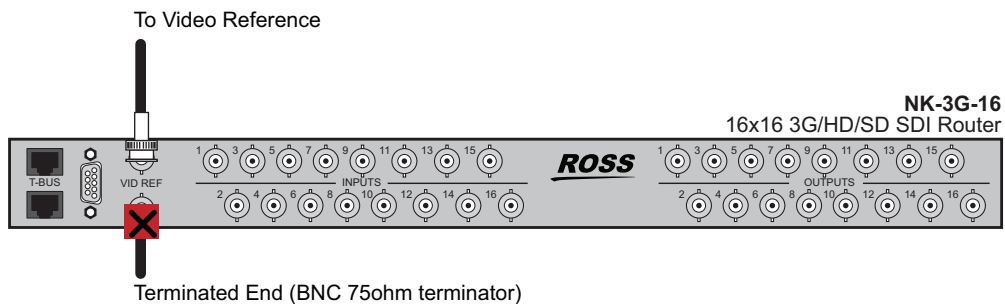

Figure 6.5 Referencing a Single Router

When referencing a more than one router, the last reference connector needs to be terminated, as in **Figure 6.6**.

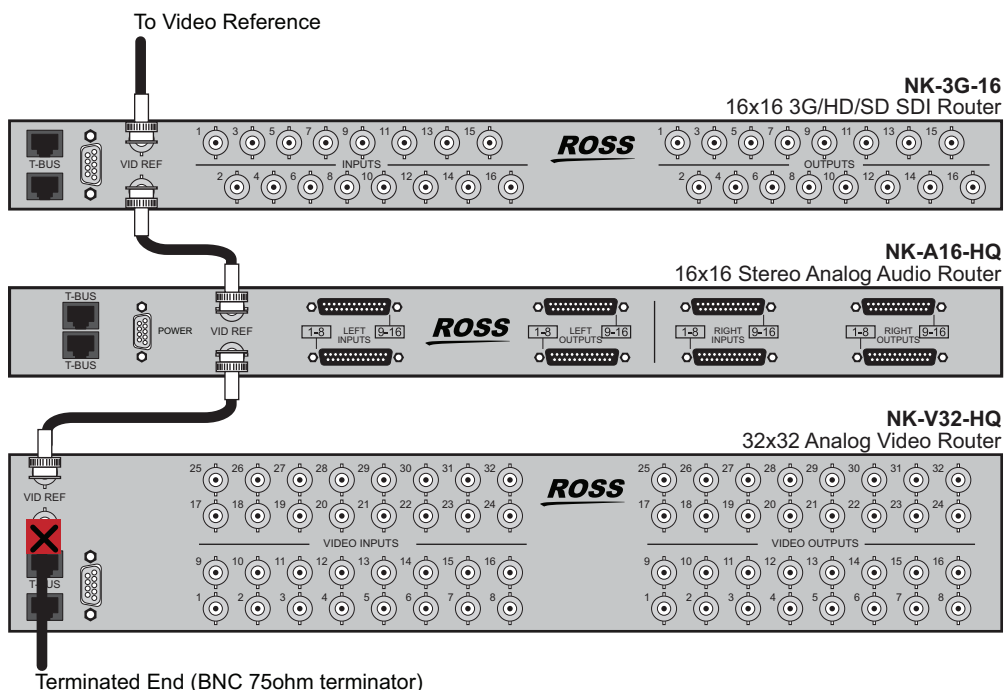

Figure 6.6 Referencing Multiple Routers

Connecting the NK-SCP/A

The NK-SCP/A is connected to a computer or RS-232 device with a straight through RS-232 cable.

The NK-SCP is phantom powered by the T-Bus, allowing the heartbeat to show communication activity when messages and switches are operated from the RS-232 device.

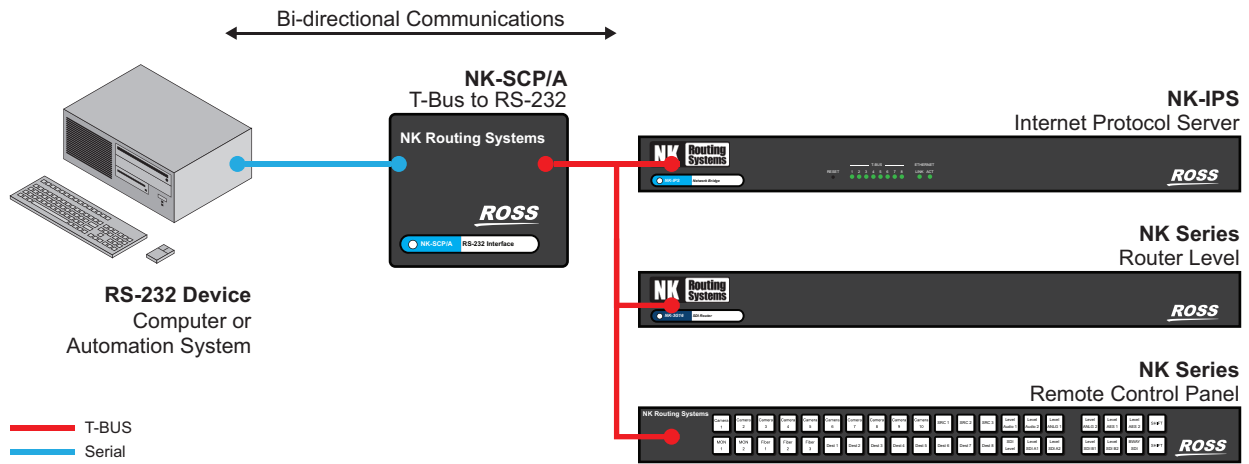

Figure 6.7 NK-SCP/A Connection Example

Connecting the NK-SCP/K2

The NK-SCP/K2 is connected to the Geneos CPU with the parallel to serial converter cable supplied (Part number 9801 2001). If the NK-SCP/K2 and NK routers have been purchased as an addition to a preexisting Kondor 2 and Geneos CPU system, this cable would have been supplied with the initial Kondor 2 / Geneos shipment.

The NK-SCP is phantom powered by the T-Bus, allowing the heartbeat to show communication activity when messages are sent from the Geneos CPU.

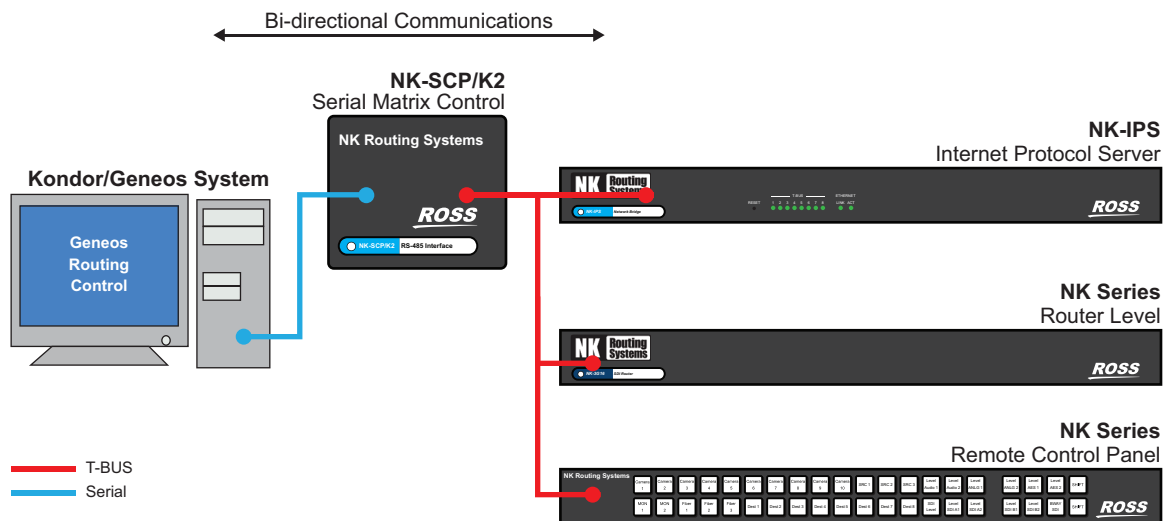

Figure 6.8 NK-SCP/K2 Connection Example

Parallel to Serial Converter

The Parallel to Serial converter is housed inside the DB-37 connector shell which plugs into the Parallel Output Control connector located at the bottom left side at the rear of the Geneos CPU frame. Power to the converter is supplied via the DB-25 connector (wired to the DB-37). The DB-25 connector plugs into the AUX connector located at the bottom left side at the rear of CPU frame. The Serial output from the converter is available from the

DB-9 plug (wired to the DB-37), this DB-9 plugs into the top RS-485 DB-9 on the Rear left of the Kondor 2 frame. The PC communications cable is wired to the DB-25, the PC end has both a DB-25 and a DB-9 for connection to an RS-232 communications connector on a PC running Geneos.

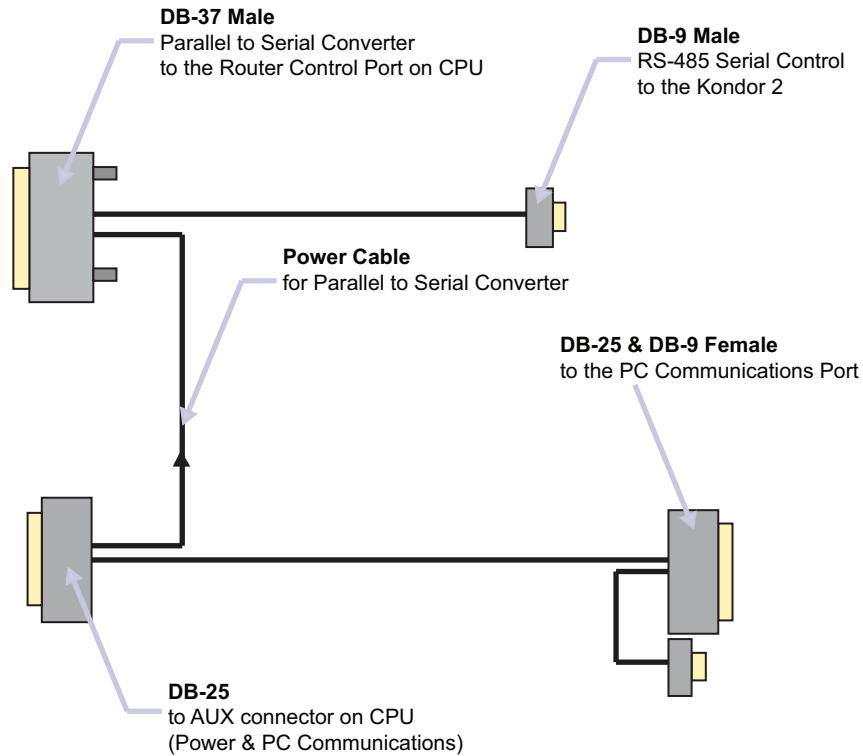

Figure 6.9 Parallel to Serial Converter Example

To connect the NK-SCP/K2 to the Geneos CPU

1. Connect the DB-37 connector of the Parallel to Serial Converter to the Router Control Port on the rear of the Geneos CPU.
2. Connect to DB-25 connector of the Parallel to Serial Converter to the Auxiliary Port on the rear of the Geneos CPU.
3. Connect the single DB-9 connector of the Parallel to Serial Converter to the DB-9 connector of the NK-SCP/K2. Alternatively, this connector can be connected to the Kondor 2 frame itself, and the NK-SCP/K2 connected to the frame via a serial cable.
4. Connect either the linked DB-25 or the DB-9 to a PC for Geneos software configuration and control.

★ The NK-SCP/K2 can be connected to the Geneos CPU at any time, but to ensure status updates are completed, it is recommended that it be connected after configuration details have been entered on both the Device Properties page via the NK-IPS, and the Geneos Software.

To connect the NK-SCP/K2 or NK-SCP/A to the T-Bus Control System

1. Connect one end of a straight through CAT5 cable to the RJ-45 connector on the SCP.
2. Connect the other end of the CAT5 cable to any available T-Bus port on the NK-IPS, or any other T-Bus compatible device connected to the NK-IPS.

Connecting the NK-GPI

The NK-GPI connects to the T-Bus control system using the RJ-45 connectors on the box edge. The loop through connector allows the NK-GPI to reside at any point on the control bus. The NK-GPI connects to general purpose interface inputs and outputs via a DB-37 port.

Pinouts

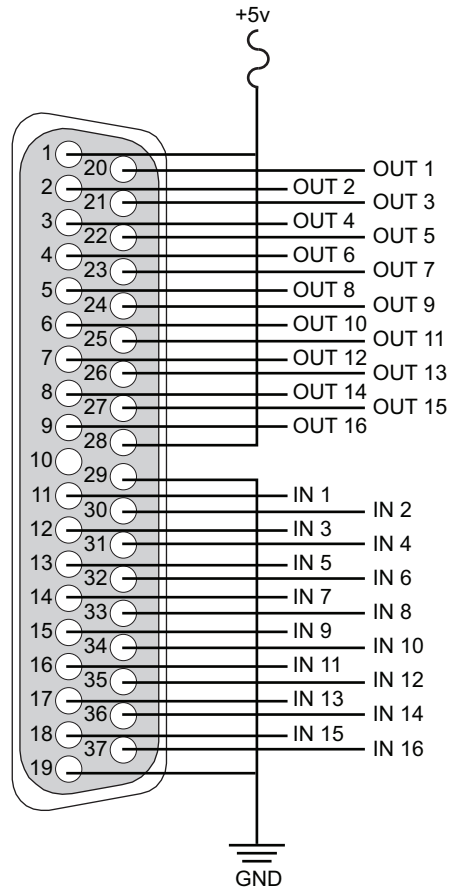

Figure 6.10 NK-GPI Pinouts

Connecting GPI Inputs

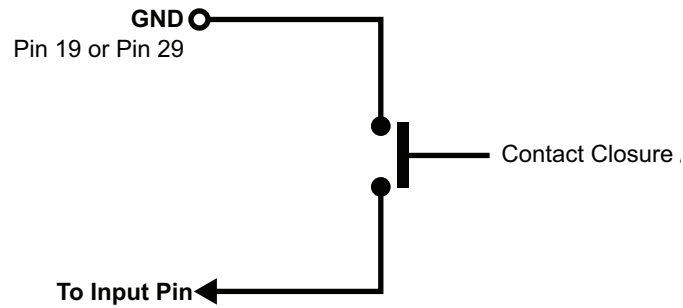

Figure 6.11 GPI Input Connection

Connecting GPI Outputs

Figure 6.12 uses a LED to indicate status. The LED can be replaced with another indicator, load or a GPI input from another device.



Caution — When connecting GPI outputs to the NK-GPI, users must remember there is a 10mA current limit on each output, and a resistor must be connected to the GPI output to maintain peak operation. **Figure 6.12** depicts how to wire outputs correctly.

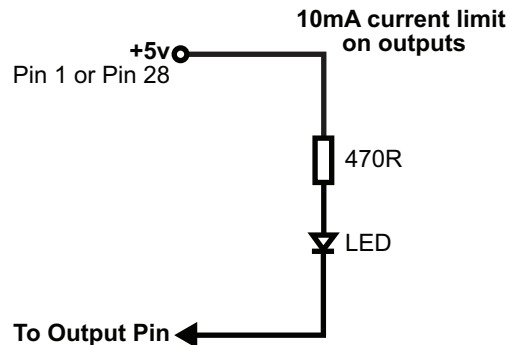

Figure 6.12 GPI Output Connection

Customizing RCP-NK1 Control Panels

One of the flexible features of the NK Series of routers and panels is the ability to install RCP-NK1 control panels either locally or remotely to NK-16 routers. Localizing panels ensures that rack space is maximized and cable connections are minimized. Remotely installing panels means that panels do not necessarily have to be installed in the immediate vicinity of the routers, and can be connected and installed in other rooms if required.

Localizing the Panel

If users are localizing control panels, a short (between 12.5cm and 20cm or 5” and 8”) standard (not crossover) CAT5 cable is required to connect the panel to the router internally.

- ★ Ensure that the router and the panel you wish to localize are not connected to any other devices before proceeding. Also ensure that both the router and the control panel are disconnected from the power source.

To fit the control panel locally to the front of the router

1. Remove the front button panel from the case it was originally shipped in.

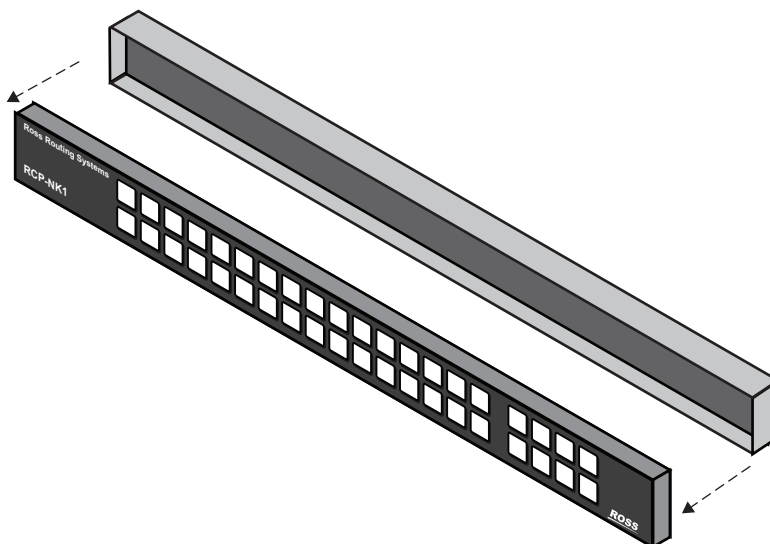

Figure 6.13 Removing the RCP-NK1 from the Shipping Case

2. Remove the front panel of the router.

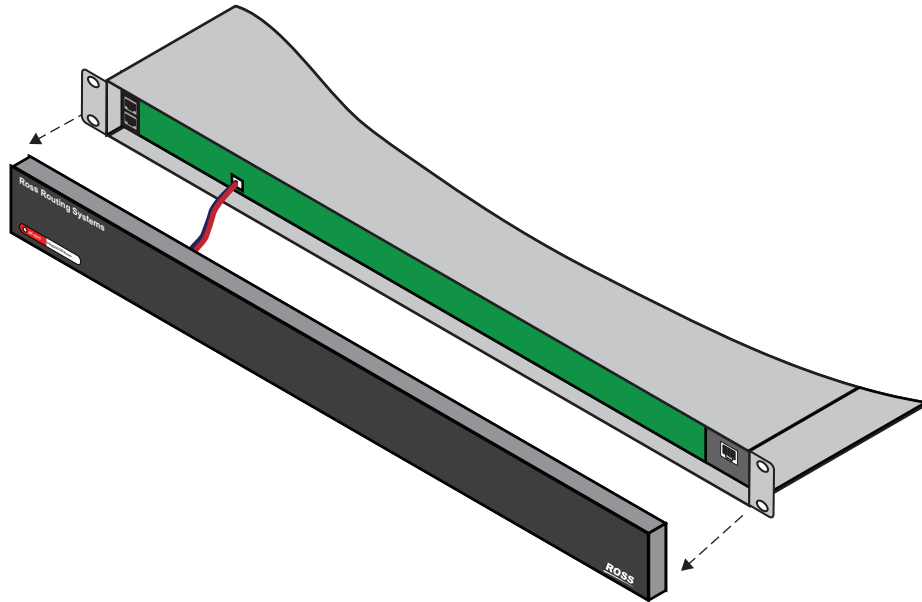

Figure 6.14 Removing the Front Panel from the Router

3. Disconnect the wire that connects the heartbeat to the circuit board.

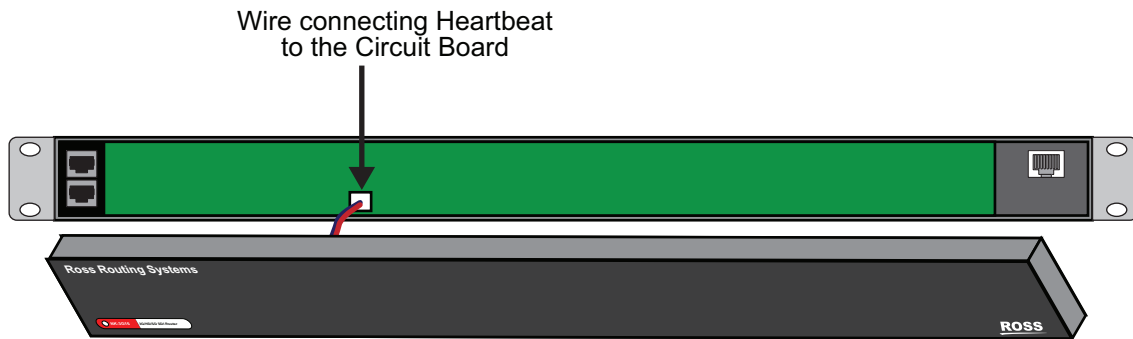

Figure 6.15 Disconnecting the Heartbeat

4. Set the router front panel aside.
5. Connect one end of the CAT5 cable to either of the control panel's RJ-45 ports.
6. Connect the other end of the CAT5 cable to the internal RJ-45 of the router.

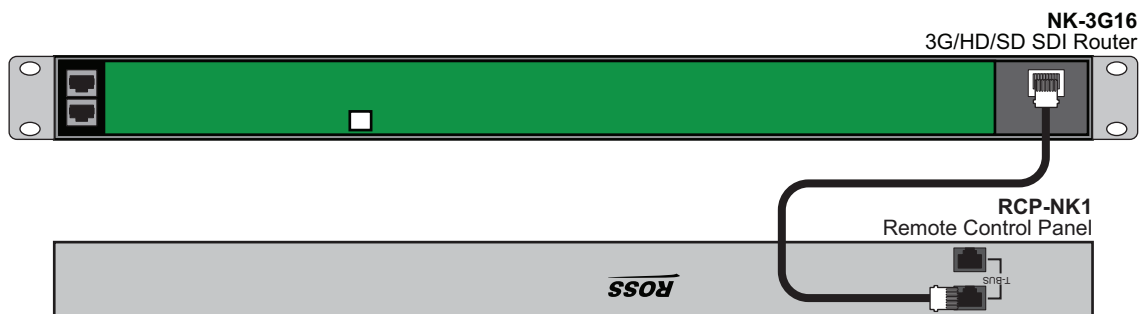

Figure 6.16 Connecting the CAT5 Cable to an RJ-45 Port

7. Ensure the excess cable is packed in the empty space of the casing before attaching the panel face.
8. Slowly clip the button panel into the router casing, on both the left and the right sides.

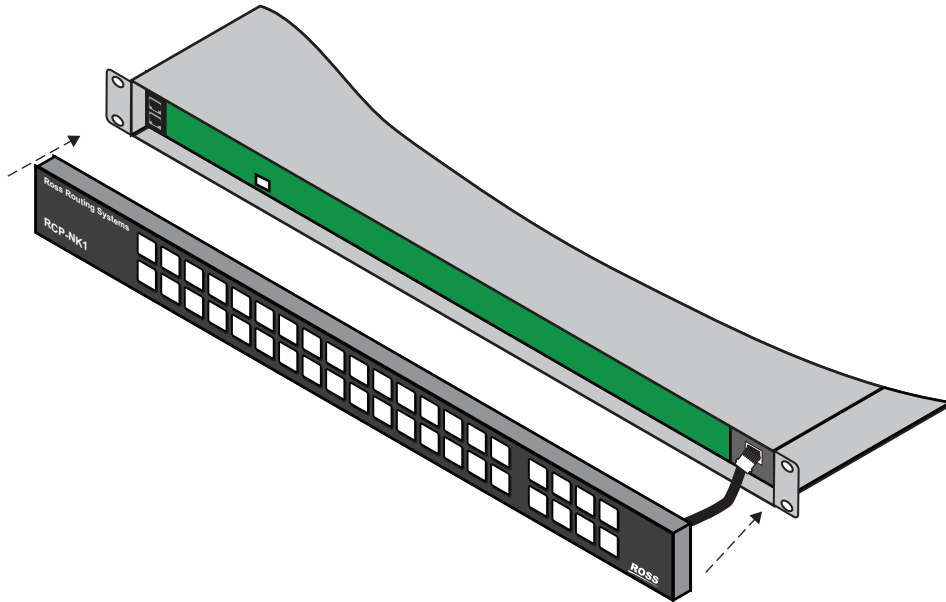

Figure 6.17 Re-installing the Front Panel

9. When the face is firmly in place on the router casing, it can be installed as any normal router, saving rack space.

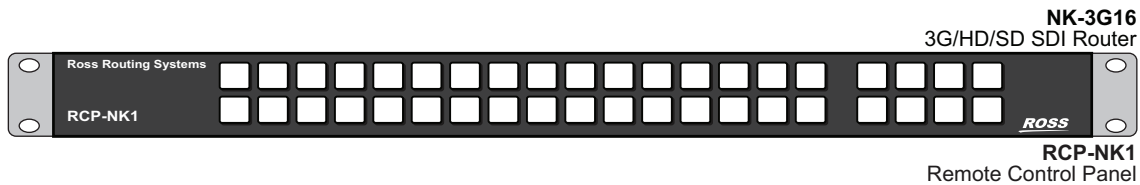

Figure 6.18 RCP-NK1 installed as the Front Panel

Customizing the RCP-NK1 Button Labels

The button labels of the RCP-NK1 may be customized to suit the needs of any application. Button labels may be customized in any word processing, spreadsheet or design software providing that the label size is set to exactly 9.5 x 9.5 mm (3/8" x 3/8").

- ★ It is recommended that labels be printed on overhead transparency rather than paper so that LED illumination is not obscured.

Default Configurations

When NK Series components are shipped, the default configuration is set to allow both NK routers and control panels to be used straight out of the box.

RCP-NK1 Control Panel Default Key Assignment

The RCP-NK1 control panel is factory configured with the key assignments as depicted in **Figure 7.1**.

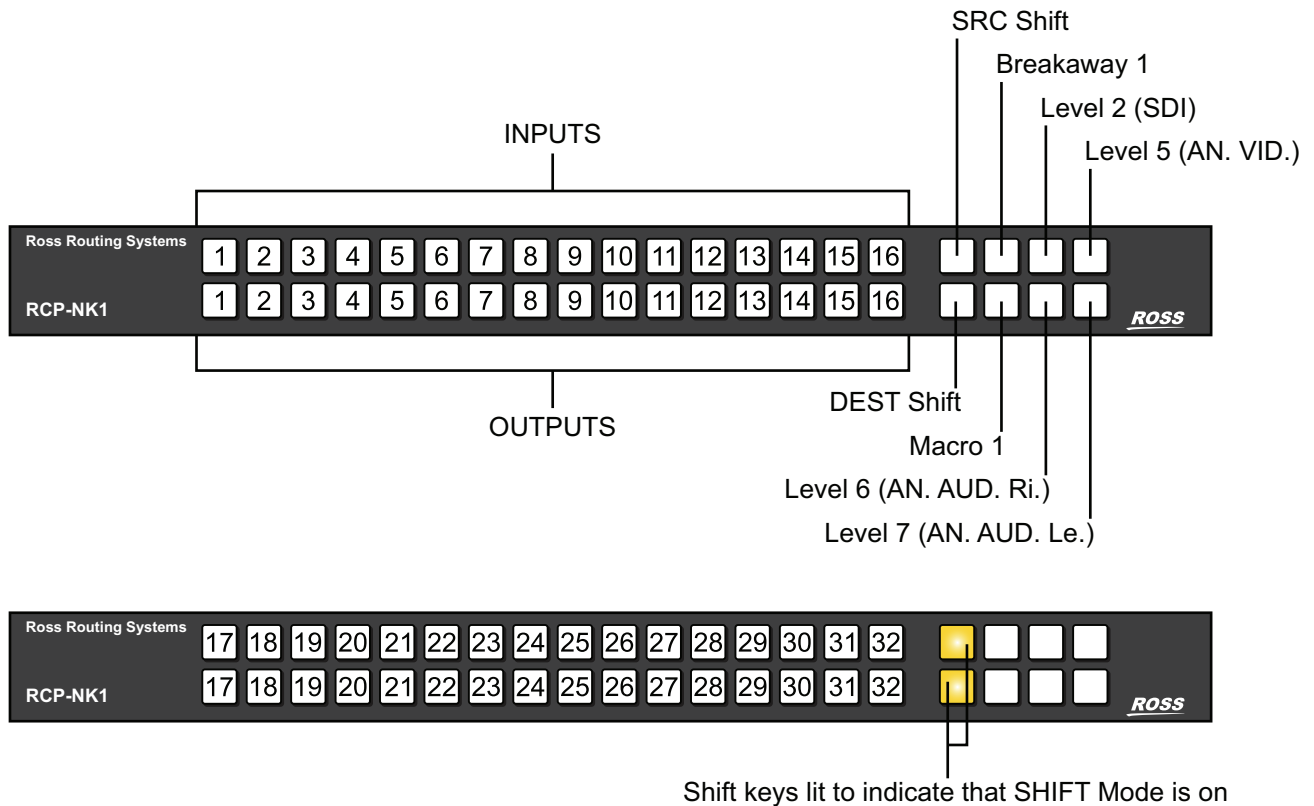

Figure 7.1 RCP-NK1 Control Panel Default Configuration

Further configuration and key panel settings, as well as router configuration, can be accessed using the NK-IPS and Phoenix or a web browser.

When purchasing a complete NK system, the RCP-NK1 will be custom programmed so that it can be used straight out of the box without further configuration via the NK-IPS. Further documentation depicting key panel layout will be provided with systems that do not adhere to the factory default.

The key functions listed in **Table 7.1** are assigned to buttons in the factory default configuration of the RCP-NK1.

Table 7.1 Default Key Functions

Key Name	Description
DESTINATION	Changes the destination the panel is controlling. The bottom, left hand row of 16 keys selects destinations 1-16 on the default page/set. When the DESTINATION SHIFT key has been pressed, the second page of destinations (17-32) is accessible.
SOURCE	Switches using the current destination and level pattern. The top left hand row of 16 keys selects the sources 1-16 on the default page/set. When the SOURCE SHIFT key has been pressed, the second page of sources (17-32) is accessible.
DESTINATION SHIFT	Changes the destination page of the panel
SOURCE SHIFT	Changes the source page of the panel
LEVEL	Toggles the specified level number from the current level pattern. Four Level keys are available on the factory default configuration: Level 2 - SDI Video Level 5 - Analog Video Level 6 - Analog Audio (Left channel) Level 7 - Analog Audio (Right channel)
MACRO	Records key press events that can be replayed later.
BREAKAWAY	Selects a pre-configured breakaway level pattern.

Keys that are not available on the factory default configuration of the RCP-NK1, but may be assigned and configured via the NK-IPS, are listed in **Table 7.2**.

Table 7.2 Assignable Key Functions

Key Name	Description
CROSSPOINT	Switches the input, output and level/breakaway associated with this key.
BREAKAWAY STEP	Steps through breakaways.
PROTECT	Protects the currently selected output/level pair. The PROTECT key also activates the panel lock function.
TAKE	Confirms input key events. After a switch is set up, press the TAKE key to activates the switch.
CHOP	Alternates between the last two selected inputs.
DEASSIGN	Allows users to reset a destination assignment.
MACHINE CONTROL KEY	Toggles on/off RS-422 Machine Control reciprocal switching.
PANEL LOCK	Activates the panel lock function, for environments where a PROTECT KEY is not required.
UNASSIGNED	Key is not assigned any function or value.

NK Series Router Levels Default

The factory default configuration breakaway and levels for the NK routers is as depicted in **Table 7.3**.

Table 7.3 Configuration Breakaway and Levels for the NK Routers

	3G/HD/SD Video	SD Video	AES/EBU Audio (1)	AES/EBU Audio (2)	Analog Video	Analog Audio (Left)	Analog Audio (Right)	Machine Control
Default	✓	✓	✓	✓	✓	✓	✓	✓
Level 1	✓							
Level 2		✓						
Level 3			✓					
Level 4				✓				
Level 5					✓			
Level 6						✓		
Level 7							✓	
Level 8								✓

RCP-NKM/Q Control Panel Default Key Assignments

The RCP-NKM and RCP-NKQ default configuration is viewed by opening the editor for the device in the Phoenix Control Surface.

For More Information on...

- RCP-NKM default configuration, refer to the *RCP-NKM Remote Control Panel User Guide*.
- the RCP-NKQ default configuration, refer to the *RCP-NKQ Remote Control Panel User Guide*.

RCP-NKM Defaults

By default, the 20 keys in the top row on the RCP-NKM are assigned as sources and the 20 keys in the bottom row are assigned as destinations. (**Figure 7.2**)

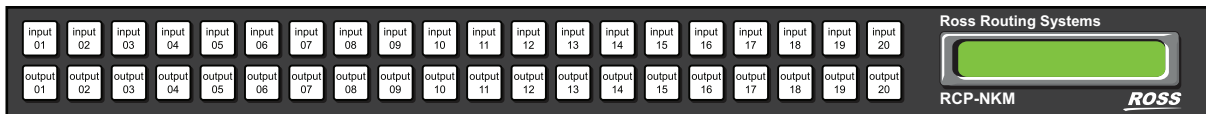

Figure 7.2 RCP-NKM Control Panel Default Configuration

RCP-NKQ Defaults

By default, the RCP-NKQ has the key assignments seen in **Figure 7.3**.



Figure 7.3 RCP-NKQ Control Panel Default Configuration

Breakaways Default

The default breakaway is tied, that is, the first eight router levels are switched together when requested from the RCP-NKM or RCP-NKQ.

Router Levels Default

The RCP-NKM and RCP-NKQ send switch requests to the routing switcher. Each routing switcher is assigned a level, or number of levels if it has been partitioned.

Table 7.4 RCP-NKM/Q Default Router Levels

Router Level	Name
1	Multi-definition video
2	Serial digital interface video
3	AES/EBU digital audio 1
4	AES/EBU digital audio 2
5	Analog video
6	Analog audio (left)
7	Analog audio (right)
8	Machine control

Configuring a Panel

The RCP-NK1 40 button panel controls NK Series routers, displaying router status, switching and protecting crosspoints. It has 40 soft, programmable back-lit keys, with 8 being physically separate for convenient function key layout. The LED brightness can be set through the NK-IPS for both on and off brightness.

Each panel is capable of controlling the whole address space for the NK system (1-65535 inputs and outputs on 32 levels). Panels operate in XY mode by default, but can easily be configured to work in dual cutbus mode using the NK-IPS.

The Device Properties page, accessible through the NK-IPS, allows users to configure interface and key assignments for RCP-NK1 control panels, as well as having the unique ability to assign names and brief descriptions for the devices themselves.

For More Information on...

- how to query devices, and use of the NK-IPS, refer to the *NK-IPS Internet Protocol Server User Guide*.

Configuring Breakaways

Users can customize their breakaways to include any levels desired. Levels can be utilized in as many breakaways as is needed.

Checking the boxes representing levels 1-8 next to the breakaways (1-16) will include that level in that breakaway, when the BREAKAWAY or BREAKAWAY STEP keys are pressed.

Different breakaways can be defined for each panel. This is configured in each panel's Device Properties page via the NK-IPS.

Breakaway Reset

When enabled the Breakaway Reset option resets to the first breakaway (Default Breakaway) after a crosspoint switch. By default, the Breakaway Reset is off (check box is cleared).

Breakaway Warning Mode

The Breakaway Warning Mode determines which breakaway the current switch status is compared with to check if a Breakaway Warning condition has occurred. Two modes are available, Current (Current Breakaway) and Default (First Breakaway).

Assigning Functions to Keys

Use the Key Definitions table to assign functions to the buttons of the RCP-NK1. Any function can be assigned to any key. The keys are represented in the first column by their respective number (1-40). Keys 1-20 represent the first row of keys on the RCP-NK1 and keys 21-40 represent the second row of keys on the panel.

The desired key function is selected from the drop down box in the second column (Function column). Any function can be assigned to any key on the panel and keys can be assigned multiple times.

Details of parameters used in the Key Definition table are explained in detail in **Table 8.1**.

The Shift1 and Shift2 values only apply to SOURCE, DESTINATION and CROSSPOINT keys, all other keys only require the Default value to be defined, and some keys require no user defined values for operation. All Shift1 and Shift2 values are ignored when not assigned to SOURCE, DESTINATION or CROSSPOINT keys.

Each key can be assigned a function, with up to 3 parameters (Default, Shift1 and Shift2). This function will be called when that switch is pressed. The available key functions are listed in **Table 8.1**.

Table 8.1 Available Key Functions

Key Name	Description
DESTINATION	Changes the destination that the panel is controlling. If the DESTINATION KEY is not active, the default value is selected. When the DESTINATION KEY has been selected first, the relative destination is selected.
SOURCE	Switches the input using the current destination and level pattern. If the SOURCE KEY is not active, the default value is switched. When the SOURCE KEY has been selected first, the relative source is switched.
CROSSPOINT	Switches the input, output and level/breakaway associated with this key.
LEVEL	Toggles this level number from the current level pattern.
BREAKAWAY	Selects a pre-configured breakaway level pattern.
BREAKAWAY STEP	Steps through breakaways.
MACRO	Records key events that can be replayed later.
PROTECT	The PROTECT key attempts to protect the currently selected output/level pair.
TAKE	The TAKE key confirms input key events. The user sets up a switch, and presses the TAKE key to activate the switch.
CHOP	Alternates between the last two selected inputs.
SHIFT	Changes the source or destination page of the panel.
DESASSIGN	Allows users to reset a destination assignment.
MACHINE CONTROL	Toggles on/off RS-422 Machine Control for reciprocal switching.
PANEL LOCK	Locks the panel from all switches or function key operation.
UNASSIGNED	Key is not assigned any function or value.

Configuring the Cut Bus Destinations

There are two cut bus destination rows on the panel:

- Cutbus Destination 1 — The top row of keys when no DESTINATION or CROSSPOINT keys have been assigned. The valid range for the Cutbus Destination 1 is 1-255.
- Cutbus Destination 2 — The bottom row of keys when no DESTINATION or CROSSPOINT keys have been assigned. The valid range for the Cutbus Destination 2 is 1-255.

Setting the Brightness for the ON State

The On Brightness menu sets the LED brightness for the RCP-NK1 control panel buttons when the button is ‘on’; that is when it has been pressed, is already active, or when indicating an error by several quick flashes. The default value is 200. The valid input value range is 1-250.

The On Brightness does not necessarily have to be a higher value than that of the Off Brightness, although it is generally advised to avoid confusion.

Table 8.2 Configuration Values

Key	Default Value	Shift Value	Shift2 Value	Value Range
Dest	(Output) #	(DESTINATION SHIFT 1) Output #	(DESTINATION SHIFT 2) Output #	Output = 1-65535
The value range for DESTINATION keys is 1-255, representing any valid output value. There may be three pages/sets of DESTINATION keys on any one panel (the default page, first DESTINATION SHIFT page and one second DESTINATION SHIFT page).				
Source	(Input) #	(SOURCE SHIFT 1) Input #	(SOURCE SHIFT 2) Input #	Input = 1-65535
The value range for SOURCE keys is 1-255, representing any valid input value. There may be three pages/sets of SOURCE keys on any one panel (the default page, first SOURCE SHIFT page and one second SOURCE SHIFT page).				
Xpoint	(Destination) #	(Source) #	(Breakaway/Level) #	Source/Destination = 1-255 Breakaway = 1-16 Level = 17-24 (Level # +16)
The CROSSPOINT key requires a destination value, a source value, and a breakaway or level value to be correctly defined.				
Level	(Level) #	__ ^a	—	Level = 1-32
For details on levels and formats, refer to “ Router Levels Default ” on page 46.				
Breakaway	(Breakaway) #	—	—	Breakaway = 1-16
For details on assigning breakaways, refer to “ Breakaways Default ” on page 45.				
Brk Step	—	—	—	—
The BREAKAWAY STEP key is a function key that, once assigned, does not require any user defined values to operate.				
Macro	(Macro) #	—	—	Macro = 1-40
The valid range for the MACRO key is 1-40. (Up to 40 MACRO keys can be assigned to one panel.)				
Protect	—	—	—	—
The PROTECT key is a function key that, once assigned, does not require any user defined values to operate.				
Take	—	—	—	—
The TAKE key is a function key that, once assigned, does not require any user defined values to operate.				
Chop	—	—	—	—
The CHOP key is a function key that, once assigned, does not require any user defined values to operate.				
Shift	(Shift) #	—	—	Shift = 1-4 1 = DESTINATION SHIFT 1 2 = DESTINATION SHIFT 2 3 = SOURCE SHIFT 1 4 = SOURCE SHIFT 2
Defines the value of the SHIFT key, can be assigned as either a DESTINATION SHIFT or a SOURCE SHIFT.				
Deassign	—	—	—	—
The DEASSIGN key is a function key that, once assigned, does not require any user defined values to operate.				
MC Key	—	—	—	—

Table 8.2 Configuration Values

Key	Default Value	Shift Value	Shift2 Value	Value Range
The MACHINE CONTROL key is a function key that, once assigned, does not require any user defined values to operate.				
Panel Lock	—	—	—	—
The PANEL LOCK key is a function key that, once assigned, does not require any user defined values to operate.				
Unassigned	—	—	—	—
UNASSIGNED means that the key has no function or value assigned.				

- a. A dash (—) indicates that user defined values are not required and that any value entered here will be ignored.

Setting the Brightness for the OFF State

The Off Brightness sets the LED brightness for the RCP-NK1 control panel buttons when the button is ‘off’; that is when it has not been pressed and is not already active. The default value is 50. The valid input value range is 1-250.

Enabling Machine Control

The Machine Control Enabled option allows reciprocal switching when the check box is checked. By default, Machine Control Enabled is turned off (the check box is not checked).

- ★ If the Machine Control Enabled option is checked on the control panel’s Device Properties page, all switches activated from the panel will be reciprocal regardless of whether or not there is an MC KEY assigned to the panel.

Machine Control Level

The Machine Control Level configures the level that the machine control (if connected) switches reciprocally when switches are performed. The valid range for this field is 1-32 (representing levels).

- ★ If an invalid level (above 32) is entered for the Machine Control Level then the level will default to 32 when the settings are updated to the panel, regardless of whether the Machine Control Enabled option has been set or not.

Specifying a Communication Retry Delay

The Comms Retry Delay configures the delay (in milliseconds) by which the panel resends data in instances where an error has occurred. Errors may be encountered when the NK system is operating over a large network or when remote panels are being used over long distances. By default, the Comms Retry Delay value is set at 5 (milliseconds) and the valid range is 1 to 65,536 (milliseconds).

Typically, larger systems or systems operated across multiple networks or VPNs will require larger values. Nominally, the following values are recommended for specific standard configurations:

Table 8.3

Configuration	Recommended Delay
Single network system	5m
Single network system (via NK-HUB)	250ms to 500ms
VPN or Internet system (via NK-HUB)	500ms to 750ms

Linking the Control Panels

Control Panels can be linked together if they have the same address and a different panel link address (that is not 0). Linked panels behave exactly as if they were one larger panel with the exception that macros can not be appended or added across panels. The panels communicate using the T-Bus protocol with support for collision detection.

A Panel Link Address is required when users wish to use multiple control panels as one linked panel. When linking panels, the Address field must be the same for each panel, whereas the Panel Link Address must be different for each individual panel. By default, the Panel Link Address is set to 0. The valid value range for linking panels is 1-254.

Locking the Panel

When the panel is locked, it will not respond to key presses. By default, this feature is disabled (unlocked).

Panels can be locked by clicking on the Panel Locked check box, by pressing the PANEL LOCK key once or by holding down the PROTECT key (if one has been assigned) for about 3 seconds.

Configuring the NK-SCP Series

The NK-SCP/A requires breakaway and baud rate configuration only via the NK-IPS for use. When connected to the T-Bus Control System it will be displayed on the NK-IPS Online Devices pages. The NK routers to be interfaced by the NK-SCP/A can be configured individually on the Device Properties page, accessed via the NK-IPS, of each router.

Configuring the Breakaway Levels

The Breakaway Level Map is used to configure the router levels to defined breakaways used when switching with the SCP via the ASCII protocol.

For More Information on...

- on ASCII protocol terms and parameters, refer to “**Single Panel RCP-NK1 Operation**” on page 57.

NK-SCP/K2 Configuration

The NK-SCP/K2 itself does not need to be configured via the NK-IPS for use, but when connected to the T-Bus Control System it will be displayed on the NK-IPS Online Devices page. The NK routers to be interfaced by the Geneos CPU need to be configured identically in both the router’s Device Properties page accessed via the NK-IPS and the Physical Map and Virtual Labels pages in Geneos.

Configuring via the NK-IPS

Each router that is to be accessed by the Geneos CPU, needs to be configured via the NK-IPS. Details on configuring routers can be found in “Configuring Routers” on page 4–4.

Configure the router’s level, first input and first output on the router’s Device Properties page. The values entered here are exactly what are used and stored by the Geneos CPU for control system operation. If multiple routers are being used, each router will have to be configured independently.

- ★ It is recommended that if multiple routers are to be used for switching, that they be configured to have only one level per format.
- ★ If an invalid level (above 8) is entered for the Machine Control Level then the level will default to 8 when the settings are updated to the SCP, regardless of whether the Machine Control Enabled option has been set or not.

Configuring the NK-GPI

The NK-GPI is a universal GPI interface for the NK Series of routers. Providing both GPI inputs and outputs, the NK-GPI allows flexible GPI control, configured from the NK-IPS Device Properties pages. The NK-GPI also supports both GPI input return and latch modes.

Configuring the NK-GPI

NK-GPI configuration via the NK-IPS and a PC connected to a network, allows users to customize GPI inputs and outputs, as well as the input mode (Latch or Return), and a Panel Link Address, configuring the NK-GPI to be controlled from a connected NK Control Panel.

- ★ The NK-GPI does not require a De-bounce Delay to be configured when used with other Ross NK Series devices. The field only requires user input if using third-party devices.

Configuring the GPI Inputs

The GPI Ins Table configures the GPI and crosspoint behavior. When the GPI input is triggered, the specified crosspoint is switched.

Setting the GPI Inputs

You can configure the GPI and crosspoint behavior. When the GPI input is triggered, the specified crosspoint is selected.

Selecting the GPI In Mode

The GPI In Mode configures the GPI input for either Return or Latch mode. Return mode will hold the switch only while the GPI input trigger is held. Latch will switch and hold the crosspoint until another switch is activated.

Configuring the GPI Outputs

You can configure the GPI outputs that are triggered when a specified crosspoint is selected.

Selecting the GPI Out Mode

The GPI Out Mode configures the GPI outputs to either Follow GPI Ins, as configured in the GPI Ins table, or to use the GPI Out Table for crosspoint configuration.

Specifying a Panel Link Address

A Panel Link Address is required when users wish to use a panel to select the GPI outputs. When switches are activated by the control panel, the NK-GPI will follow the destinations as chosen by the panel.

When linking the NK-GPI to a control panel, the Address field must be the same for both devices, whereas the Panel Link Address must be different for each device. By default, the Panel Link Address is set to 0. The valid value range for linking panels is 1-254.

- ★ Defining an NK-GPI Panel Link Address to follow crosspoint and switch events as selected by an NK control panel will use the panel's destination instead of the destination defined by the GPI Out Mode selection (either in the GPI Input Table or GPI Output Table, depending on the mode selected).

NK Series Operation

The NK Series connects to devices to expand the signal types for the routing system.

- ★ The Ross NK series devices must be connected to the Ethernet network by virtue of an Ross NK-IPS or NK-NET devices to enable the NK Series to communicate with them.

Start-up Process

After power has been supplied to the NK Series components:

1. The routers broadcast their status to each other.
2. The panels also listen to these broadcasts and are able to download the matrix status within this time.
3. The linked panels broadcast their internal state (shift, destination, levels, take, chop and machine control).
4. The panels will attempt to retrieve the status for their current output/level pair.
5. The panels will request for any protects they may be holding.
6. Any routers (possibly multiple routers) with a protect held by this address will respond.

Router Start-up

On start-up, the newly connected router will attempt to download status from an operating router with the same output range and level. It will then switch all crosspoints and broadcast its status. Routers respond to data messages from other routers to allow this synchronization.

Control Panel Start-up

When a control panel is powered up, the LEDs will light 2 at a time from left to right. It will then fade to a Ross logo, fade that logo out and fade in the current status. This is to allow time for all connected NK devices to synchronize on start up.

Panels remember the last selected output and breakaway/level. These will be restored on power up unless overridden by a linked panel with different values.

Single Panel RCP-NK1 Operation

The control panel functions detailed below can be programmed with the NK-IPS for full functionality. The examples herein are described using the factory default configuration, loaded with every NK router.

For More Information on...

- the factory configuration, refer to the chapter “**Default Configurations**” on page 43.

The examples in the this section use the following conventions.



A lit button indicates a simple key press to execute the action.



Three thin, black lines signifying the key indicates that the key should be held down for approximately 3 seconds and then released to execute to action.



Source and destination keys are labeled as Input and Output keys, in this instance ‘Out11’ signifies Output 11 and ‘In4’ signifies Input 4.



In the example that use the SHIFT key, S SHIFT signifies SOURCE SHIFT and D SHIFT signifies DESTINATION SHIFT.

Selecting a Destination

Selecting a destination changes the virtual destination the panel controls or switches the next time a SOURCE key is pressed. Destinations can be selected by pressing a preset DESTINATION key. **Figure 11.1**

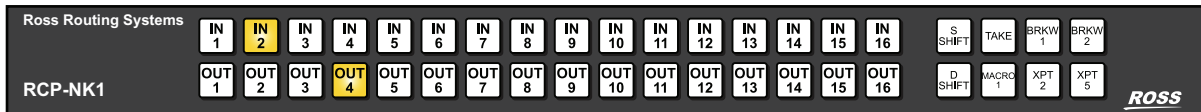

Figure 11.1 Example of Selecting a Source and Destination on the Panel

When a preset DESTINATION key is pressed, that key and its source status key (if a preset key exists) will be illuminated. If a breakaway warning occurs, the BREAKAWAY key will flash.

The bottom, left hand row of 16 keys is set to destination keys 1-16, pressing the D SHIFT key will change the bottom row to destination keys 17-32. **Figure 11.2**

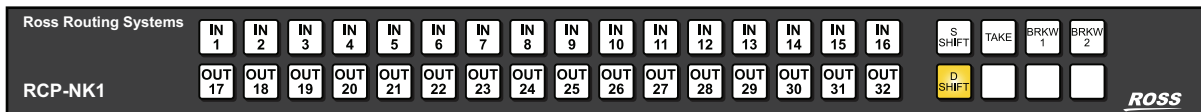

Figure 11.2 Example of Selecting D SHIFT

Selecting a Source

Source switching is performed by pressing a preset SOURCE key. Selecting a source (when a TAKE function key is not assigned) results in the controller requesting the selected source to be switched by the router to the panel’s current destination.

If the switch request was successful, the preset SOURCE key is illuminated. If the switch was not successful or generated errors, the key will flash several times quickly to indicate that an error has occurred. If a TAKE function key is assigned, the TAKE key will be illuminated and the preset SOURCE key will flash once quickly (this indicates that TAKE is armed). To perform the switch press the TAKE key or press any other key to cancel. **Figure 11.3**

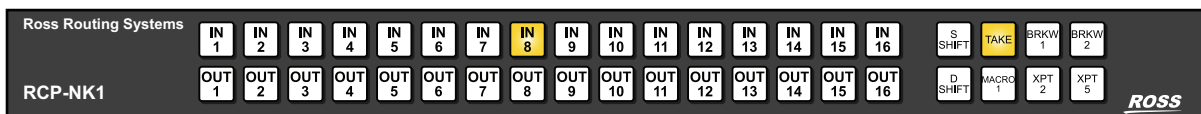

Figure 11.3 Example of Selecting TAKE

The top, left hand row of keys is set to source keys 1-16, pressing the S SHIFT key will change the top row to source keys 17-32. **Figure 11.4**

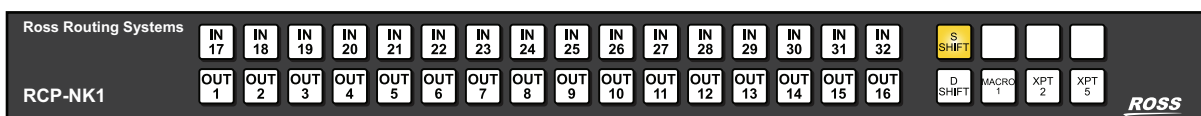

Figure 11.4 Example of Selecting S SHIFT

Using the Shift Keys

SHIFT keys allow the different pages or sets available to preset SOURCE and DESTINATION keys to be accessed. Up to three different sets of SOURCE and/or DESTINATION keys may be accessed from the panel. The SOURCE SHIFT keys change the current set of SOURCE keys available on the panel and the DESTINATION SHIFT keys change the current set of DESTINATION keys available. All other keys are not affected by SHIFT keys.

When no SHIFT keys are selected, the keys are on the first or default page/set. By pressing a specific SOURCE SHIFT or DESTINATION SHIFT key, the panel immediately changes its relevant sources or destinations to the specified set. The SHIFT key is active when illuminated. Pressing the SHIFT key again, toggles it to the default key set. As the sets change if a SOURCE or DESTINATION key matches the currently controlled destination or the source status that key will be illuminated.

Using the Crosspoint Keys

CROSSPOINT keys perform a preset crosspoint switch in a single key press, and the key will illuminate to indicate the state of that crosspoint. When a crosspoint switch is performed the panel's current destination, source and breakaway (optional) changes to those specified in the CROSSPOINT key assignment. If a breakaway is not specified, the currently selected breakaway on the panel is used for the switch.

If a CROSSPOINT key's preset destination and source status matches that destination's source status in the router on all levels on the current breakaway (or set breakaway) the key will be illuminated. If a TAKE function key is assigned, the TAKE key is illuminated and the preset CROSSPOINT key flashes (this indicates that TAKE is armed).

- ★ A CROSSPOINT key is not available on the factory default configuration. For configuration and functionality of the CROSSPOINT key, the NK-IPS is required.

Selecting a Level

LEVEL keys select the router levels. In the factory default configuration, there are four LEVEL keys assigned to the RCP-NK1 as outlined in the section “RCP-NK1” on page 25.

Using the Breakaway Keys

BREAKAWAY keys select preset groups of levels to be controlled. Breakaways can be customized from the control panel's Device Properties page via the NK-IPS. If BREAKAWAY and LEVEL keys are assigned, then the LEVEL keys will reflect the breakaway pattern. When the current breakaway is the first breakaway, the LEVEL keys will not be illuminated. The source status displayed is only for the first level of any given breakaway or level selection.

- ★ In the factory default configuration of the RCP-NK1, all levels are set to the default breakaway, which is the only defined breakaway.

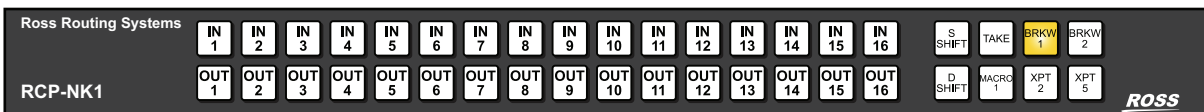

Figure 11.5 Example of Selecting a Breakaway

Breakaway Step Key

When breakaways have been configured from the NK-IPS, a BREAKAWAY STEP key may be used to cycle through the configured breakaways. Pressing this key will change the breakaway to the next breakaway with any levels. The BREAKAWAY STEP key will be illuminated if the current breakaway is not the first breakaway. Holding down the BREAKAWAY STEP key displays the levels enabled in the (current) breakaway pattern.

- ★ A BREAKAWAY STEP key is not available on the factory default configuration. For configuration and functionality of the BREAKAWAY STEP key, the NK-IPS is required.

Using Macros

Macros can be used to initiate multiple switches in one quick key press. Several **MACRO** keys can be assigned to one panel and then different macros recorded to each key. When users are required to regularly switch between two or more static switch assignments, macros can be used to switch these in one easy key press.

A macro is an event playback feature similar to a salvo. A salvo will only trigger a series of switches, whereas a macro will record a series of events for express playback at a later time. When the macro is played back, it will activate a sequence of switches to configure the router. Macros can be extremely valuable in minimizing repetitive key presses by configuring multiple switch events (source, destination and crosspoint) to one key.

A macro event comprises a source, destination, crosspoint, macro, or protect key press. When appending one macro to another, this is counted as one (1) event. This is covered in more detail in the section “**Appending Macros**” on page 60.

Overview

A **MACRO** key can store a maximum of 84 events and users can assign up to 40 **MACRO** keys on the RCP-NK1 panel. It is recommended that users with only a single, unlinked panel only assign two or three keys as **MACRO** keys. Users who have several linked panels may find it convenient to have one panel set aside solely for the purpose of macros and assign as many **MACRO** keys as is required.

- ★ Pressing a **SHIFT** key when recording a macro does not count as an event, as the macro recorder simply recognizes that the key that is actually pressed is the relevant source or destination.

Creating Macros

To record a macro, you first need to start ‘macro recording mode’.

1. Hold down the **MACRO** key for about three seconds.
The **MACRO** key will flash quickly to indicate that the panel has entered macro recording mode.
2. Release the **MACRO** key.
The **MACRO** key will flash slowly to indicate that the panel is in macro recording mode.
3. Enter the events you wish to record, as you would if you were to activate a switch.
Key presses will be acknowledged by a quick flash on the key you have entered into the macro.
4. When you have finished entering switch events, press the **MACRO** key to exit macro recording mode.
The **MACRO** key will stop flashing to indicate the panel has exited macro recording mode.

Appending Macros

Appending macros is a feature that allows the addition of more events (or another macro) to an already existing macro.

To append a macro, you first need to enter macro recording mode, and then enter macro recording mode again to append the macro.

1. Hold down the **MACRO** key for about three seconds.
The **MACRO** key will flash quickly to indicate that the panel has entered macro recording mode.
2. Release the **MACRO** key.
The **MACRO** key will flash slowly to indicate that the panel is in macro recording mode.
3. Hold down the **MACRO** key again (this will play back the macro internally so that it may be appended).
The **MACRO** key will flash quickly.
4. Release the **MACRO** key.
The **MACRO** key will again flash slowly to indicate that the panel is in macro recording mode.

5. Enter the events you wish to record as you would if you were to activate a switch.
Key presses will be acknowledged by a quick flash on the key you have entered into the macro.
6. When you have finished entering switch events, press the **MACRO** key to exit macro recording mode.
The **MACRO** key will stop flashing to indicate the panel has exited macro recording mode.

When appending macros or adding one macro to another, if you use a single input or output in more than one macro, it will override the previous status of that key.

Adding one Macro to another Macro

Adding one macro to another can be useful when you have more than one macro that shares the same output status (the same source to destination switch assignments) but where one macro also has output status that the other macro has not assigned.

As the macro function is only an event recorder, other macros are stored as one single event, not the sum of the events in that macro. Similarly, if a macro that has already been added to another macro is changed, the appended macro when played back will reflect that change.

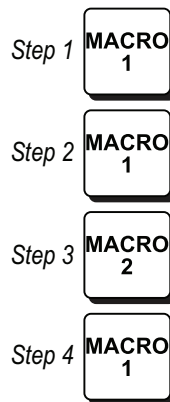

Figure 11.6 Example of Adding one Macro to Another Macro

In the example above, the Macros are as follows:

- Macro1 = Input 1 to Outputs 1, 2 and 3, and also sends input 2 to outputs 7, 8 and 9.
- Macro2 = Input 1 to Outputs 4, 5, 6 and 7, and also sends Input 2 to Outputs 8 and 9.

In this example, because Output 7 is used twice, the last status added will be the one used when the macro is played back. The final status of Macro1 when it is played back will be as such will be:

- Input 1 to Outputs 1,2,3,4,5,6 and 7.
- Input 2 to Outputs 8 and 9.

To cancel recording or appending a Macro, press the **MACRO** key after entering macro record mode.

- ★ Macros can not be canceled after entering events in macro recording mode. If a mistake has been made, you will have to exit macro recording mode and enter it again to re-enter events you wish to be played back.

Using the Protect Key

The PROTECT key is used to lock current destination from use by other sources, as well as from other linked panels. The PROTECT key is especially useful in instances where destination must be held after a switch has been made.

- ★ A **PROTECT** key is not available on the factory default configuration. For configuration and functionality of the PROTECT key, the NK-IPS is required. A **PROTECT** key can also be configured on the RCP-NK1 panel via Function Key Program Mode.

Using the Panel Lock

A panel may be locked to prevent unwanted key presses (particularly accidental switches). The Panel Lock is reflected on the control panel's Device Properties page of the NK-IPS, and can be locked or unlocked as required both from the NK-IPS configuration page or from the panel.

To activate the panel lock from the RCP-NK1

1. Hold down the **PROTECT** key for about three seconds.
The **PROTECT** key will flash quickly to indicate that the panel lock has been activated.
2. Release the **PROTECT** key.
The **PROTECT** key will flash slowly to indicate that the panel is locked.

The **PROTECT** key's panel lock function and the **PANEL LOCK** key are interchangeable. If both function keys are configured on the one panel, a panel lock can be activated from one key, and deactivated from the other.

Using the TAKE Key

A **TAKE** function key is used to activate the selected switch.

★ A **TAKE** key is not available on the factory default configuration. For configuration and functionality of the **TAKE** key, the NK-IPS is required. A **TAKE** key can also be configured on the RCP-NK1 panel via Function Key Program Mode.

1. Press the required destination key.
2. Press the required source key.
The **SOURCE** key on the panel flashes and the **TAKE** key illuminates.
3. To activate the switch, press the **TAKE** key is pressed.
The entered crosspoint change will be completed immediately after the **TAKE** key has been pressed. This enables the user to preset a crosspoint change before the switch is required. The pending switch can be aborted by pressing any key other than the **TAKE** key.

Using the Chop Key

The **CHOP** function key enables the user to alternate between two sources.

★ When **CHOP** is enabled, all other keys are disabled.

1. Pressing **CHOP** will alternate the two previously selected sources for a given destination.
2. Pressing **CHOP** once will start a slow chop.
3. Pressing **CHOP** again will increase the speed of the chop to a fast chop and pressing again will discontinue the chop mode.

Linked Panel RCP-NK1 Operation

When remote control panels are linked together, key behavior remains as above (with single panel system), although the following details must be noted when linking panels:

- Pressing **CHOP** will alternate between two sources, including cases when the sources are on different physical panels.
- Pressing **TAKE** will activate a take, including cases when the **SOURCE** key is on a different panel to the **TAKE** key.

- If any linked panel has a **TAKE** key, the linked device enters take mode when a source or crosspoint key is pressed.
- Locking one physical panel from the control panel's Device Properties page will also lock all linked panels. The NK-IPS can be used to unlock panels if required.
- Entering macro record mode causes all linked panels to be in macro record mode, switch events and protects can be added from different physical panels.
- Macros cannot be appended or added across panels.
- Page **SHIFT** keys control source and destination pages for the whole linked panel.
- **DESTINATION** keys control the destination for the whole panel.
- **LEVEL** and **BREAKAWAY** keys control the level mask for the whole panel. Breakaway preview is not available across linked panels.
- If a panel is added to an operating linked panel, the linked panel changes its states in regards to **TAKE**, **PANEL LOCK** and cut-bus accordingly.
- If a linked panel is added to an operating linked device that is in **TAKE**, **CHOP**, **PANEL LOCK**, or macro recording mode, it starts in that mode.
- Menus do not work across linked panels.

Analog Audio Router Levels

This chapter describes the Analog Audio control layers for NK Series products.

NK-A64 Control Layer

The Analog Audio level of NK-64 routers offers unparalleled configuration and audio processing, allowing users to mix left and right audio channels to suit their broadcast requirements. Channels may be swapped, phase inverted or converted to mono (both channels left, both channels right, both channels average, sum and difference).

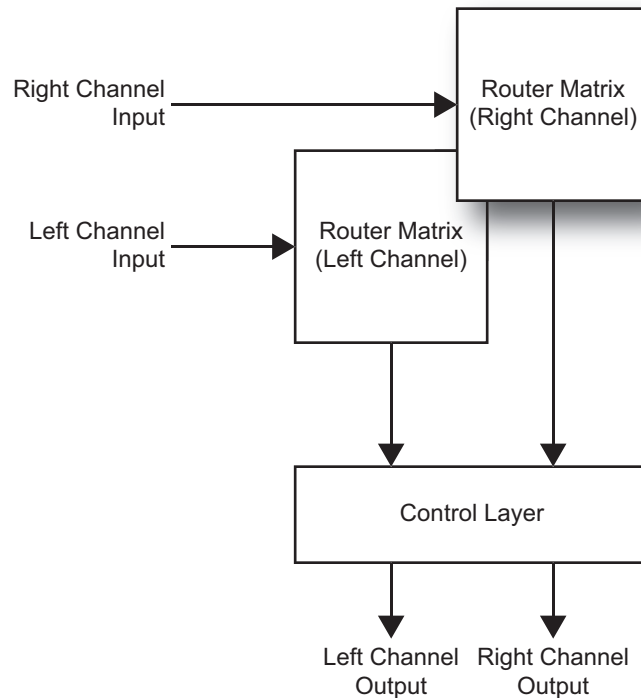

Figure 12.1 NK-A64 Control Layer Block Diagram

Signal processing is conducted by way of a Control Layer. The Control Layer is an additional level within the router matrix that may be mapped to control panel keys to allow users to mix audio channels on the fly. The Control Layer uses **SOURCE** keys as the triggers to mix the output audio signal. The Control Layer may be used after a source has been switched to a selected destination. **Table 12.1** shows the audio mixing options available for the Control Layer.

Table 12.1 Audio Mixing Options

Input Control	Signal Processing		Description
	Left Channel	Right Channel	
Input 1	L	R	Both channels normal (Default)
Input 2	R	L	Channels swapped
Input 3	L	L	Both channels Left
Input 4	R	R	Both channels Right
Input 5	L	R	Left channel normal, Right channel inverted
Input 6	L	R	Left channel inverted, Right channel normal
Input 7	L+R	L+R	Left channel sum (mono), Right channel sum (mono)

Table 12.1 Audio Mixing Options

Input Control	Signal Processing		Description
	Left Channel	Right Channel	
Input 8	L+R	L-R	Left channel sum (mono), Right channel difference

Control Layer Operation via RCP-NK Panels

The Analog Audio Control Layer can easily be accessed from NK Series control panels. Factory configured systems will allow the NK-A64 Control Layer to operate out of the box. Further configuration of the NK-A64 Control Layer and control panel options requires the NK-IPS.

- ★ When assigning breakaways for NK Series control panels, the Control Layer should not be assigned to a breakaway that contains other levels. If users require a breakaway for the NK-A64 Control Layer, it is vital that it is the only level active for that breakaway.

Mixing the Output Audio Signal

When using the Control Layer, users must remember that only the output audio stream is processed within the router matrix, not the input signal. When mixing audio channels, the control layer is selected after the switch has been made, or if the output that requires mixing is already active. Users may record macros to make mixing and switches easier, or if regular audio mixing is required.



Selecting the **Control Layer** key and then selecting **IN 1** will enable the output audio channels to be normal.



Selecting the **Control Layer** key and then selecting **IN 2** will enable the output audio channels to be swapped.



Selecting the **Control Layer** key and then selecting **IN 3** will enable both output audio channels to be the left channel of the source.



Selecting the **Control Layer** key and then selecting **IN 4** will enable both output audio channels to be the right channel of the source.



Selecting the **Control Layer** key and then selecting **IN 5** will enable the left output audio channel to be normal and the right audio channel to be inverted.



Selecting the **Control Layer** key and then selecting **IN 6** will enable the left output audio channel to be inverted and the right audio channel to be normal.



Selecting the **Control Layer** key and then selecting **IN 7** will enable the both output audio channels to be summed.



Selecting the **Control Layer** key and then selecting **IN 8** will enable the left output audio channel to be summed and the right audio channel to be differenced.

Examples

To swap the channels of the output audio signal for OUT 4

1. Select the destination.



2. Select the source.



3. Select the Control Layer, or the breakaway that the Control Layer is on.



4. Select the designated mixing mode.



To invert the left channel of the output audio signal for OUT 6

1. Select the destination.



2. Select the source.



3. Select the Control Layer, or the breakaway that the Control Layer is on.



4. Select the designated mixing mode.



- ★ The Control Layer configuration is retained by the destination until the Control Layer is changed. For example, if **IN 1** is switched to **OUT 3** and the left and right channels are swapped (by pressing the **Control Layer** key and then selecting **IN 2**) the next Input selected to be switched to **OUT 3** will also have the left and right channels swapped.

Router Interfaces Overview

This chapter summarizes the DashBoard interfaces for the NK Series routers.

Device Properties Interface Overview

The router Device Properties interface, accessible through the NK-IPS, allows users to configure interface and usability options for all NK Series routers and also displays the alarm status of the router, as well as having the unique ability to assign names and brief descriptions for the devices themselves.

Device Properties Fields

Table 13.1 Device Properties Fields

Field	Description
Family	The Family name is set in the factory before shipping and displays the family that the device belongs to. This parameter is read-only.
Device	The Device name is set in the factory before shipping and displays the name assigned to the device. This parameter is read-only.
Serial Number	The Serial Number is set in the factory before shipping and is unique to each device. This parameter is read-only.
Name	The Name field can be assigned by the user to uniquely name a device. This field has a maximum of 16 characters and is used for description and identification only.
Details	The Details field can be assigned by the user to give a device specific details. For example, a physical location or a brief description of its use. This field has a maximum of 16 characters and is used for description and identification only.
Group	The Group number can be assigned by the user to organize devices into groups. For example, users can assign separate Group numbers for devices in different physical areas. This field has a maximum of 10 characters and is used for description and identification only.

Configuration Fields

Table 13.2 Configuration Fields

Field	Description
Address	The Address is used within the overall control system to identify devices. Each device must be given a unique Address to avoid hardware and communication conflicts. The valid value range for assigning an individual device Address is 2-255.
Ignore Out of Range Inputs	<p>The Ignore Out of Range Inputs option will ignore switches on an offset router that has been configured to the same level as another connected router. By default, the Ignore Out of Range Inputs option is not active (the check box is cleared).</p> <p>The Ignore Out of Range Inputs option is only available on the NK-64 and NK-72 routers and is only used for specific installations</p>

Table 13.2 Configuration Fields

Field	Description
Switching Point	These options are only available on the NK-64 and NK-72 routers.
Custom Switching Line	
Custom Switching Position	
First Input	The First Input defines the first source used (from the range of 1-255) by the router. The valid range for the First Input is 1-65535, the default is 1.
First Output	The First Output defines the first destination used (from the range of 1-255) by this router. The valid range for the First Output is 1-65535, the default is 1.
Machine Control Destination	The Machine Control Destination radio buttons specify whether the destinations are used as the Slave or as the Master. This option is available to NK-M Routers only. The Machine Control Destination option is only available on the Machine Control router's Device Properties page. It is not applicable to other NK router models.

Number of Partitions

The **Num Partitions** field (Number of Partitions) indicates how you wish the router to be partitioned. The default value of the partitions is 1 (no partitions.), the maximum value is 8.

Table 13.3 shows the relative input and output sizes to the number of partitions configured for 16x16, 32x32, 64x64 and 72x72 routers.

Table 13.3 Relative input and output sizes to the number of configured partitions

16x16 Router		32x32 Router		64x64 Router		72x72 Router	
Partitions	I/O Size	Partitions	I/O Size	Partitions	I/O Size	Partitions	I/O Size
1	16x16	1	32x32	1	64x64	1	72x72
2	8x8	2	16x16	2	32x32	2	36x36
3*	5x5	3*	10x10	3*	21x21	3	24x24
4	4x4	4	8x8	4	16x16	4	18x18
5*	3x3	5*	6x6	5*	12x12	5*	14x14
6*	2x2	6*	5x5	6*	10x10	6	12x12
7*	2x2	7*	4x4	7*	9x9	7*	10x10
8*	2x2	8	4x4	8	8x8	8	9x9

* Denotes that partition leaves unusable inputs/outputs as 'remainders'.

When partitioning routers, some configurations will leave 'remaindered' inputs and outputs. Any division of the router that leaves a remainder will not use the remaining inputs and outputs. For example, a 32x32 partitioned into 3, will be equivalent to three 10x10 routers (30 inputs and 30 outputs in total). The last two inputs and the last two outputs will remain unused and inaccessible for router functions.

Partition Levels

The Partition Levels table allows users to configure levels to each partition. Selecting a level, by selecting a check box in the Levels column, assigns that level to a partition number from the Part. Num. column.

Levels can be assigned more than once to different or distinct partitions, but only one level can be selected for each partition.

Control Layer Partitions (NK-A64 only)

The NK-A64 Analog Audio Level Router has a control layer in addition to the first and second levels (left and right channels respectively). The control layer is used for lossless signal mixing, for more information, refer to “**NK-A64 Control Layer**” on page 65.

The Control Layer Partition table allows users to configure levels to each partition. Selecting a level, by selecting a check-box in the Levels column, assigns that level to a partition number from the Part. Num. (Partition Number) column.

Levels can be assigned more than once to different or distinct partitions, but only one level can be selected for each partition.

Status Fields

Reference Signal Type

The Reference Signal Type automatically detects if a video reference is being looped through the router. It will show the signal type if there is a reference present, either PAL or NTSC, or, if no reference is detected, it will display Local.

The Local signal is the internal random switching pulse that is generated by the router to ensure successful switch timing. For more information on video referencing, refer to “**Video Referencing**” on page 36.

Alarms

The Alarms status section of the Device Properties page is divided into three headings: Reference, Matrix Power and RCP Power. The NK-64 routers also have an additional alarm warning for I/O Power.

There are four degrees of alarm urgency: Green (Normal operation), Yellow (Warning), Orange (Error) and Red (Critical Error). The possible Reference, Matrix Power, and RCP Power statuses are displayed in **Table 13.4**.

Table 13.4 Alarms

Heading	Possible Status	Alarm Urgency	Status Color
Reference	No Reference Detected	Warning	Yellow
	Reference Present	None (Safe)	Green
Matrix Power	Matrix Power Error	Critical Error	Red
	Matrix Power OK	None (Safe)	Green
RCP Power	RCP Power Error	Critical Error	Red
	RCP Power OK	None (Safe)	Green
I/O Power (NK-64 only)	I/O Power OK	None (Safe)	Green
	I/O Power Error	Critical Error	Red

Reference Status

The Reference status alarm indicates if there if a video reference connected to the router. It will also display the format of the reference, either PAL or NTSC. If a video reference is connected, the router will attempt to perform all switches during the vertical interval of the reference. If there is no reference connected, the router will still function, but the switches may be activated by the router at any time. For more information on the NK video/switching reference feature, refer to “**Video Referencing**” on page 36.

Matrix Power

The Matrix Power status alarm indicates the power status of the router. A router that displays any alarm status other than Green (safe) should be switched off and unplugged. Another power pack can be used to test the router frame again, but if the status alarm remains on the Device Properties page, a Ross Video representative should be contacted.

RCP Power

The RCP Power status alarm indicates the power status that the router distributes to the control panels connected to it. For any alarm status other than Green (safe), panels should be disconnected one by one, and the alarm status checked. In some instances there may be too many devices connected to the router to ensure regulated power consumption by each device. If all devices have been disconnected from the router and the alarm status remains activated, the router should be switched off and unplugged. Another power pack can be used to test the router frame again, but if the alarm status remains higher than Green on the Device Properties page, a Ross Video representative should be contacted.

I/O Power (NK-64 Routers only)

The I/O Power status alarm indicates the I/O card status for the router. As NK-64 routers are comprised of 8 separate I/O cards, each card has its own alarm. If any card has a fault or fails during operation, the I/O Power status alarm will be triggered. If the alarm has been triggered, each input and output card should be checked individually before using the router for further operations.

Submit and Upgrade Firmware Fields

The Submit Settings button will upload the settings to the device.

If users wish to cancel or ignore the settings they have made, click the Online tab to return to the Online Devices page, or click the Refresh button of your browser to revert to the original settings displayed.

The Upgrade Firmware button is used to upload to the device the latest firmware, contained in a binary file. Upgrading firmware allows new features, enhancements and improvements of the NK router to be installed.

RCP Interfaces Overview

This chapter summarizes the DashBoard interfaces for the NK Series remote control panels.

Device Properties Interface Overview

The Device Properties interface, accessible through the NK-IPS, allows users to configure interface and usability options for all NK Series routers and also displays the alarm status of the router, as well as having the unique ability to assign names and brief descriptions for the devices themselves.

Device Properties Fields

Table 14.1 Device Properties Fields

Field	Description
Family	The Family name is set in the factory before shipping and displays the family that the device belongs to. This parameter is read-only.
Device	The Device name is set in the factory before shipping and displays the name assigned to the device. This parameter is read-only.
Serial Number	The Serial Number is set in the factory before shipping and is unique to each device. This parameter is read-only.
Name	The Name field can be assigned by the user to uniquely name a device. This field has a maximum of 16 characters and is used for description and identification only.
Details	The Details field can be assigned by the user to give a device specific details. For example, a physical location or a brief description of its use. This field has a maximum of 16 characters and is used for description and identification only.
Group	The Group number can be assigned by the user to organize devices into groups. For example, users can assign separate Group numbers for devices in different physical areas. This field has a maximum of 10 characters and is used for description and identification only.

Configuration Fields

Table 14.2 Configuration Fields

Field	Description
Address	The Address is used within the overall control system to identify devices. Each device must be given a unique Address to avoid hardware and communication conflicts. The valid value range for assigning an individual device Address is 2-255. When linking multiple control panels, each device must be given the same address to communicate to other devices as one panel, but a different Panel Link Address must be given to prevent internal control system conflicts.
Breakaways	The Breakaways table is used to assign levels to breakaways.
Key Definitions	The Key Definitions table is where the buttons of the RCP-NK1 are assigned.

Table 14.2 Configuration Fields

Field	Description
On Brightness	Sets the LED brightness for the RCP-NK1 when the button state is “on”.
Off Brightness	Sets the LED brightness for the RCP-NK1 when the button state is “off”.
Panel Locked	Indicates when the panel has been locked to not respond to key presses. By default, this feature is off.
Machine Control Enabled	The Machine Control Enabled option allows reciprocal switching when the check box is checked.
Panel Link Address	Used when configuring multiple control panels as a singled linked panel.
Clear Protect	Clears any protects on the panel when the Submit Settings button is selected.
Comms Retry Delay	Configures the delay (ms) the panel resends data when an error is occurring.

Protect Alarm

The Protect Alarm indicates whether an output has been protected from the control panel. The Protect Alarm status is also displayed on the NK-IPS Online Devices page and in Phoenix.

Submit Settings

The Submit Settings button will upload the settings to the device.

If users wish to cancel or ignore the settings they have made, click the Online tab to return to the Online Devices page, or click the Refresh button of your browser to revert to the original settings displayed.

Upgrade Firmware

The Upgrade Firmware button is used to upload to the device the latest firmware, contained in a binary file. Upgrading firmware allows new features, enhancements and improvements of the RCP-NK1 to be installed.

NK-SCP/A Overview

The NK-SCP/A can be used for control of an entire NK routing system. Switches activated from an external RS-232 device are monitored by all devices on the T-Bus line.

The protocol used is a simple ASCII protocol designed to give users a means for simple control of the router via custom PC software or by connecting a terminal to the AUX port and sending ASCII characters.

Using the ASCII Protocol with the NK-SCP/A

The protocol used is a simple ASCII protocol designed to give users a means for simple control of the router via custom PC software or by connecting a terminal to the **AUX** port and sending ASCII characters.

Fixed Parameters

The parameters in **Table 15.1** are fixed.

Table 15.1 COMM Port Fixed Parameters

Parameter	Setting
Parity	None
Stop Bits	1
Data Bits	8
Characters	ASCII

Commands

Table 15.2 describes the protocol commands.

Table 15.2 ASCII Protocol Commands

Command	Description
<X>	Switch an input to an output using a breakaway
<Z>	Switch multiple inputs (one per level) to an output
<R>	Read the current status of an output

Table 15.3 describes the command parameters.

Table 15.3 ASCII Protocol Command Parameters

Command	Description	Value	Note
<ddd>	Destination - output number	(000 to 254)	1
<sss>	Source - input number	(000 to 254)	1
	Breakaway number	(1 to 8)	2
<--->	Blank entry (in place of actual output sock number)		
<CR>	Carriage return character		
<LF>	Line feed character		
<SP>	Space character		

An offset of -1 is required so that the lowest value of 000 points to the router input or output number 1. In this way, inputs and outputs from 1 to 255 can be addressed with dialogue values from 000 to 254.

To switch an input to an output using a defined breakaway

1. Start the sequence (11 bytes) with an upper case <X> followed by the destination, source, breakaway and carriage return as detailed below. Do not include the parentheses.

<X> <ddd> <,> <sss> <,> <CR>

2. Response from the NK-SCP:

- If the data string is valid, the SCP returns response (B).
- If the data string is invalid, the SCP returns response (A).
- If the data string is valid but the source number is unavailable or any of the parameters are incorrectly specified, i.e. greater than 254 (255 to 999) for destination and source and greater than 1 to 8 (0 or 9) for breakaway, the SCP returns response (A) then response (B).

Response (A) <CR> <LF> <ERROR> <CR> <LF>

Response (B) <CR> <LF> <OK> <SP> <CR> <LF>

To switch multiple inputs (one per level) to an output

1. Start the sequence (37 bytes) with an upper case <Z> followed by the destination, then a source (or <---> to not switch a level) for each of 8 levels and carriage return as detailed below. Do not include the parentheses.

L1L2L3L4L5L6L7L8

<Z><ddd><,><sss,sss,sss,sss,sss,sss,sss,sss><CR>

Send <---> in place of <sss> to not switch that level.

2. Response from the NK-SCP:

- If the data string is valid, the SCP returns response (B).
- If the data string is invalid, the SCP returns response (A).
- If the data string is valid but the source number is unavailable or any of the parameters are incorrectly specified, i.e. greater than 254 (254 to 999) for destination and source and greater than 1 to 8 (0 or 9) for breakaway, the SCP returns response (A) then response (B).

Response (A) <CR> <LF> <ERROR> <CR> <LF>

Response (B) <CR> <LF> <OK> <SP> <CR> <LF>

To read the current status of an output

1. Start the sequence (5 bytes) with an upper case <R> followed by the destination and carriage return as detailed below. Do not include the parentheses.

<R> <ddd> <CR>

2. Response from the NK-SCP:

- If the data string is valid, the SCP returns response (C) then (B).
- If the data string is invalid, the SCP returns response (A).
- If the data string is valid but the destination is incorrectly specified, i.e. greater than 254 (255 to 999), the SCP returns response (A) then response (B).

Response (A) <CR> <LF> <ERROR> <CR> <LF>

Response (B) <CR> <LF> <OK> <SP> <CR> <LF>

L1L2L3L4L5L6L7L8

Response (C) <CR><LF><sss,sss,sss,sss,sss,sss,sss,sss><CR><LF>

NK-SCP/K2 Operation

Implementation of the NK-SCP/K2 means that NK routers can be controlled exactly as if they were a matrix module housed within the Kondor 2 frame. Switches can be activated by Geneos control panels as well as from a Virtual Control Panel (VCP) from the Panel-works page in the Geneos software.

When switches are activated from a control panel or VCP connected to the Geneos CPU, the SCP/K2 monitors commands and converts them to the T-Bus protocol. If the command sent corresponds with a level that an NK router is occupying, then that level will be switched. If there are no NK routers occupying that level, then the switch will be performed where that level is occupied, most likely within the Kondor 2.

Switches can be activated from the NK control panel (RCP-NK1) but are not advised as they will not be reflected within the Geneos CPU status table. If an RCP-NK1 is connected to the router (or T-Bus), any switches activated by the panel will override the status and commands from the Geneos panels or Geneostat virtual control panels.

NKP-SCP/A Device Properties Interface Overview

The Device Properties interface, accessible through the NK-IPS, allows users to configure interface and usability options for all NK Series routers and also displays the alarm status of the router, as well as having the unique ability to assign names and brief descriptions for the devices themselves.

Device Properties Fields

Table 15.4 Device Properties Fields

Field	Description
Family	The Family name is set in the factory before shipping and displays the family that the device belongs to. This parameter is read-only.
Device	The Device name is set in the factory before shipping and displays the name assigned to the device. This parameter is read-only.
Serial Number	The Serial Number is set in the factory before shipping and is unique to each device. This parameter is read-only.
Name	The Name field can be assigned by the user to uniquely name a device. This field has a maximum of 16 characters and is used for description and identification only.
Details	The Details field can be assigned by the user to give a device specific details. For example, a physical location or a brief description of its use. This field has a maximum of 16 characters and is used for description and identification only.
Group	The Group number can be assigned by the user to organize devices into groups. For example, users can assign separate Group numbers for devices in different physical areas. This field has a maximum of 10 characters and is used for description and identification only.

Configuration Fields

Table 15.5 Configuration Fields

Field	Description
Address	The Address is used within the overall control system to identify devices. Each device must be given a unique Address to avoid hardware and communication conflicts. The valid value range for assigning an individual device Address is 2-255.
ASCII Port Baud Rate	Configures the baud speed of the NK-SCP/A. The available options from the drop down box are 9600, 14.4k, 28.8k, 38.4k, 57.6k and 115.2k. By default, the baud rate is set to 9600.
Breakaway Level Map	Configures the router levels to defined breakaways

Submit Settings

The Submit Settings button will upload the settings to the device.

If users wish to cancel or ignore the settings they have made, click the Online tab to return to the Online Devices page, or click the Refresh button of your browser to revert to the original settings displayed.

Upgrade Firmware

The Upgrade Firmware button is used to upload to the device the latest firmware, contained in a binary file. Upgrading firmware allows new features, enhancements and improvements of the RCP-NK1 to be installed.

NKP-SCP/K2 Device Properties Interface Overview

The NK-SCP/K2 itself does not need to be configured via the NK-IPS for use, but when connected to the T-Bus Control System it will be displayed on the NK-IPS Online Devices page.

Device Properties Fields

Table 15.6 Device Properties Fields

Field	Description
Family	The Family name is set in the factory before shipping and displays the family that the device belongs to. This parameter is read-only.
Device	The Device name is set in the factory before shipping and displays the name assigned to the device. This parameter is read-only.
Serial Number	The Serial Number is set in the factory before shipping and is unique to each device. This parameter is read-only.
Name	The Name field can be assigned by the user to uniquely name a device. This field has a maximum of 16 characters and is used for description and identification only.

Table 15.6 Device Properties Fields

Field	Description
Details	The Details field can be assigned by the user to give a device specific details. For example, a physical location or a brief description of its use. This field has a maximum of 16 characters and is used for description and identification only.
Group	The Group number can be assigned by the user to organize devices into groups. For example, users can assign separate Group numbers for devices in different physical areas. This field has a maximum of 10 characters and is used for description and identification only.

Configuration Fields

Table 15.7 Configuration Fields

Field	Description
Address	The Address is used within the overall control system to identify devices. Each device must be given a unique Address to avoid hardware and communication conflicts. The valid value range for assigning an individual device Address is 2-255.
Machine Control Enabled	Allows reciprocal switching when enabled.
Machine Control Level	Configures the level that the machine control (if enabled) switches reciprocally when switches are performed.

NK-GPI Interfaces Overview

This chapter summarizes the interfaces for the NK-GPI.

NKP-GPI Device Properties Interface Overview

The NK-GPI Device Properties interface, accessible through the NK-IPS, allows users to configure the GPI input and output range, as well as the input and output modes.

Device Properties Fields

Table 16.1 Device Properties Fields

Field	Description
Family	The Family name is set in the factory before shipping and displays the family that the device belongs to. This parameter is read-only.
Device	The Device name is set in the factory before shipping and displays the name assigned to the device. This parameter is read-only.
Serial Number	The Serial Number is set in the factory before shipping and is unique to each device. This parameter is read-only.
Name	The Name field can be assigned by the user to uniquely name a device. This field has a maximum of 16 characters and is used for description and identification only.
Details	The Details field can be assigned by the user to give a device specific details. For example, a physical location or a brief description of its use. This field has a maximum of 16 characters and is used for description and identification only.
Group	The Group number can be assigned by the user to organize devices into groups. For example, users can assign separate Group numbers for devices in different physical areas. This field has a maximum of 10 characters and is used for description and identification only.

Configuration Fields

Table 16.2 Configuration Fields

Field	Description
Address	The Address is used within the overall control system to identify devices. Each device must be given a unique Address to avoid hardware and communication conflicts. The valid value range for assigning an individual device Address is 2-255.
GPI Ins Table	Configures the GPI and crosspoint behavior.
GPI Outs Table	Configures the GPI output that is triggered when a specified crosspoint is selected.
Debounce Delay	Configures the time (ms) that the NK-GPI will allow before sending a trigger event.

Submit Settings

The Submit Settings button will upload the settings to the device.

If users wish to cancel or ignore the settings they have made, click the Online tab to return to the Online Devices page, or click the Refresh button of your browser to revert to the original settings displayed.

Upgrade Firmware

The Upgrade Firmware button is used to upload to the device the latest firmware, contained in a binary file.

Connectors and Pinouts

This chapter provides additional information on the pinout assignments and connector details for the NK Series products.

DB-25 Pinouts for Analog and Digital Audio Routers



The following pinouts are applicable only for current NK-A16, NK-A32, NK-D16/110 and NK-D32/110 routers. These routers can be distinguished by the silk screen of the pinouts on the rear of the router.

Previous routers, without pinouts silk screened on the rear, require an alternate wiring. These are detailed in the NK Series User Guide v1.0 and v1.1 or in the NK Series DB-25 Pinouts Application Note.

The reason for the altered pinouts is that cables can be purchased off the shelf from most audiovisual, broadcast or music retailers.

NK-A16 and NK-D32/110 Wiring (16x16 Routers)

Figure 17.1 shows the pinouts for inputs and outputs on the NK-A16 and NK-D16/110.

★ The pinouts detailed in Figure 17.1 are applicable for both left and right channels (NK-A16 only).

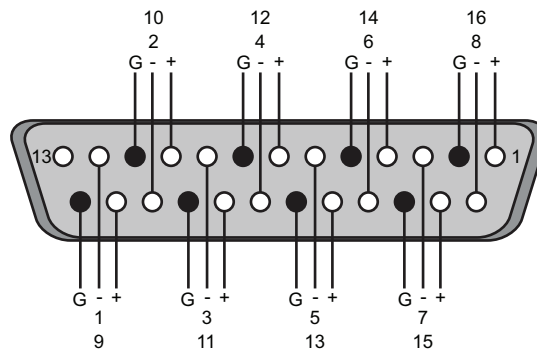

Figure 17.1 NK-A16 and NK-D16/110 — Pinouts for Inputs and Outputs

NK-A16 Unbalanced Wiring

Figure 17.2 shows pinouts for unbalanced input connections (left and right channels) for the NK-A16 model.

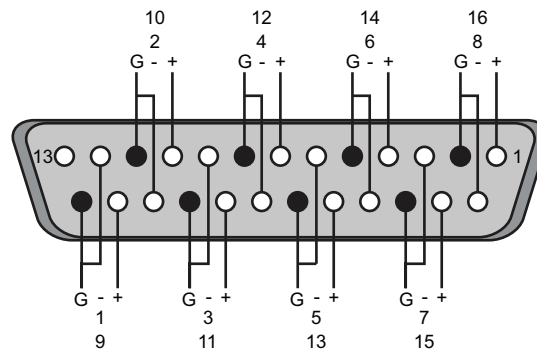

Figure 17.2 NK-A16 — Pinouts for Unbalanced Inputs

Figure 17.3 shows pinouts and wiring details for unbalanced output connections (left and right channels) for the NK-A16 model.

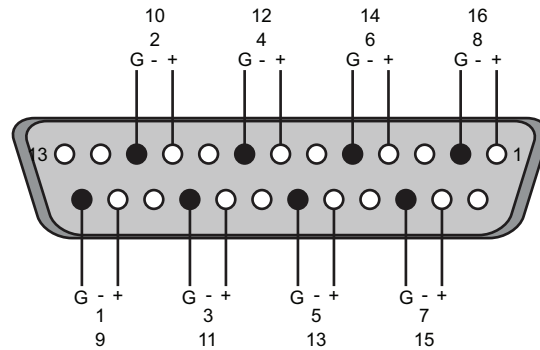

Figure 17.3 NK-A16 — Pinouts for Unbalanced Outputs

NK-A32 and NK-D32/110 Wiring (32x32 Routers)

Figure 17.4 shows the pinouts for both inputs and outputs 17-32 on the NK-A32 and NK-D32/110. Pinouts for inputs and outputs 1-16 are as depicted previously.

★ The pinouts detailed in **Figure 17.4** are applicable for both left and right channels (NK-A32 only)

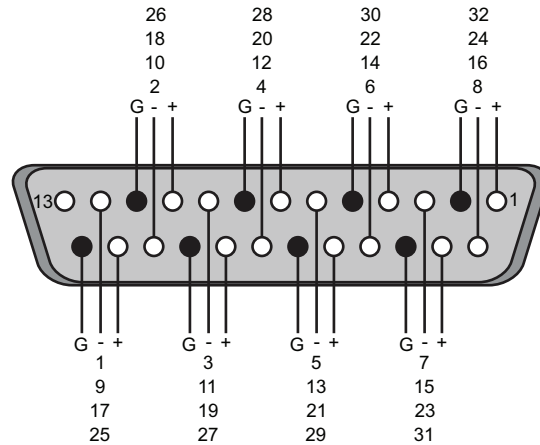

Figure 17.4 NK-A32 and NK-D32/110 — Pinouts for Inputs and Outputs

NK-A32 Unbalanced Wiring

Figure 17.5 shows pinouts for unbalanced input connections (left and right channels) for the NK-A32.

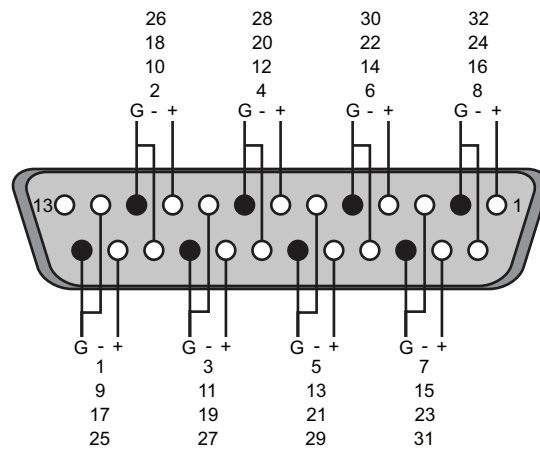

Figure 17.5 NK-A32 — Pinouts for Unbalanced Inputs

Figure 17.6 shows pinouts for unbalanced output connections (left and right channels) for the NK-A32.

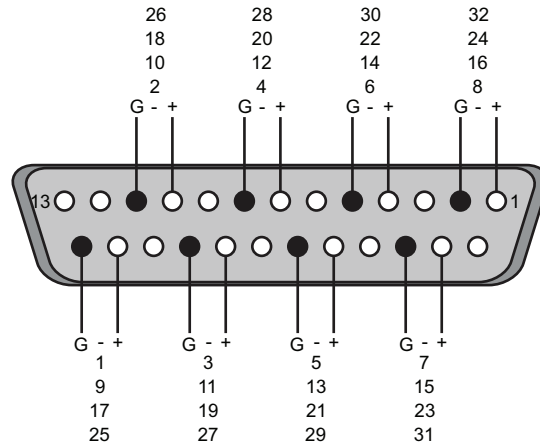

Figure 17.6 NK-A32 — Pinouts for Unbalanced Outputs

NK-A64 Wiring (64x64 Routers)

Figure 17.7 shows the pinouts for both inputs and outputs on the NK-A64. Each connector allows balanced audio of four audio channels.

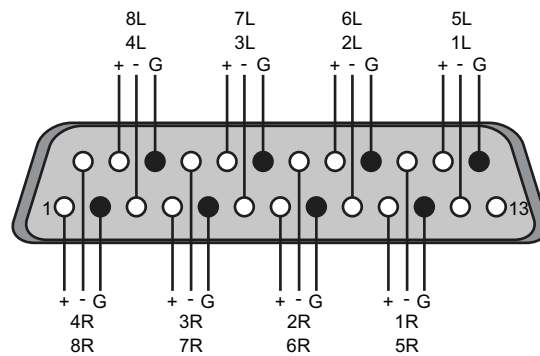

Figure 17.7 NK-A64 and NK-D64/110 — Pinouts for Inputs and Outputs

NK-A64 Unbalanced Wiring

Figure 17.8 shows pinouts and wiring details for unbalanced input connections for the NK-A64.

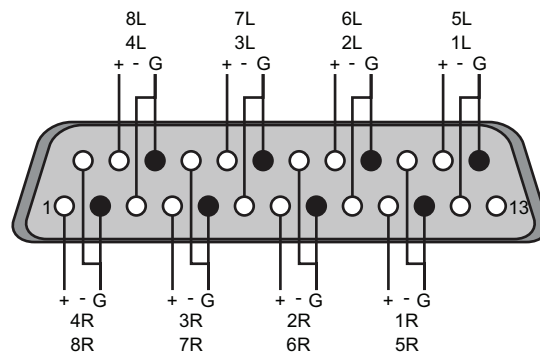

Figure 17.8 NK-A64 — Pinouts for Unbalanced Inputs

Figure 17.9 shows pinouts and wiring details for unbalanced output connections for the NK-A64.

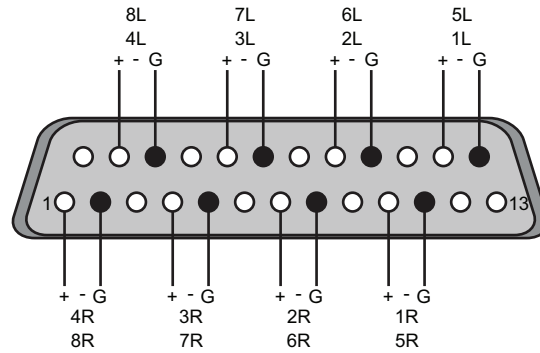

Figure 17.9 NK-A64 — Pinouts for Unbalanced Outputs

NK-D64/110 Wiring

Figure 17.10 shows the pinouts for both inputs and outputs on the NK-D64/110. Pinouts for inputs and outputs 1-32 are as depicted previously.

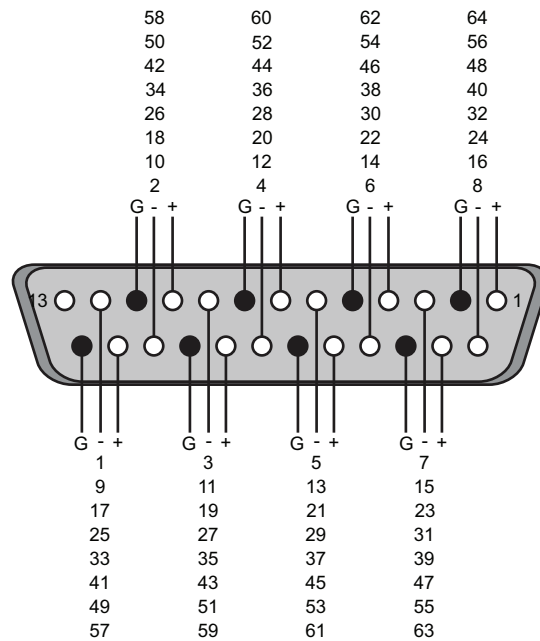

Figure 17.10 NK-D64/110 — Pinouts for Inputs and Outputs

DB-9 Power Connector (All NK-16 and NK-32 Routers)

Figure 17.1 shows the DB-9 connector port on the rear of the routers and can be used to connect GPI alarms.

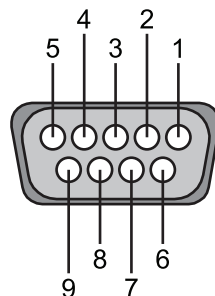

Figure 17.11 DB-9 External View Male Connector — Pinout Assignment

Table 17.1 DB-9 Pinout Assignments

Pin	GPI Alarms
1	N/C
2	RCP Power Fail
3	Matrix Power Fail
4	GND
5	GND
6	+15V
7	+15V
8	-15V
9	-15V

Machine Control DB-9 Pinouts (NK-M16 and NK-M32)

Figure 17.12 shows the pinouts for DB-9 connections on the NK-M16 and NK-M32 Machine Control routers.

★ The Machine Control DB-9 pinouts are dependent on which mode (Master or Slave) is being used.

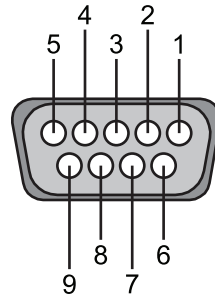

Figure 17.12 DB-9 Connector — Pinouts for NK-M16 and NK-M32 Routers

Table 17.2 DB-9 Pinout Assignments

Pin	Master	Slave
1	GND	GND
2	TX-	Rx-
3	RX+	Tx+
4	GND	GND
5	N/C	N/C
6	GND	GND
7	Tx+	Rx+
8	Rx-	Tx-
9	N/C	N/C

GPI Alarm Pinouts (NK-64 and NK-72)

Figure 17.3 shows the 3-way Phoenix connector on the rear of the NK-64 and NK-72 routers which is used to connect GPI alarms.

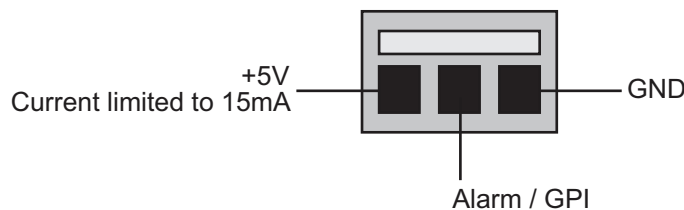

Figure 17.13 3-pin Connector — Pinouts for GPI Alarms

T-BUS RJ-45 Connector

Figure 17.14 shows the RJ-45 connector port for the T-Bus control system.

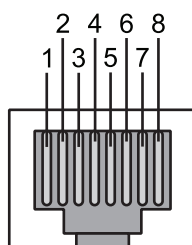

Figure 17.14 RJ45 Female Connector (External View) — Pinout Assignments

Table 17.3 T-BUS RJ-45 Pinout Assignments

Pin	Signal
1	GND
2	GND
3	+ RS-485 Tx/Rx
4	N/C
5	N/C
6	- RS-485 Tx/Rx
7	+14.4V RCP
8	Phantom Power

NK-SCP/A DB-9 Pinouts

Figure 17.15 shows the DB-9 connector port on the NK-SCP/A.

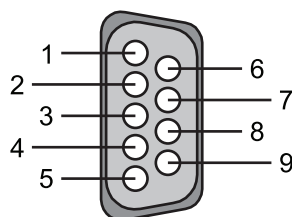

Figure 17.15 NK-SCP/A DB-9 Male External View Connector — Pinout Assignments

Table 17.4 NK/SCP/A DB-9 Pinout Assignments

Pin	Signal
1	N/C
2	Tx
3	Rx
4	N/C
5	GND
6	N/C
7	N/C
8	N/C
9	N/C

NK-SCP/K2 DB-9 Pinouts

Figure 17.16 shows the DB-9 connector port for the NK-SCP/K2.

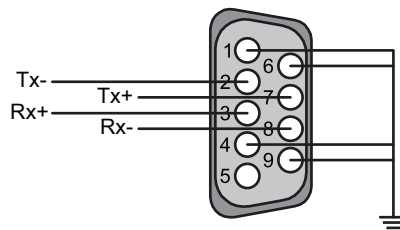

Figure 17.16 NK-SCP/K2 DB-9 Male External View Connector — Pinout Assignments

Technical Specifications

This chapter provides technical information for NK Series. Note that specifications are subject to change without notice.

NK-16, NK-32, and NK-64 Routers

NK-S, NK-MD, and NK-3G Series

Table 18.1 Inputs

Category	SD	MD	3G
Connection	75Ω BNC	75Ω BNC	75 Ω BNC
Return Loss	> 22dB	> 17dB	>15dB, 5MHz to 15GHz >10dB 1.5GHz to 3.0GHz
Cable EQ	Up to 350m Belden 8281	Up to 100m Belden 8281	Up to 80m Belden 1694

Table 18.2 Outputs

Category	SD	MD	3G
Connection	75Ω BNC	75Ω BNC	75Ω BNC
Clocking	Non-reclocking	Non-reclocking	Reclocking on all output automatic at SMPTE 259M, 292M, 424M, and DVB-ASI
Return Loss	> 22dB	15dB	15dB 5MHz to 15GHz 10dB 1.5GHz to 3.0GHz
Level	800mV p-p	800mV p-p	800mV p-p

Table 18.3 Performance

Category	SD	MD	3G
Jitter	< 370ps (.09UI)	< 0.2UI	< 0.2UI to 1.5GHz <0.3UI to 3.0GHz
Data Rates	143Mb/s to 540Mb/s	143Mb/s to 1.485Gb/s	143Mb/s to 2.97Gb/s
Overshoot	< 10%	< 10%	<10%
Rise/Fall Time	700ps (typical)	Selectable SD/HD rise time via on-board DIP switches. 700ps (typical SD) 120ps (typical HD)	Automatic at SMPTE 259M, 292M, 424M, and DVB-ASI

Table 18.4 General

Category	SD	MD	3G
Partitioning	Up to 8 partitions with independent level assignment	Up to 8 partitions with independent level assignment	Up to 8 partitions with independent level assignment
Configuration	Phoenix or web browser via NK-IPS	Phoenix or web browser via NK-IPS	Phoenix or web browser via NK-IPS
Dimensions	1RU x 64mm deep (NK-S16 and NK-S164) 2RU x 64mm deep (NK-S34)	1RU x 64mm deep (NK-MD16 and NK-MD164) 2RU x 64mm deep (NK-MD34)	1RU x 64mm deep (NK-MD16 and NK-MD164) 2RU x 64mm deep (NK-MD34)
Power Consumption	10.5W (NK-S16, NK-S164) 30W (NK-S34)	10.5W (NK-MD16, NK-MD164) 30W (NK-MD34)	8.5W (NK-3G164) 13W (NK-3G16) 27W (NK-3G34)
Power Supply	+15V DC	+15V DC	+15V DC

AES/EBU Digital Audio Level Routers**Table 18.5 Inputs**

Category	Specification
Connection	75Ω BNC (D16/75 and D32/75) 110Ω DB-25 connectors (D16/110 and D32/110)
Level	1V p-p (75 Ω) 2-7V p-p (110 Ω)
Cable EQ	Up to 300m RG59/U

Table 18.6 Outputs

Category	Specification
Connection	75Ω BNC (D16/75 and D32/75) 110Ω DB-25 connectors (D16/110 and D32/110)
Clocking	Non-reclocking
Level	1V p-p (75 Ω) 3-4V p-p (110 Ω)

Table 18.7 Performance

Category	Specification
Jitter	< 2ns (.013UI)
Data Rates	32kHz to 192kHz

Table 18.8 General

Category	Specification
Partitioning	Up to 8 partitions with independent level assignment
Configuration	Phoenix or web browser via NK-IPS

Table 18.8 General

Category	Specification
Dimensions	1RU x 64mm deep (NK-D16 and NK-D164) 2RU x 64mm deep (NK-D32)
Power Consumption	7.5W (NK-D16 and NK-D164) 10.5W (NK-D32)
Power Supply	+15V DC

Analog Video Level Routers

Table 18.9 Inputs

Category	Specification
Connection	75Ω BNC
Nominal Input Level	1V p-p
Maximum Input Level	2V p-p
Clamping Method	AC coupled with sync tip Clamping
Clamping DC Adjustment	Between blanking = 0V and sync tip = 0V
Return Loss	44dB

Table 18.10 Outputs

Category	Specification
Connection	75Ω BNC
Level	1V p-p
Coupling	DC coupled
Return Loss	30dB

Table 18.11 Performance

Category	Specification
Differential Gain	0.05 deg
Differential Phase	0.05 deg
Frequency Response	30MHz, ±0.1dB 60Mhz, ±1dB 230Mhz, -3dB
Noise	-76dB peak
Crosstalk	-60dB, 5MHz
Propagation Delay	2ns
Timing Scatter	0.5 deg fsc

Table 18.12 General

Category	Specification
Partitioning	Up to 8 partitions with independent level assignment
Configuration	Phoenix or web browser via NK-IPS

Table 18.12 General

Category	Specification
Dimensions	1RU x 64mm deep (NK-V16-HQ and NK-V164-HQ) 2RU x 64mm deep (NK-V32-HQ)
Power Consumption	8W (NK-V16-HQ and NK-V164-HQ) 20W (NK-V32-HQ)
Power Supply	+/-15V DC

Stereo Analog Audio Level

Table 18.13 Inputs

Category	Specification
Connection	DB-25 Female on chassis (8 audio channels)
Connection Type	Balanced active differential
Input Z	24K Ω
Nominal Input Level	+4dBu or -10dBu (selectable via solder links)
Maximum Input Level	+24dBu
CMRR	60dB

Table 18.14 Outputs

Category	Specification
Connection	DB-25 Female on chassis (8 audio channels)
Connection Type	Balanced active differential
Output Z	50 Ω differential
Nominal Output Level	+4dBu or -10dBu (selectable via solder links)
Maximum Output Level	+24dBu

Table 18.15 Performance

Category	Specification
Frequency Response	± 0.1 dB, 20Hz to 20kHz -3dB, 100kHz
Distortion	.005%
Noise	-90dB below +4dBu
Crosstalk	-86dB below +4dBu

Table 18.16 General

Category	Specification
Partitioning	Up to 8 partitions with independent level assignment
Configuration	Phoenix or web browser via NK-IPS
Dimensions	1 RU x 64 mm deep (NK-A16-HQ and NK-A164-HQ) 2 RU x 64 mm deep (NK-A32-HQ)

Table 18.16 General

Category	Specification
Power Consumption	13.5W (NK-A16-HQ and NK-A164-HQ) 33W (NK-A32-HQ)
Power Supply	±15V DC

Machine Control/Data Level

Table 18.17 Inputs

Category	Specification
Connection	DB-9 Female on chassis
Electrical Standard	RS-422
Direction	Auto port direction switching

Table 18.18 Performance

Category	Specification
Data Rates	Up to 115.2kBd

Table 18.19 General

Category	Specification
Configuration	Phoenix or web browser via NK-IPS
Dimensions	1RU x 64mm deep (NK-M16) 2RU x 64mm deep (NK-M32)
Power Consumption	10.5W (NK-M16) 18W (NK-M32)
Power Supply	+15V DC

NK-64 and NK-72 Routers

NK-S, NK-MD, and NK-3G Series

Table 18.20 Inputs

Category	SD	MD	3G
Connection	75Ω BNC	75Ω BNC	75Ω BNC
Return Loss	>22dB	> 17 dB	> 17dB
Cable EQ	Up to 350m Belden 8281	Up to 100m Belden 8281	Up to 100m Belden 8281

Table 18.21 Outputs

Category	SD	MD	3G
Connection	75Ω BNC	75Ω BNC	75Ω BNC
Clocking	Non-relocking	Non-reclocking	Reclocking

Table 18.21 Outputs

Category	SD	MD	3G
Return Loss	>22dB	15 dB	15dB
Level	800mV p-p	800mV p-p	800mV p-p

Table 18.22 Performance

Category	SD	MD	3G
Jitter	< 370ps (.09UI)	< 0.2UI	< 0.2UI
Data Rates	143Mb/s to 540Mb/s	143Mb/s to 1.485Gb/s	143Mb/s to 3Gb/s
Overshoot	< 10%	< 10%	< 10%
Rise Time	–	Selectable SD/HD rise time via on-board DIP switches	Auto SD/HD

Table 18.23 General

Category	SD	MD	3G
Partitioning	Up to 8 partitions with independent level assignment	Up to 8 partitions with independent level assignment	Up to 8 partitions with independent level assignment
Configuration	Phoenix or web browser via NK-IPS	Phoenix or web browser via NK-IPS	Phoenix or web browser via NK-IPS
Dimensions	3RU x 120mm deep	3RU x 120mm deep	3RU x 120mm deep
Power Supply	+15V DC	+15V DC	+15V DC

AES/EBU Digital Audio Level

Table 18.24 Inputs

Category	Specification
Connection	75 Ω BNC (D64/75) 110 Ω DB-25 connectors (D64/110)
Level	1V p-p (75 Ω) 2-7V p-p (110 Ω)
Cable EQ	Up to 300m RG59/U

Table 18.25 Outputs

Category	Specification
Connection	75Ω BNC (D64/75) 110Ω DB-25 connectors (D64/110)
Clocking	Non-reclocking
Level	1V p-p (75 Ω) 3-4V p-p (110 Ω)

Table 18.26 Performance

Category	Specification
Jitter	< 2ns (0.13UI)
Data Rates	32kHz to 192kHz

Table 18.27 General

Category	Specification
Partitioning	Up to 8 partitions with independent level assignment
Configuration	Phoenix or web browser via NK-IPS
Dimensions	3RU x 120mm deep
Power Supply	+15V DC

Stereo Analog Audio Level

Table 18.28 Inputs

Category	Specification
Connection	DB-25 Female on chassis (8 audio channels)
Connection Type	Balanced active differential
Input Z	24K Ω
Nominal Input Level	+4dBu or -10dBu (selectable via solder links)
Maximum Input Level	+25dBu
CMRR	60dB

Table 18.29 Outputs

Category	Specification
Connection	DB-25 Female on chassis (8 audio channels)
Connection Type	Balanced active differential
Output Z	50 Ω
Nominal Input Level	+4dBu or -10dBu (selectable via solder links)
Maximum Input Level	+24dBu

Table 18.30 Performance

Category	Specification
THD (Typical)	0.0025% @ 1kHz, +4dB
THD + Noise (Typical)	0.0094% @ 1kHz, +4dB
Level Deviation	\pm 0.02dB
Channel Separation	-80dB maximum

Table 18.31 General

Category	Specification
Partitioning	Up to 8 partitions with independent level assignment
Configuration	Phoenix or web browser via NK-IPS
Dimensions	3RU x 120mm deep
Power Supply	\pm 15V DC

Control Panels

RCP-NK1

Table 18.32 Keys

Category	Specification
Number	40 backlit keys

Table 18.33 General

Category	Specification
Configuration	Phoenix or web browser via NK-IPS
Dimensions	1RU x 25mm deep
Power Consumption	1.5W
Power Supply	+15V DC phantom power

Glossary

The following terms are used throughout this guide:

Breakaway — an act of performing a switch on only some of the signals grouped together under one label.

Connection Point — setting to define a communication connection between NK Series and a device in the routing system.

Crosspoint — a switch within a matrix. For example, the connection of signal IN 1 to OUT 1 requires one crosspoint.

Destination — a signal output from the routing system.

Key — refers to a physical button on the remote control panel.

Label — text that is used by control displays to identify a signal as an input or output.

Level — refers to a section of a routing system. For example, a video router would be one level and an audio router would be a second level.

Macro — a recorded sequence of Remote Control Panel operations (local to the panel).

Map — a table that defines the allocation of names (labels) to router input and output sockets.

Matrix — the part of the routing system that performs the actual signal switching tasks.

Partition — matrices may be partitioned to behave as smaller independent matrices. This can be useful in a small setup without an NK Series.

Remote Control Panel (RCP) — a physical hardware panel of buttons that is used to control the routing system.

Salvo — a system wide sequence of matrix control operations and crosspoint actions.

Source — a signal input to the routing system.

T-Bus — the Ross Video proprietary routing communication method via a defined physical interface.

Virtual Label — a name for a group of routing system inputs or outputs.

Virtual Routing — the action of switching a group of otherwise unrelated signals via a common label (name).

