

NORMAN S. WRIGHT Co.
MANUFACTURERS REPRESENTATIVES



PHOENIX	(602) 275-4467
TUCSON	(520) 790-4490
EL PASO	(915) 772-9381
ALBUQUERQUE	(505) 345-8811

**HEATING
VENTILATING
AIR CONDITIONING
EQUIPMENT**

The History of Norman S. Wright & Co.

Norman S. Wright Sr. started the company in 1906 in San Francisco as a supplier of ventilation equipment to the marine industry. The Norman S. Wright & Co. survived through earthquakes, The Great Depression, and two World Wars continuing to serve the marine and naval industries. In 1933 Norman Wright Jr. joined the company as the company was expanding and entering the heating and ventilating field by representing several HVAC products. After serving in the Merchant Marines during WWII, Norman Wright Jr. returned to become president of the company. He strengthened the company's HVAC efforts by establishing 14 offices throughout the West from San Diego, California to Anchorage, Alaska.

In 1952, Norman Wright Jr. hired Bob Langmade to open an office in Phoenix and Norman S. Wright & Co. SW was formed. In order to serve the southwest, offices and warehouses in Tucson, Albuquerque, and El Paso were established. In the 1970's, Norman Wright Jr. retired and Norman S. Wright & Co. SW became a separate organization from the original company in San Francisco.

In 1988, Dianne Langmade joined the company after serving active duty in the USAF. Dianne is currently the president of Norman S Wright Co. Manufacturers Representative. She shares management and ownership responsibilities with David Gallegos in the El Paso office, Tom Watters in Albuquerque, Tim Murphy in Tucson, and Bob Schmidt in Phoenix. Today, Norman S. Wright Co. has over 60 employees and over 50,000 sq. ft. of warehouse space to meet our customer's needs.

We represent the best manufacturers of HVAC equipment, covering a broad range of products. Our people have the dedication, product knowledge, and experience to assist you. The items listed in this catalog are based on meeting your needs, the customer. Please let us know if there is anything we need to add to our stock or services to make your job easier. All of us are dedicated to meeting the needs of our customers and exceeding your expectations.

We thank you for your business and look forward to supporting you in the years to come.

We want to be your supplier of choice.



MANUFACTURERS REPRESENTED / DISTRIBUTED

Advance Controls, Inc.	Motor Starters, Disconnects, Inverter Bypass Switches	http://www.acicontrols.com/
Air Chem Systems	FRP Fiberglass Scrubbers & Duct	http://airchemsystems.com
A Q C	Source Capture, Industrial Fume & Dust Collection	http://www.aqcdust.com/
ATCO Rubber Products Inc.	Flexible Duct Systems	http://www.atcoflex.com/
Brasch Manufacturing	Electric Duct Heaters	http://www.braschmfg.com
Broan	Ceiling Fans	http://www.broan.com/
Captive Aire	Kitchen Hoods, Fans & Make-Up Air Units	https://www.captiveaire.com/
Carel Systems	Humidifiers	http://carelusa.com/
Car-Mon	Vehicle Carbon Monoxide Exhaust Systems	http://car-mon.com/
Commercial Acoustics	Sound Attenuators / Acoustical Sound Panels	http://www.mfmca.com/
Dadanco	Chilled Beams & Infusers	http://www.dadanco.com/
Data Aire	Computer Room Air Conditioning Units	http://www.dataaire.com/
Energy Savers	CELdek Media / Evaporative Coolers	http://www.nrgsvr.com/
Fabric Air	U.L. Fabric Duct	http://www.fabricair.com/
Fantech	Fans & ERV Ventilation products	http://www.fantech.net/
Filtration Group	Air Filtration Products	http://filtrationgroup.com/
Flanders	Filters, HEPA's, Housings, Bag-In / Bag-Out	http://flanderscorp.com/
Hastings HVAC	Custom HVAC MUA & Heating Equipment	http://www.hastingshvac.com/
Hays	Flow Control Valve & Hose Kits	http://www.haysfluidcontrols.com
Honeywell Analytics/Vulcain	Gas Detection	http://www.honeywellanalytics.com
Kees Inc.	Specialty Items, Security Grilles	http://kees.com/
Kelly Fans/4Front	High Volume Low Speed Fans	http://www.4frontes.com
Lindab	Low-Leakage Spiral Pipe	http://www.lindab.com
Mallory Metals	Sun West HVAC Custom AHU and Evap Coolers	http://mallorymetal.com/
Mars Sales	Air Curtains	http://www.marsair.com/
Metal Form	Metal Fabrication / Louvers / Dampers	http://www.mfmca.com/
Milcor	Access Doors	http://www.milcorinc.com/
Pate Company	Curbs & Pipe Seals	http://www.patecurbs.com/
Phoenix Evap Cooler	Evaporative Coolers	http://www.evapcool.com/
Pottorff	Fire / Smoke / Manual Dampers / Louvers	http://www.pottorff-hvac.com/
Powered Aire	Air Curtains	http://www.poweredaire.com/
Q-Mark	Radiant Heat Panels / Unit Heaters	http://www.marlymep.com/en/qmark/
Rectorseal	Condensate Pumps & Accessories, R410A Tools	http://www.rectorseal.com
Redd-i	Electric Duct Heaters	http://www.tpicorp.com/
Reversomatic	Dryer Booster Fans & Ceiling Fans w/ Fire Dampers	http://www.reversomatic.com/
Reznor	Unit Heaters & Roof Top MUA Units	http://www.rezspec.com
Roberts-Gordon	Infrared Gas Heating Systems	http://www.rg-inc.com/
Roof Products Inc.	Roof Curbs and Platforms	http://rpcurbs.com/
Samsung	Variable Refrigerant Flow Systems	http://samsungdvm-s.com/
Samsung Mini Splits	Ductless One-to-One & Multi-Zone Systems	http://www.quietside.com/samsung.html
Seiho	Air Distribution Specialty Architectural Registers	http://www.seiho.com/
Selkirk	Boiler Flue, Generator Exhaust, NO-Chase Grease Duct	http://www.selkirkcorp.com/
Sternvent	Dust Collectors	http://sternvent.com/
Thermafex	Flexible Duct Products	http://www.thermafex.net/
Thermal Products	VAV Diffusers	http://www.thermalproducts.com
Titus Products	Air Devices, Displacement, Chilled Beam, Fan Coils & VAV	http://www.titus-hvac.com/
Twin City Flan & Blower	Fans, Blowers, Axial & Fiberglass	http://www.tcf.com/
Vibration Management	Vibration Isolation	http://www.vimco.biz
Ward Industries	4-Bolt Duct Connector	http://www.hartandcooleyinc.com/
Yellow Jacket	R410A Flaring Tools	http://www.yellowjacket.com
Young Regulator	Damper Controls, Concealed Regulators, VAV	http://www.youngregulator.com

Telephone: (602) 275-4467
(520) 790-4490

Fax: (602) 275-6516
(520) 790-4673

Order Fax: (602) 275-1637
Verify current pricing at www.nsvhvacz.com

TABLE OF CONTENTS

SECTION 1 1

SUPPLY / RETURN / VAV BOXES / ACCESSORIES

TMR – Round 2
 TMS – Lay-In, Square Face 3
 OMNI –Lay-In, Plaque 3
 250 – Curved Blade 4
 TDC – Louvered Face 5
 PCS – Perforated 6
 PAS – Perforated 6
 ML – Linear Diffusers 7
 SD – Plenum Diffusers and ML Plenums 8
 VFS – Vari-Flow Diffuser 9
 300RS – Double Deflection 10
 350-RL – Return 11
 50F – Eggcrate 12
 PAR – Perforated 13
 PXP – Perforated 13
 350-RLF – Filter Grille 14
 ESV-3000 15
 Pneumatic Controllers 15
 2-Row Coils 15
 TRM Surface Mount Frame 16
 Touch-Up Paint 16

SECTION 2 17

DAMPERS / FIRE SAFETY / DUCT ACCESS DOORS

AG-15, AG-95 – Square Opposed Blade Dampers 18
 AG-75, D-100 - Round Radial Dampers 18
 270 - Young Concealed Regulator 19
 Combination Fire / Smoke Dampers 20
 Fire Dampers 21
 Ceiling Radiation Dampers 22
 Thermal Blankets 22
 Smoke Detector 23
 Sampling Tube 23
 Remote Alarms 23
 Round Spiral Duct Access Doors 24
 Sheet Metal Duct Access Doors 24
 Fire Rated Access Doors 24

SECTION 3 25

FLEX & ACCESSORIES / SHEET METAL

Insulated Flex 26
 Clamps 26
 Square to Round Adaptors 27
 Reducers / Start Collars 27
 Blast Gates / Steel Access Doors 28
 Cylinder Lock 28
 Vibration Isolation 29

TABLE OF CONTENTS

SECTION 4.....31

FANS & ACCESSORIES

Ceiling Exhaust 32
 Speed Controllers / Broan Grilles..... 33
 Conversion Kits/ Transitions 33
 Isolators..... 33
 Wall Caps 34
 Roof Caps..... 34
 Roof Exhaust 35
 Roof Curbs 38

SECTION 5.....39

SAMSUNG

Heat Pumps / Mini Splits..... 40
 Four Way Ceiling Cassettes 41
 Multi Zone Units 42
 Accessories / Line Sets 43
 Condensate Pumps 44
 Yellow Jacket Specialty Tools..... 44

SECTION 6.....45

AIR FILTRATION / CEL PAD

Standard Pleated 46
 High Capacity Pleated 47
 Merv 11 Pleated 47
 Mini-Pleat..... 48
 Rigid Cell 48
 Synthetic Bags 49
 ASHRAE..... 49
 V-Bank..... 49
 CelPad for Evap Cooler..... 50
 Paint Arrestors 50

SECTION 6.....51

GAS DETECTION

Honeywell Analytics Gas Detection 52



Page 2



Page 3



Page 3



Page 4

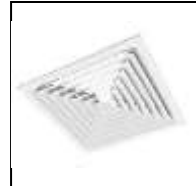

Page 5

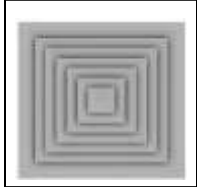

Page 5



Page 6

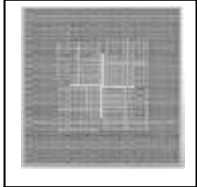

Page 6



Page 7

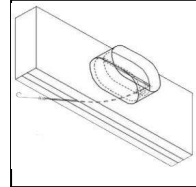

Page 7



Page 8



Page 9



Page 10



Page 11



Page 12



Page 13



Page 14



Page 15



Page 15



Page 16



Page 16



Page 18



Page 18

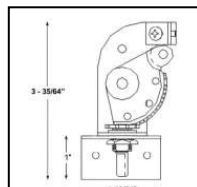

Page 19

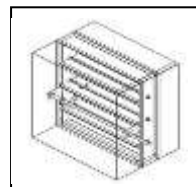

Page 20

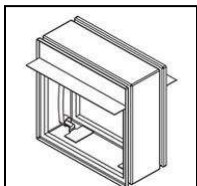

Page 21

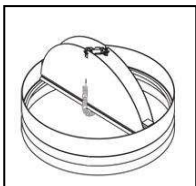

Page 23



Page 23



Page 24



Page 24

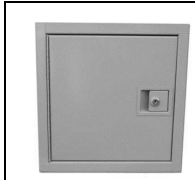

Page 24



Page 26



Page 26



Page 26



Page 27



Page 27



Page 27



Page 28



Page 28



Page 28



Page 29

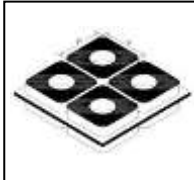

Page 30



Page 32



Page 33



Page 34



Page 33



Page 36



Page 37



Page 38



Page 40



Page 41 -42



Page 44



Page 44



Page 46 - 47



Page 48



Page 48



Page 49



Page 50

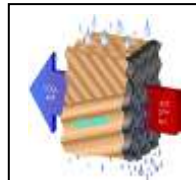

Page 50



Page 52



TERMS AND CONDITIONS

GENERAL:

Acceptance of orders and shipment of material thereunder is subject to the approval of the credit department. There shall be no liability on the part of the Norman S. Wright Co. for any delay in the shipment of material, or any other delay caused by weather, strikes, fires, government regulations or any other causes beyond our control. Seller will not accept, nor will be bound by any order containing a penalty clause and/or retention clause. Shipments may be made on open account with approval of seller; otherwise cash, COD, or slight draft bill of lading. Buyer is not entitled to take ownership of material unless that material is paid in full.

DELIVERY SCHEDULE:

Monday and Thursday – West Valley
Tuesday and Friday – East Valley
Wednesday – Tucson

RUSH DELIVERY:

If a shipment must be made on a day other than our scheduled delivery day listed above, we will try to accommodate the delivery to the best of our ability. However, if an independent shipping or delivery company is required to make the delivery, these charges will be added to your invoice.

CONFIRMATION:

Norman S. Wright Co. will not accept responsibility for errors of any kind on verbal orders unless these orders are followed up with a written confirmation. Orders for non-stock items and special made-to-order items will not be sent in to the factory until a written confirmation is received.

CANCELLATION & RETURNS:

Non-stock items, special made-to-order or damaged material are not returnable for credit. Return of stock items will not be accepted for return without a completed Warehouse Return Goods Authorization. The customer needs to provide NSW with your purchase order number and/or invoice number to be eligible for credit. All material shall be returned in new and unused condition, return freight prepaid, and are subject to a 15% restocking charge.

WARRANTIES:

Norman S. Wright Co. extends to the buyer the manufacturer's standard warranty, a copy of which is available upon request. The express warranty contained herein is in lieu of all their warranties, express or implied, including any warranty of merchantability or fitness for a particular purpose. By accepting this shipment, buyer acknowledges that seller shall not be liable for special or consequential damages of any kind whatsoever. Manufacturer's standard warranties do not include labor warranty.

BACKCHARGES:

No back-charge will be accepted without prior written approval

NOTICE:

All products and information listed in this catalog are subject to change without notice. Purchaser must review current manufacturer's catalog data and installation instructions prior to purchase of products listed herein. Catalog data is available upon request. Most current pricing will be found at our website, www.nshvacaz.com

MINIMUM ORDER DELIVERY CHARGE:

For any NSW delivery there will be a \$25 minimum delivery and handling charge for any order, or group of orders, totally less than \$100.00.

Telephone: (602) 275-4467
(520) 790-4490

Fax: (602) 275-6516
(520) 790-4673

Order Fax: (602) 275-1637
Verify current pricing at www.nshvacaz.com

SECTION 1

SUPPLY / RETURN / VAV BOXES / ACCESSORIES

SUPPLY

TMR – Round.....2
TMS – Lay-In, Square Face3
OMNI – Lay-in, Plaque.....3
250 – Curved Blade.....4
TDC – Louvered Face5
PCS – Perforated.....6
PAS – Perforated.....6
ML – Linear Diffusers.....7
SD – Plenum Diffusers and ML Plenums.....8
VFS – Vari-Flow Diffuser.....9
300RS – Double Deflection 10

RETURN

350-RL – Return..... 11
50F – Eggcrate 12
PAR – Perforated..... 13
PXP – Perforated..... 13
350-RLF – Filter Grille 14

VAV BOXES

ESV-3000 15
Pneumatic Controllers 15
2-Row Water Coils..... 15

ACCESSORIES

TRM Surface Mount Frame 16
Touch-Up Paint 16

TITUS MODEL TMR

Horizontal discharge pattern. 2 Position settings, Steel, White finish.

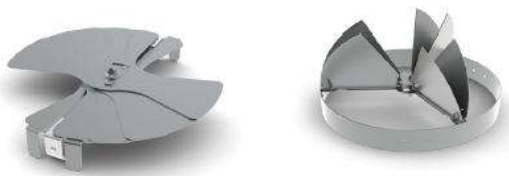

Stock #	Neck Size	CFM @ NC30	List Price
TMR6	6"	220	\$66.00
TMR8	8"	350	\$70.00
TMR10	10"	545	\$78.00
TMR12	12"	750	\$88.00
TMR14	14"	955	\$100.00
TMR16	16"	1200	\$132.00

Optional Damper		
Stock #	Size	List Price
D1006	6"	\$14.00
D1008	8"	\$16.00
D10010	10"	\$16.00
D10012	12"	\$17.00
AG7514	14"	\$34.00
AG7516	16"	\$40.00

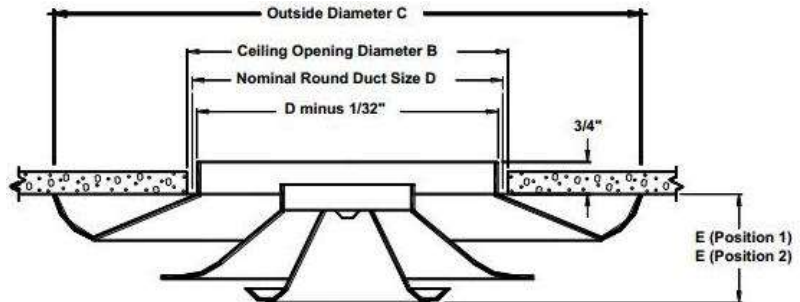
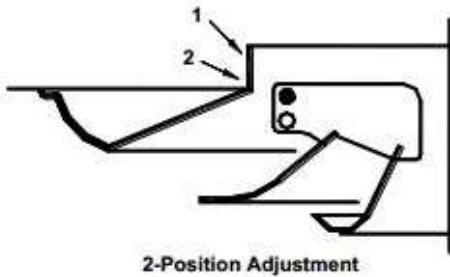

Nominal Round Duct size D	B	C	E (Pos. 1)	E (Pos. 2)
6	6 1/2"	11 1/8"	1 3/4"	1 1/8"
8	8 1/2"	14 3/4"	2 1/8"	1 1/2"
10	10 1/2"	18 1/4"	2 7/8"	2 1/8"
12	12 1/2"	22"	3 1/8"	2 3/8"
14	14 1/2"	26"	3 3/8"	2 5/8"
16	16 1/2"	29"	4"	3 1/4"
18	18 1/2"	32 1/2"	4 3/4"	3 7/8"
20	20 1/2"	36"	5 7/8"	4 7/8"
24	24 1/2"	43 1/4"	7 3/4"	6 5/8"

TITUS MODEL TMS



Lay-In. Steel. White finish. Good for VAV application.

24 X 24 Module			
Stock #	Neck Size	CFM @ NC 30	List Price
TMS36	6"	250	\$50.00
TMS38	8"	400	\$50.00
TMS310	10"	550	\$50.00
TMS312	12"	750	\$50.00
TMS314	14"	950	\$50.00
TMS315	15"	1100	\$50.00

12 X 12 Module			
Stock #	Neck Size	CFM @ NC 30	List Price
TMS361212	6"	200	\$33.00
TMS381212	8"	350	\$33.00

TITUS MODEL OMNI



Lay-in. Steel. White finish. Good for VAV application.

24 x 24 Module			
Stock #	Neck Size	CFM @ NC 30	List Price
OMNI36	6"	250	\$60.00
OMNI38	8"	360	\$60.00
OMNI310	10"	570	\$60.00
OMNI312	12"	770	\$60.00
OMNI314	14"	980	\$60.00

12 x 12 Module			
Stock #	Neck Size	CFM @ NC 30	List Price
OMNI361212	6"	200	\$42.00
OMNI381212	8"	360	\$42.00



Optional Damper			
Stock #	Size	List Price	
D1006	6"	\$14.00	
D1008	8"	\$16.00	
D10010	10"	\$16.00	
D10012	12"	\$17.00	
D10014	14"	\$28.00	
AG7515	15"	\$38.00	



Optional Surface Mount Frame		
Stock #	Size	List Price
PF1212 FRAME	12" X 12"	\$20.00
PF2424 FRAME	24" X 24"	\$26.00

TITUS MODEL 250 Frame 1



Steel ceiling or sidewall diffuser. Adjustable curved blade with mounted AG-15 damper. Surface mount. White finish.

4-Way Pattern			
Stock #	Neck Size	CFM @ NC 30	List Price
250S46	6" X 6"	135	\$41.00
250S48	8" X 8"	210	\$44.00
250S410	10" X 10"	350	\$53.00
250S412	12" X 12"	470	\$60.00
250S414	14" X 14"	625	\$74.00
250S416	16" X 16"	750	\$85.00
250S418	18" X 18"	1000	\$110.00
250S420	20" X 20"	1200	\$120.00

Border Type 1 (Surface Mount)*

Dimensions are in inches.

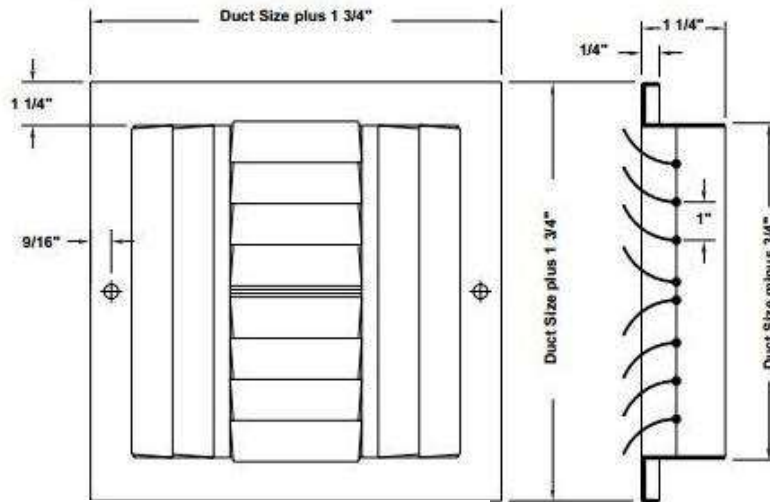

Model AG-15 Opposed Blade Damper

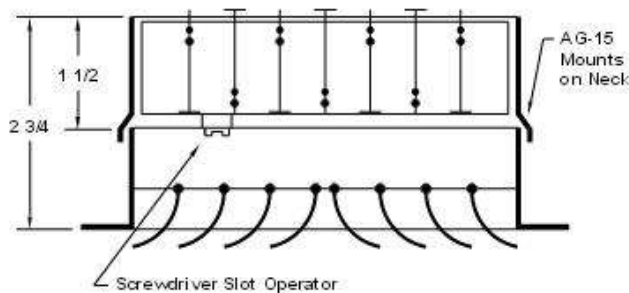

Note: Total depth is 3" with damper open

Telephone: (602) 275-4467
(520) 790-4490

Fax: (602) 275-6516
(520) 790-4673

Order Fax: (602) 275-1637
Verify current pricing at www.nsw HVAC.com

TITUS MODEL TDC Frame 3

Lay-in. Louvered face. 24 X 24 panel. Round neck. 4-Way



Border Type 3 (Lay-In)

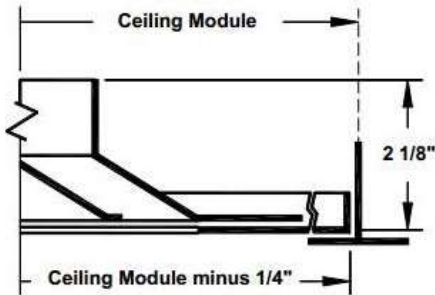

Stock #	Neck Size	CFM @ NC30	List Price
4TDC36R6	6" X 6" / 6"	170	\$60.00
4TDC39R8	9" X 9" / 8"	300	\$66.00
4TDC312R10	12" X 12" / 10"	480	\$80.00
4TDC312R12	12" X 12" / 12"	600	\$80.00
4TDC315R14	15" X 15" / 14"	770	\$104.00
4TDC318R16	18" X 18" / 16"	980	\$128.00



D100

Optional Damper		
Stock #	Size	List Price
D1006	6"	\$14.00
D1008	8"	\$16.00
D10010	10"	\$16.00
D10012	12"	\$17.00
D10014	14"	\$28.00
AG7515	15"	\$38.00

TITUS MODEL TDC Frame 6

Surface mount. Louvered face. Square neck. 4-way throw

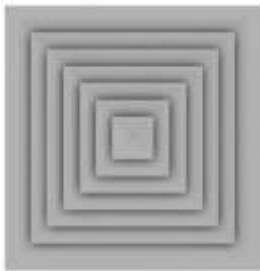

Border Type 6 (Beveled Drop Face)

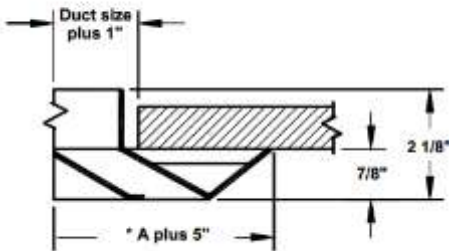

Stock #	Neck Size	CFM @ NC30	List Price
4TDC66	6" X 6"	195	\$30.00
4TDC69	9" X 9"	394	\$37.00
4TDC612	12" X 12"	650	\$50.00
4TDC615	15" X 15"	950	\$66.00
4TDC618	18" X 18"	1300	\$83.00
4TDC621	21" X 21"	1710	\$116.00



AG-95

Optional Damper		
Stock #	Size	List Price
AG956	6" X 6"	\$11.00
AG959	9" X 9"	\$15.00
AG9512	12" X 12"	\$20.00
AG9515	15" X 15"	\$36.00
AG9518	18" X 18"	\$48.00
AG9521	21" X 21"	\$60.00

TITUS MODEL PCS Frame 3



Lay-in. Perforated face. 24 x 24 module. 4-way throw
Curved blade with round neck. White finish.

Round Neck			
Stock #	Neck Size	CFM @ NC30	List Price
APC3FW 06	6"	110	\$52.00
APC3FW 08	8"	190	\$52.00
APC3FW 10	10"	270	\$52.00
APC3FW 12	12"	380	\$52.00
APC3FW 14	14"	460	\$52.00
APC3FW 16	16"	560	\$60.00

Square Neck (Tucson stock)			
Stock #	Neck Size	CFM @ NC30	List Price
APC3FW 0606	6" X 6"	140	\$60.00
APC3FW 0808	8" X 8"	222	\$60.00
APC3FW 1010	10" X 10"	324	\$60.00
APC3FW 1212	12" X 12"	433	\$60.00
APC3FW 1414	14" X 14"	580	\$60.00
APC3FW 1616	16" X 16"	711	\$64.00
APC3FW1818	18" X 18"	820	\$64.00

TITUS MODEL PAS Frame 3

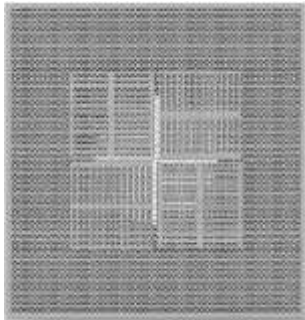

Lay-in. Perforated face, round neck. 24 X 24 module. White

24 X 24 Module			
Stock #	Neck Size	CFM @ NC30	List Price
PAS3F6	6"	180	\$44.00
PAS3F8	8"	265	\$44.00
PAS3F10	10"	350	\$44.00
PAS3F12	12"	470	\$44.00
PAS3F14	14"	575	\$44.00
PASF16	16"	680	\$62.00

Optional Damper - Round		
Stock #	Size	List Price
D1006	6"	\$14.00
D1008	8"	\$16.00
D10010	10"	\$16.00
D10012	12"	\$17.00
D10014	14"	\$28.00
AG7516	16"	\$40.00

Optional Damper - Square		
Stock #	Size	List Price
AG156	6" X 6"	\$14.00
AG158	8" X 8"	\$15.00
AG1510	10" X 10"	\$17.00
AG1512	12" X 12"	\$19.00
AG1514	14" X 14"	\$24.00
AG1516	16" X 16"	\$30.00

Optional Surface Mount Frame		
Stock #	Size	List Price
PF2424 FRAME	24" X 24"	\$26.00

TITUS MODEL ML-39 for surface mount



Linear 2 slot diffusers w/ 1" slots. Endcaps included.

Frame 1A with screw-holes		
Stock #	Size	List Price
ML394	4' long	\$100.00

Frame 2A concealed mount – for surface mount		
Stock #	Size	List Price
ML3942A	4' long	\$120.00

End cap	
Stock #	List Price
MLEB3902	\$10.00

Oval Plenum Damper with Remote Controller and Cable	
Stock #	List Price
800AWO-T-08	\$98.00
800AWO-T-10	\$102.00
800AWO-T-12	\$114.00

- Border Type 2A with
- Flanged Border
 - Concealed Mounting

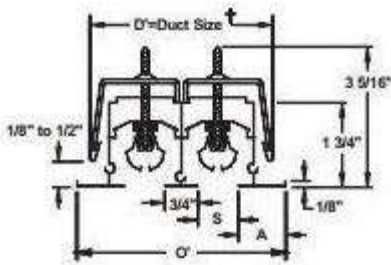

Type	A	O'	D'
1A	1-1/8"	D' + 3/4"	4-1/8"
2A	1-1/8"	D' + 3/4"	4-1/4"

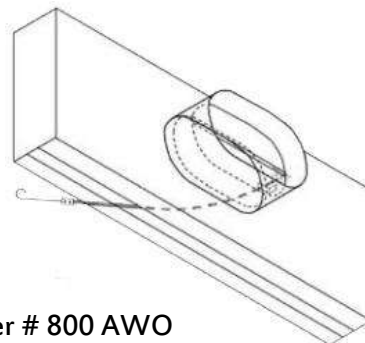

Oval Damper # 800 AWO

TITUS MODEL MPI-39

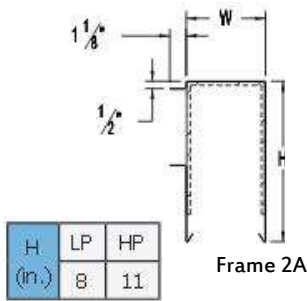

2 Slot insulated plenum for Titus ML linear, 8" high

Frame 1A – Screw Mount			
Stock #	Size	Inlet	List Price
MPI394-8	4' long	8" oval	\$58.00
MPI394	4' long	10" oval	\$58.00
MPI394-12	4' long	12" oval	\$58.00

Frame 2A – Concealed Mount			
Stock #	Size	Inlet	List Price
MPI3942A-8	4' long	8" oval	\$58.00
MPI3942A	4' long	10" oval	\$58.00
MPI3942A-12	4' long	12" oval	\$58.00

PLENUM DIFFUSER TITUS TBDI-80 for lay-in

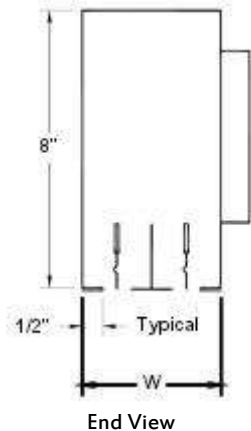

2-Slot insulated plenum diffusers for T-Bar w/1" slots and with center and outside "T". 11 5/8" high

Stock #	Size	Inlet	List Price
SD222T	2' long	8" round	\$120.00
SD422T	4' long	8" round	\$140.00
SD422T10	4' long	10" oval	\$140.00

THERMAL PRODUCTS VARI-FLOW CEILING DIFFUSER



24 X 24 panel. Variable volume cooling –
Constant volume heating.

Round Neck			
Stock #	Neck Size	CFM @ NC30	List Price
VFS8H	8"	250	\$500.00
VFS10H	10"	730	\$500.00
VFS12H	12"	630	\$500.00

Optional Surface Mount Frame		
Stock #	Size	List Price
PF2424 FRAME	24" X 24"	\$26.00

The VARI-FLOW provides individual temperature control for cooling or heating at each diffuser, adjustable from 70 to 78°F. The unit is in cooling mode when the supply duct air temperature is below 70 degree F. The unit is in the heat mode when duct temperature greater than 78°F and provides a constant air volume. The VFS-24 diffuser is totally self-contained and self-powered by a thermal element with automatic change over for heating and cooling.

INSTALLATION INSTRUCTIONS
VFS24 SERIES VARI-FLOW™ DIFFUSER

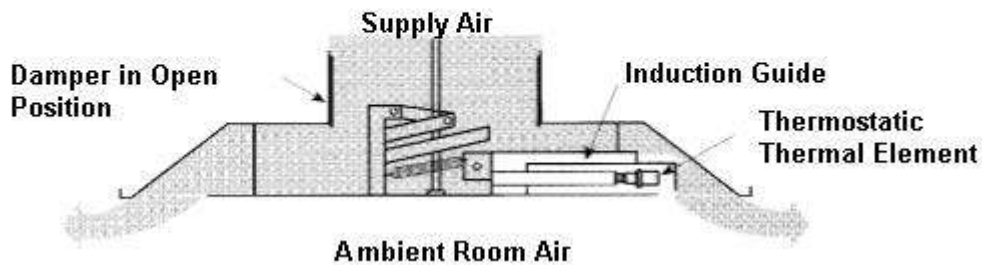

TITUS MODEL 300RS

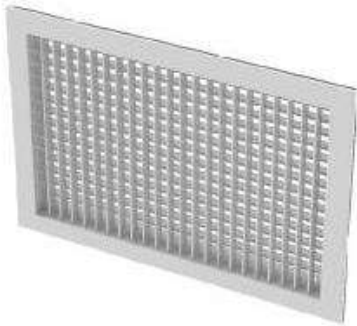

Steel sidewall supply registers. Double deflection. Adjustable. with AG-15 opposed blade damper. Front blades run short dimension. White finish.

Double Deflection Models 300RL/RS - Border Type 1

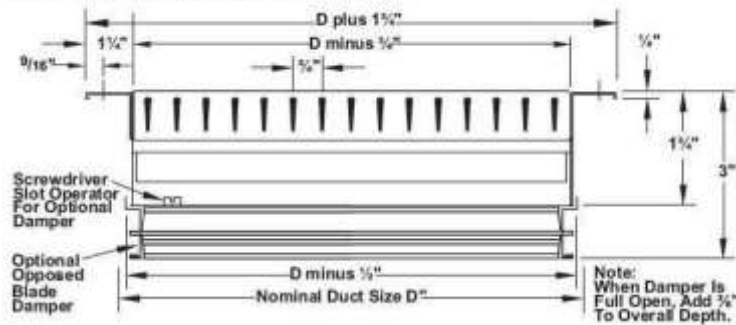

Stock #	Neck Size	List Price
300RS6	6" X 6"	\$36.00
300RS86	8" X 6"	\$37.00
300RS106	10" X 6"	\$40.00
300RS126	12" X 6"	\$42.00
300RS146	14" X 6"	\$46.00
300RS166	16" X 6"	\$50.00
300RS186	18" X 6"	\$55.00
300RS206	20" X 6"	\$59.00
300RS246	24" X 6"	\$65.00
300RS8	8" X 8"	\$36.00
300RS108	10" X 8"	\$41.00
300RS128	12" X 8"	\$46.00
300RS148	14" X 8"	\$50.00
300RS168	16" X 8"	\$55.00
300RS188	18" X 8"	\$60.00
300RS208	20" X 8"	\$63.00
300RS248	24" X 8"	\$72.00
300RS10	10" X 10"	\$45.00
300RS1210	12" X 10"	\$50.00
300RS1410	14" X 10"	\$55.00
300RS1610	16" X 10"	\$60.00
300RS1810	18" X 10"	\$66.00
300RS2010	20" X 10"	\$70.00
300RS2410	24" X 10"	\$100.00
300RS1212	12" X 12"	\$54.00
300RS2412	24" X 12"	\$87.00

TITUS MODEL 350RL



Return Grille. Fixed blade. Steel construction. Blades long dimension. 1-1/4" border. 35° fixed blades on 3/4" centers. White finish.

Surface Mount		
Stock #	Neck Size	List Price
350RL6	6" X 6"	\$11.00
350RL86	8" X 6"	\$14.00
350RL106	10" X 6"	\$18.00
350RL126	12" X 6"	\$22.00
350RL146	14" X 6"	\$26.00
350RL166	16" X 6"	\$20.00
350RL186	18" X 6"	\$24.00
350RL206	20" X 6"	\$24.00
350RL246	24" X 6"	\$30.00
350RL8	8" X 8"	\$18.00
350RL108	10" X 8"	\$18.00
350RL128	12" X 8"	\$22.00
350RL148	14" X 8"	\$26.00
350RL168	16" X 8"	\$20.00
350RL188	18" X 8"	\$25.00
350RL208	20" X 8"	\$24.00
350RL248	24" X 8"	\$28.00

T-Bar Ceiling		
Stock #	Neck Size	List Price
350RLT2210	22" X 10"	\$30.00
350RLT2222	22" X 22"	\$60.00
350RLT4622	46" X 22"	\$112.00

Optional Damper		
Stock #	Size	List Price
AG152210	22" X 10"	\$27.00
AG1522	22" X 22"	\$55.00

Surface Mount		
Stock #	Neck Size	List Price
350RL10	10" X 10"	\$20.00
350RL1210	12" X 10"	\$22.00
350RL1410	14" X 10"	\$26.00
350RL1610	16" X 10"	\$26.00
350RL1810	18" X 10"	\$30.00
350RL2010	20" X 10"	\$28.00
350RL2410	24" X 10"	\$32.00
350RL12	12" X 12"	\$22.00
350RL1412	14" X 12"	\$26.00
350RL1612	16" X 12"	\$28.00
350RL1812	18" X 12"	\$30.00
350RL2012	20" X 12"	\$32.00
350RL2412	24" X 12"	\$34.00
350RL14	14" X 14"	\$28.00
350RL16	16" X 16"	\$34.00
350RL18	18" X 18"	\$42.00
350RL20	20" X 20"	\$50.00
350RL24	24" X 24"	\$70.00
350RL4824	48" X 24"	\$134.00

Optional Damper - Square		
Stock #	Size	List Price
AG156	6" X 6"	\$14.00
AG158	8" X 8"	\$15.00
AG1510	10" X 10"	\$17.00
AG1512	12" X 12"	\$19.00
AG1514	14" X 14"	\$24.00
AG1516	16" X 16"	\$30.00
AG1518	18" X 18"	\$36.00
AG1520	20" X 20"	\$50.00
AG1524	24" X 24"	\$60.00

Telephone: (602) 275-4467
(520) 790-4490

Fax: (602) 275-6516
(520) 790-4673

Order Fax: (602) 275-1637
Verify current pricing at www.nsw HVAC.com

TITUS MODEL 50-F



Eggcrate return grille. 1/2" X 1/2" X 1/2" aluminum construction. White finish.

T-Bar Ceiling		
Stock #	Neck Size	List Price
50F2210	22" X 10"	\$30.00
50F22	22" X 22"	\$51.00
50F4622	46" X 22"	\$111.00

Optional Damper		
Stock #	Size	List Price
AG152210	22" X 10"	\$27.00
AG1522	22" X 22"	\$55.00

Surface Mount		
Stock #	Neck Size	List Price
50F6	6" X 6"	\$14.00
50F8	8" X 8"	\$17.00
50F10	10" X 10"	\$20.00
50F12	12" X 12"	\$23.00
50F14	14" X 14"	\$34.00
50F16	16" X 16"	\$33.00
50F18	18" X 18"	\$40.00
50F20	20" X 20"	\$47.00
50F24	24" X 24"	\$60.00

Optional Damper		
Stock #	Size	List Price
AG156	6" X 6"	\$14.00
AG158	8" X 8"	\$15.00
AG1510	10" X 10"	\$17.00
AG1512	12" X 12"	\$19.00
AG1514	14" X 14"	\$24.00
AG1516	16" X 16"	\$30.00
AG1518	18" X 18"	\$36.00
AG1520	20" X 20"	\$50.00
AG1524	24" X 24"	\$60.00

TITUS MODEL PAR Frame 3

Lay-in return grille. Perforated face. White finish.



Border Type 3 (Lay-In when D=Module size -2)

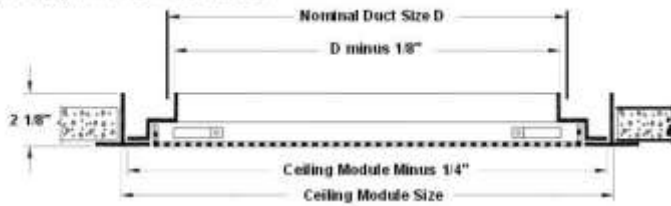

Round Neck / 24 X 24 Module		
Stock #	Neck Size	List Price
PAR3F8	8"	\$44.00
PAR3F10	10"	\$44.00
PAR3F12	12"	\$44.00
PAR3F14	14"	\$44.00
PAR3F16	16"	\$60.00

Square Neck		
Stock #	Neck Size	List Price
PAR3F1022	10" X 22"	\$44.00
PAR3F22	22" X 22"	\$44.00
PAR3F2246	22" X 46"	\$72.00

Optional Surface Mount Frame		
Stock #	Neck Size	List Price
PF24212FRAME	24" X 12"	\$22.00
PF2424FRAME	24" X 24"	\$26.00

TITUS MODEL PXP Frame 3

Perforated panel return. No frame. White finish.

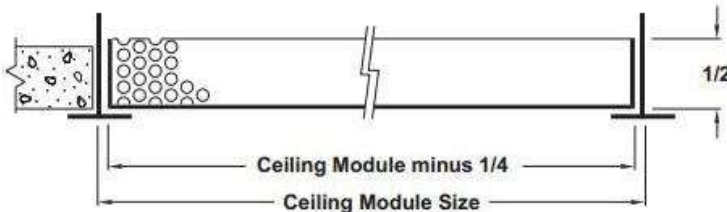
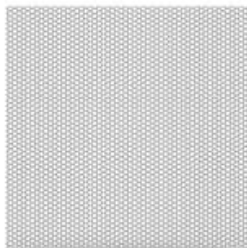

T-Bar Ceiling		
Stock #	Neck Size	List Price
PXP2424	24" X 24"	\$22.00

TITUS MODEL 350-RLF



T-Bar Ceiling (For 1" Filter)			
Stock #	Filter Size	Panel Size	List Price
350RLF1T20	20" X 20" X 1"	24" X 24"	\$120.00
350RLF1T4420	44" X 20" X 1"	48" X 24"	\$220.00

T-Bar Ceiling (For 2" Filter)			
Stock #	Filter Size	Panel Size	List Price
350RLF2T20	20" X 20" X 2"	24" X 24"	\$136.00

Surface Mount (For 1" Filter)		
Stock #	Filter Size	List Price
350RLF12014	20" X 14"	\$72.00
350RLF12016	20" X 16"	\$72.00
350RLF1T20	20" X 20"	\$120.00
350RLF124	24" X 24"	\$118.00
350RLF12514	25" X 14"	\$85.00
350RLF12516	25" X 16"	\$105.00
350RLF12520	25" X 20"	\$115.00
350RLF13020	30" X 20"	\$122.00
350RLF14020	40" X 20"	\$194.00

350RLF1/350RLF2 - Border Type 1(Surface Mount) & Border Type 3 (Lay-in T-Bar)

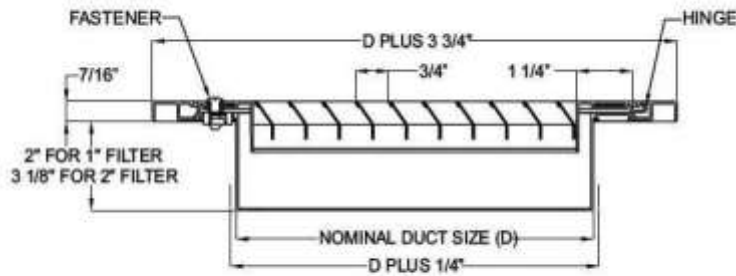

Available sizes (D" x D") are 10 x 8 inches through 48 x 36 inches in 1-inch increments. Odd sizes are available at additional cost.

Surface Mount (For 2" Filter)		
Stock #	Filter Size	List Price
350RLF2T20	20" X 20" X 2"	\$136.00

►► FOR FILTER PRICING – SEE PAGES 46 - 47

TITUS MODEL DESV-3000



Variable volume. Pressure independent.
 1/2" ECO-SHIELD liner (Non-fiberglass), with control enclosure,
 toggle disconnect, and mounted 120-24 volt control transformer.

Bare Boxes for Controls Mounted by Others				
Stock #	Size	CFM Range	Outlet	List Price
ESV-NOCONTROL06	6"	80 - 500	12" X 8"	\$250.00
ESV-NOCONTROL08	8"	145 - 900	12" X 10"	\$288.00
ESV-NOCONTROL10	10"	230 - 1400	14" X 12.5"	\$300.00
ESV-NOCONTROL12	12"	325 - 2000	16" X 15"	\$320.00
ESV-NOCONTROL14	14"	450 - 3000	20" X 17.5"	\$374.00
ESV-NOCONTROL16	16"	580 - 4000	24" X 18"	\$394.00

TITUS PNEUMATIC CONTROLLER



Pneumatic controls direct acting/normally open. Can be changed
 in the field to RA/NC.

Stock #	List Price
II Controller	\$190.00

TITUS 2-ROW WATER COIL



Copper tubing, aluminum fins. Housed in galvanized casing. Coil
 mounts at discharge outlet. Slip and drive duct connection. Coil
 ships loose.

Stock #	Size	Dimensions	Fits	List Price
COIL6	6"	12" X 8"	ESV6	\$140.00
COIL8	8"	12" X 10"	ESV8	\$170.00
COIL10	10"	14" X 12.5"	ESV10	\$220.00
COIL12	12"	16" X 15"	ESV12	\$270.00
COIL14	14"	20" X 17.5"	ESV14	\$330.00
COIL16	16"	24" X 18"	ESV16	\$420.00

TITUS MODEL TRM



Surface mount frame.

Optional Surface Mount Frame		
Stock #	Size	List Price
PF1212FRAME	12" X 12"	\$20.00
PF2412FRAME	24" X 12"	\$22.00
PF2424FRAME	24" X 24"	\$26.00

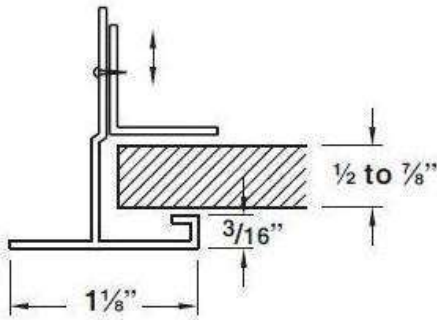

Ceiling Opening View

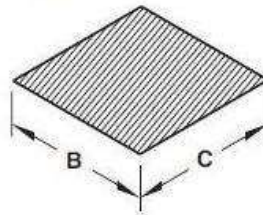

Ceiling Module	Recommended Ceiling Opening	
	B	C
12" X 12"	12-1/2"	12-1/2"
24" X 12"	24-1/2"	12-1/2"
24" X 24"	24-1/2"	24-1/2"

*Check actual dimensions of ceiling opening before installation.

TOUCH UP PAINT



Aerosol can.

Stock #	Color	List Price
PAINT26	White	\$14.00
PAINTBLK	Black	\$14.00

SECTION 2

DAMPERS / FIRE SAFETY / DUCT ACCESS DOORS

DAMPERS

AG-15, AG-95 – Square Opposed Blade Dampers 18
AG-75, D-100 – Round Radial Dampers 18
270 - Young Concealed Regulator 19
Combination Fire / Smoke Dampers 20
Fire Dampers 21
Ceiling Radiation Dampers..... 22

FIRE SAFETY

Thermal Blankets 22
Smoke Detector 23
Sampling Tube 23
Remote Alarms..... 23

DUCT ACCESS DOORS

Round Spiral Duct Access Doors 24
Sheet Metal Duct Access Doors 24
Fire Rated Access Doors..... 24

TITUS MODEL AG-15

Use on 300, 350, 50F series, PCS. Screwdriver operator



Stock #	Size	List Price
AG156	6" X 6"	\$14.00
AG158	8" X 8"	\$15.00
AG1510	10" X 10"	\$17.00
AG1512	12" X 12"	\$19.00
AG1514	14" X 14"	\$24.00
AG1516	16" X 16"	\$30.00
AG1518	18" X 18"	\$36.00
AG1520	20" X 20"	\$50.00
AG1524	24" X 24"	\$60.00

TITUS MODEL AG-95

Use on TDC and perforated diffusers. Operated via lever



Stock #	Size	List Price
AG956	6" X 6"	\$11.00
AG959	9" X 9"	\$15.00
AG9512	12" X 12"	\$20.00
AG9515	15" X 15"	\$36.00
AG9518	18" X 18"	\$49.00
AG9521	21" X 21"	\$60.00

TITUS MODEL AG-75

Gang operated opposed blades. Mounts directly to neck



Stock #	Size	List Price
AG7514	14"	\$36.00
AG7515	15"	\$38.00
AG7516	16"	\$40.00

TITUS MODEL D-100

Gang operated radial blades. Mounts on neck, flush with the top. Useful in flex duct applications.



Stock #	Size	List Price
D1006	6"	\$14.00
D1008	8"	\$16.00
D10010	10"	\$16.00
D10012	12"	\$17.00
D10014	14"	\$28.00

YOUNG REGULATORS

Remote cable controls and hardware. Includes hardware for dampers by others: 1/2" round or 3/8" square shaft.

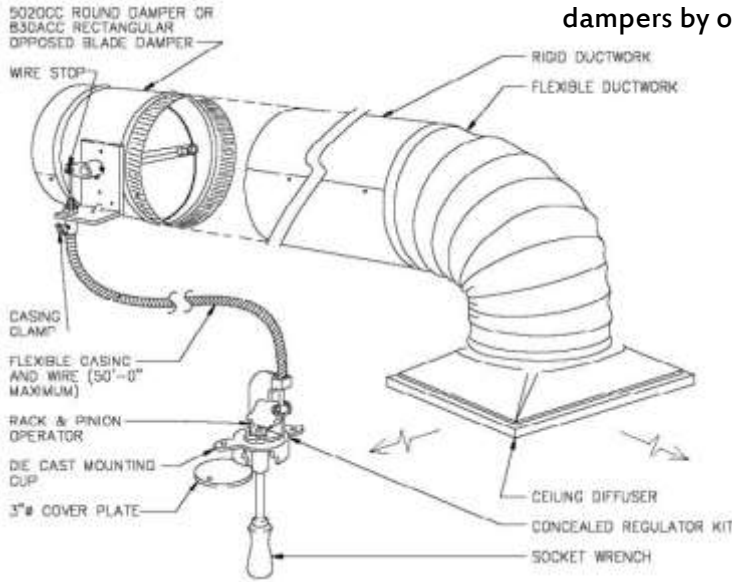

Stock #	Description	List Price
270-275B	Non-Ceiling Mount	\$90.00
270-301B	Ceiling Mount	\$100.00
270-896B	Ceiling Mount	\$110.00
270-275MLB	ML Linear	\$112.00
BCW	Cable and Wire	\$5.00 (ft.)
030	Bowden Wrench	\$30.00

Optional Oval Plenum Damper – Titus ML Plenum	
Stock #	List Price
800AWO-T-08	\$98.00
800AWO-T-10	\$102.00
800AWO-T-12	\$114.00

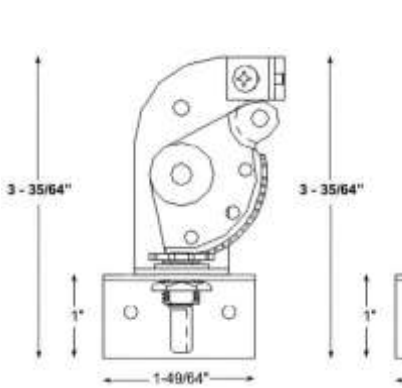

270-275B

Mounts above lay-in ceiling behind grilles, inside plenum

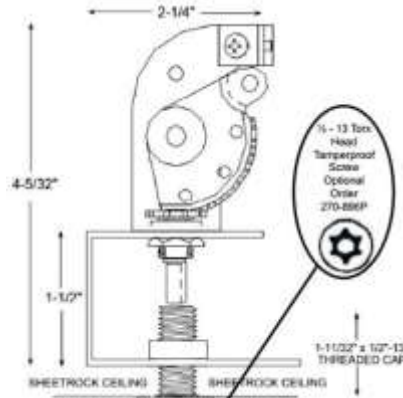

270-896B

Mounts in ceiling

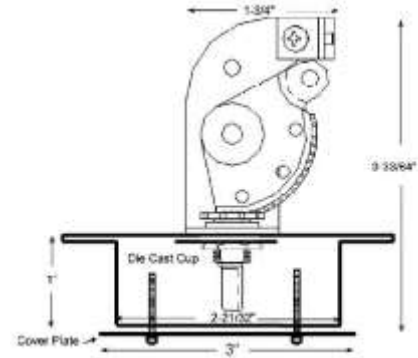

270-301B

Mounts in ceiling

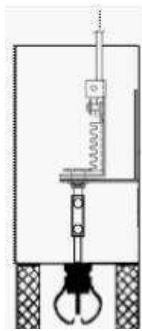

270-275-ML

Extended control shaft for "ML" style linear

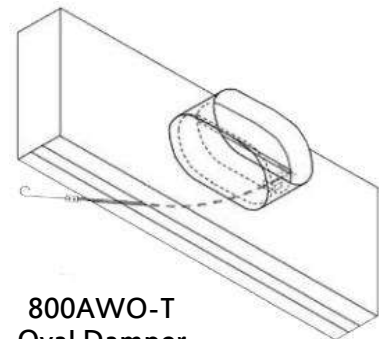

800AWO-T
Oval Damper

POTTORFF COMBINATION FIRE/SMOKE DAMPERS – 5 YEAR WARRANTY

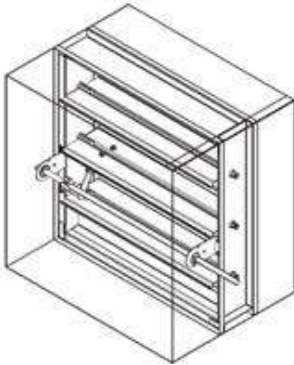

UL Listed – 250°F – 120 Volt Belimo Actuator. Class 2, 20" sleeves, retaining angles shipped loose. DRS-30 remote re-open feature. Qualified to 2000 ft/min and 4 in. wg. Install in vertical walls or partitions, or horizontally in floors or assemblies, with fire resistance ratings up to 2 hours. With picture frame angles shipped loose.

Stock #	Size	List Price
FS2V8	8" X 8"	\$630.00
FS2V10	10" X 10"	\$650.00
FS2V12	12" X 12"	\$660.00
FS2V14	14" X 14"	\$720.00
FS2V16	16" X 16"	\$740.00
FS2V18	18" X 18"	\$800.00
FS2V20	20" X 20"	\$810.00
FS2V24	24" X 24"	\$840.00

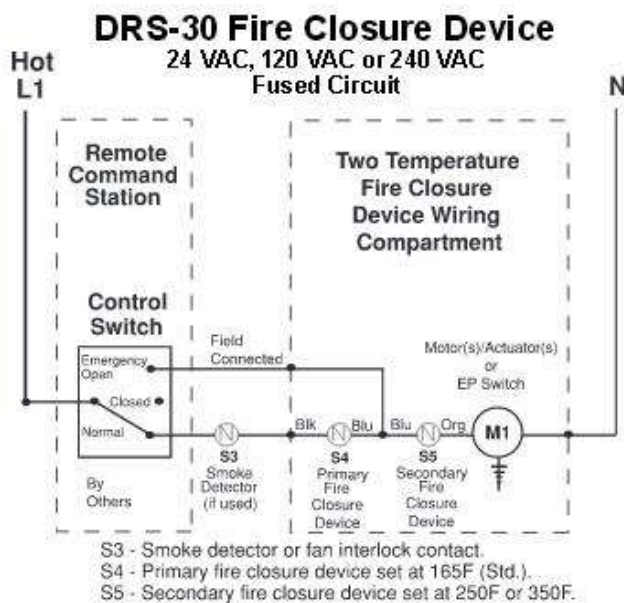

Wiring Diagram

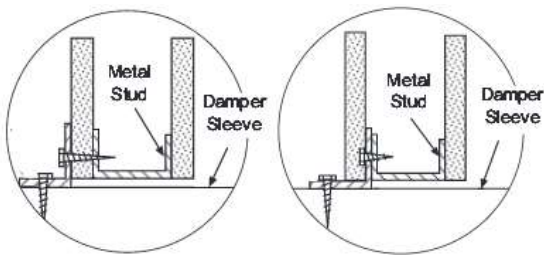

Mounting Angles



POTTORFF DYNAMIC FIRE DAMPERS - OUT OF AIR STREAM - 5 YEAR WARRANTY

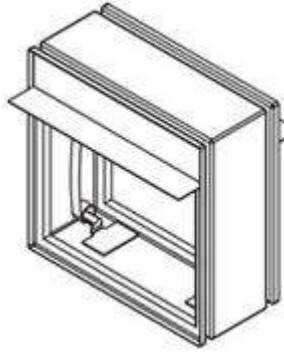

UL Listed – 1.5 Hour Rated. Vertical Installation. Dynamic Qualified to 4,000 ft. / min and 4 in. wg. 12" long sleeve. Type B Blades out of airstream.

Stock #	Size	List Price
VFD-10D-ISB8	8" X 8"	\$80.00
VFD-10D-ISB10	10" X 10"	\$90.00
VFD-10D-ISB12	12" X 12"	\$80.00
VFD-10D-ISB14	14" X 14"	\$105.00
VFD-10D-ISB16	16" X 16"	\$115.00
VFD-10D-ISB18	18" X 18"	\$135.00
VFD-10D-ISB20	20" X 20"	\$140.00
VFD-10D-ISB24	24" X 24"	\$170.00

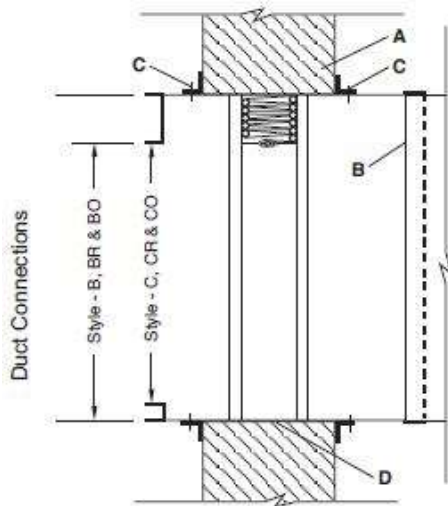

Damper Installation For Typical Fire Rated Partition

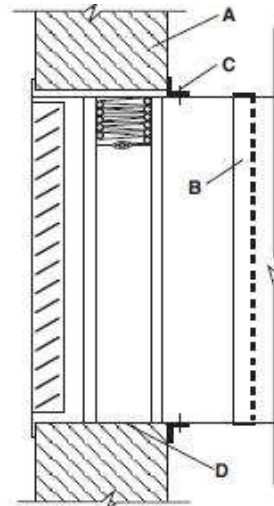

Damper Installation For Typical Flange Termination with Grille / Register

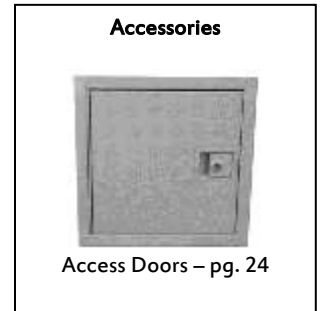

Add 2" for blades stacked in head.

Classified by Underwriters Laboratories as a 1 1/2 hour fire protection rated Fire Damper, in accordance with standards UL-555 and NFPA-90A, for the protection of openings in fire partitions having a fire resistance rating of less than three hours.

NO ADDITIONAL SLEEVE REQUIRED, PROVIDED DUCT THICKNESS IS 20 GA. OR LESS, AND U.L. APPROVED BREAKAWAY DUCT-TO-SLEEVE CONNECTION JOINTS ARE USED, PER UL-555.

POTTORFF CEILING RADIATION DAMPERS - 5 YEAR WARRANTY

UL listed. 3 hour rated.

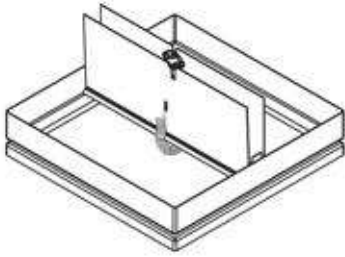

Square		
Stock #	Size	List Price
CFD-15-66	6" X 6"	\$34.00
CFD-15-88	8" X 8"	\$38.00
CFD-15-1010	10" X 10"	\$48.00
CFD-15-1212	12" X 12"	\$55.00
CFD-15-1414	14" X 14"	\$68.00
CFD-15-1616	16" X 16"	\$74.00
CFD-15-1818	18" X 18"	\$80.00
CFD-15-2020	20" X 20"	\$84.00
CFD-15-2222	22" X 22"	\$90.00

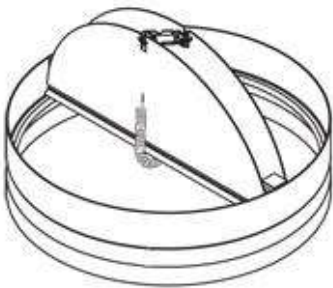

Round		
Stock #	Size	List Price
CFD15R-6	6"	\$42.00
CFD15R-8	8"	\$46.00
CFD15R-10	10"	\$48.00
CFD15R-12	12"	\$60.00
CFD15R-14	14"	\$68.00

THERMAL BLANKETS

For use with radiation dampers. Can be cut to size.



Stock #	Size	List Price
CDB	24" X 24"	\$30.00

AIR PRODUCTS & CONTROL SMOKE DETECTOR



Ionization type, Non-addressable. No tools required
 Low flow 100 – 4000 fpm
 230V AC, 115V AC, 24V AC/DC.

Stock #	List Price
SL-2000-N	\$220.00

SAMPLING TUBE



Fits Smoke Detector. Available in 2 Sizes. Can cut to length.

Stock #	Size	List Price
0532	2.5'	\$14.00
0533	5'	\$16.00
FAST TUBE	Adjustable	\$28.00

REMOTE ALARM



Pilot, Alarm(Red LED), Pilot, Test/Reset (push button).
 (Model #MS-RA/P/R)

Stock #	List Price
0537	\$48.00

REMOTE ALARM

White cover plate, (model #MSR-100R/W) Visual indication of detector
 "Pilot, Trouble and Alarm"; Key-operated "Test & Reset" functions.



Stock #	List Price
MSR100RS	\$160.00

ROUND ACCESS DOORS

20 gauge, insulated, tested to 20" S.P. with minimal leakage.



Stock #	Size	List Price
WAD6	10" X 6" for 6" round	\$72.00
WAD8	10" X 6" for 8" round	\$72.00
WAD10	10" X 6" for 10" round	\$72.00
WAD12	10" X 6" for 12" round	\$72.00
WAD14	10" X 6" for 14" round	\$72.00
WAD16	10" X 6" for 16" round	\$72.00

DUCT ACCESS DOORS

24 gauge, insulated, flanged frame with gasket, tabs, and cam lock. Hinged.

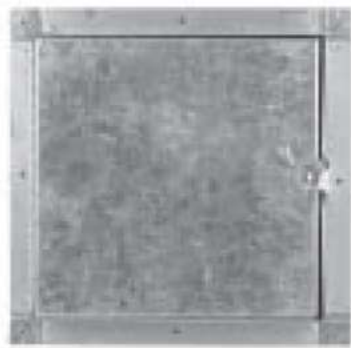

Stock #	Size	List Price
ADF6	6" X 6"	\$38.00
ADF8	8" X 8"	\$40.00
ADF10	10" X 10"	\$52.00
ADF12	12" X 12"	\$52.00
ADF14	14" X 14"	\$56.00
ADF16	16" X 16"	\$68.00
ADF18	18" X 18"	\$89.00
ADF20	20" X 20"	\$105.00
ADF24	24" X 24"	\$124.00

FIRE RATED ACCESS DOORS

UL 1.5 hour fire rated. Flush mounted for walls or ceilings.



Stock #	Rough-In	Size	List Price
FD12	12-3/8" X 12-3/8"	12" X 12"	\$190.00
FD14	14-3/8" X 14-3/8"	14" X 14"	\$210.00
FD16	16-3/8" X 16-3/8"	16" X 16"	\$230.00
FD18	18-3/8" X 18-3/8"	18" X 18"	\$240.00
FD24	24-3/8" X 24-3/8"	24" X 24"	\$300.00

SECTION 3

FLEX & ACCESSORIES / SHEET METAL

Insulated Flex 26
Clamps 26
Square to Round Adaptors 27
Reducers / Start Collars..... 27
Blast Gates / Steel Access Doors 28
Cylinder Lock..... 28
Vibration Isolation..... 29

FLEXIBLE DUCT – ATCO #036



Insulated. R value 6.0. Low & medium pressure.
 Temperature range -20degree F to +140degree F.
 Positive P. 6" (4-12" dia) 4" (14-20" dia)
 Negative pressure 3/4" on all sizes.
 Velocity 5,000 ft per minute.
 Codes UL-181 class 1 air duct, NFPA 90A and 90B,
 BOCA, ICBO.

Stock #	Size	List Price
R6FLEX06	6" X 25'	\$50.00
R6FLEX08	8" X 25'	\$60.00
R6FLEX10	10" X 25'	\$80.00
R6FLEX12	12" X 25'	\$100.00
R6FLEX14	14" X 25'	\$120.00
R6FLEX16	16" X 25'	\$130.00
R6FLEX18	18" X 25'	\$160.00

STAINLESS STEEL CLAMPS



Stock #	Size	List Price
5688	6" max diameter / 19" long	\$3.00
56128	8" max diameter / 22" long	\$3.50
56188	12" max diameter / 38" long	\$4.00
56272	17" max diameter / 54" long	\$5.00

NYLON CLAMPS – PANDUIT STRAPS

25 per bag.



Stock #	Size	List Price
PLT9H1	9" max diameter / 36" long	\$0.80
PLT13	13" max diameter / 45" long	\$1.00

SQUARE TO ROUND ADAPTERS – 26 GAUGE



Stock #	SQ to RND	List Price
SRA208	20-1/4" X 20-1/4" - 8"	\$22.00
SRA2010	20-1/4" X 20-1/4" - 10"	\$22.00
SRA2012	20-1/4" X 20-1/4" - 12"	\$22.00
SRA2014	20-1/4" X 20-1/4" - 14"	\$22.00
SRA2016	20-1/4" X 20-1/4" - 16"	\$22.00
SRA2018	20-1/4" X 20-1/4" - 18"	\$22.00
SRA20BLANK	20-1/4" X 20-1/4"	\$22.00
SRA4420BLANK	44-1/4" X 20-1/4" - 8"	\$50.00

Special Sizes for Filter Grilles.

Stock #	SQ to RND	List Price
SRA66	6" X 6" - 6"	\$12.00
SRA86	8" X 8" - 6"	\$12.00
SRA88	8" X 8" - 8"	\$12.00
SRA98	9" X 9" - 8"	\$12.00
SRA108	10" X 10" - 8"	\$12.00
SRA1010	10" X 10" - 10"	\$12.00
SRA126	12" X 12" - 6"	\$15.00
SRA128	12" X 12" - 8"	\$15.00
SRA1210	12" X 12" - 10"	\$15.00
SRA1212	12" X 12" - 12"	\$15.00
SRA22108	22" X 10" - 8"	\$22.00
SRA221010	22" X 10" - 10"	\$22.00
SRA226	22" X 22" - 6"	\$22.00
SRA228	22" X 22" - 8"	\$22.00
SRA2210	22" X 22" - 10"	\$22.00
SRA2212	22" X 22" - 12"	\$22.00
SRA2214	22" X 22" - 14"	\$22.00
SRA2216	22" X 22" - 16"	\$22.00
SRA2218	22" X 22" - 18"	\$22.00
SRA2220	22" X 22" - 20"	\$22.00
SRA22BLANK	22" X 22"	\$22.00

PANCAKE REDUCERS



Stock #	Size	List Price
REDUCER1412	14" to 12"	\$16.00
REDUCER1210	12 to 10"	\$16.00
REDUCER108	10" to 8"	\$12.00
REDUCER86	8" to 6"	\$12.00

START COLLARS

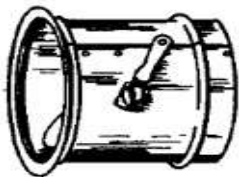

Dove-tail for Sheet Metal Duct – 26 Gauge. With Damper.

Stock #	Size	List Price
SMD6	6"	\$10.00
SMD8	8"	\$13.00
SMD10	10"	\$16.00
SMD12	12"	\$18.00
SMD14	14"	\$20.00
SMD16	16"	\$24.00

FULL BLAST GATES



Stock #	Size	List Price
FG2	2"	\$25.00
FG3	3"	\$32.00
FG4	4"	\$36.00
FG5	5"	\$46.00
FG6	6"	\$55.00
FG7	7"	\$66.00
FG8	8"	\$75.00
FG9	9"	\$110.00
FG10	10"	\$136.00
FG12	12"	\$144.00
FG14	14"	\$250.00

STEEL ACCESS DOORS



Flush mounted for walls or ceilings. 16 gauge with 1" flange.
Screwdriver-operated steel cam

Stock #	Rough In	Size	List Price
TM8	8-3/8 X 8-3/8	8" X 8"	\$40.00
TM10	10-3/8 X 10-3/8	10" X 10"	\$44.00
TM12	12-3/8 X 12-3/8	12" X 12"	\$46.00
TM14	14-3/8 X 14-3/8	14" X 14"	\$54.00
TM16	16-3/8 X 16-3/8	16" X 16"	\$56.00
TM18	18-3/8 X 18-3/8	18" X 18"	\$68.00
TM24	24-3/8 X 24-3/8	24" X 24"	\$94.00
TM2436	24-3/8 X 24-3/8	24" X 36"	\$130.00

CYLINDER LOCK – field mounted (factory mount lock available with special order)



Stock #	List Price
CL	\$20.00

SPRING FLEX HANGER

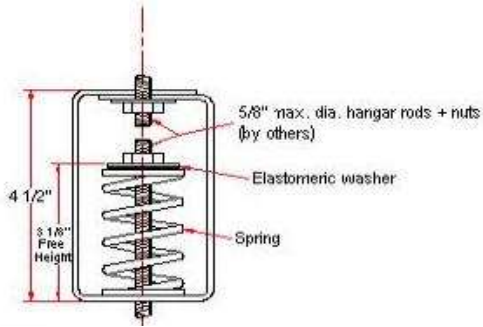

Springs have 50% additional travel to solid beyond rated load.



Stock #	Rated Load	List Price
HSA121	40 lbs.	\$30.00
HSA123	110 lbs.	\$30.00

ANTI-VIBRATION HANGAR MOUNTS

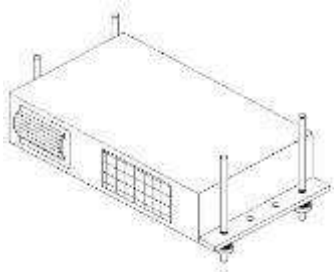

Direct on unit



On channel / strut

Can be used with threaded rods up to 3/8" for suspension of pipes, fans, etc. Can be used for small floor mounted machines like refrigerator, dishwasher, etc.



Stock #	Rated Load	List Price
AVHM-50	110 lbs.	\$5.00
AVHM-100	220 lbs.	\$5.00

NEOPRENE-IN-SHEAR HANGERS

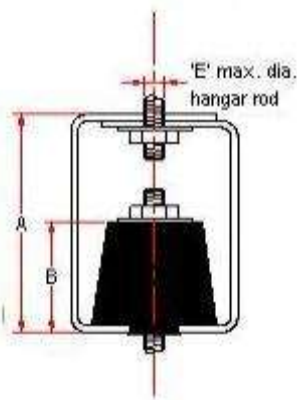

Do not exceed maximum load by more than 5%. Nuts, washer & rods by others.



Stock #	Color	Rated Load	List Price
HNDA2	Red	40 lbs.	\$17.00
HNDA3	Green	70 lbs.	\$17.00
HNDA4	Black	115 lbs.	\$17.00

SHEAR FLEX PADS / CORK RIB PADS



RMP

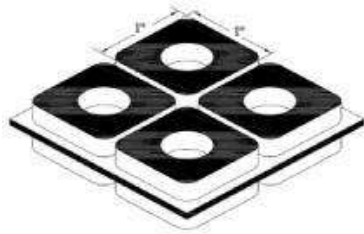

ECRMP (040434)

For application wherever bolting is to be avoided and minor, non-critical vibration conditions exist. (i.e. pumps, motors, a/c units, generators, etc.) Special rubber material. Maximum loading: 60 lbs/sq.in. Working range: 15 to 55 lbs/sq.in.

Stock #	Size	List Price
RMP	18" X 18" X 3/8"	\$50.50
* CRMP	18" X 18" X 1"	\$100.00
ECRMP	4" X 4"	\$5.00

SECTION 4

FANS & ACCESSORIES

Ceiling Exhaust..... 32
Speed Controllers / Broan Grilles 33
Conversion Kits/ Transitions..... 33
Isolators 33
Wall Caps..... 33
Roof Caps..... 34
Roof Exhaust..... 35
Roof Curbs 38

BROAN LO-SONE CEILING FANS



115 Volt.

Stock #	Outlet	CFM vs. SP				Sones @ .25"	List Price
		0"	.25"	.375"	.5"		
L100	6"	136	93	80	65	1.3	\$220.00
L150	6"	181	141	132	124	2.2	\$250.00
L200	8"	231	196	186	177	2.3	\$290.00
L250	8"	269	253	248	239	3.0	\$340.00
L300	8"	309	294	286	276	2.9	\$300.00
L400	4.5 X 18.5	480	388	344	299	2.8	\$490.00
L500	4.5 X 18.5	538	491	463	434	3.6	\$520.00

BROAN ECONOMY CEILING FANS

115 Volt.

Stock #	Outlet	CFM @ 0"	Sones	Amps	List Price
674	4"	110	4	1.3	\$120.00
684	4"	80	2.5	0.5	\$120.00
688	3"	50	2	0.8	\$40.00



674

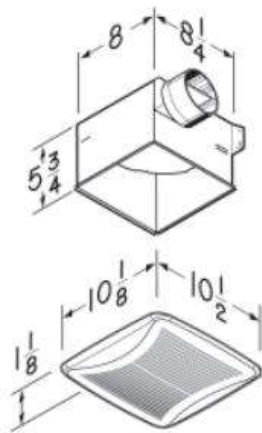

684

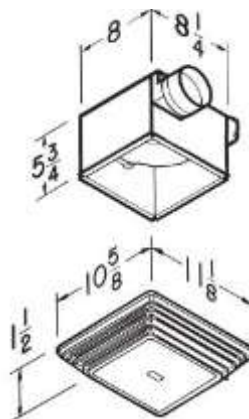

688

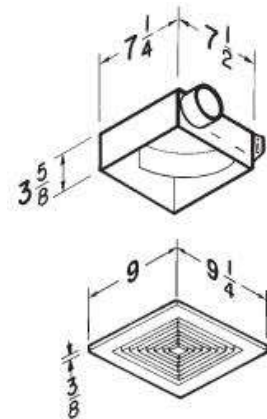

FAN SPEED CONTROLLERS - BROAN

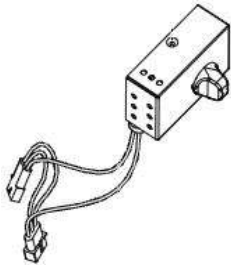

Stock #	Description	Max. Amp	List Price
57	L100-L700	3	\$48.00
80L	L100-L900 Internal	3	\$106.00

BROAN EXHAUST GRILLES

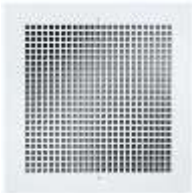

White Enamel Painted Steel.

Stock #	Description	List Price
MG1	for L100-L300	\$50.00

ISOLATORS



For use with threaded rods up to 3/8" for suspension of item.
Nut, washer and rod by others.

Stock	Descriptions	List Price
AVHM-50	Max Load 110 lbs.	\$5.00
AVHM-100	Max Load 220 lbs.	\$5.00

BROAN IN-LINE CONVERSION KITS

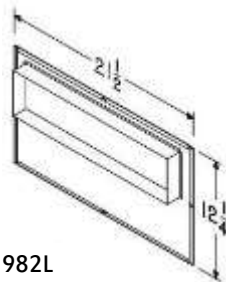

982L

Stock #	Description	List Price
961L	6" for L100/L150	\$44.00
981L	8" for L200/L250/L300	\$44.00
982L	4.5" X 18.5" for L400/L500	\$44.00

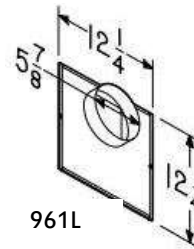

961L

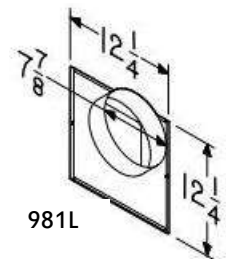

981L

WALL CAP Wall cap with screen. Galvanized



Stock #	Description	List Price
SWVG4	4"	\$22.00
SWVG6	6"	\$25.00
SWVG8	8"	\$30.00
SWVG10	10"	\$50.00

FLAT BASE ROOF CAP



611/612

Stock #	Description	List Price
611	Aluminum 8"	\$ 96.00
612	Aluminum 12"	\$170.00
PJV826	Galvanized 8" White	\$ 40.00
PJV1226	Galvanized 12" White	\$ 60.00

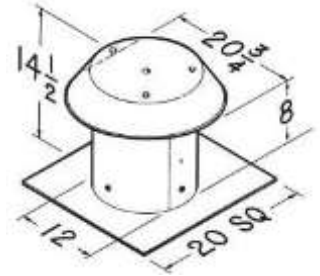
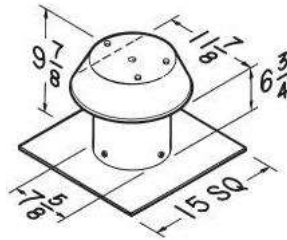

CURB MOUNT ROOF CAP



611CM/612CM

Stock #	Description	List Price
611CM	AL 8" (curb size = 14" X 14")	\$110.00
612CM	AL 12" (curb size = 17" X 17")	\$170.00
PJV826-CURB	GA 8" (curb size = 14" X 14") white	\$ 70.00
PJV1226-CURB	GA 12" (curb size = 17" X 17") white	\$ 80.00

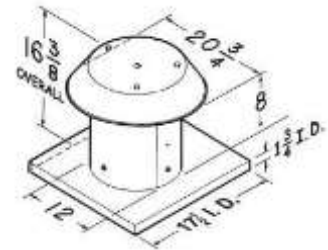
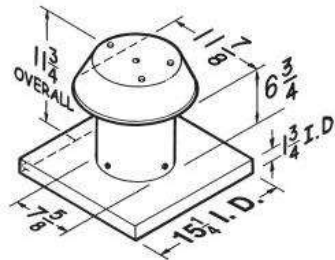

TEE TOPS

Galvanized with 12 inch high throat. For range hoods, dryer vents, fans.



Stock #	Description	List Price
JV42812CL	4"	\$30.00
JV62812CL	6"	\$36.00
JV82812CL	8"	\$40.00

TWIN CITY DIRECT DRIVE ROOF EXHAUSTER



1/8 HP motors are 3-speed (sizes 070, 080, & 090) with factory mounted speed controller; BDD, NEMA 1 Disconnect shipped loose. Motors are 115/1/60 PSC.

Stock #	Roof Opening	Curb Size	Weight	List Price
DCRD070	10.5" X 10.5"	15.5" X 15.5"	30 lbs.	\$660.00
DCRD080	10.5" X 10.5"	15.5" X 15.5"	32 lbs.	\$690.00
DCRD090	10.5" X 10.5"	15.5" X 15.5"	43 lbs.	\$700.00
DCRD100	10.5" X 10.5"	15.5" X 15.5"	48 lbs.	\$920.00
DCRD120	14.5" X 14.5"	18.5" X 18.5"	50 lbs.	\$1100.00
DCRD130	18.5" X 18.5"	22.5" X 22.5"	65 lbs.	\$1200.00

Size	HP	RPM	static pressure (INCHES W.G)											
			0.125		0.25		0.375		0.5		0.625			
			CFM		CFM		CFM		CFM		CFM			
70B	1/8	1350	266		176									
			0.02	5.1	0.02	5.2								
		1500	312		235									
			0.02	6.2	0.02	6.1								
		1650	355		289		214							
			0.03	8	0.03	7.7	0.03	7.1						
80B	1/8	1350	319		198									
			0.02	5.1	0.1	5.2								
		1500	376		277									
			0.02	6.2	0.02	5.6								
		1650	432		345		240							
			0.03	7.5	0.03	7.7	0.03	7.3						
90B1	1/8	1350	663		574		467		340					
			0.06	7.6	0.07	6.8	0.07	6.8	0.07	6.8				
		1500	754		678		589		488		370			
			0.09	8.9	0.09	8.1	0.1	8.4	0.09	7.7	0.09	8		
		1650	842		776		701		616		521			
			0.11	10.4	0.12	9.8	0.13	9.3	0.13	9.8	0.12	9.2		
100B1	1/3	1450	1135		1015		877		713		524			
			0.13	12.9	0.13	11.6	0.13	12.4	0.13	11.4	0.12	11.6		
		1750	1413		1317		1216		1103		977			
			0.22	17.5	0.23	16.7	0.23	16.0	0.23	16.6	0.23	16.6		
		1450	1535		1399		1251		1085		902			
			0.18	13.2	0.19	11.9	0.20	12.1	0.20	12.5	0.19	11.8		
1750	1901		1793		1678		1557		1427					
	0.31	18.0	0.33	17.9	0.34	16.4	0.35	16.7	0.35	17.7				
130B1	1/2	1450	2131		1988		1856		1709		1550			
			0.34	17.0	0.35	17.2	0.36	17.1	0.37	18.0	0.37	18.7		
		1750	2620		2513		2402		2285		2164			
			0.59	22	0.60	22.0	0.62	23.0	0.62	22	0.63	23		

BHP does not include transmission losses.

Telephone: (602) 275-4467
(520) 790-4490

Fax: (602) 275-6516
(520) 790-4673

Order Fax: (602) 275-1637
Verify current pricing at www.nsw HVAC.com

TWIN CITY BELT DRIVE ROOF EXHAUSTER



Motors are 115/1/60, includes NEMA 1 disconnect, BDD shipped loose.

Stock #	Roof Opening	Curb Size	Weight	List Price
BCRD070C	10.5" X 10.5"	15.5" X 15.5"	70 lbs.	\$950.00
BCRD085C	10.5" X 10.5"	15.5" X 15.5"	95 lbs.	\$970.00
BCRD100C	14.5" X 14.5"	18.5" X 18.5"	112 lbs.	\$990.00
BCRD120C	14.5" X 14.5"	18.5" X 18.5"	135 lbs.	\$1,200.00
BCRD140C	18.5" X 18.5"	22.5" X 22.5"	141 lbs.	\$1,130.00
BCRD160C	20.5" X 20.5"	24.5" X 24.5"	153 lbs.	\$1,480.00

Size	HP	RPM	static pressure (INCHES W.G)									
			0.125		0.25		0.375		0.5		0.625	
			CFM	BHP	Sone	CFM	BHP	Sone	CFM	BHP	Sone	CFM
70D	1/4	1375	263		214		145					
			0.03	6.5	0.03	8.4	0.03	9.1				
		1775	362		329		290		251		187	
			0.06	6.6	0.06	6.8	0.06	7.3	0.06	7.9	0.06	7.9
		2100	441		411		383		350		316	
			0.1	8.7	0.10	8.1	0.11	7.9	0.11	8.4	0.11	9.0
85D	1/4	1200	504		445		368		232			
			0.04	9.6	0.04	6.5	0.04	6.4	0.03	4.8		
		1750	770		740		705		661		613	
			0.11	16.1	0.11	16.1	0.11	13.2	0.11	11.1	0.12	11.2
		2280	1017		996		973		949		921	
			0.23	19.3	0.24	19.3	0.24	19.3	0.24	18.1	0.24	16.2
100D	1/3	1250	1080		999		924		856		755	
			0.14	10.1	0.14	8.7	0.14	9.3	0.15	10.0	0.15	8.2
		1590	1416		1349		1285		1225		1167	
			0.27	14.9	0.28	13.6	0.29	12.6	0.29	12.5	0.3	13.3
		1665	1489		1424		1363		1305		1248	
			0.31	16.1	0.32	14.9	0.33	13.8	0.33	13.3	0.34	13.6
120D	1/2	1365	1686		1609		1537		1469		1393	
			0.27	13.6	0.28	12.7	0.28	11.7	0.29	11.6	0.3	11.7
		1540	1921		1852		1785		1723		1663	
			0.38	16.4	0.39	15.7	0.4	14.7	0.41	13.9	0.42	13.8
		1650	2068		2003		1940		1880		1824	
			0.46	17.9	0.48	17.9	0.49	16.8	0.5	15.9	0.51	15.5
140D	1/2	1225	2108		2016		1915		1803		1694	
			0.32	13	0.33	13.0	0.34	11.7	0.35	11.6	0.35	12.3
		1310	2266		2181		2091		1989		1883	
			0.39	14.4	0.41	14.8	0.42	13.8	0.42	13.3	0.43	13.4
		1400	2432		2354		2272		2181		2083	
			0.47	16.2	0.49	16.2	0.51	16.1	0.51	15.6	0.52	15.2
160D	1/2	1020	2713		2578		2425		2255		2078	
			0.31	12.1	0.32	11.5	0.33	10.4	0.34	10	0.35	10.6
		1100	2945		2822		2687		2535		2376	
			0.39	13.3	4	13.0	0.41	12	0.43	11.2	0.43	11.4
		1180	3176		3063		2942		2807		2661	
			0.48	14.5	0.49	14.5	0.5	13.6	0.52	12.7	0.53	12.3

Telephone: (602) 275-4467
(520) 790-4490

Fax: (602) 275-6516
(520) 790-4673

Order Fax: (602) 275-1637
Verify current pricing at www.nsw HVAC.com

TWIN CITY KITCHEN EXHAUSTER



Belt Drive. Restaurant construction with grease box, drain connection, NEMA 3R Disconnect, curb hinge shipped loose. Motors 1/2 HP and less are 115/1/60, 3/4 HP 208/230/3/60

Stock #	Roof Opening	Curb Size	Weight	List Price
BCRUR120	18.5" X 18.5"	23.5" X 23.5	135 lbs.	\$1,800.00
BCRUR140	18.5" X 18.5"	23.5" X 23.5	173 lbs.	\$2,000.00
BCRUR160A	18.5" X 18.5"	23.5" X 23.5	183 lbs.	\$2,600.00

Size	HP	RPM	static pressure (INCHES W.G)											
			0.125		0.25		0.375		0.5		0.625		0.075	
			CFM		CFM		CFM		CFM		CFM		CFM	
BHP	Sone	BHP	Sone	BHP	Sone	BHP	Sone	BHP	Sone	BHP	Sone			
120B	1/2	1370	1683		1604		1513		1460		1379		1282	
			0.27	12.5	0.26	11.8	0.29	11	0.29	10.6	0.3	11.2	0.31	11.8
		1545	1918		1847		1779		1715		1653		1583	
			0.38	14.9	0.39	14.6	0.4	13.8	0.41	13.1	0.42	12.9	0.43	13
		1655	2064		1998		1933		1872		1814		1754	
			0.47	16.6	0.48	16.6	0.49	15.5	0.5	14.6	0.51	14.4	0.52	14.3
140B	1/2	1140	2097		1976		1862		1735		1577			
			0.27	12.9	0.29	11.7	0.3	11	0.3	11.6	0.31	11.8		
		1305	2434		2327		2224		2125		2015		1885	
			0.41	16.8	0.42	15.5	0.43	13.9	0.45	13.5	0.45	13.8	0.46	14
		1370	2566		2464		2364		2269		2171		2058	
			0.47	18.5	0.48	17.5	0.5	15.6	0.51	14.6	0.52	14.6	0.53	15.2
160B	3/4	1100	2543		2404		2293		2169		2082		1866	
			0.39	15.1	0.40	13.0	0.41	12.4	0.42	12.6	0.42	13.5	0.42	13.3
		1265	2974		2834		2730		2634		2528		2410	
			0.59	19.7	0.6	17.0	0.61	16.0	0.62	15.5	0.63	15.5	0.64	16.5
		1345	3183		3044		2939		2848		2755		2650	
			0.7	22	0.72	19.1	0.73	17.8	0.74	17.1	0.75	17	0.76	17.1

TWIN CITY UPBLAST EXHAUSTER

Upblast belt exhauster. with NEMA1 Disconnect Switch, BDD shipped



Stock #	Roof Opening	Curb Size	Weight	List Price
BCRU110	18.5" X 18.5"	23.5" X 23.5"	135 lbs.	\$1,350.00
BCRU120	18.5" X 18.5"	23.5" X 23.5"	135 lbs.	\$1,350.00

Size	HP	RPM	static pressure (INCHES W.G)									
			0.125		0.25		0.375		0.5		0.625	
			CFM		CFM		CFM		CFM		CFM	
BHP	Sone	BHP	Sone	BHP	Sone	BHP	Sone	BHP	Sone	BHP	Sone	
110B	1/4	1025	871		774		653		433			
			0.08	6.3	0.08	5.6	0.08	5.9	0.07	5		
		1250	1098		1023		942		846		732	
			0.13	9.2	0.14	8.0	0.14	7.6	0.14	8.3	0.14	7.4
		1515	1360		1299		1236		1170		1097	
			0.23	12.6	0.24	11.8	0.25	10.8	0.25	10.3	0.25	10.7
120B	1/2	1370	1683		1604		1513		1460		1379	
			0.27	12.5	0.26	11.8	0.29	11	0.29	10.6	0.3	11.2
		1545	1918		1847		1779		1715		1653	
			0.38	14.9	0.39	14.6	0.4	13.8	0.41	13.1	0.42	12.9
		1655	2064		1998		1933		1872		1814	
			0.47	16.6	0.48	16.6	0.49	15.5	0.5	14.6	0.51	14.4

Telephone: (602) 275-4467
(520) 790-4490

Fax: (602) 275-6516
(520) 790-4673

Order Fax: (602) 275-1637
Verify current pricing at www.nsw HVAC.com

ROOF CURB

12" high, no cant. for flat roof, treated 1-1/2" wood nailer, insulated.

Stock #	Size	List Price
CURB 14	14" X 14" for 8" Cap	\$70.00
CURB 15.5	15.5" X 15.5"	\$80.00
CURB 17	17" X 17" for 12" Cap	\$88.00
CURB 18.5	18.5" X 18.5"	\$100.00
CURB 22.5	22.5" X 22.5"	\$110.00
CURB 24.5	24.5" X 24.5"	\$120.00



Note

- 1) Curbs are sized 1-1/2" less than fan base to allow 3/4" each side for clearance and flashing material.
- 2) Inside of curb is 3" less O.D.

VENTED ROOF CURB FOR KITCHEN FAN



18" high Galvanized construction, no insulation

Stock #	Size	List Price
VCURB 23.5	23.5" X 23.5"	\$164.00
VCURB 29.5	29.5" X 29.5"	\$182.00
VCURB 33.5	33.5" X 33.5"	\$210.00

SECTION 5

SAMSUNG

Heat Pumps / Mini Splits 40
Four Way Ceiling Cassettes..... 41
Multi Zone Units..... 42
Accessories / Line Sets..... 43
Condensate Pumps..... 44
Yellow Jacket Specialty Tools 44

WHISPER & (MAX) SERIES HEAT PUMPS / MINI SPLITS – HIGH WALL



Heat pump models with hand held remote controller.
 Inverter-driven compressor. 208/230-1 power, R-410A.
 Warranty: 7(5) year-compressor, 5(3) year-parts, 120 day-limited labor.



Stock #	Unit	Line Size	Max Length	Tons	Capacity @ 115°F	SEER	List Price
AR09HSFSHWKN	Indoor	1/4" & 3/8"	50'	3/4	9076	23	800.00
AR09HSFSHWKX	Outdoor						1200.00
AR12HSFSHWKN	Indoor	1/4" & 3/8"	50'	1	10816	22	900.00
AR12HSFSHWKX	Outdoor						1350.00
AR18HSFSHWKN	Indoor	1/4" & 1/2"	98'	1-1/2	17708	20.5	1280.00
AR18HSFSHWKX	Outdoor						1930.00
AR24HSFSHWKN	Indoor	1/4" & 5/8"	98'	2	23270	20	1420.00
AR24HSFSHWKX	Outdoor						2120.00
AQN36VFUAGM	Indoor	1/4" & 5/8"	164'	3	29635	18	\$1,970.00
AQX36VFUAGM	Outdoor						\$2,954.00

Stock #	Description	Line Size	List Price
Quiet Side 20 Seer High Wall			
QS12-VP115	1-ton HP outdoor - high wall 115/1	-	\$1326.00
QS12-VJ115	1-ton HP indoor - high wall 115/1	1/4 & 3/8	\$654.00

- Accessories - page 43

 - Condensate Pump & Hose
 - Line Sets with Wire
 - Wired Controller
 - Lineset Cover
 - WiFi Adapter Kit

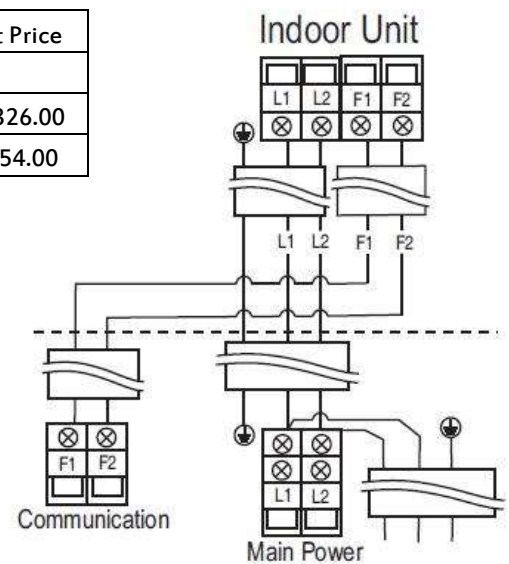

Wiring diagram

MAX SERIES HEAT PUMPS – 4 WAY CEILING CASSETE



Ultra slim design 12" height with an opening of 33 X 33.

Built in Low Ambient cooling to 14°F. 208-230/1phase

Built-in condensate lift and overflow cut off.

Wired controller AQN-WRS included. Inverter-driven compressor.

Warranty: 5 years-compressor, 3 years-parts, 120 day-limited labor.



Stock #	Unit	Line Size	Max Length	Tons	Capacity @ 95°F	SEER	List Price
UH070CAV1	Outdoor	1/4" & 5/8"	162'	2	24,000	17	\$2,995.00
CH070CAV1	Indoor						\$2,656.00
UH105CAV1	Outdoor	3/8" & 5/8"	246'	3	36,000	15.5	\$3,179.00
CH105CAV1	Indoor						\$3,037.00

Stock #	Description	List Price
Optional Wired Controllers		
AQN-WRS	Standard wired remote (MWR-WH00)	\$221.00
AQN-WRP	Premium wired remote (MWR-WE10)	\$341.00

Stock #	Description	List Price
Alternate Front Panel		
P4SMA	4-Way 2T, 3T	\$0.00

MAX SERIES MULTI ZONE UNITS



MH050FXCA2A

Line sizes dependent upon indoor selection.
Line set max length: 75ft.

High Wall hand held controller included.
Mini 4-way wired standard wired remote #AQN-WRS included.
Mini 4-way with internal condensate pump with 29-1/2" lift.
Warranty: 5 years-compressor, 3 years-parts, 120 day-limited labor.
Other styles of air handlers available.

Stock #	Unit	Line Size	Tons	SEER	List Price
Free Joint					
MH050FXCA2A	Outdoor Multi Zone	(1/4" & 3/8") x 2	2	*	\$2,315.00
MH080FXCA4A	Outdoor Multi Zone	(1/4" & 3/8") x 3; (1/4" & 1/2") x 1	3	*	\$3,429.00
MH026FNCA	Indoor High Wall	1/4" & 3/8"	3/4	16	\$827.00
MH035FNCA	Indoor High Wall	1/4" & 3/8"	1	16	\$909.00
MH052FNCA	Indoor High Wall	1/4" & 1/2"	1-1/2	16	\$1,115.00
NJ035MHXCA	Indoor MINI 4-way	1/4" & 3/8"	1	16	\$1,525.00
NJ052MHXCA	Indoor MINI 4-way	1/4" & 1/2"	1-1/2	16	\$1,925.00

Stock #	Description	List Price
Alternate Front Panel		
PMSMA	*	\$0.00

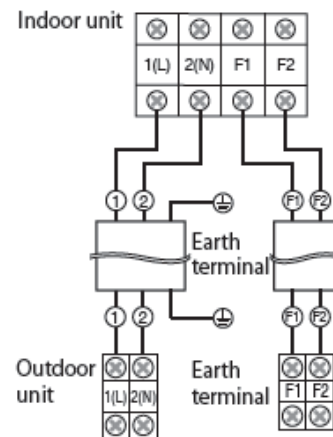
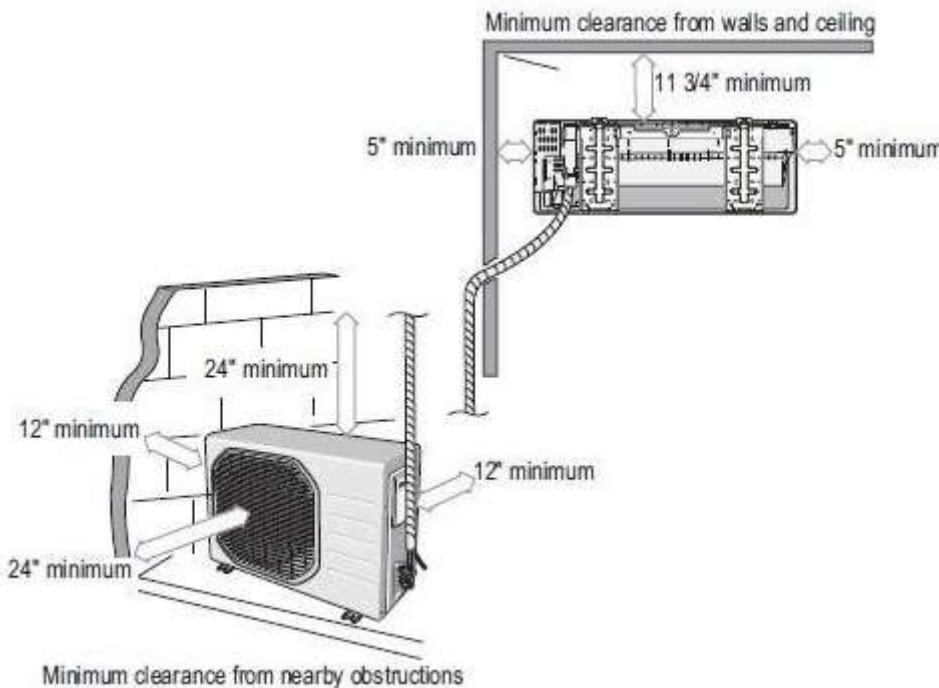

* Screws on terminal block must not be unscrewed with the torque less than 0.87 ft-lb.

Telephone: (602) 275-4467
(520) 790-4490

Fax: (602) 275-6516
(520) 790-4673

Order Fax: (602) 275-1637
Verify current pricing at www.nswhvcaz.com

MINI SPLIT ACCESSORIES



Stock #	Description	Capacity	List Price
Insulated Line Sets with Power and Control Wires			
ILS2506	25ft 1/4" x 3/8" with wire 14-3 & 16-2	12,000 BTU	\$216.00
ILS5006	50ft 1/4" x 3/8" with wire 14-3 & 16-2	12,000 BTU	\$387.00
ILS2507	25ft 1/4" x 1/2" with wire 14-3 & 16-2	18,000 BTU	\$235.00
ILS5007	50ft 1/4" x 1/2" with wire 14-3 & 16-2	18,000 BTU	\$427.00
ILS2509	25ft 1/4" x 5/8" with wire 14-3 & 16-2	36,000 BTU	\$264.00
ILS5009	50ft 1/4" x 5/8" with wire 14-3 & 16-2	36,000 BTU	\$480.00
I33-500	2 wire 16 AWG shielded 500 ft roll	-	\$1.18/ft
R410A-ADPT	5/16" Schraeder connector	-	\$34.00



AQN-WRS



AQN-WRP

Stock #	Description	List Price
Optional Wired Controllers		
AQN-WRS	Standard remote MWR-WH00	\$221.00
AQN-WRP	Premium remote MWR-WE10	\$341.00
WIFI	WIFI Controller AR09-24	\$150.00

Wall mount unit includes MIM-A00A sub-PCB



Stock #	Description	List Price
Fortress Lineset Covers		
LDK-92-W	12' Wall Duct Kit w/ fittings	\$130.00

Stock #	Description	List Price
Condensate Pumps		
ASP-MA-UNI	Mini Aqua	\$220.00
ASP-MAXO-230	Maxi Orange	\$300.00

Stock #	Description	List Price
Mini-Split Condensate Drain Hose		
DRAIN HOSE	5/8" ID Smooth Bore UV-resistant 164ft per roll	\$0.96/ft.



Mini Aqua Pump Kit



Maxi Orange Pump Kit



Condensate Hose

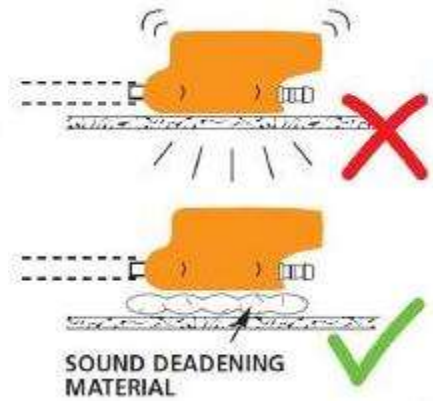
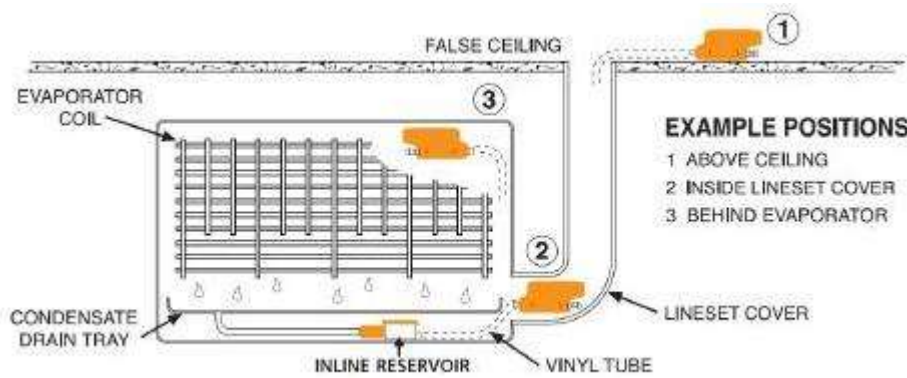

Condensate Pump install diagram

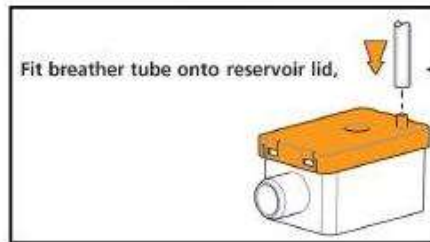
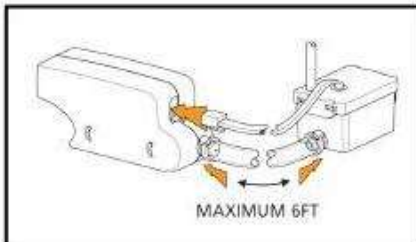

YELLOW JACKET SPECIALTY TOOLS

Reduce warranty calls and improve install time.

Stock #	Description	List Price
Flare Tool	Deluxe R-410A Flaring Tool	\$230.00
Torque Wrench	Torque Wrench Set	\$204.00
R140A-ADPT	5/16" x 1/4" Adapter	\$34.00



60278 – Flaring Tool



60650 – Torque Set

Telephone: (602) 275-4467
(520) 790-4490

Fax: (602) 275-6516
(520) 790-4673

Order Fax: (602) 275-1637
Verify current pricing at www.nsw HVAC.com

SECTION 6

AIR FILTRATION / CEL PAD

AIR FILTRATION

Standard Pleated MERV 8.....46
High Capacity Pleated MERV 10 & 1147
Pleat 4" Geopleat MERV 11 - 1448
Rigid Cell Aerostar MERV 13 & 1448
Synthetic Bags MERV 13 & 14.....49
ASHRAE Cartridge MERV 1449
V-Bank Mini Pleat MERV 13 & 1449

CELPAD

CELDEK Evap Cooler Pad50
Paint Arrestors.....50

FILTRATION GROUP STANDARD CAPACITY PLEATED AIR FILTER



SERIES 400

1" Disposable, 30 – 35% efficiency MERV 8.
 14 pleats per lineal foot. 1.6 square feet of media per square foot of face area.
 Initial resistance 0.18" w.g.

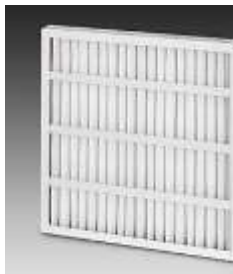

NOVA PLEAT

2" Disposable, 30 – 35% Efficiency MERV 8.
 10 pleats per lineal foot. 3.1 square feet of media per square foot of face area.
 Initial resistance 0.19" w.g. 500 fpm



SERIES 400

4" Disposable, 30 – 35% Efficiency MERV 8.
 8 pleats per lineal foot. 5.8 square feet of media per square foot of face area.
 Initial resistance 0.12" w.g. 500 fpm

Nominal Size	List Price		
	1"	2"	4"
	SC14-x	SC10-x	SC8-x
10" X 20"	\$5.79	\$6.22	
10" X 24"	\$7.00		
10" X 25"	\$7.47		
12" X 12"	\$5.79		
12" X 20"	\$5.79	\$8.18	
12" X 24"	\$5.79	\$6.22	\$10.07
12" X 25"	\$6.38		
14" X 20"	\$5.79	\$6.22	
14" X 24"	\$7.00		
14" X 25"	\$6.38	\$6.80	
15" X 20"	\$5.97	\$6.22	
16" X 16"	\$7.47	\$8.18	
16" X 20"	\$5.97	\$6.22	\$10.07
16" X 24"	\$6.38	\$6.80	
16" X 25"	\$6.38	\$6.80	\$11.09
18" X 18"	\$7.47		
18" X 20"	\$7.47	\$8.30	
18" X 22"	\$8.27	\$8.30	
18" X 24"	\$7.09	\$7.56	\$12.53
18" X 25"	\$7.09	\$9.10	
20" X 20"	\$6.38	\$6.80	\$11.09
20" X 24"	\$7.09	\$7.56	\$12.53
20" X 25"	\$7.09	\$7.56	\$12.53
20" X 30"	\$8.32	\$9.24	
22" X 22"	\$8.92		
24" X 24"	\$7.33	\$8.39	\$13.26
25" X 25"	\$8.32	\$9.24	

FILTRATION GROUP HIGH CAPACITY PLEATED FILTER



SERIES 400

1" Disposable, 50 – 55% Efficiency MERV 10.
16 pleats per lineal foot. 2.3 square feet of media per square foot of face area.
Initial resistance 0.15" w.g. 375 fpm



NOVA PLEAT

2" Disposable, 30 – 35% Efficiency MERV 8.
15 pleats per lineal foot. 4.6 square feet of media per square foot of face area.
Initial resistance 0.17" w.g. 500 fpm



SERIES 400

4" Disposable, 50 – 55% Efficiency MERV 10.
12 pleats per lineal foot. 7.0 square feet of media per square foot of face area.
Initial resistance 0.11" w.g. 500 fpm

MERV 11 PLEATED AIR FILTER



SERIES 1100

2" Disposable, 60 – 65% Efficiency MERV 11.
15 pleats per lineal foot. 4.6 square feet of media per square foot of face area.
Initial resistance 0.34" w.g. 500 fpm

Nominal Size	List Price		
	1"	2"	4"
	SC14-x	SC10-x	SC8-x
10" X 20"	\$5.79	\$6.22	
10" X 24"	\$7.00		
10" X 25"	\$7.47		
12" X 12"	\$5.79		
12" X 20"	\$5.79	\$8.18	
12" X 24"	\$5.79	\$6.22	\$10.07
12" X 25"	\$6.38		
14" X 20"	\$5.79	\$6.22	
14" X 24"	\$7.00		
14" X 25"	\$6.38	\$6.80	
15" X 20"	\$5.97	\$6.22	
16" X 16"	\$7.47	\$8.18	
16" X 20"	\$5.97	\$6.22	\$10.07
16" X 24"	\$6.38	\$6.80	
16" X 25"	\$6.38	\$6.80	\$11.09
18" X 18"	\$7.47		
18" X 20"	\$7.47	\$8.30	
18" X 22"	\$8.27	\$8.30	
18" X 24"	\$7.09	\$7.56	\$12.53
18" X 25"	\$7.09	\$9.10	
20" X 20"	\$6.38	\$6.80	\$11.09
20" X 24"	\$7.09	\$7.56	\$12.53
20" X 25"	\$7.09	\$7.56	\$12.53
20" X 30"	\$8.32	\$9.24	
22" X 22"	\$8.92		
24" X 24"	\$7.33	\$8.39	\$13.26
25" X 25"	\$8.32	\$9.24	

Stock #	Nominal Size	List Price
12242	12" X 24" X 2"	\$8.60
16202	16" X 20" X 2"	\$8.65
16242	16" X 24" X 2"	\$9.88
16252	16" X 25" X 2"	\$9.90
20202	20" X 20" X 2"	\$9.90
20252	20" X 25" X 2"	\$11.29
24242	24" X 24" X 2"	\$13.42

FILTRATION GROUP

4" PLEAT – GeoPleat – for LEED MERV 13



Long Life Filter

High Efficiency Wet Laid Microglass. Intermittent thermoplastic separators. Box style. UL 900 Class 2

Stock #	Size	MERV	List Price
MP6512244	12" X 24" X 4"	MERV 11 – 65%	\$60.00
MP6516204	16" X 20" X 4"	MERV 11	\$98.00
MP6516254	16" X 25" X 4"	MERV 11	\$98.00
MP6518244	18" X 24" X 4"	MERV 11	\$98.00
MP6520204	20" X 20" X 4"	MERV 11	\$98.00
MP6520244	20" X 24" X 4"	MERV 11	\$98.00
MP6520254	20" X 25" X 4"	MERV 11	\$98.00
MP6524244	24" X 24" X 4"	MERV 11	\$98.00
MP8524244	24" X 24" X 4"	MERV 13 – 85%	\$100.00
MP9512244	12" X 24" X 4"	MERV 14 – 95%	\$68.00
MP9520204	20" X 20" X 4"	MERV 14	\$106.00
MP9520244	20" X 24" X 4"	MERV 14	\$106.00
MP9524244	24" X 24" X 4"	MERV 14	\$106.00

SYNTHETIC RIGID CELL - AEROSTAR

High efficiency ultra-fine synthetic media. With or without header. UL900 Class 1 or 2.



With Header

Stock #	Size	CFM	Efficiency	List Price
No Header UL 900 CLASS 2				
ERP85122412	12" X 24" X 12"	1000	MERV 13	\$92.00
ERP85242412	24" X 24" X 12"	2000	MERV 13	\$117.30
ERP95122412	12" X 24" X 12"	1000	MERV 14	\$94.40
ERP95242412	24" X 24" X 12"	2000	MERV 14	\$129.00
With Header UL 900 CLASS 1 or 2				
Stock #	Size	CFM	Efficiency	List Price
ERPH85122412	12" X 24" X 12"	1000	MERV 13	\$96.00
ERPH85202012	20" X 20" X 12"	-	MERV 13	\$101.00
ERPH85202412	20" X 24" X 12"	1700	MERV 13	\$107.00
ERPH85242412	24" X 24" X 12"	2000	MERV 13	\$125.00
ERPH95242412	24" X 24" X 12"	1000	MERV 13	\$101.00
ERPH95202012	20" X 20" X 12"	-	MERV 14	\$105.00
ERPH95202412	20" X 24" X 12"	1700	MERV 14	\$114.00
ERPH95242412	24" X 24" X 12"	2000	MERV 14	\$130.00

**FILTRATION GROUP
SYNTHETIC BAG – SONIQ POCKET FILTER**



High efficiency, high-capacity pocket filters. 8 pockets per 24" of width. UL900 Class 2. Final pressure 1-1.5" w.g.

Stock #	Size	Sq. ft.	Efficiency	List Price
EPS885122422	12" X 24" X 22"	31	MERV 13 85%	\$36.00
EPS885202422	20" X 24" X 22"	47	MERV 13	\$45.00
EPS885242422	24" X 24" X 22"	62	MERV 13	\$58.00
EPS895122422	12" X 24" X 22"	31	MERV 14 95%	\$34.00
EPS895202422	20" X 24" X 22"	47	MERV 14	\$60.00
EPS895242422	24" X 24" X 22"	62	MERV 14	\$65.00

ASHRAE SERIES – CARTRIDGE FILTER



High efficiency micro-fine glass mat. Rolled edge. Aluminum separators. UL900 Class 2

Stock #	Size	Model	Efficiency	List Price
ECN95122412	12" X 24" X 12"	Double header	MERV 14	\$125.00
ECN95242412	24" X 24" X 12"	Doubleheader	MERV 14	\$177.00
ECS95122412	12" X 24" X 12"	Single header	MERV 14	\$125.00
ECS95242412	24" X 24" X 12"	Single header	MERV 14	\$177.00

V-BANK FP MINI PLEATED



Strong. Exceptional burst strength. Nominal air flow up to 3000 CFM per cell. Largest filter area available (193 sq. ft.) Lowest pressure drop-highest energy savings. Rigid cellular structure – no dust migration – no fiber break-off.

Stock #	Size	Cfm Capacity	Efficiency	List Price
FP85122412	12" X 24" X 12"	3000	MERV 13	\$174.00
FP85242412	24" X 24" X 12"	3000	MERV 13	\$230.00
FP95122412	12" X 24" X 12"	3000	MERV 14	\$175.00
FP95242412	24" X 24" X 12"	3000	MERV 14	\$235.00

CEL PAD FOR EVAP COOLERS

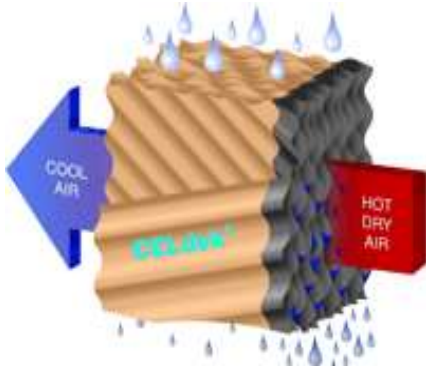

Evaporative Cooler pad. Rigid media.
Custom cut to your specifications.

Standard Sizes	Net Price
12" X 12" X 48" high	\$12.50 cu. Ft.
12" X 12" X 60" high	\$12.50 cu. Ft.
12" X 12" X 72" high	\$12.50 cu. Ft.

PAINT ARRESTORS



Paint overspray control.

Standard Efficiency			
Stock #	Size	Quantity	List Price
3031	20" X 25" X 1"	70 per box	\$104.00 / box
3032	20" X 20" X 1"	70 per box	\$90.00 / box

High Efficiency			
Stock #	Size	Quantity	List Price
3232	20" X 20" X 1"	60 per box	\$100.00 / box
3266	30' X 45" X 1"	1 roll	\$54.00 / roll
3331	20" X 25" X 1"	60 per box	\$144.00 / box
3351	6' X 45" X 1"	5 rolls	\$68.00 / bag

SECTION 7

GAS DETECTION

Honeywell Analytics Gas Detection 52

HONEYWELL ANALYTICS GAS DETECTION



E3 Point

Standalone, remote or network versions. Connects to analog or digital systems. Works with most BAS including BACnet, Modbus or LonWorks. Connects to wired System via 301C Controller. Factory-calibrated cartridges. Utilizes factory-calibrated plug-n-play sensor cartridges.

Power requirement: 24Vac/dc

Stock #	Description	List
E3SCO	CO Sensor Cartridge (Carbon Monoxide)	\$270.00
E3NO2	NO ₂ Sensor Cartridge (Nitrogen Dioxide)	\$490.00
E3M	CH ₄ Sensor Cartridge (Methane)	\$490.00
E3SM	E3 Point Network - BACnet	\$860.00
E3SAH	E3 Point, Analog 120V	\$860.00
301-C-DLC	Controller w/ Datalogger	\$3,330.00
301-C-DLC-BIP	Controller w/ Datalogger & BACnet/IP	\$5,880.00
T100VA	100VA Transformer	\$270.00
VA201TA50	50VA Transformer	\$120.00



Plug-N-Play Sensor Cartridge



301 Controller

Main AC Input Voltage: 120Vac

Norman S. Wright Co.

Date: _____



Manufacturer's Representative
2121 E. Magnolia St., Phoenix, AZ 85034
Ph: 602-275-4467 Fax: 602-275-6516

PO #: _____

ORDER FORM

Order Desk (602) 275-1637

BILL THIS ORDER TO:

SHIP THIS ORDER TO: (if different than billing address)

Name: _____

Name: _____

Address: _____

Address: _____

City: _____ St: _____ Zip: _____

City: _____ St: _____ Zip: _____

Phone: _____

Phone: _____

Email: _____

Email: _____

Stock #	Quantity Ordered	Description of Product	Unit Price	Total Price

PAYMENT METHOD: VISA MASTERCARD
(Please Circle) AMEX DISCOVER
Check Cash Money Order Credit Card

SUBTOTAL:	
TAX:	
TOTAL:	

Card #: _____
Exp. Date: _____
Signature: _____
Tax Exemption #: _____

THANK YOU FOR YOUR ORDER!

Serving the Southwest since 1952



PHOENIX, AZ

2121 E. Magnolia, Phoenix, AZ
85034
Tel: (602) 275-4467
(800) 275-4461
Fax: (602) 275-6516



TUCSON, AZ

2917 E. Ganley, Tucson, AZ 85706
Tel: (520) 790-4490
Fax: (520) 790-4673



ALBUQUERQUE, NM

4303 Ellison NE, Albuquerque,
NM 87109
Tel: (505) 345-8811
Fax: (505) 344-8535



EL PASO, TX

1220 Barranca Dr Ste 5G El Paso, TX
79935
Tel: (915) 772-9381
Fax: (915) 772-7910