



Nortel Communication Server 1000

# IP Phone 1120E

## User Guide





# Revision history

## **June 2006**

Standard 2.00. This document is up-issued to support Nortel Communication Server 1000 Release 4.5 software. Added support for new security features.

## **January 2006**

Standard 1.00. This document is issued to support Nortel Communication Server 1000 Release 4.5 software.



# Contents

<b>About the Nortel IP Phone 1120E</b> .....	<b>11</b>
Basic features .....	11
Telephone controls .....	13
Telephone display .....	19
Call features and Flexible Feature Codes .....	19
Security features .....	20
Using Encrypted Calling .....	20
Managing your Station Control Password (SCPW) .....	20
<b>Entering and editing text</b> .....	<b>23</b>
Entering text using the dialpad .....	23
Editing text using the soft keys .....	24
Entering text using the USB keyboard .....	25
<b>Connecting the components</b> .....	<b>26</b>
Before you begin .....	27
Connecting the components of the phone .....	27
<b>Configuring Telephone Options</b> .....	<b>32</b>
Time offset .....	32
Using the Telephone Options menu .....	33
Adjusting the volume .....	35
Adjusting the display screen contrast .....	36
Selecting a language .....	36
Selecting date and time format .....	37
Accessing display diagnostics .....	38
Choosing local dialpad tone .....	38
Viewing telephone information .....	39
Diagnostics .....	40
Configuring call log options .....	41

Choosing a ring type .....	45
Enabling or disabling Call Timer .....	46
Enabling OnHook Default Path .....	47
Changing feature key labels .....	47
Configuring the name display format .....	49
<b>Configuring Local Menu options .....</b>	<b>51</b>
Using the 1. Preferences submenu .....	53
Changing 1. Display Settings .....	53
Changing 2. Language .....	55
Using the 2. Local Diagnostics submenu .....	56
Using 1. IP Set&DHCP Information .....	56
Using 2. Network Diagnostic Tools .....	56
Using 3. Ethernet Statistics .....	56
Using 4. IP Network Statistics .....	56
Using 5. USB Devices .....	57
Using the 3. Network Configuration menu .....	57
Using the 4. Lock Menu .....	57
<b>Making a call .....</b>	<b>58</b>
Using Off-hook dialing .....	58
Using On-hook dialing .....	59
Using handsfree dialing .....	60
Using the Directory applications .....	62
Making a call using Corporate Directory .....	62
Making a call using the Personal Directory .....	63
Making a call using the Callers List .....	64
Making a call using the Redial List .....	65
Viewing the date and time of a call .....	65
Using Predial .....	66
Using AutoDial .....	67
Using Ring Again .....	69

Using Last Number Redial . . . . .	70
Using Speed Call . . . . .	71
Using System Speed Call . . . . .	72
Using HotLine . . . . .	72
Using intercom calling . . . . .	73
<b>Answering a call . . . . .</b>	<b>74</b>
<b>While on an active call . . . . .</b>	<b>75</b>
Placing a call on hold . . . . .	75
Transferring a call . . . . .	76
Using Timed Reminder Recall . . . . .	77
Using Attendant Recall . . . . .	78
Using Call Park . . . . .	79
Recording a Calling Party Number . . . . .	81
Displaying incoming call information . . . . .	81
Tracing a malicious call . . . . .	82
<b>Incoming calls . . . . .</b>	<b>83</b>
Using Automatic Answerback . . . . .	83
Using Call Pickup . . . . .	83
Using Call Waiting . . . . .	85
<b>While away from your desk . . . . .</b>	<b>87</b>
Using Call Forward . . . . .	87
Using Internal Call Forward . . . . .	88
Using Remote Call Forward . . . . .	89
Securing your telephone . . . . .	91
<b>Talking with more than one person . . . . .</b>	<b>93</b>
Using the Call Join feature . . . . .	93

Setting up a conference call . . . . .	94
Using Conferee Selectable Display . . . . .	95
Using Group Call . . . . .	96
<b>Working without interruption . . . . .</b>	<b>99</b>
Activating Make Set Busy . . . . .	99
<b>Additional call features . . . . .</b>	<b>100</b>
Using AutoDial Transfer . . . . .	100
Using the Buzz feature . . . . .	101
Using Call Page Connect to make an announcement . . . . .	101
Using Centrex/Exchange Line Switchhook Flash . . . . .	102
Charging a call or charging a forced call . . . . .	102
Using Enhanced Override . . . . .	105
Using Forced Camp-on . . . . .	106
Overriding a busy signal . . . . .	107
Using Privacy Release . . . . .	108
Using Radio Page . . . . .	109
Using Voice Call . . . . .	111
<b>Additional phone features . . . . .</b>	<b>112</b>
Using the Personal Directory . . . . .	112
Using the Callers List . . . . .	115
Using the Redial List . . . . .	117
Using Virtual Office . . . . .	119
Logging in to Virtual Office . . . . .	120
Using Virtual Office on your Remote telephone . . . . .	121
Using Virtual Office on your Office telephone . . . . .	124
Logging out of Virtual Office . . . . .	125
Troubleshooting Virtual Office . . . . .	126
Using Media Gateway 1000B . . . . .	128



Using Test Local Mode .....	129
Using Resume Normal Mode .....	129
Troubleshooting MG 1000B .....	130
<b>Using Hospitality features .....</b>	<b>132</b>
Configuring Automatic Wake-Up .....	132
Activating Message Registration .....	134
Using Maid Identification .....	136
Displaying Room Status .....	137
<b>Accessing External Server Applications .....</b>	<b>139</b>
<b>Flexible Feature Codes (FFC) .....</b>	<b>140</b>
<b>Terms you should know .....</b>	<b>143</b>
<b>Regulatory and safety information .....</b>	<b>149</b>
DenAn regulatory notice for Japan .....	151
Other .....	151
<b>Index .....</b>	<b>153</b>



# About the Nortel IP Phone 1120E

The Nortel IP Phone 1120E brings voice and data to the desktop by connecting directly to a Local Area Network (LAN) through an Ethernet connection.

**Note:** In this guide, user-defined feature key labels appear beside the keys, and soft key labels appear directly above the keys. Figure 1 shows the key labels.

**Figure 1: User-defined feature keys and soft keys**

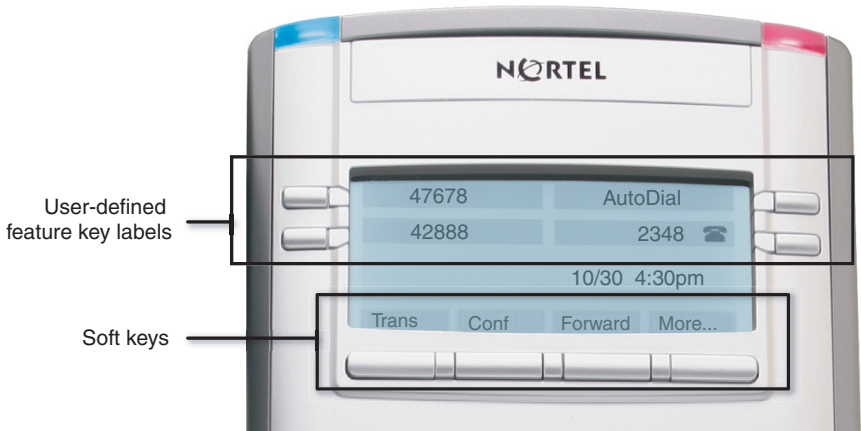

## Basic features

Your IP Phone 1120E supports the following features:

- four user-defined feature keys with labels and indicators
- four soft keys

**Note:** Some IP Phone 1120E phones are not configured to support soft key functionality. Consult your system administrator.

- graphical, high-resolution LCD display, backlit, with adjustable contrast
- high-quality speaker phone

- volume control keys for adjusting ringer, speaker, handset, and headset volume
- six specialized feature keys:
  - Quit
  - Directory
  - Message/Inbox
  - Shift/Outbox
  - Services
  - Copy
- six call-processing fixed keys:
  - Mute
  - Handsfree
  - Goodbye
  - Expand to PC
  - Headset
  - Hold
- gigabit Ethernet ports
- built-in gigabit Ethernet switch for shared PC access
- headset jack with an On/Off key
- USB port to support a keyboard or mouse
  - Note:** Powered downstream 1.1-compliant USB hubs are supported, including USB 2.0 hubs, if they offer USB 1.1 backwards compliancy.
- automatic network configuration
- graphical XAS
- hearing aid compatibility

Figure 2 on page 13 shows the IP Phone 1120E.

**Figure 2: IP Phone 1120E**



\*Note: If supported by your server, the Feature Status Lamp provides a user-defined alert. Contact your system administrator to find out if this feature is available for you.

## Telephone controls

**Note:** In some geographic regions, the IP Phone 1120E is offered with key caps that have English text labels. Text in parentheses indicates labels appearing on the key caps, for example, (Services).



**Soft keys** are located below the display area. The LCD label above each key changes based on the active feature.

When a triangle appears before a soft key label, the feature is active.

Press the **More** key to access the next layer of soft keys (self-labeled).



The keys on either side of the LCD display area are **user-defined feature keys**, with labels on the LCD. These keys also function as **line (DN)** keys.

2493



A steady LCD light beside a line (DN) key indicates that the line is active. A flashing LCD light indicates the line is on hold or the feature is being programmed.

GrpC1



A steady LCD light beside a feature key indicates that the feature is active. A flashing LCD light indicates that the feature is being programmed.

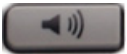

(Volume +)



(Volume -)

Use the **Volume control** buttons to adjust the volume of the ringer, handset, headset, speaker, and the Handsfree feature. Press the top button to increase the volume, and press the bottom button to decrease volume.



(Mute)

Press the **Mute** key to listen to the receiving party without transmitting. Press the **Mute** key again to return to two-way conversation. The **Mute** key applies to handsfree, handset, and headset microphones.

**Note:** The Mute LED indicator, located on the **Mute** key, flashes to indicate that the microphone is muted.



(Handsfree)

Press the **Handsfree** key to activate handsfree.

**Note:** The Handsfree LED indicator, located on the **Handsfree** key, lights to indicate when handsfree is active.



Use the **Navigation** keys to scroll through menus and lists appearing on the LCD display screen. The outer part of this key cluster rocks for up, down, left, and right movements.



Press the **Enter** key, at the center of the Navigation key cluster, to confirm menu selections.

In many cases, you can use the **Enter** key instead of the **Select** soft key.



(Hold)

Press the **Hold** key to put an active call on hold. Tap the flashing line (DN) soft key to return to the caller on hold.

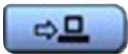

(Expand)

Use the **Expand to PC** key to access external server applications



(Headset)

Press the **Headset** key to answer a call using the headset or to switch a call from the handset or handsfree to the headset.

**Note:** The Headset LED indicator, located on the **Handsfree** key, lights to indicate that the headset is in use.



(Goodbye)

Use the **Goodbye** key to terminate an active call.



When a message is waiting, the red **Visual Alerter/Message Waiting** indicator flashes. Also, when the ringer sounds, this indicator flashes.



When your IP Phone 1120E firmware is being updated, the blue **Feature Status Lamp** flashes.

**Note:** To find out if additional features are supported, contact your administrator.



(Copy)

Press the **Copy** Key to copy entries to your Personal Directory from other lists, such as the Caller List, Redial List, and Corporate Directory.





(Services)

Press the **Services** key to open the Services menu, and use the navigation keys to access the following items:

- Telephone Options:
  - Volume adjustment
  - Contrast adjustment
  - Language
  - Date/Time
  - Display diagnostics
  - Local Dialpad Tone
  - Set Info
  - Diagnostics
  - Call Log Options
  - Ring type
  - Call Timer
  - On hook default path
  - Change Feature Key Label
  - Name Display Format

- Password Admin:
  - Station Control Password

**Note:** The **Password Admin** menu is not available on all IP Phone 1120E sets. Consult your system administrator.

- Virtual Office Login and Virtual Office Logout (if Virtual Office is configured)
- Test Local Mode and Resume Local Mode (if Media Gateway 1000B is configured)



(Services)

(continued)

Press the **Services** key to exit from any menu or menu item.



(Services)



(Services)

Press the **Services** key twice to access the Local Tools menu, and use the navigation keys to access the following items:

- 1. Preferences
- 2. Local Diagnostics
- 3. Network Configuration
- 4. Lock Menu

**Note:** Your system administrator can establish a password for the Local Tools menu. If you attempt to access the Local Tools menu and a password prompt dialog box appears, contact your system administrator.



(Quit)

Press the **Quit/Stop** key to exit an active menu or dialog. Pressing the **Quit/Stop** key does not affect the status of active calls.

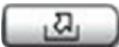

(Shift/Outbox)

The **Shift/Outbox** key is a fixed key that is reserved for future feature development.



(Msg/Inbox)

Press the **Message/Inbox** key to access your voice mailbox.

**Note:** This function is not available on all phones; consult your administrator.



(Directory)

Press the **Directory** key to access directory services.

## Telephone display

Your IP Phone 1120E has three display areas:

- The upper display area provides labels for the four user-defined feature key labels.
- The middle display area contains single-line information for items such as caller number, caller name, Call Timer, feature prompt string, user-entered digits, date and time information, and telephone information.
- The lower display area provides labels for the four soft keys.

Figure 3 shows an idle LCD screen.

**Figure 3: IP Phone 1120E LCD screen**

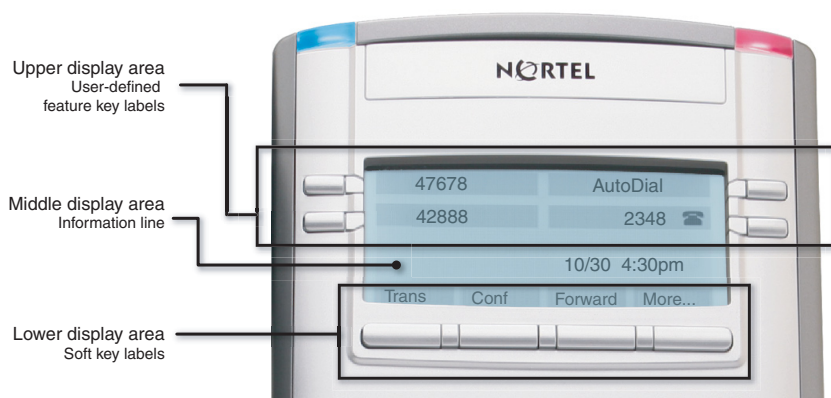

## Call features and Flexible Feature Codes

Some features are not available on all telephones. Call features and Flexible Feature Codes (FFCs) must be assigned to your telephone and supported by system software. Contact your system administrator to configure these features and codes on your telephone.

## Security features

---

The following security features are available on your IP Phone 1120E:

- Using Encrypted Calling
- Managing your Station Control Password (SCPW)

### Using Encrypted Calling

Your IP Phone 1120E supports secure communication using SRTP Pre-Shared Key (PSK) encryption. If the feature is enabled, a security icon (🔒) is displayed on the screen when your call is secured using SRTP (PSK). Contact your system administrator to find out if this feature is available for your use.

### Managing your Station Control Password (SCPW)

Your Station Control Password (SCPW) enables the following security features:

- Electronic Lock to prevent others from making calls from your telephone
- password-protected telephone features (for example, Personal Directory, Redial List, and Callers List)

Your system administrator defines your initial SCPW. Contact your system administrator for detailed information.

#### To change your password (SCPW):



(Services)

1. Press the **Services** key.



2. Press the **Up/Down** navigation keys to scroll and highlight **Password Admin**.



3. Press the **Enter** key.



4. Use the dialpad to enter your password at the prompt.



5. Press the **Up/Down** navigation keys to scroll and highlight **New Password**.



6. Press the **Enter** key.



7. Use the dialpad to enter the new password.



8. Press the **Enter** key to accept the new password.

**Note:** If you are locked out of your IP Phone 1120E, or if you forget your SCPW, contact your system administrator.

**Note:** The default configuration for Password Protection is off.

**To turn Password Protection on or off:**



1. Press the **Directory** key.



2. Press the **Up/Down** navigation keys to scroll and highlight **Change Protection Mode**.



3. Use the dialpad to enter your password (if Password Protection is enabled).

Enter



4. Press the **Enter** soft key.



5. Press the **Up/Down** navigation keys to highlight one of the following:
  - Enable Password Protection
  - Disable Password Protection

Yes

No



or



6. Choose one of the following soft keys:
  - **Yes** to accept the selection
  - **No** to return to the Directory menu

Done



7. Press the **Done** soft key.

# Entering and editing text

You can enter and edit text on your IP Phone 1120E using the following methods:

- “Entering text using the dialpad” on page 23
- “Editing text using the soft keys” on page 24
- “Entering text using the USB keyboard” on page 25

The use of any of these methods for text entry depends on the application. Table 1 shows the applications and input devices that you can use for text entry.

**Table 1: Application text entry**

For:	Use:
Call Server-related applications (for example, changing feature key labels, adding personal directory entries, or dialing)	Dialpad USB keyboard for numeric entries only
Graphical applications	USB keyboard
Local Tools menu	USB keyboard Dialpad for numeric entries

## Entering text using the dialpad

You can use the dialpad to enter text when you use features such as Personal Directory, Redial List, and Callers List.

For example, if you want to use the letter A, press the number **2** key once. If you want the letter C, press the number **2** key three times.

**Note:** No letters are associated with the number 1 or the 0 keys.

## Editing text using the soft keys

You can use soft keys to edit text when you use features such as Personal Directory, Redial List, and Callers List.

To edit an entry in your Personal Directory, press the **Directory** key, and select the desired entry from your Personal Directory.

### To edit text with the soft keys:

1. Press the **Edit** soft key.
2. Press the **Left/Right** navigation keys to move through the text.
3. Select the appropriate editing soft key for the operation you want to perform.
4. If the character you want is not visible, press the **More..** soft key to access the next layer of soft keys.
5. To add non-alphanumeric symbols, press the **Symbol** soft key, and perform the following:
  - a. Press the **Up** navigation key to access the symbols.
  - b. Press the **Left/Right** navigation keys to move to a specific symbol.
  - c. Press the **Choose** soft key to select a symbol.
6. Press the **Next** soft key to submit your changes.

Table 2 describes the soft key editing functions on your IP Phone 1120E.

**Table 2: Editing soft key description (Part 1 of 2)**

Key	Description
Cancel	Action is cancelled.
Choose	Select a non-alphanumeric symbol (available only after the <b>Symbol</b> soft key is selected).
Clear	Clear the input field.



**Table 2: Editing soft key description (Part 2 of 2)**

Key	Description
Case	Switch the next character to either uppercase or lowercase.
Delete	Backspace one character.
Done/Select/Enter	Meaning depends on application.

## Entering text using the USB keyboard

You can use the USB keyboard, when connected, to enter text in the tools and graphical applications.

For number entry in telephone applications (for example, when dialing), you can use the keyboard to enter digits (0–9), as well as \* and #. Other characters are ignored.

When on a call, you can use the function keys (f1, f2, f3, f4, f5, f6, f7, and f8) to control the telephone. Table 3 shows the function keys and their associated action during telephone calls.

**Table 3: USB keyboard function keys during telephone calls**

Function key	Action
f1	Go to Handsfree mode
f2	Go to Headset mode
f3	Place the current call on hold
f4	Mute the current call
f5	Volume up
f6	Volume down
f7	Copy
f8	Quit

# Connecting the components

Figure 4 on page 26 shows connections on the IP Phone 1120E.

**Figure 4: IP Phone 1120E connections**

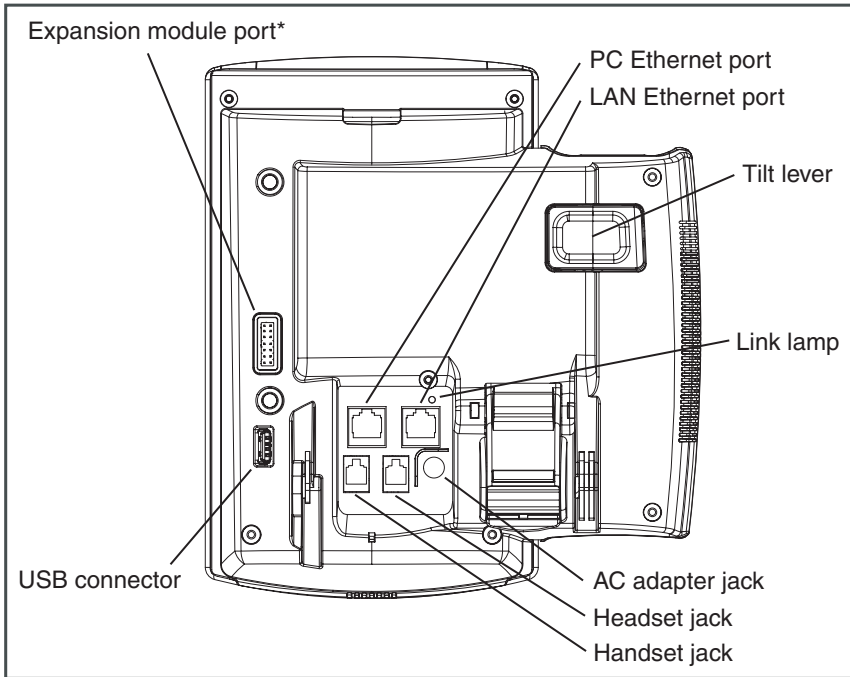

**WARNING** \*Ensure that the protective rubber cap on the EM 1100 Expansion Module port is in place when the port is not in use. Connecting anything other than the proper Expansion Module connector to this port can cause damage to the phone.

## Before you begin

---

**CAUTION****Damage to Equipment**

Do not plug your IP Phone 1120E into a regular telephone jack. This results in severe damage to the IP Phone. Consult your system administrator to ensure that you plug your phone into a 10/100/1000BaseT Ethernet jack.

**CAUTION**

Your IP Phone 1120E is designed for use in an indoor environment only.

## Connecting the components of the phone

---



**WARNING** Your IP Phone 1120E is shipped with the base locked in position. To avoid damaging your phone, press the wall-mount lever, located just under the Handsfree key as indicated in Figure 7 on page 31, to release the base and pull it away from the phone.

Use the following steps to connect the components of your phone.

1. Remove the stand cover. Pull upward on the center catch as indicated in Figure 5, and remove the stand cover. The cable routing tracks are now accessible.

**Figure 5: Remove the stand cover**

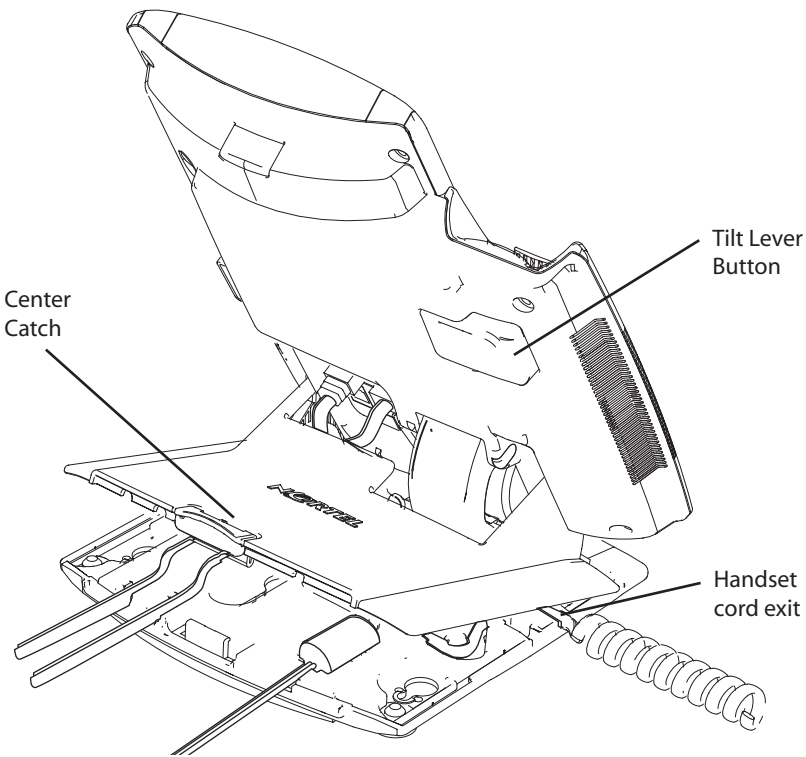









2. Connect the AC power adapter (optional). Connect the adapter to the AC adapter jack in the bottom of the phone. Form a small bend in the cable, and then thread the adapter cord through the channels in the stand.

**Warning:** Use your IP Phone 1120E with the approved Nortel AC Adapter (model #N0023000) for this model of phone only.

**Note 1:** Your IP Phone 1120E supports both AC power and Power over Ethernet options, including IEEE 802.3af standard power. To use local AC power, the optional AC adapter can be ordered separately. To use Power over Ethernet, where power is delivered over the CAT-5 cable, the LAN must support Power over Ethernet, and an AC adapter is not required.

**Note 2:** You must use CAT-5e (or later) cables if you want to use gigabit Ethernet.

3. Install the handset. Connect the end of the handset cable with the short straight section into the handset. Connect the end of the handset cable with the long straight section to the back of the phone, using the RJ-9 handset jack marked with the symbol . Form a small bend in the cable, and then thread the handset cord through the channels in the stand so that it exits behind the handset on the right side, in the Handset cord exit in the stand base marked with the symbol , as shown in Figure 5.
4. Install the headset (optional). If you are installing a headset, plug the connector into the RJ-9 headset jack marked with the symbol  on the back of the phone, and thread the headset cord along with the handset cord through the channels in the stand, so that the headset cord exits the channel marked with the symbol .
5. Install the Ethernet cable. Connect one end of the supplied Ethernet cable to the back of your phone using the RJ-45 connector marked with the symbol , and thread the network cable through the channel marked with the symbol .
6. Install the Ethernet cable connecting the PC to the phone (optional). If you are connecting your PC Ethernet through the phone, connect one end of the PC Ethernet cable to your phone using the RJ-45 connector marked with the symbol , and thread it through the channel marked with the symbol . Connect the other end to the LAN connector on the back of your PC.
7. Install additional cables. If applicable, plug in optional USB devices. Connect the Ethernet cable to the LAN Ethernet connection. If you are using an AC power adapter, plug the adapter into an AC outlet.

**Figure 6: Cable routing tracks and mounting holes**

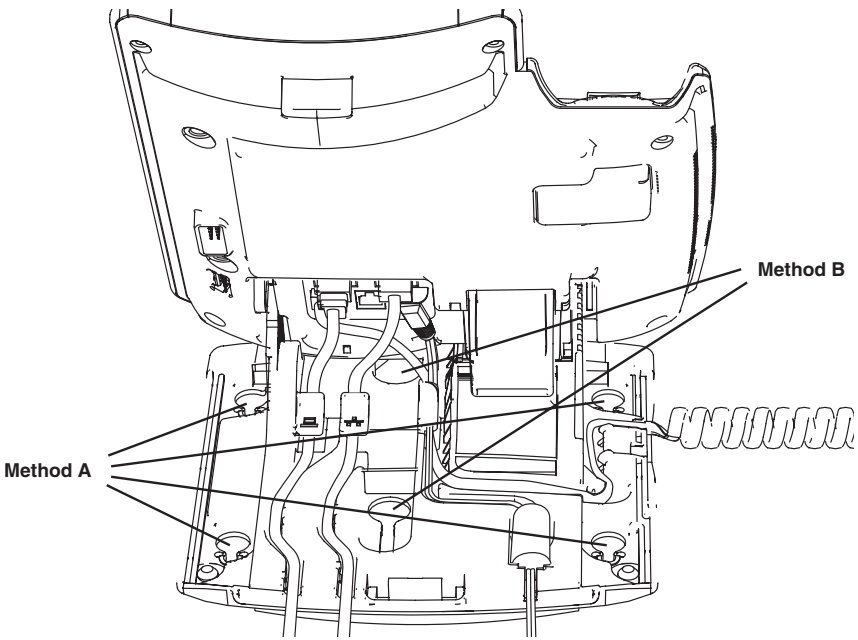

8. Wall-mount your phone (optional). Your IP Phone 1120E can be mounted either by: (Method A) using the mounting holes on the bottom of the phone stand, or (Method B) using a traditional-style wall-mount box with an RJ-45 connector and a 15-cm (6-inch) RJ-45 cord (not provided).

*Complete steps 1-7, as needed, before you wall-mount your phone:*

**Method A:** Press the wall-mount lever, and pull the phone away from the stand, as shown in Figure 5. Using the stand cover (the part you removed in step 1), mark the wall-mount holes by pressing the bottom of the stand cover firmly against the wall in the location where you wish to install the phone. Four small pins on the bottom of the stand cover make marks on the wall. Use the marks as a guideline for installing the wall-mount screws (not provided). Install the screws so that they protrude 3 mm (1/8 inch) from the wall, and then install the phone stand mounting holes over the screw heads as indicated in Figure 4 (Method A). You may need to remove the phone from the wall to adjust the lower screws. When the lower screws are snug, install the phone on the mounting screws, and then tighten the top screws.

**Figure 7: Rotate the phone into the wall mount position.**

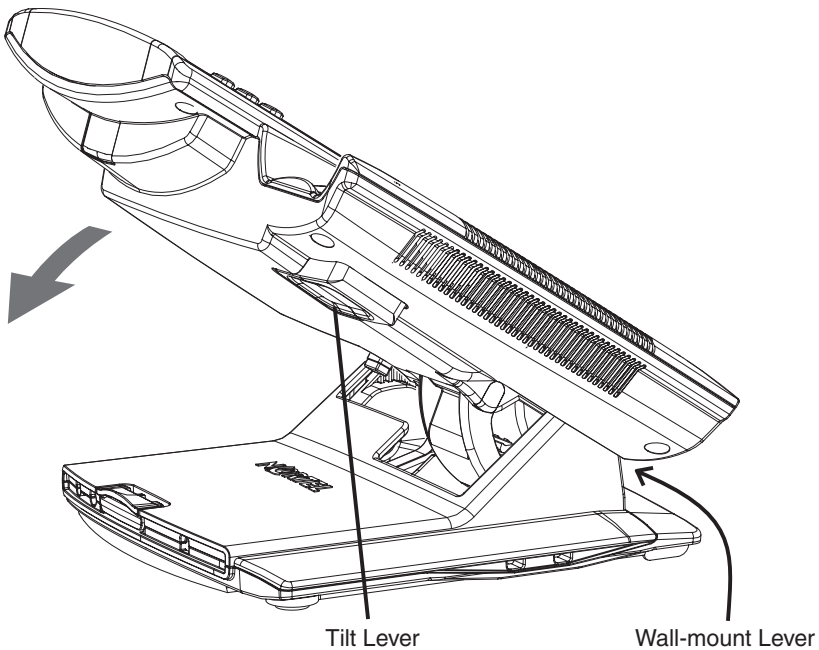

**Method B:** Attach the 15-cm (6-inch) CAT5e cable, position the stand over the mounting rivets, and slide the phone down the wall so that the rivets fit into the slots on the stand, indicated in Figure 6 on page 30 (Method B).

9. Replace the stand cover. Ensure that all cables are neatly routed and press the stand cover into place until you hear a click
10. Put the phone in the wall-mount position (optional). If you wall-mounted your phone, put it in the wall-mount position by holding the Tilt Lever and pressing the phone towards the base until the phone is parallel with the base. Release the Tilt Lever and continue to push the phone towards the base until you hear an audible click. Ensure the phone is securely locked in position



# Configuring Telephone Options

## Time offset

---

When your Nortel IP Phone 1120E is located in a different time zone from your system, the display shows the system time, not the local time. The Time Offset feature allows you to adjust the time that appears on the display.

Before you adjust the time, calculate the time difference, in hours, between the server time and local time. To change the time that appears on your telephone display to local time:

- Press the **Feature** soft key.
- Use the telephone dialpad () to enter \*510.
- Press the **CHANGE** soft key.
- Press \* on the telephone dialpad to switch between adding or subtracting time.
- Use the telephone dialpad () to enter the number of hours between local time and system time.

**Note:** Press # to enter half hour increments.

- Press the **OK** soft key.

The change can take up to 1 minute to appear on the display.

The **Services** menu lists the following submenus:

- The **Telephone Options** menu enables you or your system administrator to configure telephone preferences.
- **Password Admin** menu enables you or your system administrator to change the Station Control Password (SCPW).
- The **Virtual Office Login** and **Test Local Mode** (for Branch Office) menus are listed when an IP Phone 1120E Class of Service is configured for Virtual Office and Branch Office. For more information, see page 119.



**Note:** The **Password Admin**, **Virtual Office Login**, and **Test Local Mode** menus are not available on all IP Phone 1120E telephones. Consult your system administrator.

**Figure 8: Telephone Options menu**

Volume adjustment	Diagnostics
Contrast adjustment	Call Log Options
Language	Ring type
Date/Time	Call Timer
Display diagnostics	On hook default path
Local Dialpad Tone	Change Feature Key Label
Set Info	Name Display Format

## Using the Telephone Options menu

Use the **Telephone Options** menu to access the following:

- “Adjusting the volume” on page 35
- “Adjusting the display screen contrast” on page 36
- “Selecting a language” on page 36
- “Selecting date and time format” on page 37
- “Accessing display diagnostics” on page 38
- “Choosing local dialpad tone” on page 38
- “Viewing telephone information” on page 39
- “Diagnostics” on page 40
- “Configuring call log options” on page 41
- “Choosing a ring type” on page 45
- “Enabling or disabling Call Timer” on page 46
- “Enabling OnHook Default Path” on page 47

- “Changing feature key labels” on page 47
- “Configuring the name display format” on page 49

When an option has a submenu, an ellipses (...) appears after the option.

### To use the Telephone Options menu:



1. Press the **Services** key.



2. Press the **Up/Down** navigation keys to scroll and highlight **Telephone Option**.



3. Press the **Enter** key.



4. Use the **Up/Down** navigation keys to scroll and highlight an option (for example, **Language...**).



5. Press the **Enter** key. The display provides information required to adjust your selection.

6. Choose one of the following:



- Press the **Select** soft key to save changes and return to the **Telephone Options** menu.
- Press the **Cancel** soft key to keep existing configurations.

## Adjusting the volume

To adjust the volume, press the **Services** key, select **Telephone Options**, and select **Volume adjustment...**

To adjust the volume:



1. Press the **Up/Down** navigation keys to scroll and highlight one of the following:

- **Ringer**
- **Handset listen**
- **Handsfree listen**
- **Headset listen**
- **Buzzer**



2. Press the **Enter** key.

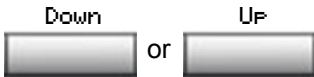

or



3. To increase or decrease the volume, do one of the following:
  - Press the **Down** and **Up** soft keys.
  - Press the **Up/Down** navigation keys.

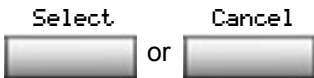

4. Choose one of the following:
  - Press the **Select** soft key to save the volume level and return to the **Telephone Options** menu.
  - Press the **Cancel** soft key to keep existing configurations.

### Adjusting the display screen contrast

To adjust the LCD display screen contrast, press the **Services** key, select **Telephone Options**, and select **Contrast adjustment**.

**Note 1:** If you have an EM 1100 Expansion Module for the IP Phone attached to your telephone, adjusting the telephone's LCD screen contrast also adjusts the display screen contrast configuration for the Expansion Module.

**Note 2:** You can also adjust the contrast using the Local Tools menu; Nortel recommends that you use the control in the Telephone Options menu.

To adjust the display screen contrast:

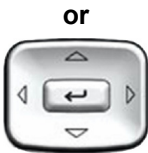

1. To increase or decrease the display contrast level, choose one of the following:

- Press the **Lower** and **Higher** soft keys.
- Press the **Up/Down** navigation keys.

2. Choose one of the following:



- Press the **Select** soft key to save the contrast level and return to the **Telephone Options** menu.
- Press the **Cancel** soft key to keep existing configurations.

### Selecting a language

The display is available in multiple languages. To choose a language, press the **Services** key, select **Telephone Options**, and select **Language...**

**Note:** This language setting controls the language used by features on your phone only. To set the language used elsewhere on your phone, press **Services** twice, select Preferences, and select Language.

**To select a language:**



1. Press the **Up/Down** navigation keys to scroll and highlight the desired language (for example, German [Deutsche]).

2. Choose one of the following:

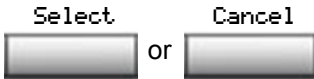

- Press the **Select** soft key to save the language and return to the **Telephone Options** menu.
- Press the **Cancel** soft key to keep existing configurations.

## Selecting date and time format

Several date and time formats are available. Formats are based on the 12-hour and 24-hour clocks. To select the date and time format, press the **Services** key, select **Telephone Options**, and select **Date/Time...**

**To select a date and time format:**



1. Press the **Up/Down** navigation keys to scroll and highlight the desired format. Sample formats appear on the upper-right side of the display area.

2. Choose one of the following:

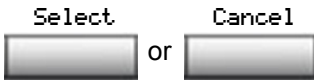

- Press the **Select** soft key to save the format and return to the **Telephone Options** menu.
- Press the **Cancel** soft key to keep existing configurations.

## Accessing display diagnostics

The Display diagnostics option tests the telephone's display screen and indicator lights. To access display diagnostics, press the **Services** key, select **Telephone Options**, and select **Display diagnostics**.

To select Display diagnostics:



1. Press the **Up/Down** navigation keys to scroll through the list to view display capabilities.



2. Press the **Cancel** soft key to return to the **Telephone Options** menu.

## Choosing local dialpad tone

The Local DialPad Tone option produces Dual-Tone Multi-Frequency (DTMF) sounds, a single tone, or no sound when you press a key on the dialpad. To choose a local dialpad tone, press the **Services** key, select **Telephone Options**, and select **Local DialPad Tone**.

To choose a local dialpad tone:



1. Press the **Up/Down** navigation keys to highlight one of the following dialpad tones:
  - **None** to disable all tones
  - **Short Click** to enable a single tone for all keys
  - **DTMF** to turn on a separate DTMF tone for each key

2. Choose one of the following:

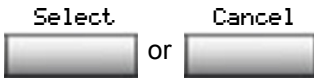

- Press the **Select** soft key to save the tone selection and return to the **Telephone Options** menu.
- Press the **Cancel** soft key to keep existing configurations.

## Viewing telephone information

The Set Info option displays the following telephone-specific information:

- General Information
- Set IP Information
- Ethernet Information
- Server Information

To view telephone information, press the **Services** key, select **Telephone Options**, and select **Set Info**.

To view telephone information:

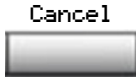

1. Press the **Up/Down** navigation keys to scroll through the list to view the telephone information.
2. Press the **Cancel** soft key to return to the **Telephone Options** menu.

## Diagnostics

The Diagnostics option displays the following telephone-specific information:

- Diag Tools (Ping, do Route Traces)
- EtherStats (Speed, Auto Neg, CRC Errors, Collision)
- IP Stats (Packet Info)
- RUDP Stats (Msg receive/trans)
- QOS Stats

To view diagnostic information, press the **Services** key, select **Telephone Options**, and select **Diagnostics**.

To view telephone information:



1. Press the **Up/Down** navigation keys to scroll through the list of diagnostic information.
2. Press the **Cancel** soft key to return to the **Telephone Options** menu.



## Configuring call log options

Use the call log option to configure the following preferences:

- “Configuring the Callers List log” on page 41
- “Configuring New Call Indication” on page 42
- “Configuring Preferred Name Match” on page 43
- “Configuring Area Code Setup” on page 43

### Configuring the Callers List log

You can configure the Callers List to log all incoming calls or only unanswered calls. The default configuration is Log all calls. To log unanswered calls only, press the **Services** key, select **Telephone Options**, and select **Call Log Option**.

To log only unanswered calls:



1. Press the **Up/Down** navigation keys to scroll and highlight the **Log Mode** option.



2. Press the **Enter** key.



3. Press the **Up/Down** navigation keys to scroll and highlight **Log unanswered calls**.



4. Choose one of the following:
  - Press the **Select** soft key to save the configuration.
  - Press the **Cancel** soft key to keep existing configurations.

### Configuring New Call Indication

You can configure your IP Phone 1120E to display a message to indicate that a new incoming call was received. The default configuration is On. To configure new call indication, press the **Services** key, select **Telephone Options**, and select **Call Log Option**.

To configure New Call Indication:



1. Press the **Up/Down** navigation keys to scroll and highlight the **Log Mode** option.



2. Press the **Enter** key.



3. Press the **Up/Down** navigation keys to scroll and highlight **New Call Indication**.



4. Press the **Enter** key.



5. Press the **Up/Down** navigation keys to scroll and highlight one of the following:

- **New call indication off**
- **New call indication on**

6. Choose one of the following:

- Press the **Select** soft key to save the configuration.
- Press the **Cancel** soft key to keep existing configurations.

Select

Cancel

or



## Configuring Preferred Name Match

You can configure your IP Phone 1120E to display the name of the caller as defined in your Personal Directory. The default configuration is Off. To configure Preferred Name Match, press the **Services** key, select **Telephone Options**, and select **Call Log Option**.

To configure Preferred Name Match:



1. Press the **Up/Down** navigation keys to scroll and highlight **Preferred Name Match**.



2. Press the **Enter** key.



3. Press the **Up/Down** navigation keys to scroll and highlight one of the following:
  - **Preferred name match on**
  - **Preferred name match off**



4. Choose one of the following:
  - Press the **Select** soft key to save the configuration.
  - Press the **Cancel** soft key to keep existing configurations.

## Configuring Area Code Setup

Use the **Area Code Setup** menu to save up to three area codes. When an incoming call arrives with an area code that matches one of the three stored area codes, the incoming call number is reordered to display the telephone number followed by the area code (as opposed to the area code followed by the telephone number).

This reordering is also performed when you scroll through your Callers List. To configure area codes, press the **Services** key, select **Telephone Options**, and select **Call Log Option**.

To configure default area codes (maximum of three):



1. Press the **Up/Down** navigation keys to scroll and highlight **Area Code Setup**.



2. Press the **Enter** key.



3. Press the **Up/Down** navigation keys to scroll and highlight one of the following:
  - Area Code # 1
  - Area Code # 2
  - Area Code # 3



4. Press the **Enter** key.



5. Use the dialpad to enter the number at the prompt.

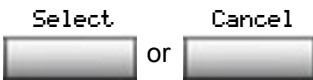

6. Choose one of the following:
  - Press the **Select** soft key to save the configuration.
  - Press the **Cancel** soft key to keep the existing configurations.

To edit area code display:



1. Press the **Up/Down** navigation keys to scroll and highlight **Area Code Setup**.



2. Press the **Enter** key.



3. Press the **Up/Down** navigation keys to scroll and highlight one of the following:
  - Area Code # 1
  - Area Code # 2
  - Area Code # 3



4. Press the **Enter** key.



5. Use the dialpad to edit the number.



6. Choose one of the following:
  - Press the **Select** soft key to save the configuration.
  - Press the **Cancel** soft key to keep existing configurations.

## Choosing a ring type

The Ring type... option configures the telephone's ring tone. To choose a ring type, press the **Services** key, select **Telephone Options**, and select **Ring type...**

To choose a ring type:



Play



Select



Stop



Cancel



1. Press the **Up/Down** navigation keys to scroll and highlight one of the ring types.
2. Press the **Play** soft key to sample the ring tone.
3. Choose one of the following:
  - Press the **Select** soft key to save the ring type and return to the **Telephone Options** menu.
  - Press the **Stop** soft key and use the **Up/Down** navigation keys to select a different ring type.
  - Press the **Cancel** soft key to keep existing configurations.

## Enabling or disabling Call Timer

The call timer measures how long you are on each call. To enable Call Timer, press the **Services** key, select **Telephone Options**, and select **Call Timer**.

To enable or disable Call Timer:

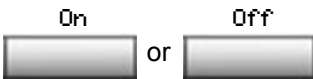

1. Choose one of the following:
  - To turn on the call timer, press the **On** soft key.
  - To turn off the call timer, press the **Off** soft key.

- Choose one of the following:

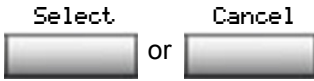

- Press the **Select** soft key to save the configuration and return to the **Telephone Options** menu.
- Press the **Cancel** soft key to keep existing configurations.

## Enabling OnHook Default Path

The OnHook Default Path option allows control whether a headset or the Handsfree feature is used to operate your IP Phone while it is on-hook. To enable OnHook Default Path, press the **Services** key, select **Telephone Options**, and select **OnHook Default Path**.

To enable OnHook Default Path:



- Press the **Up/Down** navigation keys to highlight one of the following:
  - **Handsfree enable**
  - **Headset enable**

- Choose one of the following:



- Press the **Select** soft key to save the default path and return to the **Telephone Options** menu.
- Press the **Cancel** soft key to keep existing configurations.

## Changing feature key labels

The Change feature key label option renames the label displayed next to each feature key or restores the default labels to the keys. To rename feature key labels, press the **Services** key, select **Telephone Options**, and select **Change feature key labels**.

**Note:** If a feature key is configured as an auto-dial key, the label does not change if the auto-dial key configuration changes.

### To rename the labels:



3. Press the **Enter** key.

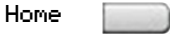

4. Press the feature key that you are changing.

**Note:** If you enter a prime DN key, an error message appears.



5. Enter the new information for the feature key label. To enter special characters, press the **Up** navigation key. For information about entering text, refer to “Entering text using the dialpad” on page 23.

6. Choose one of the following:

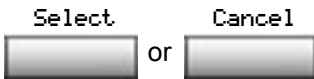

- Press the **Select** soft key to save the changes and return to the **Telephone Options** menu.
- Press the **Cancel** soft key to keep existing configurations.

### To restore the default labels:

To restore default labels, press the **Services** key, select **Telephone Options**, and select **Change feature key labels**.



7. Press the **Enter** key.





8. Use the **Up/Down** navigation keys to scroll and highlight one of the following:
  - a. Restore all key labels
    - Press the **Yes** soft key to change all feature keys to default values.
  - b. Restore one key label
    - Press the **Select** soft key.
    - Press the feature soft key.
    - Press the **Yes** soft key to change the selected feature key label to the default value.

**Note:** When labels are changed to default values, you cannot undo the change. The labels must be reentered.

### Configuring the name display format

You can configure your IP Phone 1120E to display the name of the incoming calling party in the following formats:

- first name, last name
- last name, first name

To configure name display format, press the **Services** key, select **Telephone Options**, and select **Name Display Format**.

**To configure name display format:**



1. Press the **Up/Down** navigation keys to scroll and highlight **Name display format**.



2. Press the **Enter** key.



3. Press the **Up/Down** navigation keys to scroll and highlight one of the following:

- **first name, last name**
- **last name, first name**

4. Choose one of the following:

- Press the **Select** soft key to save the configuration.
- Press the **Cancel** soft key to keep existing configurations.

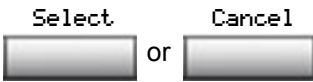

# Configuring Local Menu options

**Note 1:** Many of the options discussed in this section are for administrator use only. Do not make any changes unless instructed by an administrator.

**Note 2:** Your system administrator can establish a password for the Local Tools menu. When the password is enabled, a password prompt dialog box appears when you attempt to access this menu. If this happens, contact your system administrator.

Your IP Phone 1120E has both local and server-based options. Press the **Services** key twice to access the Local Tools menu, which is organized into the following submenus:

- “Using the 1. Preferences submenu” on page 53
- “Using the 2. Local Diagnostics submenu” on page 56
- “Using the 3. Network Configuration menu” on page 57
- “Using the 4. Lock Menu” on page 57

**Note:** Where a menu entry has a number in front of it you can select that entry by pressing the associated key on the dialpad. For example, when you are in the Local Tools menu, you can access **2. Local Diagnostics** by pressing the 2 key on the dialpad.

The function of some keys on the telephone varies depending on the situation. The key functions in the menus are described in Table 4.

**Table 4: Navigation key functions in menus (Part 1 of 2)**

Key	Function
<b>Down</b> arrow keys	Move the highlight down
<b>Up</b> arrow keys	Move the highlight up
<b>Right</b> arrow key	Select the current menu item
<b>Left</b> arrow key	Close the menu
<b>Enter</b> key	Select the current menu item

**Table 4: Navigation key functions in menus (Part 2 of 2)**

Key	Function
Enter digits on the dialpad	Select the associated menu item
<b>Stop</b> key	Close the menu

The key functions in dialog boxes are described in Table 5.

**Table 5: Navigation key functions in dialog boxes**

Key	Function
<b>Down</b> arrow keys	Scroll the window down
<b>Up</b> arrow keys	Scroll the window up
<b>Right</b> arrow key	Go to the next Edit item
<b>Left</b> arrow key	Go to the previous Edit item
<b>Enter</b> key	Toggle Edit mode on or off Toggle the check box status

When you are working in Edit mode, the first field of the item is highlighted and a blinking cursor is to the right of the current edit position. The navigation key functions in Edit mode are described in Table 6.

**Table 6: Navigation key functions in Edit mode (Part 1 of 2)**

Key	Function
<b>Down</b> arrow keys	Open the combo box list Move the highlight down the list
<b>Up</b> arrow keys	Move the highlight up the list
<b>Right</b> arrow key	Select the current combo box list item Move the cursor to the right
<b>Left</b> arrow key	Delete a character in edit field

**Table 6: Navigation key functions in Edit mode (Part 2 of 2)**

Key	Function
<b>Enter</b> key	Select highlighted item in combo box Exit edit mode
Enter characters or digits on the dialpad	Insert characters or digits at the current cursor position

**Note:** If you are using a USB mouse, you can right-click on the Telephony screen to open the Local Tools menu, and click on an item to select it.

## Using the 1. Preferences submenu

The Local Tools menu **1. Preferences** submenu offers the following choices:

- “Changing 1. Display Settings” on page 53
- “Changing 2. Language” on page 55

### Changing 1. Display Settings

The Display Settings menu provides access to two tools: **Contrast** and **Sleep**. Use the **Contrast** tool to alter the physical settings of the display. Use the **Sleep** tool to control how long the display remains lit if the phone is inactive.

**Note:** Contrast can also be adjusted in the Telephone Options menu; Nortel recommends that you use the control in the Telephone Options menu whenever possible.

To configure the Contrast or Sleep tools, press the **Services** key twice to open the Local tools menu, press the 1 key on the dialpad to select **1. Preferences**, and press the 1 key on the dialpad to select **1. Display Settings**.

To configure Contrast or Sleep tools:



1. Press the **Up/Down** arrow keys to scroll and highlight one of the following:

- **Contrast**
- **Sleep**

**Note:** Sleep is displayed in the format xxx, where xxx is a time in minutes or hours.



2. Press the **Enter** key.



3. Press the **Up/Down** arrow keys to increase or decrease the selected value.

**Note 1:** Available values for Sleep are as follows:

- 5m (5 minutes)
- 15m (15 minutes)
- 30m (30 minutes)
- 1h (1 hour — default)
- 2h (2 hours)
- Never (screen does not go black)

**Note 2:** Extending the sleep time or never sleeping reduces the life span of the display screen.

Exit



4. Press the **Exit** soft key to exit to the main display. Changes are saved automatically.

## Changing 2. Language

Use the Language menu item to configure local preferences. Use the **Language** tool to select the language used on your phone.

**Note:** This language setting controls the language used in the local menus on your phone only. To select the language used by features on your phone, press the **Services** key, select **Telephone Options**, and select **Language...**

To select the language used in the local menus, press the **Services** key twice to open the Local tools menu, press the 1 key on the dialpad to select **1. Preferences**, and press the 2 key on the dialpad to select **2. Language**.

To select the language used in local menus:



1. Press the **Up/Down** navigation keys to scroll and highlight the desired language (for example, German [Deutsche]).

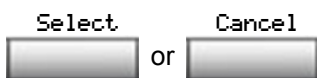

2. Choose one of the following:
  - Press the **Select** soft key to save the desired language and return to the **Telephone Options** menu.
  - Press the **Cancel** soft key to keep existing configurations.



3. Press the **Exit** soft key to exit to the main display. Changes are saved automatically.

# Using the 2. Local Diagnostics submenu

---

Use the Local Tools menu **2. Local Diagnostics** submenu to access the following:

- “Using 1. IP Set&DHCP Information” on page 56
- “Using 2. Network Diagnostic Tools” on page 56
- “Using 3. Ethernet Statistics” on page 56
- “Using 4. IP Network Statistics” on page 56
- “Using 5. USB Devices” on page 57

**Note:** Press the **Return** soft key to return to the Local Diagnostics submenu at any time while working tools in the Local Diagnostics submenu. Use the **Return** key to quickly gather information and run tests without exiting and reentering the Local Tools menu. For example, you can check the Ethernet Statistics, then press **Return** and enter the Network Diagnostics Tools to ping an IP address.

## Using 1. IP Set&DHCP Information

The Network Configuration tool is used to view reports about IP set and DHCP operation. This tool is for administrator use only.

## Using 2. Network Diagnostic Tools

The Network Diagnostic Tools menu contains tools that are used to diagnose network problems. This menu is for administrator use only.

## Using 3. Ethernet Statistics

The Ethernet Statistics tool is used to view reports about Ethernet operation. This tool is for administrator use only.

## Using 4. IP Network Statistics

The IP Networks Statistics tool is used to view reports about network operation. This tool is for administrator use only.



## Using 5. USB Devices

The USB devices tool provides information about Universal Serial Bus (USB) devices that connect to your phone. Your IP Phone 1120E automatically detects USB devices when you connect them to the USB port in the back of the phone.

To check USB device information, press the **Services** key twice to open the Local tools menu, press the 2 key on the dialpad to select **2. Local Diagnostics**, and press the 5 key on the dialpad to select **5. USB Devices**.

**To check USB device information:**

The screen displays information about connected devices.



1. Press the **Return** soft key to return to the main display.

## Using the 3. Network Configuration menu

---

The Network Configuration tool displays information that was configured when the telephone was installed. This tool is for administrator use only.

## Using the 4. Lock Menu

---

Your system administrator can use the lock menu tool to protect the Local Tools menu items from accidental or unwanted changes. This tool is for administrator use only

# Making a call

This section describes features associated with making a call. You can make a call from your IP Phone 1120E using any of the following methods:

- “Using Off-hook dialing” on page 58
- “Using On-hook dialing” on page 59
- “Using handsfree dialing” on page 60
- “Using the Directory applications” on page 62
- “Using Predial” on page 66
- “Using AutoDial” on page 67
- “Using Ring Again” on page 69
- “Using Last Number Redial” on page 70
- “Using Speed Call” on page 71
- “Using System Speed Call” on page 72
- “Using HotLine” on page 72
- “Using intercom calling” on page 73

## Using Off-hook dialing

---



1. Lift the handset.



2. Dial the number.

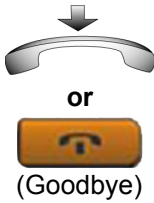

3. To terminate the call, choose one of the following:
  - Replace the handset into the cradle.
  - Press the **Goodbye** key.

## Using On-hook dialing

---



1. Leave the handset in the cradle.
2. Press the line (DN) key.
3. When the dial tone sounds, dial the number.
4. When the called party answers, lift the handset.
5. To terminate the call, choose one of the following:
  - Replace the handset into the cradle.
  - Press the **Goodbye** key.

## Using handsfree dialing

---

Use handsfree dialing to use a built-in microphone and speaker, or a headset, instead of the handset. While on an active call, you can switch between Handset and Handsfree mode.

### To use handsfree dialing:



(Handsfree)

1. Press the **Handsfree** key.



(Headset)

2. If a headset is connected, press the **Headset** key.



3. Dial the number.

### To discontinue a handsfree call:



(Goodbye)

Press the **Goodbye** key.

### To mute a handsfree call:



(Mute)

1. Press the **Mute** key. The LED indicator flashes.



2. Press the **Mute** key again to return to a two-way handsfree conversation.

**To switch from handsfree to handset:**



Lift the handset.

**To switch from handset to handsfree:**



1. Press the **Handsfree** key.

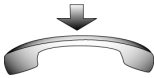

2. Replace the handset.

**To use a headset:**

1. Connect the **headset** to the headset jack or the handset jack.

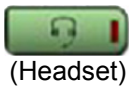

2. Press the **Headset** key.

**To switch from handsfree to headset:**

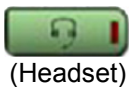

1. Press the **Headset** key.

# Using the Directory applications

---

You can make calls using the following Directory applications available on your IP Phone 1120E:

- “Making a call using Corporate Directory” on page 62
- “Making a call using the Personal Directory” on page 63
- “Making a call using the Callers List” on page 64
- “Making a call using the Redial List” on page 65

## Making a call using Corporate Directory

**Note:** This feature is not available on all phones. Contact your system administrator to find out if this feature is available for your use.

The Corporate Directory feature provides an alphabetical list of entries using last names. You can search by name, view additional information on each entry, and dial Corporate Directory numbers. To use the Corporate Directory, press the **Directory** key and select **Corporate Directory**.

**To search for a specific number:**



1. When prompted, use the dialpad to enter the desired name in the last name, first name format.
2. Press the **Search** soft key to find the desired name.

**Note:** A successful search displays the first match on the screen.

3. Choose one of the following:

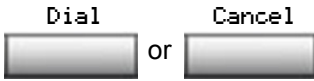

- Press the **Dial** soft key to dial the resulting number.
- Press the **Cancel** soft key to exit without dialing.

**Note:** If there is no match to the search query, start a new search or change the information in the initial search.

**To scroll to a specific number:**



1. Press the **Up/Down** navigation keys to scroll and highlight a name in the Corporate Directory.

2. Choose one of the following:

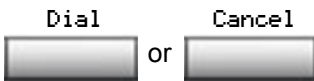

- Press the **Dial** soft key to dial the resulting number.
- Press the **Cancel** soft key to exit without dialing.

## Making a call using the Personal Directory

The Personal Directory feature allows you to store a maximum of 100 entries consisting of names and numbers. To use the Personal Directory, press the **Directory** key and select **Personal Directory**. For information on how to configure and use the Personal Directory, refer to “Using the Personal Directory” on page 112.

### To make a call using the Personal Directory:



1. Press the **Up/Down** navigation keys to scroll and highlight a name in the **Personal Directory**.

2. Choose one of the following:



- Press the **Dial** soft key to dial the resulting number.
- Press the **Cancel** soft key to exit without dialing.

### Making a call using the Callers List

The Callers List feature automatically stores up to a maximum of 100 callers. After 100 callers have been stored, each additional caller overwrites the oldest entry. To use the Callers List, press the **Directory** key and select **Callers List**. For information on how to configure and use the Callers List, refer to “Using the Callers List” on page 115.

### To make a call using the Callers List:



1. Press the **Up/Down** navigation keys to scroll and highlight a name in the **Callers List**.

2. Choose one of the following:



- Press the **Dial** soft key to dial the resulting number.
- Press the **Cancel** soft key to exit without dialing.



## Making a call using the Redial List

The Redial List feature automatically stores a maximum of 20 previously dialed telephone numbers. To use the Redial List, press the **Directory** and select **Redial List**. For information on how to configure and use the Redial List, refer to “Using the Redial List” on page 117.

**To make a call using Redial List:**



1. Press the **Up/Down** navigation keys to scroll and highlight a name in the **Redial List**.

2. Choose one of the following:

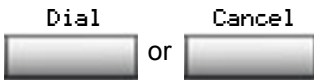

- Press the **Dial** soft key to dial the resulting number.
- Press the **Cancel** soft key to exit without dialing.

## Viewing the date and time of a call

In both the Redial List and Caller List, you can check the date and time of a call.

**To view date and time of a call:**



1. Press the **Up/Down** navigation keys to scroll and highlight a name in the **Redial List** or **Caller List**.



2. Press the **Right** navigation key to display the DN of the selected entry.



3. Choose one of the following:
  - In the **Redial List**, press the **Down** navigation key to display the date and time the last call was placed to the selected entry.
  - In the **Caller List**, press the **Down** navigation key twice to display the date and time of the last call from the selected entry.

**Note:** In the Caller List, the first press of the Down navigation key displays the number of times a caller has called.

## Using Predial

---

Use the Predial feature to enter, preview, and edit numbers before dialing.

**To use Predial:**



2498

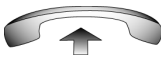

1. Without selecting the line key, enter the number to be dialed.
2. Press a line key to dial the number.
3. Lift the handset when the called party answers or, if in handsfree mode, begin to speak.

To edit a Predial number:



1. Use the dialpad to enter the number.

2. Choose one of the following:

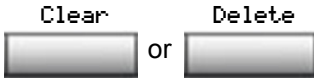

- To erase all numbers, press the **Clear** soft key. Reenter the numbers to be dialed.
- To change one number at a time, press the **Delete** soft key to backspace. Re-enter the number.



3. Press a line key to dial the number.

## Using AutoDial

Use the AutoDial feature to display, store, and automatically dial telephone numbers.

To store an AutoDial number:

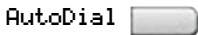

1. Without lifting the handset, press the appropriate **AutoDial** key.

**Note:** The display screen displays the word Autodial next to the appropriate key.



2. Using the dialpad, dial the telephone number (including access code) to be stored on the selected **AutoDial** key.

AutoDial 

3. Press the **AutoDial** key a second time to store the number on the selected key.

**Note:** After you store a number, the word AutoDial disappears, and the stored number is displayed.

4. Assign a label to the key.

**Note:** After you assign the label, the number disappears and only the label appears on the screen next to the key.

### To display an AutoDial number:

Display 

1. Press the **Display** key.

AutoDial 

2. Press an **AutoDial** key in the upper display area to display the number associated with that key.

### To use AutoDial:

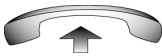

1. Lift the handset.

AutoDial 

2. Press an **AutoDial** key in the upper display area to dial the number associated with that key.

## Using Ring Again

Use the Ring Again feature if you receive a busy tone or if there is no answer. Your IP Phone rings when the person you called becomes available. Ring Again automatically redials the number.

### To activate Ring Again:



1. Dial a number and receive a busy tone or no answer.

Ring Again



2. Choose one of the following:

- Press the **Ring Again** soft key.
- Enter the **Ring Again Activate** FFC.

or



### To call a Ring Again party when you receive notification:



1. After receiving the notification ring, lift the handset, or, if you are using the headset or in Handsfree mode, go to step 2.

Ring Again



2. Press the **Ring Again** soft key to automatically dial the number.

### To deactivate Ring Again before notification:

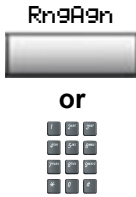

Choose one of the following:

- Press the **Ring Again** soft key a second time.
- Enter the **Ring Again Deactivate** FFC.

## Using Last Number Redial

---

Use the Last Number Redial feature to automatically redial the last dialed number.

### To use Last Number Redial:

Choose one of the following:

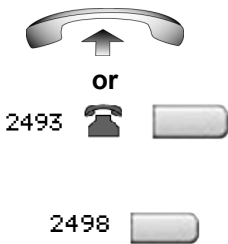

1. To redial using the handset:

- Lift the handset.
- Press the line (DN) key.

2. To redial without lifting the handset, press the line (DN) key twice (the last number dialed is automatically redialed).

## Using Speed Call

Use the Speed Call feature to place internal and external calls by dialing a one-, two-, or three-digit code to store, edit, and automatically dial frequently called telephone numbers.

### To store a Speed Call number:



1. Press the **Speed Call Controller** soft key. The triangular icon flashes, indicating programming mode.



2. At the prompt:
  - Enter a one-, two-, or three-digit code (0-999).
  - If required, dial the access code.
  - Enter the telephone number (internal, external or long-distance number).



3. Press the **Speed Call Controller** soft key again to save the code and number. The flashing icon turns off.

### To make a Speed Call:

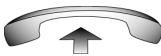

1. Lift the handset.



2. Press the **Speed Call Controller** soft key.



3. Dial the **Speed Call** code to automatically dial the number.

## Using System Speed Call

---

Use the System Speed Call feature to dial Speed Call codes that override dialing restrictions placed on your telephone.

**To make a System Speed Call:**



1. Lift the handset.

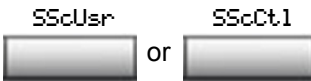

2. Choose one of the following:
  - Press the **System Speed Call** soft key.
  - Press the **System Speed Call Controller (SScCt1)** key.



3. Dial the **Speed Call** code to automatically dial the number.

## Using HotLine

---

Use the HotLine feature to automatically dial a specific number.

**To use HotLine:**



- Press the **HotLine** soft key to automatically dial the number.



## Using intercom calling

Use the Intercom feature to call a member of your intercom group by pressing the code assigned to each member.

### To make an intercom call:



1. Lift the handset.



2. Press the **Intercom** key.



3. Dial the one- or two-digit code for the desired intercom group member.

### To answer an intercom call while on a line other than your intercom group line:



(Hold)

or



(Goodbye)

1. Choose one of the following keys:
  - Press the **Hold** key to put the current call on hold.
  - Press the **Goodbye** key to end the call.



2. Press the **Intercom** key and begin to speak.

# Answering a call

Each incoming call causes the telephone to ring, the LCD indicator (  ) beside the Line (DN) key to flash, and the Message Indicator lamp to flash.

## To answer a call:

Choose one of the following four options:

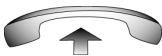

or



or

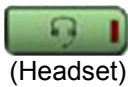
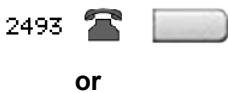

- Lift the handset.

- Press the **Handsfree** button located on the left side of the handset.

- Press the line (DN) key beside the LCD indicator as it flashes.

- Press the **Headset** key if a headset is connected to your telephone.

# While on an active call

This section describes the following features, available during an active call:

- “Placing a call on hold” on page 75
- “Transferring a call” on page 76
- “Using Timed Reminder Recall” on page 77
- “Using Attendant Recall” on page 78
- “Using Call Park” on page 79
- “Recording a Calling Party Number” on page 81
- “Displaying incoming call information” on page 81
- “Tracing a malicious call” on page 82

## Placing a call on hold

---

Use the Hold feature when you are talking on one line and another call arrives on a second line. Retain the original call by putting it on hold and then answer the second call.

**To place a call on hold:**



(Hold)

Press the **Hold** key. The LCD indicator flashes beside the line on hold.

**Note:** If **Automatic Hold** is enabled, the active call is automatically put on hold when you answer the second call.

**To retrieve a call on hold:**



Press the line (DN) key beside the flashing LCD indicator.

## Transferring a call

---

Use the Transfer feature to redirect a call to the appropriate person.

### To transfer a call to a third party:



1. Press the **Transfer** soft key. The other party is put on hold and a dial tone sounds. The LCD indicator light flashes steadily.



2. Dial the DN to which you are transferring the call or use the **Personal Directory**, **Redial List**, or **Callers List** to select a number to dial.



3. When that number rings or a person answers, press the **Transfer** soft key to connect the calling party.

### To return to the original call, if the transfer is incomplete:



If the person called is not available, press the line (DN) key (next to the LCD indicator) to reconnect to the original call.

## Using Timed Reminder Recall

Use the Timed Reminder Recall feature to receive a reminder tone when a transferred call is not answered.

### To use Timed Reminder Recall:



or

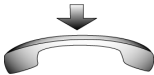

1. Press the **Transfer** soft key. The call is put on hold.
2. Dial the number to which you are transferring the call.
3. Choose one of the following to start the recall timer:
  - Press the **Transfer** soft key.
  - Replace the handset before the extension answers.

**Note:** If the transfer is complete, the recall timer stops.

If the transferred call is not answered, your telephone rings:



1. Lift the handset to reconnect to the original caller.

Trans



or



(Goodbye)

2. Choose one of the following:

- Press the **Transfer** soft key and repeat the transfer.
- If the transfer is picked up while you are on the line, press the **Goodbye** key to complete the transfer.

## Using Attendant Recall

---

Use the Attendant Recall feature to contact an attendant during a call and to connect the caller to the attendant.

To contact the attendant while on a call:

AttRcl



1. Press the **Attendant Recall** key and stay on the line until the attendant answers.



(Goodbye)

2. Press the **Goodbye** key. The caller remains connected to the attendant.

## Using Call Park

Use the Call Park feature to hold temporarily (park) and retrieve a call from any telephone. Using Call Park does not tie up a line. When configured network-wide, Call Park can be used across networks. A System Park extension can be configured to automatically park most calls.

### To park a call on the System Park DN or your own DN:

During an active call, press the **Park** soft key twice.



**Note:** By default, the call is parked on your DN unless a **System Park DN** is enabled to automatically park calls on the system.

### To park a call on a DN other than the System Park DN or your own DN:



1. Press the **Park** soft key.



2. Dial the DN where you want to park the call.



3. Press the **Park** soft key.

## To park a call using the SPRE code or FFC:

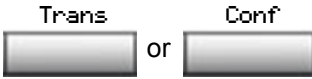

1. Choose one of the following:
  - Press the **Transfer** soft key.
  - Press the **Conference** soft key.



2. Dial the **Call Park** FFC.



3. To use an alternate DN from the **System Park** DN or your own DN, dial the DN where you want to park the call. Otherwise, proceed to step 4.

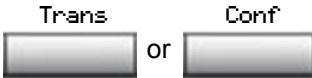

4. Choose one of the following:
  - Press the **Transfer** soft key.
  - Press the **Conference** soft key.

## To retrieve a parked call:

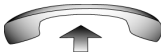

1. Lift the handset.



2. Press the **Park** soft key.



3. Dial the DN where you parked the call.

**Note:** If a parked call is not retrieved within a specified period of time, it rings back to your telephone or to the attendant.



## Recording a Calling Party Number

---

Use the Calling Party Number feature to record a caller's number, or to charge a call to an account number, during an established call.

To record a caller's number for accounting purposes:



1. Press the **Call Party** soft key. The caller is placed on hold.



2. Dial a charge account number or the caller's number.

**Note:** For information on using the **Charge** key, see "Charging a call or charging a forced call" on page 102.



3. Press the **Call Party** soft key to return to the call.

## Displaying incoming call information

---

Use the Display feature to display a second incoming caller's number and name (if available) during an active call, without interfering with the call in progress.

To view the information on an incoming call while on a call in progress:



1. Press the **Display** key.

2493  

2. Press the flashing line (DN) key. The call waiting information displays.

**Note:** When used with other feature keys, the **Display** key displays information associated with those feature keys.

## Tracing a malicious call

---

Use the Call Trace feature to trace nuisance calls within your system.



**Note:** This is not a default feature. Contact your system administrator to configure this feature on your telephone.

### To use Call Trace while on a call:

CallTrace 

Press the **Call Trace** key.

### To use Call Trace without a Call Trace key:

Trans  or  Conf

1. Choose one of the following:
  - Press the **Transfer** soft key.
  - Press the **Conference** soft key.
2. Dial the **SPRE code** followed by **83** or dial the **Call Trace** FFC to automatically reconnect.



# Incoming calls

You can use the following features when you have an incoming call:

- “Using Automatic Answerback” on page 83
- “Using Call Pickup” on page 83
- “Using Call Waiting” on page 85

## Using Automatic Answerback

---

When the Automatic Answerback feature is active, your telephone automatically answers in Handsfree mode after one ring; however, calls are *not* forwarded to the voice message service.

**To activate Automatic Answerback:**

AutoAns



Press the **Automatic Answerback** key.

**To deactivate Automatic Answerback:**

AutoAns



Press the **Automatic Answerback** key again.

## Using Call Pickup

---

Use the Call Pickup feature to pick up calls from any telephone in your pickup group or another pickup group.

**To answer a call in your own call pickup group:**

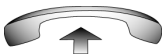

1. Lift the handset.

Pickup 

or



2. Choose one of the following:

- Press the **Pickup** key.
- Enter the **Pickup Ringing Number** FFC.

### To answer an incoming call in another call pickup group:



1. Lift the handset.

GrpPkP 

2. Press the **Group Pickup** key or enter the **Pickup Group** FFC.



3. Dial the pickup group number of the ringing telephone.

### To answer a call at a specific extension in any pickup group:



1. Lift the handset.

Pickup 

2. Choose one of the following:

- Press the **Pickup** key.
- Enter the **Pickup Directory Number** FFC.

or





3. Dial the DN of the telephone that is ringing (and that is not in your call pickup group). If the pickup DN or group number is invalid (an overflow burst tone sounds and the screen displays *Goodbye and try again*), press the **Goodbye** key.

## Using Call Waiting

The Call Waiting feature alerts you to an incoming call by producing a tone. It also puts the current call on hold while you answer the new call.

### To answer an incoming call while on another call:



(Hold)

1. When the incoming call tone sounds, press the **Hold** key to put the current call on hold.

**Note:** If **Automatic Hold** is enabled, it is not necessary to press the **Hold** key.



2. Press the **Call Waiting** key.

### To return to the first telephone call:



(Hold)

or



(Goodbye)

1. Choose one of the following:
  - Press the **Hold** key to put the second call on hold.
  - Press the **Goodbye** key to end the second call.

2493



2. Press the line (DN) key associated with the first call.

### If you do not have a Call Waiting key:



(Goodbye)

1. Press the **Goodbye** key to end the current call.

2493



2. Press the line (DN) key beside the flashing status icon to answer the incoming call.

# While away from your desk

You can use the following features when you are away from your desk:

- “Using Call Forward” on page 87
- “Using Internal Call Forward” on page 88
- “Using Remote Call Forward” on page 89
- “Securing your telephone” on page 91

## Using Call Forward

Use the Call Forward feature to direct incoming calls to ring on another line (DN). If the telephone is ringing, the call cannot be forwarded.

**To forward your calls or change the forward number:**

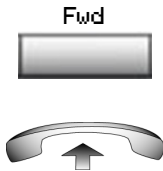

1. Choose one of the following:
  - Press the **Forward** soft key.
  - Lift the handset and enter the **Call Forward All Calls Activate** FFC.



2. Dial the DN where you want to forward your calls.



3. Press the **Forward** soft key.

To deactivate Call Forward:

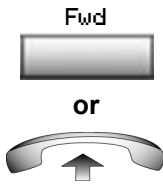

Choose one of the following:

- Press the **Forward** soft key.
- Lift the handset and enter the **Call Forward All Calls Deactivate** FFC.

To reinstate Call Forward to the same number:

Press the **Forward** soft key twice.



## Using Internal Call Forward

Use Internal Call Forward to accept only calls originating at internal DNs to ring at another DN. Calls originating outside your telephone system still ring at your telephone. Current incoming calls cannot be forwarded.

To forward internal calls:

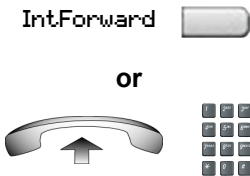

1. Choose one of the following:

- Press the **Internal Call Forward** key.
- Lift the handset and enter the **Internal Call Forward Activate** FFC.





2. Dial the DN to which you are forwarding your internal calls.



IntForward 

3. Press the **Internal Call Forward** key.

### To deactivate Internal Call Forward:

IntForward  

or



Choose one of the following:

- Press the **Internal Call Forward** key.
- Lift the handset and enter the **Internal Call Forward Deactivate FFC**.

### To reinstate Call Forward to the same number:

IntForward 

IntForward 

Press the **Internal Call Forward** key twice.

## Using Remote Call Forward

Use the Remote Call Forward feature (from any telephone other than your own) to forward calls to any telephone.

### To activate Remote Call Forward:



1. Lift the handset.



2. If you are calling from a telephone outside the system, dial your direct system access number and wait for the dial tone.



3. Dial the **Remote Call Forward Activate FFC** to activate the feature.



4. Dial your **Station Control Password**. A dial tone sounds.



or



5. Choose one of the following:
  - Dial your DN.
  - To forward calls to the previous call forward telephone number, press the **#** key. (Do not perform steps 6 and 7.)



6. Dial the number to which you are forwarding calls. If calls are forwarded to an invalid number, a fast busy signal sounds.



7. Press the **#** key.

### To deactivate Remote Call Forward:



1. Lift the handset.



2. If you are calling from a telephone outside the system, dial the **direct system access** number and wait for the dial tone.



3. Dial the **Remote Call Forward Deactivate** FFC.



4. Dial your **Station Control Password**.



5. After you hear the dial tone, dial your DN.



6. Press the **#** key.

## Securing your telephone

---

Use the Electronic Lock feature to prevent others from making calls from your telephone. The Electronic Lock feature is controlled using your Station Control Password (SCPW). To change your Station Control Password, please refer to “Security features” on page 20.

### To lock your telephone:

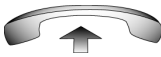

1. Lift the handset.



2. Dial the **Electronic Lock Activate** FFC.



3. Dial your **Station Control Password**.



(Goodbye)

or



4. Choose one of the following:
  - If you are dialing locally, press the **Goodbye** key.
  - If you are dialing the FFC remotely, dial your DN.

To unlock your telephone:

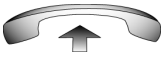

1. Lift the handset.



2. Dial the **Electronic Lock Deactivate** FFC.



3. Dial your **Station Control Password**.



(Goodbye)

or



4. Choose one of the following:
  - If you are dialing locally, press the **Goodbye** key.
  - If you are dialing the FFC remotely, dial your DN.

# Talking with more than one person

Use the following features to enable conversations between more than two people:

- “Using the Call Join feature” on page 93
- “Setting up a conference call” on page 94
- “Using Conferee Selectable Display” on page 95
- “Using Group Call” on page 96

## Using the Call Join feature

---

Use the Call Join feature to connect a call to a current active call. This connection creates a conference between the two callers and yourself.

**To connect a call on hold (on a different line) to your current call:**

Conf



1. Press the **Conference** soft key.

2493



2. Press the line key that has the number of the caller you want to connect to your current call.

Conf



3. Press the **Conference** soft key to join the person on hold to your conversation.

## Setting up a conference call

---

Use the Conference feature to set up a conference call for a maximum of three or six people including yourself. The maximum number of people the conference feature supports depends on the configuration of your telephone.

### To set up a conference call:



1. While on a call, press the **Conference** soft key to place the party on hold. You hear a dial tone.



2. Dial the number of the person you want to add to the conference call. You can talk privately to the person you are adding at this time.

**Note:** If you press the **Directory** key, you can also use the **Corporate Directory**, **Personal Directory**, **Redial List**, and **Callers List** to find and dial the number of the person you want to add to the conference call.



3. Press the **Conference** soft key a second time to conference all parties together.

### If the person you attempt to add to the conference is unavailable:



(Goodbye)

1. Press the **Goodbye** key.

2493



2. Press the line (DN) key beside the flashing status icon to return to your original call.

## Using Conferee Selectable Display

Use the Conferee Selectable Display and Disconnect feature to list active conferees and disconnect a conferee from the conference call.

### To view active conferees:

ConfDsp



1. While on a conference call, press the **Conferee Selectable Display** key to turn on the LCD indicator. Each key press changes the screen to show a different active conferee.

**Note:** This action has no effect on the display of other telephones involved in the conference.



(Goodbye)

2. Press the **Goodbye** key. If configured, the **Conference Count Display** returns an updated total count of conferees. The LCD indicator turns off.

### To disconnect a conferee:

ConfDsp



1. While on a conference call, press the **Conferee Selectable Display** key until the conferee you want to disconnect appears on the screen.

2493



2. Press the line (DN) key on which the conference call is established.



(Goodbye)

3. Choose one of the following:
  - For a single conferee, press the **Goodbye** key. If configured, the **Conference Count Display** returns an updated total count of conferees. The LCD indicator turns off.
  - For multiple conferees, repeat steps 1 and 2 until all conferees are disconnected. Then press the **Goodbye** key.

## Using Group Call

---

Use the Group Call feature to automatically call members of a predefined group, one at a time, until all members answer.

**To call group members:**

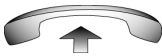

1. Lift the handset.



GrpC1



2. Press the **Group Call** key or enter the **Group Call FFC**.
  - The feature automatically calls all group members. The icon flashes until all members answer.
  - The telephone numbers of the group members appear on the display as they answer. When the last person answers, the **Group Call** indicator lights steadily.
  - When a person in your group is on a conference call or another group call, they are not connected to your group call.
  - After everyone in the group has answered, only the person who made the group call can put the call on hold.

### To answer a group call:



1. Lift the handset. Note the following about notification tones:
  - If you are on a call and receive three 10-second tones, this is the notification of a group call on your current extension.
  - If you are on a call on another line when a group call is made, you receive a long tone through the handset or speaker.
  - If you are already on a conference call or another group call, you do not receive notification of a group call.

To end a group call:



(Goodbye)

Press the **Goodbye** key.

**Note:** When the person who made the group call disconnects, the call terminates for all members of the group. However, the members of the group call can disconnect from the call and not affect other members on the call.

# Working without interruption

This section describes the Activating Make Set Busy feature, which provides uninterrupted work time.

## Activating Make Set Busy

Use the Make Set Busy feature to make your telephone appear busy to all callers.

### To activate Make Set Busy:

MakeSetBsy 



or



Choose one of the following:

- Press the **Make Set Busy** key.
- Lift the handset and enter the **Make Set Busy Activate** FFC.

### To deactivate Make Set Busy:

MakeSetBsy  

or



Choose one of the following:

- Press the **Make Set Busy** key a second time to deactivate the feature.
- Lift the handset and enter the **Make Set Busy Deactivate** FFC.

# Additional call features

Contact your system administrator to determine if the following call features are available on your telephone.

- “Using AutoDial Transfer” on page 100
- “Using the Buzz feature” on page 101
- “Using Call Page Connect to make an announcement” on page 101
- “Using Centrex/Exchange Line Switchhook Flash” on page 102
- “Charging a call or charging a forced call” on page 102
- “Using Enhanced Override” on page 105
- “Using Forced Camp-on” on page 106
- “Overriding a busy signal” on page 107
- “Using Privacy Release” on page 108
- “Using Radio Page” on page 109
- “Using Voice Call” on page 111

## Using AutoDial Transfer

---

Use the AutoDial Transfer feature to transmit digits through your AutoDial key to the Central Office after a Trunk Switchhook Flash. You must be on a Central Office/Exchange (CO) trunk call from or to a CO that offers Centrex or exchange line-type features.

**To use AutoDial Transfer when picking up an incoming trunk call:**

CentrexSHF



1. Press the **Centrex Switchhook Line Flash** key and wait for an interrupted dial tone.

AutoDial



2. Press the **AutoDial** key to call the number desired.



(Goodbye)

3. Press the **Goodbye** key to end the call.

## Using the Buzz feature

---

Use the Buzz feature to notify another person of a call, a visitor, or a request. Two telephones that are linked together enable one person to signal the other. The person signaled hears a buzz.

### To buzz the telephone linked to your telephone:



Press the **Buzz** key. The telephone linked to your telephone buzzes as long as you press the key.

## Using Call Page Connect to make an announcement

---

Use the Call Page Connect feature to make an announcement over a paging system.

**Note:** A **Page** key on an attendant console overrides and disconnects the telephones. The telephones must reaccess the page trunk.

### To connect to Call Page:



1. Lift the handset.



2. Dial the **Page Trunk Access Code** to complete the connection to the page system.
3. Make your announcement.



(Goodbye)

4. Press the **Goodbye** key.

## Using Centrex/Exchange Line Switchhook Flash

---

Use the Centrex/Exchange Line Switchhook Flash feature during an established call to use a Centrex service, such as Call Transfer or Three-Way Calling.

### To use Centrex/Exchange Line Switchhook Flash:

CentrexSHF



1. While on a call, press the **Centrex Line Switchhook Flash** key. A special dial tone sounds.



2. Dial the codes for your custom **Centrex** feature.



(Goodbye)

3. Press the **Goodbye** key to end the call.

## Charging a call or charging a forced call

---

Use the Call Charge feature to charge a call to a specific account. The Forced Charge feature charges long-distance calls from a telephone restricted to local calls.

To charge a local or long-distance call to an account before you dial:

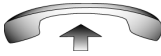

1. Lift the handset.
2. Choose one of the following:
  - Press the **Charge** soft key.
  - Dial the **Call Detail Recording** FFC.
3. Dial the charge account number.
4. When the dial tone sounds, dial the number.

To charge a call in progress:



or



1. Choose one of the following:
  - Press the **Transfer** soft key.
  - Press the **Conference** soft key.
2. Choose one of the following:
  - Press the **Charge** soft key.
  - Dial the **Call Detail Recording** FFC.
3. Dial the charge account number.

2493 

4. Press the line (DN) key to return to the call.

**To charge a call to an account when you transfer a call:**



1. Press the **Transfer** soft key. The call is on hold.



2. Choose one of the following:
  - Press the **Charge** soft key.
  - Dial the **Call Detail Recording** FFC.

or



3. Dial the charge account number.



4. After the dial tone, dial the number to which you are transferring the call.



5. Press the **Transfer** soft key when you hear the telephone ring.

**Note:** You can talk privately to the person at the transfer number before you press the **Transfer** soft key.



To charge a call to an account when you add someone to a conference call:



1. Press the **Conference** soft key. The call is placed on hold.



or



2. Choose one of the following:
  - Press the **Charge** soft key.
  - Dial the **Call Detail Recording** FFC.



3. Dial the charge account number.



4. Dial the number of the person you want to add to the conference.



5. Press the **Conference** soft key.

## Using Enhanced Override

---

Use the Enhanced Override feature to override an active call after you attempt a Forced Camp-on. Use Enhanced Override to make a call or a consultation call, such as placing a call on hold and calling another party.

### To use Enhanced Override:



You receive a busy signal after dialing a telephone number.



or



1. Choose one of the following:

- Press the **Override** key.
- Enter the **Override** FFC to initiate a Forced Camp-on.

If either person on the call disconnects at this time, you receive an overflow (fast busy or engaged) signal.



or



2. Choose one of the following:

- Press the **Override** key again.
- Enter the **Override** FFC again.

The other two people on the call receive an override tone and a conference call is established between the three of you. If anyone disconnects, the other two people remain connected.



(Goodbye)

3. To terminate the call, press the **Goodbye** key.

## Using Forced Camp-on

---

Use the Forced Camp-on feature to automatically ring another telephone (internal or external) immediately after that telephone disconnects from its current call.

### To use Forced Camp-on:



You receive a busy signal after dialing a telephone number.

EnhOvr 

or



1. Choose one of the following:
  - Press the **Override** key.
  - Enter the **Override** FFC, to initiate a Forced Camp-on.

**Note:** The person you called receives a tone, and you receive a ring signal or a busy signal, depending on the options chosen. You are now camped-on to the number you dialed.

2. Return the handset to the cradle.
3. When the person you called finishes the call, your telephone automatically dials the number and both telephones ring.

### Answering a call camped-on to your extension:



When your telephone rings, lift the handset.

**Note:** You can program your telephone for either Camp-on or Call Waiting, but not both.

## Overriding a busy signal

---

Use the Override feature to override a busy signal and interrupt another call.

### To override a busy signal:



1. You receive a busy signal after dialing a telephone number.

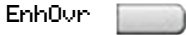

or



2. Choose one of the following:

— Press the **Override** key.

— Enter the **Override** FFC. The people in the targeted call receive a tone for approximately 1 second. After Override joins you to their call, a short tone repeats every 16 seconds.



(Goodbye)

3. To terminate the call, press the **Goodbye** key.

## Using Privacy Release

---

Use the Privacy Release feature to enable one or more people who share your DN to join a call.

### To use Privacy Release in an established state:



Press the **Privacy Release** soft key during a call. People can join the call by pressing the shared number (DN) key on their telephone (Multiple Appearance DN feature).

## Using Radio Page

Use the Radio Page feature to page a person and stay on the line until they answer. The paged person answers the call after entering a special Page Meet-me code from any telephone.

### To use Automatic Preselection (Meet-me page):

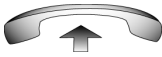

1. Lift the handset.



2. Dial the **Radio Paging Access** FFC. The paging tone sounds (two beeps followed by a dial tone).



3. Dial the number of the party you want to page. After dialing, the ringback tone sounds.

**Note:** The paged person can use any telephone to enter a **Radio Paging Answer** FFC, plus their own DN number.



(Goodbye)

or

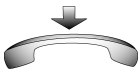

4. If your call goes unanswered for a preset time period and a 15-second high-pitched tone sounds followed by silence, press the **Goodbye** key or replace the handset.

### To use Automatic Post-selection:

The called party is either busy on the telephone or away from their desk. To page the called party, you do not need to redial the number of the called party.



1. Press the **Radio Page** soft key. A special dial tone sounds.



2. Dial the **Radio Paging Access** FFC. The ringback tone sounds.

**Note:** The paged person can use any telephone to enter a **Radio Paging Answer** FFC, plus their own DN number.

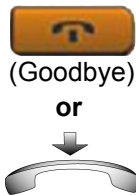

3. If your call goes unanswered for a preset time period and a 15-second high-pitched tone sounds, followed by silence, press the **Goodbye** key or replace the handset.

### To answer a Radio Page:

If you carry a Radio Pager, a page indicates that someone dialed your DN. If the Radio Page system is configured to function in Meet-me mode, you can answer the page call from any telephone.

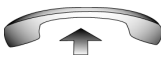

1. Lift the handset.



2. Dial the **Radio Paging Answer** FFC. The paging tone sounds.



3. Dial your own DN to connect to the paging caller. If the caller has disconnected, a steady high-pitched (number unavailable) tone sounds.

## Using Voice Call

---

Use the Voice Call feature to make an announcement through someone else's telephone speaker.

### To make a voice call:



1. Lift the handset.

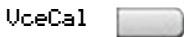

2. Press the **Voice Call** key and make the announcement.



(Goodbye)

3. Press the **Goodbye** key.

### To respond to a voice call:

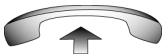

Your telephone rings once and the caller's voice transmits through your speaker. Lift the handset.

# Additional phone features

The following features are described in this section:

- “Using the Personal Directory” on page 112
- “Using the Callers List” on page 115
- “Using the Redial List” on page 117
- “Using Virtual Office” on page 119
- “Using Media Gateway 1000B” on page 128

## Using the Personal Directory

---

Use the Personal Directory feature to create and store up to 100 directory entries. A Personal Directory entry can contain:

- last name (up to 24 characters)
- first name (up to 24 characters)
- telephone numbers (up to 31 characters)

To use the Personal Directory, press the Directory key and select Personal Directory.

**Note:** If password control has been enabled, enter your SCPW at the prompt.

**To add an entry:**



1. Press the **Add** soft key.

**Note:** If the message *Directory is full* appears, delete one or more entries to add a new entry.





2. Use the dialpad to enter the name.

Next



3. Press the **Next** soft key.



4. Use the dialpad to enter the telephone number.

Done



or

Cancel



5. Choose one of the following:

- Press the **Done** soft key to save the new entry.
- Press the **Cancel** soft key to discard the new entry and return to the Add screen.

### To edit an entry:



1. Press the **Up/Down** navigation keys to scroll and highlight the desired entry.

Edit



2. Press the **Edit** soft key and perform your edits.

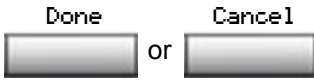

3. Choose one of the following:
  - Press the **Done** soft key to save the changes.
  - Press the **Cancel** soft key to return to the Personal Directory without saving your changes.

### To delete an entry:



1. Press the **Up/Down** navigation keys to scroll and highlight the entry.
2. Press the **Delete** soft key.

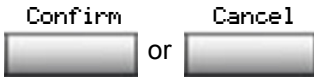

3. Choose one of the following:
  - Press the **Confirm** soft key to delete the entry.
  - Press the **Cancel** soft key to return to the Personal Directory without deleting the entry.

### To search for an entry:



1. Press the **Up/Down** navigation keys to scroll and highlight the desired entry.

2. Choose one of the following:
- Press the **Dial** soft key to dial the resulting number.
  - Press the **Cancel** soft key to exit without dialing.

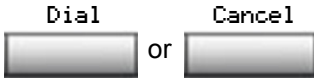

## Using the Callers List

---

The Callers List feature logs all incoming calls. The Callers List can store up to 100 entries. When the list is full, the system overwrites the oldest entry. Use the Callers List feature to review missed calls and to dial calls. The Callers List contains:

- the caller's last and first name (if available)
- the DN of the caller
- the time and date of the call
- the number of times the caller called

Entries in the Callers List are sorted by the time the call arrived.

**Note:** Calling Party Name Display (CPND) is affected depending on the Preferred Name Match option. If Preferred Name Match is on, the CPND appears according to your configurations. If the Preferred Name Match option is off, the CPND appears according to the system configurations.

To access the Callers List, press the **Directory** key and select **Callers List**.

**Note:** If password control is enabled, enter your SCPW at the prompt.

### To dial an entry:



Dial



1. Press the **Up/Down** navigation keys to scroll and highlight the desired entry.
2. Press the **Dial** soft key.

### To delete an entry:



Delete



1. Press the **Up/Down** navigation keys to scroll and highlight the desired entry.
2. Press the **Delete** soft key.

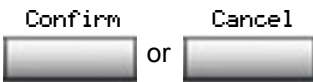

3. Choose one of the following:
  - Press the **Confirm** soft key.
  - Press the **Cancel** soft key.

### To delete the entire Callers List:

Delete



1. Press the **Delete** soft key.

2. Choose one of the following soft keys:
- **Yes** to delete the entire Callers List
  - **No** to return to the previous screen

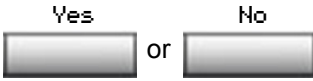

## Using the Redial List

---

The Redial List feature logs all outgoing calls. The Redial List can store up to 20 entries. When the list is full, the system overwrites the oldest entry. Use the Redial List feature to review calls made and to redial previously dialed calls. The Redial List contains:

- the last and first name of the dialed party (if available)
- the DN of the dialed party
- the time and date of the last dialed occurrence

Entries in the Redial List are sorted by the time the call arrived.

**Note:** Calling Party Name Display (CPND) is affected depending on the Preferred Name Match option. If Preferred Name Match is on, the CPND appears according to your configurations. If the Preferred Name Match option is off, the CPND appears according to the system configurations.

To access Redial List, press the **Directory** key and select **Redial List**.

**Note:** If password control is enabled, enter your SCPW at the prompt.

**To dial an entry:**



1. Press the **Up/Down** navigation keys to scroll and highlight the desired entry.

Dial



2. Press the **Dial** soft key.

To delete an entry:



1. Press the **Up/Down** navigation keys to scroll and highlight the desired entry.

Delete



2. Press the **Delete** soft key.

3. Choose one of the following soft keys:

Yes



or

No



— **Yes** to delete the entry

— **No** to return to the previous screen

To delete the entire Redial List:.

Delete



1. Press the **Delete** soft key.

2. Choose one of the following soft keys:

Yes



or

No



— **Yes** to delete the entire Callers List

— **No** to return to the previous screen

## Using Virtual Office

The Virtual Office feature provides a service you can use while you are away from your desk to transfer calls, and all your office telephone features, to a remote telephone. Virtual Office makes this possible by allowing you to use another IP Phone (the Remote phone) to log in to your own home or office IP Phone (the Office phone). After you log in, you can access the DN, autodial numbers, key layout, feature keys, and voicemail features that are configured on your own home or office IP Phone.

To use Virtual Office, you need your DN and preconfigured Station Control Password (SCPW). You must activate Virtual Office on your Office phone before you can connect to it from a Remote phone. See “Logging in to Virtual Office” on page 120.

**Note:** Consult your system administrator to verify if the Virtual Office feature is available for your use.

You can use an IP Phone as a Remote phone to connect to your IP Phone 1120E even if it is a different IP Phone model. Table 7 shows the IP Phones on which you can use Virtual Office to connect to your IP Phone 1120E.

**Table 7: Virtual Office connection availability**

IP Phone model	Possible to log in to the 1120E?
IP Phone 1120E	Yes
IP Phone 1140E	Yes
IP Phone 2001	Yes, with restrictions
IP Audio Conference Phone 2033	Yes, with restrictions
IP Phone 2002	Yes
IP Phone 2004	Yes
IP SoftPhone 2050	Yes, with restrictions

**Table 7: Virtual Office connection availability**

IP Phone model	Possible to log in to the 1120E?
IP Phone 2007	Yes

**Note 1:** When logged into an IIP Phone 1120E or an IP Softphone 2050 using Virtual Office, feature keys 4 and 5, and the Shift key, are not available to the IP Phone 1120E.

**Note 2:** A Virtual Office login to an IP Phone 1120E from an IP Phone 2001, IP Audio Conference Phone 2033, or IP Softphone 2050 is blocked in certain situations. Consult your system administrator.

## Logging in to Virtual Office

To activate Virtual Office on your Office telephone from your Remote telephone:



(Services)

1. Press the **Services** key.



2. Press the **Up/Down** navigation keys to scroll and highlight **Virtual Office Login**.



3. Press the **Enter** key.



4. At the prompt, enter your user ID.



5. Press the **Enter** key.





6. At the prompt, enter the home **Station Control Password (SCPW)**.

**Note 1:** If the user ID is not found locally, the message “Locating Remote Server” is displayed.

**Note 2:** After three failed login attempts, wait 1 hour before attempting to log in again, or contact your system administrator to reset your password. For more information, see “Security features” on page 20.

**Note 3:** Your Virtual Office session expires after a fixed period of time, (determined by your system administrator).

A successful login transfers all the features, time, date, and tones to your Remote telephone from your Office telephone.

## Using Virtual Office on your Remote telephone

Because the display characteristics, including size, vary from one IP Phone model to the next, your Office IP Phone 1120E display is different on each Remote phone. Figure 9 shows an IP Phone 1120E logged in as a Remote phone to an IP Phone 1120E Office phone. All the features appear as they do on your Office IP Phone 1120E.

**Figure 9: Logged in to an IP Phone 1120E**



Figure 10 shows an IP Phone 1140E logged in as a Remote phone to an IP Phone 1120E Office phone. Fewer display lines are available on the IP Phone 1120E, so the display provides less information.

**Figure 10: Logged in to an IP Phone 1120E using an IP Phone 1140E**



Figure 11 shows an IP Softphone 2050 logged in as a Remote phone to an IP Phone 1120E Office phone. In this case, the information display is arranged in a different fashion, but all the information is visible at one time.

**Figure 11: Logged in to an IP Phone 1120E using an IP Softphone 2050**

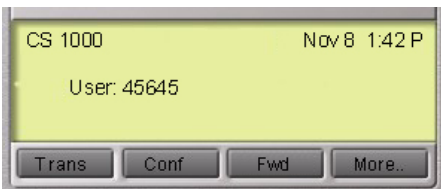

## Using Virtual Office on your Office telephone

Figure 12 shows the IP Phone 1120E display when the phone is logged out due to remote access.

**Figure 12: Office phone displays the message *Logged Out***



When activated for Virtual Office by a Remote telephone, your Office telephone is *logged out* and no longer operational. If this is the case when you return to your office, you can disconnect the remote login and regain control of your Office phone. If you do not disconnect the remote login, your Virtual Office session expires after a fixed period of time, determined by your system administrator.

## To regain operation of a telephone being used for Virtual Office:

Choose one of the following:

Home 



or

Virtual



- To completely disconnect your Office telephone from the Remote telephone:
  - a. Press the **Home** key.
  - b. Enter your User ID and password (this logs the Office telephone back on to your office network).
- Press the **Virtual** soft key to log in to another IP Phone, and your telephone becomes a Remote telephone.

## Logging out of Virtual Office

While working on a Remote phone, you can log out of Virtual Office using the following steps.

### To log out from a Remote telephone:



(Services)

1. Press the **Services** key.



2. Press the **Up/Down** navigation keys to scroll and highlight **Virtual Office Logout**.



3. Press the **Enter** key.

## Troubleshooting Virtual Office

Virtual Office can display error messages on-screen. Table 8 lists error messages and describes actions to correct the causes.

**Table 8: Troubleshooting Virtual Office (Part 1 of 3)**

Displayed Message	Probable Cause	Actions
Busy, try again	Remote IP Phone is active (not idle).	Wait for remote IP Phone to become idle and try again.
	ACD is logged in.	Log out ACD IP Phone before Virtual Office from another IP Phone.
	Make Set Busy is inactive on ACD IP Phone.	Configure Make Set Busy active on ACD IP Phone.
Invalid ID (1)	Incorrect User ID entered.	Enter correct User ID.
	User ID is not in Gatekeeper database.	Notify system administrator.
Invalid ID (2)	Incorrect User ID entered.	Enter correct User ID.
Invalid ID (3)	Incorrect User ID entered.	Enter correct User ID.
	User ID in Gatekeeper database points to originating Call Server.	Notify system administrator.

**Table 8: Troubleshooting Virtual Office (Part 2 of 3)**

Displayed Message	Probable Cause	Actions
Locked from Login	Three failed attempts to enter the correct Station Control Password.	Wait one hour for the lock to clear automatically, or notify system administrator to clear lock.
Permission Denied (1)	Remote telephone has no Station Control Password.	Notify system administrator.
Permission Denied (3)	Incorrect User ID entered.	Enter correct User ID.
	Remote telephone has no Station Control Password.	Notify system administrator.
Permission Denied (4)	Incorrect User ID entered.	Enter correct User ID.
	Attempt to log in to a remote IP Phone 2004 or IP Softphone 2050 from an IP Phone 1120E (some restrictions apply).	Go to an IP Phone 2004 or IP Softphone 2050 and try again, or consult your local system administrator.
Permission Denied (5)	Incorrect User ID entered.	Enter correct User ID.
	Remote telephone does not have VOUA Class of Service.	Notify system administrator.

**Table 8: Troubleshooting Virtual Office (Part 3 of 3)**

Displayed Message	Probable Cause	Actions
Permission Denied (6)	Incorrect User ID entered.	Enter correct User ID.
	Incorrect Station Control Password entered.	Select Retry, and try again with the correct Station Control Password.
Server Unreachable (1)	Network problem.	Notify system administrator if the problem persists.
Server Unreachable (2)	Network problem.	Notify system administrator if the problem persists.

## Using Media Gateway 1000B

The Media Gateway 1000B (MG 1000B) provides a means of extending CS 1000 Release 4.5 features to one or more remotely located branch offices using the Branch Office feature. A branch office is a remote location in the network where IP Phones, PSTN access, and TDM telephones are located. Contact your system administrator to see if these functions are available for your use.

The Media Gateway 1000B (MG 1000B) telephone can operate in Normal or Local Mode.

### Normal Mode

The telephone registers with the Main Office and receives telephone services from the Main Office. At any time during Normal Mode, you can check Local Mode functionality (make and receive calls) by enabling Local Mode and returning to Normal Mode. After testing, you can return to Normal Mode (see “Using Resume Normal Mode” on page 129) or by waiting for 10 minutes.



## Local Mode

If the WAN connection fails, the IP Phone loses communication with the Main Office Telephone Preference Service (TPS). It then registers with the MG 1000B and receives telephone services from the MG 1000B. Features such as Personal Directory, Redial List, and Callers List are not available when operating in Local Mode. When in Local Mode, the telephone displays the message *LOCAL MODE*.

## Using Test Local Mode

Use Test Local Mode to check Local Mode functionality (make and receive telephone calls). Test Local Mode is useful when provisioning has changed for an IP Phone on an MG 1000B Controller.



(Services)

1. Press the **Services** key.



2. Press the **Up/Down** navigation keys to scroll and highlight **Test Local Mode**.



3. Press the **Enter** key (the telephone resets and registers back to the Main Office).

## Using Resume Normal Mode

Use the Resume Normal Mode command to return to Normal Mode after testing survival functionality.

**Note:** If you do not use the Resume Normal Mode command after testing, the telephone automatically returns to Normal Mode in 10 minutes.



(Services)

1. Press the **Services** key.



2. Press the **Up/Down** navigation key to scroll and highlight **Resume Normal Mode**.



3. Press the **Enter** key (the telephone registers back to the main office).

## Troubleshooting MG 1000B

The MG 1000B can display error messages on-screen. Table 9 lists error messages and describes actions to correct the causes.

**Table 9: Troubleshooting MG 1000B (Part 1 of 2)**

Display Message	Probable Cause	Actions
Local Mode	Test Local Mode.  Network problem.	Press the <b>Services</b> key, and then select Resume Normal Mode.  Contact system administrator if problem persists.
Local Mode Invalid ID (1)	Gatekeeper unable to find end point from Branch User ID.	Notify system administrator.

**Table 9: Troubleshooting MG 1000B (Part 2 of 2)**

Display Message	Probable Cause	Actions
Local Mode Invalid ID (2)	Branch User ID not found in any equipped TN.	Notify system administrator.

# Using Hospitality features

Hospitality features are intended for hotel operations. The following features are discussed in this section:

- “Configuring Automatic Wake-Up” on page 132
- “Activating Message Registration” on page 134
- “Using Maid Identification” on page 136
- “Displaying Room Status” on page 137

## Configuring Automatic Wake-Up

---

Use the Automatic Wake-Up feature to receive a timed reminder call. From your telephone, you can program the system to automatically place a call to you at a predetermined time. When you answer the call, recorded music plays for up to 30 seconds, followed by a prerecorded announcement or the attendant.

**To enter the time for an Automatic Wake-Up call:**



1. Lift the handset.



2. Dial the **Automatic Wake-Up Request FFC**.



3. Dial the **Automatic Wake-Up** time in a 24-hour time format (hhmm). A tone sounds to confirm your entered time.

**Note:** In a 24-hour time format,  
7:30 a.m. is entered as 0730;  
9:45 p.m. is entered as 2145.



(Goodbye)

4. Press the **Goodbye** key.

### To cancel an Automatic Wake-Up call:



1. Lift the handset.



2. Dial the **Automatic Wake-Up Quit** FFC.



(Goodbye)

3. Press the **Goodbye** key.

### To verify the time for the Automatic Wake-Up call:



1. Lift the handset.



2. Dial the **Automatic Wake-Up Verify** FFC.



3. Dial the **Automatic Wake-Up** time in a 24-hour time format (hhmm). If your query matches the preset time, a confirmation tone sounds.

**Note:** In a 24-hour time format, 7:30 a.m. is entered as 0730; 9:45 p.m. is 2145.



(Goodbye)

4. Press the **Goodbye** key.

## Activating Message Registration

---

Use the Message Registration feature to read, change, or reset meters that log your hotel telephone calls.

### To read meters:



1. Press the **Message Registration** key.



2. Dial the room **Directory Number** (DN).



3. Press the **Message Registration** key.

### To change a meter:



1. Press the **Message Registration** key.



2. Dial the **Directory Number** (DN).



3. Dial the correct meter count.



4. Press the \* key.

MRK



5. Press the **Message Registration** key.

**To reset a meter to zero:**

MRK



1. Press the **Message Registration** key.



2. Dial the room DN.



3. Press the \* key.

MRK



4. Press the **Message Registration** key.

## Using Maid Identification

Use the Maid Identification feature to track the cleaning status of rooms. The maid enters the information from the telephone in each room.

### To enter cleaning status:

RMK



1. Press the **Room Status** key.



2. Dial the DN for the room.



3. Dial one of the following cleaning status codes:

1 = Cleaning requested

2 = Cleaning in progress

3 = Room cleaned

4 = Room passed inspection

5 = Room failed inspection

6 = Cleaning skipped

The interrupted dial tone sounds.



4. Press the \* key.



5. Dial the **Maid ID**. If you dial the wrong **Maid ID**, press the \* key and redial the ID.

RMK



6. Press the **Room Status** key.



## Displaying Room Status

---

Use the Room Status feature to display the status of a room using the Display Module.

**To read the status of a room:**

RMK



1. Press the **Room Status** key.



2. Dial the DN for the room. The DN is displayed followed by a two-digit code. The first digit indicates the occupancy status:

0 = Room vacant

1 = Room occupied

The second digit indicates the cleaning status of the room:

1 = Cleaning requested

2 = Cleaning in progress

3 = Room cleaned

4 = Room passed inspection

5 = Room failed inspection

6 = Cleaning skipped

RMK



3. Press the **Room Status** key.

**Changing the status of a room:**

RMK



1. Press the **Room Status** key.



2. Dial the DN for the room. The DN displays followed by a two-digit code. The first digit indicates the occupancy status:

0 = Room vacant

1 = Room occupied

The second digit indicates the cleaning status of the room:

1 = Cleaning requested

2 = Cleaning in progress

3 = Room cleaned

4 = Room passed inspection

5 = Room failed inspection

6 = Cleaning skipped



3. Dial the status code for the room. A three-digit code appears. The first digit indicates the occupancy status, the second is the previous cleaning status, and the third is the new status.

RMK



4. Press the **Room Status** key.

# Accessing External Server Applications

Use External Server Applications to access a variety of applications directly from your IP Phone 1120E.

To find out what features and services are available, contact your system administrator. Depending on what is available on your system, your phone can provide information; for example, local news and weather, stock market information, or traffic reports.

For more information about the External Server Applications, consult the *Nortel IP Phone External Server Applications User Guide*.

# Flexible Feature Codes (FFC)

Use Table 10 to keep track of the FFCs assigned by your system administrator.

**Table 10: Flexible Feature Codes (Part 1 of 2)**

FFC	Feature	FFC	Feature
	Automatic Wake-Up Activate		Make Set Busy Activate
	Automatic Wake-Up Deactivate		Make Set Busy Deactivate
	Automatic Wake-Up Verify		Malicious Call Trace
	Call Detail Recording Charge Account		Override
	Call Forward All Calls Activate		Pickup Ringing Number
	Call Forward All Calls Deactivate		Pickup Directory Number
	Call Park		Pickup Group
	Electronic Lock Activate		Radio Paging Access
	Electronic Lock Deactivate		Radio Paging Answer
	Group Call		Remote Call Forward Activate
	Internal Call Forward Activate		Remote Call Forward Deactivate
	Internal Call Forward Deactivate		RingAgain Activate

**Table 10: Flexible Feature Codes (Part 2 of 2)**

FFC	Feature	FFC	Feature
	RingAgain Deactivate		Virtual Office Terminal Log Off
	Station Control Password Change		Virtual Office Terminal Log On



# Terms you should know

## Calling Party Name Display

Information appearing on the LCD display screen, such as the caller's name and telephone number. The system must have CPND enabled.

## Category 5 (Cat5)

Cable and associated connecting hardware capable of transmitting at speeds up to 100 MHz, used by 10BaseT, 100BaseT4, 100BaseTX.

## Category 5e (Cat5e)

Most Cat5 cable manufactured after 1996 also supports 1000BaseT (GigE) installations, and is designated Cat 5e. Cat5e cable normally has four pairs of copper wire.

## Category 6 (Cat6)

Cable and associated connecting hardware capable of transmitting at speeds up to 200 MHz. Designed specifically to support 1000BaseT (Gig Ethernet (GigE)), it is also compatible with 10BaseT, 100BaseT4, and 100BaseTX installations. The cable normally has four pairs of copper wire.

## Communication Server 1000

Your office communication system.

## Date/time display

The current date and time when the telephone is in an idle state.

## Directory Number (DN)

A number consisting of one to seven digits for a telephone, and also known as an *extension number*.

### **Feature display**

An area that shows status information about the feature in use. It also displays the name and status of the active session.

### **Feature Status Lamp indicator**

An LCD or an LED that indicates a data message, contact, or feature status by a flash, wink, steady on, or off.

### **Fixed key**

The hard-labeled keys on your telephone.

### **Flexible Feature Codes (FFC)**

Specialized codes entered using the dialpad that enable features (for example, Ring Again).

### **Goodbye key**

A fixed key used to end an active call.

### **Indicator**

An LCD or an LED that indicates the status of a feature by the flash, wink, steady on, or off.

### **Information display**

Any display of call activity, lists, prompts, and status of calls. On your IP Phone 1120E, this information area is one line of text and symbols. If a text message exceeds this area, a scroll arrow icon indicates that you must use the scroll keys to view the remaining text.

### **Information line**

A one-line by 24-character area that displays date and time or application information.



### **Interrupted dial tone**

A broken or pulsed dial tone that sounds when you access some features on your telephone.

### **Message/Inbox**

A fixed key on your IP Phone 1120E that connects to your voice messaging system when the key is pressed.

### **Navigation keys**

Keys used to scroll through menus and lists appearing on the LCD display screen.

### **Off-hook**

Any line selected to make a call or receive an incoming call. The term *off-hook* is applied when (a) the end-user lifts up the handset, (b) the end-user presses a line key, (c) the call is automatically answered at the telephone, or (d) a line is automatically selected for an outgoing call.

### **Paging tone**

A special tone (two beeps followed by dial tone) that sounds when you use the Radio Paging feature.

### **Ringback/ring tone**

A sound indicating that a call you have made is ringing at its destination.

### **Services key**

A fixed key used to access options such as Telephone Options, Password Admin, Virtual Office Login, Virtual Office Logout, Test Local Mode, and Resume Normal Mode.

### **Shared Directory Number**

A DN (extension) that is shared by two or more persons.

### Special Prefix code (SPRE)

Special codes entered using the dialpad, followed by a two-digit access code, that enable features (for example, Call Forward All Calls requires entry of SPRE code + 74).

### Soft keys

A set of keys programmed by your system administrator. These four keys, located directly below the display area, have four programmable layers. These keys are also used to configure parameters in the **Telephone Options** menu.

### Special dial tone

The three consecutive tones followed by dial tone that you hear when accessing telephone features.

### Station Control Password (SCPW)

Enables security features on your phone to prevent others from making calls from your telephone and to prevent access to protected features (for example, Remote Call Forward).

### Status Messages

A message displayed to inform the user of important information. A right arrow appears if more than one Status Message is present. Examples of Status Messages include: Message Waiting, All Lines Forwarded to: 6453, Do Not Disturb On, Ring Again active, and Ringer is OFF.

### System or Switch

Your office communication system.

### Switchhook

A button on which the handset presses down, disconnecting your call when you replace the handset. The handset (when lifted) releases the switchhook, and you either answer an incoming call or you receive a dial tone to make a call.

## **User interface**

Screen displays that interact with the end user as a result of an action or event.

## **Visual Alerter/Message Waiting indicator**

An LCD or an LED that flashes to indicate that a message is waiting or when the ringer is on.



# Regulatory and safety information

This equipment has been tested and found to comply with the limits for a Class B digital device, pursuant to part 15 of the FCC Rules. These limits are designed to provide reasonable protection against harmful interference in a residential installation. This equipment generates, uses and can radiate radio frequency energy and, if not installed and used in accordance with the instructions, may cause harmful interference to radio communications. However, there is no guarantee that interference will not occur in a particular installation. If this equipment does cause harmful interference to radio or television reception, which can be determined by turning the equipment off and on, the user is encouraged to try to correct the interference by one or more of the following measures:

- Reorient or relocate the receiving antenna.
- Increase the separation between the equipment and receiver.
- Connect the equipment into an outlet on a circuit different from that to which the receiver is connected.
- Consult the dealer or an experienced radio/ TV technician for help.

**Note:** The user should not make changes or modifications not expressly approved by Nortel Networks. Any such changes could void the user's authority to operate the equipment

This Class B digital apparatus complies with Canadian ICES-003. Cet appareil numérique de la classe B est conforme à la norme NMB-003 du Canada.

## Warnings:

- This is a Class B product. In a domestic environment this product can cause radio interference in which case the user must take adequate measures.
- Operation is subject to the following two conditions: (1) this device may not cause interference, and (2) this device must accept any interference, including interference that may cause undesired operation of the device."
- Privacy of communications may not be ensured when using this telephone.

To prevent radio interference to the licensed service, this device must be operated indoors only and should be kept away from windows to provide maximum shielding.

この装置は、情報処理装置等電波障害自主規制協議会（VCCI）の基準に基づくクラスB 情報技術装置です。この装置は、家庭環境で使用することを目的としていますが、この装置がラジオやテレビジョン受信機に近接して使用されると、受信障害を引き起こすことがあります。

取扱説明書に従って正しい取り扱いをして下さい。

Table 11 lists EMC compliance for various jurisdictions.

**Table 11: EMC compliance**

Jurisdiction	Standard	Description
United States	FCC CFR 47 Part 15	Class B Emissions: FCC Rules for Radio Frequency Devices (see Notes 1 and 2)
Canada	ICES-003	Class B Emissions: Interference-Causing Equipment Standard: Digital Apparatus
Australia/ New Zealand	AS/NZS 3548 CISPR 22	Class B Emissions: Information technology equipment - Radio disturbance
European Community	EN 55022	Class B Emissions: Information technology equipment - Radio disturbance
	EN 55024	Information technology equipment - Immunity characteristics Limits and methods of measurement
	EN 61000-3-2	Limits for harmonic current emissions (equipment input current $\leq 16$ A per phase)
	EN 61000-3-3	Limitation of voltage fluctuations and flicker in low-voltage supply systems for equipment with rated current $\leq 16$ A
Japan	VCCI	Regulations for voluntary control measures.

## DenAn regulatory notice for Japan



警告

本製品を安全にご使用頂くため、以下のことにご注意ください。

- 接続ケーブル、電源コード、ACアダプタなどの部品は、必ず製品に同梱されております。添付品または指定品をご使用ください。添付品・指定品以外の部品をご使用になると故障や動作不良、火災の原因となることがあります。
- 同梱されております付属の電源コードを他の機器には使用しないでください。上記注意事項を守らないと、死亡や大怪我など人身事故の原因となることがあります。



Warning

Please be careful of the following while installing the equipment:

- Please only use the Connecting cables, power cord, AC adaptors shipped with the equipment or specified by Nortel to be used with the equipment. If you use any other equipment, it may cause “failures, malfunctioning or fire”.
- Power cords shipped with this equipment must not be used with any other equipment. In case the above guidelines are not followed, it may lead to death or severe injury

## Other

**US/Canada:** Hearing Aid Compatibility (HAC) as per FCC Part 68

This equipment complies with the CE Marking requirements. 

**EU Countries:** This device complies with the essential requirements and other relevant provisions of Directive 1999/5/EC. A copy of the Declaration may be obtained from Nortel Networks GmbH address: Ingolstaedter Strasse 14-18, 80807 Munich Germany





# Index

## A

- Adjusting the display screen contrast 36
- Adjusting the volume 35
- Area Code Setup 43
- Attendant Recall 78
- AutoDial 67
- AutoDial Transfer 100
- Automatic Wake-Up 132

## B

- Buzz feature 101

## C

- Call Forward 87
- Call Join 93
- Call log options 51
- Call Page 101
- Call Page Connect 101
- Call Park 79
- Call party information 143
- Call Timer 47
- Call Waiting 85
- Callers List 64
- Callers List log 41
- Calling 58
- Calling Party Number 81
- Camp-on, Forced 106
- Centrex/Exchange Line Switch-hook Flash 102
- Change feature key labels 47

- Changing feature key labels 47
- Charge a call or charge a forced call 102
- Choosing ring type 47
- Conferee Selectable Display and Disconnect 95
- Conference call 94
- Configure Callers List log 41
- Configure Name Display format 45
- Configure New Call indication 42
- Configuring Area Code Setup 43
- Configuring call log options 51
- Configuring Name Display format 45
- Connect the components 26
- Connecting the components 26
- Contrast adjustment 36
- Copy Key 16
- Corporate Directory 62

## D

- Date/time display 143
- Date/Time format 37
- Directory applications 62
- Directory key 19
- Directory Number 143
- disconnect a conferee 95
- display areas 19
- Display diagnostics 47
- Display incoming calls 81
- Display Settings 53
- DN 143

**E**

- Electronic Lock 91
- Enabling OnHook Default Path 47
- Enabling/disabling Call Timer 47
- Enhanced Override 105
- Entering and editing text 23
  - Editing text using the soft keys 24
  - Entering text using the USB keyboard 25
- Expand to PC key 15
- External server applications 139

**F**

- Feature display 144
- Fixed key 144
- Flexible Feature Code (FFC) 84, 144
- Flexible Feature Codes (FFCs) 140

**G**

- Goodbye key 16, 144
- Group Call 96

**H**

- Handsfree / Speaker key 15
- Handsfree dialing 60
- Headset key 15
- Hold key 15
- Hospitality features 132
- Hot Line 72

**I**

- Indicator status 144

- Information display 144
- Information line 144
- Intercom call 73
- Internal Call Forward 88
- Interrupted dial tone 145

**L**

- Language display 36
- Last Number Redial 70
- Line (DN) key 14
- Local Area Network (LAN) 11
- Local Diagnostics 56
- Local DialPad Tone 47
- Local mode 129

**M**

- Maid Identification 136
- Make Set Busy 99
- Malicious Call Trace 82
- Media Gateway 1000B 128
- Meet - me page 109
- Message (Inbox) key 19
- Message key 145
- Message Registration 134
- Message waiting indicator 16, 147
- More key 13
- Mute key 14

**N**

- Navigation keys 15, 145
- New Call indication 42
- Normal mode 128

**O**

Off-hook 145  
Off-hook dialing 58  
Onhook Default Path 47  
On-hook dialing 59  
Override a busy signal 107

**P**

Paging tone 145  
Personal Directory 63  
Place a call on hold 75  
Predial feature 66  
Preferred Name Match 43  
Privacy Release 108

**R**

Radio Page 109  
Record a Calling Party Number 81  
Redial List 65  
Regulatory and safety information 149  
Remote Call Forward 89  
Resume Normal Mode 129  
Ring Again 69  
Ring type 47  
Ringback/ring tone 145  
Room Status 137

**S**

Secure your telephone 91  
Security features 20  
Selecting a language 36  
Selecting date/time format 37  
Services key 17, 145

Shared Directory Numbers 145  
Soft keys 13  
Soft keys (self-labeled) 146  
Special dial tone 146  
Special Prefix code (SPRE) 146  
Speed Call 71  
Station Control Password (SCPW) 20, 146  
    change your password 20  
    turn Password Protection on or off 22  
Status Messages 146  
Switchhook 146  
System or Switch 146  
System Speed Call 72

**T**

Telephone controls 13  
Telephone information 51  
Telephone Options 33  
Test Local Mode 129  
The Telephone Option menu 33  
Timed Reminder Recall 77  
Transfer a call 76

**U**

USB keyboard  
    function keys 25  
User Interface 147

**V**

Viewing telephone information 51  
Virtual Office 119  
Virtual Office login 120  
Virtual Office logout 125

Virtual Office on your Remote telephone 121

Voice Call 111

Volume adjustment 35

Volume control 14

Volume control bar 14



Nortel Communication Server 1000

# IP Phone 1120E

## User Guide

Copyright © 2006 Nortel Networks. All rights reserved.

The information in this document is subject to change without notice. The statements, configurations, technical data, and recommendations in this document are believed to be accurate and reliable, but are presented without express or implied warranty. Users must take full responsibility for their applications of any products specified in this document. The information in this document is proprietary to Nortel Networks.

Nortel, Nortel (Logo), the Globemark, SL-1, Meridian 1, and Succession are trademarks of Nortel Networks.

Publication Number: NN-10300-061

Document Release: Standard 2.00

Date: June 2006

Produced in Canada

To provide feedback or report a problem in this document, go to [www.nortel.com/documentfeedback](http://www.nortel.com/documentfeedback)



[www.nortel.com](http://www.nortel.com)