

North Carolina Floodplain Management

2017 Quick Guide



Floodplain Management Branch
www.nccrimecontrol.org/NFIP



**North Carolina Department of
Crime Control and Public Safety**

Table of Contents

Table of Contents	1	Approximate Flood Zones and Unnumbered A Zones	22
Introduction	3	AE Flood Zones With Non-Encroachment Areas	23
About This Guide	4	Limited Detailed Study	24
Useful Resources and Common Acronyms	5	Using Data from Limited Detailed Studies	25
North Carolina's Disaster Declarations	6	Levee Certification for FEMA Flood Maps	26
Why Communities Regulate the Floodplain	7	Letter of Map Change (LOMC) Information	27
Overview: National Flood Insurance Program (NFIP)	8	Pre-FIRM and Post-FIRM Structures	28
Community Responsibilities	9	Flood Map Revisions Processed by FEMA	29
Community Rating System (CRS)	10	Flood Map Revisions Processed by North Carolina	30
Be Prepared for Flood Emergencies	11	Community Flood Map Changes	31
Turn Around Don't Drown™	12	Community Flood Map Changes, Continued	32
North Carolina's Flood Warning Program	13	Risk MAP Products	33
Flood Map Information	14	Risk MAP Products, Continued	34
North Carolina Floodplain Mapping Program	15	Building Sites Higher Than the BFE	35
North Carolina Flood Risk Information System (FRIS)	16	Activities in SFHAs That Require Local Permits and Approvals	36
North Carolina Flood Risk Information System (FRIS) , Continued	17	Some Key Floodplain Development Permit Review Steps	37
Nature Doesn't Read Flood Maps	18	Applying for a Floodplain Development Permit	38
Old Format Flood Insurance Rate Map	19	Safer Uses of the Floodplain	39
Future Conditions Floodplain Mapping	20	Think Carefully Before You Seek a Floodplain Variance	40
Use the Riverine Flood Profile to Determine BFE	21	Freeboard: Build Higher, Reduce Damage, Save on Insurance	41

Elevation Certificate and Its Purpose	42	Post-Flood Compliance Funding	63
Completing the Elevation Certificate	43	Elevating Pre-FIRM Buildings	64
Documentation is Important – for You and Your Community	44	Easy and Low-Cost Protection Options for Older Homes	65
The Adverse Impacts of Floodplain Fill	45	More Expansive Flood Mitigation Projects	66
Required “No-Impact” Certification	46	Riverine Floodplains	67
How to Elevate your Floodplain Building (Riverine)	47	Understanding the Riverine Floodplain	68
Compaction of Floodplain Fill (A Zones)	48	Understanding the Floodway	69
Enclosures Below the BFE (A Zones)	49	Riverine: Flood Insurance Rate Map	70
Crawlspace Details (A Zones)	50	Coastal Floodplains	71
Basements Are Especially Flood Prone	51	Understanding the Coastal Floodplain	72
Manufactured Homes Require Special Attention	52	Coastal Areas: Flood Insurance Rate Map	73
Utility Service Outside Buildings	53	Coastal Area Management Act (CAMA) Permits	74
Utility Service Inside Enclosures	54	Typical Elevation Methods for Coastal Buildings	75
Accessory (Appurtenant) Structures	55	Wind and Water Requirements for Coastal Houses	76
Recreational Vehicles	56	Enclosures Below V Zone Buildings	77
Improving Your Floodplain Building	57	State of North Carolina V Zone Certification	78
Non-Substantial Improvements	58	Flood Insurance: Property Owner’s Best Protection	79
Substantial Improvement: Renovation Only	59	Flood Insurance: Property Owner’s Best Protection, Continued	80
Substantial Improvement: Lateral Addition Only	60	Factors that Affect Flood Insurance Rates	81
Substantial Improvement: Addition Plus Other Work	61	Learning More About Floodplain Management	82
Post-Damage Considerations	62	Learning More About Flood Insurance	83

Introduction

The North Carolina Division of Emergency Management is pleased to provide this **Quick Guide** to help our citizens understand what floodplain management is and why floodplain development is regulated.

Counties and local communities regulate development in floodplains to:

- **Protect** people and property
- **Ensure** that federal flood insurance and disaster assistance are available
- **Save** tax dollars
- **Reduce** liability and lawsuits
- **Reduce** future flood losses



Floods have been, and continue to be, a destructive natural hazard in terms of economic loss to the citizens of North Carolina. Since 1978, federal flood insurance policyholders in North Carolina have received over \$970 million in claim payments. Though that figure represents many insurance payments, most of the state's flood-prone properties do not have flood insurance. As of November 2015, only about 30% of buildings located in high-risk floodplain areas in North Carolina had a flood insurance policy.

About This Guide

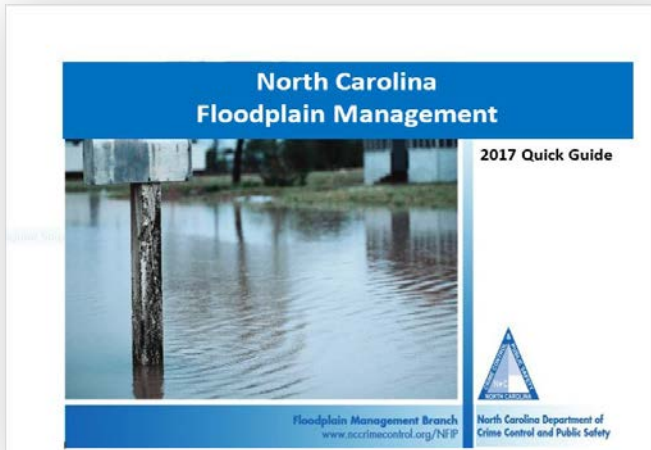

The North Carolina Division of Emergency Management Floodplain Management Branch prepared this **Quick Guide** to help you understand more about why and how communities in the state of North Carolina manage floodplains to protect people and property.

Flood-prone communities adopt ordinances that detail the rules and requirements for floodplain development. In case of conflict, the applicable ordinance, and not this publication, must be followed. For questions, contact your local planning, permit, engineering, or floodplain management official.

The Floodplain Management Branch coordinates the National Flood Insurance Program (NFIP) with North Carolina's local communities. For more information about the topics covered in this **Quick Guide** go to www.ncdps.gov.

In association with:



Printed with support from:



North Carolina Association of Floodplain Managers
www.ncafpm.org

This publication is supported with funding from the Department of Homeland Security (FEMA). It does not necessarily reflect the views of that agency.



FEMA

Useful Resources and Common Acronyms

The American Red Cross addresses disaster safety, being prepared, and repairing homes (Disaster Services): www.redcross.org

FEMA has developed materials to help families and businesses prepare for floods and recover from disasters: www.fema.gov/resource-document-library

NFIP regulations: www.fema.gov/national-flood-insurance-program-laws-regulations

CRS Resource Center: www.fema.gov/national-flood-insurance-program-community-rating-system

Association of State Floodplain Managers: www.floods.org

North Carolina Emergency Preparedness: www.readyNC.org

North Carolina Association of Floodplain Managers: www.ncafpm.org

North Carolina Society of Surveyors: www.ncsurveyors.com

Common Acronyms

- BFE = Base Flood Elevation
- EC = Elevation Certificate
- FEMA = Federal Emergency Management Agency
- FIRM = Flood Insurance Rate Map
- ICC = Increase Cost of Compliance
- NFIP = National Flood Insurance Program
- SFHA = Special Flood Hazard Area (1% Annual-Chance Floodplain)

Why Communities Regulate the Floodplain

- **Protect people and property.** Knowing where high-risk flood areas are in your community enables residents and businesses to make reasonable decisions regarding the purchase of flood insurance and protecting flood-prone property, creating a more sustainable and resilient community.
- **To ensure federal flood insurance and disaster assistance are available.** A community must participate in the National Flood Insurance Program (NFIP) for residents and businesses to be eligible to purchase federal flood insurance through the NFIP. If your community does not participate, flood insurance through the NFIP is not available and eligibility for federal disaster assistance is limited. In addition, homeowners may find it hard to secure, renew, or extend a mortgage loan. Please visit the NFIP Community Status Book site (www.fema.gov/national-flood-insurance-program-community-status-book) to find out if your community participates in the NFIP.
- **To save tax dollars.** Every flood disaster affects your community's budget. By building resiliently, we'll have fewer problems the next time it floods. Remember, federal disaster assistance isn't available for all floods. Even when the President declares a disaster, and federal grant funding is made available, you and your community may still be required to pay a portion of the costs associated with disaster response including repairing, rebuilding, and cleanup.
- **To reduce future flood losses to North Carolina communities.** Sustainable development that complies with or exceeds the minimum floodplain management requirements is better protected against flood-related damage.

Overview: National Flood Insurance Program (NFIP)

The National Flood Insurance Program was created by Congress in 1968 to protect lives and property from flooding and to reduce the financial burden of providing disaster assistance. The NFIP is administered by FEMA. Nationwide, over 22,000 communities participate in the NFIP including most of North Carolina's flood-prone communities.

The NFIP is based on an agreement between the federal government and participating communities.

The partnership involves:

- **Flood hazard maps.** In partnership with FEMA, North Carolina produces flood maps in accordance with FEMA standards. The maps are used by communities, insurance agents, and others.
- **Flood insurance.** Property owners in participating communities are eligible to purchase federal flood insurance for buildings and contents.
- **Regulations.** Communities must adopt and enforce minimum floodplain management regulations so that development in high-risk floodplain areas is undertaken in ways that reduce exposure to flooding. The Community Rating System (CRS) is a program developed by FEMA which credits NFIP communities that adopt floodplain standards beyond minimum federal requirements for participation in the NFIP. These activities reward communities for doing more by discounting flood insurance premiums for residents and businesses. To learn more about FEMA's CRS program, visit www.fema.gov/community-rating-system. Related information may be found in other sections of this document.



Community Responsibilities

To participate in the National Flood Insurance Program, a community agrees to:

- **Adopt and enforce** a flood damage prevention ordinance
- **Require** permits for all development in the floodplain
- **Ensure** that all development is reasonably safe from flooding
- **Estimate** Base Flood Elevations (BFEs) where not determined by FEMA
- **Require** new or substantially improved homes and manufactured homes to be elevated above the BFE
- **Require** other structures be flood proofed or elevated above the BFE
- **Determine** if flooded buildings are substantially damaged
- **Conduct** field inspections; cite and remedy building or code violations
- **Require** elevation surveys to document NFIP compliance
- **Review** requests for variances
- **Resolve** non-compliance issues and violations
- **Advise** FEMA and the state when updates to flood maps are needed
- **Maintain** records of all development within the Special Flood Hazard Area

For more information about the NFIP as it relates to local communities, visit FEMA's website at

www.fema.gov/information-state-local-officials.

Community Rating System (CRS)

The goals of the NFIP and the **Community Rating System (CRS)** are to provide flood insurance to property owners, to encourage flood loss reduction activities by communities, and to save taxpayers' money. As a part of NFIP, the CRS provides both incentives and tools to further these goals. Examples of actions your community can take to reduce the cost of your insurance premiums include:

- **Preserve** open space in the floodplain
- **Enforce** higher standards for safer development
- **Undertake** engineering studies and prepare flood maps
- **Obtain** grants to mitigate flooding to flood-prone structures through buyouts, structural elevation, and other flood damage reduction activities
- **Maintain** drainage systems
- **Implement** measures that protect life and property through flood warning and response programs
- **Educate** the public about flood hazards, flood insurance, and how to reduce flood damage

Community officials can request assistance from CRS specialists to help with eligibility requirements and the application process. Visit the online CRS Resource Center: www.fema.gov/national-flood-insurance-program-community-rating-system.

Property owners in 81 North Carolina local jurisdictions that qualify for the CRS receive flood premium discounts ranging from 5% to 25%. Four communities are among the highest-ranked in the nation: the cities of Charlotte and Kinston and the towns of Grifton and Topsail.

Be Prepared for Flood Emergencies

When disaster strikes, you may not have much time to act. Prepare now for a sudden emergency to protect yourself and your family from the next flood or other disaster.

Develop an **Emergency Preparedness Checklist** to help you get started.



- **Learn** your flood risk by contacting your community's engineering or planning office
- **Ask** how you would be warned of a flood emergency or other natural disaster
- **Learn** your community's evacuation routes and shelter locations if evacuated
- **Learn** about workplace and school emergency plans and create a family emergency plan
- **Put together** a disaster kit with supplies to last three days. Don't forget to include a copy of critical family records stored in a waterproof container

Additional Resources:

- To learn more about preparing for disasters, visit the North Carolina emergency preparedness website at readync.org/EN/Plan.html
- Flood hazard risk information can be found for individual buildings at fris.nc.gov/fris
- Other natural hazard information (for hazards such as earthquakes and wildfires) can be found at irisk.ncem.org/irisk/Home.aspx
- Flood warning information is provided at fiman.nc.gov/fiman

Turn Around Don't Drown™

Learn about flood risks and follow these safety rules:

- When flooding is expected, stay away from creeks, streams, and rivers
- NEVER drive through flooded roads—they may be washed out
- It takes less than 12 inches of flowing water to wash away a passenger car
- Be especially cautious at night when it is harder to determine flood depth and recognize dangers
- More than half of the deaths from flooding each year occur in vehicles

Visit tadd.weather.gov for more advice.



North Carolina's Flood Warning Program

FIMAN (Flood Inundation Mapping and Alert Network) is a sophisticated system of integrated datasets and tools with the ability to effectively communicate information to emergency managers and the public. FIMAN assembles a network over more than 550 stream gages. The image below shows the gages on the FIMAN web application.

Data collected from gage sensors is transmitted by radio or satellite, retrieved and processed by special software, and then stored in an enterprise GIS database. The FIMAN web application can be viewed on desktop, tablet and mobile devices to display real-time and forecasted flood information.

Gage readings are typically recorded and transmitted every 15 to 30 minutes. The goal of the FIMAN system is to reduce the loss of life and flood-related property damage by providing emergency managers and the public with timely, detailed, and accurate flood inundation information.

Flood warning information is provided for local community officials at fiman.nc.gov/fiman.

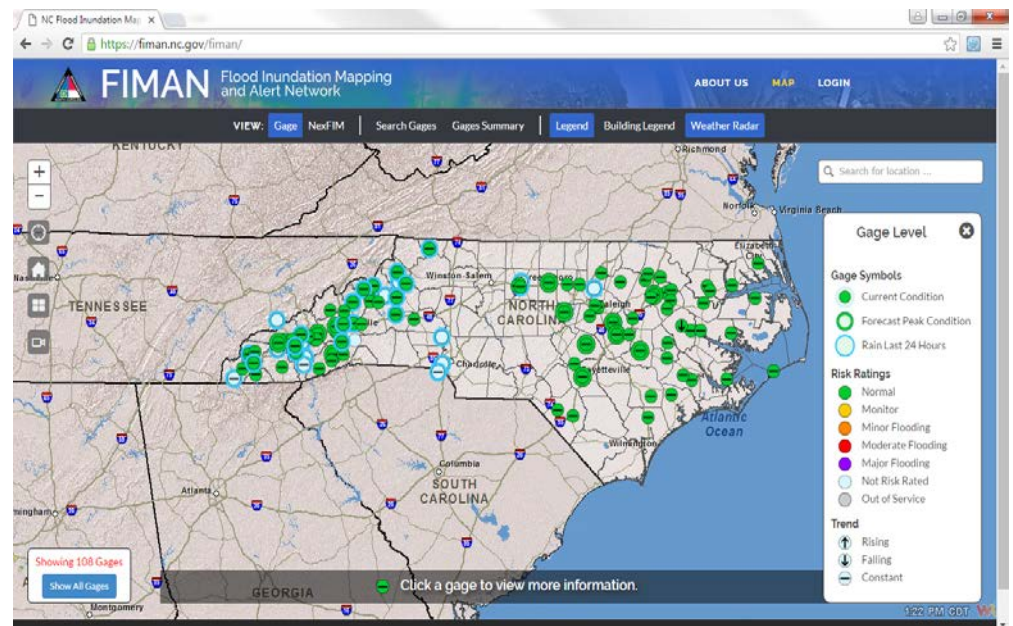

Flood Map Information

There are two locations where the general public can view flood maps and obtain flood map information:

- North Carolina's **The Flood Risk Information System (FRIS)** at fris.nc.gov/fris. FRIS contains digitally accessible flood hazard data, models, maps, risk assessments, and reports that are database driven. The website also provides geospatial base map data, imagery, LiDAR data, along with hydraulic and hydrologic models that are available for download. The State of North Carolina provides this website as a public service to the citizens of North Carolina.



- FEMA's **Flood Map Service Center (MSC)** at msc.fema.gov/portal. The MSC can also be reached at (877) 336-2627. Downloads of official flood maps and flood insurance studies, both effective and historic, are available. Historical flood map information is useful for various reasons, including determining the 100-year flood elevation used for permitting purposes by the local community on previous FEMA studies.

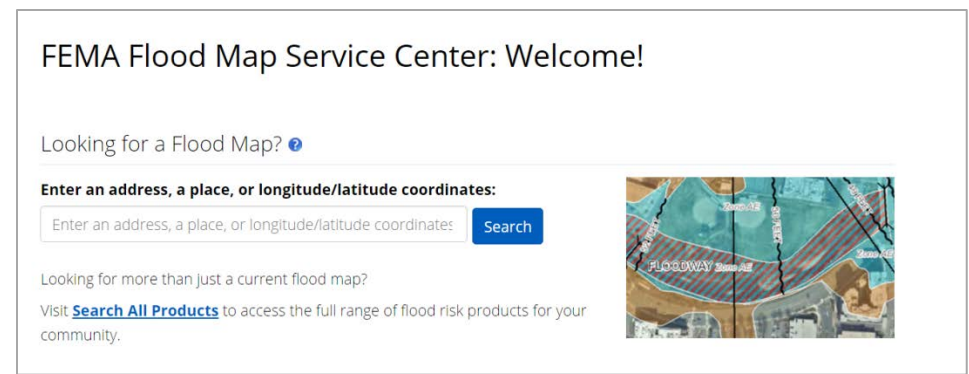

North Carolina Floodplain Mapping Program

In 1999, Hurricane Floyd flooded thousands of square miles of eastern North Carolina and left thousands of people homeless. This disaster highlighted our vulnerability to natural disasters and the need for accurate, up-to-date floodplain maps.

In 2000, the Federal Emergency Management Agency (FEMA) designated North Carolina a Cooperating Technical Partner State, formalizing an agreement between FEMA and the State to modernize flood maps. This partnership resulted in creation of the North Carolina Floodplain Mapping Program (NCFMP). As a CTS, the State assumed primary ownership and responsibility of the Flood Insurance Rate Maps (FIRMs) for all

North Carolina communities as part of the National Flood Insurance Program (NFIP). This project includes conducting flood hazard analyses and producing updated, Digital Flood Insurance Rate Maps (DFIRMs).

The NCFMP has made every effort to ensure the accuracy of this information. Contact information for the North Carolina Floodplain Mapping Program is available at www.ncfloodmaps.com or by phone at (919) 715-5711.

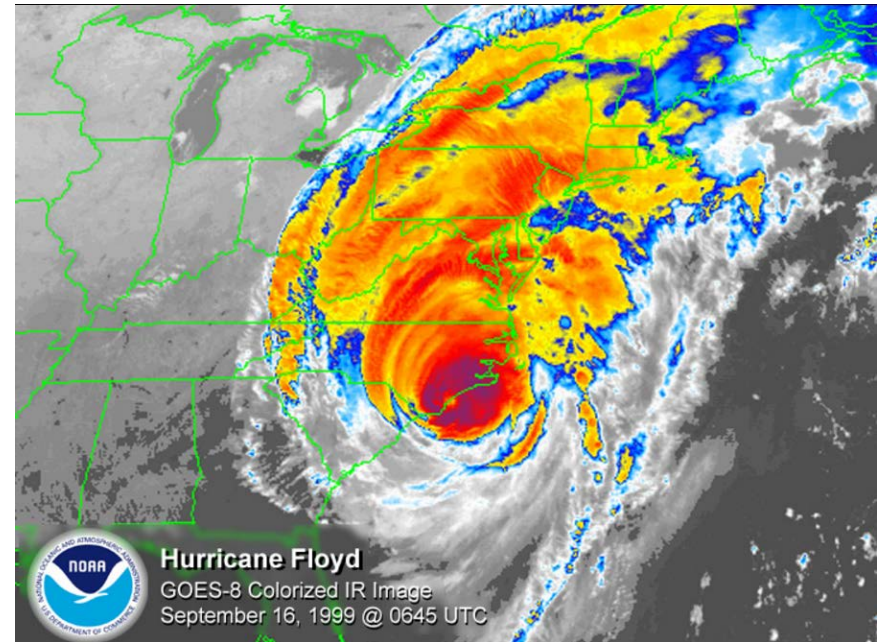

North Carolina Flood Risk Information System (FRIS)

In 2012, North Carolina enhanced the statewide Digital Flood Insurance Rate Map (DFIRM) database design to further support and enhance FEMA's Risk MAP initiative. The FRIS allows users to quickly assess their flood hazard vulnerabilities and consider mitigation options associated with known flood risk. More importantly, it communicates the overall risk communities may face and subsequent impacts. General FRIS data may be found at fris.nc.gov/fris. Some of the advanced features are listed below.

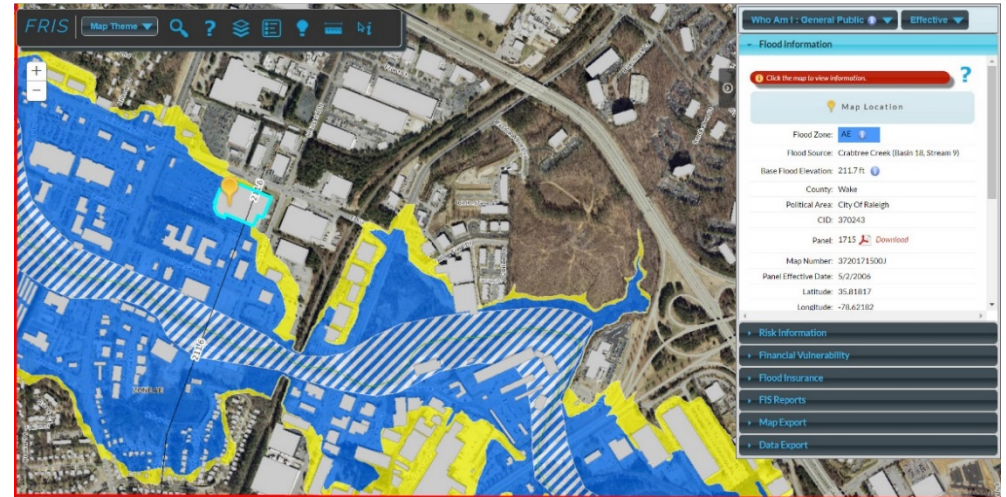

- **Point and click flood elevation determinations:** Enhanced 3D water surface layers provide for flood elevation determination with the click of a mouse. Flood elevations are available statewide for multiple flood return periods such as the 10-year, 50-year, and 500-year flood periods.
- **Print Flood Insurance Study (FIS) table and report data:** Users can zoom to an area of interest and print stream-specific FIS tables to support development and floodplain management decisions. The Flood Insurance Study report has been integrated digitally into the database for cost-effective distribution and maintenance. Users may also select specific sections of an FIS countywide report for download in PDF format.
- **Print effective flood maps:** Users can develop, print, and download regulatory or preliminary Flood Insurance Rate Maps using interactive online tools.
- **Flood loss and risk data:** The FRIS leverages statewide foundational datasets such as building footprints, parcel information, and first floor elevations to provide flood depth and damage estimates at the individual property owner level. Property owners and planners can adjust factors (such as value and square footage) to refine the loss estimates.
- **Technical data and downloads:** Geospatial and modeling data is available for instant download for advanced industry users. This includes hydrologic and hydraulic modeling data, GIS datasets, and Letters of Map Revisions (LOMRs). Other technical data, such as the flood geodatabase, has been designed to allow for efficient versioning of the digital flood layers using spatial datasets and the date. Visualization layers allow for display of both preliminary and effective flood hazard information.

North Carolina Flood Risk Information System (FRIS) , Continued

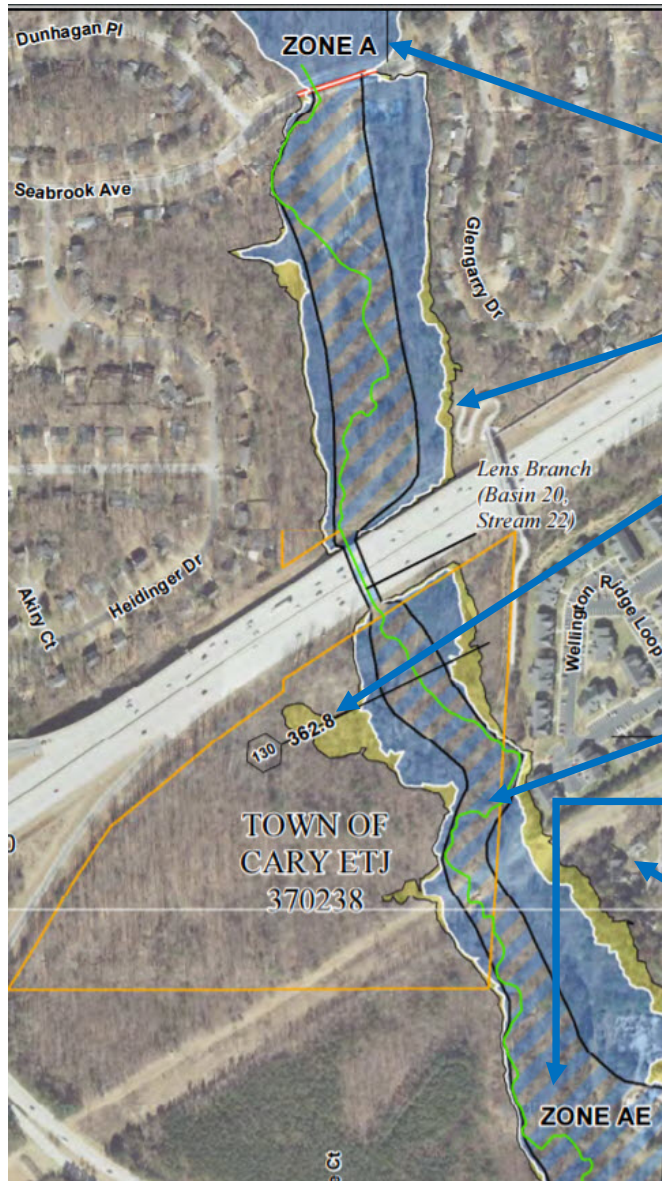

Zone A (unnumbered) is the flood hazard area without Base Flood Elevations (BFEs).

Shaded Zone X is the 0.2%-annual-chance (500-year) floodplain (formerly Zone B).

Base Flood Elevation (BFE) is the water surface elevation of the base flood at approximate locations (in feet above the vertical datum shown on the map).

Cross Section location ([see page 70](#)).

The **Floodway** is the hatched area.

Zone AE is the 1%-annual-chance (100-year) floodplain with BFEs (formerly Zones A1–A30).

Unshaded Zone X is all other areas considered low risk (formerly Zone C).

Nature Doesn't Read Flood Maps

Everyone lives in a flood zone, and everyone needs flood insurance. For persons living in a high-risk flood area, there is at least a one in four chance of flooding during a 30-year mortgage. Floods are the most common natural disaster in the United States, yet most homeowners' insurance does not cover flood damage. If you wait until a flood is on its way, it will be too late because there is generally a 30-day waiting period before a flood policy takes effect. Consider safety—protect your home or business by building higher.



Important

Information

Many people don't understand just how risky the floodplain can be. There is a 26% chance that a non-elevated home in the floodplain will be damaged during a 30-year mortgage period. The chance that a major fire will occur during the same period is less than 5%.

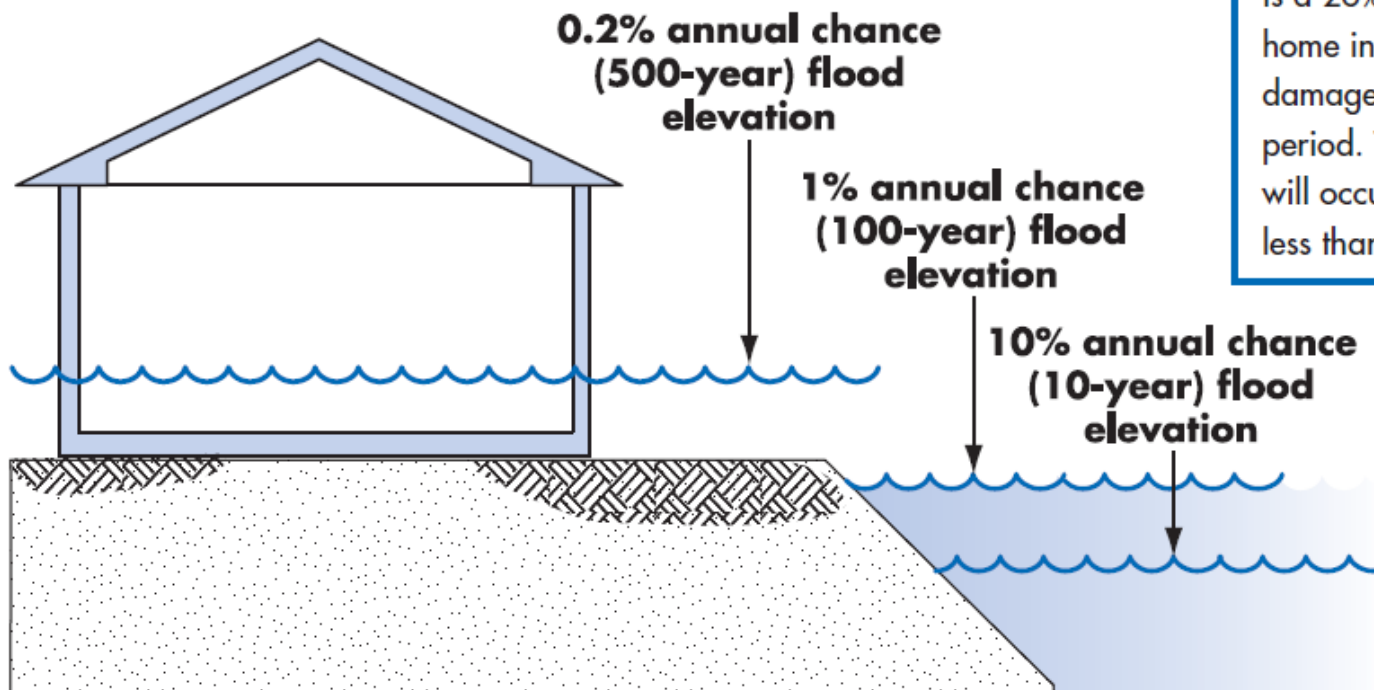

Old Format Flood Insurance Rate Map

The early paper versions of the Flood Insurance Rate Maps (FIRMs) contained shaded Special Flood Hazard Areas and Base Flood Elevations with a rough street layout.

FEMA also prepared Flood Boundary and Floodway Maps as companions to many "older version" FIRMs.

Floodway maps do not identify flood zones or BFEs. Check the companion FIRM for that information.

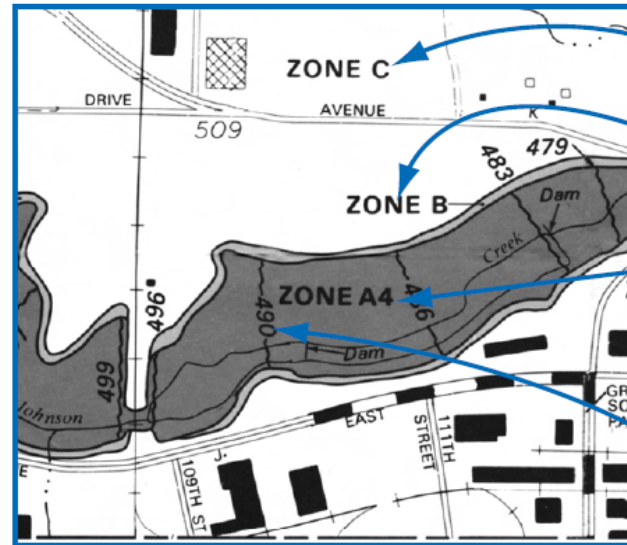

FLOOD HAZARD ZONES

- 1 **Zone C** (or Zone X) is all other areas, considered to be low-risk.
- 2 **Zone B** (or shaded Zone X) is subject to flooding by the 500-year flood (0.2% annual chance), and is a moderate risk area.
- 3 **Zone A, Zones A1-A30** and **Zone AE** are subject to flooding by the base or 100-year flood (1% annual chance), and are considered high-risk areas.
- 4 **Base Flood Elevation (BFE).** Water surface elevation of the base flood at specific locations.

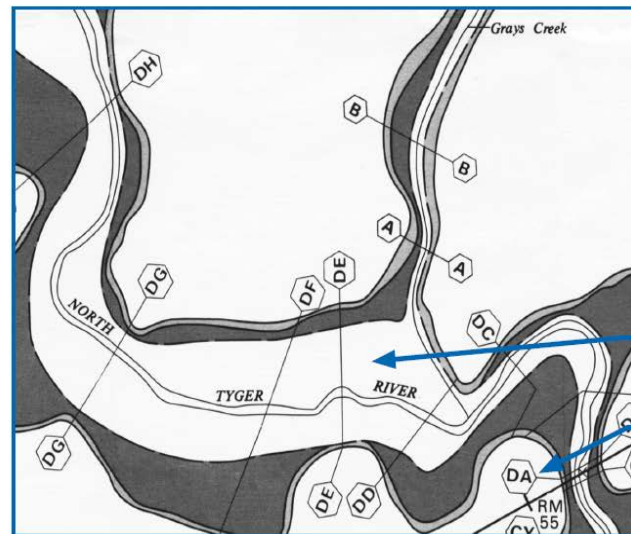

- 1 **The Floodway** is the unshaded area around the waterway centerline.
- 2 **Cross Section** location, where ground surveys determined the shape of the land and how constrictions such as bridges and culverts affect the flow of floodwater.

Future Conditions Floodplain Mapping

FEMA requires regulation of floodplain development based on existing-conditions data, while local communities may choose to regulate development based on future-conditions data. Future development will create more impervious cover, causing more runoff which will increase flood frequency and flood levels. Some communities ask for flood maps that show the future conditions floodplain determined by assuming the watershed is fully developed. If the flood map shows a shaded area that is labeled **Zone X (FUTURE)**, the area is the future conditions 1%-annual-chance (100-year) floodplain.

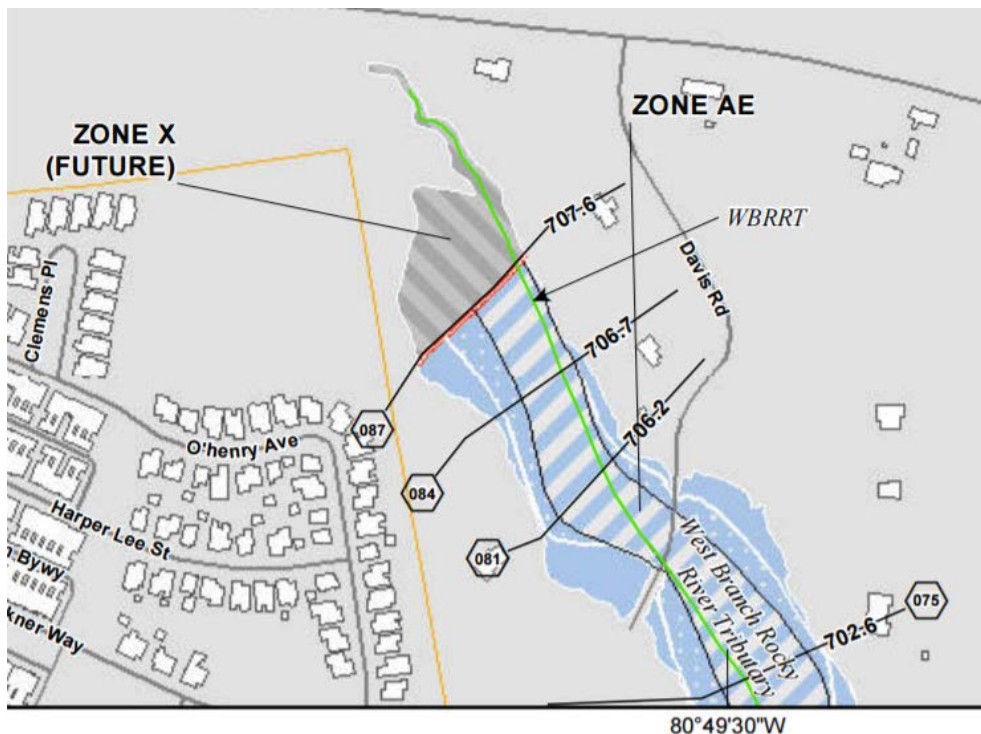

Flood insurance is not required for buildings in mapped Zone X (FUTURE) areas, but it is available.

The future conditions flood elevation may be a few feet higher than the current condition BFE shown on the FIRM.

Communities usually require new and substantially improved buildings in Zone AE and Zone X (FUTURE) areas to be elevated to or above the future conditions flood elevation. These buildings will continue to be protected as more development occurs and floods become more severe—and flood insurance will cost less.

Use the Riverine Flood Profile to Determine BFE

The FEMA Flood Insurance Study (FIS) is a report that contains detailed flood elevation data in flood profiles and data tables. FIS flood profiles provide detailed information about BFEs, stream bed locations, and cross section locations. Flood profiles are available on the [North Carolina FRIS site](#), where users can “point and click” anywhere in the flood hazard areas to obtain a BFE at any location.

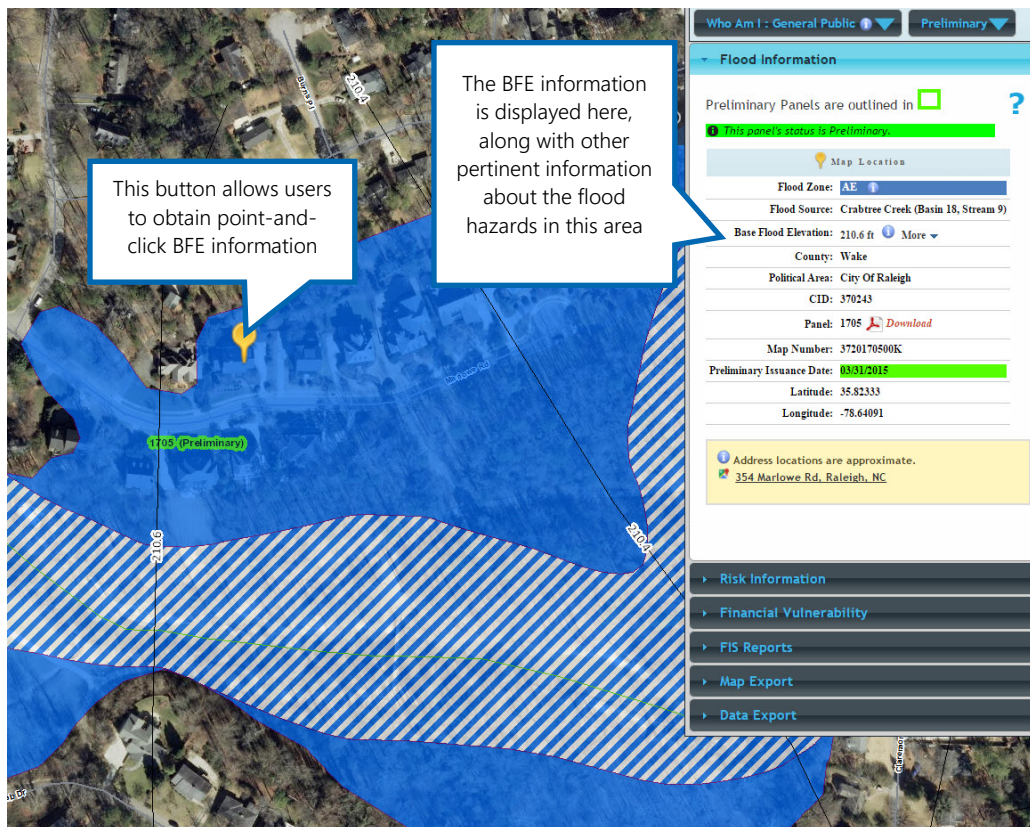

The BFE information is displayed here, along with other pertinent information about the flood hazards in this area

This button allows users to obtain point-and-click BFE information

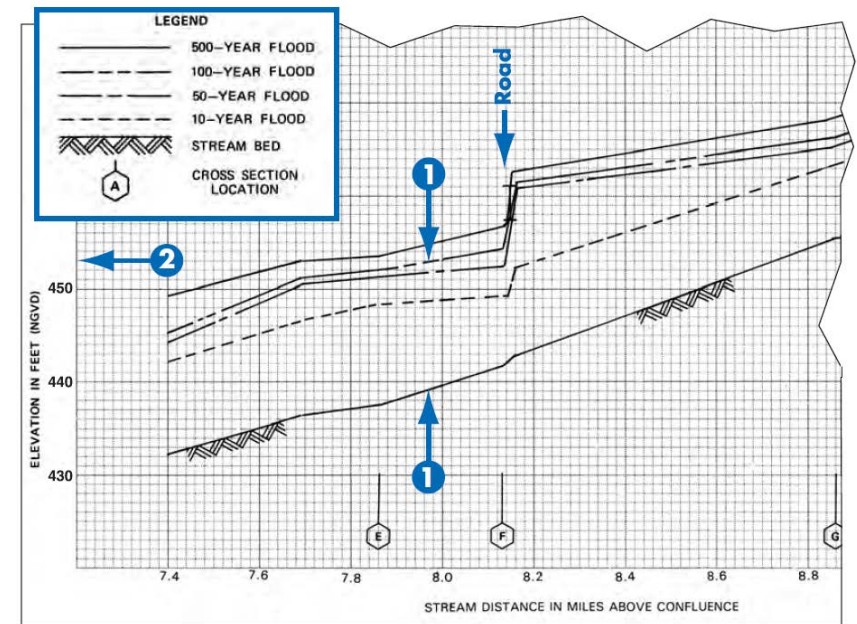

Flood profiles can be used to determine the BFE at a specific site. Profiles also show estimated water surface elevations for floods other than the 1% annual chance flood (100-year flood.)

- 1 On the effective flood map, locate your site by measuring the distance, along the center line of the stream channel, from a road or cross section, for example, E or F.
- 2 Scale that distance on the Flood Profile and read up to the profile of interest, then across to determine the elevation.

Approximate Flood Zones and Unnumbered A Zones

Some floodplains are delineated using approximate methods and therefore do not have specified Base Flood Elevations (BFEs). For assistance, contact your community's planning, engineering, or permit office, or the Floodplain Management Branch.

The FEMA publication **Managing Floodplain Development in Approximate Zone A Areas (FEMA 265)** is useful for engineers and community officials and is located here: www.fema.gov/media-library/assets/documents/1911.

Even if the estimated BFE indicates flooding might be only a foot or two deep, it is recommended that the lowest floor be at least two feet above the highest adjacent grade. Not only does this improve flood protection, but lower flood insurance premiums may apply.

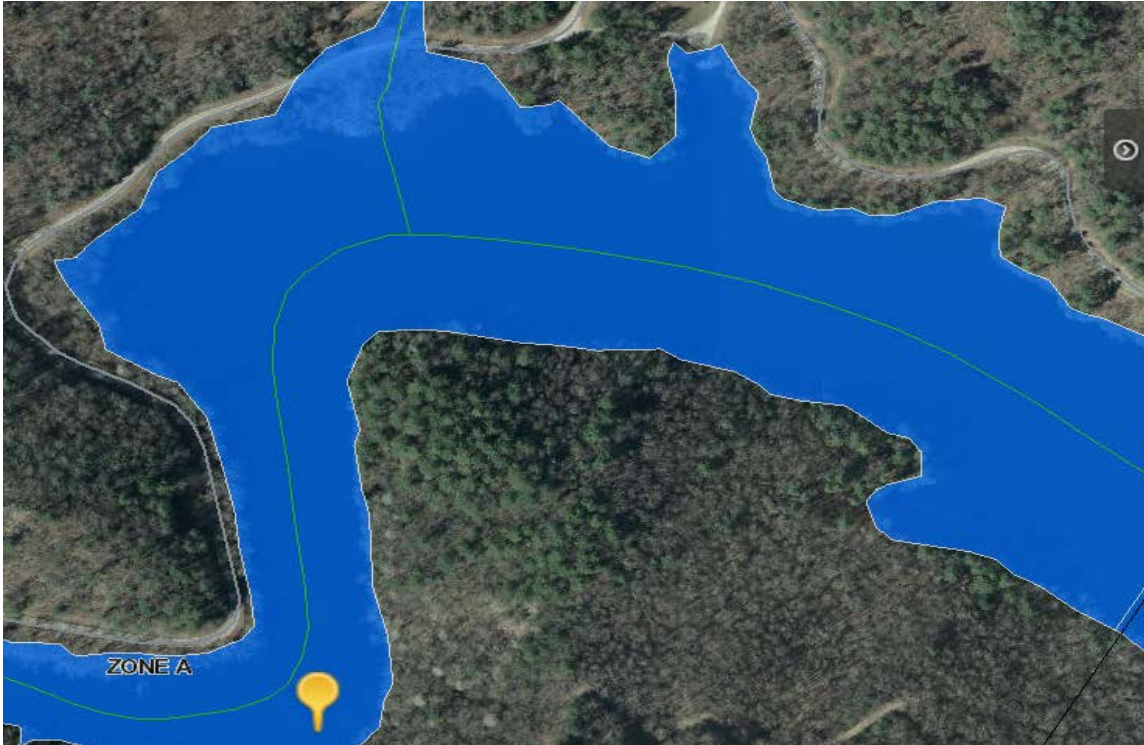

Who Am I : General Public | Effective

Flood Information

Click the map to view information.

Map Location

Flood Zone:	A
Flood Source:	Santeetlah Creek
Base Flood Elevation:	Not available for this area.
County:	Graham
Political Area:	Graham County
CID:	370105
Panel:	5632 Download
Map Number:	3700563200J
Panel Effective Date:	2/18/2009
Latitude:	35.36772
Longitude:	-83.90856

Address locations are approximate.
4960 Joyce Kilmer Rd, Robbinsville, NC

AE Flood Zones With Non-Encroachment Areas

Most riverine flooding sources that are shown on older North Carolina FIRMs with **Approximate A Zones** or **Unnumbered A Zones** (estimated high-risk areas with no detailed study) have been studied by the Limited Detailed Study method and remapped as AE Zones with BFEs on the new North Carolina DFIRMs. This method determines a Non-Encroachment Area (NEA) (not shown on the maps) which serves the same function as a floodway.

The Limited Detailed Flood Hazard Data tables in the Flood Insurance Study report list BFE data and non-encroachment area widths at all flood study cross sections.

If your property is near a river or stream and is mapped as an AE Zone without a floodway, check with your community's planning, engineering, or permit office to see if your project is within a **Non-Encroachment Area**.

Non-Encroachment Area (NEA) is the portion of the floodplain where proposed construction, placement of fill, or similar alterations of topography require a "No-rise/No-Impact" Certification due to the potential adverse effects development would have on conveyance of the base flood.

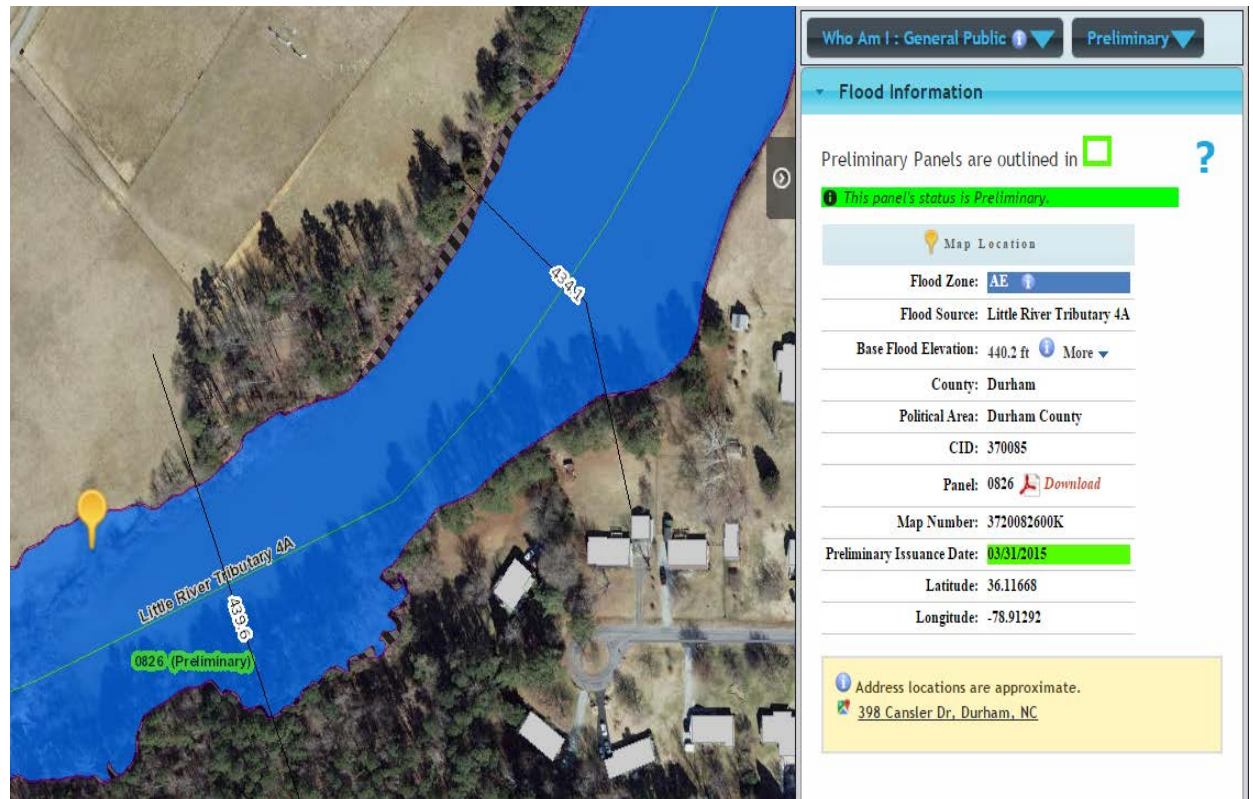

Limited Detailed Study

Limited Detailed Study (LDS) is the term given to a method of calculating Base Flood Elevations using cross section information from available topography (with limited or no surveyed field data). Limited Detailed Studies are performed to improve flood hazard information in areas that were originally mapped as Approximate A Zones (without BFEs) or were not previously studied.

Waterways for which the Limited Detailed Study method is used have BFEs, SFHA boundaries, and cross sections shown on the FIRM. Floodways are not shown on the FIRM, and flood profiles are not provided in the Flood Insurance Study report. BFEs and other data are listed in the Limited Detailed Flood Hazard Data table in the FIS report.

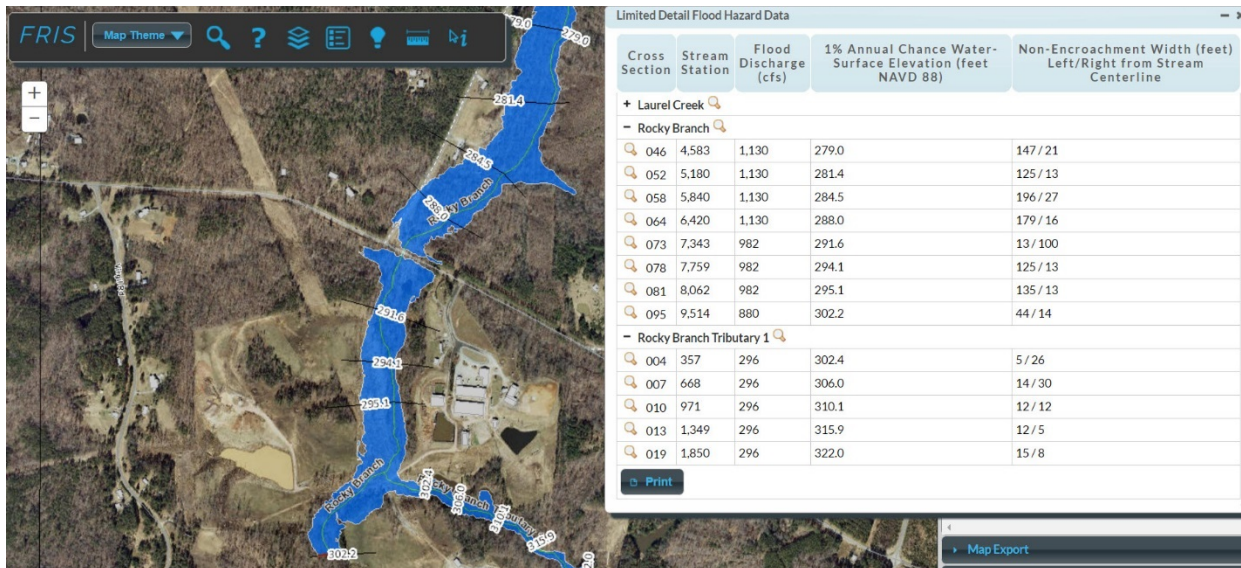

Floodways are not shown when the LDS method is used. When the FIRM shows BFEs but not floodways, NFIP regulations require communities to ensure that no new construction, substantial improvement, or other development (including fill), is permitted “unless it is demonstrated that the cumulative effect of the proposed development, when combined with all other existing and anticipated development, will not increase the water surface elevation of the base flood more than one foot at any point.”

To avoid requiring analyses for every development proposal, the North Carolina LDS method determines a “non-encroachment area” which communities adopt and then regulate similar to a floodway.

Using Data from Limited Detailed Studies

Streams studied using the Limited Detailed Study method do not have a flood profile in the FIS report. Use the Limited Detailed Flood Hazard Data table in the FIS and follow these steps to determine BFEs and non-encroachment widths at a specific location:

1. On the FIRM, find the upstream and downstream cross sections closest to the site.
2. Follow the stream centerline and measure the distance from the site to the nearest cross section.
3. In the table, find the 1% Annual Chance Water Surface Elevation values for both cross sections.
4. Numerically interpolate to find the BFE at the site (see instructions online at www.ncfloodmaps.com/pubdocs/limited_detailed.pdf).
5. Find the Non-Encroachment Widths for both cross sections. Use the wider value measured from the center of the stream or numerically interpolate to find the value at the site.

Limited Detailed Flood Hazard Data (partial)

Cross Section	Stream Section	Flood Discharge (cfs)	1% Annual Chance Water Surface Elevation (feet NAVD 88)	Non-Encroachment Width (feet)*
FISHER BRANCH				
120	12,043	1,572	711.7	74 / 35
126	12,567	1,572	715.4	35 / 68
130	12,996	1,429	718.1	42 / 34
134	13,427	1,429	721.2	34 / 71

* Left/Right distance from the mapped center of stream to non-encroachment boundary based on a 1.0 foot or less surcharge (looking downstream)

Levee Certification for FEMA Flood Maps

Levees are designed to protect land against flooding. In order for FEMA to show this land as outside of the Special Flood Hazard Area (protected from flooding), communities and levee owners must certify that levees meet required criteria. Certification presents significant challenges during the map revision process.

Communities that have levees should determine as soon as possible whether certification will be required and feasible.

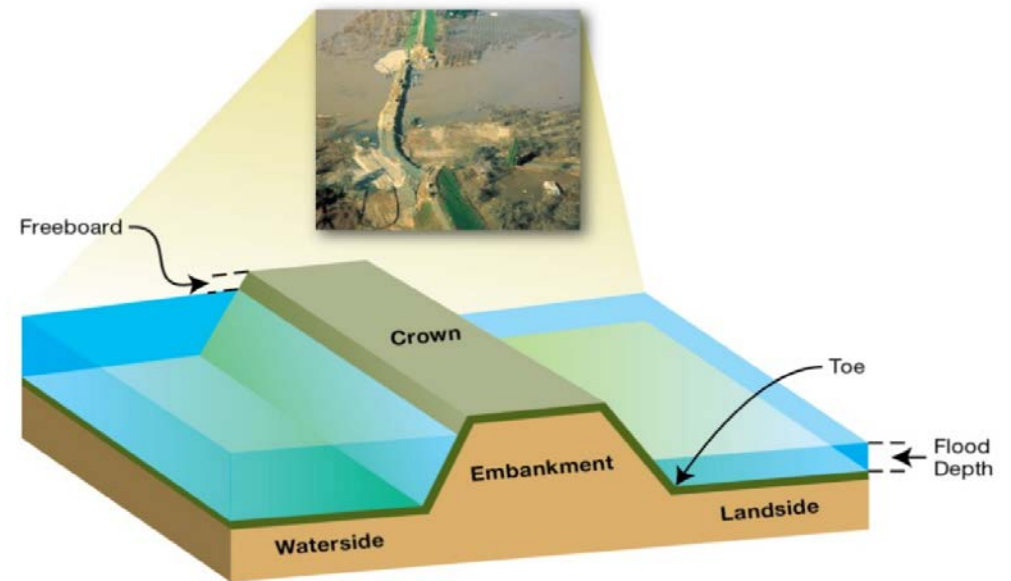

For individual property owners in areas where floodwaters aren't expected to be deep, small levees and floodwalls can be helpful in protecting structures against flooding, especially older Pre-FIRM structures. A permit is required for those protection measures, and extra care must be taken if the site is in a floodway. A levee or floodwall cannot be used to comply with floodplain regulations for a new or substantially improved residential buildings, or ones that are repaired after substantial damage. **Note:** These protective measures will not reduce flood insurance premiums.

The following references provide additional information about levees and levee protection for properties:

- Federal Regulations at 44 CFR Section 65.10: www.gpo.gov/fdsys/granule/CFR-2011-title44-vol1/CFR-2011-title44-vol1-sec65-10
- Other FEMA Fact Sheets: www.floodsmart.gov/toolkits/flood/downloads/LivingBehindLevees-OT2007.pdf and www.fema.gov/living-levees-its-shared-responsibility
- FEMA's Engineering and Mapping guidance: www.fema.gov/final-levee-analysis-and-mapping-approach

Letter of Map Change (LOMC) Information

There are multiple sets of forms available on the FEMA website to assist in the request for a Letter of Map Change (LOMC). These forms can be found at www.fema.gov/flood-mapping-related-forms.

- **MT-EZ form:** This form should be used to request that FEMA remove a single structure or a legally recorded parcel of land or portions thereof, described by metes and bounds certified by a Registered Professional Engineer or Licensed Land Surveyor, from a designated Special Flood Hazard Area (SFHA) via Letter of Map Amendment (LOMA)
- **MT-1 form:** This form should be used to assist requesters (community officials, individual property owners, and others) in gathering the information that FEMA needs to determine whether property (structure(s), parcel(s) of land) is likely to be flooded during the flood event that has a 1% chance of being equaled or exceeded in any given year (base or 100-year flood). Lands that are at risk of being inundated by the base flood are designated as SFHAs. The forms in this package may be used for property that has been inadvertently included in a V zone or the regulatory floodway. However, if the property is to be removed from a V zone, it must not be located seaward of the landward toe of the primary frontal dune.
- **MT-2 form:** This form should be used for revisions to effective Flood Insurance Study reports, Flood Insurance Rate Maps or Flood Boundary and Floodway Maps by individual and community requesters. These forms will provide FEMA with assurance that all pertinent data relating to the revision are included in the submittal. They also will ensure that: (a) the data and methodology are based on current conditions; (b) qualified professionals have assembled data and performed all necessary computations, and (c) all individuals and organizations affected by proposed changes are aware of the changes and will have an opportunity to comment on them.



More information about LOMCs and an Online LOMC application are available on FEMA's website: www.fema.gov/change-flood-zone-designation-online-letter-map-change.

Pre-FIRM and Post-FIRM Structures

A building is **Pre-FIRM** if it was built before the date of your community's first FIRM, and before many communities adopted elevation requirements in high-risk flood areas. If built or substantially improved after that date, a building is **Post-FIRM**. **Substantial improvement** is any reconstruction, rehabilitation, addition, or other improvement of a structure, the cost of which equals or exceeds 50% of the market value of the structure before the "start of construction" of the improvement. Find the initial FIRM date for your community online at www.fema.gov or call your community's planning, engineering, or permit office.

Permits are required for improvements or repairs to Pre-FIRM buildings, which may have to be elevated to the current BFE and flood zone requirements.

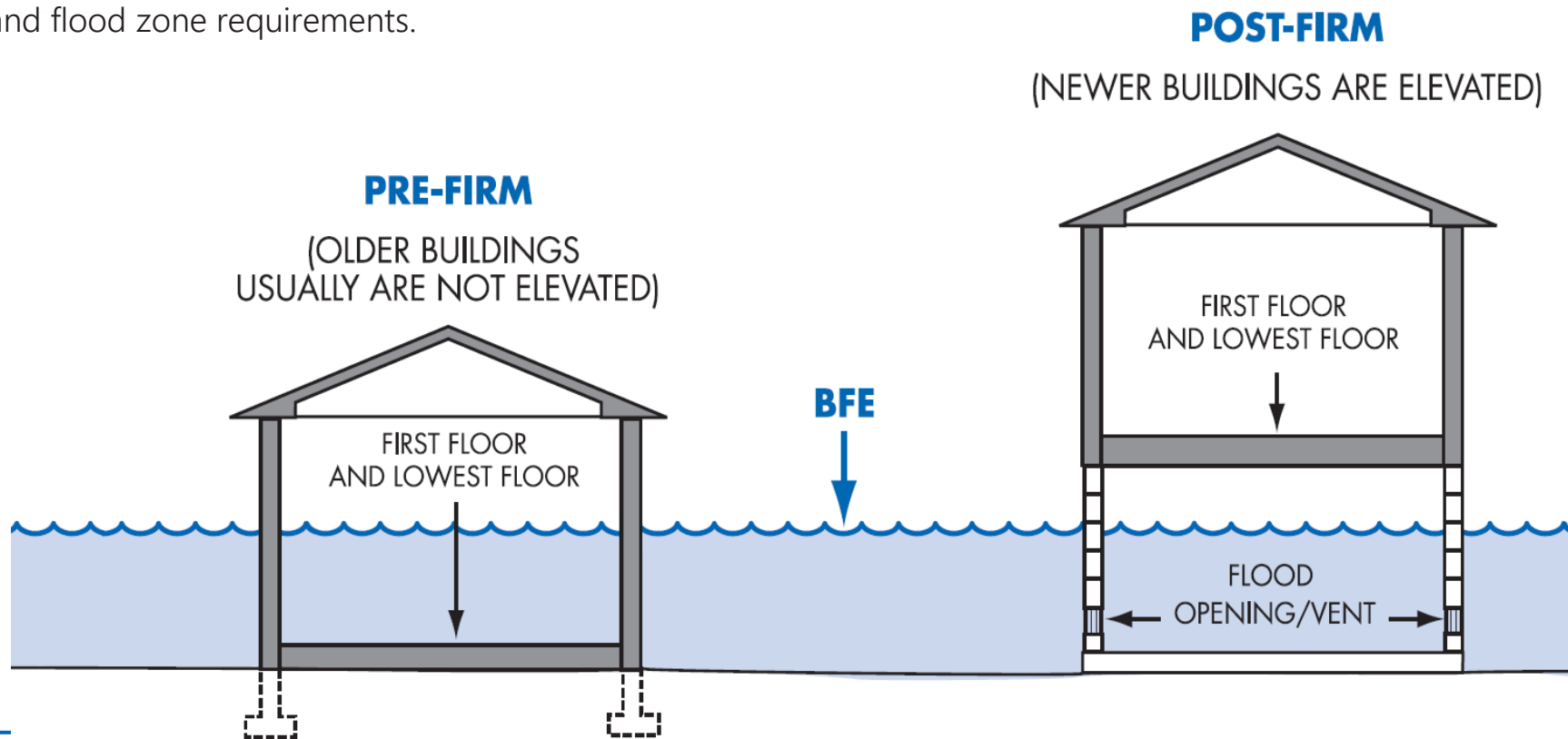

Flood Map Revisions Processed by FEMA

LOMCs are documents issued by FEMA that revise or amend the flood hazard information shown on the FIRM without requiring the FIRM to be physically revised and re-published. **Letters of Map Revision (LOMRs)**, **Letters of Map Revision Based on Fill (LOMR-Fs)** and **Letters of Map Amendment (LOMAs)** are all forms of LOMCs that are issued for a property, or properties, on the revised FIRM panel.

The most accurate information available is used to make flood maps, including topographic base maps and detailed engineering methods or methods of approximation. Map revisions are issued when technical data is submitted to support the changes. Map changes are processed either directly through FEMA or by the State of North Carolina on behalf of FEMA, depending on the type of map change. Map changes processed through FEMA include LOMAs and LOMR-Fs described below:

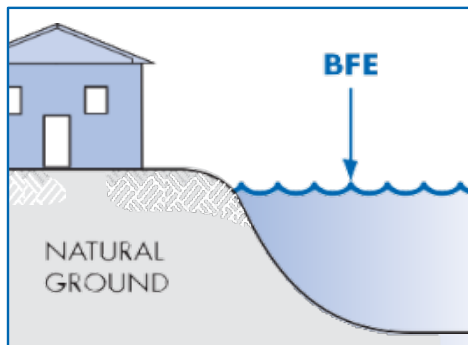

Letter of Map Amendment (LOMA) is an official amendment to an effective FIRM that may be issued when a property owner provides additional technical information from a professional land surveyor or civil engineer, such as ground elevation relative to the BFE. Lenders may waive the flood insurance requirement if the LOMA removes a building site from the SFHA because natural ground at the site is at or above BFE.

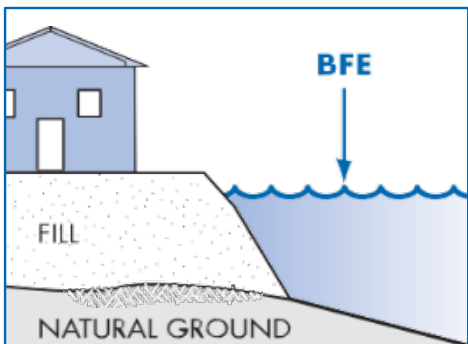

Letter of Map Revision Based on Fill (LOMR-F) is an official revision to an effective FIRM that is issued to document FEMA's determination that a structure or parcel of land has been elevated by fill above the BFE, and therefore is no longer in the SFHA. Lenders may waive the insurance requirement if the LOMR-F removes a building site from the SFHA.

Flood Map Revisions Processed by North Carolina

In July 2006, the State of North Carolina assumed responsibility from FEMA for reviewing requests for Conditional Letters of Map Revision (CLOMRs) and Letters of Map Revision (LOMRs). Initiated as a one-year pilot project, FEMA has continued to delegate MT-2 LOMC processing to the State of North Carolina.

- **Conditional Letter of Map Revision (CLOMR)** is a letter commenting on whether a proposed project, if built as shown on the submitted documentation, would meet the standards for a map revision. Communities may require this evidence prior to issuing a permit, and the Certificate of Occupancy/Compliance should be withheld until receipt of the final LOMR based on “as-built” documentation and certification.
- **Letter of Map Revision (LOMR)** is an official revision to an effective FIRM that may be issued to change flood insurance risk zones, SFHAs and floodway boundary delineations, BFEs, and other map features. Lenders may waive the insurance requirement if the approved map revision shows buildings to be outside of the SFHA.

The North Carolina Floodplain Mapping Program (NCFMP) coordinates the review and issuance of CLOMRs and LOMRs. Program staff are available to discuss potential projects prior to submittal of an LOMC application. Applicants and communities can contact the NCFMP for assistance throughout the process.

Go to www.ncfloodmaps.com/mt-2_forms.htm for instructions on how to submit a CLOMR or LOMR application for a proposed project in North Carolina.

Community Flood Map Changes

The following are examples of how FEMA flood map changes affect flood insurance and applicable requirements, options, and savings (other situations not reflected here may affect your flood premium).

To obtain a flood insurance quote for your property, contact your property insurance agent. To find an insurance agent near you, call the NFIP's toll-free number at (888) 356-6329 or visit www.FloodSmart.gov.

EXAMPLE 1:

If maps show change from moderate-to-low flood risk (Flood Zones B, C, or X) to high risk (Zones A, AE, AH, AO, V, or VE): **Flood insurance is mandatory.**

Flood insurance is federally required for most mortgage holders. Insurance costs may rise to reflect the true (or high) risk. The **Newly Mapped Procedure** can offer savings under the Preferred Risk Policy (PRP). A **Preferred Risk Policy** (PRP) offers multiple coverage combinations for both buildings and contents (contents-only coverage is available for renters) that are in moderate- to low-risk areas (B, C, and X Zones). PRPs are available for residential or non-residential buildings also located in these zones, and that meet eligibility requirements based on the building's entire flood loss history. The Newly Mapped Procedure allows policyholders lower-cost PRP rates for the first 12 months after new maps go into effect. After the first year, the rate begins its transition to a full-risk rate with annual rate increases of no more than 18% each year.

Policyholders not eligible for the Newly Mapped Procedure may still benefit from the NFIP's **Grandfathering Rule**. Eligible policyholders can keep their prior Flood Zone or Base Flood Elevation for rating purposes after maps change. Grandfathering applies if the structure was built in compliance with an earlier (or older version) flood map or the policyholder has maintained continuous flood coverage.

Community Flood Map Changes, Continued

EXAMPLE 2:

If maps change from high flood risk (Flood Zones A, AE, AH, AO, V, or VE) to moderate-to-low risk (Zone X or Shaded X): **Flood insurance is optional but still recommended. The risk is only reduced, *not* removed.**

You can still obtain flood insurance, and at a lower rate. Even though flood insurance isn't federally required in this example, everyone is financially vulnerable to floods. In fact, people outside of mapped high-risk flood areas file more than 20% of all NFIP flood insurance claims and receive one-third of federal disaster assistance for flooding.

Your insurance agent can easily convert an existing policy to a lower-cost PRP if the building qualifies. Note that lenders always have the option to require flood insurance in these areas.

EXAMPLE 3:

If maps change from high flood risk (Flood Zones A or AE) to higher flood risk (Zones V or VE or there is an increase in the Base Flood Elevation (BFE) with no change in risk level: **No change in insurance rates.**

However, this is a good time to review your flood coverage and ensure that your building and contents are adequately protected.

For further information and to learn more about flood insurance rating and ways to save, click on the terms below:

- [Newly Mapped Procedure](#)
- [Grandfather Rule](#)
- [Conversion](#)

What are FEMA Risk MAP Products?

Flood Risk Products go beyond the basic flood hazard information. Flood Risk Products provide a deeper and user-friendly analysis of flood risks within a community.

Flood Risk Products help community members and officials view and visualize their local flood risk, allowing communities to make informed decisions about reducing flood loss and mitigating potential damage from flood hazards. These individuals may include property owners, emergency management officials, community planners and developers, real estate and insurance specialists, and other professionals and community decision-makers. The following is a list of these products:



- **Flood Risk Map (FRM):** The FRM depicts flood risk data for a flood risk project area and is typically used to illustrate overall flood risk for the area. The content and format of individual FRMs may vary among project areas to best represent the local conditions. Typical maps might show the potential flood losses associated with the 1%-annual-chance flood event for each census block, areas planned for new or revised maps, key watershed features that affect local flood risk, and information about potential or successful past projects to reduce flood risk.
- **Flood Risk Report (FRR):** The FRR provides community- and watershed-specific flood risk information extracted from the Flood Risk Database (FRD), explains the concept of flood risk, and identifies useful tools and reference materials. The FRR, used in combination with the Flood Risk Map (FRM), is a good tool for communities to use for raising local flood risk awareness.

- **Flood Risk Database (FRD):** The FRD stores all flood risk data for a flood risk project, including the information shown in the Flood Risk Report (FRR) and on the Flood Risk Map (FRM). The FRD provides a wealth of data that may be used to analyze, communicate, and visualize flood risk on an ad hoc basis for a variety of uses. Communities are encouraged to use this database to support mitigation efforts and raise awareness. Data in the FRD represents a snapshot in time. Data is not updated regularly once the final FRD is posted to the FEMA Flood Map Service Center. Elements in the FRD can include:
 - **Changes Since Last FIRM** shows where the Special Flood Hazard Area (SFHA) has changed since the last effective Flood Insurance Rate Map (FIRM).
 - **Areas of Mitigation Interest** communicates where conditions have contributed to the severity of flooding losses, allowing for better prioritization of flood mitigation efforts and use of funds.
 - **Flood Depth and Analysis Grids** communicate the depth and velocity of floodwaters as well as the probability of an area being flooded over time.
 - **Flood Risk Assessment Data** provides an assessment of potential financial consequences and other impacts associated with structures located in an SFHA. This data also enables communities to make informed decisions regarding future land development and community infrastructure.
 - In addition to these standard flood risk datasets, the **Flood Risk Database** may contain custom flood risk datasets created for the specific project area or even risk datasets related to other hazards. Geographic Information System (GIS) software and specialized skills are required to view the FRD and the associated elements.

For more information on FEMA Risk MAP products, go to www.fema.gov/risk-map-flood-risk-products#.

Building Sites Higher Than the BFE

Because of limitations of scale or topographic definition of the source maps used to prepare a FIRM, small areas may be inadvertently shown within an SFHA on a FIRM even though the structure and natural ground is at or above the elevation of the 1%-annual-chance flood and therefore shown on the FEMA flood map as being “in” the SFHA.

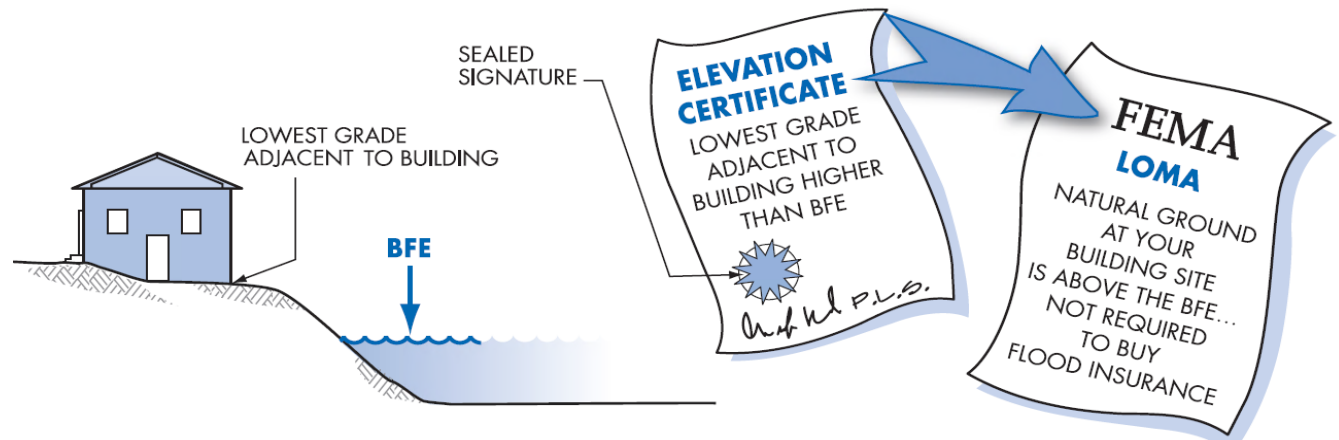

Recognizing that these situations do occur, FEMA established administrative procedures to change the designation for these properties on the FIRM. If a property owner thinks their property has been inadvertently mapped in a Special Flood Hazard Area, they may submit a request to FEMA for a Letter of Map Amendment (LOMA). This requires hiring a professional land surveyor or civil engineer to complete a FEMA Elevation Certificate (EC). Submit a request for a Letter of Map Amendment to FEMA along with the EC to verify that your structure is above the BFE. If FEMA approves your request, the mandatory federal requirement to purchase flood insurance could be removed. Keep the certificate and the LOMA with your deed since this information relates to the property and may be transferred to future buyers.

Keep in mind that it is the lender’s prerogative to require flood insurance even if FEMA grants a LOMA. Check with your lender first before applying for a LOMA to remove the flood insurance requirement.

Activities in SFHAs That Require Local Permits and Approvals

The following development activities require a Floodplain Development Permit. The Code of Federal Regulations defines “development” as any man-made change to improved or unimproved real estate, including but not limited to dredging, filling, grading, paving, excavation, or drilling operations or storage of equipment or materials. Keep in mind that your local community may have additional situations that stipulate the need for a Floodplain Development Permit.

- **Construction** of new buildings
- **Additions** to existing buildings
- **Improvements** of existing buildings
- **Renovation** of existing building (interior or exterior)
- **Repair** of damaged buildings
- **Placement** of manufactured (mobile) homes
- **Subdivision** of land
- **Construction** or placement of temporary buildings and accessory structures
- **Construction** of agricultural buildings
- **Construction** of roads, bridges, and culverts
- **Placement** of fill, grading, excavation, mining, and dredging
- **Alteration** of stream channels
- **Drilling** (oil and gas)



Some Key Floodplain Development Permit Review Steps

The permit reviewer has to check many things. Some of the key questions are:

- Is the site near a watercourse?
- Is the site in the mapped FEMA floodplain or floodway?
- Have other state and federal permits been obtained?
- Is the site reasonably safe from flooding?
- Does the site plan show the flood zone, Base Flood Elevation, and building location?
- Is substantial improvement of an older building proposed?
- Is an addition proposed?
- Will new buildings and utilities be elevated properly?
- Will manufactured homes be properly elevated and anchored?
- Do the plans show an appropriate and safe foundation?
- Will the owner/builder have to submit an as-built Elevation Certificate?



Applying for a Floodplain Development Permit

Your local community's Floodplain Development permitting process will include a comprehensive review of the proposed development addressing the following topics:

- Is the site in the mapped FEMA floodplain or floodway?
- Will fill material be placed on the site?
- Have other state and federal permits been obtained?
- Is the site reasonably safe from flooding?
- Does the site plan show the flood zone, Base Flood Elevation, natural ground elevations, and proposed building location?
- Is substantial improvement of an older building proposed?
- Is an addition proposed?
- Will new buildings and utilities be elevated properly?
- Will manufactured homes be properly elevated and anchored?
- Do the plans show an appropriate and safe foundation?
- Will an Elevation Certificate be required?

Part of a Sample Application
(may vary by community)

Owner's Name: DAVID & SALLY JONES
Site Address, Tax #, Parcel #: 701 REED STREET, 400-55A-002

A. Description of Work

1. Proposed Development Description:
 New Construction Dredging
 Alteration or Repair Manufactured/Modular
 Filling Logging
 Grading Other

2. Size and Location of Development
SINGLE FAMILY (2,000 CY FILL);
FLOOD FRINGE OF OAK CREEK

3. Type of Construction
 New Residential Improvement
 New Non-Residential Renovation
 Addition Accessory structure
 Temporary

Applicant's Signature: David M. Jones

Community, Map, and Elevation Data:

1. Community No: 570171
2. Panel No: 5720512700
3. Zone: AE
4. Base Flood Elevation: 59.2
5. Required Lowest Floor Elevation (including basement): 60.2
6. If floodproofed, required floodproofing elevation: N/A
7. Elevation to which all attendant utilities, including all heating, duct work, and electrical equipment will be installed or floodproofed: 60.2

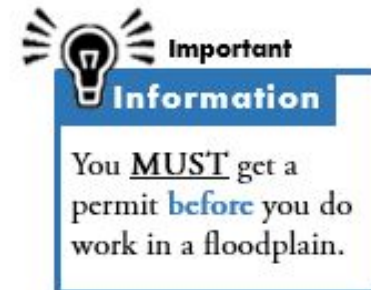

Safer Uses of the Floodplain

Let the floodplain perform its natural function—if possible, keep it as open space. Other compatible uses: recreational areas, playgrounds, reforestation, parking, gardens, pasture, and created wetlands. One resource that is very helpful on this topic is Subdivision Design in Flood Hazard Areas (FEMA/APA Planning Advisory Service Report Number 473), which can be found here: www.planning.org/publications/report/9026823.

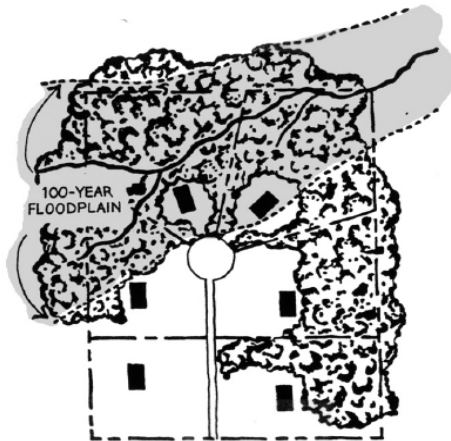

All land subdivided into lots, some homesites and lots partially or entirely in the floodplain.

NOT RECOMMENDED

All land subdivided into lots, some lots partially in the floodplain, setbacks modified to keep homesites on high ground.

RECOMMENDED

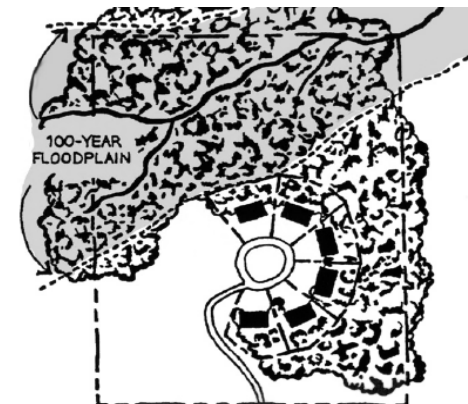
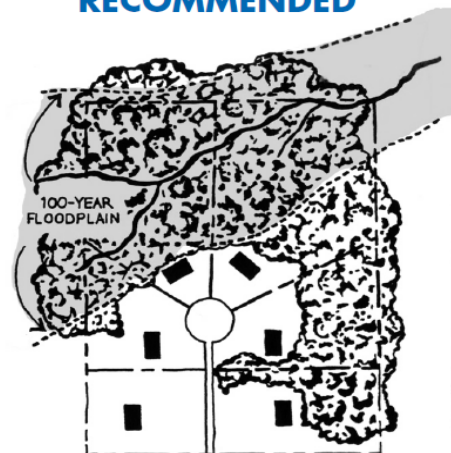

Floodplain land put into public/common open space, net density remains, lot sizes reduced and setbacks modified to keep homesites on high ground.

RECOMMENDED

Think Carefully Before You Seek a Floodplain Variance

Very specific conditions related to the property (not the owner's actions or preferences) must be satisfied to justify a local community granting a **floodplain variance**, such as:

- Good and sufficient cause
- Unique site conditions
- Non-economic hardship
- If in the floodway, no increase in flood level

A floodplain variance allows construction in a high-risk flood area built below the BFE without being elevated. It does **not** waive a lender's flood insurance requirement.

Even if a variance is granted by a local community, flood insurance will be **very** expensive—perhaps more than \$5,000 in annual premiums. Not only will flood insurance be cost prohibitive, but the structure would not be eligible for a federally backed mortgage and may be difficult to sell in the secondary market.

(See **Freeboard**, below.)

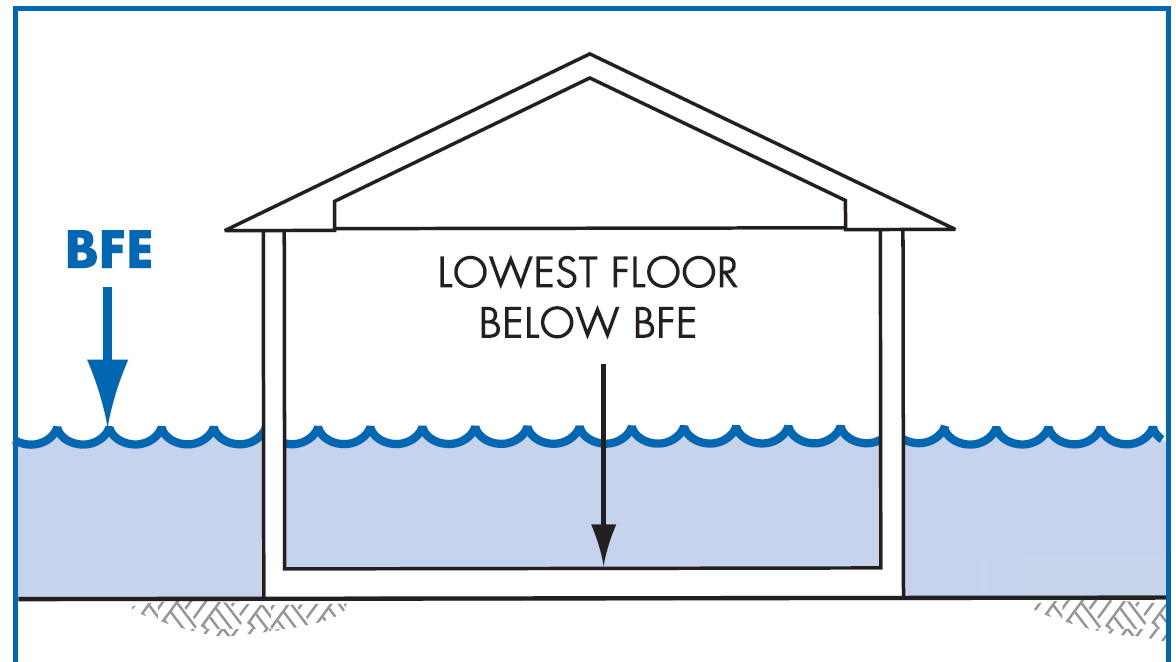

Freeboard: Build Higher, Reduce Damage, Save on Insurance

Freeboard is a factor of safety when constructing a building in the Special Flood Hazard Area (SFHA), usually one, two, or even three feet above the Base Flood Elevation (BFE). Building higher than local NFIP requirements provides peace of mind and can save money. Freeboard can compensate for the many unknown factors that could contribute to flood heights greater than the BFE.

Annual Flood Insurance Cost	
If you have:	
<input checked="" type="checkbox"/>	a post-FIRM structure
<input checked="" type="checkbox"/>	in an AE Zone
<input checked="" type="checkbox"/>	with \$250,000 structural coverage (maximum)
<input checked="" type="checkbox"/>	with \$100,000 contents (maximum)
The approximate annual cost for flood insurance:	
+3 ft.	\$500
+2 ft.	\$550
+1 ft.	\$700
BFE	\$1,100
-1 ft.	\$5,000
-2 ft.	expensive (submit for rate)

NOTE: This is hypothetical and flood insurance premiums change yearly. For specific rate information contact a licensed insurance agent.



NOTE: Flood insurance rates and various fees change from time to time. Rather than specific costs for insurance, this figure gives a feel for how much difference just a foot or two can make.

Building owners will save insurance money if they elevate above the BFE. More dramatically, the cost of insurance can more than double if the building is only foot below the BFE.

Remember: The community may be able to grant a variance, but the owner will probably still be required to buy insurance. Imagine trying to sell a house if the bank requires insurance that costs about \$5,000 a year.

Elevation Certificate and Its Purpose

A community's permit file must have an official record that shows new buildings and substantial improvements in all identified Special Flood Hazard Areas (SFHAs) are properly elevated. This elevation information is needed to document compliance with the local community's floodplain management ordinance. FEMA encourages communities to use the Elevation Certificate (EC) developed by FEMA to fulfill this requirement. The EC is also used as a tool for accurately rating a flood insurance policy for properties located in SFHAs. Find FEMA's current EC at: www.fema.gov/media-library/assets/documents/160.

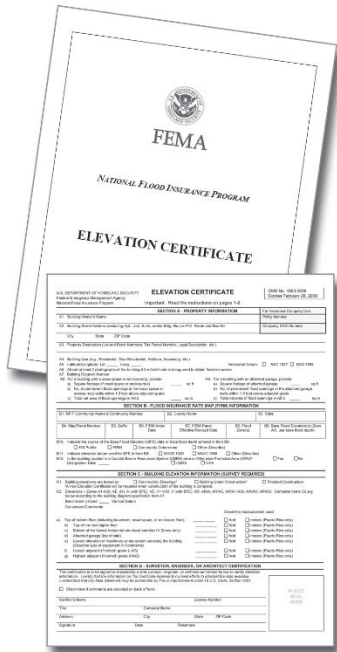

- In North Carolina, the EC must be completed and sealed by a licensed surveyor (a registered professional engineer or architect may complete an EC when based on "construction drawings" only)
- A community official or property owner may complete an EC for sites in approximate A Zones and AO zones
- An EC can be used to show the ground elevation at a development site when required for the permit application
- Insurance agents use the EC as a tool to write and rate flood insurance policies for SFHA properties
- The EC is generally required as part of a Letter of Map Amendment (LOMA) application to waive the flood insurance requirement

For more information about North Carolina's Certified Floodplain Surveyor (CFS) Program and Elevation Certificate training, visit: www.ncsurveyors.com/education/cfs_program.

Completing the Elevation Certificate

An EC may be required by the local permit official as part of an SFHA development permit application prior to construction and/or at the time of finished construction. It has numerous sections and includes detailed information to verify that buildings are properly elevated to reduce flood risk.

ELEVATION CERTIFICATE

OMB No. 1860-0008
Expiration Date: November 30, 2018

IMPORTANT: In these spaces, copy the corresponding information from Section A.			FOR INSURANCE COMPANY USE
Building Street Address (including Apt., Unit, Suite, and/or Bldg. No.) or P.O. Route and Box No.			Policy Number:
City	State	ZIP Code	Company NAIC Number

SECTION C – BUILDING ELEVATION INFORMATION (SURVEY REQUIRED)

C1. Building elevations are based on: Construction Drawings* Building Under Construction* Finished Construction

*A new Elevation Certificate will be required when construction of the building is complete.

C2. Elevations – Zones A1–A30, AE, AH, A (with BFE), VE, V1–V30, V (with BFE), AR, AR/A, AR/AE, AR/A1–A30, AR/AH, AR/AO. Complete Items C2.a–h below according to the building diagram specified in Item A7. In Puerto Rico only, enter meters.

Benchmark Utilized: _____ Vertical Datum: _____

Indicate elevation datum used for the elevations in items a) through h) below.

NGVD 1929 NAVD 1988 Other/Source: _____

Datum used for building elevations must be the same as that used for the BFE.

Check the measurement used.

- | | | | | |
|---|-------|-------|-------------------------------|---------------------------------|
| a) Top of bottom floor (including basement, crawlspace, or enclosure floor) | _____ | _____ | <input type="checkbox"/> feet | <input type="checkbox"/> meters |
| b) Top of the next higher floor | _____ | _____ | <input type="checkbox"/> feet | <input type="checkbox"/> meters |
| c) Bottom of the lowest horizontal structural member (V Zones only) | _____ | _____ | <input type="checkbox"/> feet | <input type="checkbox"/> meters |
| d) Attached garage (top of slab) | _____ | _____ | <input type="checkbox"/> feet | <input type="checkbox"/> meters |
| e) Lowest elevation of machinery or equipment servicing the building
(Describe type of equipment and location in Comments) | _____ | _____ | <input type="checkbox"/> feet | <input type="checkbox"/> meters |
| f) Lowest adjacent (finished) grade next to building (LAG) | _____ | _____ | <input type="checkbox"/> feet | <input type="checkbox"/> meters |
| g) Highest adjacent (finished) grade next to building (HAG) | _____ | _____ | <input type="checkbox"/> feet | <input type="checkbox"/> meters |
| h) Lowest adjacent grade at lowest elevation of deck or stairs, including structural support | _____ | _____ | <input type="checkbox"/> feet | <input type="checkbox"/> meters |

Documentation is Important – for You and Your Community



Terms and Definitions

Lowest Floor means the lowest floor of the lowest enclosed area (including basement). An unfinished or flood-resistant enclosure (that is not a basement) is not the lowest floor if the enclosure is built as required in the local ordinance ([see pages 50 and 78](#)), which includes limited uses.

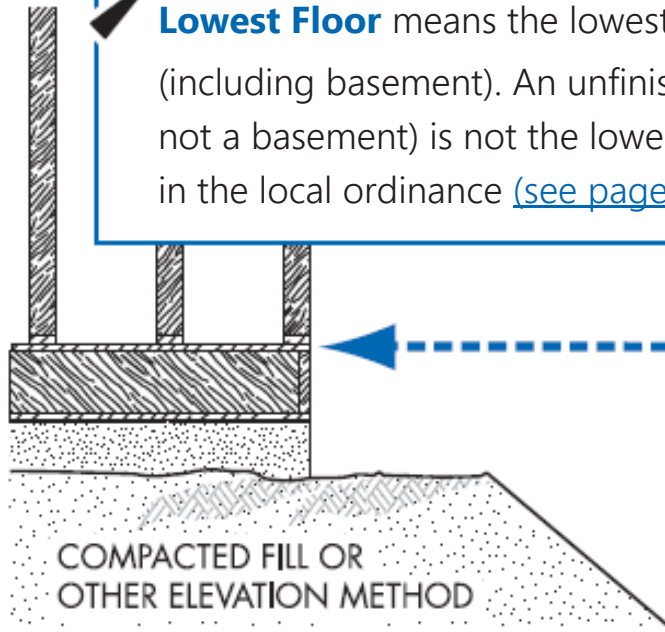

If you get a permit to build in the floodplain, a FEMA Elevation Certificate or similar documentation will be required as soon as your lowest floor is set. An “as-built” survey and Elevation Certificate will be required when construction is completed. This form is important! It proves that you built correctly. It can be used to obtain the correct insurance rating.

The Adverse Impacts of Floodplain Fill

Floodplain serves as storage for flood water. If storage space is blocked by fill material, future flooding may be worsened. Floodplain fill can alter valuable floodplain functions, including wildlife habitat and wetlands. Your community may apply the same restrictions to in the flood fringe as those applied in floodways.

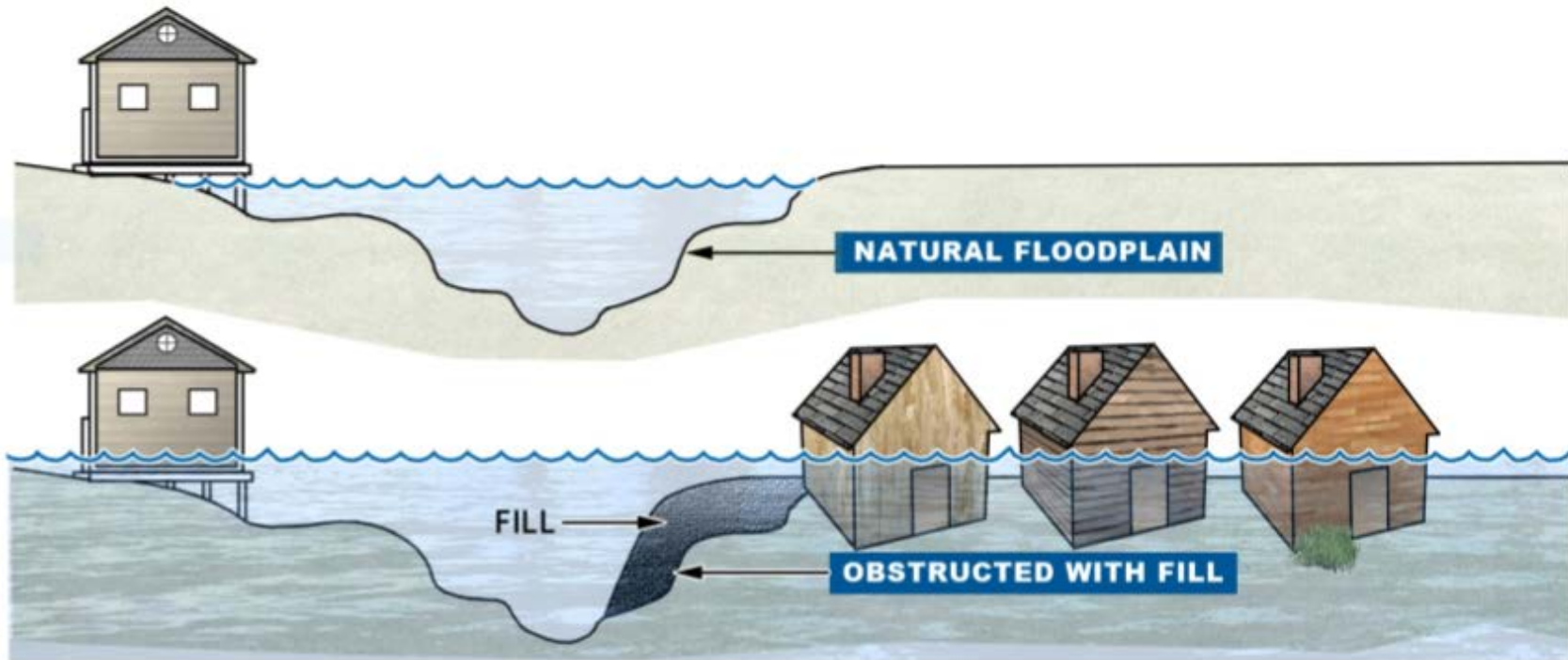

To ensure that a proposed development, including placement of fill in or near a floodplain, won't adversely impact your neighbor, check with your community's planning, engineering, or permit office before beginning any construction.

Required “No-Impact” Certification

Check with your community for guidance before you decide to work in a floodway. Any project in a floodway must be reviewed to determine if the project will increase flood heights and ensure floodplain fill won't harm your neighbor.

An engineering analysis must be conducted before a permit can be issued. The community's permit file must have a record of the results of this analysis, which can be in the form of a No-Rise/No-Impact Certification. This certification must be supported by technical data and signed by a registered professional engineer.

For further information about the No-Rise/No-Impact certification, visit:

www.ncdps.gov/div/EM/Documents/NFIP-No-RiseGuidanceDocument.pdf.

ENGINEERING “NO IMPACT” CERTIFICATION (example)

This is to certify that I am a duly qualified engineer licensed to practice in the State of North Carolina. It is to further certify that the attached technical data supports the fact that proposed (Name of Development) will not impact the 100-year flood elevations, floodway elevations and floodway widths on (Name of Stream).



**National Flood
Insurance
Program**

Signature _____ Seal _____

The engineering analysis must be based on technical data obtained from the state or FEMA.
Save time and money—don't build in a floodway!

How to Elevate your Floodplain Building (Riverine)

CAUTION: To ensure that a proposed development, including placement of fill in or near a floodplain, won't adversely impact your neighbor, check with your community's planning, engineering, or permit office before beginning any construction. Building construction and enclosures (including crawlspace) have special requirements in the high-risk flood zones. As a condition of NFIP participation, a community must adopt a floodplain management ordinance requiring that new and substantially improved residential buildings must be constructed with the lowest floor at or above the Base Flood Elevation (BFE). Non-residential buildings can either be elevated or floodproofed to the BFE. FEMA encourages communities to adopt regulations requiring at least a one-foot freeboard. Building at least one foot above the BFE significantly lowers flood insurance rates due to lower flood risk.

ELEVATE ON FOUNDATION WALLS

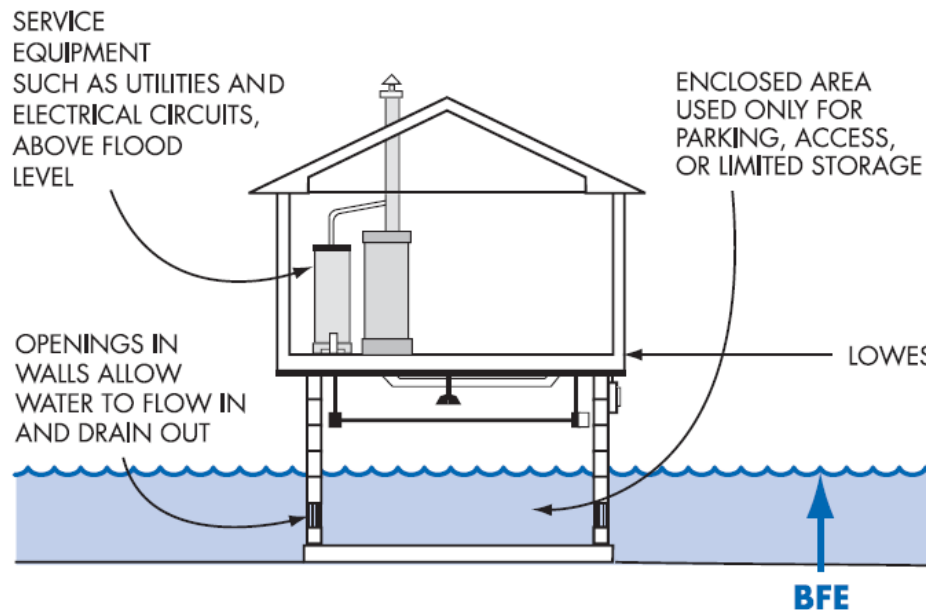

ELEVATE ON FILL

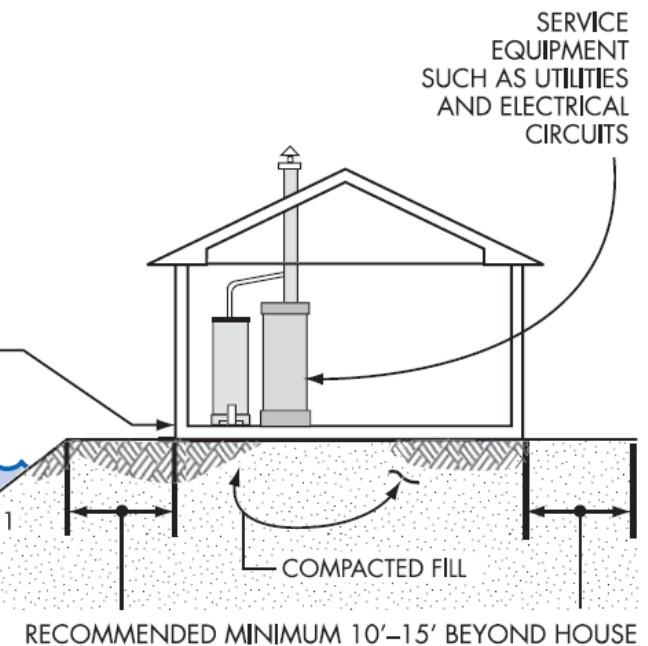

Compaction of Floodplain Fill (A Zones)

Earthen fill used to raise the ground above the flood elevation must be placed properly so that it does not erode or slump when water rises. For safety and to meet floodplain requirements, floodplain fill should:

- Extend 10 to 15 feet beyond the footprint of the structure
- Be good clean soil, free of large rocks, construction debris, and woody material (e.g. stumps, roots). Communities should refer to local community guidelines for fill material that is required for any specific compaction testing
- Have graded side slopes that are not steeper than 2:1 (one foot vertical rise for every two feet horizontal extent); flatter slopes are recommended
- Have slopes protected against erosion (vegetation for “low” velocities, durable materials for “high” velocities—determined by a design professional)
- Be machine compacted to 95% of the maximum density (determined by a design professional)

Communities may ask for a licensed engineer to certify the fill elevation, compaction, slope, and slope protection materials to determine that the proposed structure will be “reasonably safe from flooding.”

More information on the “reasonably safe from flooding” standard can be found in FEMA’s Technical Bulletin at www.fema.gov/media-library-data/20130726-1511-20490-3169/tb1001.pdf.

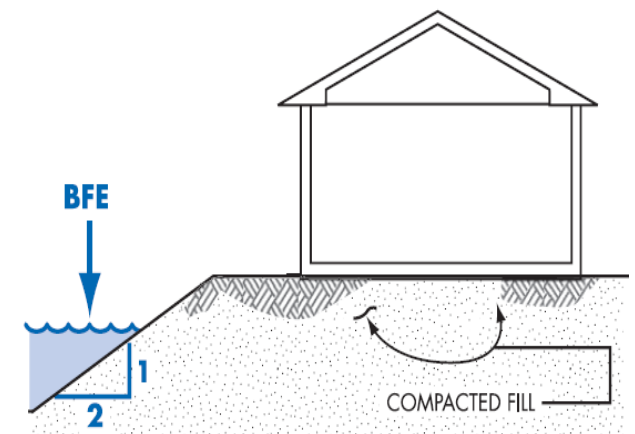

Enclosures Below the BFE (A Zones)

Solid perimeter wall foundations can enclose flood-prone space. A crawlspace is a good way to elevate just a couple of feet. In all cases, the following are required: flood vents/openings, elevated utilities, flood-resistant materials, and limitations on use.

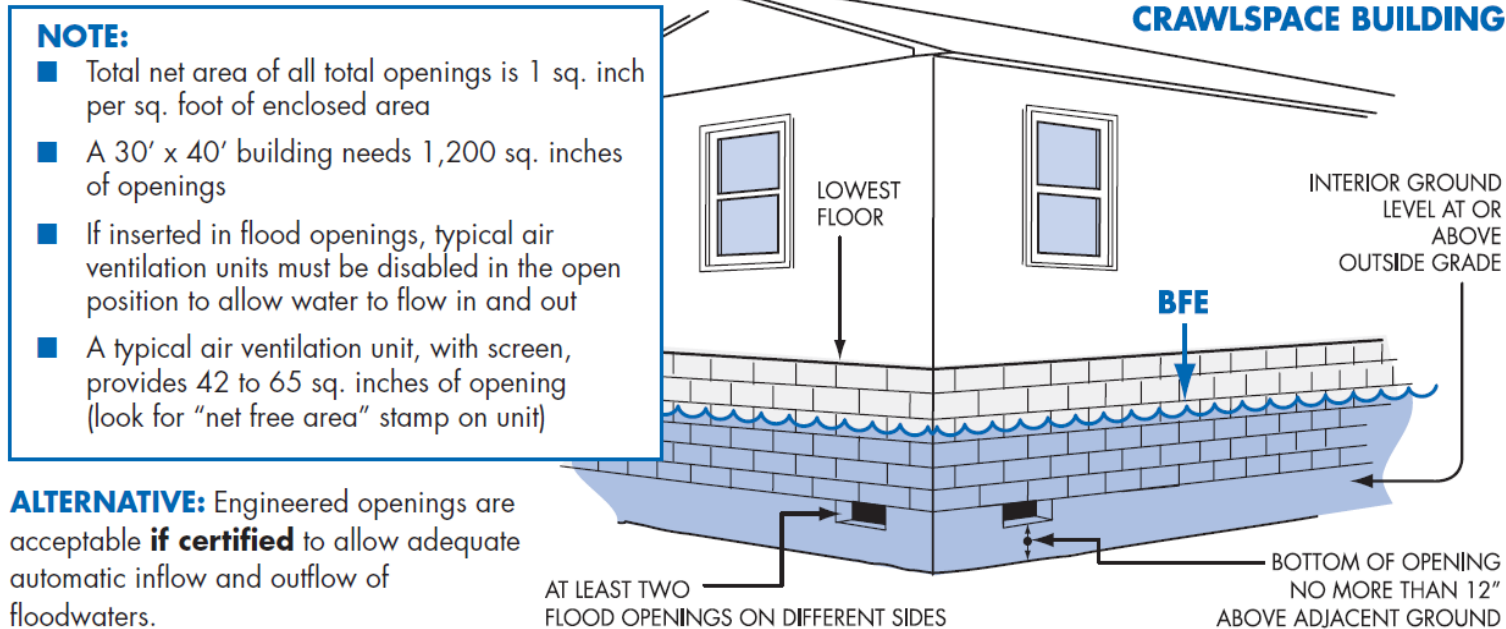

Additional information about flood openings is available in FEMA's Technical Bulletin 1: Openings in Foundation Walls and Walls of Enclosures: www.fema.gov/media-library-data/20130726-1502-20490-9949/fema_tb_1_1_.pdf.

Crawlspace Details (A Zones)

- The Lowest Floor Elevation must be at or above the BFE
- All materials below the BFE must be flood resistant
- The bottom of flood openings/vents must be no more than 12 inches above interior or exterior grade
- Standard air ventilation units must be disabled in the “open” position to allow water to flow in and out
- Interior grade must be equal to or higher than exterior grade on at least one side

Calculate Net Flood Opening: A building that measures 30' x 40' has 1,200 square feet of enclosed crawlspace. Flood vents must provide 1,200 square inches of net open area (or have certified engineered openings). If a standard air vent unit provides 60 square inches of net open area, 20 vent units are required to satisfy the flood opening requirement (1,200 divided by 60).

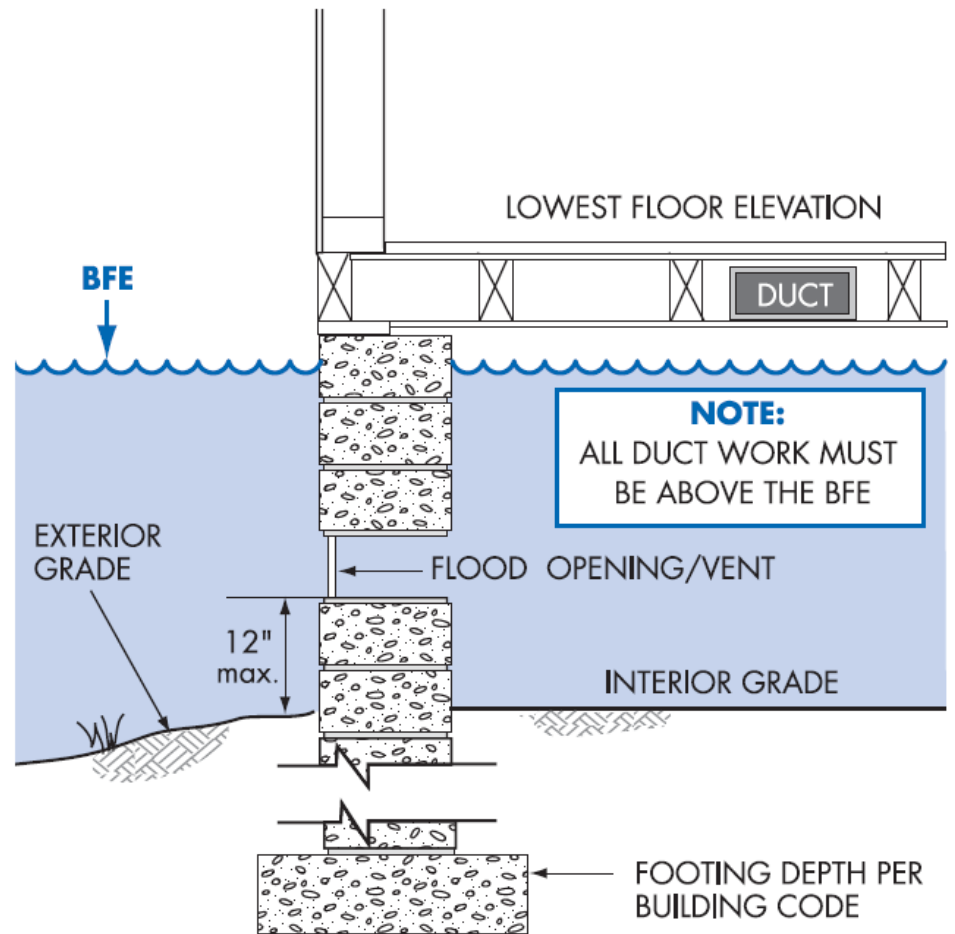

Basements Are Especially Flood Prone

A **Basement** is any portion of a building that has its floor subgrade (below ground level) on all sides. Basements below the BFE are **not** allowed in new buildings and flood insurance coverage is very limited in existing basements for a very good reason. It only takes an inch of water over the sill to flood a basement! Excavating a basement into fill doesn't always make it safe because saturated groundwater can damage the walls.

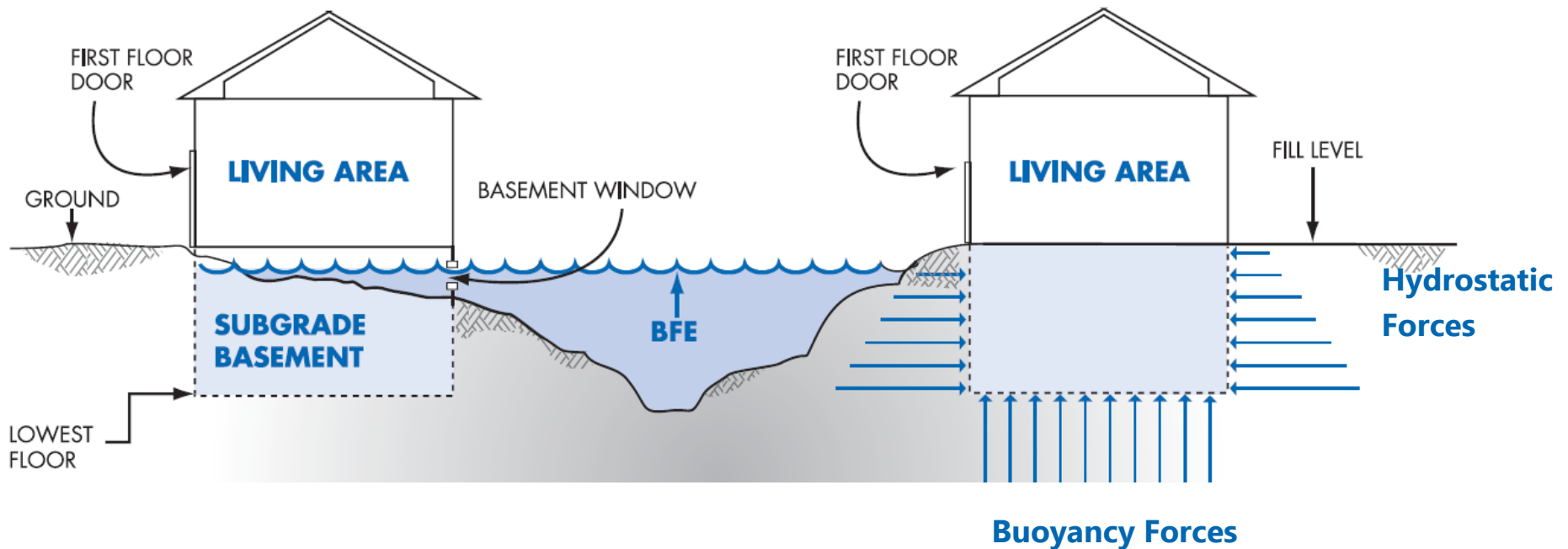

Manufactured Homes Require Special Attention

Experience shows that manufactured homes are easily damaged. As little as 1 foot of water can cause substantial damage.

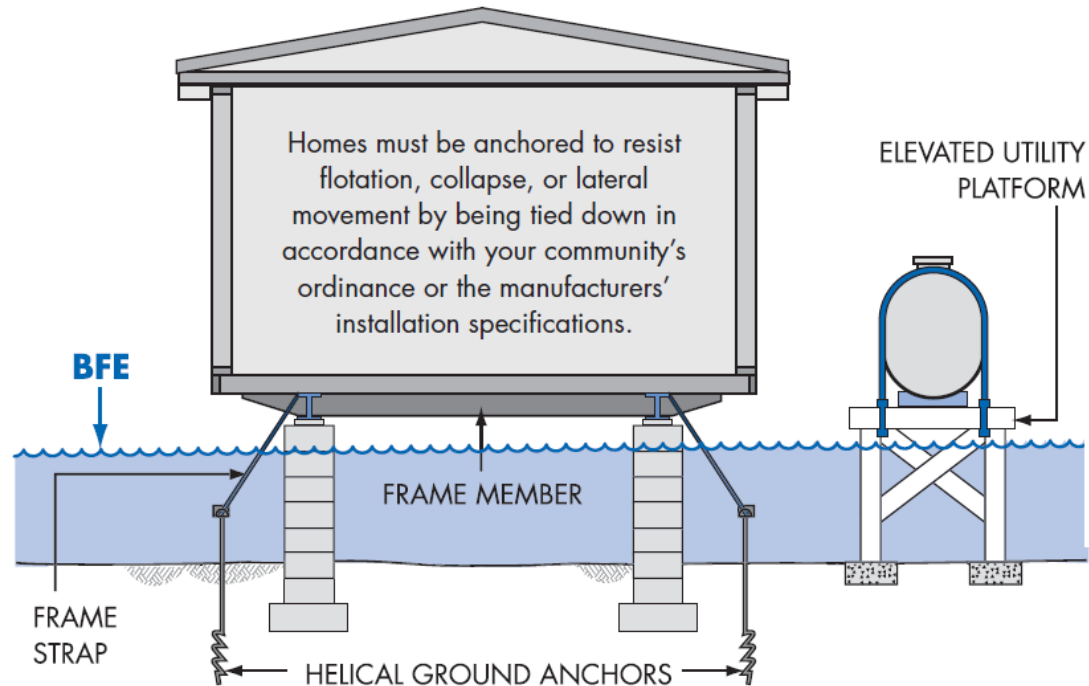
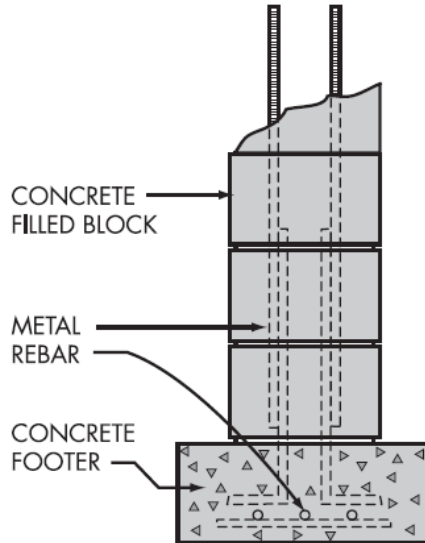

In North Carolina, new manufactured homes are prohibited in floodways, non-encroachment areas, and V Zones. FEMA P-85 "Protecting Manufactured Homes from Floods and Other Hazards" is a good reference:

www.fema.gov/media-library/assets/documents/2574.

Utility Service Outside Buildings

Fuel and propane tanks may cause explosion and pollution risks during flood conditions! Even shallow water can create large buoyant forces on tanks so extra care must be taken to ensure that all tanks are anchored.

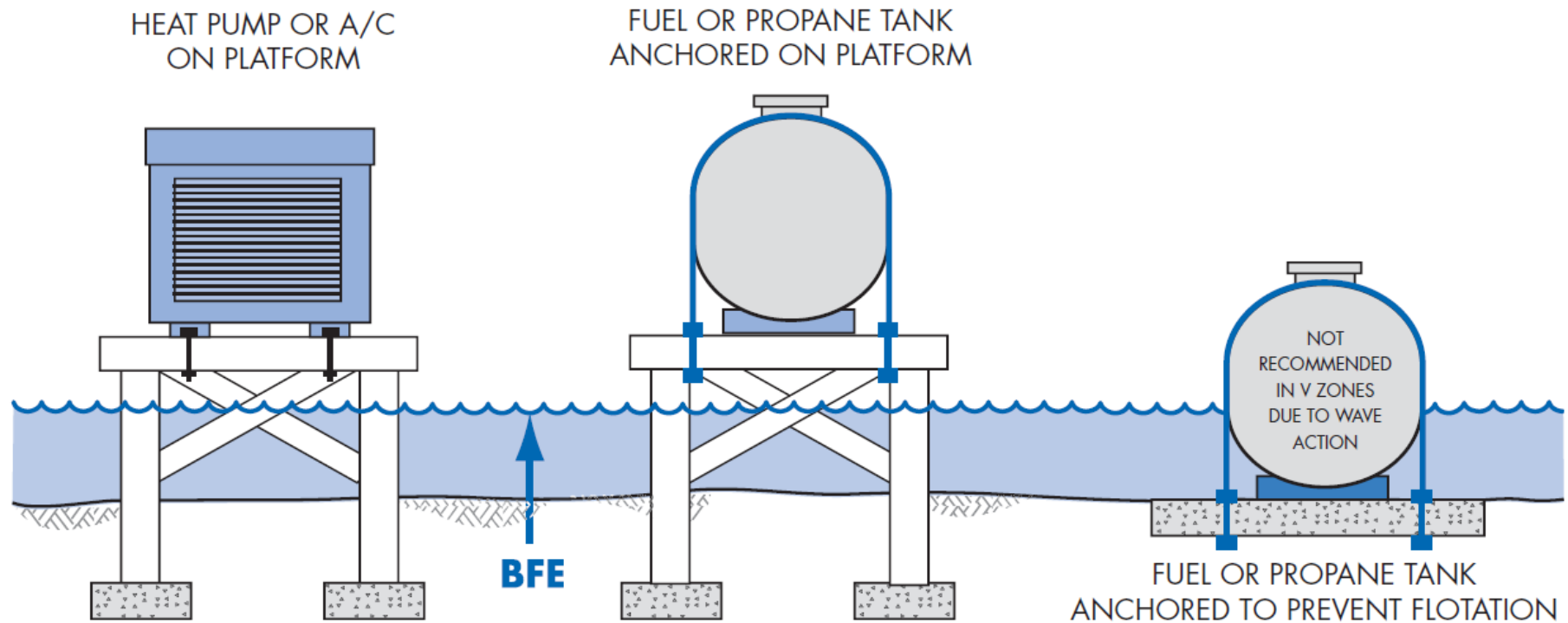

Whether inside an attached garage or outside the building, all utilities, appliances and equipment must be elevated above the BFE or protected against flood damage. Utilities include plumbing, electrical components, gas lines, fuel tanks, and heating and air conditioning equipment.

Additional Resource:

- FEMA 348, Protecting Building Utilities from Flood Damage:
www.fema.gov/media-library/assets/documents/3729

Utility Service Inside Enclosures

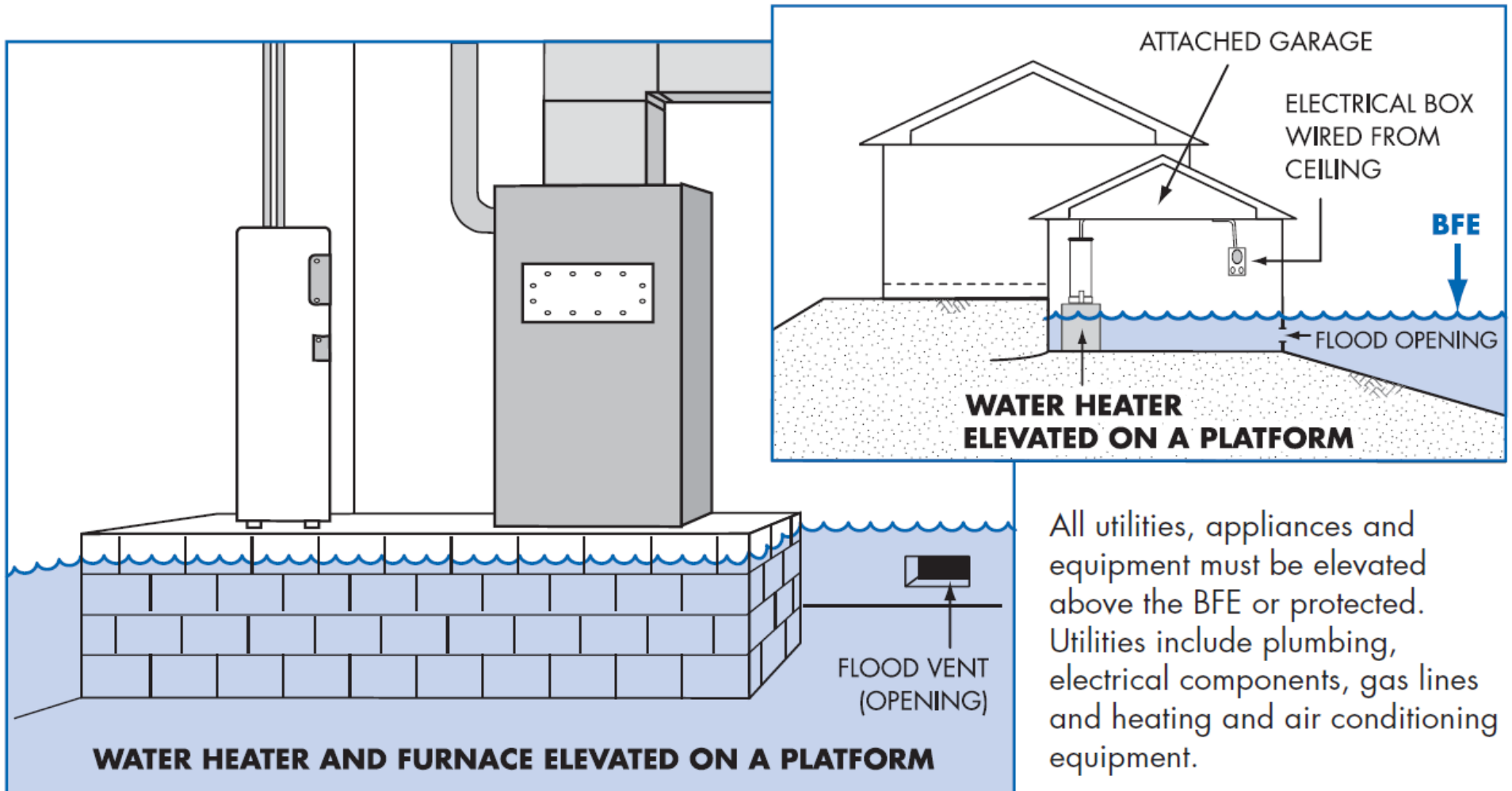

Accessory (Appurtenant) Structures

An **Accessory (Appurtenant) Structure** means a structure that is located on the same parcel of land as a principal structure and whose use is incidental to the use of the principal structure. Accessory structures may not be used for human habitation and must be designed to minimize flood damage. Examples: detached garages, pools, carports, storage sheds, decks, gazebos, pole barns, and hay sheds.

Even small buildings are considered “development” and permits or variances with noted conditions are required. They must be elevated or anchored and built to withstand flood damage. Remember, everything inside is likely to get wet when flooding occurs.

In Special Flood Hazard Areas, accessory and appurtenant structures must:

- Not be habitable
- Be used only for parking or storage (not pollutants or hazardous materials)
- Be anchored to resist floating
- Have flood openings/vents
- Be built of flood-resistant materials
- Have elevated utilities
- Not be modified for different use in the future
- Have documented floor elevation

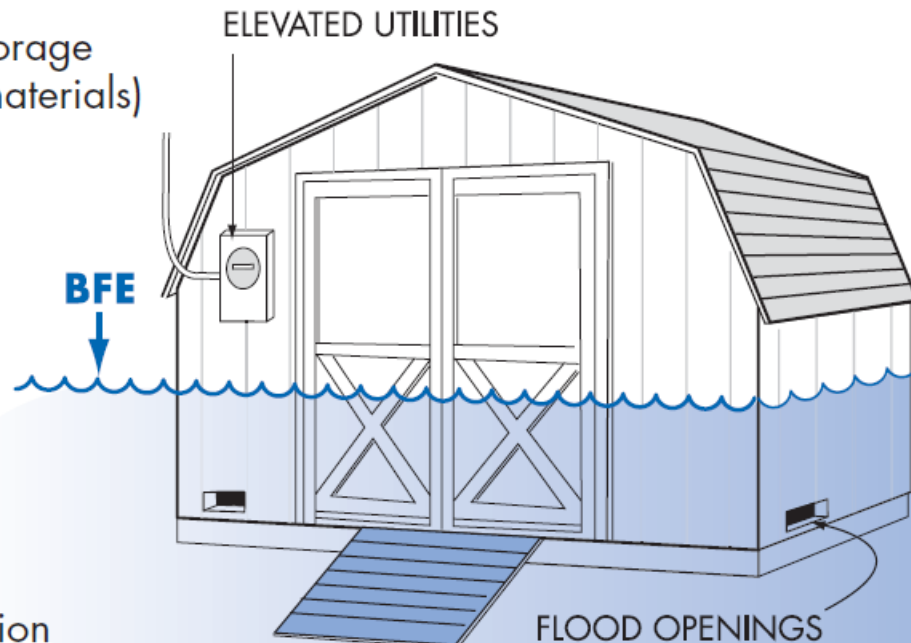

Recreational Vehicles

In Special Flood Hazard Areas, RVs must:

- Be licensed and titled as an RV or park model (not as a permanent residence)
- Be built on a single chassis
- Have inflated wheels and be self-propelled or towable by light truck
- Have no attached deck, porch, or shed
- Be used for temporary recreational, camping, travel, or seasonal use (no more than 180 days)
- Have quick-disconnect sewage, water, and electrical connectors



RVs that do not meet these conditions must be installed and elevated like manufactured homes, including permanent foundations and tie-downs.

IMPORTANT FLOOD SAFETY INFORMATION

Camping or temporary placement of your RV near the water requires special attention to flood risk. Check with the campground or RV park operator about flood warnings and emergency evacuation routes and plan accordingly in the event of flash flooding or rising water. Remember to “Turn Around, Don’t Drown.”

Improving Your Floodplain Building

Substantial improvement means any reconstruction, rehabilitation, addition, or other improvement of a structure, the cost of which equals or exceeds 50% of the market value of the structure before the start of construction of the improvement.

This term includes structures which have incurred substantial damage from any cause, regardless of the actual work performed.

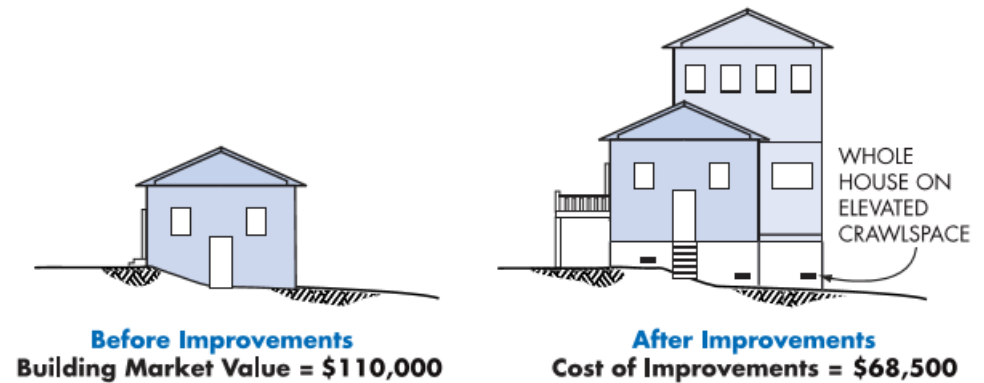

Important

If the cost of the improvement equals or exceeds 50% of the market value of the building, you must comply with the Substantial Improvement requirements.

If the costs are less than 50% of its market value, only the addition is required to be built above the BFE, but you should still consider ways to reduce future damage.

The cost to correct previously cited violations of state or local health, sanitary, or safety code to provide safe living conditions can be excluded. Alteration of a registered historic structure is allowed, as long as it will continue to meet the criteria for listing as a historic structure and FEMA P-467-2 Historic Structures.

See FEMA P-758 Substantial Improvement/Substantial Damage Desk Reference for more information.

Non-Substantial Improvements

Your proposed improvements are “non-substantial” if the costs of all improvements are less than 50% of the market value of the building. Although you are not required to bring the existing building into compliance, there are many things you can do to reduce future flood damage. Find out the BFE at your locations and consider the following:

- Use flood resistant materials, for example tile, closed-cell wall insulation and polyvinyl wall coverings.
- Raise air conditioning equipment, heat pump, furnace, hot water heater and other appliances on platforms.
- Install electrical outlets higher above the floor.
- Move ductwork out of crawlspaces.
- Retrofit Crawlspaces with flood openings.
- Fill in below-grade crawlspaces/utility space.

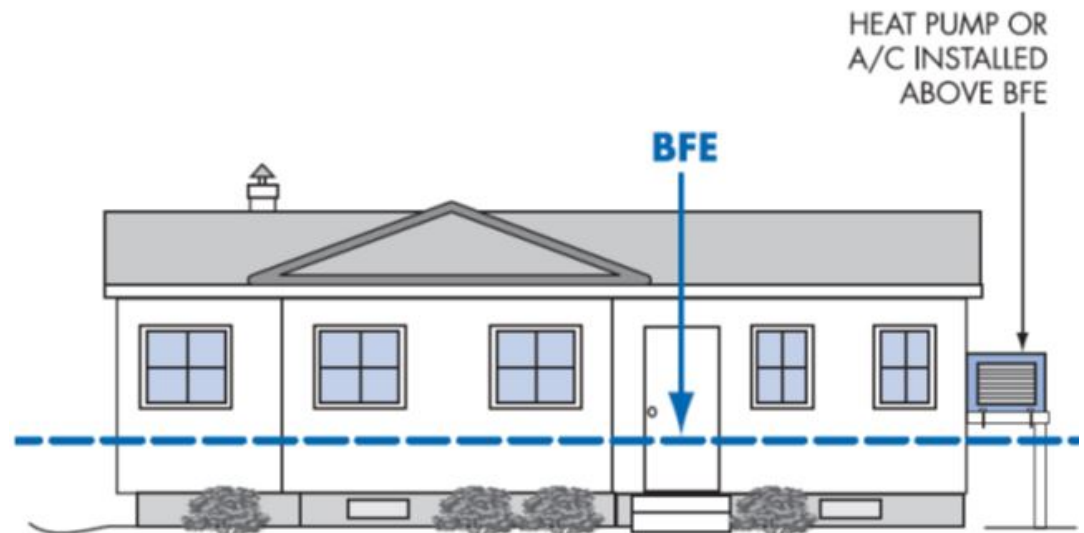

Be sure to include ALL proposed work in your initial permit application. If you add more work after the permit is issued your community will make another evaluation for Substantial Improvement.

Substantial Improvement: Renovation Only

Floodplain buildings can be improved, renovated, rehabilitated, or altered, but special rules apply. Check with your local permit office before you begin. It will be easier to do it right the first time. The cost to correct previously cited violations of state or local health, sanitary, or safety codes to provide safe living conditions can be excluded from the cost of renovations. Alteration of a registered historic structure is allowed, by variance, if it will continue to meet the criteria for listing as a historic structure.

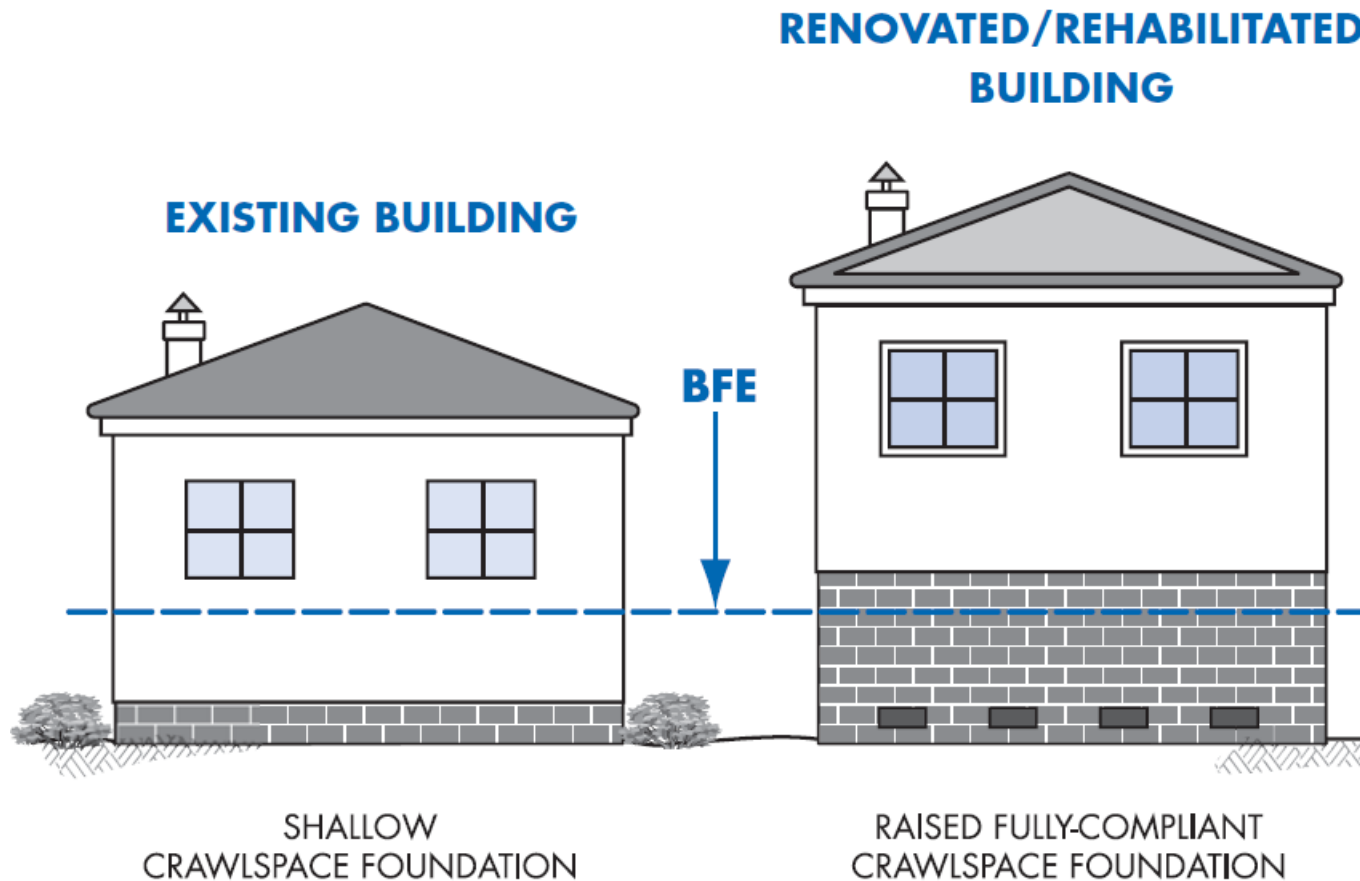

Substantial Improvement: Lateral Addition Only

You must get a permit from your community to build an addition to your floodplain building. Only the addition must be built with the lowest floor at or above the Base Flood Elevation provided:

- You make no interior modifications to the existing building; and
- You make no structural modifications to the existing common wall other than adding a standard 36" door.
- See the "Substantial Improvement: Addition Plus Other Work" section of this document if your project to add a lateral addition also includes modifying the interior of the existing building or making structural modifications to the existing common wall.

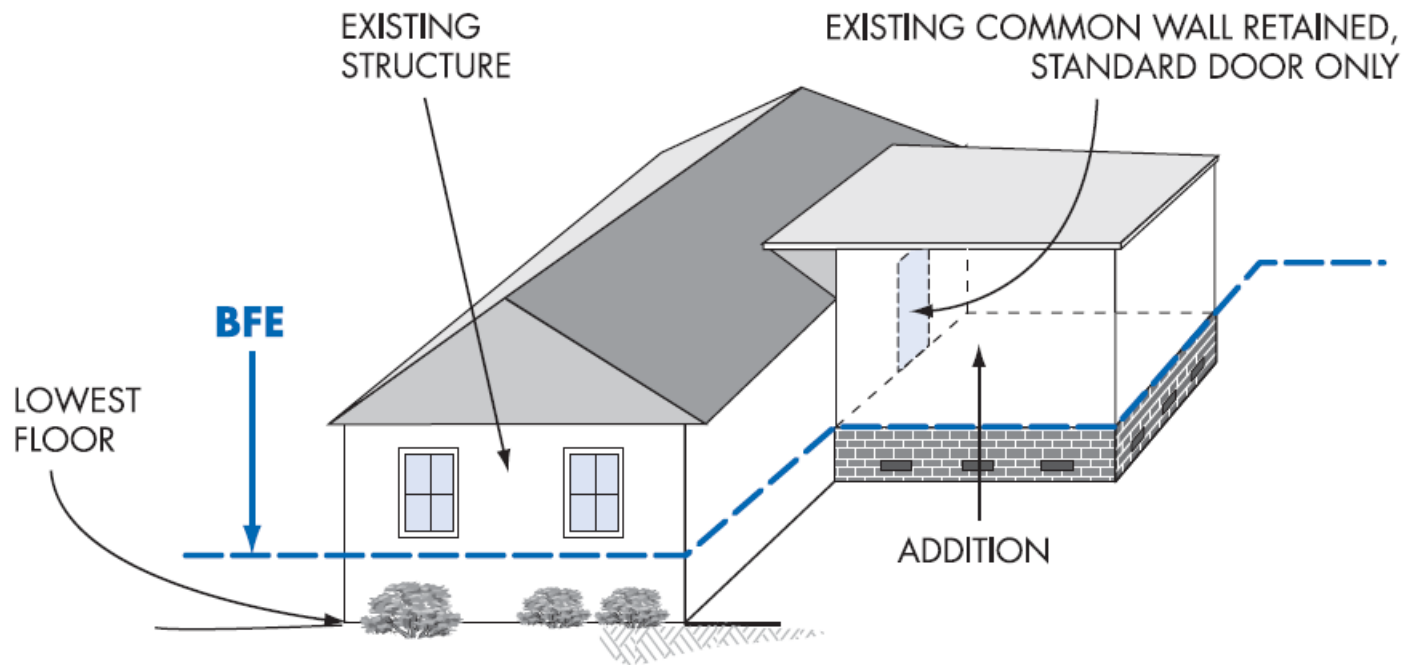

Substantial Improvement: Addition Plus Other Work

Your community must prepare an evaluation to determine if all of your proposed work will trigger the Substantial Improvement requirement.

Substantial Improvement is triggered if:

- The work involves adding a new top floor, modifying the interior of the existing building, or structural modifications to the existing common wall (for lateral addition); and
- The cost of all proposed work plus the cost of improvements equals or exceeds 50% of the market value of the existing building

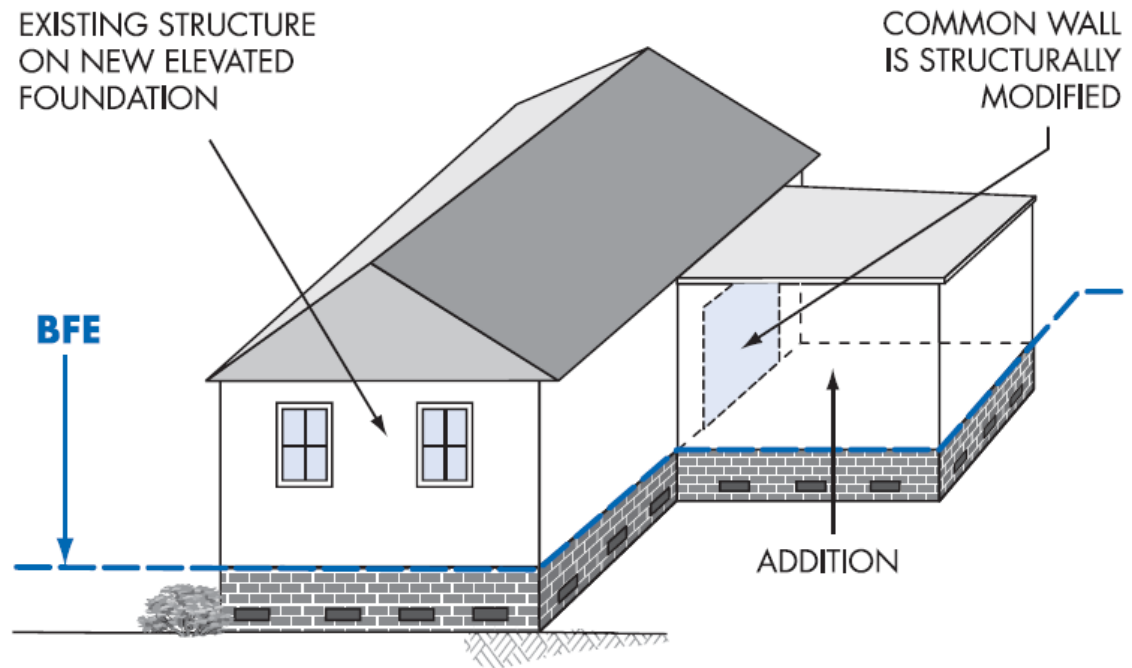

Your community's permit office can help you determine which requirements apply. It is always a good idea to request a preliminary review before you get too far along with your plans.

Additional Resources:

- FEMA P-758, Substantial Improvement/Substantial Damage Desk Reference: www.fema.gov/media-library/assets/documents/18562
- FEMA P-784 CD, Substantial Damage Estimator (SDE): www.fema.gov/media-library/assets/documents/18692

Post-Damage Considerations

A permit is required to repair a damaged floodplain structure, regardless of cause—fire, flood, wind, or even a truck running into a building. You will be asked to provide a detailed cost estimate to repair it to its pre-damaged condition. If the repair costs are 50% or more of the pre-damage market value of the building, then the building is Substantially Damaged and must be brought into compliance, which may involve raising the foundation or other measures.

Check with your community before you begin repairs. Some permit fees can be waived after a disaster, but the permit cannot be waived. It is also a good idea to confirm with the community about any regulations for flood repetitive loss structures.



Post-Flood Compliance Funding

Increased Cost of Compliance (ICC) is part of most standard NFIP flood insurance policies. Claims for ICC benefits are filed separately from your claim for contents or building loss. If eligible, you can collect up to \$30,000 to help cover the cost of bringing your home or business into compliance with your community's current Flood Damage Prevention ordinance. You may file a claim for ICC coverage if:

- You have NFIP flood insurance that includes ICC coverage
- Your building is in the mapped Special Flood Hazard Area
- Your building's lowest floor is below the Base Flood Elevation required by your community
- Your community has made an official determination that flooding and repair costs substantially damaged the building and will exceed 50% of the building's pre-damage market value
- Check to see if your community's floodplain ordinance has been amended to include a "Repetitive Loss" provision for ICC benefits. ICC benefits will be paid if a flood-insured structure was damaged by a flood two times in the past 10 years, where the cost of repairing the flood damage, on average, equaled or exceeded 25% of its market value at the time of each flood. This is called repetitive damage. Additionally, there must have been a flood insurance claim payment for each of the two flood losses. Note: A Repetitive Loss is not eligible under ICC unless it is defined in the community's Flood Damage Prevention Ordinance

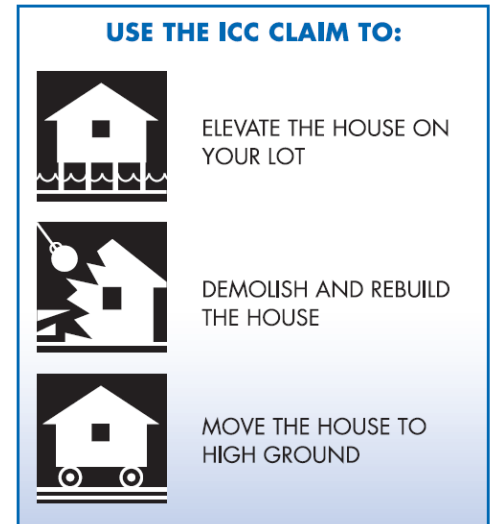

Owners whose buildings are substantially damaged are required to bring the building into compliance with local floodplain regulations. If your building is damaged by flood and you meet the above criteria for filing an ICC claim, you will need to work with your local building official and claims adjuster to process the necessary paperwork.

Additional Resources:

- FEMA's Increased Cost of Compliance: www.fema.gov/increased-cost-compliance-coverage
- FEMA's Increased Cost of Compliance (ICC) Coverage: Guidance for State and Local Officials: www.fema.gov/media-library/assets/documents/1973

Elevating Pre-FIRM Buildings

This is one way to elevate an existing building to comply with floodplain regulations.

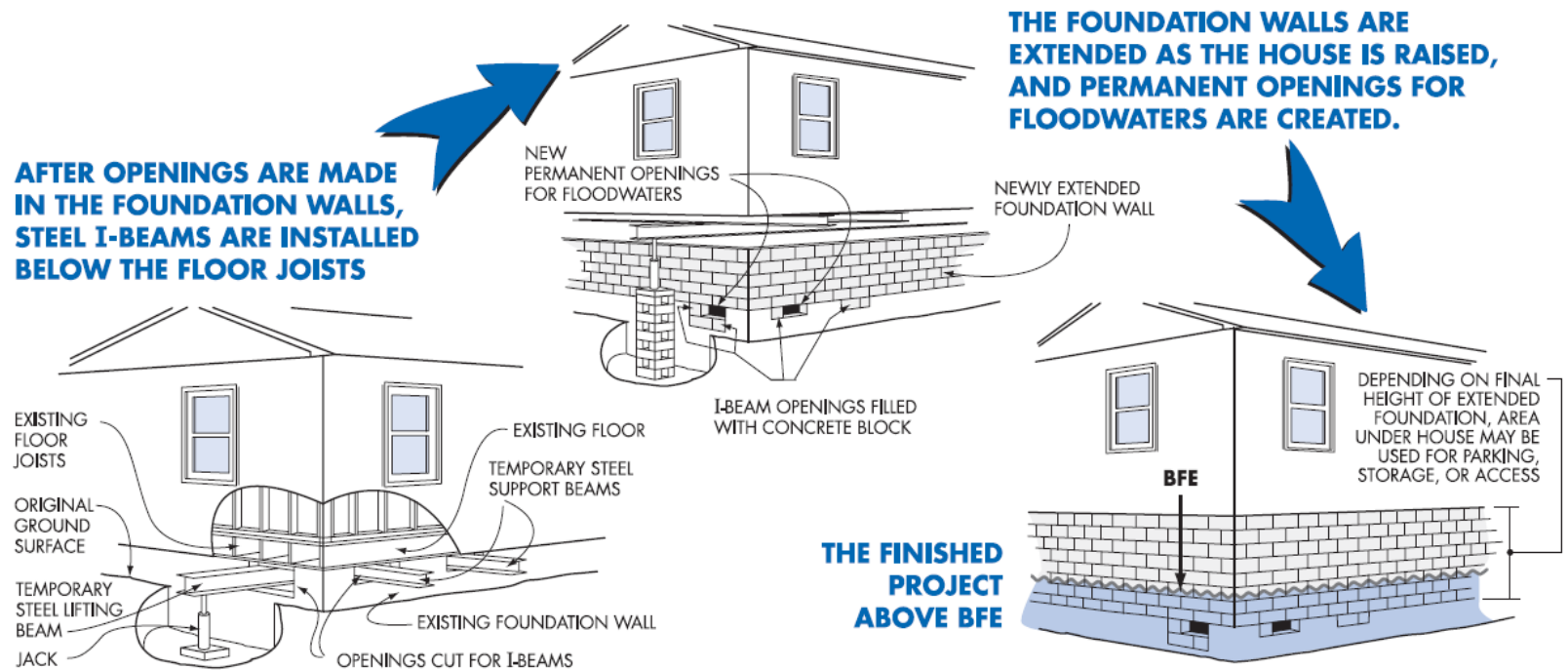

Additional Resources:

- FEMA 348, Protecting Building Utilities from Flood Damage: www.fema.gov/media-library/assets/documents/3729
- FEMA P-312, Homeowner's Guide to Retrofitting: www.fema.gov/media-library/assets/documents/480
- FEMA's Increased Cost of Compliance: www.fema.gov/increased-cost-compliance-coverage
- FEMA's Increased Cost of Compliance (ICC) Coverage: Guidance for State and Local Officials: www.fema.gov/media-library/assets/documents/1973

Easy and Low-Cost Protection Options for Older Homes

- Move water heaters, furnaces, and ductwork out of crawlspaces and basements.
- Anchor heating oil and propane gas tanks to prevent flotation.
- **Do not** store valuables or hazardous materials in a flood-prone crawlspace or basement.
- Use water-resistant materials when you repair.

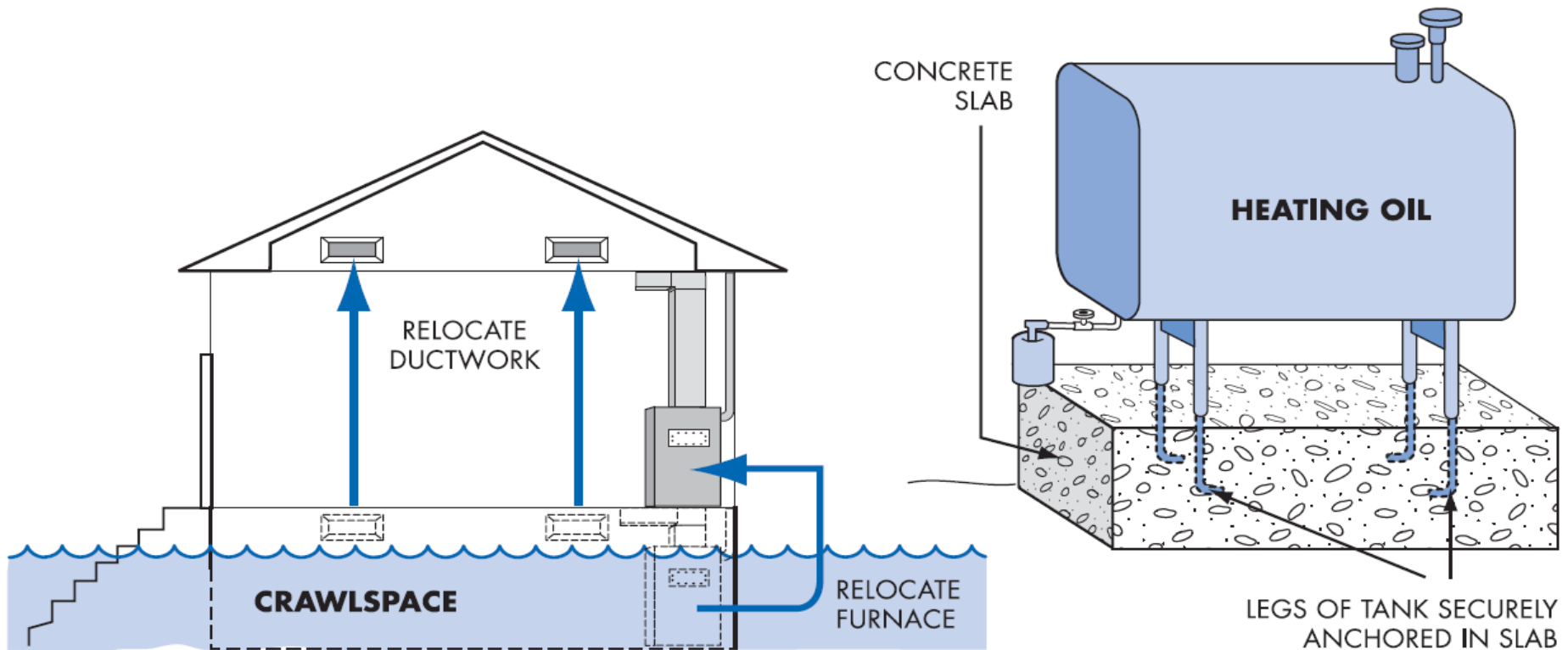

More Expansive Flood Mitigation Projects

Some Flood Mitigation Projects are More Costly—But Give You More Protection

After floods, some communities buy out and demolish homes that were severely damaged. The acquired land is dedicated to open space and can be used for recreation or to help restore wildlife habitat and wetlands. In some cases, FEMA also provides mitigation grant assistance to elevate or relocate a structure out of a flood-prone area for residents of flood-damaged communities. The **FEMA Hazard Mitigation Grant Program (HMGP)** is initiated and managed by the community, so check with your local engineering or planning office to determine if you're eligible for FEMA grant assistance.

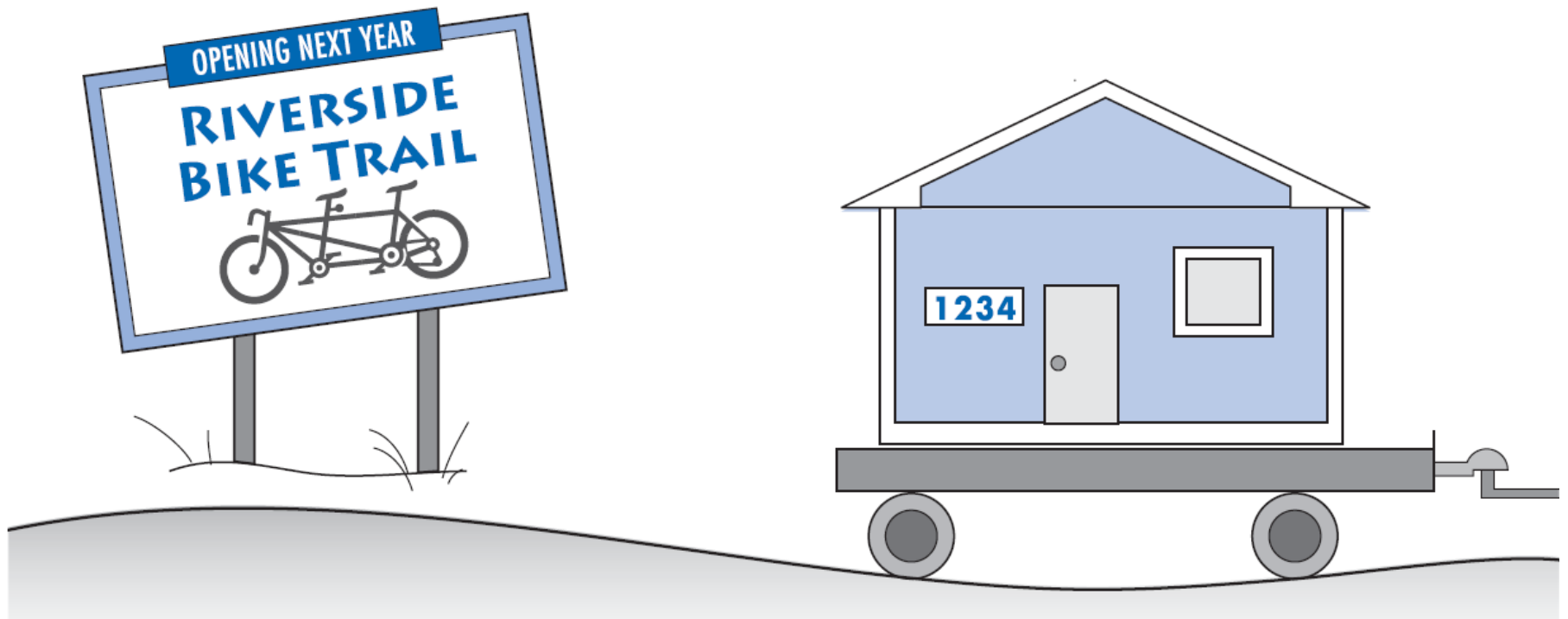

Riverine Floodplains

How riverine models are created:

- Hydrology (flows) are derived using historic records, detailed studies, or regression calculations
- Riverine cross-sections are created using field survey and LiDAR topographic data
- Obstructions, ground cover, bridges, culverts, dams, encroachments, and other hydraulic features are entered into the model
- Flood levels are calculated based on the flows and the hydraulic modeling
- The flood levels are intersected with the ground topography to determine the limits of flooding

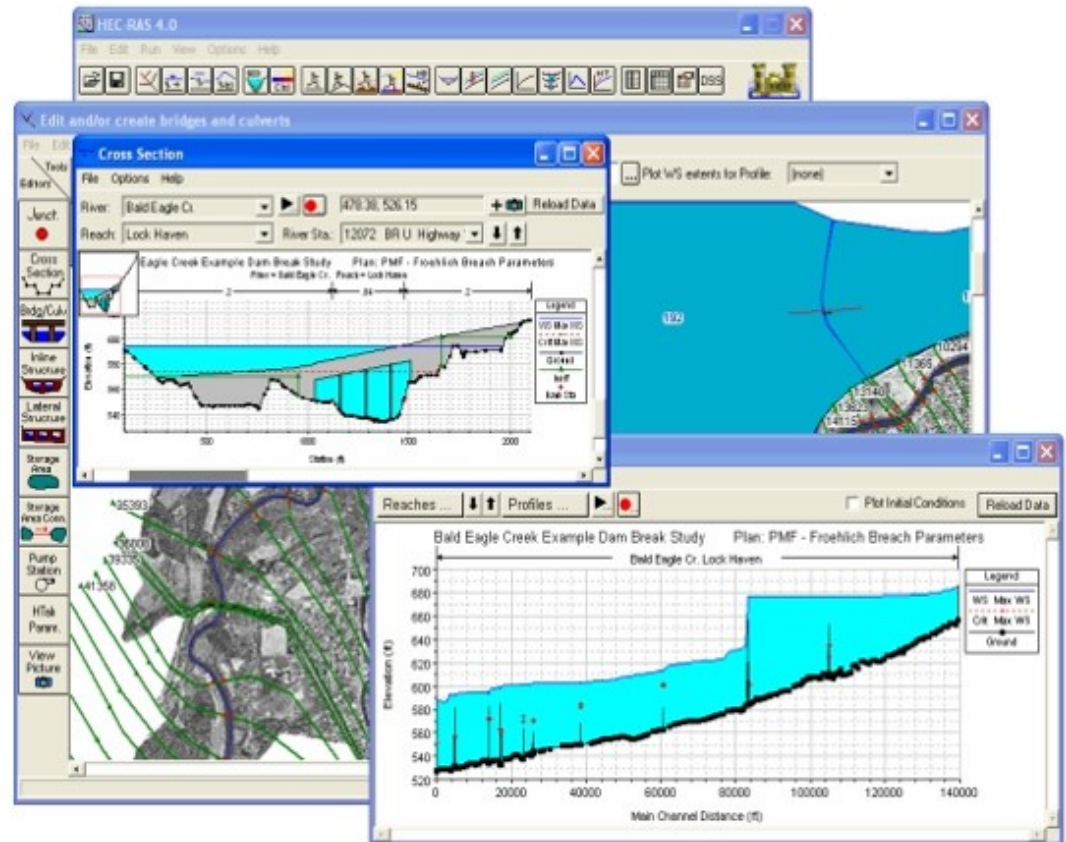

Understanding the Riverine Floodplain

For floodplains with Base Flood Elevation information, check the Flood Insurance Study to find the Flood Profile which shows water surface elevations for different frequency floods.

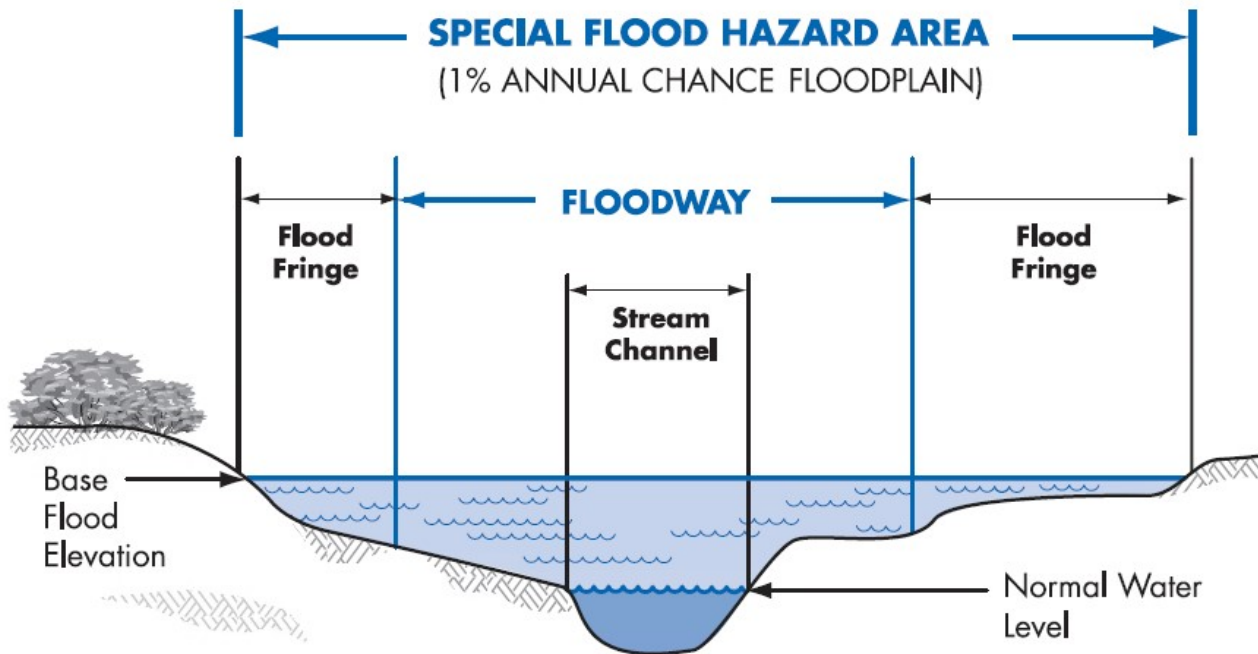

Terms and Definitions

Special Flood Hazard Area (SFHA) is that portion of the floodplain subject to inundation by the base flood and/or flood-related erosion hazards. SFHAs are shown on Flood Insurance Rate Maps (FIRMs) as Zones A, AE, A1-A30, AH, AO, and AR for riverine floodplain areas. Coastal flood zones are V, VE, and V1-V30.

The **floodway** is the area of the floodplain where floodwaters usually flow faster and deeper.

The **base flood** means the flood having a 1% chance of being equaled or exceeded in any given year (also called the "100-year floodplain").

Understanding the Floodway

The **Floodway** or **Non-Encroachment Area** includes the channel of a river or other watercourse and the adjacent land areas that must be reserved in order to pass the base flood discharge without increasing flood depths. Computer models of the floodplain are used to simulate “encroachment” or development in the flood fringe to predict where and how much the Base Flood Elevation would increase if the floodplain is allowed to be developed.

Any project in a floodway must be reviewed by the local community’s engineering or planning office to determine if the project will increase flood heights. An engineering analysis must be conducted before a permit can be issued. The community’s permit file must have a record of the results of this analysis which can be in the form of a **No-Impact Certification**.

The **No-Impact Certification** must be supported by technical data and signed by a registered professional engineer. The supporting technical data should be based on the standard step-backwater computer model used to develop the floodway shown on the **Flood Insurance Rate Map (FIRM)** or **Flood Boundary and Floodway Map (FBFM)**.

A Floodway or Non-Encroachment Area can exist above overtopped bridges or culverts.

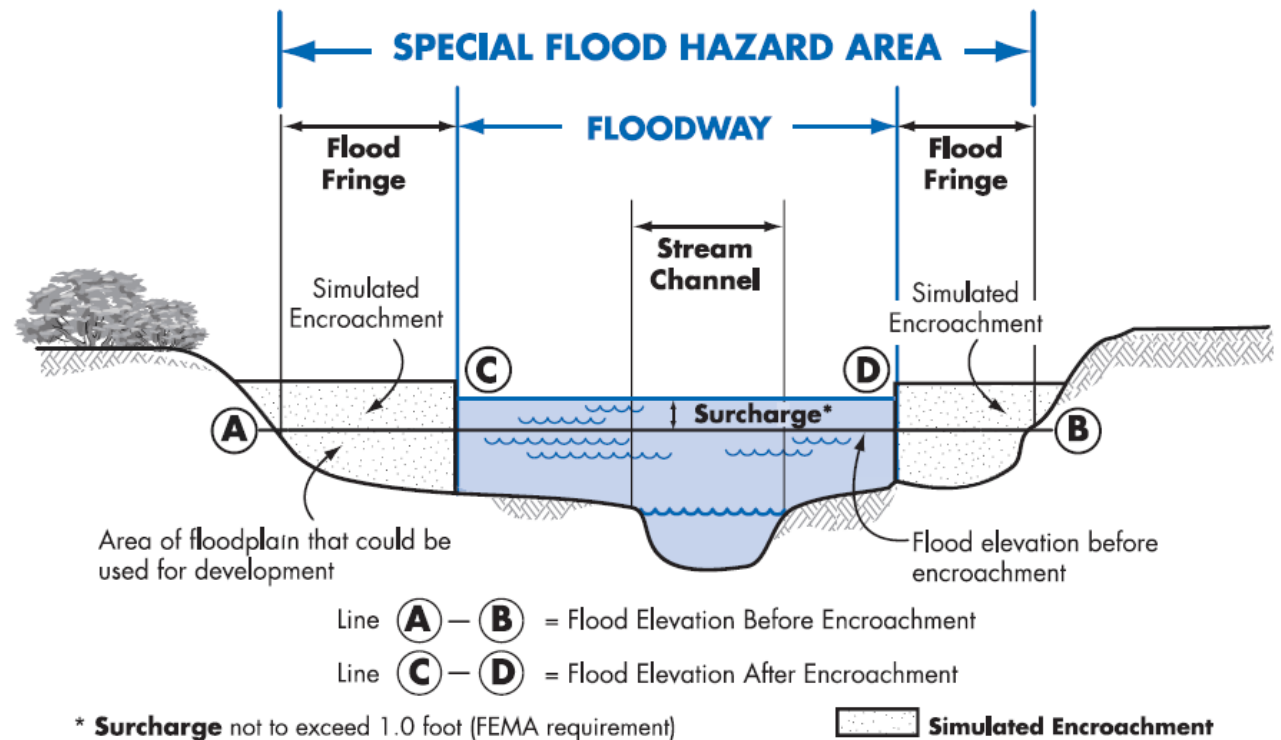

Riverine: Flood Insurance Rate Map

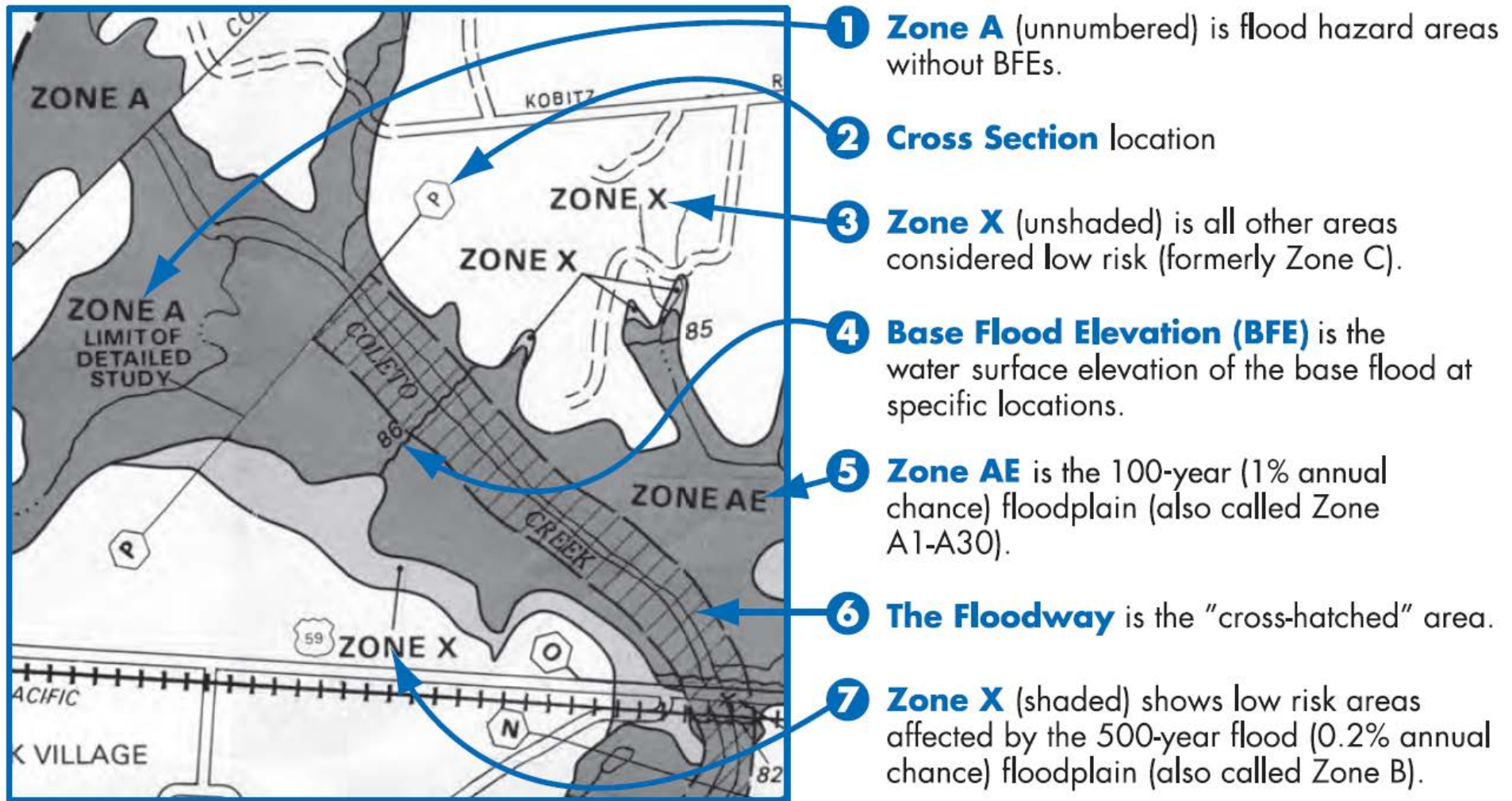

FEMA prepares **Flood Insurance Rate Maps (FIRMs)** to show areas that are at high risk of flooding. Initial or older version companion Flood Boundary and Floodway Maps ([see page 20](#)) have been replaced statewide as part of the North Carolina Floodplain Mapping Program.

Coastal Floodplains

How coastal models are created:

- Storm parameters (e.g.: wind, pressure) and bathymetry are used to develop storm surge and offshore wave heights
- Coastal transects are created using field survey and LiDAR topographic data
- Dunes, ground cover, and obstructions are entered into the transects
- Waves propagating ashore are modeled along each transect
- Flood hazard zones (VE/AE and base water elevation) are determined along each transect
- Flood hazard zones are interpolated between the transects
- The flood levels are intersected with the ground topography to determine the limits of flooding

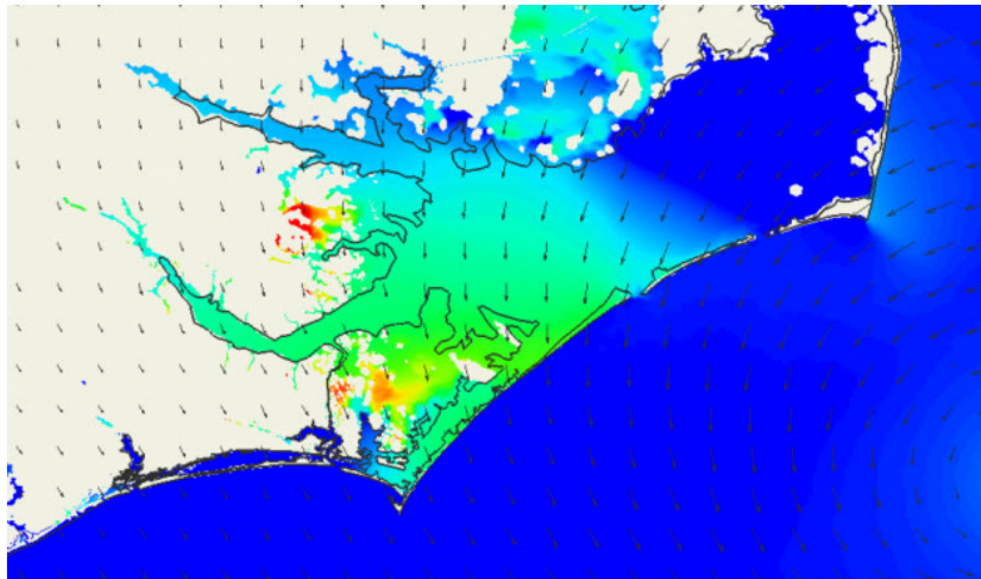

Understanding the Coastal Floodplain

Coastal storms with waves and storm surges can quickly erode beaches, dunes, and banks and threaten homes and properties. When designing, siting, and reviewing projects on the coast, it is therefore important to evaluate the potential for dangerous storm-generated wave action and flooding.

The graphic to the right shows a cross-sectional diagram of flood zones on a gently sloping ground profile with no wave run-up. **The Limit of Moderate Wave Action (LiMWA)** marks the landward limit of the **Moderate Wave Action (MoWA)** area, where wave heights are between 1.5 and 3.0 feet. Landward of the MoWA and the LiMWA boundary is the **Minimal Wave Action (MiWA)** area, where wave heights are less than 1.5 feet.

A **Primary Frontal Dune (PFD)** is defined by the NFIP as a continuous or nearly continuous mound or ridge of sand with relatively steep seaward and landward slopes immediately landward of and adjacent to the beach. PFDs are subject to erosion and may be vulnerable to overtopping or breaching from high water levels and waves during coastal storms. The NFIP recognizes the importance of dunes in reducing coastal flood hazards and has established special mapping, insurance, and floodplain management criteria designed to help communities protect the dunes.

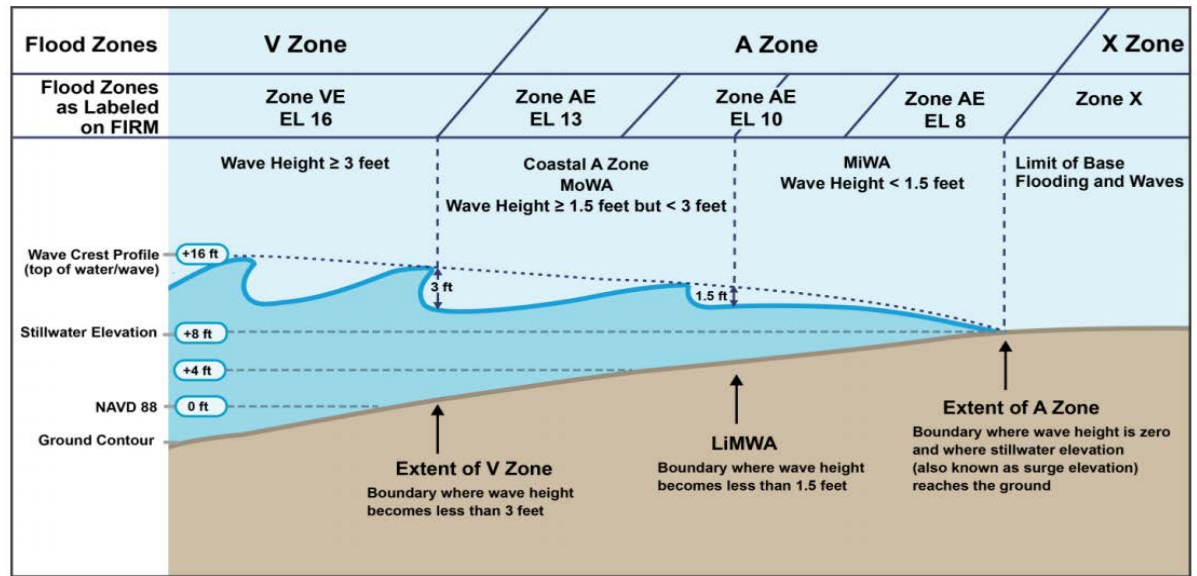

Coastal Areas: Flood Insurance Rate Map

Low-lying coastal areas are especially vulnerable to damage from erosion, waves, and storm surge. The National Flood Insurance Program (NFIP) depicts two coastal flood hazard zones on its Flood Insurance Rate Maps (FIRMs):

- **Zone VE**, where the flood elevation includes wave heights equal to or greater than 3 feet; and
- **Zone AE**, where the flood elevation includes wave heights less than 3 feet

The Limit of Moderate Wave Action (LiMWA) is the inland limit of the area expected to receive 1.5 foot or greater breaking waves during the 100-year, or 1%-annual-chance, flood event. While not formally defined in the NFIP regulations or mapped as a flood zone, the area between Zone VE and the LiMWA is called the Coastal A Zone. This area is subject to flood hazards associated with floating debris and high-velocity flow associated with waves and debris that can erode and scour building foundations and, in extreme cases, cause foundation failure.

- **Zone AE** is subject to flooding by the base or 1%-annual-chance (100-year) flood and waves less than 3 feet high (formerly called Zones A1-A30). These areas are shown as blue on the NC FRIS website
- **Unshaded Zone X** is the area of minimal flood risk outside the 500-year floodplain, formerly called Zone C. These areas are unshaded on the NC FRIS website
- **Shaded Zone X** is subject to flooding by the 0.2%-annual-chance (500-year) flood, formerly called Zone B. These areas are shown as yellow on the NC FRIS website
- **Zone VE** is where wave heights are expected to be 3 feet or more. These areas are shown as blue on the NC FRIS website

Additional resources regarding coastal zones and coastal construction:

- www.fema.gov/media-library/assets/videos/82399
- FEMA P-499, Home Builder's Guide to Coastal Construction: www.fema.gov/media-library/assets/documents/6131; and related fact sheet (Category 3): www.fema.gov/home-builders-guide-coastal-construction-technical-fact-sheet-series-fema-p-499

Coastal Area Management Act (CAMA) Permits

The North Carolina Coastal Resources Commission established four categories of “Areas of Environmental Concern”: (1) the Estuarine and Ocean System; (2) the Ocean Hazard System (includes V Zones shown on FIRMs); (3) Public Water Supplies; and (4) Natural and Cultural Resource Areas.

CAMA permits are required for development activities proposed in Areas of Environmental Concern found in the state’s 20 coastal counties. Certain activities are exempt, including some types of minor maintenance and improvements as well as accessory buildings usually found with existing structures, if no filling of estuarine or navigable waters or coastal marshland is involved.

There are three types of CAMA permits:

- **Minor Permits**, which are used for projects—such as single-family houses—that do not require major permits or general permits; minor permits are handled by local governments under contract with the state
- **General Permits**, which are used for routine projects that usually pose little or no threat to the environment
- **Major Permits**, which are reviewed by 10 state and four federal agencies

CAMA is administered by the Department of Environment and Natural Resources. Download the CAMA Handbook for Development in Coastal North Carolina and other resources at portal.ncdenr.org/web/cm. Contact a district office to obtain a permit application and to determine if your proposed activity is exempt.

All coastal development projects subject to CAMA must be approved by the North Carolina Division of Coastal Management. Depending on the type of development, permit applications must adhere to applicable local, state, and federal agency requirements including NFIP and FEMA.



Typical Elevation Methods for Coastal Buildings

In coastal V Zones, design specifications will be determined by your architect or engineer based on the proposed site, how your building will be elevated, and how deep in the ground the foundation elements will extend. Your community will require certified or sealed building designs and plans.

- FEMA P-550, Recommended Residential Construction for Coastal Areas: Building on Strong and Safe Foundations: www.fema.gov/media-library/assets/documents/3972
- FEMA P-499, Home Builder's Guide to Coastal Construction: www.fema.gov/media-library/assets/documents/6131
- FEMA P-55, Coastal Construction Manual: Principles and Practices of Planning, Siting, Designing, Constructing, and Maintaining Residential Buildings in Coastal Areas: www.fema.gov/media-library/assets/documents/3293

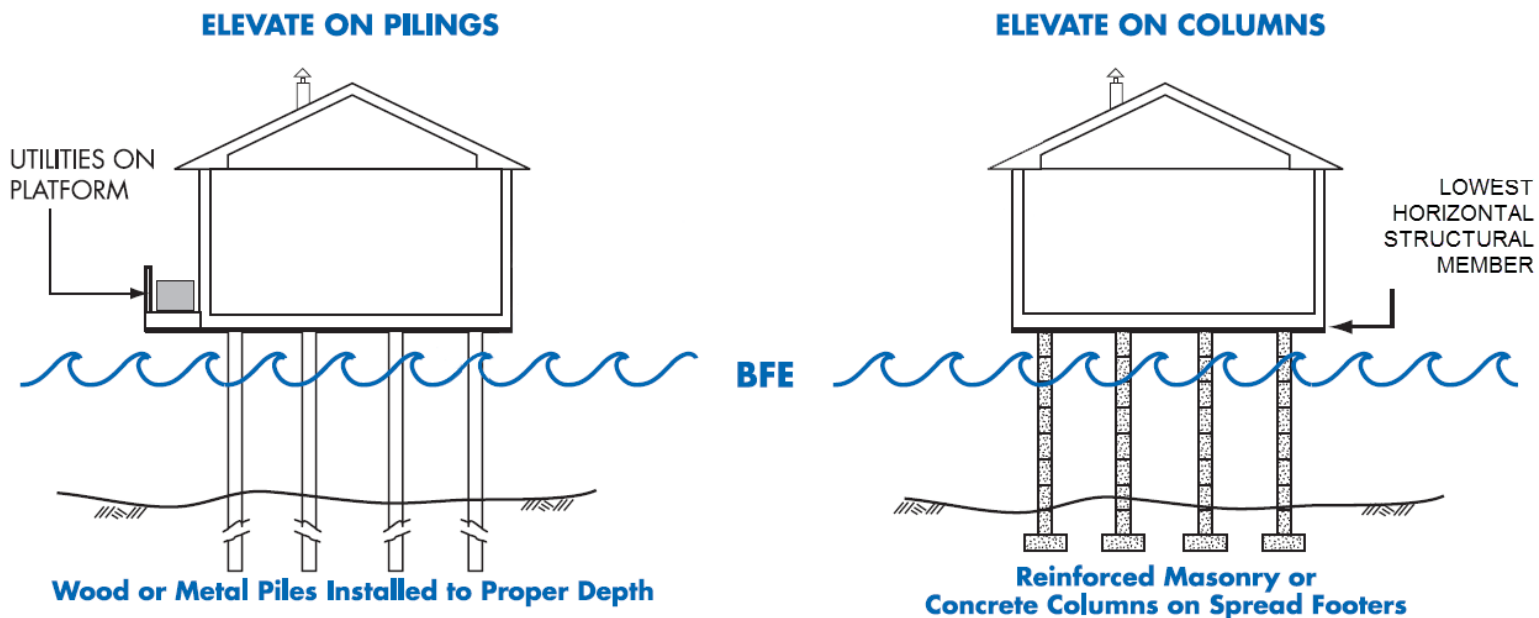

Wind and Water Requirements for Coastal Houses

Coastal buildings may be exposed to high winds, waves, and floodwater so they can withstand high winds and storm surge.

Examples of construction design specified by an architect or engineer include clips and straps to keep the roof and building connected to the foundation.

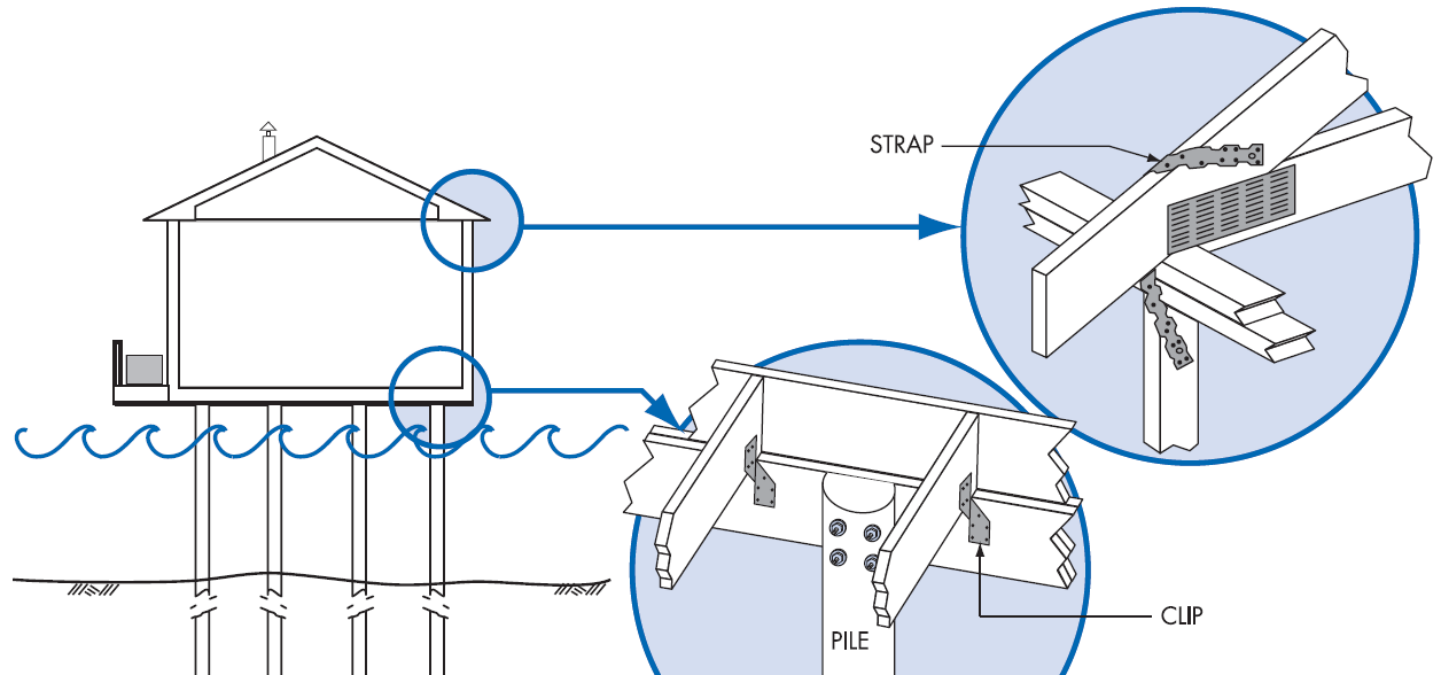

Additional Resources:

- FEMA P-550, Recommended Residential Construction for Coastal Areas: Building on Strong and Safe Foundations: www.fema.gov/media-library/assets/documents/3972
- FEMA P-55, Coastal Construction Manual: Principles and Practices of Planning, Siting, Designing, Constructing, and Maintaining Residential Buildings in Coastal Areas: www.fema.gov/media-library/assets/documents/3293

Enclosures Below V Zone Buildings

Avoid building an enclosure under your V Zone building. If you must enclose a small area your community will require construction standards to include:

- Walls must be designed to collapse or “breakaway” under storm and flood conditions
- Must be unfinished and use flood-resistant materials
- Utility wires and pipes should not go through or be attached to the breakaway walls
- Enclosed area is to be used only for parking, building access, or limited storage
- No bathrooms, utility rooms, or electric service below BFE
- Enclosures below an elevated V Zone building (or any zone for that matter) may not be more than 300 square feet. Enclosures are a violation of your community’s NFIP floodplain regulations, may cause increased damage when it floods, and will substantially increase your flood insurance premiums

Additional Resources:

- FEMA’s Technical Bulletin 5, Free-of-Obstruction Requirements: www.fema.gov/media-library/assets/documents/3490
- FEMA’s Technical Bulletin 9, Design and Construction Guidance for Breakaway Walls Below Elevated Coastal Buildings: www.fema.gov/media-library/assets/documents/3514
- FEMA P-499, Home Builder’s Guide to Coastal Construction: www.fema.gov/media-library/assets/documents/6131; and related fact sheet (Category 8.1): www.fema.gov/home-builders-guide-coastal-construction-technical-fact-sheet-series-fema-p-499

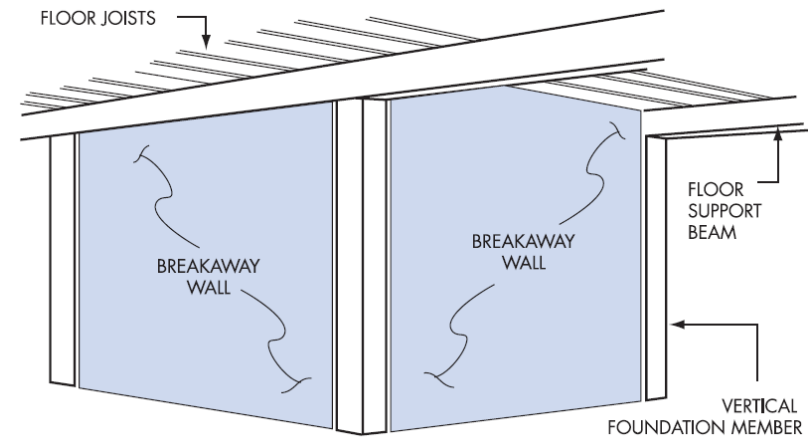

State of North Carolina V Zone Certification

V-ZONE CERTIFICATION				
Owner's Name			Policy Number	
Structure Address or Other Description				
City, State, & Zip Code				
SECTION I: FLOOD INSURANCE RATE MAP (FIRM) INFORMATION				
1. Community Number	2. Panel Number	3. Suffix	4. Date of FIRM Index	5. FIRM Zone
SECTION II: ELEVATION INFORMATION				
1. Elevation of the Bottom of Lowest Horizontal Structure Member ...	_____	feet	<i>This form is not a substitute for an Elevation Certificate. Elevations should be rounded to the nearest tenth of a foot in NAVD 1988 vertical datum.</i>	
2. Base Flood Elevation (BFE).....	_____	feet		
3. Design Flood Elevation (BFE plus Freeboard).....	_____	feet		
4. Elevation of Lowest Adjacent Grade	_____	feet		

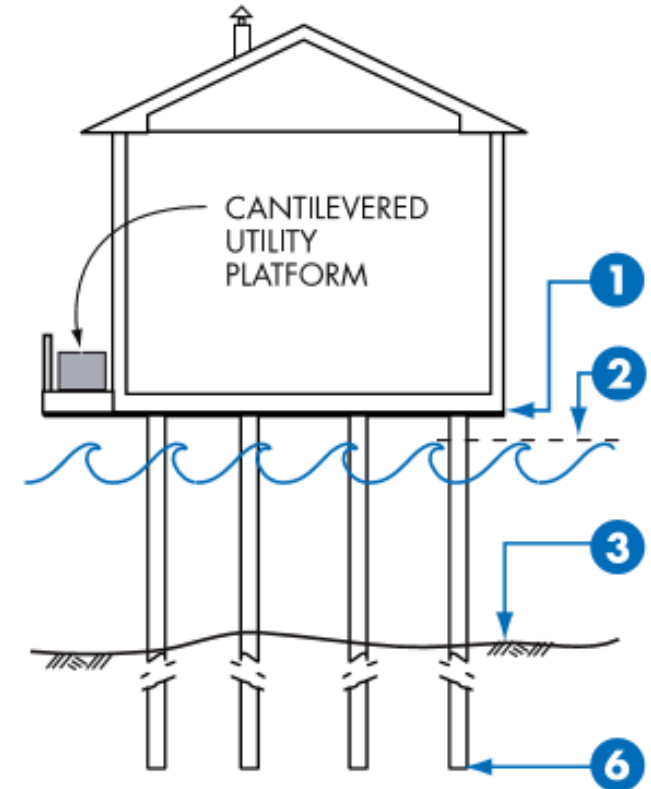

A Registered Professional Engineer or Architect must review or prepare your building design and provide a signed and sealed statement that the design meets minimum design and construction requirements. You will also need to submit an “as built” Elevation Certificate when construction is finished.

Resource: *Coastal Construction Manual (FEMA 55CD)*. Revised in 2011, this interactive CD is a useful tool for engineers and architects who design buildings in V zones.

Additional Resources:

- V Zone Design Certificate: https://www.fema.gov/media-library-data/20130726-1538-20490-4065/fema499_1_5.pdf

Flood Insurance: Property Owner's Best Protection

Did you know? Typical homeowners' insurance policies do not provide coverage against flood losses. Federally backed flood insurance through the National Flood Insurance Program is made available to homeowners, renters, and business owners in communities that participate in the NFIP. Nationwide, North Carolina ranks eighth in the number of NFIP policies and ninth in the number of claims to date.

Who needs flood insurance? EVERYONE. Federal flood insurance is required for all buildings in mapped Special Flood Hazard Areas (SFHAs) shown on FEMA flood maps if secured by federally backed loans or mortgages. All homeowners, business owners, and renters in communities that participate in the NFIP may purchase federal flood insurance on any building and its contents even if outside of the mapped high-risk flood zone. If your home is in the mapped SFHA, you are five times more likely to be damaged by flood than by a major fire.

Not in a mapped floodplain? Unfortunately, it's often after a flood that many people discover that their home or business property insurance does NOT cover flood damage. Over 25% of all flood damage occurs in low-risk zones, commonly described as being "outside the mapped flood zone."

Protected by a levee or dam? Even if you live in an area protected by levees or other flood control structures, there is a residual risk that those structures will be overtopped or fail. If your community's levee provides "1%-annual-chance" flood protection, there is still a possibility that a more severe event will cause flooding.



Flood Insurance: Property Owner's Best Protection, Continued

The NFIP and North Carolina's Association of Floodplain Managers urge you to protect your family and your financial future by purchasing a flood insurance policy. Being prepared by having flood insurance will save you money. For a \$50,000 loan at 4% interest, for example, you will pay around \$3,000 per year for 30 years. Compare that to a \$100,000 flood insurance premium, which is about \$700 per year. If your property is in a low-risk zone, your premium may be low and could include coverage for your property's contents. To purchase a policy, call your property insurance agent. To find an insurance agent near you, call NFIP's toll-free number at (888) 356-6329 or visit www.FloodSmart.gov.

What about disaster grants and loans? Federal disaster grants do not cover most losses, and repayment of a disaster loan can cost many times more than the price of a flood insurance policy. If you have a flooding disaster, contact your local engineering and planning department to learn more about eligibility requirements associated with FEMA's Hazard Mitigation Grant Program (HMGP) and options for mitigating flood risk to your property.



Factors that Affect Flood Insurance Rates

What is a flood? For a general understanding of factors affecting how NFIP flood insurance rating works, it is helpful to describe what the term “flood” means relative to rating. For purposes of the NFIP program, FEMA defines a **flood** as a general and temporary condition where two or more acres of normally dry land, or two or more properties, are inundated by water or mudflow. Floods are the most common natural disaster in the United States. And you don’t need to live on the coast to be at risk. Flash floods, inland flooding, and seasonal storms affect every region of the country, severely damaging homes and businesses. Flood risk is based on many factors, both natural and man-made. These include, but are not limited to:

- Current weather patterns
- Natural changes in the environment
- Recent development in your community
- Date of construction
- History of flooding
- Flood map changes

Flood risks change over time. When flood maps are updated, you might learn that your property’s risk is higher or lower than before. This can affect flood insurance costs and lender requirements for insurance. Where new flood maps show your property to now be at a high flood risk, most mortgage lenders will require flood insurance. The NFIP has cost-saving rating options to help reduce the financial impact. Where new maps show that your property is no longer at high risk, flood insurance is no longer required for federally backed mortgages. Keep in mind though that many lenders may still require you to obtain flood insurance. This is because nature doesn’t follow flood map boundaries, and, while the flood risk may be reduced, it is not removed. The good news is that insurance rates may be lower. The maps are first issued in “preliminary” form for public viewing. Once approved, they become effective six to twelve months later. This gives residents time to prepare for any change in risk and talk to an insurance agent to learn ways to save on flood insurance.

Learning More About Floodplain Management

- For advice on flood information and permits, call your community's building permit office, engineering or planning department
- View or download digital flood data and learn about the North Carolina Floodplain Mapping Program at www.ncfloodmaps.com
- To view maps online, visit the FEMA Flood Map Service Center online at msc.fema.gov/portal
- FEMA's online publications can be found at www.fema.gov/resource-document-library. Search by key word, title, or publication number. Call (800) 480-2520 to order free printed copies
- For information pertaining to flood maps, general flood insurance questions, or disaster assistance, call FEMA's Flood Information Exchange at (800) 358-9616
- Find online Elevation Certificate training for surveyors by going to www.fema.gov and searching for "Elevation Certificate"
- The NFIP's Community Rating System Resource Center is online at www.fema.gov/national-flood-insurance-program-community-rating-system
- Download North Carolina's "Safer Development in Floodprone Areas," a guidebook for communities interested in adopting higher development standards, at www.ncfloodmaps.com/floodprone_areas_guide.htm
- Find out about floodplain management conferences and training workshops at www.ncafp.org

The North Carolina Floodplain Mapping Program (NCFMP) website is at www.ncfloodmaps.com. The site provides important information about the NCFMP including contact information for state program managers. Click on "NCFMP Program Information" for a series of fact sheets, including frequently asked questions and information about how map changes affect flood insurance.

Learning More About Flood Insurance

- Consumer information about flood insurance, flood risks, and flood maps is online at www.FloodSmart.gov. Click on “Insurance Center” to learn more about estimating the cost of a policy, finding an agent, purchasing a policy, coverage limits and exclusions, filing claims, and other topics.
- At www.FloodSmart.gov, click on “NFIP Resources” then “Flood Hazard Maps” to learn more about flood maps.
- Also at www.FloodSmart.gov, click on “Know the Facts” to view “Fast Facts,” frequently asked questions, and a library of articles and brochures.
- To obtain an NFIP flood insurance policy, call your insurance agent. Most insurance companies can write an NFIP policy for you. If you need more help, you can call the National Flood Insurance Program’s toll-free number to get the name of an agent in your area who writes flood insurance: (888) 356-6329.
- To find out how many NFIP flood insurance policies are in force in your community, or how many claims have been paid since 1978, go to www.fema.gov/national-flood-insurance-program and click on “Statistics” on the left-hand column.