

Released Form

**North Carolina
READY End-of-Grade
Assessment
Mathematics**

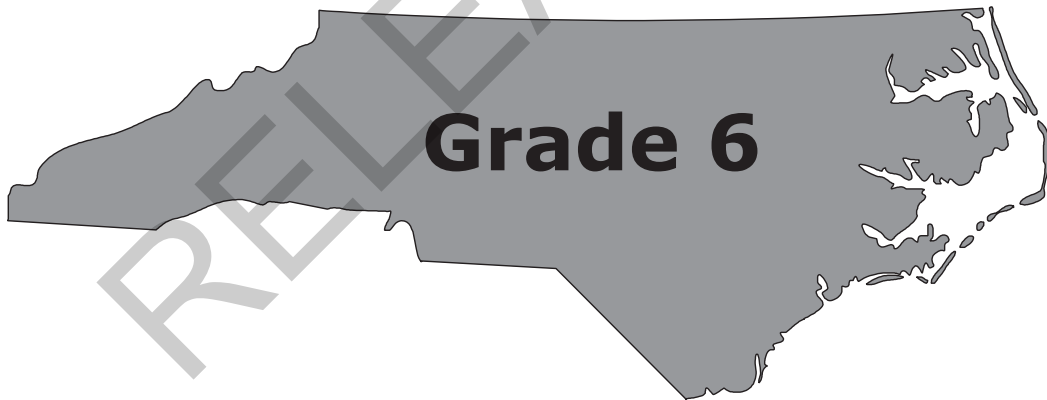

Student Booklet



Academic Services and Instructional Support
Division of Accountability Services



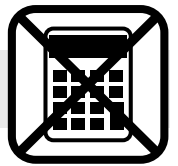

Sample Questions

S1 Kerry walks 3 miles each day. How far will she walk in 7 days?

- A 10 miles
- B 14 miles
- C 21 miles
- D 24 miles

S2 What number is represented by point P on the number line below?

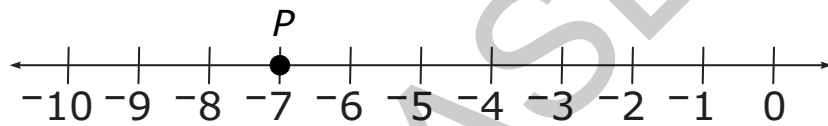

S3 What fraction of the circle is shaded?

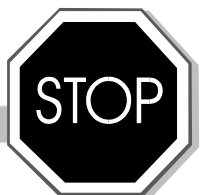
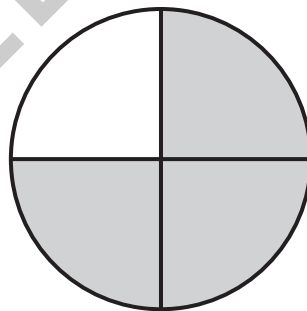

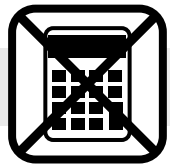

- 1 Joe will go to the swimming pool on 20 different days this month.
- A one-day pass to the pool is \$2.25.
 - A monthly pass to the pool is \$30.00.

How much money will Joe save by buying a monthly pass?

- A \$20
- B \$18
- C \$15
- D \$12
- 2 A rectangular parking lot has an area of $\frac{2}{3}$ of a square kilometer. The width is $\frac{1}{2}$ of a kilometer. What is the length, in kilometers, of the parking lot?
- A $\frac{1}{3}$
- B $\frac{2}{3}$
- C $1\frac{1}{3}$
- D $1\frac{2}{3}$

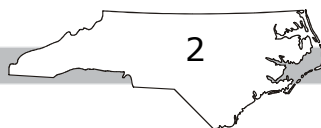

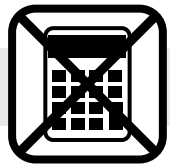

3 The price of a theater ticket increased from \$7.50 to \$7.75. The theater sold 315 tickets at the higher price. With the price increase, how much more did the theater earn on the tickets?

- A \$78.00
- B \$78.25
- C \$78.50
- D \$78.75

4 Hannah babysits to earn money.

- She charges \$6.50 to babysit for the first hour.
- She charges \$5.75 for each additional hour.
- Let n equal the number of hours after the first hour.

Which expression represents how much Hannah charges?

- A $12.25n$
- B $6.50 + 5.75n$
- C $6.50n + 5.75$
- D $6.50n + 5.75n$



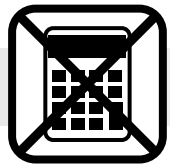

5 What is the value of $\left(\frac{1}{7}\right)^3$?

- A $\frac{3}{7}$
- B $\frac{1}{7}$
- C $\frac{3}{343}$
- D $\frac{1}{343}$

6 Which choice shows a set of data that could be represented by the box plot shown below?

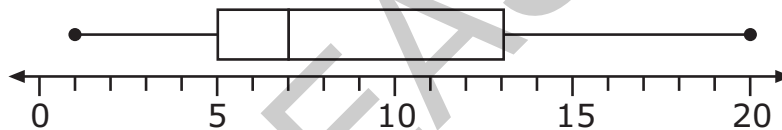

- A 1, 3, 5, 6, 7, 7, 8, 13, 19, 20
- B 1, 3, 5, 6, 6, 8, 13, 14, 19, 20
- C 1, 2, 3, 5, 7, 8, 8, 13, 19, 20
- D 1, 5, 5, 6, 6, 6, 8, 13, 19, 20



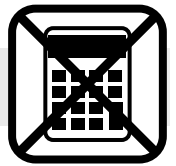

Questions 7 through 15 require you to write your answers in the boxes provided on your answer sheet. Write only one number or symbol in each box and fill in the circle in each column that matches what you have printed. Fill in only one circle in each column.

- 7 A recipe requires $\frac{1}{4}$ lb of onions to make 3 servings of soup. Mark has $1\frac{1}{2}$ lb of onions. How many servings can Mark make?
- 8 A rectangular room has an area of $131\frac{1}{4}$ square feet. The length of the room is $12\frac{1}{2}$ feet. What is the width, in feet, of the room?
- 9 Allen is building birdhouses that require $\frac{1}{2}$ -ft-long boards. How many pieces that are exactly $\frac{1}{2}$ ft long can be made from a board that is $8\frac{1}{4}$ ft long?

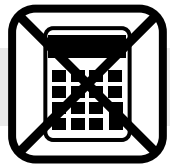

- 10 How much money should John get back when he uses \$10.00 to pay for purchases totaling \$5.25?

Express the answer as dollars.cents.

- 11 What is the product of 2.52 and 3.4?

- 12 At a store, Susan selected a pumpkin that weighed 35.2 ounces.

- Pumpkins cost \$1.80 per pound.
- There are 16 ounces in 1 pound.

How much did Susan's pumpkin cost?

Express the answer as dollars.cents.

RELEASED



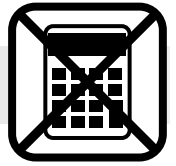

- 13 What is the greatest whole number that is less than $\left(\frac{5}{2}\right)^3 \div \left(\frac{3}{4}\right)^2$?
- 14 What is the value of $\frac{1}{3}x^2 + 2$, when $x = 3$?
- 15 Heather earns \$8.00 per hour for walking a dog. How many hours must she work to earn \$256.00?

RELEASED



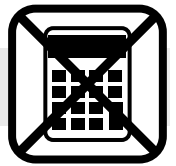

This is the end of the calculator inactive test questions.

Directions:

- 1. Look back over your answers for the calculator inactive questions. You will not be able to go back and work on these questions once you are given a calculator.**
- 2. Raise your hand to let your teacher know you are ready to begin the calculator active test questions.**
- 3. Do not begin work on the calculator active test questions until your teacher has given you a calculator.**

RELEASED





- 16 One serving of Mike’s crackers has 150 calories and a mass of 30 grams. How many calories are in 6 grams of the crackers?
- A 5
 B 10
 C 25
 D 30
- 17 The ratio of nitrogen to potassium in a sample of soil is 12:9. The sample has 36 units of nitrogen. How much potassium does the sample have?
- A 21 units
 B 27 units
 C 33 units
 D 48 units
- 18 To clean a tank, $\frac{3}{4}$ cup of disinfectant is needed for every 2 gallons of water. How many cups of disinfectant are needed for 20 gallons of water?
- A $7\frac{1}{2}$
 B 15
 C $22\frac{1}{2}$
 D 30





19 A laundry detergent is sold at four stores.

Store	Size (ounces)	Price
Hawkin’s Store	60	\$6.50
Don’s Store	54	\$5.50
Allen’s Market	48	\$5.61
Value Market	40	\$4.50

Which store has the lowest price per ounce?

- A Hawkin’s Store
- B Don’s Store
- C Allen’s Market
- D Value Market

20 Marcy is taking two types of medicine.

- She takes one medicine every 6 hours.
- She takes the other medicine every 4 hours.
- She takes both medicines at 9:00 a.m.

At what time will Marcy take both medicines together again?

- A 1:00 p.m.
- B 3:00 p.m.
- C 5:00 p.m.
- D 9:00 p.m.

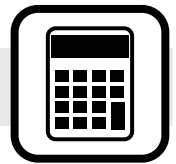

- 21 Jeff recorded the average temperatures for six months. He will display the temperatures on a number line.

Month	Temperature (°F)
December	-5
January	-16
February	-15
March	20
April	24
May	35

On the number line, which month's temperature will be between February's and March's temperatures?

- A December
 - B January
 - C April
 - D May
- 22 A trapezoid in a coordinate plane has vertices $(-2, 5)$, $(-3, -2)$, $(2, -2)$, and $(1, 5)$. What is the height of the trapezoid?
- A 3 units
 - B 5 units
 - C 7 units
 - D 9 units

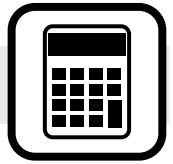

- 23 Which can be represented by the expression $17 - 2x$?
- A 17 less than twice a number x
 - B the difference between 17 and twice a number x
 - C a number x squared, subtracted from 17
 - D 17 less than a number x squared
- 24 Which expression is equivalent to $5y + 2y + 6x + 2y - x$?
- A $5x + 6y$
 - B $5x + 7y$
 - C $5x + 9y$
 - D $7x + 7y$
- 25 Diana can use the equation $y = 7x$ to calculate her pay, where y represents the amount of pay, and x represents the number of hours worked. How many hours did Diana work if she was paid \$45.50?
- A 5.5 hours
 - B 6 hours
 - C 6.5 hours
 - D 7 hours

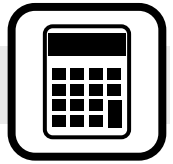

- 26 If $y - 18 = 14$, what is the value of $3(y + 5)$?
- A 27
 - B 32
 - C 96
 - D 111

- 27 Karen recorded her walking pace in the table below. What equation **best** represents this relationship?

Hours Walked (h)	Miles Walked (m)
2.5	8.75
4	14

- A $h = m + 10$
- B $h = 3.5m$
- C $m = h + 10$
- D $m = 3.5h$

RELEASED



28 The shaded area indicates the parking lot at a shopping center.

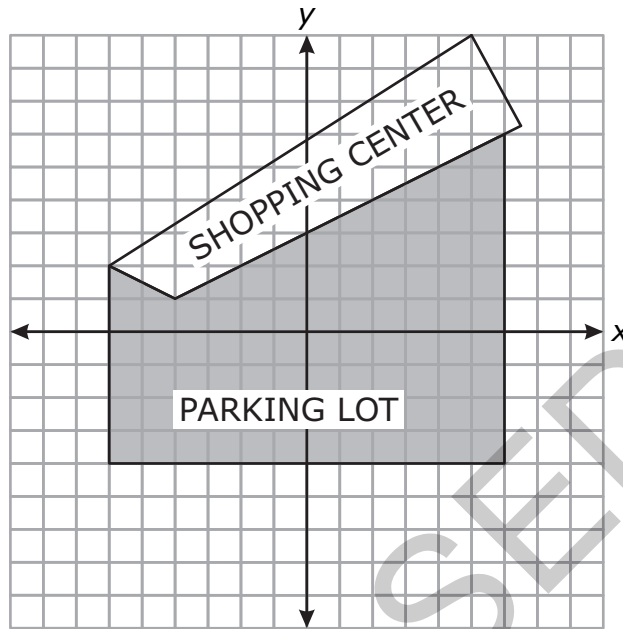

What is the total area of the parking lot?

- A 72 units²
- B 86 units²
- C 91 units²
- D 120 units²

RELEASED

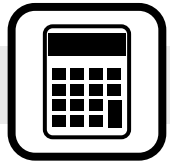

- 29 The right rectangular prism below is made up of 8 cubes. Each cube has an edge length of $\frac{1}{2}$ inch.

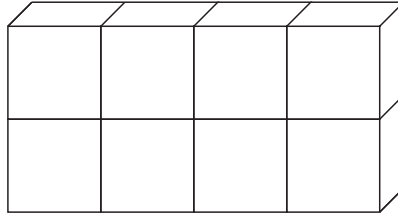

What is the volume of this prism?

- A 1 cubic inch
 - B 2 cubic inches
 - C 4 cubic inches
 - D 8 cubic inches
- 30 What is the area of the quadrilateral with vertices at $(-1, 0)$, $(2, 0)$, $(2, 5)$, and $(-1, 5)$?
- A 15 square units
 - B 12 square units
 - C 10 square units
 - D 5 square units

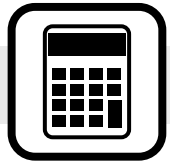

31 The net of a triangular right prism is shown below.

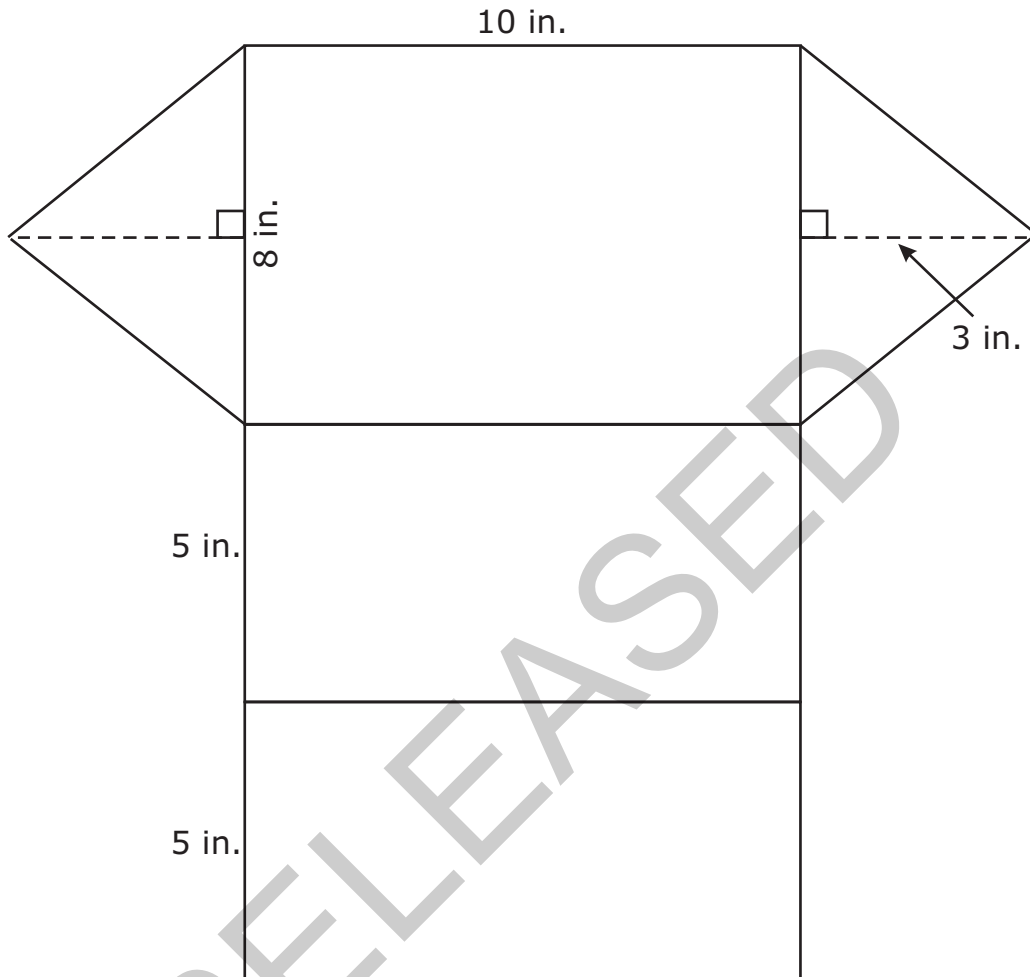

What is the surface area of the prism?

- A 204 in.²
- B 228 in.²
- C 240 in.²
- D 288 in.²



32 The data below represents the numbers of books that twelve students read.

2, 4, 7, 8, 9, 12, 14, 18, 19, 21, 30, 32

Which box plot correctly summarizes the data?

A

Numbers of Books

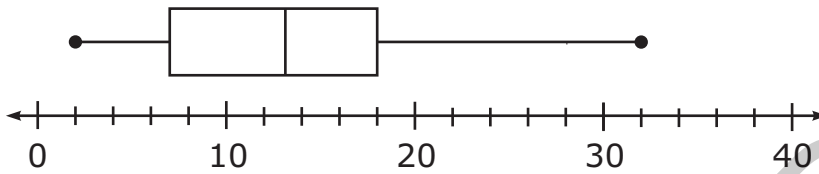

B

Numbers of Books

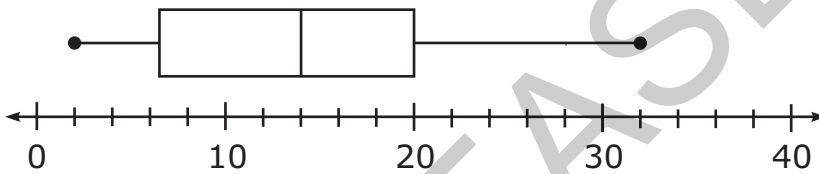

C

Numbers of Books

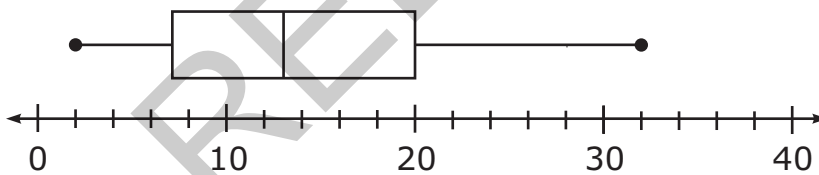

D

Numbers of Books

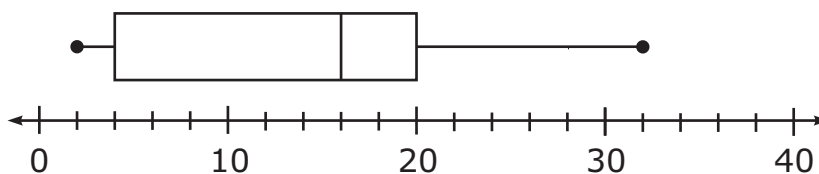

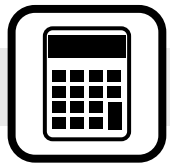

33 Which box plot represents a set of data with the largest interquartile range?

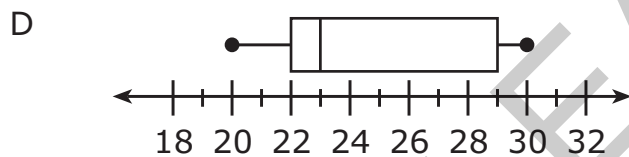
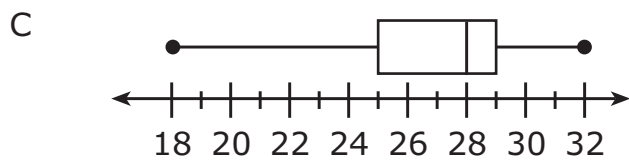
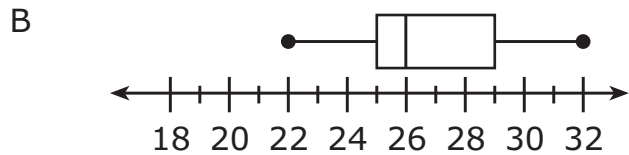
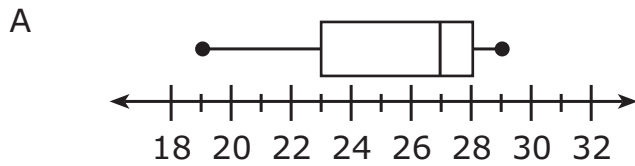

34 A company that makes boxes finds that 3 out of 20 boxes are damaged. What percent of the boxes are damaged?

- A 12%
- B 15%
- C 25%
- D 34%

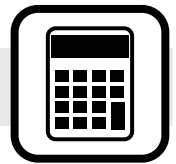

35 Jack drew a number line on his paper.



Jack drew a new point 45% of the distance from point *E* to point *J*. Between which two letters does the new point lie?

- A *G* and *H*
- B *I* and *J*
- C *F* and *G*
- D *H* and *I*

36 Valerie is 64 inches tall. **About** how many centimeters tall is Valerie? (1 inch \approx 2.5 centimeters)

- A 25.6
- B 30.6
- C 160
- D 180

37 Which point on the number line represents the number $-4\frac{1}{2}$?

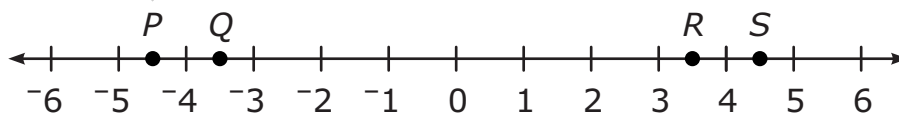

- A *P*
- B *Q*
- C *R*
- D *S*

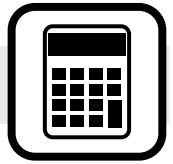

38 This table shows the number of miles four friends travel to get to school.

Student	Distance to School (miles)
Andie	$1\frac{3}{8}$
Helen	$1\frac{2}{3}$
Michelle	$1\frac{5}{9}$
Troy	$1\frac{4}{9}$

Who travels the greatest distance to school?

- A Andie
- B Helen
- C Michelle
- D Troy

39 In the coordinate plane, what is the distance between $(-3, 5)$ and $(-3, -8)$?

- A 3 units
- B 6 units
- C 8 units
- D 13 units

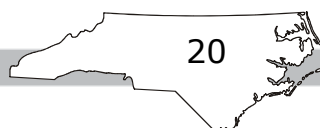



40 Which choice is equivalent to the expression $4(x + 2y)$?

- A $4x + 8y$
- B $4x + 2y$
- C $x + 8y$
- D $8xy$

41 Which expression represents the perimeter of the triangle?

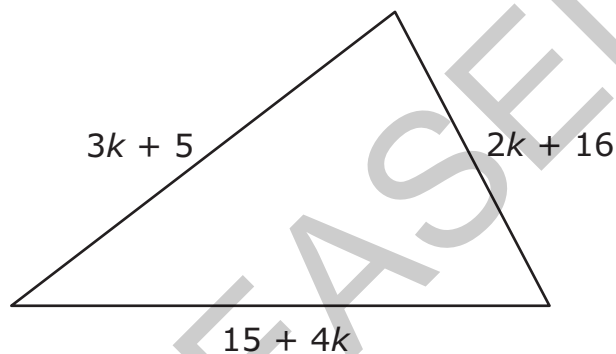

- A $9k + 36$
- B $10k + 25$
- C $20k + 25$
- D $24k + 36$

42 The length of a rectangle is 6 units longer than the width, w . Which choice is a correct expression for the perimeter of the rectangle?

- A $2w + 6$
- B $2w + 12$
- C $4w + 6$
- D $4w + 12$



43 Jane wants to visit her sister.

- Her car travels x miles per gallon of gas.
- She will travel 1,000 miles to her sister’s house.
- Gas costs \$3.50 per gallon.

Which expression shows how much Jane will spend for gas on the trip to her sister’s house?

A $1,000(3.50x)$

B $3.50\left(\frac{1,000}{x}\right)$

C $3.50\left(\frac{x}{1,000}\right)$

D $1,000\left(\frac{1}{3.50x}\right)$

44 Suppose that a stove and a freezer together weigh at least 370 pounds. The weight of the stove is 170 pounds. Which inequality correctly describes these conditions for the weight of the freezer, f ?

A $f \geq 200$

B $f > 200$

C $f \leq 200$

D $f < 200$

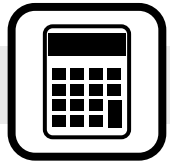

45 The Wilsons want to put outdoor carpet on their porch.

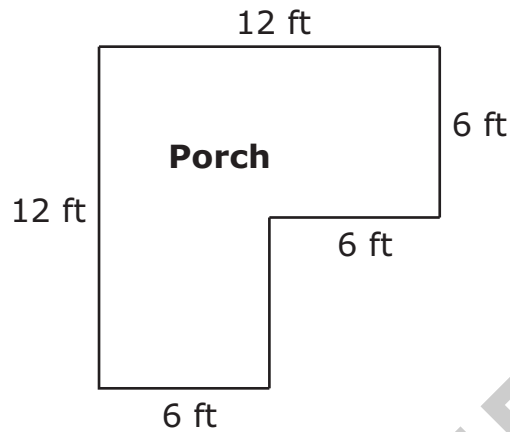

How much carpet will be needed for their porch?

- A 42 ft²
- B 72 ft²
- C 108 ft²
- D 144 ft²

RELEASED

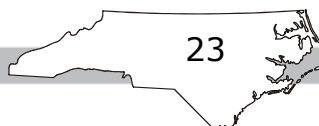

Go to the next page.

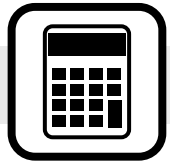

46 What is the volume of the right rectangular prism below?

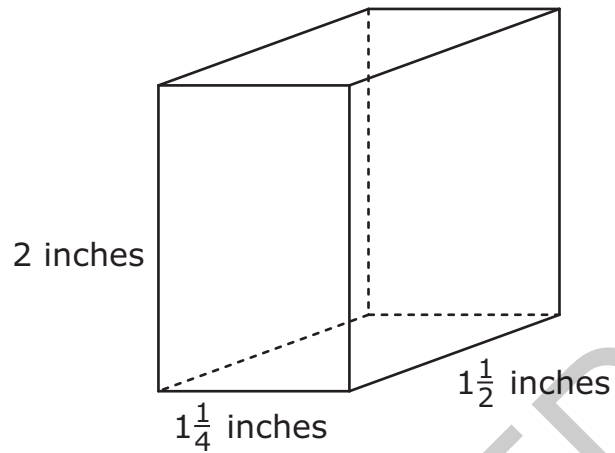

- A $4\frac{3}{4}$ cubic inches
- B $4\frac{1}{8}$ cubic inches
- C $3\frac{3}{4}$ cubic inches
- D $2\frac{1}{8}$ cubic inches

RELEASED

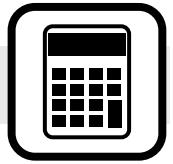

47 In the graph below, each grid square represents one square yard.

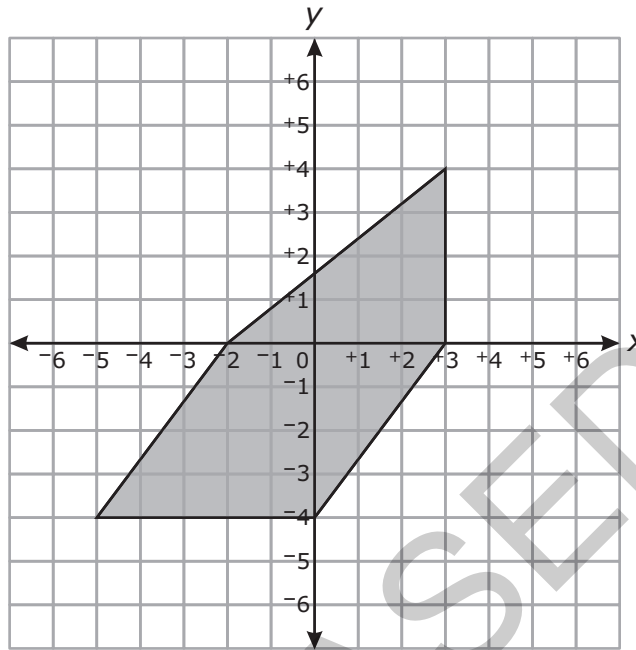

What is the area of the shaded figure?

- A 20 yd²
- B 30 yd²
- C 36 yd²
- D 40 yd²

RELEASED

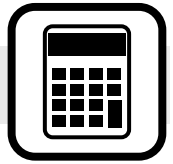

- 48 Abby is making a decoration. When folded, the decoration is a triangular pyramid made of four congruent equilateral triangles. **Approximately**, what is the surface area of Abby's decoration?

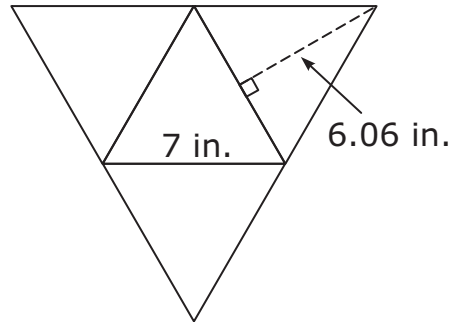

- A 64 in.²
 B 85 in.²
 C 97 in.²
 D 170 in.²
- 49 Katherine earned 84, 92, 84, 75, and 70 on her first 5 tests. What is the minimum grade Katherine needs to earn on the next test to have a mean of 84?
- A 81
 B 84
 C 95
 D 99

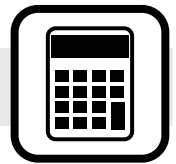

- 50 The weather station recorded the high temperature each day for 30 days. The graph of the temperature data is shown below.

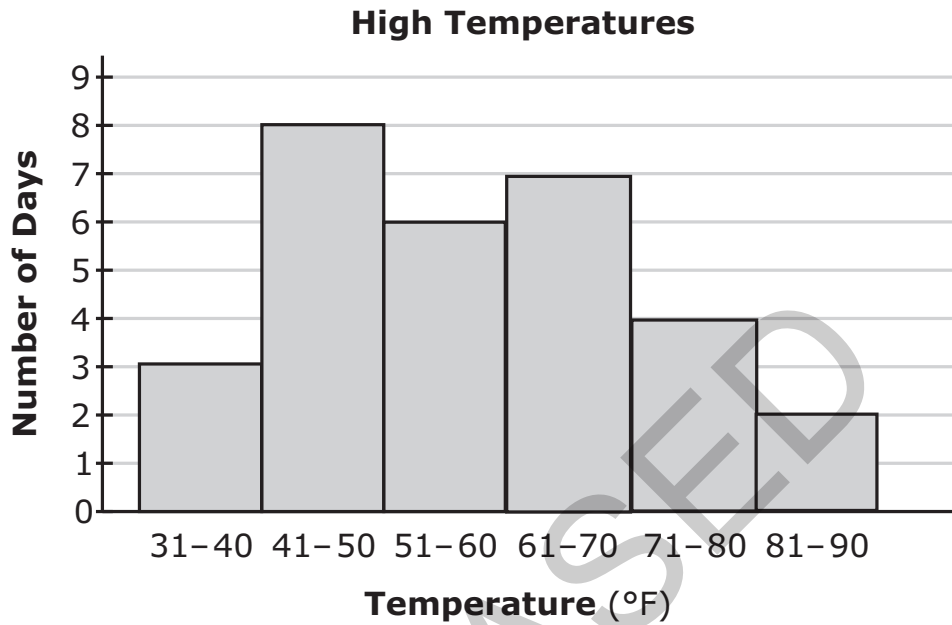

In which interval is the median temperature?

- A 41-50
- B 51-60
- C 61-70
- D 71-80

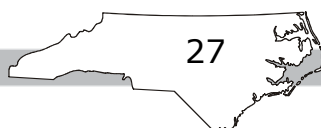

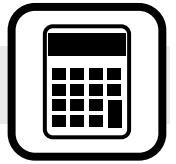

Directions:

This is the end of the mathematics test.

- 1. Put all of your papers inside your test book and close your test book.**
- 2. Place your calculator on top of the test book.**
- 3. Stay quietly in your seat until your teacher tells you that testing is finished.**

RELEASED

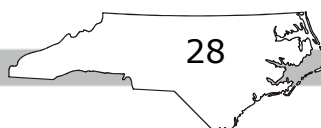

GRADE 6 MATH—RELEASED FORM

Grade 6 Math RELEASED Form 2012–2013 Answer Key

Item Number	Type	Key	Domain
S1	MC	C	
S2	GR	-7	
S3	GR	$\frac{3}{4}$ or .75	

Calculator Inactive



Item Number	Type	Key	Domain
1	MC	C	NS — The Number System
2	MC	C	NS — The Number System
3	MC	D	NS — The Number System
4	MC	B	EE — Expressions and Equations
5	MC	D	EE — Expressions and Equations
6	MC	A	SP — Statistics and Probability
7	GR	18	NS — The Number System
8	GR	10.5	NS — The Number System
9	GR	16	NS — The Number System
10	GR	4.75	NS — The Number System
11	GR	8.568	NS — The Number System
12	GR	3.96	NS — The Number System
13	GR	27	EE — Expressions and Equations
14	GR	5	EE — Expressions and Equations
15	GR	32	EE — Expressions and Equations

GRADE 6 MATH—RELEASED FORM

Calculator Active



Item Number	Type	Key	Domain
16	MC	D	RP — Ratio and Proportional Relationships
17	MC	B	RP — Ratio and Proportional Relationships
18	MC	A	RP — Ratio and Proportional Relationships
19	MC	B	RP — Ratio and Proportional Relationships
20	MC	D	NS — The Number System
21	MC	A	NS — The Number System
22	MC	C	NS — The Number System
23	MC	B	EE — Expressions and Equations
24	MC	C	EE — Expressions and Equations
25	MC	C	EE — Expressions and Equations
26	MC	D	EE — Expressions and Equations
27	MC	D	EE — Expressions and Equations
28	MC	B	G — Geometry
29	MC	A	G — Geometry
30	MC	A	G — Geometry
31	MC	A	G — Geometry
32	MC	C	SP — Statistics and Probability
33	MC	D	SP — Statistics and Probability
34	MC	B	RP — Ratio and Proportional Relationships
35	MC	A	RP — Ratio and Proportional Relationships
36	MC	C	RP — Ratio and Proportional Relationships
37	MC	A	NS — The Number System

GRADE 6 MATH—RELEASED FORM

Item Number	Type	Key	Domain
38	MC	B	NS — The Number System
39	MC	D	NS — The Number System
40	MC	A	EE — Expressions and Equations
41	MC	A	EE — Expressions and Equations
42	MC	D	EE — Expressions and Equations
43	MC	B	EE — Expressions and Equations
44	MC	A	EE — Expressions and Equations
45	MC	C	G — Geometry
46	MC	C	G — Geometry
47	MC	B	G — Geometry
48	MC	B	G — Geometry
49	MC	D	SP — Statistics and Probability
50	MC	B	SP — Statistics and Probability

Item Types:

MC = multiple choice

GR = gridded response

Links to instructions for the gridded-response items can be found on the [main accountability page](#).