

NOTE: If the fuse panel on your 500686 1969 Camaro kit ***DOES NOT*** have a sticker like the photo at the left, you have the first design harness and your instructions are listed below and follow this page.

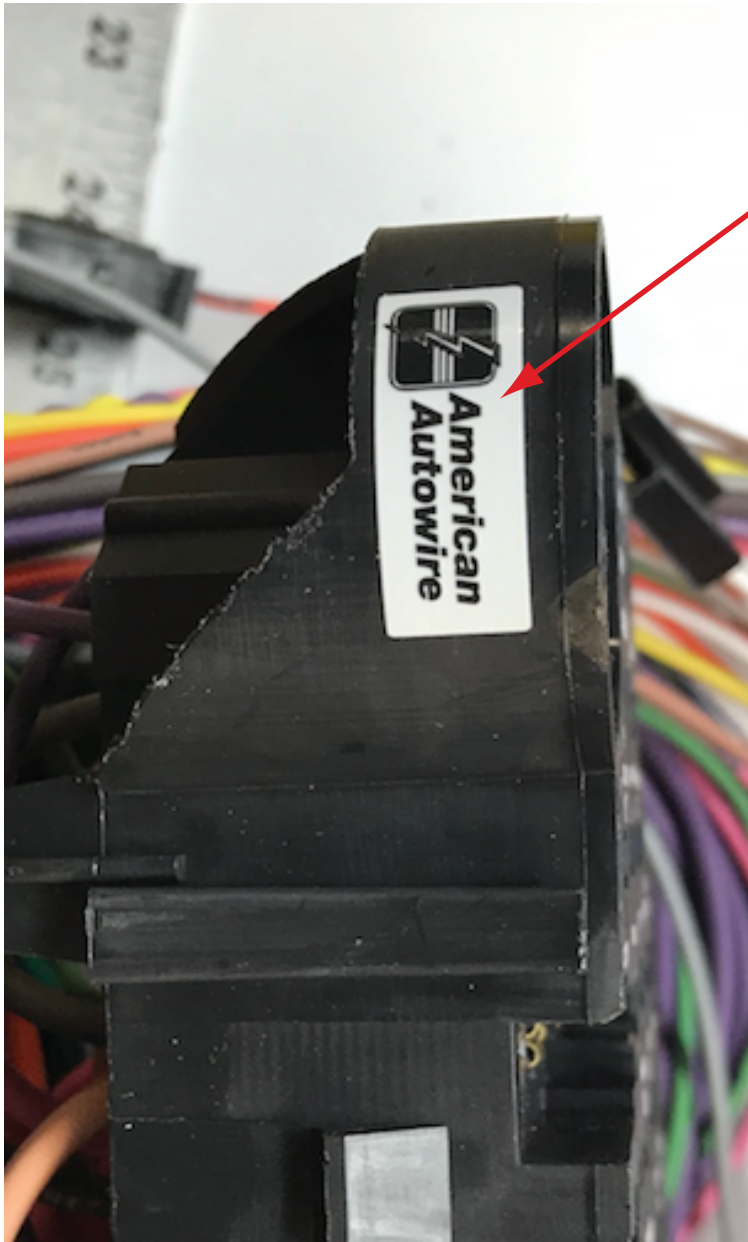

Number	Description
500332	Headlight Switch
500707	Fuse, Relay, and Flasher kit
500708	Courtesy Light kit
500919	Practice Terminal Crimping Set
500775	Dash Harness kit
500668	Engine Wiring Kit
500671	Front Light Wiring kit
500776	Instrument Cluster Wiring kit
500664	Console gauge Wiring kit
500734	Rear Body Wiring kit
500042	Floor Dimmer Switch
92966547	Kit Introduction Instruction Sheet
92970003	Warning Sheet



www.americanautowire.com 856-933-0801

1969 Camaro
First Design
Instructions

92972869 rev. 0.0 1/27/2020



WARNING:

Validate the kit contents with the component list included on page 2 of this sheet before proceeding. This kit is intended to be used in a modified vehicle. Please read this sheet thoroughly and be sure that you understand everything explained on it prior to opening any of the enclosed packages, or before attempting to install any of the components. Once this kit has been opened or a component installed, the kit is not returnable.

1. This kit should typically be used in a **MODIFIED** application only.
2. This kit supports the use of factory heater systems and aftermarket heater and A/C systems. The kit supplies power to a factory A/C control head but **DOES NOT** include the actual A/C harness for an original factory A/C vehicle. Factory original A/C harnesses are available under our Factory Fit product line as they are self contained harnesses made to fit and work with the stock A/C component configuration.
3. This kit supports the use of a high current self-exciting 1-wire alternator or other style internally regulated alternators. An adapter may be necessary in some applications. The use of a stock, low amperage alternator is seriously discouraged as they cannot handle the higher current requirements of updated ignition systems, electric fans, aftermarket A/C systems, stereo systems, air ride suspensions, and other power hungry accessories and will ultimately create performance issues with the system.
4. This kit **WILL NOT** support the use of a factory ammeter. All AAW kits are engineered to supply the optimum charge to the battery. To achieve this performance, we route our 8ga. charge wire directly from the alternator output charge terminal to the starter battery terminal. Due to the path of the charge being altered from the stock configuration, the gauge can no longer see a charge vs. a discharge, so it will not work properly. When ammeters were originally used, most generator or alternator current outputs were rated at a maximum of about 25-60 amps. Modified cars being built today typically utilize a 100 amp or higher output alternator. With these higher current units, ammeters, generally speaking, become a safety hazard. Ammeters are usually wired in parallel to the charging circuit, are typically unfused, and can short very easily causing a fire. A voltmeter is recommended as a good alternative.
5. This kit **IS NOT** set up with a resistance wire for a standard, points type ignition system. It is wired with a full 12 volt primary ignition feed that is hot in the run position. Primary ignition voltage in the starting position is handled via a full 12 volt bypass wire. Our system will support HEI, MSD, other electronic ignition systems, as well as most all computerized Fuel Injection systems. If you wish to run a points type system, there are illustrations on the engine connection pages to do so. Extra parts (ballist resistor) that are not included in this kit will be required to complete that operation.



500686

500686 - Classic Update Series Kit 1969 Chevrolet Camaro

This kit contains the following components:

<u>Bag</u>	<u>Part Number</u>	<u>Description</u>	<u>Quantity</u>
	500042	Floor Dimmer Switch	1
	500332	Headlight Switch	1
K	500664	Console Gauge wiring kit	1
J	500668	Engine Wiring Kit	1
L	500671	Front Light Wiring kit	1
	500707	Fuse, Relay, and Flasher kit	1
N	500708	Courtesy Light kit	1
M	500734	Rear Body Wiring kit	1
G	500775	Dash Harness kit	1
H	500776	Instrument Cluster wiring kit	1
	500919	Practice Terminal Crimping Set	1
	92966547	Kit Introduction Instruction Sheet	1
	92970003	Warning Sheet	1

Validate the kit contents with this component list. If there are any discrepancies with incorrect or missing parts, stop your installation and notify the supplier you purchased the kit from before proceeding.



www.americanautowire.com 856-933-0801

500686

92970003 instruction sheet Rev 0.0 2/2/2012

Classic Update Series

1969 Camaro

START HERE !

PLEASE READ THIS BEFORE STARTING INSTALLATION !

This wiring kit is designed for ease of installation. Please read the guidelines below, BEFORE STARTING your installation, to guarantee a successful job! Use an appropriate crimping tool which folds the crimp wings on the terminals as shown below. Top quality crimping tools are available from American Autowire or American Autowire authorized dealers.

NOTE: ALL TERMINALS THAT YOU INSTALL SHOULD BE PROPERLY SOLDERED.

Our factory terminations are installed by GM approved termination presses, and soldering is not necessary on these terminations.



STEP 1: DISCONNECT YOUR BATTERY:

Disconnect the battery before installing the wiring kit to prevent any accidental shorting caused by loose bare wire ends.

STEP 2: START INSTALLING KIT:

This kit is broken down into individual steps that are identified by a letter printed on the instruction sheets visible through each bag. These letters are the order of operation for installing your kit. Start with the bag letter G. The order of installation is shown below.

G 500775 Dash Harness Kit
H 500776 Instrument Cluster Kit
J 500668 Engine Kit
K 500664 Console Kit
L 500671 Front Light Kit
M 500734 Rear Body Kit
N 500708 Courtesy Light Kit

STEP 3: RECONNECT YOUR BATTERY:

When you have completed the installation and are ready to reconnect the battery, make sure that the following electrical system grounds are in place:

- A. Battery is grounded to the ENGINE BLOCK.
- B. Battery is grounded to the frame.
- C. Engine block is grounded to the frame.
- D. Body is grounded to the frame.

STEP 4: CHECK ALL ELECTRICAL FUNCTIONS:

Any non-functioning items should be checked for proper installation. Any problems with your wiring and electrical circuit functions should be addressed to American Autowire Systems, Inc. as soon as possible to avoid any warranty problems.

If you have any questions concerning this or any of our products, please feel free to call us at 1-800-482-WIRE.

AMERICAN AUTOWIRE MAKES IT EASY !!
page 1

We carry many accessories for your 1969 Camaro

p/n R0067108
OEM style non-stick harness tape



p/n CA82006 (1968-69)
Factory console gauge terminal kit.

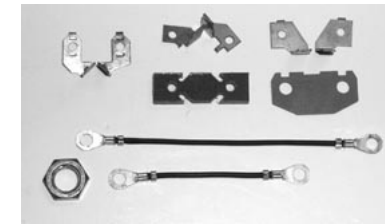

p/n 01993464 (1969)
OEM style wiper switch.



p/n 03943657 (1969)
Muncie 4 speed back up lamp switch.



p/n 500523
OEM large terminal and double crimping tool (20-8 gauge).



p/n 500649
Multi-crimp tool (20-14 gauge).



p/n 38131
Breakerless Ignition Module,
GM V-8 POINT CONVERSION KIT



p/n 36280 (1969)

Factory assembly manual.
(It's what they used on the assembly line to build your Camaro!)

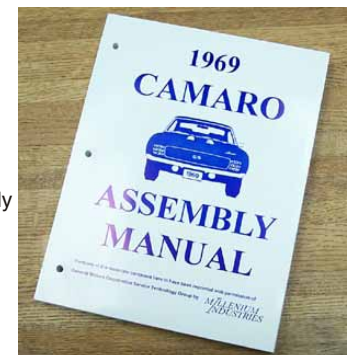

**American
Autowire**
800-482-9473

Classic Update
Series
1969 Camaro
500686

© COPYRIGHT 2004 American Autowire / Factory-Fit
Used with express permission of
American Autowire / Factory-Fit
92966547 instruction sheet rev. 3.0 2/10/2012

Classic Update Series

1969 Camaro



800-482-9473

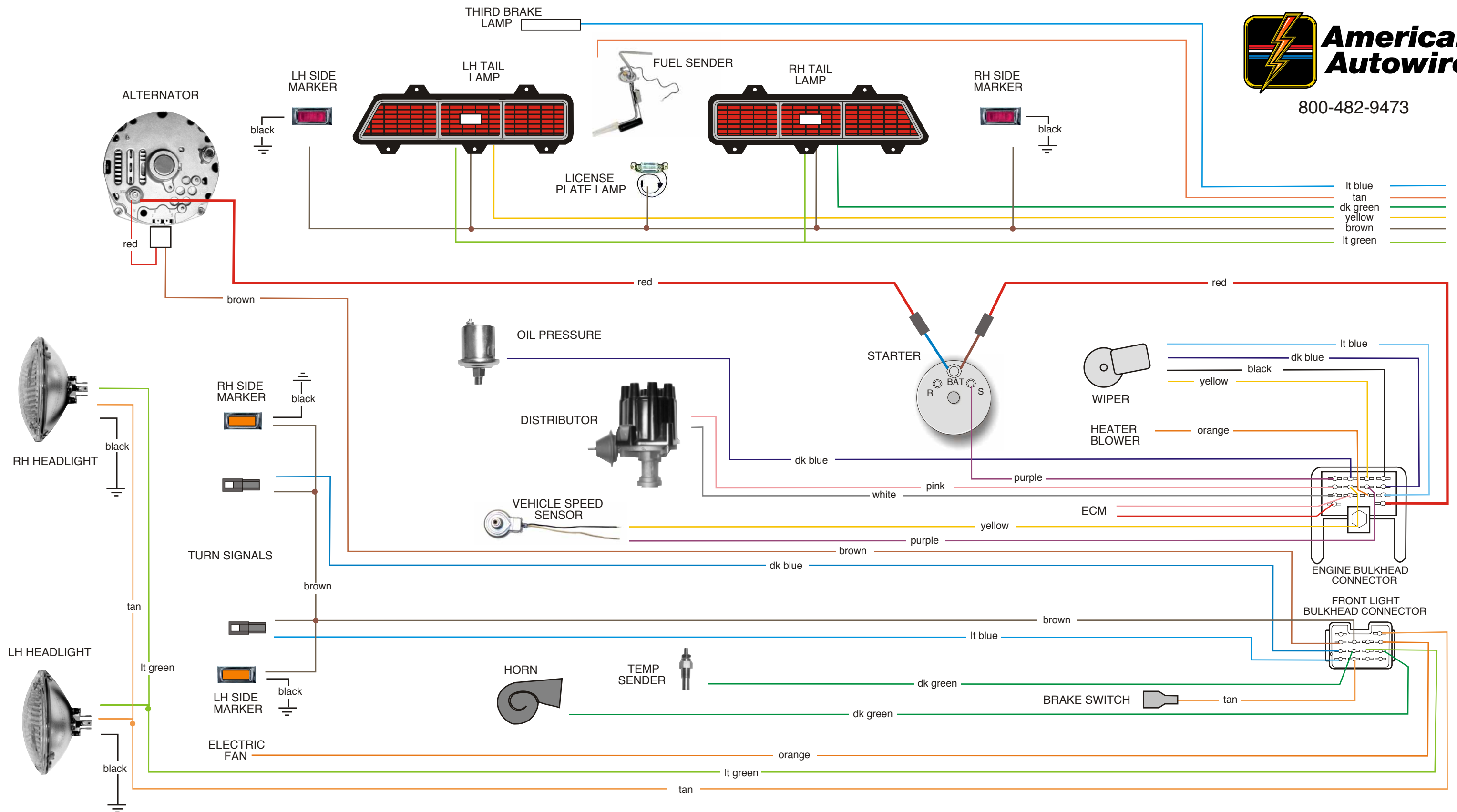

NOTICE: This schematic drawing is for reference only. Do not use the schematic to install this wiring kit! Use the instruction sheets included in each bag, which includes directions for proper terminations, and specific applications (such as Rally Sport).

500686

© COPYRIGHT 2004 American Autowire / Factory-Fit
Used with express permission of American Autowire / Factory-Fit
92966547 instruction sheet rev. 3.0 2/10/2012



800-482-9473

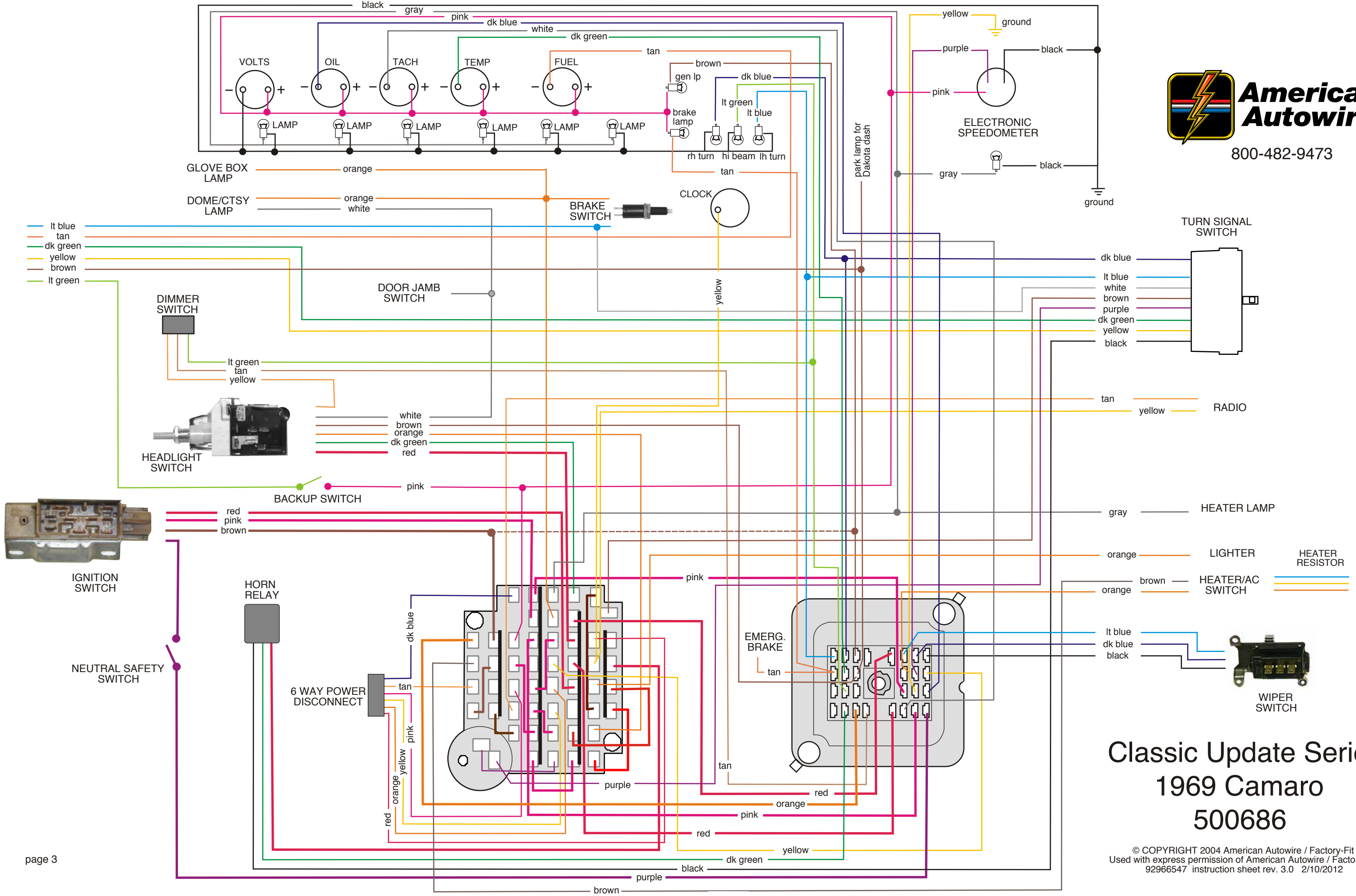

TURN SIGNAL SWITCH

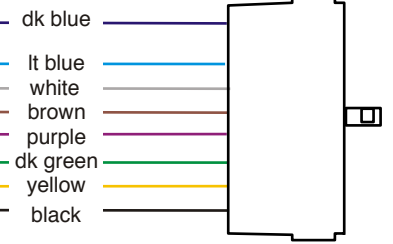

RADIO



HEATER LAMP



LIGHTER

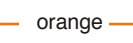

HEATER/AC SWITCH

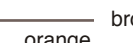

HEATER RESISTOR



WIPER SWITCH

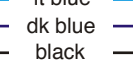

Classic Update Series 1969 Camaro 500686

© COPYRIGHT 2004 American Autowire / Factory-Fit
Used with express permission of American Autowire / Factory-Fit
92966547 instruction sheet rev. 3.0 2/10/2012

THIS PAGE HAS BEEN INTENTIONALLY LEFT BLANK



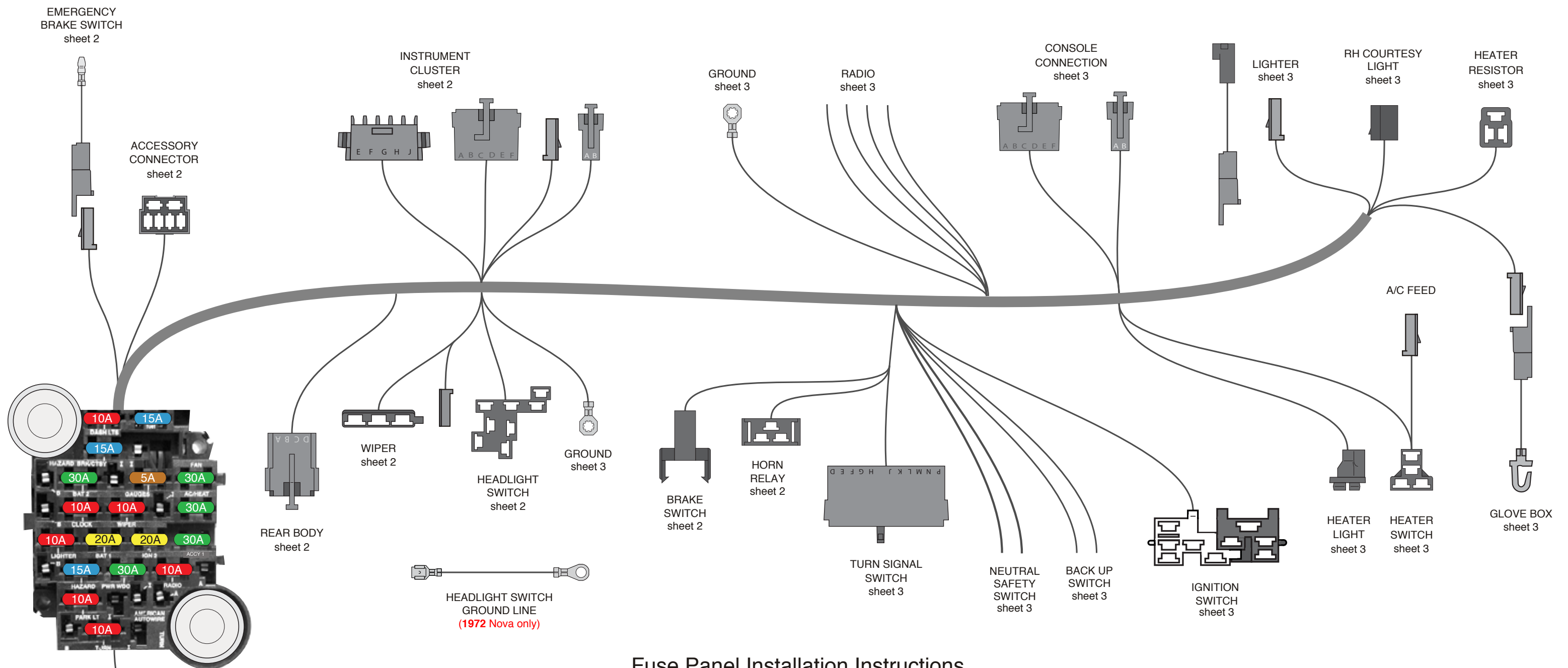

The above picture shows the orientation for **1972** Nova wiper hook-up **only**. All other applications can only be plugged in one way.

Fuse Panel Installation Instructions

Following these simple instructions will guarantee a successful installation of your American Autowire fuse panel harness.

1. Study the diagram above to familiarize yourself with the dash harness.
2. Install the fuse box.
3. Route the dash harness using the factory support straps.
4. Make all connections as shown on the following pages of this dash harness kit.
5. Once this harness is installed, continue to bag 'H', and install the rest of the kit (bags H,J,K,L,M).



www.americanautowire.com 856-933-0801

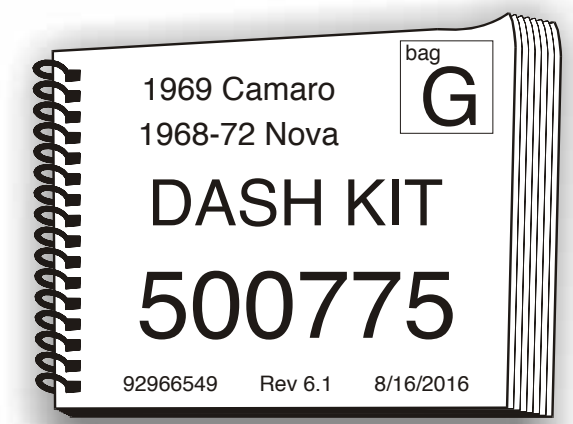

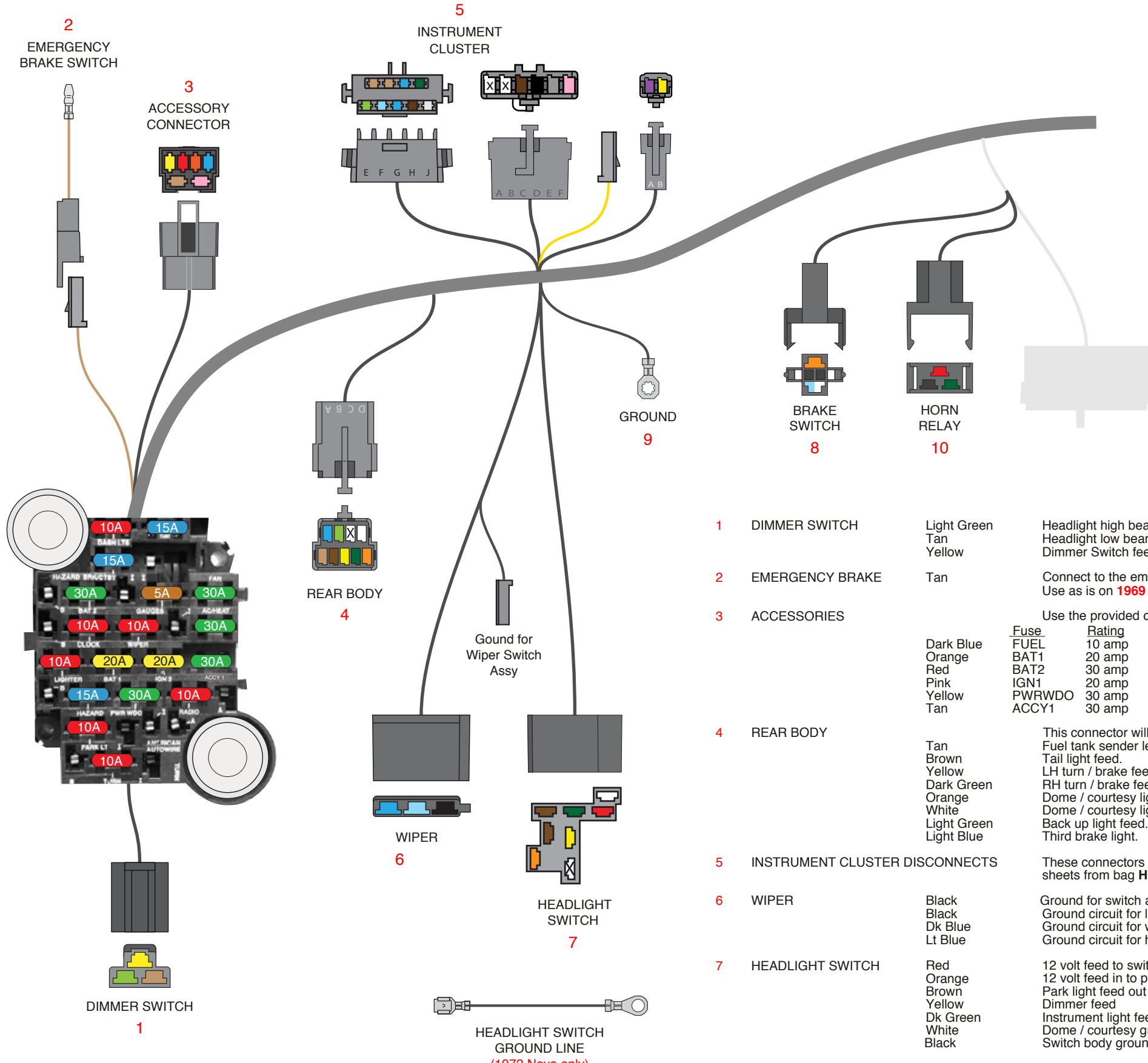

INSTALLING THE FUSE BOX

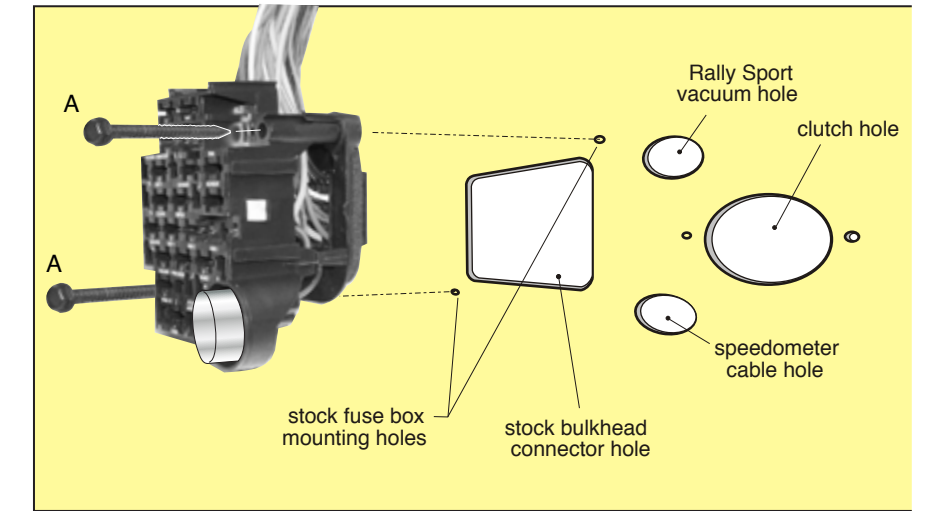

1. Locate the stock OEM bulkhead hole in the driver side of the firewall.
2. Mount the fuse box with the flasher can in the bottom right corner, as shown above.
3. Using the two mounting screws A, attach the fuse panel to the firewall.

1	DIMMER SWITCH	Light Green Tan Yellow	Headlight high beam feed wire. Headlight low beam feed wire. Dimmer Switch feed wire from headlight switch.																					
2	EMERGENCY BRAKE	Tan	Connect to the emergency brake switch. This is the ground circuit for the brake switch light. Use as is on 1969 Camaro, and use female connector on Nova applications.																					
3	ACCESSORIES		Use the provided connector J and terminals as power leads for the following: <table border="1"> <thead> <tr> <th>Fuse</th> <th>Rating</th> <th></th> </tr> </thead> <tbody> <tr> <td>FUEL</td> <td>10 amp</td> <td>Fused 12 volt IGNITION feed for fuel pump (may also be used to feed power to another ignition circuit).</td> </tr> <tr> <td>BAT1</td> <td>20 amp</td> <td>Fused 12 volt BATTERY feed for power seats (may also be used to feed power to another battery circuit).</td> </tr> <tr> <td>BAT2</td> <td>30 amp</td> <td>Fused 12 volt BATTERY feed for power door locks (may also be used to feed power to another accessory circuit).</td> </tr> <tr> <td>IGN1</td> <td>20 amp</td> <td>Fused 12 volt IGNITION feed for cruise control (may also be used to feed power to another ignition circuit).</td> </tr> <tr> <td>PWRWDO</td> <td>30 amp</td> <td>Fused 12 volt IGNITION feed for power windows (may also be used to feed power to another ignition circuit).</td> </tr> <tr> <td>ACCY1</td> <td>30 amp</td> <td>Fused 12 volt ACCESSORY feed (may also be used to feed power to an accessory circuit).</td> </tr> </tbody> </table>	Fuse	Rating		FUEL	10 amp	Fused 12 volt IGNITION feed for fuel pump (may also be used to feed power to another ignition circuit).	BAT1	20 amp	Fused 12 volt BATTERY feed for power seats (may also be used to feed power to another battery circuit).	BAT2	30 amp	Fused 12 volt BATTERY feed for power door locks (may also be used to feed power to another accessory circuit).	IGN1	20 amp	Fused 12 volt IGNITION feed for cruise control (may also be used to feed power to another ignition circuit).	PWRWDO	30 amp	Fused 12 volt IGNITION feed for power windows (may also be used to feed power to another ignition circuit).	ACCY1	30 amp	Fused 12 volt ACCESSORY feed (may also be used to feed power to an accessory circuit).
Fuse	Rating																							
FUEL	10 amp	Fused 12 volt IGNITION feed for fuel pump (may also be used to feed power to another ignition circuit).																						
BAT1	20 amp	Fused 12 volt BATTERY feed for power seats (may also be used to feed power to another battery circuit).																						
BAT2	30 amp	Fused 12 volt BATTERY feed for power door locks (may also be used to feed power to another accessory circuit).																						
IGN1	20 amp	Fused 12 volt IGNITION feed for cruise control (may also be used to feed power to another ignition circuit).																						
PWRWDO	30 amp	Fused 12 volt IGNITION feed for power windows (may also be used to feed power to another ignition circuit).																						
ACCY1	30 amp	Fused 12 volt ACCESSORY feed (may also be used to feed power to an accessory circuit).																						
4	REAR BODY	Tan Brown Yellow Dark Green Orange White Light Green Light Blue	This connector will mate to the connector from the Rear Body harness found in bag L. Fuel tank sender lead. Tail light feed. LH turn / brake feed. RH turn / brake feed. Dome / courtesy light feed. Dome / courtesy light ground. Back up light feed. Third brake light.																					
5	INSTRUMENT CLUSTER DISCONNECTS		These connectors will plug into the gauge disconnect harness from bag H. Wire identifications are described on the Instruction sheets from bag H.																					
6	WIPER	Black Black Dk Blue Lt Blue	Ground for switch assy (single wire used in 1972 Nova only). Ground circuit for low speed (in 3 way connector). Ground circuit for washer (in 3 way connector). Ground circuit for hi speed (in 3 way connector).																					
7	HEADLIGHT SWITCH	Red Orange Brown Yellow Dk Green White Black	12 volt feed to switch 12 volt feed in to park/tail Park light feed out Dimmer feed Instrument light feed Dome / courtesy ground Switch body ground BAT location on headlight switch. PARK/TAIL FEED IN location on headlight switch. PARK LIGHT OUT location on headlight switch. DIMMER FEED location on headlight switch. INSTRUMENT LIGHT location on headlight switch. GROUND location on headlight switch. Plug this onto male blade on side of H/L switch then ground ring terminal (for use on 1972 Nova applications only).																					
8	BRAKE SWITCH	Orange White Lt Blue	Plug this connector into the factory brake switch. 12 volt feed 'in' to switch. 12 volt feed 'out' to steering column switch. 12 volt feed 'out' to third brake light.																					
9	GROUND	Black	Connect to a good chassis ground.																					
10	HORN RELAY	Red Black Green	Plug the horn relay (found in the fuse bag) into this connector. 12 volt battery. Relay ground circuit (to steering column). Triggered 12 volts to horn.																					



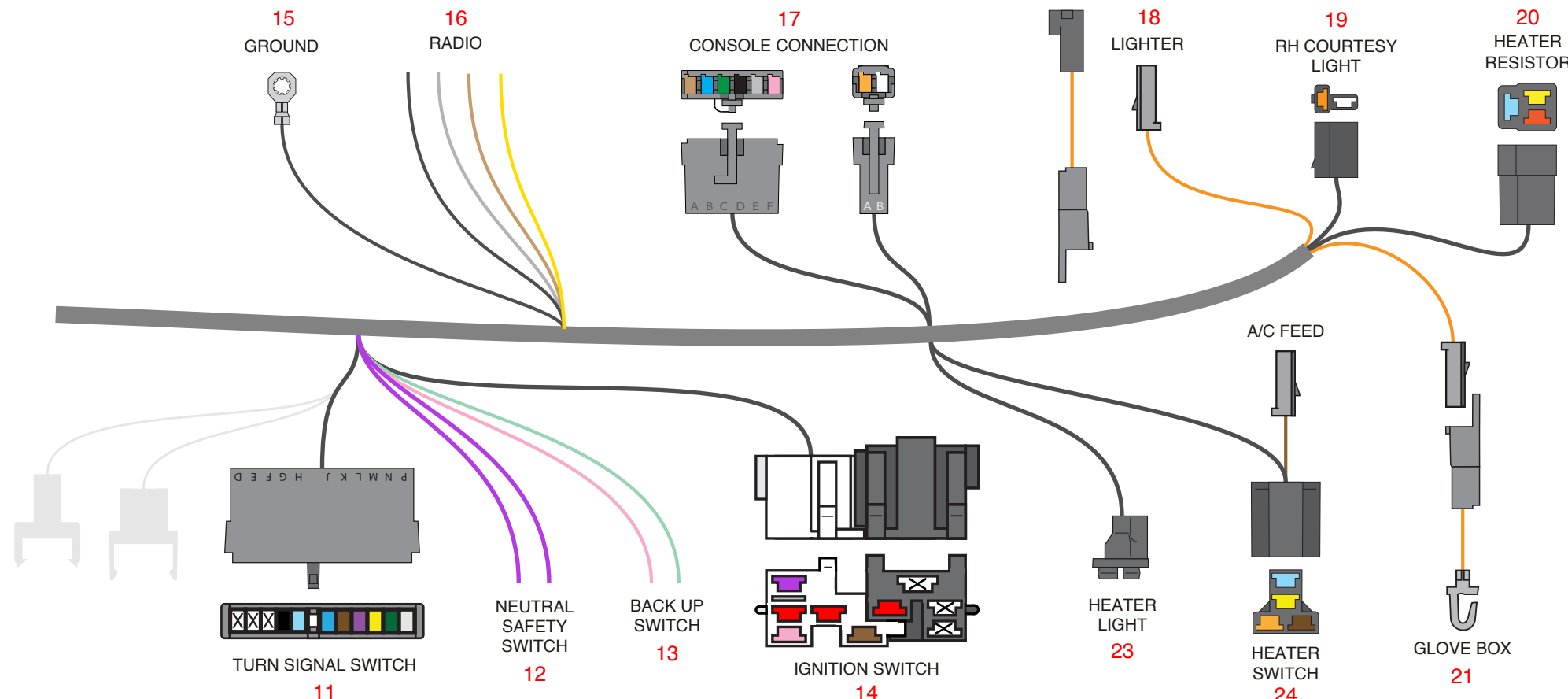

- 11** TURN SIGNAL SWITCH This harness has a connector on it for the 3-7/8 **1969-1974** GM column connection used by GM and many after-market manufacturers. If using a late model GM steering column or an after-market column using the 4-1/4 GM turn signal connector, replace existing connector with connector L, matching wires by color, as shown in **Diagram G**.
 White 12 volt feed from brake switch.
 Dark Green RH stop/turn light.
 Yellow LH stop/turn light.
 Purple 12 volt feed from turn flasher.
 Brown 12 volt feed from hazard flasher.
 Dark Blue RH front turn light.
 Light Blue LH front turn light.
 Black Horn relay ground wire to horn switch.
- 12** NEUTRAL SAFETY SWITCH Connect these wires to the neutral safety switch on the column or console shifter.
 Purple 12 volt feed 'in' to neutral safety switch from ignition switch.
 Purple 12 volt feed 'out' to starter solenoid.
- 13** BACK UP SWITCH Connect these wires to the back up switch on the column or console shifter.
 Pink 12 volt ignition feed 'in' to back up light switch.
 Lt Green 12 volt feed 'out' from back up light switch to back up lights.
- 14** IGNITION SWITCH Note: Connectors are included if you are using a stock **1969-72** ignition switch as shown in **Diagram H**.
 Red 12 volt battery feed "in".
 Pink 12 volt ignition feed "out".
 Brown 12 volt accessory feed "out".
 Purple Starter lead "out" to Neutral Safety Switch.
- 15** GROUND Black Connect to a good chassis ground.
- 16** RADIO Tan Radio accessory feed. (Power wire for stock radio).
 Yellow Radio 12 volt clock lead (battery feed) (Loose piece terminals & connectors have been provided for stock radio hook up.)
 Black Radio ground for stock **1970-72** radio (or aftermarket if necessary).
 Gray Radio light feed for stock **1970-72** radio (or aftermarket if necessary).
- 17** CONSOLE CONNECTION These wires are for use on a console vehicle. For wire functions, refer to bag **K, 500664**.
- 18** LIGHTER Orange Connect to lighter. (battery feed)(use as is with extension for Camaro or remove extension for use on Nova).
- 19** RH COURTESY LIGHT Plug this connector into the mating connector from the courtesy light kit bag **N, 500708**.
 Orange 12 volt battery feed fo light
 White Ground circuit for light
- 20** HEATER RESISTOR Plug this connector into the factory heater resistor located on top of the heater box on **non-A/C cars only**.
- 21** GLOVE BOX LIGHT Orange Connect to the original factory glove box light switch. If not using, just unplug and tape back.
- 23** HEATER LIGHT Gray Heater control light feed.
 Black Heater control light ground.
- 24** HEATER SWITCH Plug this connector into the factory heater switch.
 Brown 12 volt accessory feed to heater / ac switch (if using factory or aftermarket a/c, use the short brown wire as the accessory feed wire to your a/c harness. If a new A/C harness is needed, please refer to **Table A**, at right).
 Yellow Heater resistor.
 Lt Blue Heater resistor.
 Orange Heater resistor.

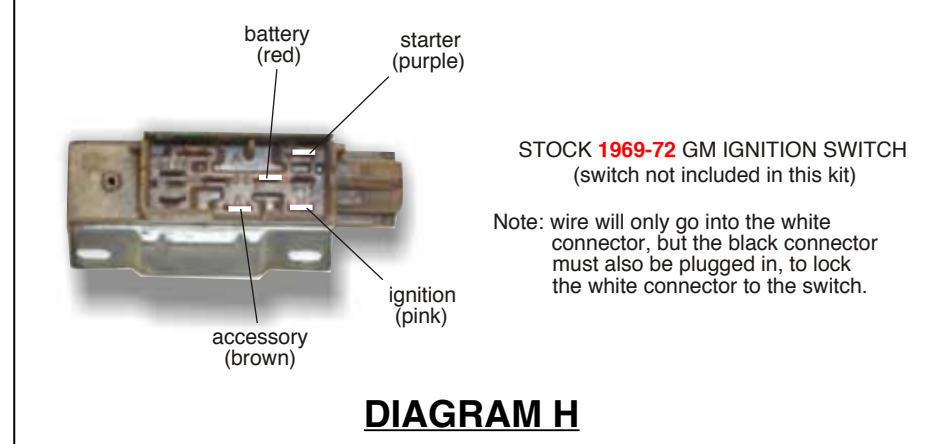
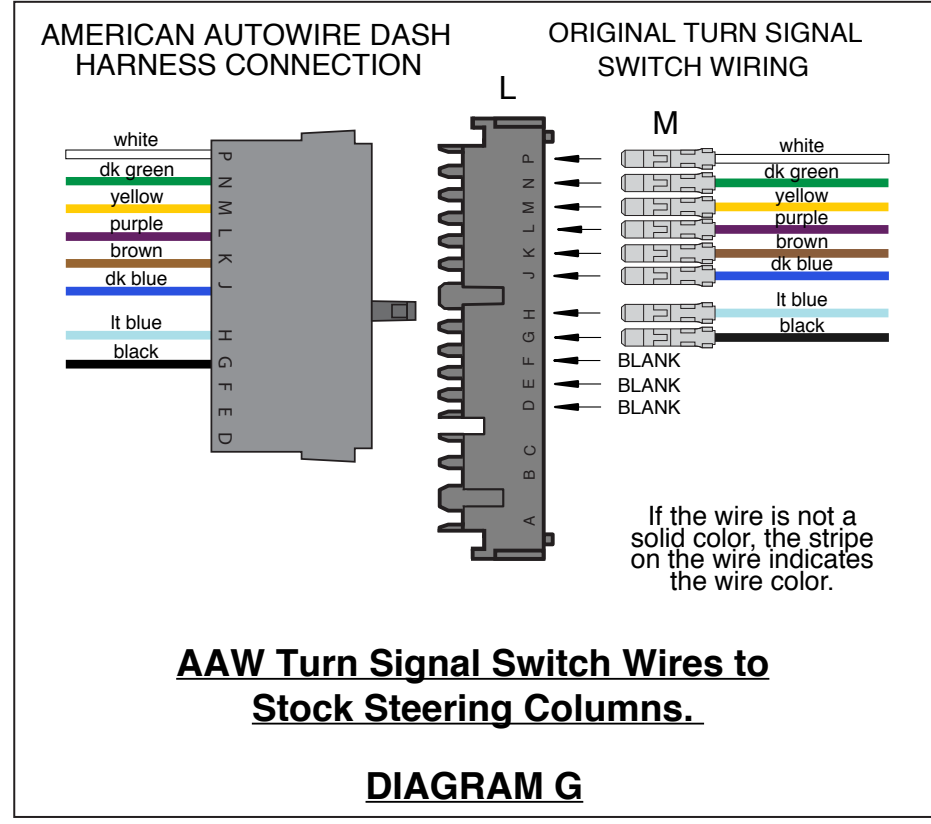

Factory A/C Harnesses

1968 Nova	NV85279
1969 Camaro, 1969-70 Nova	CA97546
1971 Nova	NV11892
1972 Nova	NV28041

TABLE A



**American
Autowire**

www.americanautowire.com

1969 Camaro
1968-72 Nova

**DASH KIT
500775**

92966549 Rev 6.1 8/16/2016

THIS PAGE HAS BEEN
INTENTIONALLY LEFT BLANK



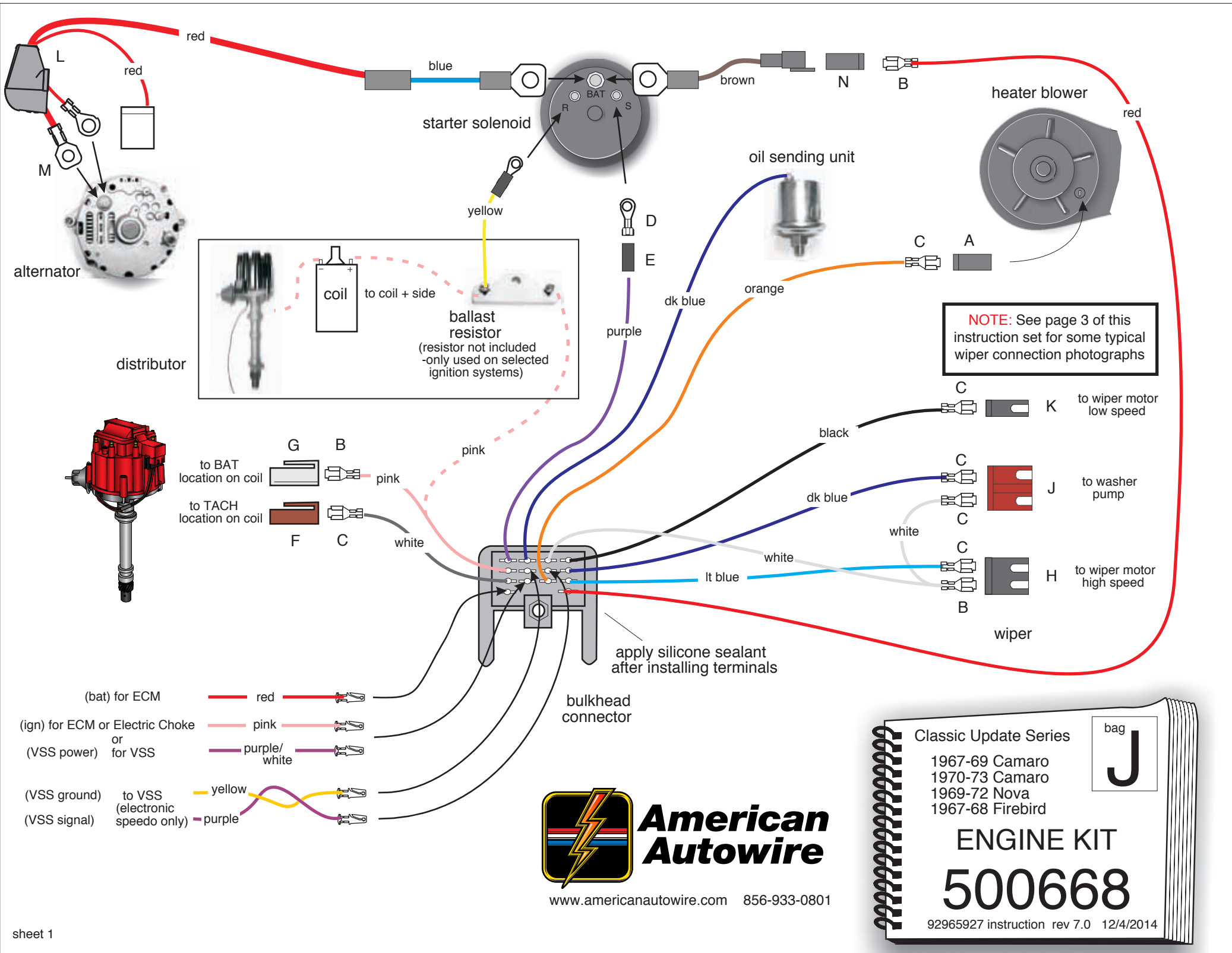

American Autowire

www.americanautowire.com 856-933-0801

TEMPORARILY, PLUG THE MAIN BULKHEAD CONNECTOR FROM THIS KIT INTO THE MATING CONNECTOR ON THE DASH BULKHEAD CONNECTOR (LOCATED UNDER THE MASTER CYLINDER) Note: This will be unbolted to install the front light harness later.

BULKHEAD CONNECTOR WIRES:

RED	(12V BATTERY)	Route this wire to the starter solenoid and cut to length. Install terminal B and solder. Plug into connector N.
BROWN	(fuse-link wire)	Connect to the battery stud on the starter solenoid, and plug the other end into the RED wire above.
PURPLE	(STARTER SOLENOID)	Route to the starter solenoid and cut to length. Install rubber sleeve E and ring D. Connect to the 'S' terminal on solenoid.
DK BLUE	(OIL PRESSURE SENDER)	Connect this wire to the oil pressure sending unit. Using terminal P or terminal C with connector A.
ORANGE	(HEAT / AIR)	If using after-market air conditioning, remove this wire. If using a stock heater only system, route this wire to the heater blower, cut to length. Install terminal C and connector A and plug into the blower unit.
PINK	(12V IGNITION)	If using an HEI distributor, or after-market ignition system which requires a 12V feed: Route the PINK wire to the coil and trim to length. Install terminal C and connector G, and plug into distributor cap BAT location. If using a points type ignition system which required reduced voltage: Route the PINK wire to the ignition feed side of the ballast resistor (not included in this kit). Connect the loose piece YELLOW wire to the R terminal on the starter and connect the other end to the coil side of the ballast resistor (not included in this kit). Connect a piece of the left over PINK wire to the coil side of the ballast resistor and route the to the distributor coil + side.
WHITE	(COIL-TACH)	Route this wire to he coil and trim to length. if using an HEI distributor, terminal B and connector F are included for connection. Plug into the TACH location on the HEI distributor, or attach to the negative side of coil in a points type system.

The following wires are for use on a stock wiper system. If using an after-market wiper system, follow the manufacturer's instructions (see sheets 1 and 3 for details).

BLACK	(WIPER LOW SPEED)	Route to the wiper motor and trim to length. Install terminal C, plug into connector K, and plug into the low speed terminal of the wiper motor as shown on sheet 3.
DK BLUE	(WIPER WASHER)	Route this wire to the washer pump and trim to length. Install terminal C and plug into BROWN connector J in the location shown on sheet 1.
LT BLUE	(WIPER HI SPEED)	Route this wire to the wiper motor and trim to length. Install terminal C and plug into BLACK connector H in the location shown on sheet 1.
WHITE	(WIPER ACC)	Route this wire to the wiper motor and trim to length. Double it with the cut off portion, install terminal B and plug into the open cavity of connector H as shown on sheet 1. Route the loose end of this wire to the washer pump, install terminal C and plug into open cavity of connector J as shown on sheet 1. Plug connector H onto the high speed terminals of the wiper motor as shown on sheet 3. Plug connector J onto the washer pump terminals of the wiper motor as shown on sheet 3.

ALTERNATOR WIRES:

HEAVY RED	(AMERICAN AUTOWIRE)	Connect the blue fuse link wire to the battery stud on the starter solenoid. Route the other end to the alternator and trim to length. Install boot L and terminal M and connect to the battery stud on the alternator.
SMALL RED		Send the ring terminal end of this wire through boot L (as shown on sheet 1) and connect to the battery stud on alternator. Do not plug the connector into the alternator yet, the exciter wire will be added when the front light wires are install.

REMAING LOOSE WIRES: These wires will be used only if you are using and ECM module which is located in the engine compartment, an electric choke, or if you are using an electronic speedometer. (**NOTE:** The pink wire can also be used as a fused ignition lead for an electric choke).

RED	(12V BATTERY)	Used on ECM module which is mounted in the engine compartment. Plug this wire into the firewall bulkhead connector, at the location shown on sheet 1. Route the other end to the ECM harness, battery feed in.
PINK	(12V IGNITION)	Used on ECM module which is mounted in the engine compartment. Plug this wire into the firewall bulkhead connector, at the location shown on sheet 1. Route the other end to the ECM harness, ignition feed in. (NOTE: If using the pink wire as an electric choke feed, simply connect this wire to the power terminal on your electric choke housing).
PURPLE		Used on vehicles which have an electronic speedometer. Route this wire to the vehicle speed sensor and connect to the signal lead.
YELLOW		Used on vehicles which have an electronic speedometer. <u>Twist this wire with the purple wire above to assure proper shielding.</u> Connect this wire to the vehicle speed sensor ground lead.

Once the main connector has all of it's wires plugged in, the connector cavities should be sealed with di-electric grease on the terminals. Also, to assure a moisture resistant seal, silicone can be applied to seal the outside of the connector.

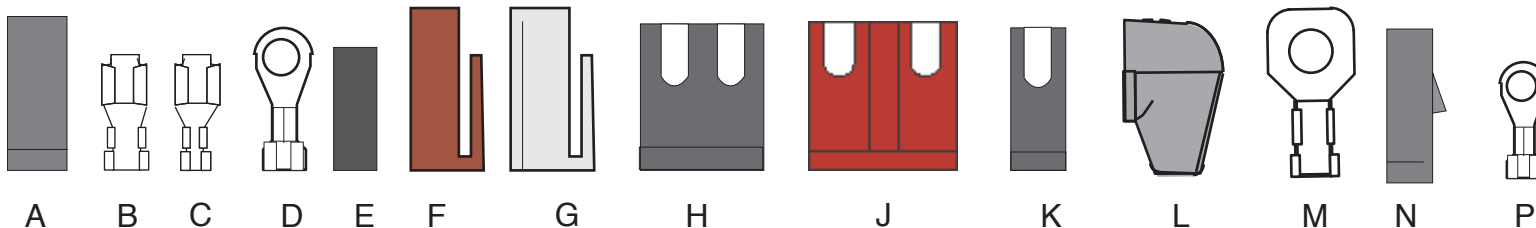

ENGINE KIT

500668

92965927 instruction rev 7.0 12/4/2014



The photo above depicts the typical stock 1967-1969 Camaro (all), 1968-1972 Nova (all), 1967-1968 Firebird (all), and 1970-73 Camaro “without depressed park” wiper motor and washer pump connections. Where you see the black wire with the yellow strip in the photo, that would be equivalent to the AAW white “wiper feed” power wire.



The photo above depicts the typical stock 1970-73 Camaro “with depressed park” wiper motor and washer pump connections. Where you see the black wire with the yellow strip in the photo, that would be equivalent to the AAW white “wiper feed” power wire.



THIS PAGE HAS BEEN
INTENTIONALLY LEFT BLANK



www.americanautowire.com 856-933-0801

ENGINE KIT

500668

92965927 instruction rev 7.0 12/4/2014

REFER TO SHEETS 3 AND 4 FOR CONNECTING TO STOCK FACTORY CONSOLE GAUGES.
IF YOU ARE USING AFTERMARKET GAUGES, USE THE AFTERMARKET GAUGE CONNECTION TERMINALS (SEE 500663 BAG H).



1967 FACTORY CONSOLE GAUGE PACKAGE

For safety purposes, American Autowire does not support or encourage the use of a factory ammeter in an after-market application. A voltmeter is a much safer choice to monitor the charging system in a car equipped with a higher amperage alternator. American Auto manufactures factory type replacement voltmeters that are direct replacements for the stock ammeters for both the 1968-69 Camaro (500121) and the 1969-72 Nova (500122) console gauge packages. Contact our Sales Group or your favorite retailer today to purchase one of these gauges to complete your project.



1968-69 Camaro 1969-72 Nova FACTORY CONSOLE GAUGE PACKAGE

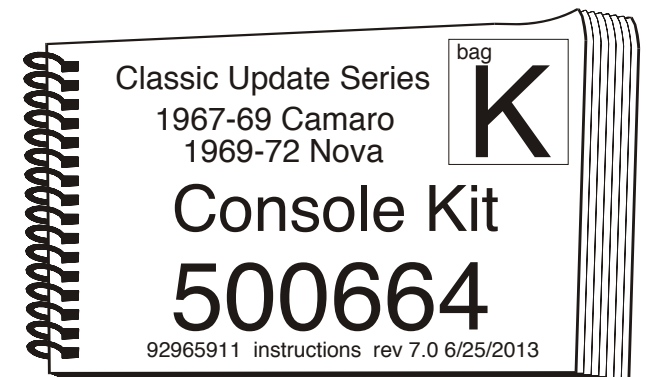

**American
Autowire**

www.americanautowire.com 856-933-0801

REFER TO SHEETS 3 AND 4 FOR CONNECTING TO STOCK FACTORY CONSOLE GAUGES.
 IF YOU ARE USING AFTERMARKET GAUGES, USE THE AFTERMARKET GAUGE CONNECTION TERMINALS (SEE 500663 BAG H).

CONNECTOR A

ORANGE 12v Ignition

Connect this wire to the courtesy lamp in the rear of the console (either location).
 Connect the shorter bare end wire to the console clock (if factory equipped).

WHITE Courtesy Ground

Note: If a console clock is not being used, this wire must be terminated and taped back against the harness to prevent and short to ground.
 Connect this wire to the courtesy lamp in the rear of the console (either location).

If you are using a console shift manual transmission, without gauges on the console, then only the orange and white wires will be used. All other applications, continue to the next wire.

CONNECTOR P

BLACK Ground

Route this wire to the console gauge plates and cut to length. Double this wire with the cut off portion, install terminal D.
 Connect the ring terminal to the gauge plate, as shown on sheet 3 for 1967 console gauges and sheet 4 for 1968-69 console gauges.
 For 1967 console gauges, connect the remaining black wire to the floor under the console using terminal as shown on sheet 3.
 For the 1968-69 console gauges, there are two gauge mounting plates that are mounted in a plastic tray. Both of these plates need to be grounded.
 In the stock configuration the second plate ground was on the inside of the tray connecting the two plates with a small ground jumper wire.
 If this wire is not on your gauge plates, you will need to create an additional ground wire to the second plate as shown on sheet 4. Then the remaining black wire is attached to the floor under the console using terminal Das shown on sheet 4.
 Using the butt splice connectors C, route the wires to each lamp location as shown on sheet 2. Install lamps socket G and rivets J and plug into the lamp holes on the gauge plates.

Note: If you have an automatic transmission, you will need to install the shift indicator lamps, as shown on sheet 2, using terminals F, J, springs H, and lamp sockets E.

LOOSE WIRES

PINK 12V Ignition

Plug this wire into connector B, maintaining color continuity with the mating connector on the dash harness.
 Route the other end to the temperature gauge, and cut to length. Double this wire with the cut off portion, and install terminal B. Route the remaining end to the fuel gauge, install terminal B, and plug into the fuel gauge

TAN Fuel Sender

in the location shown on sheet 2. (if using an electric oil pressure gauge, then double this wire and route to the oil gauge also)
 Plug this wire into connector B. Route this wire to the fuel gauge and cut to length. Install terminal B and connect to fuel gauge, as shown on sheet 2.

DK BLUE Oil Pressure Sender
 DK GREEN Temperature Sender

This wire is only used on an electric oil pressure gauge (not used on a factory mechanical pressure gauge).
 Plug this wire into connector B. Route this wire to the temperature gauge and cut to length. Install terminal B and connect to the sender (-) terminal.

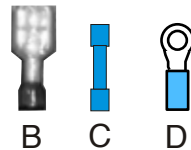

A, B & C are part of gauge terminal kit 92965220 found in bag H

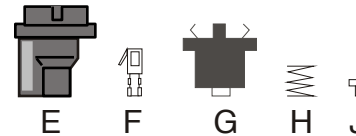

Look!

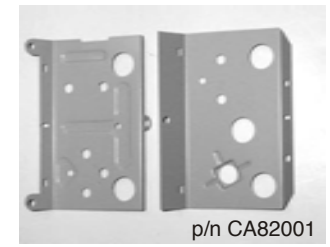
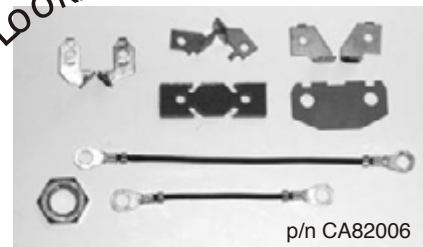

American Autowire manufactures OEM gauge terminals and OEM gauge plates for the 1968 & 1969 Camaros!

Classic Update Series

CONNECTING TO 1968-69 Camaro or 69-72 Nova FACTORY CONSOLE GAUGES

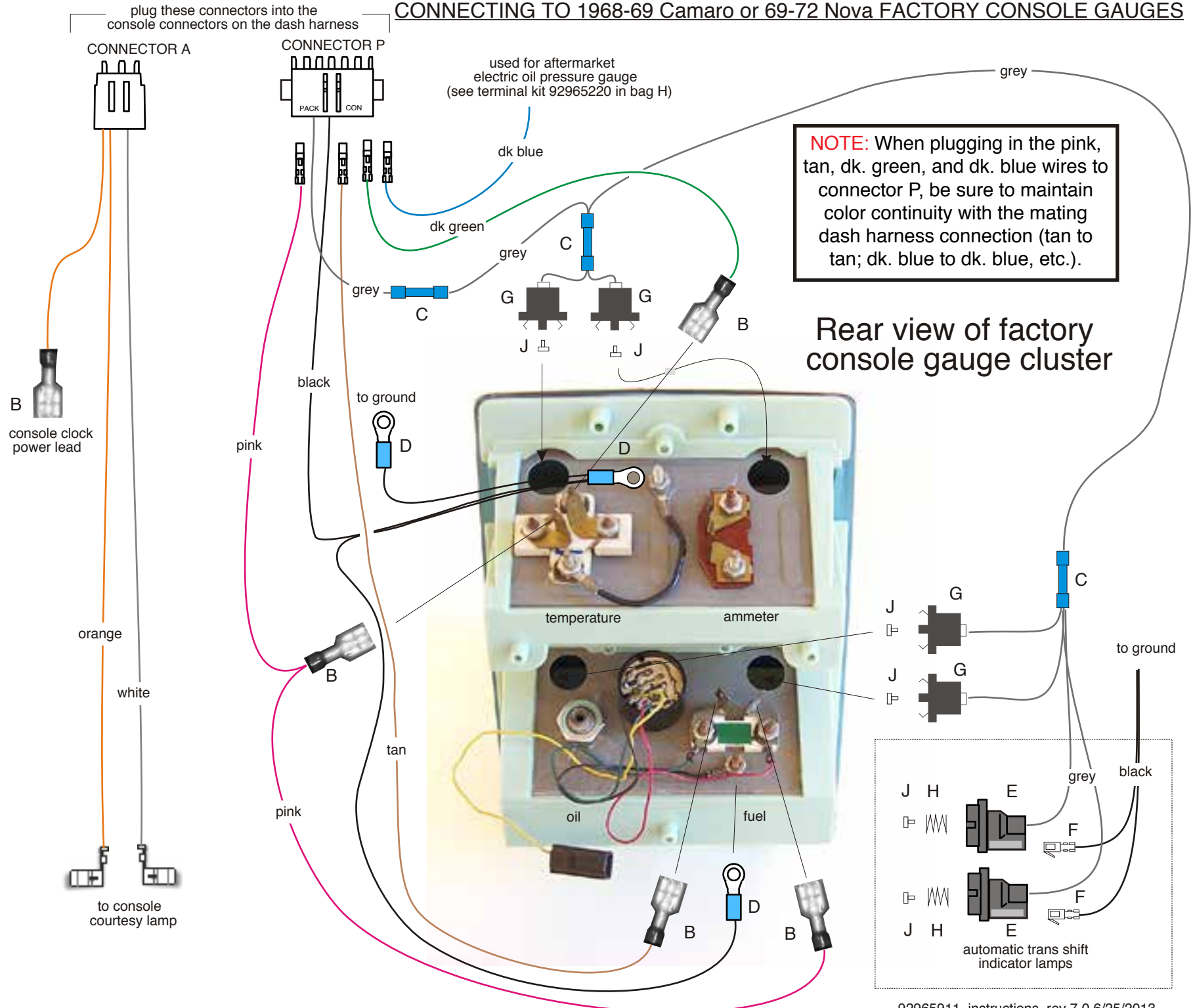

Classic Update Series

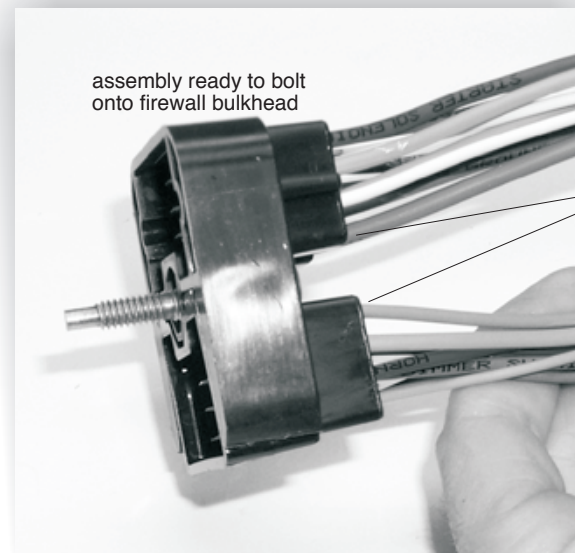
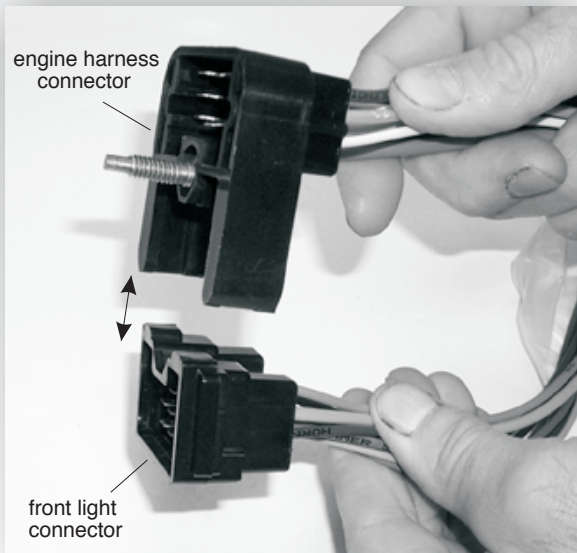

The bulkhead connector from this front light kit must snap into the mating engine connector (bag J), as shown. After snapping together, then bolt the assembly into the dash harness firewall connector using the attached bolt.

Look!



American Autowire also sells factory OEM style harness wrap. this is the same stuff used on original Camaro harnesses! If you want that OEM look with your Classic Update wiring system, then give us a call and order p/n R0067108 !















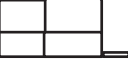

**American
Autowire**

www.americanautowire.com 856-933-0801



1967-68 Camaro Rally Sport Front Lighting; 1969-72 Nova Front Lighting 1969 Camaro & 1970-73 Camaro Standard and Rally Sport Front Lighting

A		Connect the bulkhead connector from this kit onto the bulkhead connector from the engine kit (bag J), and bolt to the firewall dash bulkhead.		
B		<u>PARKING LAMP WIRES</u>		
C		LT BLUE	LH turn	Route this wire to the LH turn signal lamp install terminal J, and plug into connector H as shown on sheet 4.
D		DK BLUE	RH turn	Route this wire to the RH turn signal lamp install terminal J, and plug into connector H as shown on sheet 4.
E		BROWN	Parking Lamp	Route this wire to the LH side marker lamp and cut to length. Double this wire with the cut off portion, install terminal Q, and plug into lamp socket N, as shown on sheet 4. (Also plug the pre-assembled black ground wire into lamp socket N, as shown on sheet 4.) Route the remaining portion of the brown wire to the LH turn signal lamp and cut to length. Double this wire with the cut off portion, install terminal M, and plug into connector H with the lt blue wire from above as shown on sheet 4. Route the remaining portion of the brown wire to the RH turn signal lamp and cut to length. Double this wire with the cut off portion, install terminal M, and plug into connector H with the dk blue wire from above as shown on sheet 4. Route the remaining brown wire to the RH side marker and trim to length. Install terminal P and plug into connector N, as shown on sheet 4. (Also plug the pre-assembled black ground wire into lamp socket N, as shown on sheet 4.)
F				
H		NOTE: The running and directional light assemblies use factory parking lamp housing assemblies that are not serviceable. To connect them, plug completed connector H (on the wires above) onto the factory parking lamp housing assemblies as shown on sheet 4. New terminals D and connectors F have been provided in the event that your originals are damaged or are missing.		
J		<u>FRONT LIGHT WIRING</u>		
L		TAN (heavy gauge)	Lo Beam	Route this wire to the driver side headlight and trim to length. Double this wire with the cut off portion, and install terminal B. Plug this terminal into connector A, in the location shown on sheet 8. Route the remaining portion of this tan wire to the passenger headlight and trim to length. Install terminal C and connector A, in the location shown on sheet 8.
M		LT GREEN	Hi Beam	Route this wire to the driver side headlight and trim to length. Double this wire with the cut off portion, and install terminal B. Plug this terminal into connector A, in the location shown on sheet 8. Route the remaining portion of this lt green wire to the passenger headlight and trim to length. Install terminal C and connector A, in location shown on sheet 8.
N		BLACK	Ground	Install terminal C and plug into connector A, in the location shown on sheet 8. Connect the ring terminal to a good chassis ground. Complete for each headlight.
P		DK GREEN	Horn	Route to horns and install terminals D & E, as shown on sheet 4, Plug into connectors L.
		ORANGE	Electric Fan	Route to the electric fan, and connect per manufacturer's instructions.
		NOTE: We recommend that this wire be used as the trigger wire for the electric fan relay. American Autowire manufactures relay kits for this application!		
Q		TAN (small gauge)	Brake Sender	Plug this wire onto the stock brake sender switch.
R		DK GREEN	Water Temp	Connect this wire to the temperature sending unit using terminal R or terminal D and connector S (depending on your sending unit).
S		BROWN	Alternator Regulator	Route this wire to the alternator and cut to length. Install terminal D and plug into the regulator connector (previously installed from the engine kit 500668 bag J).
		NOTE: This wire is only used on an alternator with an internal regulator which requires an exciter wire. If you are using a true one wire alternator, then this brown wire will not used and can be removed.		

1967-68 Firebird Front Lighting

ORANGE	Electric Fan	Route to the electric fan, and connect per the manufacturers instructions. <u>NOTE:</u> We recommend that this wire be used as the trigger wire for the electric fan relay. American Autowire manufactures relay kits for this application.
TAN (small gauge)	Brake Sender	Plug this wire into the stock brake sender switch.
DK GREEN	Water Temp	Connect this wire to the temperature sending unit using terminal R or terminal D and connector S (depending on your sending unit).
BROWN	Alternator Regulator	Route this wire to the alternator and cut to length. Install terminal D and plug into the regulator connector (previously installed from the engine kit 500668 bag J). <u>NOTE:</u> This wire is only used on an alternator with an internal regulator which requires an exciter wire. If you are using a true one wire alternator, then this brown wire will not used and can be removed.

After all wires are installed from this kit, the main connector should have die-electric grease applied to the terminals. Also, to assure a moisture resistance seal, apply silicone sealant to the outside of the main connector around each wire.

Headlight Connector “Plug-In Details”



1967-73 Camaro All
1968-72 Nova All

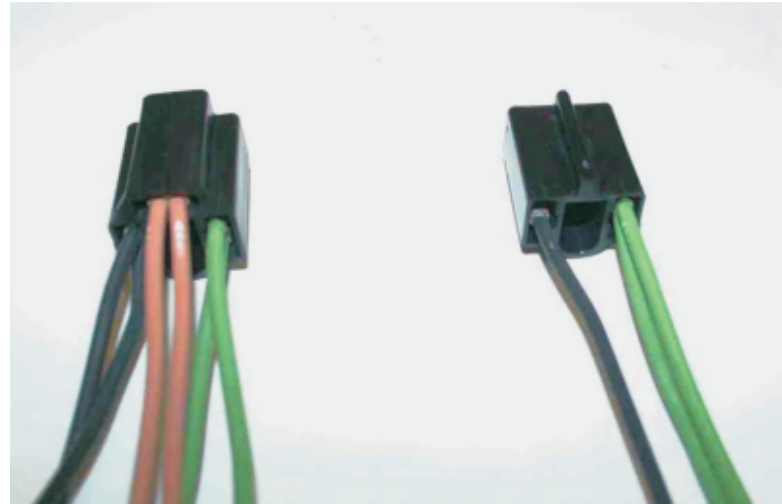

1967-68 Firebird (only)

Classic Update Series

Stock Instrument Cluster Wiring for:

1. Warning light cars.
2. Warning light cars with center in-dash clock.
3. Warning light cars with tachometer and center fuel gauge.

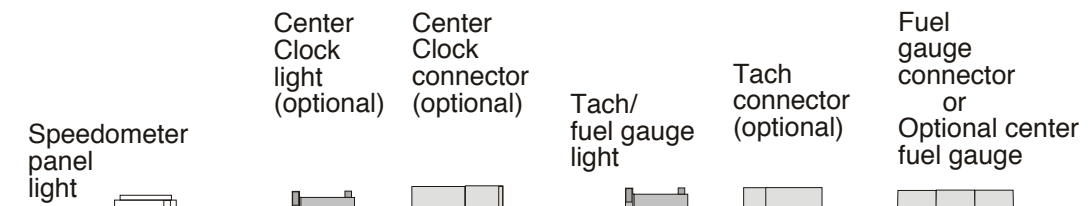

Connector G.

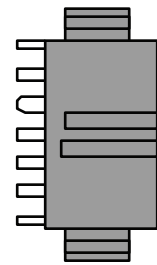
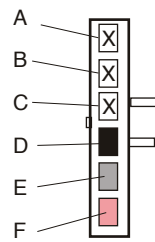

- D- BLACK (GROUND)
- E- GRAY (DASH LIGHTS)
- F- PINK (12 V IGNITION)

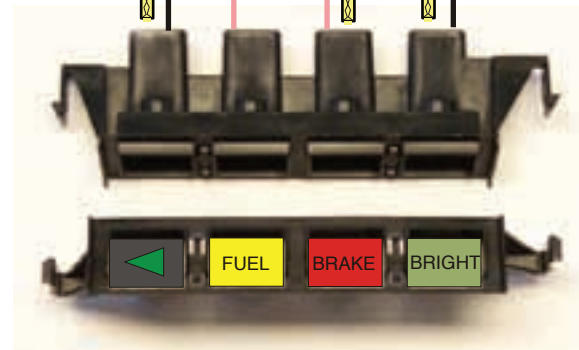

LEFT HAND INSTRUMENT CLUSTER POD

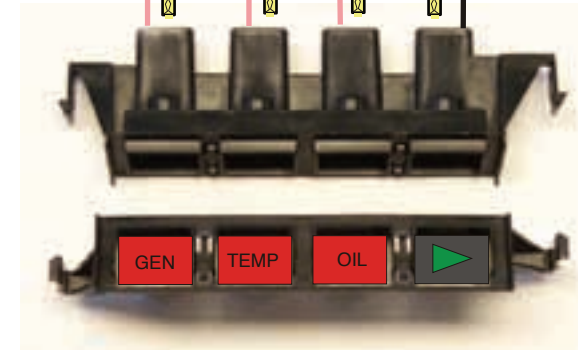

RIGHT HAND INSTRUMENT CLUSTER POD

Connector F.

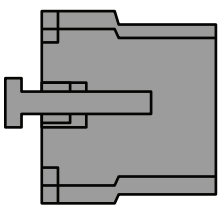
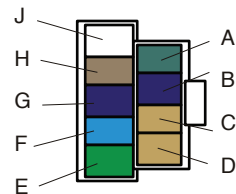

- G- DARK BLUE (RIGHT TURN IND)
- B- DARK BLUE (OIL PRESSURE)
- A -DARK GREEN (WATER TEMP)
- H- BROWN (ALTERNATOR)
- E- LIGHT GREEN (HIGH BEAM IND)
- C- TAN (BRAKE WARNING)
- F- LIGHT BLUE (LEFT TURN IND)
- J- WHITE (COIL--> TACH)
- D- TAN (GAS GAUGE)



**American
Autowire**

800-482-9473

Classic Update Series
1969 Camaro

**INSTRUMENT
CLUSTER**

500776

92966553 instruction rev 2.0 2/10/2012

bag **H**

Classic Update Series

Stock Instrument Cluster Wiring for Factory Gauge Cars.

NOTE: If you are using console gauges, connections for the console are included in 500664 kit (bag K). After market gauge connectors and terminals are included in this kit (92965220)

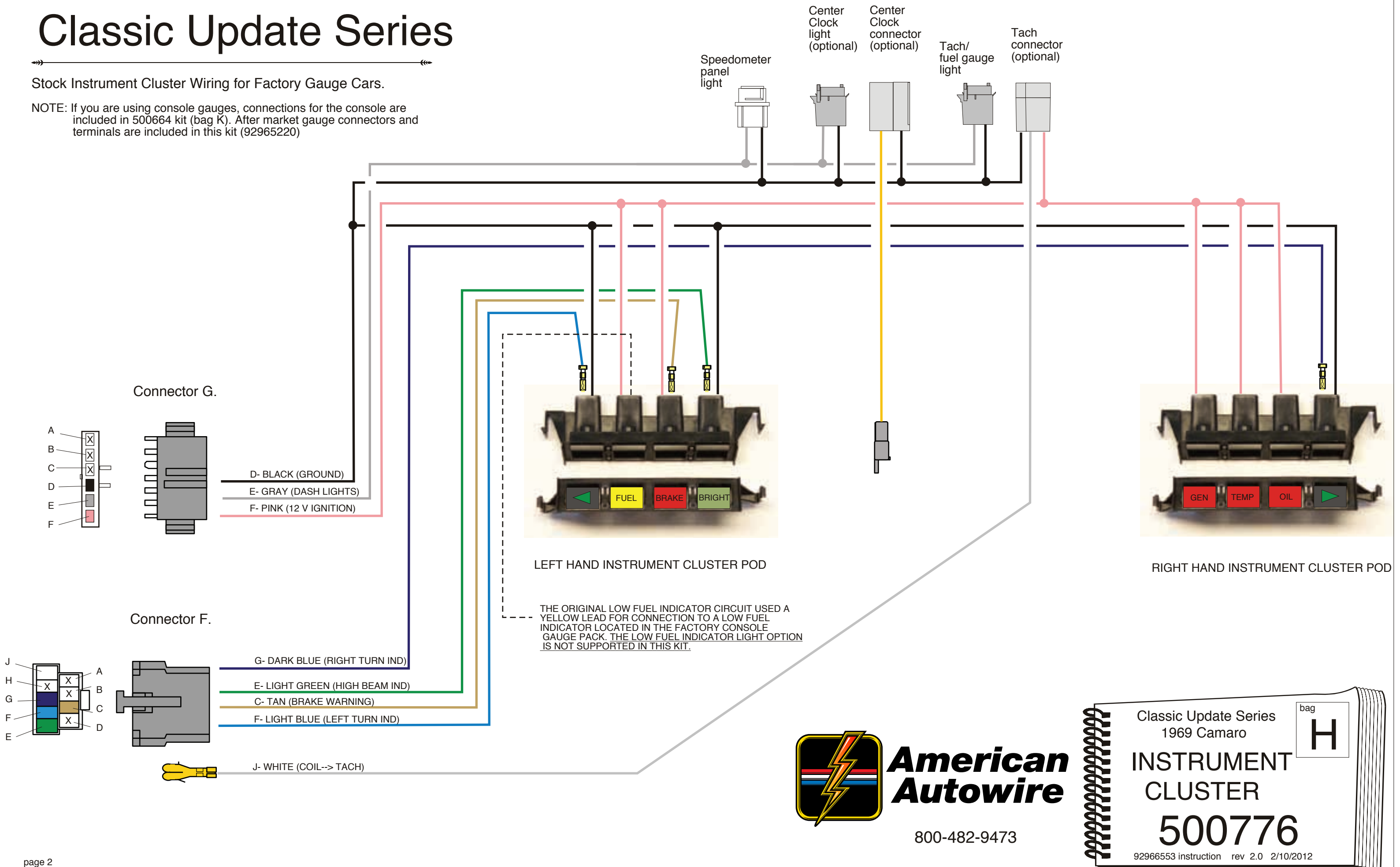

**American
Autowire**

800-482-9473

Classic Update Series
1969 Camaro

INSTRUMENT
CLUSTER

500776

92966553 instruction rev 2.0 2/10/2012

bag
H

Classic Update Series Instrument Cluster wiring for Custom Gauge Installations

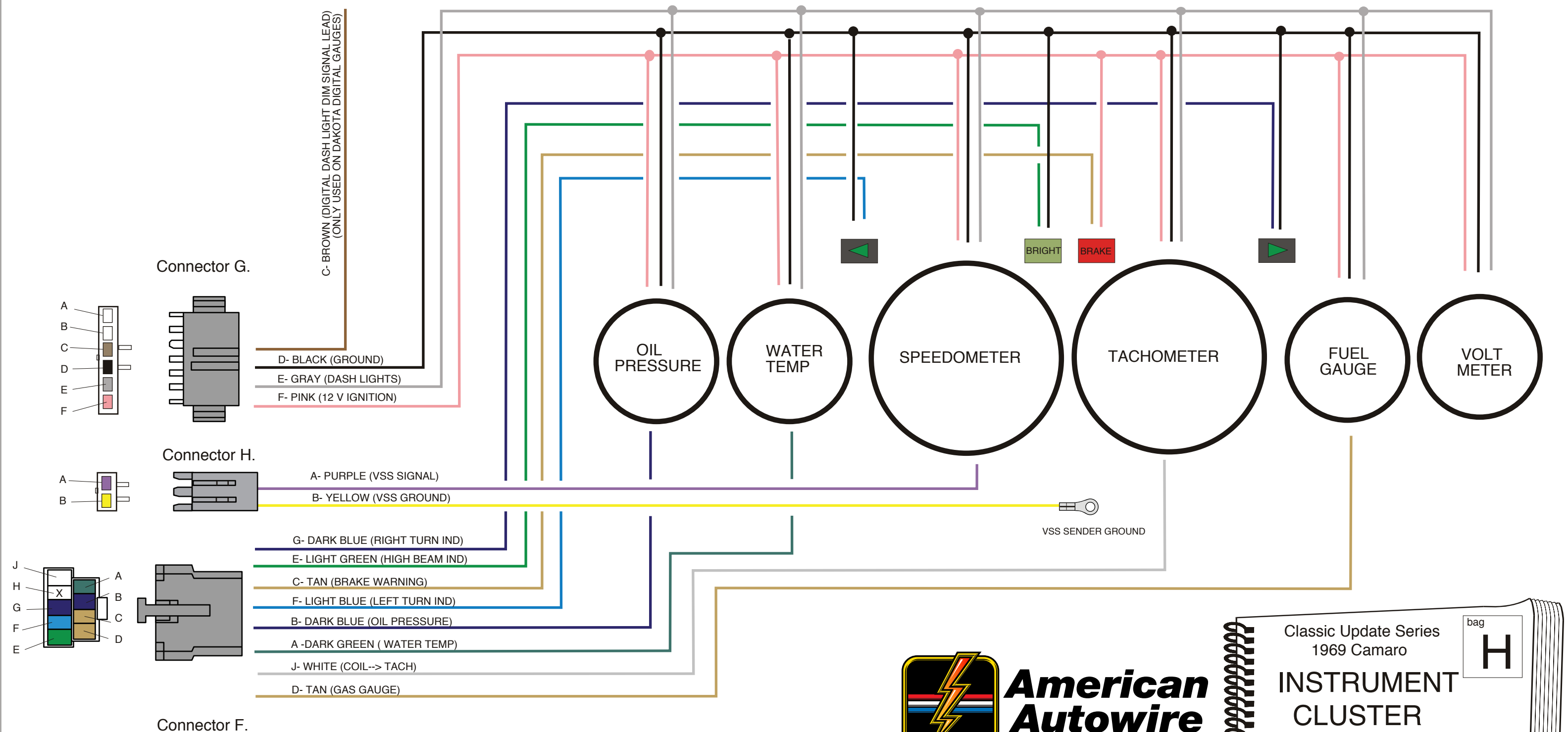

**American
Autowire**

800-482-9473

Classic Update Series
1969 Camaro

**INSTRUMENT
CLUSTER**

500776

92966553 instruction rev 2.0 2/10/2012

bag **H**

Classic Update Series

Circuit Functions for All Instrument Cluster Installations

The following chart explains the functions of each wire in the instrument cluster disconnects.

CONNECTOR F - Plug this connector into the mating connector on the dash harness (bag G) and connect wires as follows:

Wire Color	Circuit Function	Pin	Installation
DK GREEN	Temperature Sender	A	Route this wire to the sender input terminal of the gauge, warning light, or sender terminal of a custom gauge. This wire is supplied as a loose wire that is plugged in, if necessary, into connector F (cavity A), maintaining color continuity with the dark green "WATER TEMP" wire on the mating dash connector. For console gauge applications, this wire is not used as another similar one is routed to the console through the console gauge connector on the 500775 dash harness.
DK BLUE	Oil Pressure Sender	B	Route this wire to the sender input terminal of the gauge, warning light, or sender terminal of a custom gauge. This wire is supplied as a loose wire that is plugged in, if necessary, into connector F (cavity B), maintaining color continuity with the dark blue "OIL PRESSURE" wire on the mating dash connector. For custom console gauge applications, this wire is not used as another similar one is routed to the console through the console gauge connector on the 500775 dash harness.
TAN (no printing)	Brake Lamp	C	OPTIONAL - Route this wire to a brake indicator light output lead wire. This wire is the light ground lead that is set to ground through the emergency brake switch or the brake system balance switch in the proportioning valve manifold.
TAN	Fuel Sender	D	Route this wire to the sender input terminal of the gauge. This wire is supplied as a loose wire that is plugged in, if necessary, into connector F (cavity D), maintaining color continuity with the tan "GAS GAUGE" wire on the mating dash connector. For console gauge applications, this wire is not used as another similar one is routed to the console through the console gauge connector on the 500775 dash harness.
LT GREEN	Hi Beam Indicator Lamp	E	Route this wire to the high beam indicator light input lead wire. The indicator output lead wire is routed to ground.
LT BLUE	Left Turn Lamp	F	Route this wire to the left turn indicator light input lead wire. The indicator output lead wire is routed to ground.
DK BLUE	Right Turn Lamp	G	Route this wire to the right turn indicator light input lead wire. The indicator output lead wire is routed to ground.
BROWN	Alternator	H	OPTIONAL - Used with a stock generator lamp. Custom gauge configurations usually incorporate a voltmeter and will not require a generator/alternator light. This wire is supplied as a loose wire that is plugged in, if necessary, to connector F (cavity H), maintaining color continuity with the brown "ALTERNATOR" wire on the mating dash connector.
WHITE	Tachometer	J	OPTIONAL - <u>Used ONLY with a tachometer.</u> This wire is supplied as a loose wire that is plugged in, if necessary, into connector F (cavity J), maintaining color continuity with the white "TACH" wire on the mating dash connector.

CONNECTOR G - Plug this connector into the mating connector on the dash harness (bag G) and connect wires as follows:

Wire Color	Circuit Function	Pin	Installation
BROWN	Park Lamp	C	OPTIONAL - <u>Used ONLY with digital dash panels.</u> Plug this wire into connector G, maintaining color continuity with the brown "PARK LAMP" wire on the mating dash connector. Connect the other end to the gauge manufacturer's panel - DIM location. This will dim the panel lights when headlights are turned on. This wire is supplied as a loose wire that is plugged in if necessary.
BLACK	Ground	D	The original instrument housing is plastic as are many of the custom aftermarket instrument cluster housings. This requires that each gauge be grounded. Ultimately, the black gauge ground wires from each gauge will be joined in a common in-line splice before the single wire connection is made in connector G. Blue butt splice connectors are provided in loose piece kit 92965220 located in console gauge kit 500664(Bag K) to complete the in-line splice. The grounding circuit is completed in the 500775 dash harness.
GREY	Instrument Lamps	E	This is the common instrument lamp lead for each gauge. Each instrument light lead from each gauge will be joined in a common in-line splice before the single wire connection is made in connector G. Blue butt splice connectors are provided in loose piece kit 92965220 located in console gauge kit 500664(Bag K) to complete the in-line splice. The dash light circuit is completed in the 500775 dash harness.
PINK	12v Ignition	F	This is the common ignition lead for each gauge. Each ignition power lead from each gauge will be joined in a common in-line splice before the single wire connection is made in connector G. Blue butt splice connectors are provided in loose piece kit 92965220 located in console gauge kit 500664(Bag K) to complete the in-line splice. The 12 volt ignition circuit is completed in the ignition buss of the 500775 dash harness.

CONNECTOR H - Plug this connector into the mating connector on the dash harness (bag G) and connect wires as follows:

PURPLE	VSS Signal lead	A	OPTIONAL - <u>Used ONLY with an electronic speedometer.</u> This wire will plug into connector G, maintaining color continuity with the purple wire on the mating dash connector. Connect the other end to the speedometer 'sender' terminal following the manufacturer's instructions. This wire is supplied as a loose wire that is plugged in if necessary.
YELLOW	VSS Signal ground	B	OPTIONAL - <u>Used ONLY with an electronic speedometer.</u> This wire will plug into connector G, maintaining color continuity with the yellow wire on the mating dash connector. Connect the other end to a good chassis ground, following the manufacturer's instructions. This wire is supplied as a loose wire that is plugged in if necessary.

LOOSE WIRES

ORANGE Clock Feed If using a factory in-dash clock, plug this wire into the clock feed on the 500775 dash harness.



Terminal "A"



Terminal "B"



Terminal "C"

- Note: 1. Extra terminals "A" are supplied for Connector "F" should they be necessary.
2. Extra terminals "B" are supplied for Connector "G" should they be necessary.
3. Necessary terminals "C" are provided for use in the stock instrument cluster pods for use wherever necessary.



800-482-9473





www.americanautowire.com 856-933-0801

TYPICAL AFTERMARKET GAUGE CONNECTIONS
(STUD TYPE CONNECTIONS SHOWN)

GAUGE CONNECTIONS

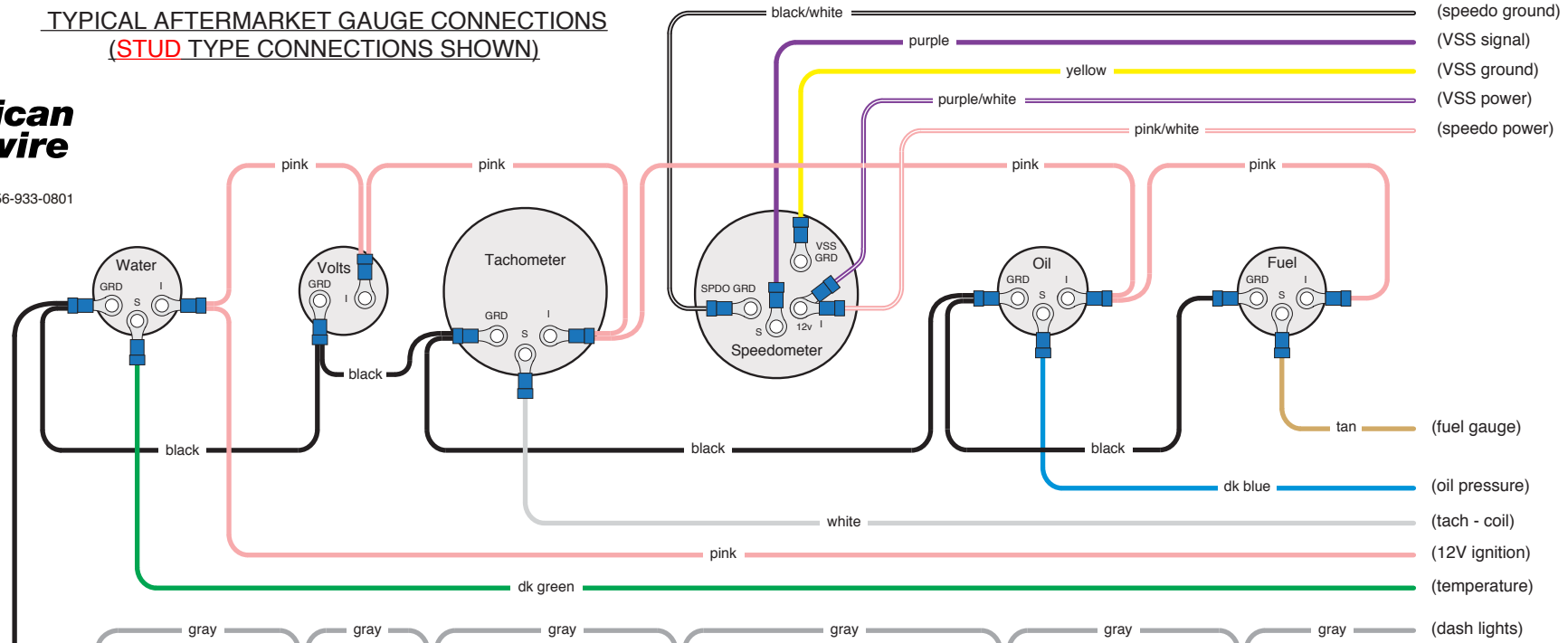

LAMP CONNECTIONS

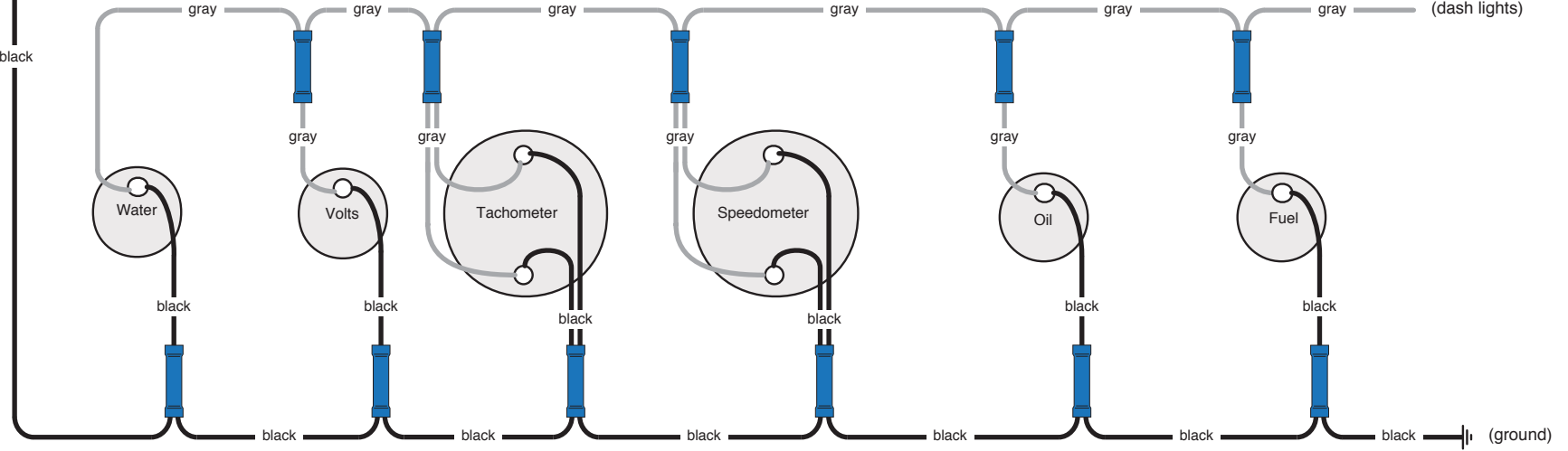

TURN SIGNAL AND HI-BEAM LAMP CONNECTIONS

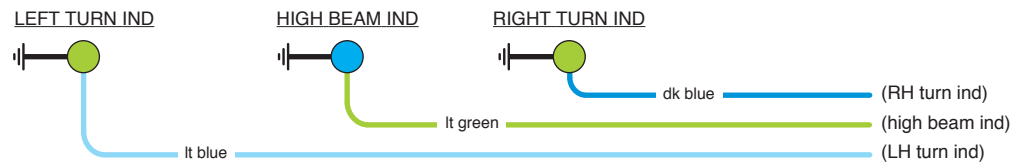

PART # **92965220**
Gauge Connection Kit
 Complete connections
 for aftermarket gauges
 92965221 Rev 1.1 12/12/2014



www.americanautowire.com 856-933-0801

TYPICAL AFTERMARKET GAUGE CONNECTIONS
(BLADE TYPE CONNECTIONS SHOWN)

GAUGE CONNECTIONS

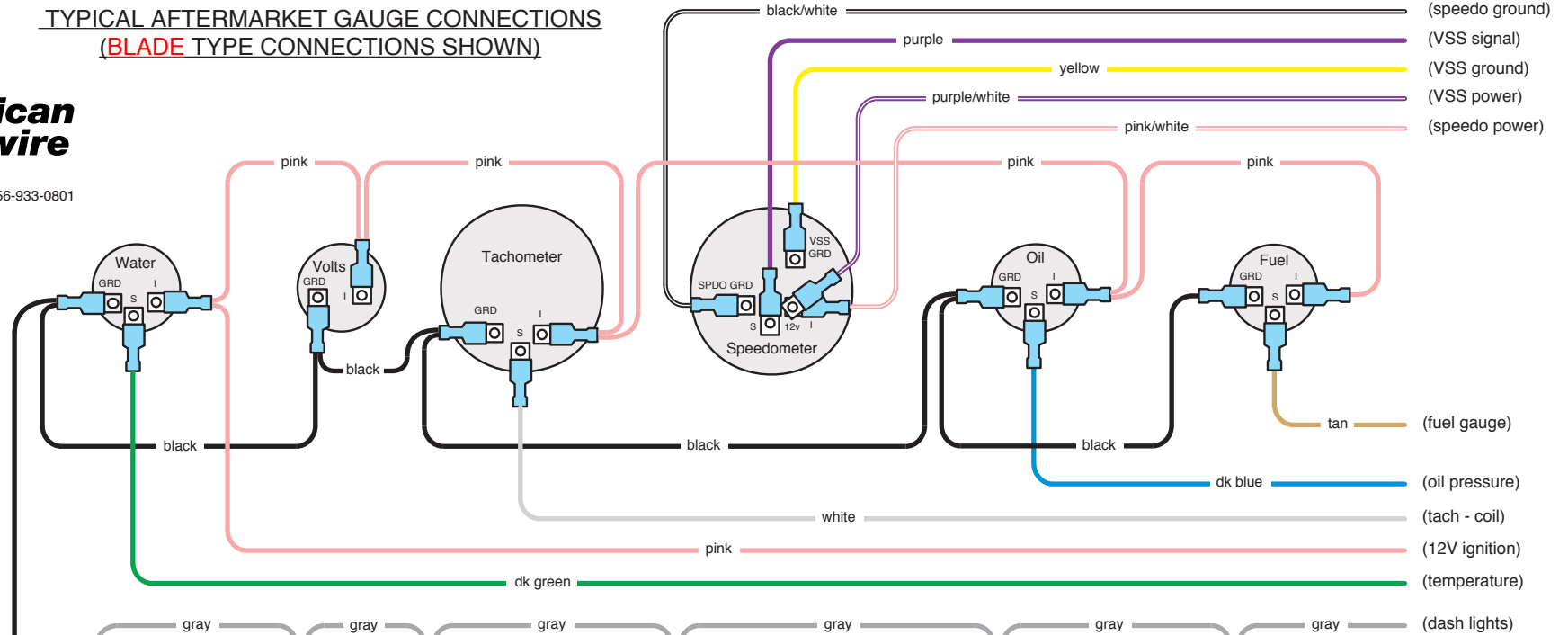

LAMP CONNECTIONS

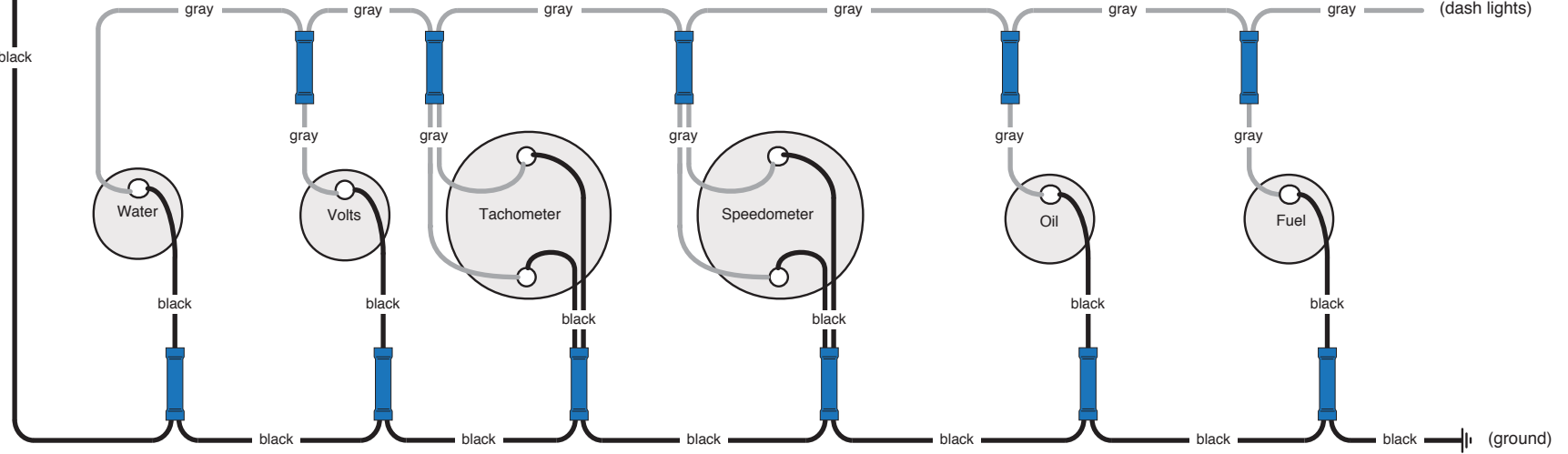

TURN SIGNAL AND HI-BEAM LAMP CONNECTIONS

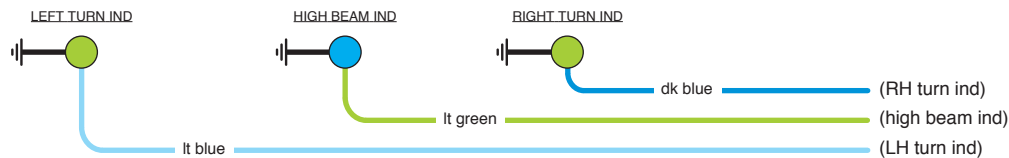

PART # **92965220**
Gauge Connection Kit
 Complete connections
 for aftermarket gauges
 92965221 Rev 1.1 12/12/2014

Classic Update Series

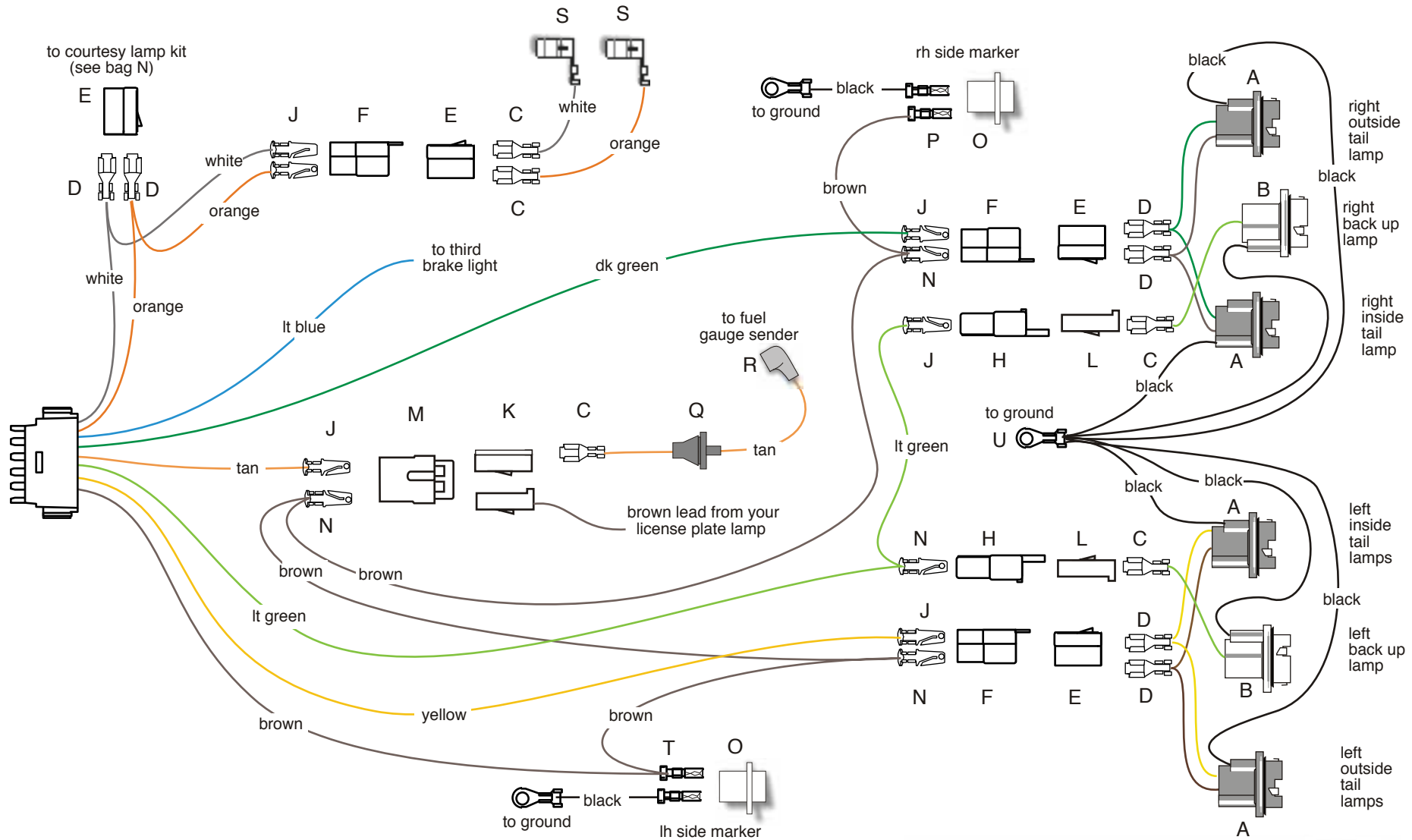

Use the loose piece dk blue wire (power lead) if you are using electric fuel pump.

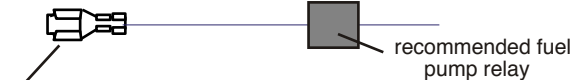

Plug this terminal into the 6 way power feed connector, located on the dash harness.

USE THIS SHEET FOR A NON-RALLY SPORT CAR



American Autowire

www.americanautowire.com 856-933-0801

Classic Update Series
1969 Camaro

bag
M

REAR BODY KIT

500734

92966162 instruction rev 4.0 4/21/2015

Classic Update Series

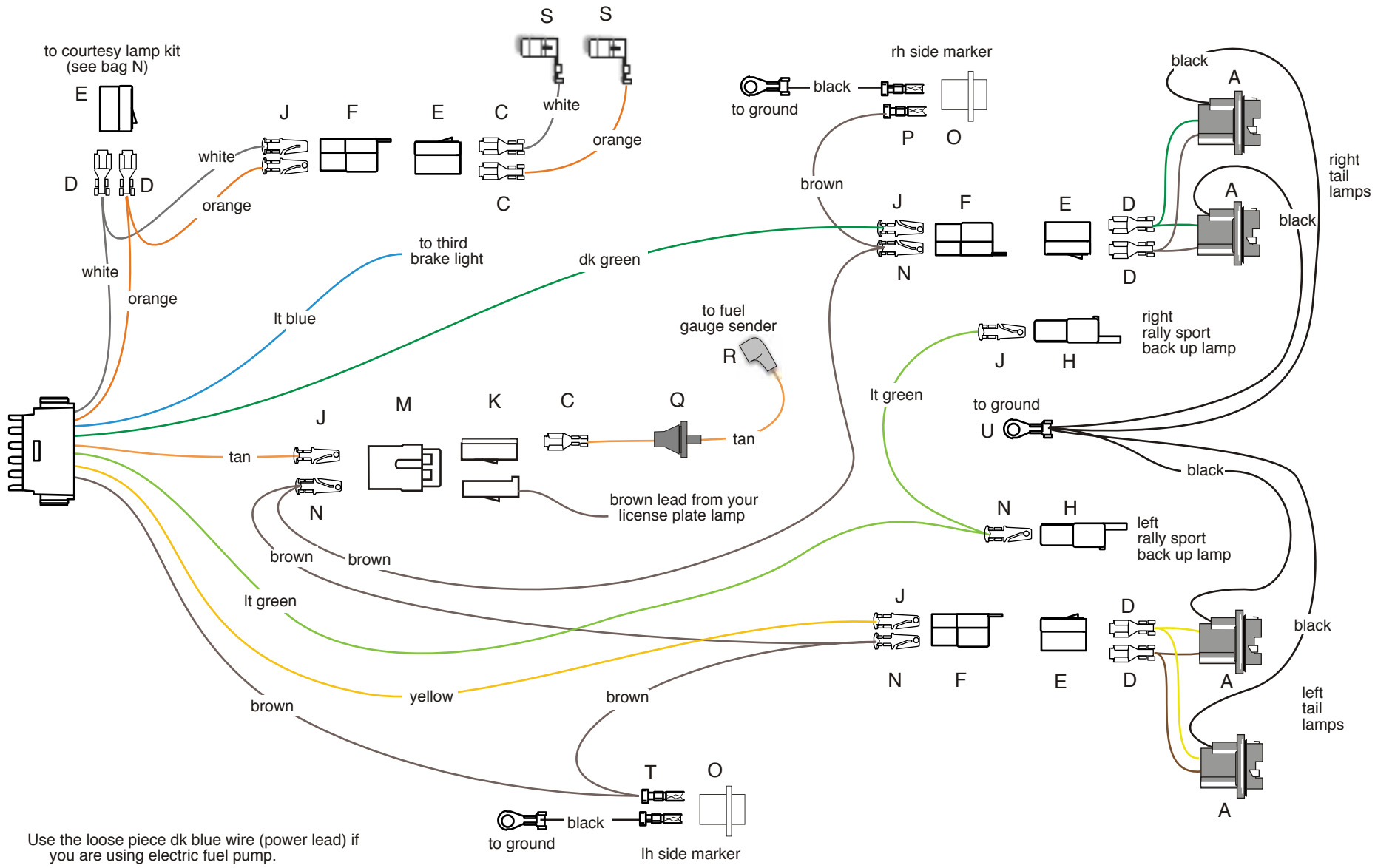

Use the loose piece dk blue wire (power lead) if you are using electric fuel pump.

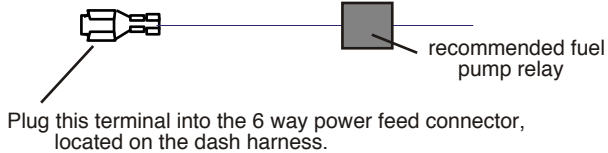

USE THIS SHEET FOR A RALLY SPORT CAR











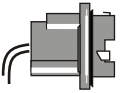
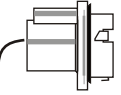



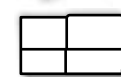
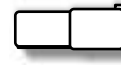

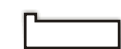

www.americanautowire.com 856-933-0801

USE THIS SHEET FOR A NON-RALLY SPORT CAR

A	Connect the main connector to the mating connector on the dash harness 500662 bag G. Route this harness along door sill and into trunk
LIGHT BLUE	Third brake light Connect to the third brake lamp, if equipped.
B	TAN Fuel signal Route this wire to the rear panel of the trunk (near fuel tank filler) and trim to length. Install terminal J and plug into connector M, as shown on sheet 1.
C	TAN Fuel Tank lead (with rubber end) Plug the rubber end of this wire R onto the sending unit on fuel tank. Route the wire to the stock feed thru hole under fuel tank filler and install rubber grommet Q in direction shown on sheet 1. Secure this wire into hole with the attached grommet. In the trunk area, trim this wire to reach connector M from wire above. Attach terminal C and plug into connector K. Plug connector K into mating connector M. This should match the tan wire from above.
D	
E	Your existing license plate lamp wire will also plug into connector M. (Note: Terminal C and connector L are provided if you need to attach to your lamp wire.)
BROWN	Parking lamps Route this wire to the left side marker and trim to length. Double this wire with the cut off portion and install terminal T and plug into lamp socket O. Route the loose end to the LH tail lamps.
F	Cut to length, and double this wire with the cut off portion, using terminal N. Plug this terminal into connector F, in location shown on Sheet 1. Route the loose end to connector M (from the tan wire above), and cut to length. Double this wire with the cut off portion and install terminal N.
G	Plug this terminal into connector M, in location shown on sheet 1. Route the loose end to the RH tail lamps and repeat the procedure.
H	BLACK Side Marker Ground There are two loose black wires in this kit. Plug each into the rear side markers (connector O). Route the black wires to the rear panel support (near fuel tank filler) and attach to ground.
J	YELLOW LH Stop / Tail Route this wire to the LH tail lamp and cut to length and install terminal J. Plug this wire into connector F from above. Install terminal C and connector E on the tail lamp pigtail A, maintaining color continuity with connector F. Plug connector E into connector F. <u>See Note 1.</u>
K	DK GREEN RH Stop / Tail Route this wire to the RH tail lamp and cut to length and install terminal J. Plug this wire into connector F from above. Install terminal C and connector E on the tail lamp pigtail A, maintaining color continuity with connector F. Plug connector E into connector F. <u>See Note 1.</u>
L	LIGHT GREEN Back up lamp feed Route this wire to the LH back up lamp and trim to length and install terminal N and connector H. Route the loose end of the lt green wire to the right side back up lamp. Repeat this procedure with terminal J. Install terminals C on each of the back up pigtails B, and plug into connectors H.
M	WHITE Courtesy ground At the driver's side kick panel area, cut this wire and double it with the cut off portion using terminal D, and plug into connector E maintaining color continuity with the mating connector in the courtesy lamp kit (bag N).
N	If you are using a dome lamp, route the loose end of this wire to the rear pillar area of the trunk and install terminal J and connector F. Plug into connector F in location shown on Sheet 1. (Note: a factory dome lamp harness will also plug into this connector, if you are not replacing the headliner at this time.) Install the loose white wire S (supplied with terminal installed into the dome lamp. Route this wire to connector F (on white wire) location and trim to length. Install terminal C and connector E, maintaining color continuity with the white wire in connector F.
O	ORANGE Courtesy Lamp At the driver's side kick panel area, cut this wire an double it with the cut off portion using terminal D, and plug into connector E maintaining color continuity with the mating connector in the courtesy lamp kit (bag N).
P	If you are using a dome lamp, route the loose end of this wire to the rear pillar area of the trunk and install terminal J and connector F. Plug into connector F in location shown on Sheet 1. (Note: a factory dome lamp harness will also plug into this connector, if you are not replacing the headliner at this time.) Install the loose orange wire S (supplied with terminal installed) into the dome lamp. Route this wire to connector F (on orange wire) location and trim to length. Install terminal C and connector E, maintaining color continuity with the orange wire in connector F.
Q	This wire can be used if you are using an electric fuel pump. Plug the terminated end into the 6 way power disconnect on the dash harness, maintaining color continuity with the dk blue wire in the mating connector. Route the other end to a fuel pump relay (not included in this kit, but available from American Autowire).
R	DK BLUE Fuel Pump
S	Note 1. The original configuration of the non rally sport tail lights was to have an inside running light, a middle reflector with a backup light, and an outside running/directional/brake light. We have modified this configuration by supplying an inside tail light that is wired for running/directional/ and brake light as opposed to just a running light. The socket indexing is slightly different and requires a slight modification to the tail light housing to mount the light socket into the housing. If you desire the inside tail light to function as per the stock configuration, do not connect the green or yellow wire on the inside light socket.
T	
U	

USE THIS SHEET FOR A RALLY SPORT CAR

A		CONNECT the main connector to the mating connector on the dash harness 500662 bag G. Route this harness along door sill and into trunk LIGHT BLUE Third brake light TAN Fuel signal	Connect to the third brake lamp, if equipped. Route this wire to the rear panel of the trunk (near fuel tank filler) and trim to length. Install terminal J and plug into connector M, as shown on sheet 2.
B		TAN Fuel Tank lead (with rubber end)	Plug the rubber end of this wire R onto the sending unit on fuel tank. Route the wire to the stock feed thru hole under fuel tank filler and install rubber grommet Q in direction shown on sheet 5. Secure this wire into hole with the attached grommet. In the trunk area, trim this wire to reach connector M from wire above. Attach terminal C and plug into connector K. Plug connector K into mating connector M. This should match the tan wire from above.
C			
D			
E		BROWN Parking lamps	Your existing license plate lamp wire will also plug into connector M. (Note: Terminal C and connector L are provided if you need to attach to your lamp wire.) Route this wire to the left side marker and trim to length. Double this wire with the cut off portion and install terminal P and plug into lamp socket O. Route the loose end to the LH tail lamp. Cut to length, and double this wire with the cut off portion, using terminal N. Plug this terminal into connector F, in location shown on sheet 2. Route the loose end to the other LH tail lamp and repeat.
F			Route the loose end to connector M (from the tan wire above), and cut to length. Double this wire with the cut off portion and install terminal N. Plug this terminal into connector M, in location shown on sheet 2. Route the loose end to the RH tail lamps and repeat the procedure.
H		BLACK Side Marker Ground	There are two loose black wires in this kit. Plug each into the rear side markers (connector O). Route the black wires to the rear panel support (near fuel tank filler) and attach to ground.
J		YELLOW LH Stop / Tail	Route this wire to the LH tail lamp and cut to length. Double this wire with the cut off portion and install terminal N. Plug this wire into connector F from above. Route the loose end to the other LH tail lamp and cut to length. Install terminal J and plug into connector F, as shown on sheet 2. Install terminals C and connector E on the tail lamp pigtailed A, maintaining color continuity with connector F. Plug connectors E into connectors F.
K			
L		DK GREEN RH Stop / Tail	Route this wire to the RH tail lamp and cut to length. Double this wire with the cut off portion and install terminal N. Plug this wire into connector F from above. Route the loose end to the other RH tail lamp and cut to length. Install terminal J and plug into connector F, as shown on sheet 2. Install terminals C and connector E on the tail lamp pigtailed A, maintaining color continuity with connector F. Plug connectors E into connectors F.
M		LIGHT GREEN Back up lamp feed	Route this wire to the LH back up lamp and trim to length. Double this wire with the cut off portion and install terminal N and connector H. Plug connector H into your Rally Sport back up lamp assembly. Route the loose end of the lt green wire to the right side back up lamp.
N		WHITE Courtesy ground	Install terminal J and connector H. Plug connector H into your Rally Sport back up lamp assembly. At the driver's side kick panel area, cut this wire and double it with the cut off portion using terminal D, and plug into connector E maintaining color continuity with the mating connector in the courtesy lamp kit (bag N).
O			If you are using a dome lamp, route the loose end of this wire to the rear pillar area of the trunk, and install terminal J and connector F. Plug into connector F in location shown on sheet 2. (Note: a factory dome lamp harness will also plug into this connector, if you are not replacing the headliner at this time.) Install the loose white wire S (supplied with terminal installed) into the dome lamp. Route this wire to connector F (on white wire) location and trim to length. Install terminal C and connector E, maintaining color continuity with the white wire in connector F.
P			
Q		ORANGE Courtesy Lamp	At the driver's side kick panel area, cut this wire and double it with the cut off portion using terminal D, and plug into connector E maintaining color continuity with the mating connector in the courtesy lamp kit (bag N).
R			If you are using a dome lamp, route the loose end of this wire to the rear pillar area of the trunk, and install terminal J and connector F. Plug into connector F in location shown on sheet 2. (Note: a factory dome lamp harness will also plug into this connector, if you are not replacing the headliner at this time.) Install the loose orange wire S (supplied with terminal installed) into the dome lamp. Route this wire to connector F (on orange wire) location and trim to length. Install terminal C and connector E, maintaining color continuity with the orange wire in connector F.
S			
T		DK BLUE Fuel Pump	This wire can be used if you are using an electric fuel pump. Plug the terminated end into the 6 way power disconnect on the dash harness, maintaining color continuity with the dk blue wire in the mating connector. Route the other end to a fuel pump relay (not included in this kit, but available from American Autowire).
U			

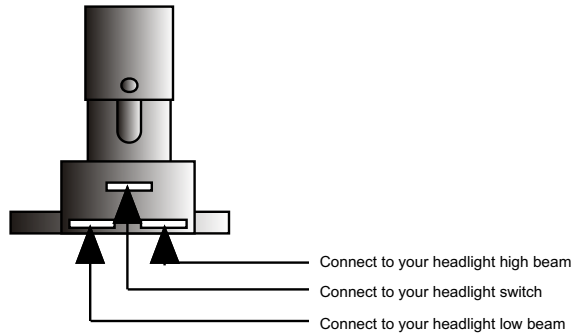

Connect the Dimmer Switch wires as shown above.

1. The top center terminal of the Dimmer Switch is connected to the Headlight switch.
2. The terminal on the right side is connected to your headlight high beam terminal.
3. The terminal on the left side is connected to your headlight low beam terminal.

another wiring product by...



150 Heller Pl #17 W Bellmawr, NJ 08031 856-933-0801

PART #

500042

DESCRIPTION:

DIMMER SWITCH

92964573 instruction sheet Rev 3.0 6/29/99

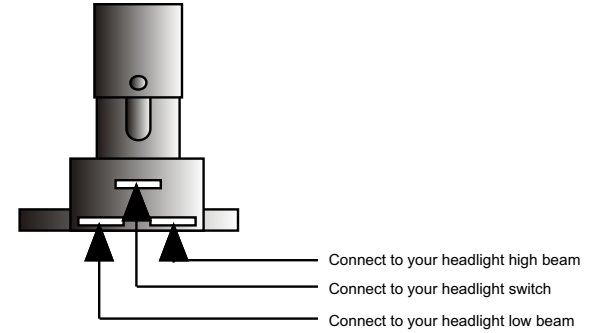

Connect the Dimmer Switch wires as shown above.

1. The top center terminal of the Dimmer Switch is connected to the Headlight switch.
2. The terminal on the right side is connected to your headlight high beam terminal.
3. The terminal on the left side is connected to your headlight low beam terminal.

another wiring product by...



150 Heller Pl #17 W Bellmawr, NJ 08031 856-933-0801

PART #

500042

DESCRIPTION:

DIMMER SWITCH

92964573 instruction sheet Rev 3.0 6/29/99

Most switches supplied with Classic Update and Universal Kits ship with the shaft pre-installed. In many instances, the switch can be installed without removing the shaft, but in some cases the switch shaft may need to be trimmed to fit your specific dash. In this situation, reference Trim to Fit instructions on the back of this page for details.

To install your new headlight switch:

1. Install the switch from behind the dash, and align the switch body with the mounting hole. The switch body has an alignment tab that must line up with the notch in the dashboard mounting hole.

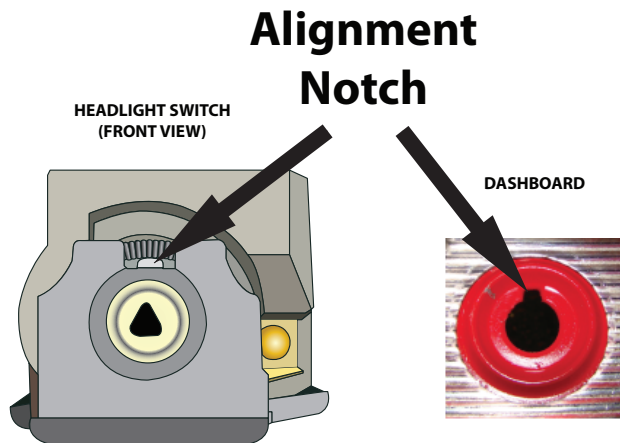

2. Install the switch mounting nut and tighten.

3. Gently press shaft into switch until it stops, then press firmly until it “clicks.” Pull shaft back out to confirm it is seated correctly. The shaft should be locked into place inside switch.

4. If the shaft does not lock, reinsert applying moderate pressure and slowly move shaft side to side for lock to engage. Make sure switch body is still supported to prevent flexing. Press shaft firmly until it clicks into place.

5. Ensure the shaft is fully seated and in the off position.

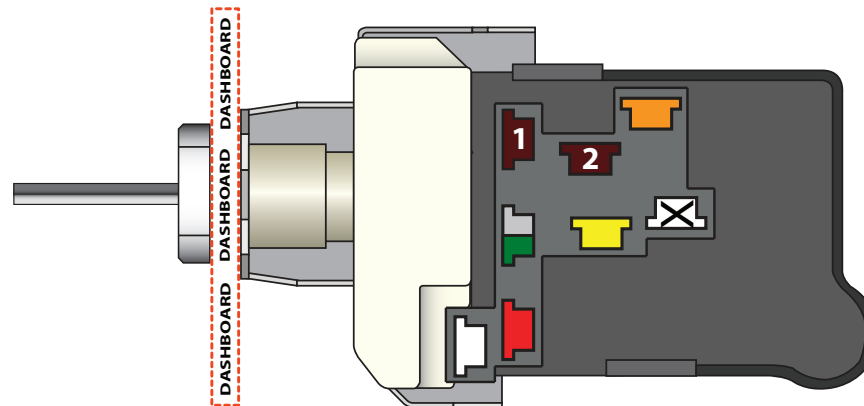

1	Parking Lights - Stay on with headlights
2	Tail Lights - On in the park and headlight positions
	Fused Battery Feed - For park, tail and dash lamps
	Headlight Feed - Power to the headlight dimmer switch
	12V Battery Feed - Unfused power to the switch for headlights
	Courtesy Ground - Ground feed to the dome and courtesy lights
	Part-Time Parking Lights - Turns off when the headlights are on (Not supported by all kits)
	Dash Lights - Output to the dash light fuse or lights



www.americanautowire.com 856-933-0801

PART #

500332

DESCRIPTION:

Headlight Switch

92964649

Rev 3.0

1/3/2020

To Trim Shaft to Fit or Remove Shaft:

The headlight shaft knob should extend from the face of the mounting nut, and must allow enough clearance for the switch to turn off. If the shaft is longer than necessary for your specific dash it can be trimmed to fit. Always trim the knob end of the shaft only and follow the guidelines below for best results.

1. With the headlight switch installed, loosen the set screw and remove the knob. Make sure the switch is in the "off" position by pushing the shaft toward the back of the switch.

Switch in OFF position
(shaft pushed all the way in)

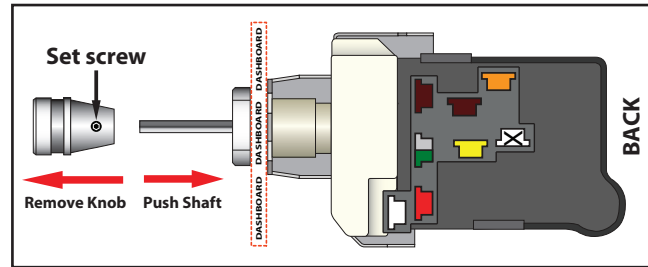

2. Set knob alongside shaft and mark the desired location for cutting on the shaft.

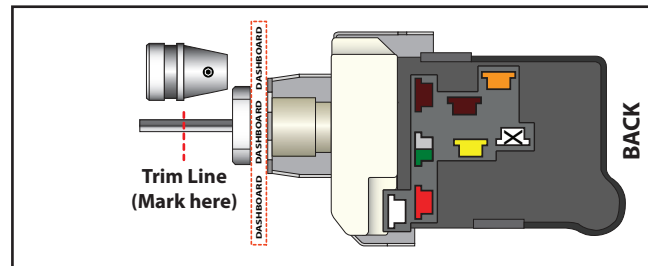

3. Remove the shaft and trim at mark. The shaft can be released from the switch by pulling it outward (toward the rear of the vehicle). Once fully in the "On" position, press and hold the release button on the base of the switch body. Once button is pressed, continue to pull the shaft outward. New switches may be tight, and it might be necessary to move the shaft side to side slightly while pulling to release.

