



# NSS evo3

## Installation Manual

ENGLISH





# Preface

---

## Disclaimer

As Navico is continuously improving this product, we retain the right to make changes to the product at any time which may not be reflected in this version of the manual. Please contact your nearest distributor if you require any further assistance.

It is the owner's sole responsibility to install and use the equipment in a manner that will not cause accidents, personal injury or property damage. The user of this product is solely responsible for observing safe boating practices.

NAVICO HOLDING AS AND ITS SUBSIDIARIES, BRANCHES AND AFFILIATES DISCLAIM ALL LIABILITY FOR ANY USE OF THIS PRODUCT IN A WAY THAT MAY CAUSE ACCIDENTS, DAMAGE OR THAT MAY VIOLATE THE LAW.

Governing Language: This statement, any instruction manuals, user guides and other information relating to the product (Documentation) may be translated to, or has been translated from, another language (Translation). In the event of any conflict between any Translation of the Documentation, the English language version of the Documentation will be the official version of the Documentation.

This manual represents the product as at the time of printing. Navico Holding AS and its subsidiaries, branches and affiliates reserve the right to make changes to specifications without notice.

## Copyright

Copyright © 2016 Navico Holding AS.

## Warranty

The warranty card is supplied as a separate document.

In case of any queries, refer to the brand website of your unit or system: [www.simrad-yachting.com](http://www.simrad-yachting.com).

## Compliance statements

This equipment complies with:

- CE under 2014/53/EU Directive
- The requirements of level 2 devices of the Radio communications (Electromagnetic Compatibility) standard 2008
- Part 15 of the FCC Rules. Operation is subject to the following two conditions: (1) this device may not cause harmful interference, and (2) this device must accept any interference received, including interference that may cause undesired operation.

The relevant Declaration of conformity is available in the product's section at the following website: [www.simrad-yachting.com](http://www.simrad-yachting.com).

## Industry Canada

### IC RSS-GEN, Sec 7.1.3 Warning Statement- (Required for license exempt devices)

This device complies with Industry Canada license-exempt RSS standard(s). Operation is subject to the following two conditions: (1) this device may not cause interference, and (2) this device must accept any interference, including interference that may cause undesired operation of the device.

Le présent appareil est conforme aux CNR d'Industrie

Canada applicables aux appareils radio exempts de licence. L'exploitation est autorisée aux deux conditions suivantes: (1) l'appareil ne doit pas produire de brouillage, et (2) l'utilisateur de l'appareil doit accepter tout brouillage radioélectrique subi, même si le brouillage est susceptible d'en compromettre le fonctionnement.

## Warning

The user is cautioned that any changes or modifications not expressly approved by the party responsible for compliance could void the user's authority to operate the equipment.

This equipment generates, uses and can radiate radio frequency energy and, if not installed and used in accordance with the instructions, may cause harmful interference to radio communications. However, there is no guarantee that the interference will not occur in a particular installation. If this equipment does cause harmful interference to radio or television reception, which can be determined by turning the equipment off and on, the user is encouraged to try to correct the interference by one or more of the following measures:

- Reorient or relocate the receiving antenna
- Increase the separation between the equipment and receiver
- Connect the equipment into an outlet on a circuit different from that of the receiver
- Consult the dealer or an experienced technician for help

## Internet usage

Some features in this product use an internet connection to perform data downloads and uploads. Internet usage via a connected mobile/cell phone internet connection or a pay-per-MB type internet connection may require large data usage. Your service provider may charge you based on the amount of data you transfer. If you are unsure, contact your service provider to confirm rates and restrictions.

## Countries of intended use in the EU

AT - Austria  
BE - Belgium  
BG - Bulgaria  
CY - Cyprus  
CZ - Czech Republic  
DK - Denmark  
EE - Estonia  
FI - Finland  
FR - France  
DE - Germany  
GR - Greece  
HU - Hungary  
IS - Iceland  
IE - Ireland  
IT - Italy  
LV - Latvia  
LI - Liechtenstein  
LT - Lithuania  
LU - Luxembourg  
MT - Malta  
NL - Netherlands  
NO - Norway  
PL - Poland  
PT - Portugal  
RO - Romania  
SK - Slovak Republic  
SI - Slovenia  
ES - Spain  
SE - Sweden  
CH - Switzerland  
TR - Turkey  
UK - United Kingdom

## Trademarks

Navico® is a registered trademark of Navico.

Simrad® is used by license from Kongsberg.

NMEA® and NMEA 2000® are registered trademarks of the National Marine Electronics Association.

FLIR® is a registered trademark of FLIR.

Mercury® is a registered trademark of Mercury.

SmartCraft VesselView® is a registered trademark of Mercury.

Suzuki® is a registered trademark of Suzuki.

SimNet® is a registered trademark of Navico.

C-MAP® is a registered trademark of C-MAP.

SD™ and microSD™ are trademarks or registered trademarks of SD-3C, LLC in the United States, other countries or both.

HDMI® and HDMI™, the HDMI Logo, and High-Definition Multimedia Interface are trademarks or registered trademarks of HDMI Licensing LLC in the United States and other countries.

## Navico product references

This manual refers to the following Navico products:

- Broadband Sounder™ (Broadband Sounder)
- DownScan Overlay™ (Overlay)
- GoFree™ (GoFree)
- Halo™ Pulse Compression Radar (Halo Radar)
- INSIGHT GENESIS® (Insight Genesis)
- StructureScan® (StructureScan)

## About this manual

This manual is a reference guide for installing NSS evo3 units.

Important text that requires special attention from the reader is emphasized as follows:

→ **Note:** Used to draw the reader's attention to a comment or some important information.

**⚠ Warning:** Used when it is necessary to warn personnel that they should proceed carefully to prevent risk of injury and/or damage to equipment/personnel.

# Contents

---

<b>8</b>	<b>Check the contents</b>
<b>9</b>	<b>Overview</b>
9	Front controls
10	Rear connections
10	Card reader
<b>11</b>	<b>Installation</b>
11	Mounting location
12	Bracket mounting
12	Flush mounting
13	Bezel Fitment and Removal
13	Transducer mounting location
<b>15</b>	<b>Wiring</b>
15	Guidelines
15	Power connection
15	Power Control connection
17	Power Control master/slave bus
18	External alarm
18	Connect an external monitor
19	NMEA 2000 backbone
20	NMEA 0183 device connection
21	CZone connection to NMEA 2000
21	Transducer connection
22	Ethernet connector
23	Video in
<b>24</b>	<b>Software Setup</b>
24	First time startup
24	Configuring the WheelKey
24	Time and Date
24	Power Control
24	Data source selection
26	Device list
26	SimNet Groups
26	Diagnostics
27	Damping
27	Calibration
27	External Alarm Setup
27	Echosounder setup
30	StructureScan
30	Radar setup
33	Video In configuration
33	Autopilot setup
33	Fuel setup
35	CZone setup
36	Wireless setup
39	NMEA 0183 setup
41	NMEA 2000 setup
41	Ethernet setup
43	Mercury®
43	Suzuki Marine®
43	Software updates and data backup
<b>45</b>	<b>Accessories</b>
45	NSS evo3 accessories

<b>46</b>	<b>Supported data</b>
46	NMEA 2000 compliant PGN List
48	NMEA 0183 supported sentences
<b>49</b>	<b>Technical specifications</b>
49	Technical specifications
<b>51</b>	<b>Dimensional drawings</b>
51	7" Unit dimensions
51	9" Unit dimensions
52	12" Unit dimensions
52	16" Unit dimensions

# 1

## Check the contents

---

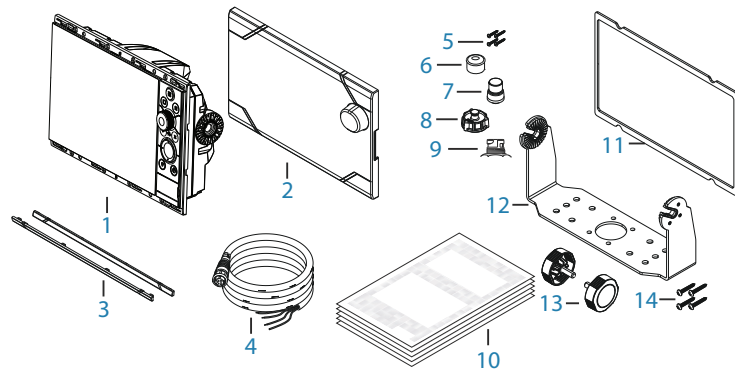

- 1** Display unit
- 2** Sun cover
- 3** Bezel trim
- 4** Power cable
- 5** Self tapping pozi screws, 4Gx1/2" (x4 for 7", x8 for 9"/12", & x12 for 16" units)
- 6** Dust caps, different sizes for NMEA 2000 (x1), Ethernet (x1 for 7"/9", x2 for 12"/16") and Sonar (x2) connectors
- 7** Dust cap for HDMI connector (12" and 16" only)
- 8** Dust cap for Video/NMEA 0183 connector
- 9** Dust cap for USB (16" only)
- 10** Document pack
- 11** Foam gasket (self adhesive)
- 12** U-bracket
- 13** Bracket knobs
- 14** Self tapping pozi screws for bracket, 14G x 1"



# 2

## Overview

The unit has a built-in CHIRP/Broadband, StructureScan and ForwardScan Echosounder.

The unit can network over NMEA 2000, and Ethernet allows access to data as well as control of numerous optional devices that can provide Echosounder, radar, audio entertainment, weather and digital switching.

The unit has a built-in high speed GPS receiver (10Hz) and supports Insight charts from Navico including Insight Genesis. The system also supports charts from Navionics and C-MAP as well as content created by a variety of third party mapping providers in the AT5 format. For a full selection of available charts, visit [www.gofreemarine.com](http://www.gofreemarine.com), [www.c-map.com](http://www.c-map.com) or [www.navionics.com](http://www.navionics.com).

The unit may be mounted to the vessel with the supplied mounting bracket, or panel mounted.

The unit can operate on 12 V or 24 V systems.

## Front controls

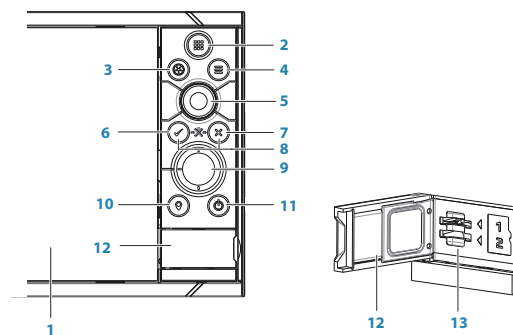

**1 Touch screen**

**2 Pages/Home** - press to open the Home page for page selection and setup options

**3 WheelKey** - user configurable key, refer to "*Configuring the WheelKey*" on page 24. Default without an autopilot connected to the system:

- Short press: toggles between panels on split screen
- Long press: maximizes active panel on split screen

Default with an autopilot connected to the system:

- Short press: opens the autopilot controller and puts the autopilot in standby mode
- Long press: toggles between panels on split screen

**4 Menu key** - press to display the active panel's menu

**5 Rotary knob** - turn to zoom or scroll the menu, press to select an option

**6 Enter key** - press to select an option or to save settings

**7 Exit key** - press to exit a dialog, return to previous menu level, and clear the cursor from the panel

**8 MOB** - press simultaneously the **Enter** and **Exit** keys to create a MOB at the vessel's position

**9 Arrow keys** - press to activate the cursor or to move the cursor  
Menu operation: press to navigate through menu items and to adjust a value

**10 Mark key** - press to place waypoint at vessel position or at cursor position when cursor is active

**11 Power key** - press and hold to turn the unit ON/OFF

Press once to display the System Controls dialog, additional presses to toggle through three default dimming levels

- 12 **Card reader door**
- 13 **Dual card reader slots**

## Rear connections

### All units

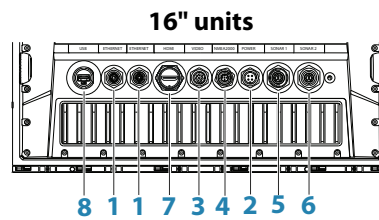
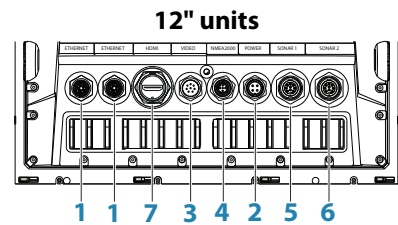
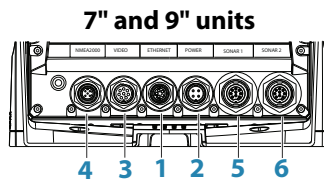

- 1 **Ethernet** - connection to high bandwidth network modules
- 2 **Power** - 12 V or 24 V DC supply input
- 3 **Video** - input for video sources such as cameras, and NMEA 0183 port
- 4 **NMEA 2000** - dynamic data
- 5 **Sonar 1** - single channel CHIRP, 50/200 kHz conventional or HDI transducer
- 6 **Sonar 2** - single channel CHIRP, 50/200 kHz conventional, TotalScan, StructureScan or ForwardScan transducer
- 7 **HDMI** - video output for external monitor
- 8 **USB** - mouse, keyboard or mass storage

## Card reader

Used for inserting a microSD memory card. The memory card can be used for detailed chart data, software updates, transfer of user data, and system backup.

→ **Note:** Do not download, transfer or copy files to a chart card. Doing so can damage chart information on the chart card.

The card reader door should always be securely shut immediately after inserting or removing a card, in order to prevent possible water ingress.

# 3

## Installation

---

### Mounting location

Choose the mounting locations carefully before you drill or cut.

For overall width and height requirements, refer to "*Dimensional drawings*" on page 51.

Do not mount any part where it can be used as a hand hold, where it might be submerged, or where it will interfere with the operation, launching, or retrieving of the boat.

The unit should be mounted so that the operator can easily use the controls and clearly see the screen.

The unit has a high-contrast screen and is viewable in direct sunlight, but for best results install the unit out of direct sunlight. The chosen location should have minimal glare from windows or bright objects.

Consider the optimum viewing angle when determining installation, refer to "*Viewing angle*" on page 12.

The mounting location may affect the internal GPS receiver. Test the unit in its intended location to ensure satisfactory reception. An external GPS source can be added to overcome poor reception areas.

Check that it is possible to route cables to the intended mounting location.

Leave sufficient clearance to connect all relevant cables.

Before cutting a hole in a panel, make sure that there are no hidden electrical wires or other parts behind the panel.

Ensure that any holes cut are in a safe position and will not weaken the boat's structure. If in doubt, consult a qualified boat builder, or marine electronics installer.

→ **Note:** Where flush mounted, the enclosure should be dry and well ventilated. In small enclosures, it may be required to fit forced cooling.

**⚠ Warning:** Inadequate ventilation and subsequent overheating of the unit may cause unreliable operation and reduced service life. Exposing the unit to conditions that exceeds the specifications could invalidate your warranty. – refer to "*Technical specifications*" on page 49.

## Viewing angle

The viewing angle influences the viewability of the monitor. The recommended viewing angles relative to perpendicular are shown in the illustrations below.

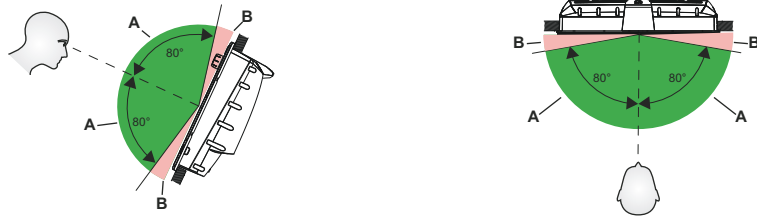

- A** Optimum viewing angle
- B** Poor viewing angle or obstructed view

## Bracket mounting

### U-bracket mounting

1. Place the bracket in the desired mounting location. Ensure that the chosen location has enough height to accommodate the unit fitted in the bracket, and allows tilting of the unit. Also adequate space is required on both sides to allow tightening and loosening of the knobs.
2. Mark the screw locations using the bracket as a template, and drill pilot holes. Use fasteners suited to the mounting surface material. If the material is too thin for self-tappers, reinforce it, or mount the bracket with machine screws and large washers. Use only 304 or 316 stainless steel fasteners.
3. Screw down the bracket.

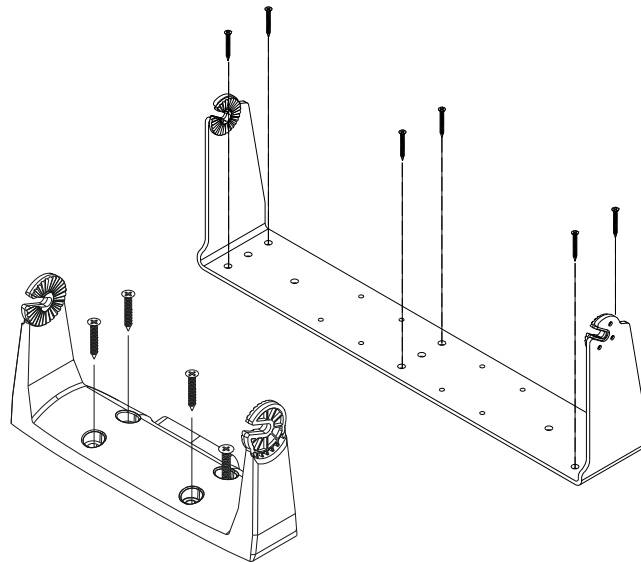

4. Mount the unit to the bracket using the knobs. Hand tighten only. The ratchet teeth in the bracket and unit ensure a positive grip and prevent the unit from changing from the desired angle.

### Flush mounting

Use the separate Mounting template to flush mount the unit.

- **Note:** Remember to attach the foam gasket (self adhesive) to rear of unit before flush mounting.

## Bezel Fitment and Removal

When fitting bezels, ensure hook tabs on back of each bezel recess in to opposing slots on screen frame. Once flush with front surface of screen, slide top bezel to the left, and bottom bezel to the right to lock in to place.

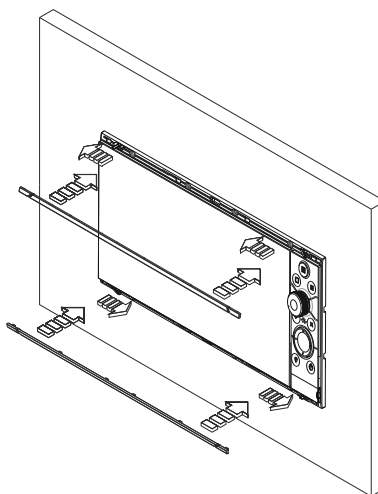

The bezel trim have been designed to be very low profile, and therefore fully conceal the locking tabs that keep them from being accidentally disengaged from the mounting flange. To release the locking tab, gently lever the centre of the bezel trim away from the mounting flange. To remove the cover, simultaneously slide it sideways; to the right for the top bezel, and to the left for the bottom bezel.

## Transducer mounting location

Transducer location selection and installation are two of the most critical steps in sonar installation. To function properly the transducer must be in the water at all times, and in a location that has a smooth flow of water when the boat is moving.

### Research

Before starting the installation of the transducer, check the following:

- Find out if the boat builder has a recommended installation location
- Establish the direction of rotation of the propeller(s)
- With the boat traveling at cruising speed, watch the water flow behind the boat to find the area with the smoothest flow (least bubbles)

### Select a transducer location

The primary aim is to stay clear of propeller and hull generated turbulence, while mounting the transducer as close to the center of the vessel as possible.

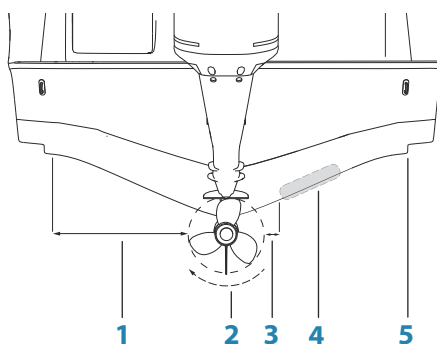

- 1 Avoid mounting within 1 m (3.3') to port (left) of propeller**
- 2 Conventional clockwise propeller rotation**
- 3 Avoid mounting within 7.5 cm (3") to starboard of propeller**
- 4 Best mounting location - undisturbed water flow**
- 5 Planing strake - avoid mounting behind here**

- **Note:** Reverse the distance guides (1 & 3) from propeller where engine is of counterclockwise configuration.
- **Note:** Vessels with strakes or ribs on the hull can create large amounts of turbulence at higher speeds. A good transducer location on these types of boats is between the ribs closest to the engine.
- **Note:** If the transducer is not placed in a smooth flow of water, interference caused by bubbles and turbulence may show onscreen in the form of random lines or dots. The unit could also lose bottom signal when the boat is on plane.
- **Note:** Trim tabs vary in the amount of turbulence they create as they are adjusted, stay clear of these.

### **Transducer installation**

For transducer installation information, refer to separate installation instructions included with the transducer.

# 4

## Wiring

### Guidelines

Don't:

- make sharp bends in the cables
- run cables in a way that allows water to flow down into the connectors
- run the data cables adjacent to radar, transmitter, or large/high current carrying cables or high frequency signal cables.
- run cables so they interfere with mechanical systems
- run cables over sharp edges or burrs

Do this:

- make drip and service loops
- use cable-tie on all cables to keep them secure
- solder/crimp and insulate all wiring connections if extending or shortening the cables. Extending cables should be done with suitable crimp connectors or solder and heat shrink. Keep joins as high as possible to minimize possibility of water immersion.
- leave room adjacent to connectors to ease plugging and unplugging of cables

**⚠ Warning:** Before starting the installation, be sure to turn electrical power off. If power is left on or turned on during the installation, fire, electrical shock, or other serious injury may occur. Be sure that the voltage of the power supply is compatible with the unit.

**⚠ Warning:** The positive supply wire (red) should always be connected to (+) DC with the supplied fuse or a circuit breaker (closest available to fuse rating).

### Power connection

The unit is designed to be powered by a 12 or 24 V DC system. It is protected against reverse polarity, under voltage and over voltage (for a limited duration).

A fuse should be fitted to the positive supply; 3 A for the 7" and 9" units, and 5 A for the 12" and 16" units.

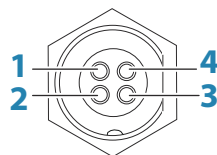

Unit socket (male)

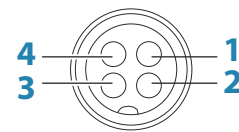

Cable plug (female)

Key	Purpose	Color
1	DC negative	Black
2	External alarm	Blue
3	Power control	Yellow
4	+12/24 V DC	Red

### Power Control connection

→ **Note:** If the control unit is set to Power Slave, the unit cannot be powered down using its own power key. Pressing and holding this key will set the unit to standby. Refer to "Power Control" on page 24.

The yellow Power Control wire in the power cable can either be an input that will turn on the unit when power is applied, or an output that turns on other devices when the unit is powered on. It can be configured at the installation stage to control the power state of displays and compatible devices. When commissioning the system, the unit can be set to be a Power Control Slave or Power Control Master.

Power Control configuration options of the unit are:

- Unit turns on when power key pressed: Yellow wire not connected.
- Unit turns on when power source is turned on: Common red and yellow wires.
- Unit turns on with power key, as well as other compatible devices such as Broadband Radar: Yellow wires connected together (Power Control Bus). (Set one or more displays to be a Power Control Master.)

### Power Control unconnected

Device will turn on and off when the power button on the front of the unit is pressed. Leave the yellow Power Control wire disconnected and tape or heat-shrink the end to prevent shorting.

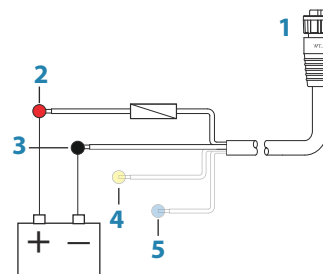

- 1 Power cable connector to unit
- 2 Positive wire (red)
- 3 Ground wire (black)
- 4 Power control wire (yellow)
- 5 Alarm wire (blue)

### Power Control to supply positive (auto on)

Device will turn on immediately when power is applied. Common the yellow wire with the red wire after the fuse.

→ **Note:** The unit cannot be powered down by power button, but can be put in to standby mode. (The screen backlight turns off.)

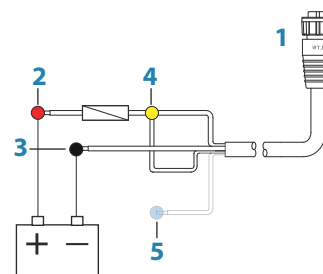

- 1 Power cable connector to unit
- 2 Positive wire (red)
- 3 Ground wire (black)
- 4 Power control wire (yellow)
- 5 Alarm wire (blue)



## Power Control to ignition

Device will turn on once ignition is turned on to start engines. Connect the yellow wire to the accessories output of the engine key switch.

→ **Note:** Engine start batteries and house batteries should have a common ground connection.

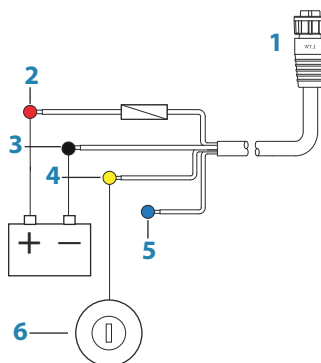

- 1 Power cable connector to unit
- 2 Positive wire (red)
- 3 Ground wire (black)
- 4 Power control wire (yellow)
- 5 Alarm wire (blue)
- 6 Ignition switch

## Power Control master/slave bus

Turning on the 'master' device turns on connected 'slave' devices.

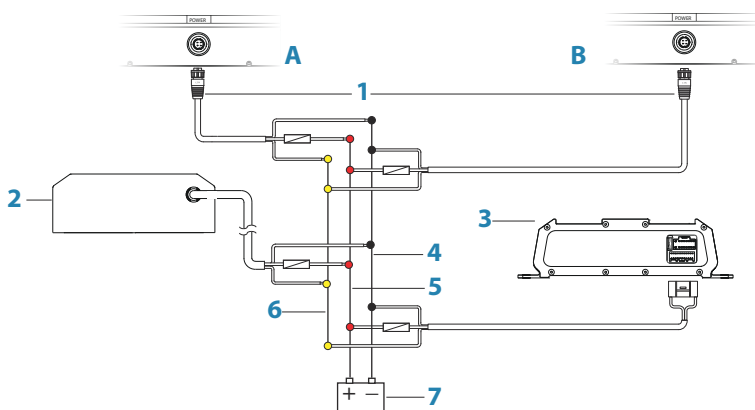

- A Power connection to unit on the left
- B Power connection to unit on the right
- 1 Power cable connectors to units
- 2 Radar interface box
- 3 Audio entertainment device (e.g. SonicHub2)
- 4 Ground wire (black)
- 5 Positive wire (red)
- 6 Power control wire (yellow)
- 7 Battery

## 7 DC power supply

If the unit on the left (A) is turned on using the power button and is set as the Power Control Master, it will output voltage on the Power Control bus to power on the other unit on the right (B), the Radar Interface, and the SonicHub.

If the unit on the right (B) is set to Power Control Slave, it cannot be powered down using its own power button, but can be set to standby.

If the unit on the left (A) is set to Power Control Master and is off, the unit on the right (B) can be turned on using its own power button, but does not turn on any other devices.

To turn on all network devices from either the unit on the left (A) or the unit on the right (B), both devices can be configured as Power Control Masters.

→ **Note:** If a unit has its power state controlled by another device (or ignition switch), it cannot be totally powered down. It can however enter a standby state to save power.

### External alarm

The external alarm can be a small piezo buzzer connected directly, or a horn siren connected through a relay.

Alarms are configured globally in the system. That is, they can be configured on any one networked multifunction device or instrument, and be seen, heard, and acknowledged from all devices. Individual devices can also be configured to not sound their internal buzzer, but still display the alarm information. For information about configuring alarms, refer to the Alarms section in the Operator Manual.

For sirens that draw more than 1 Amp, use a relay.

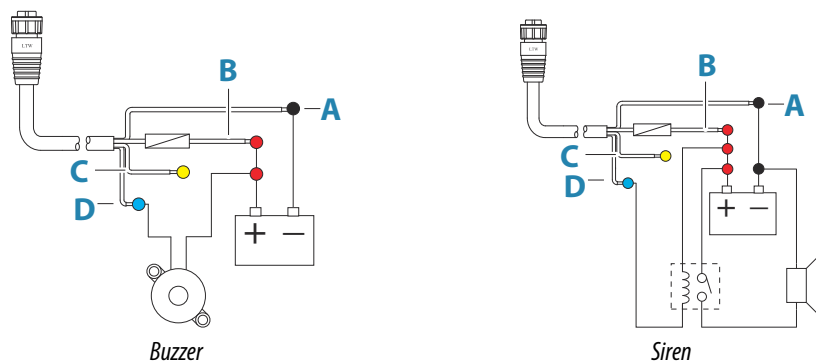

- A** Negative power wire (black)
- B** Positive power wire (red)
- C** Power control wire (yellow)
- D** Alarm wire (blue)

### Connect an external monitor

The 12" and 16" units incorporate HDMI technology and have a HDMI output which can be connected to an external monitor to replicate the display at a remote location. The image is shown on the external monitor at the units own native resolution, so the external monitor should support the same resolution or be able to scale.

If a monitor of different resolution is connected, a dialog is displayed at power up which allows you to **Force HDMI** output to the closest resolution it can output. This may not provide an optimal image on the monitor. The unit will need to restart to apply the change.

→ **Note:** An HDMI cable with a water tight HDMI connector should be used to connect to the unit in exposed installations.

→ **Note:** While the HDMI standard does not state maximum cable length, signal may be compromised on long runs. Only use Navico or other high quality HDMI certified cables.

3rd party cables should be tested before installation. On runs over 10m it may be required to add an HDMI amplifier or use HDMI-CAT6 adaptors.

→ **Note:** Some HDMI TV displays may apply over-scan, which will in effect crop the image possibly causing loss of important content. Check the display manual for an option to disable over-scan or adjust scaling

## NMEA 2000 backbone

### NMEA 2000 device connection

The NMEA 2000 data port allows the receiving and sharing of a multitude of data from various sources.

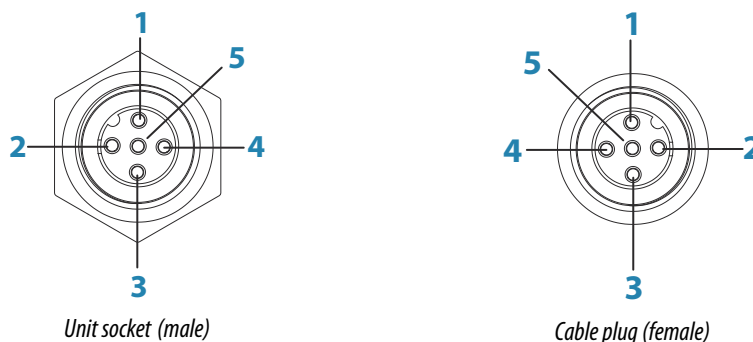

Key	Purpose	Color
1	Shield	Drain
2	NET-S (+12 V DC)	Red
3	NET-C (DC negative)	Black
4	NET-H	White
5	NET-L	Blue

### Essential network information

The standardized physical cables/connectors for NMEA 2000 are Micro-C and Mini-C, directly derived from the automation industries **DeviceNET - Micro-C** being the more commonly used size.

- While most Navico products use Micro-C cabling and connectors, some products still use proprietary SimNet connectors, which are easily made compatible with adaptor cables.
- A network consists of a linear backbone from which drop-cables connect to NMEA 2000 compliant devices.
- A single drop cable has a maximum length of 6 m (20 ft). The total length of all drop cables combined should not exceed 78 m (256 ft).
- A NMEA 2000 network, using Micro-C cabling, has a maximum cable length of 100 m (328 ft), between any two points.
- A NMEA 2000 network needs to have a terminator at each end of the backbone. A terminator can be one of the following:
  - A terminator blank plug.
  - A wind transducer (where the mast cable is one end of the backbone).

### Planning and installing a network backbone

The backbone needs to run between the locations of all products to be installed - typically in a bow to stern layout - and be no further than 6 m from a device to be connected.

Choose from the following components to make up the backbone:

- Micro-C cables: 0.6 m (2 ft), 1.8 m (6 ft), 4.5 m (15 ft), and 7.6 m (25 ft) cables.
- T-connector or 4-way connector. Used to connect a drop cable to the backbone.
- Micro-C power cable. Connect to the backbone at a position that is central to the network load using a T-connector or 4-way connector.

### Power the network

The network requires its own 12 V DC power supply protected by a 5 amp fuse or breaker. For vessels fitted with 24 V systems, use a DC-DC converter to supply 12 V.

Connect power at any location in the backbone for smaller systems.

For larger systems introduce power at a central point in the backbone to *balance* the voltage drop of the network.

- **Note:** If joining to an existing NMEA 2000 network that already has its own power supply, do not make another power connection elsewhere in the network, and ensure the existing network is not powered by 24 V DC.
- **Note:** Do not connect the NMEA 2000 power cable to the same terminals as the engine start batteries, autopilot computer, bow thruster or other high current devices.

The following drawing demonstrates a typical small network. The backbone is made up of directly interconnected T-connectors.

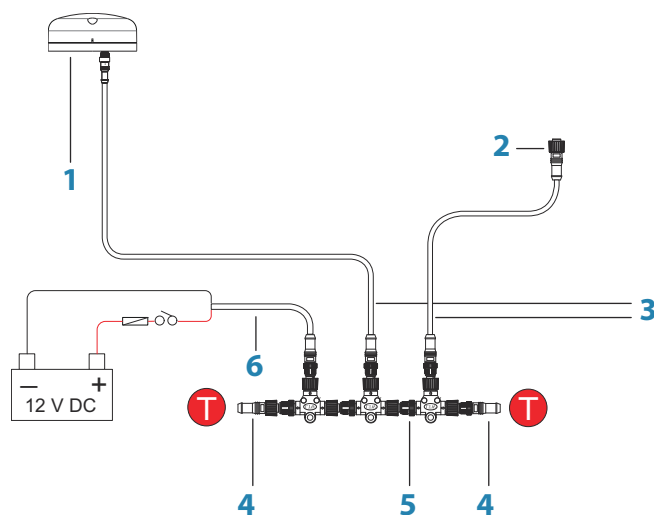

- 1 NMEA 2000 device
- 2 Connector to unit
- 3 Drop-cable, should not exceed 6 m (20 ft)
- 4 Terminators
- 5 Backbone
- 6 Power cable

### NMEA 0183 device connection

The unit has a NMEA 0183 serial port, providing both an input and an output. The port uses the NMEA 0183 (serial balanced) standard, and can be configured in the software for different baud rates up to 38,400 baud.

- **Note:** The connector for NMEA 0183 is labelled VIDEO on rear of unit, as the cable is dual purpose and carries both composite video and NMEA 0183 (on separate wires)

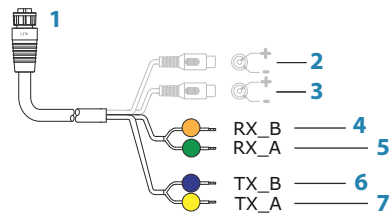

- 1 Connector to unit
- 2 Camera input 1 - red cable
- 3 Camera input 2 - green cable
- 4 NMEA 0183 RX\_B (orange)
- 5 NMEA 0183 RX\_A (green)
- 6 NMEA 0183 TX\_B (blue)
- 7 NMEA 0183 TX\_A (yellow)

### Talkers and Listeners

Do not connect multiple devices outputting data (Talkers) on to any serial input (RX) of the unit. The RS422 protocol is not intended for this type of connection, and data will be corrupted if more than one device transmits simultaneously. The output (TX) however may drive multiple receivers (Listeners). The number of receivers is finite, and depends on the receiving hardware. Typically three devices is possible.

### CZone connection to NMEA 2000

When interfacing to CZone network it is recommended to use a BEP Network interface bridge to join the two network backbones together.

The CZone / NMEA 2000 Network interface bridge isolates the power of the two networks, but allows data to be freely shared between both sides.

The Interface Bridge can also be used for expansion of the NMEA 2000 network, when the maximum node limit (node = any device connected to network) for the network has been reached or the maximum cable length of 150 m will be exceeded. Once an Interface Bridge has been fitted, a further 40 nodes and additional cable length can be added.

The Network Interface is available from your BEP dealer. For more information please refer to the BEP web site [www.bepmarine.com](http://www.bepmarine.com).

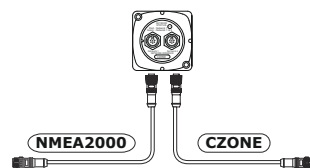

### Transducer connection

The unit has internal CHIRP, Broadband, StructureScan, TotalScan and ForwardScan sonar.

There are two 9-pin transducer connectors on the rear of the unit. Traditional 50/200 Khz, CHIRP and HDI transducers can be connected to Sonar1 (Blue nut) or Sonar2 (black nut). TotalScan, StructureScan and ForwardScan must be connected to Sonar2. For connector location, refer to the embossed labeling on the back of the unit or the section "*Rear connections*" on page 10.

→ **Note:** The connector attached to the transducer cable is keyed, and can only be inserted in one orientation. Once inserted, turn locking collar to secure.

- **Note:** A 7-pin transducer cable can be connected to a 9-pin port using a 7-pin to 9-pin adaptor cable. However, if the transducer has a paddle wheel speed sensor, the water-speed data will not be displayed on the unit.
- **Note:** For transducer installation information, refer to separate installation instructions included with the transducer.

## Ethernet connector

The unit is equipped with an Ethernet port, which allows connecting the unit to your network using the 5 pin Ethernet connector.

- **Note:** The 7" and 9" units have one Ethernet port, where as the 12" and 16" have two.

Connection of network devices, such as radar, sonar, and other multifunction displays, can be made directly to the Ethernet port, or via a network expansion device to the Ethernet port.

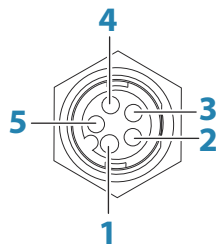

Unit socket (female)

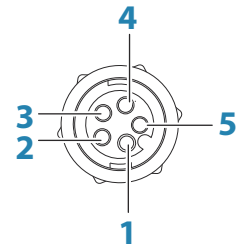

Cable plug (male)

Key	Purpose	Color
1	Transmit positive TX+	Blue/White
2	Transmit negative TX-	Blue
3	Receive positive RX+	Orange/White
4	Receive negative RX-	Orange
5	Shield	Bare

## Ethernet expansion device

Connection of network devices can be made via an Ethernet expansion device. Additional expansion devices can be added to provide the required number of ports.

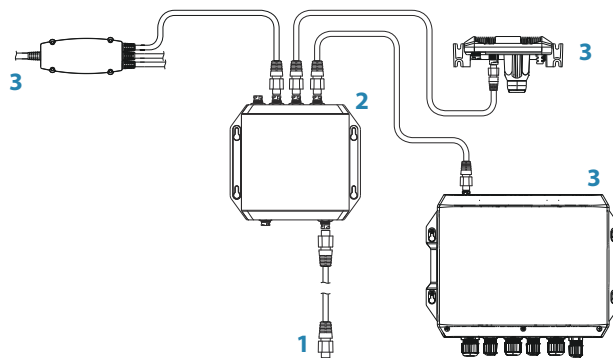

- 1 Ethernet connector to unit
- 2 Ethernet expansion device
- 3 Network devices

## Video in

The unit can be connected to two composite video sources, and display video images on its display.

The video input cable is fitted with female RCA plugs - the camera cables should be terminated with male RCA cables to suit.

→ **Note:** The video images will not be shared with another unit via the network. It is only possible to view video on the unit connected to the video source.

→ **Note:** Both NTSC and PAL formats are supported.

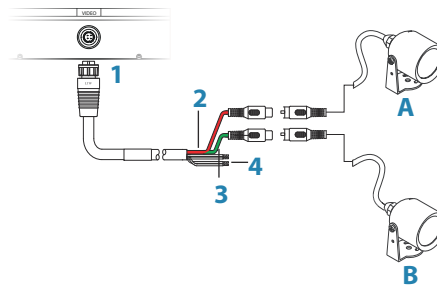

- 1 Cable connector to Video port on unit
- 2 Camera A input (red cable)
- 3 Camera B input (green cable)
- 4 NMEA 0183 cables

# 5

## Software Setup

This unit requires some initial configuration before use, in order to get the most out of the product. The following sections focus on settings that typically do not require change once configured. User preference settings and operation are covered in the Operator Manual.

Pressing the Home key or selecting the Home button opens the Home page. Select the Settings icon in the top left corner of the Home page to open the Settings dialog and access items that require configuration. You can also press the Power key once to display the Systems Controls dialog and select the Settings icon from there.

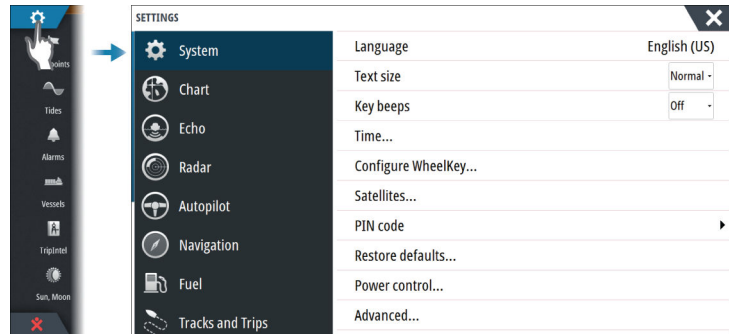

### First time startup

When the unit is started for the first time, or after a factory default, the unit displays a setup wizard. Respond to the setup wizard prompts to select some fundamental setup options. You can perform further setup using the system settings option and later change settings made with the setup wizard.

### Configuring the WheelKey

You can define what happens with a short or long press of the WheelKey on the front of the unit.

To configure the Wheel key, select **Configure WheelKey** on the System Setting dialog.

Select the **Short press** option or **Long press** option in the WHEELKEY CONFIGURATION dialog and then an option from the list displayed.

### Time and Date

Configure time settings to suit vessel location, along with time and date formats.

### Power Control

Determines unit response to signal applied to the yellow wire of the power cable.

Set to 'Slave' if the yellow wire is connected to ignition or to a stand-alone switch that applies 12 V/24 V. Set to Master to make this device turn on other devices when powered up.

→ **Note:** The System Controls panel does not display the Power Off option and you cannot use the power key to power off the unit when the unit is configured as slave. To power down the unit, the master device must be powered down, or system power removed.

### Data source selection

→ **Note:** If NMEA 0183 is used, complete the NMEA 0183 setup prior to doing source selection. Refer to "*NMEA 0183 setup*" on page 39.

Data sources provide live data to the system.

The data may originate from modules internal to the unit (for example internal GPS or sonar), or external modules connected to the NMEA 2000 or via NMEA 0183 if available on the unit.

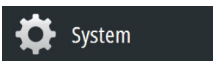
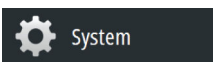



When a device is connected to more than one source providing the same data, the user can choose the preferred source. Before commencing with source selection make sure all external devices and the NMEA 2000 backbone are connected and are turned on.

### Auto Select

The Auto Select option looks for all sources connected to the device. If more than one source is available for each data type, selection is made from an internal priority list. This option is suitable for the majority of installations.

### Manual source selection

Manual selection is generally only required where there is more than one source for the same data, and the automatically selected source is not the one desired.

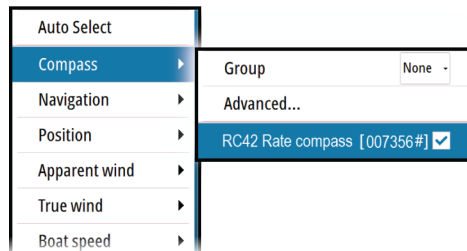

### Group source selection

Multifunction displays, autopilot controllers, and instruments have the ability to:

- Use data sources (for example position, wind direction, and so on) that all other products on the network use, or alternatively use a data source independently from other units.
- Globally change all displays over to a different source from any display. (This only includes products set to Group mode.)

→ **Note:** In order to enable group selection, the display must be set to Simrad group.

Devices with the Group set to None can be set to use different sources to those of the rest of the network devices.

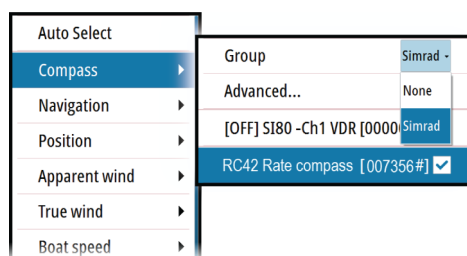

### Advanced source selection

This allows the most flexible and precise manual control over which devices provide data. Some data sources, such as those for fuel level, or engine RPM, can only be changed from the Advanced menu. Occasionally Auto Select may not assign the desired source, which may be corrected using the Advanced Source Selection. An example of this is where twin installations with NMEA 2000 compliant engines are not programmed with unique instance numbers. This means that the auto select feature cannot determine which engine is fitted on the port and which is fitted on the starboard side.

→ **Note:** The **Advanced** option is visible in multiple places - the bottom of the **Sources** list, and under each source category (for example, Compass). The latter shows a filtered list that only relates to devices that output data relevant to the category.

## Device list

The Device list shows the devices that provide data. This may include a module inside the unit, or any external NMEA 2000 device.

Selecting a device in this list will bring up additional details and actions:

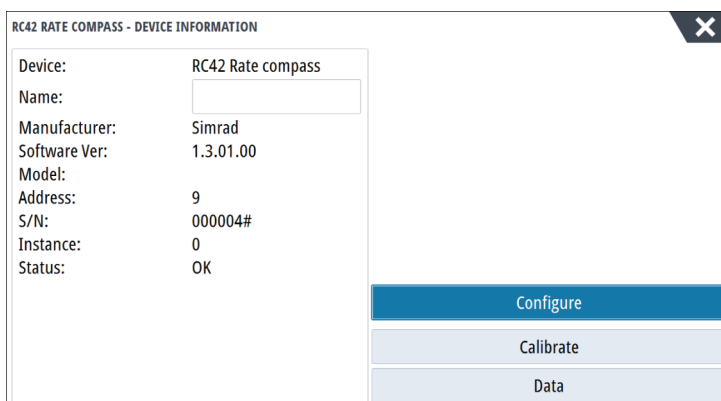

All devices allow allocation of an instance number in the **Configure** option. Set unique instance numbers on any identical devices on the network to allow for the unit to distinguish between them. The **Data** option shows all data being output by the device.

Some devices will show additional option(s) specific to the device - the RC42 illustrated above has a **Calibration** option, to allow easy setup of this device.

→ **Note:** Setting the instance number on a 3rd party product is typically not possible.

## SimNet Groups

The SimNet Group function is used to control parameter settings, either globally or in groups of units. The function is used on larger vessels where several SimNet units are connected to the network. By assigning several units to the same group, a parameter update on one unit will have the same effect on the rest of the group members.

**Display** (backlighting), **Units** (metric or imperial units of measure), **Damping** (to dynamic data), and **Alarms** can be grouped either in **Simrad** group, or groups **1** through to **6**. If any of the settings require discrete control, set it to **none**.

## Diagnostics

The NMEA 2000 tab on the diagnostics page can provide information useful for identifying an issue with the network.

→ **Note:** The following information may not always indicate an issue that can be simply resolved with minor adjustment to network layout or connected devices and their activity on the network. However, Rx and Tx errors are most likely indicating issues with the physical network, which may be resolved by correcting termination, reducing backbone or drop lengths, or reducing the number of network nodes (devices).

### Bus state

Simply indicates whether the bus is powered, but not necessarily connected to any data sources. However, if bus shows as **off**, but power is present along with an increasing error count, it is possible that termination or cable topology is incorrect.

### Rx Overflows

The unit received too many messages for its buffer before the application could read them.

### Rx Overruns

The unit contained too many messages for its buffer before the driver could read them.

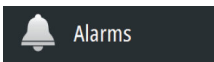
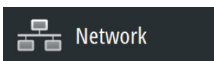

### Rx/Tx Errors

These two numbers increase when there are error messages, and decrease when messages are received successfully. These (unlike the other values) are not a cumulative count. Under normal operation these should be at 0. Values around 96 upwards indicate a heavily error prone network. If these numbers go too high for a given device, it will automatically drop off the bus.

### Fast Packet Errors

Cumulative counter of any fast packet error. This could be a missed frame, or a frame out of sequence etc. NMEA 2000 PGNs are made of up to 32 frames. The entire message will be discarded when a frame is missed.

→ **Note:** Rx and Tx Errors often indicate an issue with the physical network, which may be resolved by correcting termination, reducing backbone or drop lengths, or reducing the number of network nodes (devices).

### Damping

If data appears erratic or too sensitive, damping may be applied to make the information appear more stable. With damping set to off, the data is presented in raw form with no damping applied.

### Calibration

An offset (positive or negative) can be applied to correct inaccuracies in boat speed, sea temp, air temp, barometric pressure, and depth sourced from NMEA 2000.

→ **Note:** Any calibrations made here will ONLY be applied locally to this unit. Other devices on the network will not have these offsets applied.

### External Alarm Setup

The **Siren Enabled** option must be set in order for the unit to drive the buzzer when an alarm condition arises. Its setting also determines the operation of the external alarm output.

### Echosounder setup

Make general settings from the Echosounder Settings dialog. Define Echosounder sources in the Installation dialog.

You can select which source is displayed in the Echosounder panel. You can also display two different sources simultaneously, using a split panel configuration. All menu controls for each panel are independent.

The source can be the internal Echosounder, another MFD on the Ethernet network, or a Echosounder module.

### Internal Echosounder

Select to make the internal Echosounder available for selection in the Echosounder menu. For more information about panel source selection, refer to the Operator manual.

When set to off, this option disables the internal Echosounder in the unit. It will not be listed as a Echosounder source for any unit on the network. Select this option on a unit which does not have a transducer connected.

### Network Echosounder

Enabling Network Echosounder allows the display to use other compatible Echosounder sources on the Ethernet network as well as sharing it's own Echosounder with other devices.

### Structure depth offset

Setting for Structure transducers.

All transducers measure water depth from the transducer to the bottom. As a result, water depth readings do not account for the distance from the transducer to the lowest point of the boat in the water or from the transducer to the water surface.

To show the depth from the lowest point of the boat to the bottom, do the following. Before setting the Structure offset, measure the distance from the structure transducer to the lowest point of the boat in the water. If, for example, the distance is 0.3 m (1 ft), it will be input as (minus) -0.3 m (-1 ft).

To show the depth from the water surface to the bottom, do the following. Before setting the Structure offset, measure the distance from the structure transducer to the water surface. If, for example, the distance is 0.3 m (1 ft), it will be input as (plus) 0.3 m (1 ft).

A setting of 0 (zero) causes the depth displayed to be the distance from the transducer to the bottom.

### Overlay downscan

When a DownScan source is connected to your system, you can overlay DownScan images on the regular Echosounder image.

When activated, the Echosounder menu expands to include basic DownScan options.

### Echosounder installation

Use this dialog to setup and configure available Echosounder sources.

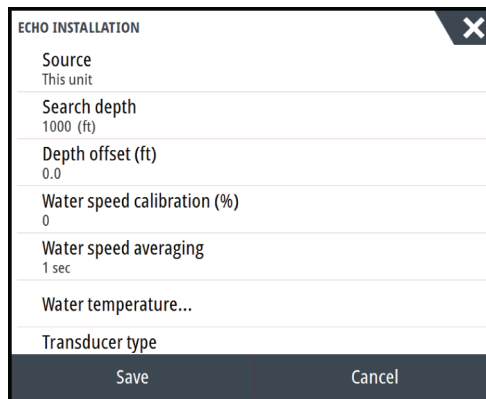

#### Source

Select this option to display a list of Echosounder sources available for setup. The settings you make in the rest of the dialog pertain to the source selected. The sources setup in this dialog are available for selecting to display in the image in the Echosounder panel.

#### Search depth

Noise may cause the echosounder to search for unrealistic depths. By setting the search depth manually the system displays echoes received from objects within the set depth range.

#### Depth offset

All transducers measure water depth from the transducer to the bottom. As a result, water depth readings do not account for the distance from the transducer to the lowest point of the boat (for example; bottom of the keel, rudder, or skeg) in the water or from the transducer to the water surface.

Before setting the offset, measure the distance from the transducer to the lowest point of the boat in the water or from the transducer to the water surface.

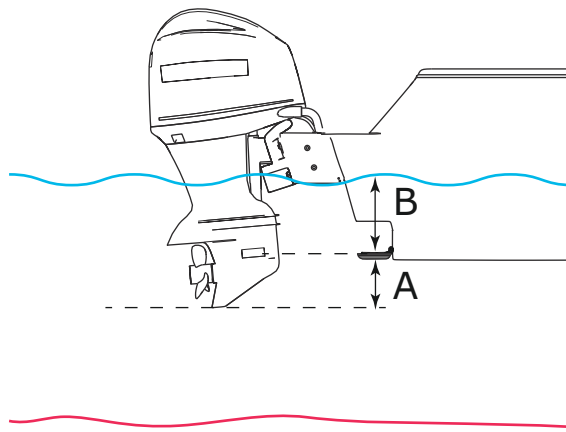

- A** Lowest point of vessel offset: Set the distance from the transducer to the lowest point of the boat in the water - this should be set as a negative value. For example, -0.3 m (-1 ft).
- B** Depth below surface (waterline) offset: Set the distance from the transducer to the surface - this should be set as a positive value. For example, +0.5 m (+1.77 ft).

For depth below transducer, set the offset to 0.

#### Echosounder software version

For external sounder modules, the software version is displayed in the header of the Echo Installation dialogue. For upgrade software information, refer to "*Software updates and data backup*" on page 43.

#### Water speed calibration

Water speed calibration is used to adjust the speed value from the paddle wheel to match the actual boat speed through the water. Actual speed can be determined from GPS speed over ground (SOG) or by timing the boat over a known distance. Water speed calibration should be performed in calm conditions, with minimal wind and current movement.

Increase this value above 100 % if the paddle wheel is under reading, and decrease this value if it is over reading. For example, if the average water speed reads 8.5 knots (9.8 MPH) and SOG records 10 knots (11.5 MPH) the calibration value needs to be increased to 117 %. To calculate the adjustment, divide the SOG by the paddlewheel speed, and multiply the product by 100.

Calibration range: 50-200 %. Default is 100 %.

#### Water speed averaging

Averages water speed by measuring your speed at a selected interval of time. Water speed intervals range from one to thirty seconds. For example if you select five seconds, your displayed water speed will be based on averaging over 5 seconds of sampling.

Calibration range: 1-30 seconds. Default is 1 second.

#### Water temperature calibration

Temperature calibration is used to adjust the water temperature value from the sonar transducer to match the data from another temperature sensor. It may be required to correct for localized influences to the measured temperature.

Calibration range: -9.9° - +9.9°. Default is 0°.

→ **Note:** Water temperature calibration only appears if the transducer is temperature capable. Check transducer type selection if this option should be available.

#### Transducer type

Transducer type is used for selecting the transducer model connected to the sonar module. The transducer selected will determine what frequencies the user can select during sonar operation. In some transducers with built-in temperature sensors, the temperature reading

may be inaccurate or not available at all if the wrong transducer is selected. Transducer temperature sensors are one of two impedances - 5k or 10k. Where both options are given for the same model transducer, refer to paperwork supplied with transducer to determine impedance.

### ForwardScan installation

Available when the ForwardScan feature is turned on. For installation and setup information, refer to the separate ForwardScan documentation.

## StructureScan

This feature is automatically enabled when a TotalScan transducer is plugged in before the unit has been powered on.

You should set the **Structure depth offset** for the structure transducer. This settings is in the Echosounder Settings dialog.

## Radar setup

Use the Radar Installation dialog to setup the radar.

→ **Note:** The installation can vary depending on the radar. Follow the installation and setup instructions supplied with the radar.

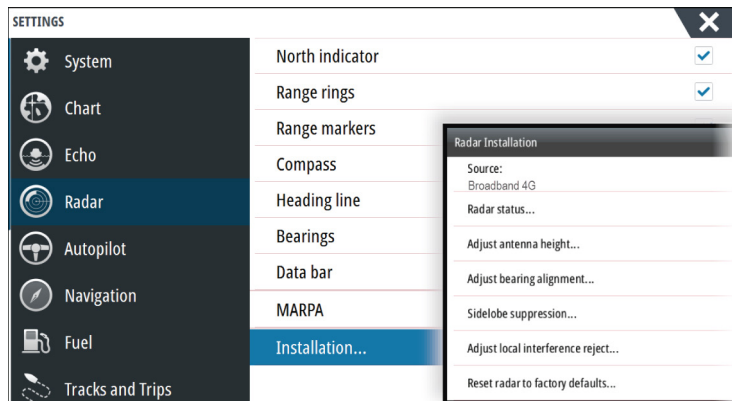
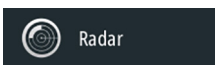
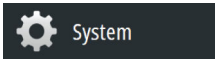

### Radar source

In a system with more than one radar, the correct device to configure can be selected from this menu.

→ **Note:** Radars that support dual radar mode are represented twice in the source list, with an A and B suffix.

### Radar status

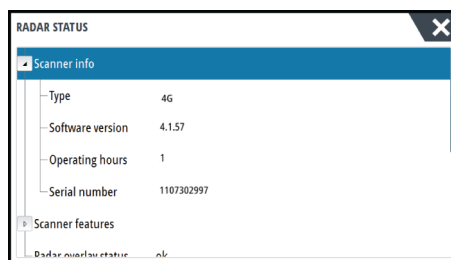

#### Scanner type

Identifies the model of scanner connected to the network.

### Software version

Check to make sure you have the latest software. Check the latest software version available at: [www.simrad-yachting.com](http://www.simrad-yachting.com).

### Serial Number

This number should be recorded for support and insurance purposes.

### MARPA status

The MARPA status can identify if a heading sensor is on the network and that the radar is receiving heading information essential for MARPA calculations.

### Reset device ID

Should a radar be connected to the network that has been connected to a dual radar network in the past, it might not be detected by the system because it might have an invalid Device ID. With the radar connected and powered up, select the Reset Device ID button to resolve this problem.

→ **Note:** This procedure must be performed with only one radar on the network, and only applies where a network combines an older MFD with other MFDs.

## Adjust range offset

(Pulse Radar only)

The radar sweep should commence at your vessel (a radar range of zero). You may need to adjust the radar range offset to achieve this. If this is set incorrectly, a large dark circle in the center of the sweep might occur. You might notice straight objects such as straight sea walls or piers having curves or an indentation. Objects close to your vessel may appear "pulled in" or "pushed out".

Adjust the range offset as below when the vessel is about 45 to 90 m (50 to 100 yards) from a straight-walled jetty or similar feature that produces a straight line echo on the display.

- Point the boat towards the jetty
- Adjust the gain setting until a reasonably good image of the jetty echo is displayed

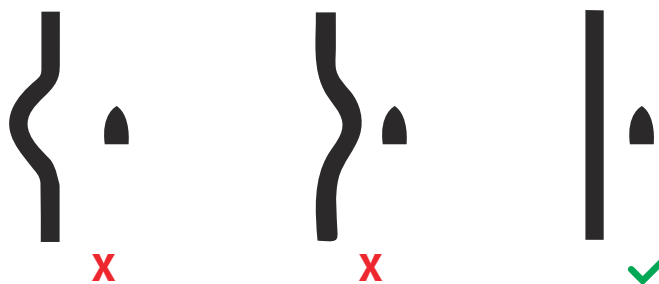

## Adjust antenna height

Set the radar scanner height relative to the water surface. The Radar uses this value to calculate the correct STC settings.

## Adjust bearing alignment

This is to align the heading marker on the screen with the center line of the vessel. This will compensate for any slight misalignment of the scanner during installation. Any inaccuracy will be evident when using MARPA or chart overlay.

Point the boat to be perpendicular to the very end of a breakwater or peninsula. Adjust the bearing alignment setting, so that the heading marker and land mass intersect.

## Sidelobe suppression

Occasionally false target returns can occur adjacent to strong target returns such as large ships or container ports. This occurs because not all of the transmitted radar energy can be

focused into a single beam by the radar antenna, a small amount of energy is transmitted in other directions. This energy is referred to as sidelobe energy and occurs in all radar systems. The returns caused by sidelobes tend to appear as arcs.

→ **Note:** This control should only be adjusted by experienced radar users. Target loss in harbor environments may occur if this control is not adjusted correctly.

When the radar is mounted where there are metallic objects near the radar, sidelobe energy increases because the beam focus is degraded. The increased sidelobe returns can be eliminated using the Sidelobe Suppression control.

By default, this control is set to Auto and normally should not need to be adjusted. However, if there is significant metallic clutter around the radar, sidelobe suppression may need to be increased. The control should be adjusted as follows:

1. Set Radar range to between 1/2 nm to 1 nm and Sidelobe Suppression to Auto
2. Take the vessel to a location where sidelobe returns are likely to be seen. Typically, this would be near a large ship, container port, or metal bridge.
3. Traverse the area until the strongest sidelobe returns are seen.
4. Change Auto sidelobe suppression to OFF then select and adjust the sidelobe suppression control until the sidelobe returns are just eliminated. You may need to monitor 5-10 radar sweeps to be sure they have been eliminated.
5. Traverse the area again and readjust if sidelobe returns still occur.
6. Exit the dialog.

### Radar sector blanking (Halo radar only)

Radar installed in close proximity to a mast or structure could cause unwanted reflections or interference to appear on the radar image. Use the sector blanking feature to stop the radar from transmitting on up to four sectors in the image. The blanking occurs on the main radar PPI and on the radar overlay on a chart.

→ **Note:** Sectors are setup relative to the heading line of the radar. The bearing of the sector is measured from the center line of the sector.

→ **Note:** Sector blanking should be applied very carefully to avoid reducing the radar's usefulness in identifying valid and potentially dangerous targets.

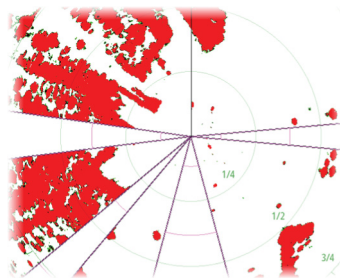

Main radar PPI



Radar overlay on a chart

### Adjust open array park angle (Halo Radar only)

The park angle is the final resting position of the antenna relative to the heading line of the radar when the radar is set to standby. The antenna will stop rotating at the desired offset.

### Halo light

Controls the levels of the Halo Radar pedestal blue accent lighting. There are four levels possible for the lighting. The accent lighting can only be adjusted when the radar is in standby mode.

→ **Note:** The blue accent pedestal lighting might not be approved for use in your boating location. Check your local boating regulations before turning the blue accent lights ON.

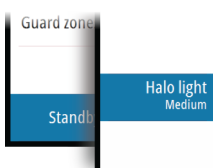



## Adjust local interference reject

Interference from some onboard sources can interfere with the Broadband radar. One symptom of this could be a large target on the screen that remains in the same relative bearing even if the vessel changes direction.

Choose from Local interference rejection LOW, MED or HIGH. Default is LOW.

## Restore radar to factory defaults

This option can be used to revert all user adjustments.

## Video In configuration

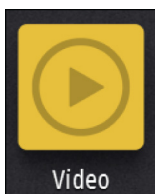

Open the menu on the video panel to set up video. Enable PAL or NTSC depending on the video output standard of the selected camera. You can optimize the video display by adjusting the video image settings (brightness, saturation, etc.). The settings are applied individually for each video source. Mirror image may be applied where the camera is providing a rear view, and the user wishes to see objects as they would appear in a vehicle rear view mirror, i.e., on the same side as they actually are.

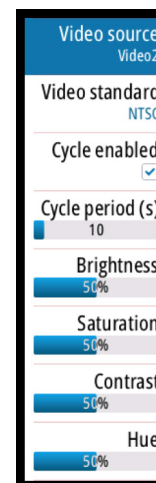

## Autopilot setup

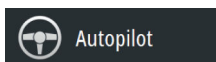

For setup and commissioning of autopilot computers, refer to the documentation included with the autopilot computer.

→ **Note:** The WheelKey can be used as a STBY key when configured for autopilot control. To configure the WheelKey, refer to "Configuring the WheelKey" on page 24.

## Fuel setup

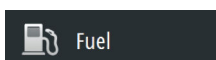

The fuel utility monitors a vessel's fuel consumption. This information is totaled to indicate trip and seasonal fuel usage, and is used to calculate fuel economy for display on instrument pages and the data bar.

To use the utility, a Navico Fuel Flow sensor, or a NMEA 2000 engine adaptor cable/gateway with Navico Fuel Data Storage device must be fitted to the vessel. Neither the Navico Fuel Flow sensor, nor the Suzuki engine interface require the use of a separate Fuel Storage device. Refer to the engine manufacturer or dealer for information on whether or not your engine provides a data output, and what adaptor is available to connect to NMEA 2000.

Once the physical connection is made, ensure source selection is completed. Multiple engine installations using Fuel Flow sensors, or Fuel Data Storage devices, require setup of related engine location in the Device list. For general source selection information, refer to "Data source selection" on page 24.

## Vessel setup

The Vessel setup dialog must be used to select the number of engines, the number of tanks and vessel's total fuel capacity across all tanks.

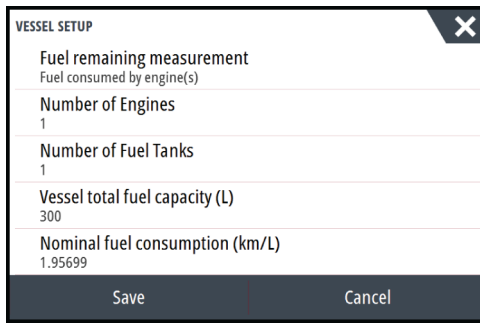

### Fuel remaining measurement

The Fuel remaining measurement can be determined from fuel used by engine(s), or fuel level from tank sensors. Nominal fuel consumption is required to set the scale on the fuel economy gauge. This value should be determined from experience, over time. Alternatively the boat builder or designer may be able to give an approximate value to use.

- **Note:** Fuel remaining measurement taken from level sensors while underway can get inaccurate readings due to vessel movement.
- **Note:** Nominal fuel consumption setting should be determined taking into account typical vessel loads. That is, filled fuel and water tanks, stowed tender, supplies, etc.

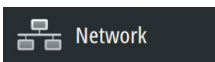

### Fuel flow configuration

After the number of engines is set, it is required to set which fuel flow sensor is connected to which engine. Under **Device list** on the Network page, view the Device Configuration dialog for each sensor, and set the **Location** to match the engine the device is connected to.

**Unconfigure** - defaults the device which clears all user settings.

**Reset Fuel Flow** - restores only the Fuel K-Value setting, if set in Calibrate. Only Navico devices can be reset.

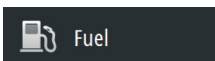
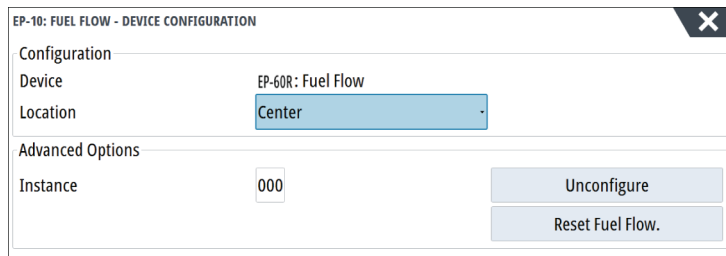

### Calibrate

Calibration may be required to accurately match measured flow with actual fuel flow. Access calibration from the **Refuel** dialog. Calibration is only possible on Navico's Fuel Flow sensor.

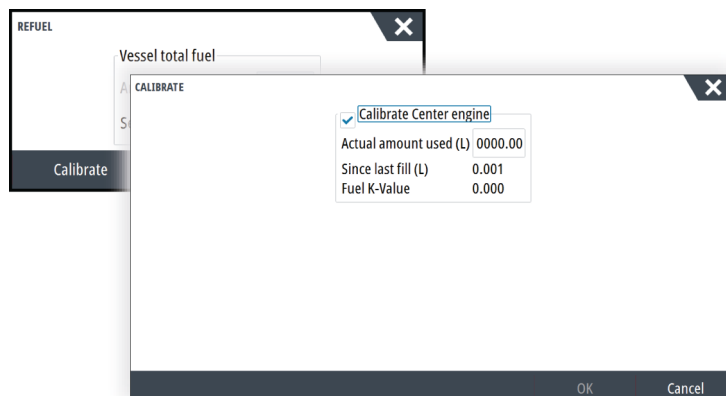

1. Start with a full tank and run the engine as it would normally be operated.
  2. After at least several liters (a few gallons) have been used, the tank should be fully refilled, and the **Set to full** option selected.
  3. Select the **Calibrate** option.
  4. Set the **actual amount used** based on amount of fuel added to the tank.
  5. Select **OK** to save settings. The **Fuel K-Value** should now show a new value.
- **Note:** To calibrate multiple engines repeat the steps above, one engine at a time. Alternatively, run all engines simultaneously, and divide the *Actual amount used* by the number of engines. This assumes reasonably even fuel consumption on all engines.
- **Note:** The **Calibrate** option is only available when **Set to full** is selected, and a Fuel Flow is connected and set up as a source.
- **Note:** A maximum of 8 engines is supported using Fuel Flow sensors.

## Fuel Level

With the use of a Navico Fluid Level device connected to a suitable tank level sensor, it is possible to measure the amount of fuel remaining in any equipped tank. The number of tanks must be set in Vessel Setup dialog, initiated from the Fuel setting options page, to allow discrete tank assignment of the Fluid Level devices.

Select **Device list** on the Network page, and view the Device Configuration dialog for each sensor, and set the Tank location, Fluid type, and Tank size.



**EP-15: FLUID LEVEL - DEVICE CONFIGURATION** ✕

Configuration

Device	EP-65R Fluid Level
Tank	Center
Fluid type	Fuel
Tank size (L)	0704.90

Advanced Options

Instance	000	<input type="button" value="Unconfigure"/>
----------	-----	--

For setting up the Instrument bar or a gauge on the Instrument page with Fluid Level device data, refer to the Operator Manual.

- **Note:** A maximum of 5 tanks is supported using Fluid Level devices.
- **Note:** Tank data that is output by a compatible engine gateway can also be displayed, however tank configuration for such a data source is not possible from this unit.

## CZone setup

In order to communicate with the CZone modules connected to the network, the NSS evo3 must be assigned a unique CZone Display Dipswitch setting.

The functionality of the CZone system is determined by the CZone Config File (.zcf), which is stored on all CZone modules and the NSS evo3. The file is created using the CZone Configuration Tool, a specialized PC application available from BEP Marine Ltd, and associated CZone distributors.

The NSS evo3 system provides a means to load the Config file, as well as apply updates to module firmware, removing the need to take a laptop computer aboard the vessel.

### Enabling CZone functionality

If the CZone device(s) are not automatically detected, it is possible to manually enable CZone.

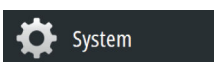

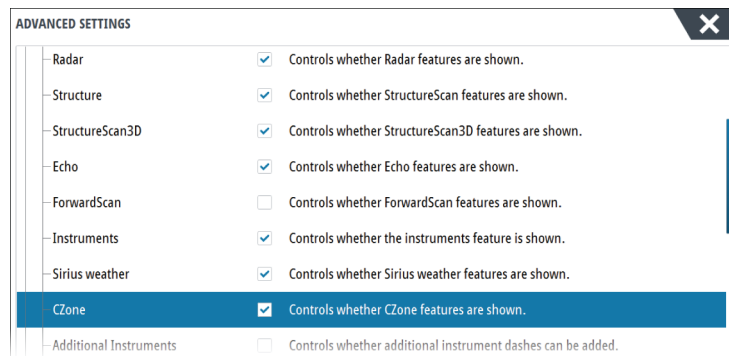

## Assigning the dipswitch setting

Every product capable of controlling and viewing CZone devices must be assigned a virtual dipswitch setting. This setting is unique for each device. Typically it is set after the configuration file already exists on the CZone system, but it may also be set in advance. To do so, access the CZone menu on the Settings page.

When the configuration is already available on the network, it will immediately commence uploading to the NSS evo3 once the dipswitch is set. Allow this to complete, without interruption.

## Setting CZone to display at startup

With this option selected, the CZone control page is shown first, every time the NSS evo3 is powered up.

## CZone backlight control

Enabling this causes the NSS evo3 to synchronize its backlight setting with that of any CZone Display Interfaces set up to share backlight settings.

→ **Note:** CZone Config also needs to have the NSS evo3 set as a controller.

## Import and backup a configuration file

The files page may be used to import CZone configuration files, or export a copy to a memory card in the card reader. Importing overwrites the existing file on the NSS evo3 and all connected CZone devices.

For further information, see *"Backing up and Importing user data"* on page 44.

## Wireless setup



The unit includes built-in wireless functionality that lets you:

- Use a wireless device to remotely view (smartphone and tablet) and control the system (tablet only). Wireless devices use the GoFree app downloaded from their relevant application store.
- Access the GoFree Shop.
- Upload your logs to create custom maps at Insight Genesis.
- Download software updates
- Connect to third party applications

## Connecting a tablet

Install the GoFree App on the tablet before following this procedure.

1. Set the internal wireless to **Access Point** mode. To do this, select the **Wireless devices** page in the Wireless settings dialog and then select the Internal wireless. Next, select the **Mode** option and then select **Internal Access Point**.
2. Select a device on the **Wireless devices** page to view its network key.
3. Navigate to the wireless network connection page on the tablet, and find the unit or GoFree wireless **xxxx** network. If more than one is in range, review the **Wireless devices** page on the unit to confirm which wireless device is connected to the unit.
4. Enter the Network Key in the tablet to connect to the network.

5. Open the GoFree application - the unit should be automatically detected. The name displayed will be either the default, or that assigned in the Device Name setting. If the unit does not appear, follow the on screen instructions to manually find the device.
6. Select the graphic icon of the unit. The unit displays a prompt similar to the following:

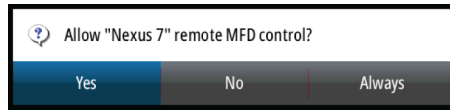

7. Select **Yes** for one-time connection, or **Always** if device is to be remembered for regular connection. This setting can be changed later if required.

→ **Note:** The internal wireless module only supports GoFree connection to itself. Other units connected on the network are not visible.

## Connecting a smartphone

Install the GoFree App on the smartphone before following this procedure.

1. Set the internal wireless to **Access Point** mode. To do this, select the **Wireless devices** page in the Wireless settings dialog and then select the unit's Internal Wireless. Next, select the **Mode** option and then select **Internal Access Point**.
2. Select a device on the **Wireless devices** page to view its Network Key.
3. Navigate to the wireless network connection page on the smartphone, and find the unit or GoFree wireless **xxxx** network. If more than one is in range, review the **Wireless devices** page from the unit's Wireless settings dialog to confirm which wireless device is connected to the unit.
4. Enter the Network Key in the smartphone to connect to the network.
5. Open the GoFree application on the smartphone, the unit should be automatically detected. The name displayed will be either the default, or that assigned in the Device Name setting. If the unit does not appear, follow the on screen instructions to manually find the device.

The MFD's display is shown on the smartphone. To change the MFD's display on the smartphone, use the MFD to change the display on the MFD. The display change on the MFD is reflected on the smartphone.

## Wireless settings

Provides configuration and setup options for the wireless functionality.

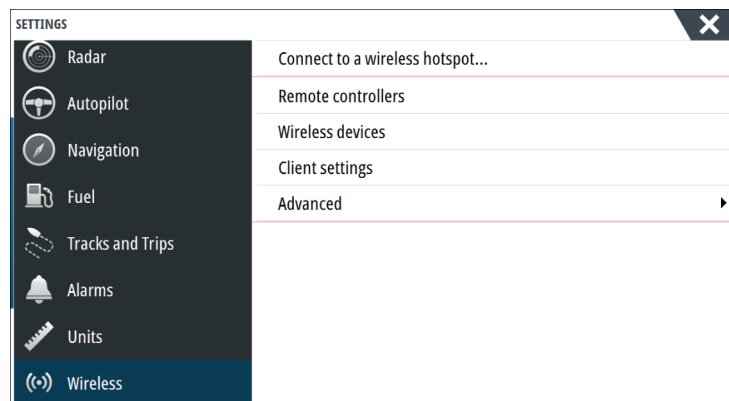

## Remote controllers

When a wireless device is connected, it should appear in the **Remote controllers** list.

Selecting **Always allow** means the device can automatically connect without needing a password each time. This menu also allows disconnection of devices that no longer require access.

## Wireless devices

This dialog shows the internal wireless and any connected WIFI-1 devices, as well as their IP and channel number. Selecting the internal wireless or a WIFI-1 device provides additional detail.

To view and change internal wireless detail values (Network Name (SSID), Network Key, or Channel) the internal wireless must be in **Access Point** (Internal Wifi) mode. To select a network (hotspot) to connect to, the internal wireless must be in **Client Mode**. Use the Mode option to change modes.

### Mode

Displays if the internal wireless is set to **Access Point** (Internal Wifi) mode or **Client Mode**. Select it to change the wireless between **Access Point** mode and **Client Mode**.

If the internal wireless is set to **Access Point** (Internal Wifi) mode, smartphones and tablets can access the unit to view and control (tablet only) it. Also when set to **Access Point** (Internal Wifi) mode you can view and change the internal wireless details. **Client Mode** allows the unit internet access via a wireless hotspot.

When viewing this menu for a WIFI-1 set to **Access Point** mode, it's also possible to switch between **Primary** and **Secondary** access point modes so two WIFI-1 devices can exist on the network at the same time.

Only one WIFI-1 may operate as **Primary**, which determines that the device is acting as DHCP server. Only one DHCP server may exist on a network at a time.

To use two WIFI-1s as access points simultaneously the unit must initially be connected to only one unit. Once this unit is set to secondary, a second module may be turned on/connected, and will automatically default to primary.

→ **Note:** In a network with only one WIFI-1 and one or more internal wireless modules, the WIFI-1 should be left in **Primary** mode. The internal modules do not act as a DHCP server.

### Hardware

Provides firmware version info, and MAC address details.

### Networks

Only visible if the internal wireless is in **Client Mode** when the device is selected. Shows a list of all networks (hotspots) available for connection. Select the name of the desired network to enter its network key and connect to it.

### Network Name (SSID)

Displays the name of the internal wireless network.

Only visible if the internal wireless is set to **Access Point** (Internal Wifi) mode when the device is selected. You can select it and change the internal wireless network to any name you want for easy identification.

### Network Key

Required by the smartphone or tablet to connect to the internal wireless network.

Only visible if the internal wireless is set to **Access Point** (Internal Wifi) mode when the device is selected. You can select it and change it to increase network security. The key must be at least 8 characters.

### Channel

Only visible if the internal wireless is set to **Access Point** (Internal Wifi) mode when the device is selected. Select it to change the Channel setting to overcome potential interference to the internal wireless by another RF device transmitting in the same frequency band.

### Restore defaults

Deletes all user made changes, and restores the wireless to factory settings.

## Client settings

Opens the Wireless Client Settings dialogue, which shows networks previously connected to, regardless of whether they are currently visible or not. Allows deletion of a network from the list, and toggling of Automatic connection setting.

## Advanced

Tools are available within the software to assist in fault-finding and setting up the wireless network.

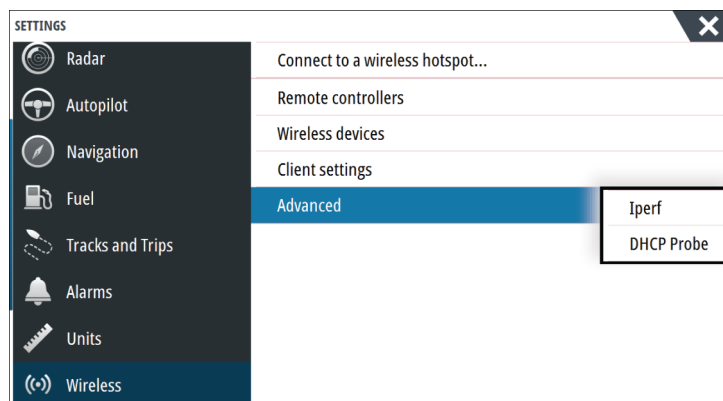

### Iperf

Iperf is a commonly used network performance tool. It is provided for testing wireless network performance around the vessel so weak spots or problem areas can be identified. The application must be installed on and run from a tablet device.

The NSS evo3 must be running Iperf server before initiating the test from the tablet. On exiting the page, Iperf automatically stops running.

### DHCP Probe

The wireless module contains a DHCP server that allocates IP addresses for all the MFDs, and Echosounder in a network. If integrating with other devices, such as a 3G modem or satellite phone, other devices in the network may also be acting as DHCP servers. To make it easy to find all DHCP servers on a network, dhcp\_probe may be run from the NSS evo3. Only one DHCP device may be operational on the same network at a time. If a second device is found, turn off its DHCP feature if possible. Refer to the device's own instructions for further assistance.

→ **Note:** Iperf and DHCP Probe are tools provided for diagnostic purposes by users familiar with network terminology and configuration. Navico is not the original developer of these tools, and cannot provide support related to their use.

## Simultaneous Client and Access Point operation

If it is desirable to have the MFD accessible to a tablet while also having internet access for GoFree store and Insight Genesis, it is necessary to use two wireless units - one must be in Client mode, the other in Access Point mode. This can be a combination of internal wireless and an external WIFI-1, or two external WIF-1 units. Two external WIFI-1 units will offer the advantage of providing both features to all MFDs on the network (where applicable).visible or not.

## NMEA 0183 setup

The NMEA 0183 port must be set to suit the speed of connected devices, and can be configured to output only the sentences required by listening devices.



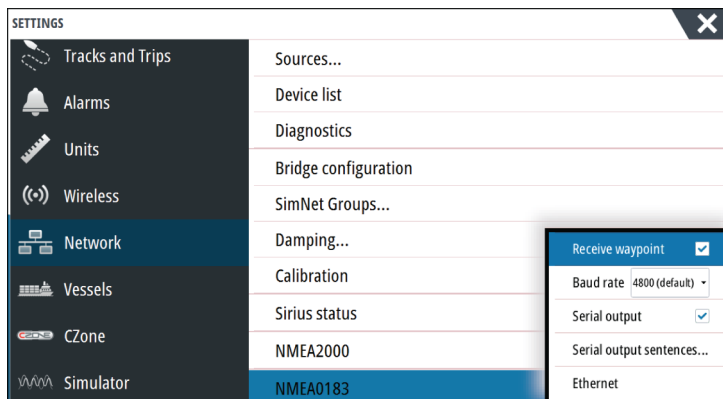

### Receive waypoint

Select this option to allow a device capable of creating and exporting waypoints via NMEA 0183 to transfer directly to this unit.

### Baud rate

This should be set to correspond with devices connected to the NMEA 0183 input and output. The input and output (Tx, Rx) use the same baud rate setting.

→ **Note:** AIS transponders typically operate at NMEA 0183-HS (high speed), and will require the baud rate to be set to 38,400.

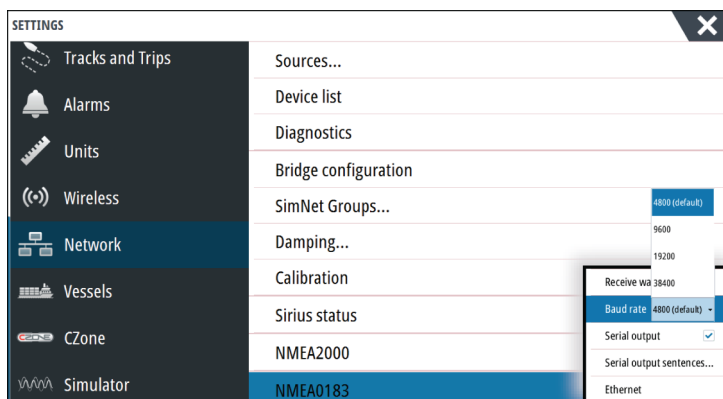

### Serial Output

Selection determines whether the data is output via Tx lines, and will enable editing of the output sentences list.

### Serial Output Sentences

This list allows control over which sentences need to be transmitted to other devices from the NMEA 0183 port. Due to the limited bandwidth of NMEA 0183 it is desirable to only enable the data that is required. The less sentences that are selected, the higher the output rate of the enabled sentences.

Commonly used sentences are enabled by default.



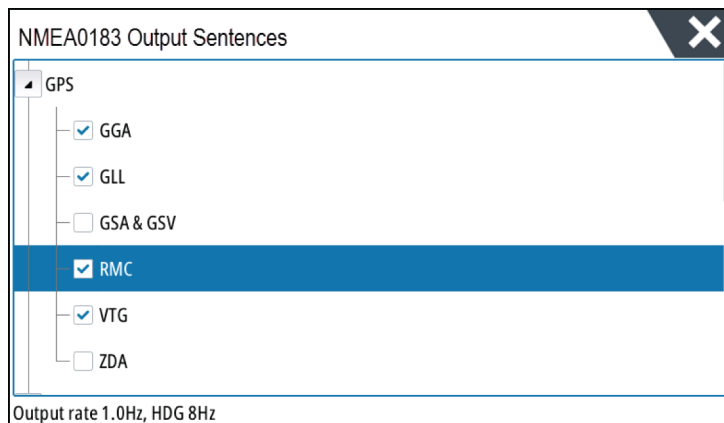

### NMEA 0183 over Ethernet

NMEA 0183 data stream is also output over ethernet, which is made available to tablet devices and PCs, via the internal wireless. The ethernet dialogue provides IP and port data typically required for configuring the application on the third party device.

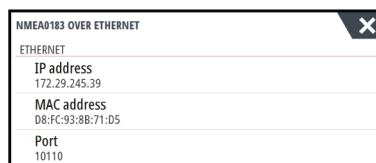

→ **Note:** Other MFDs cannot decode this information back to NMEA 0183, to use the data as a source. To share data a physical NMEA 2000 or NMEA 0183 connection is still required.

### NMEA 2000 setup

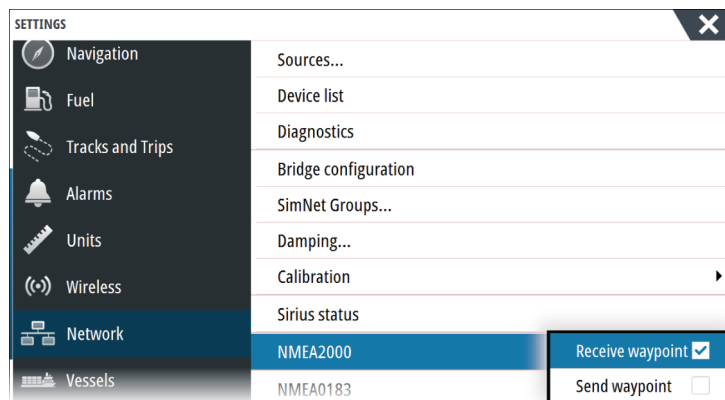

#### Receive waypoint

Select this option to allow another device capable of creating and exporting waypoints via NMEA 2000 to transfer directly to this unit.

#### Send waypoint

Select this option to allow this unit to send waypoints to another device via NMEA 2000.

### Ethernet setup

No special setup is required for establishing an ethernet network, it is all *plug-and-play*. An optional ethernet expansion device connected between the unit and another network

module (e.g. 4G radar) will automatically start working, and relay data between the two devices.

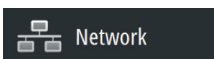

## Diagnostics

The UDB (User Data Base) tab on the diagnostics page, provides information on Ethernet activity, as shown below.

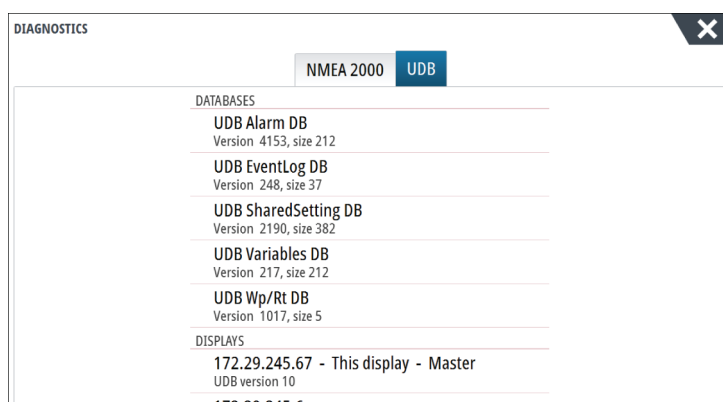

The **Reset Display List** option can be used to refresh the list of connected displays and their UDB version.

### Databases

The upper table gives an account of the various automatically synchronised databases that ensure units are all using the same user settings and data. Each unit stores the database locally, so that all information is available if the device is run in standalone.

Databases can become unsynchronised when one or more displays in a multi display network are not powered up while other displays are being operated. Creation of waypoints, routes, tracks, and altering global settings all affect databases.

When the check-box **Dirty** is selected, the unit has identified that its database is older than that of another device on the network. The check-box should clear within seconds of both devices being powered up, and the databases synchronising. If it does not clear, it is recommended that all devices are power cycled.

### IP address

The lower table shows the IP address of the display being viewed (top of list), the Master display (with **This display** next to it), and any other displays in a multiple display network.

The function of the Master is invisible to the end user - It manages database synchronization, however this task automatically shifts to another display if the current master is shut down.

The IP address list only refreshes after all devices on the network have been powered down - a single device that is shutdown on the network will not be removed from the table shown on other devices. When powering up a system that has been completely shutdown, a network connectivity issue can be identified if a display does not show any other IP addresses than its own.

The **UDB version** is dependant on the software version installed on the display. It will never change on its own, unlike the **Version** of the Databases on the upper table. It is preferable to have all UDB versions the same. This can usually be achieved by loading the latest software on to your display - refer to "*Software upgrades*" on page 43.

### Module network light

The network LED on network expansion devices can be useful for determining if the network is fundamentally operational. No light indicates no connection. A rapidly blinking green LED means the network module is communicating with another device.

## FLIR camera setup

The FLIR M-series cameras are plug and play when used in conjunction with the WIFI-1 acting as a DHCP host. For setup on networks not utilizing a DHCP host, refer to the website [www.simrad-yachting.com](http://www.simrad-yachting.com), or contact technical support.

## Mercury®

If the unit is on the same NMEA 2000 network as a Mercury VesselView® 4, 7, 403, 502, 702, 703, or Link, a host of Mercury® specific features are automatically unlocked on the unit. When the features are enabled, the display may prompt the user for some basic configuration information. Refer to the VesselView® manual or engine supplier for further information.

## Suzuki Marine®

If the unit is on the same NMEA 2000 network as a Suzuki C10 color gauge, a dedicated Suzuki instrument panel is unlocked and automatically enabled. Data source selection is done the same way as for any regular NMEA 2000 sources.

## Software updates and data backup

From time to time we release software updates to our existing products. Updates are created for a variety of reasons; to add or improve features, to add support for new external devices, or to fix software bugs.

Updates can be found on the website: [www.simrad-yachting.com](http://www.simrad-yachting.com)

When the unit is connected to the internet, a pop-up can appear advising that a software update is available and encourages you to download the update.

The unit may be used to apply software updates to itself, and to supported network devices, with files read off a memory card inserted in the card reader.

Before initiating an update to the unit itself, be sure to back up any potentially valuable user data.

## Network analyzer and service assistant

The system has a built-in service assistant that creates a report of the devices installed on the NMEA 2000 and Ethernet network such as the software versions, serial numbers, and information from the settings file to assist in technical support enquiries.

To use the analyzer, open the About page of the System settings dialog and select Support. Two options are displayed:

### Create report

Analyzes your network and prompts you for information required for support and creates the report with information automatically gathered from the network. You can add screenshots and log files that will be attached to the report. There is a 20MB limit for the report attachments. You can save the report to a memory card and email it to support or upload it directly if you have an internet connection. If you call technical support first, you can enter an incident number to assist with tracking.

### Check system for updates

Analyzes your network and checks if updates are available for compatible devices.

→ **Note:** Connect your unit to the internet to check for the latest available software versions. The software versions will be up to date as of the last time you updated your unit or connected to the internet.

## Software upgrades

The update file must be loaded to the root directory of the memory card.

The update may be initiated at boot up: insert the memory card into the card reader before turning the unit on, boot the unit, and follow the on-screen instructions.

Alternatively, in the Files menu, locate the update file on the memory card inserted in the card reader and select **Upgrade**, followed by **This Display**. Accept the prompt to reboot

the unit, and wait a few moments as the unit restarts. Do not remove the memory card or repower the unit until the process is completed (this typically takes no more than a couple of minutes).

### NMEA 2000 device upgrades

The update file must be loaded to the root directory of a memory card inserted in the card reader.

1. Select the Files toolbar option and select the update file under Memory card.
  2. Select the Upgrade option presented when the file is highlighted. A list should appear displaying any compatible devices the update file applies to. In most cases this will be a single device.
- **Note:** If no device is shown, check that the device to be updated has power, and run any outstanding updates for the unit first.
3. Select the device and initiate the upgrade. Do not interrupt the upgrade process.

### Backing up and Importing user data

There are two files that can be backed up that relate to user changes made to the system:

- Waypoints, Routes, and Tracks database.
- Settings database (includes preferences such as unit settings, custom pages, and CZone configuration files).

Insert a memory card into the unit's card reader as a storage location for backup data.

#### Waypoints, Routes, and Tracks database backup

You can export all Waypoints, Routes, and Tracks, or export only those contained within a specific region.

If Export Region is selected, the chart page will be displayed, centered on vessel location. Using the touch screen, adjust the red boundary box to outline the area to be exported. The export option offers different file formats to save as:

- **User data file version 5:** Use with current units (NSO evo2/3, NSS evo2/3, NSS, NSO, NSE, Zeus, Zeus Touch, HDS Gen2, HDS Gen2 Touch, HDS Gen3, HDS Carbon, GO XSE units, Vulcan units, and ELITE Ti units). Offers most detail.
- **User data file version 4:** Use with current units (NSO evo2/3, NSS evo2/3, NSS, NSO, NSE, Zeus, Zeus Touch, HDS Gen2, HDS Gen2 Touch, HDS Gen3, HDS Carbon, GO XSE units, Vulcan units, and ELITE Ti units).
- **User data file version 3 (with depth):** Use with legacy GPS chartplotters.
- **User data file version 2 (no depth):** Use with legacy GPS chartplotters.
- **GPX (GPS Exchange, no depth):** Use with some other manufacturers' GPS products, and PC applications.

After you select the file type, select Export and destination memory card. The receiving GPS/PC typically needs to be set to allow import of Waypoints.

#### Settings database export

Select **Setting database** to export the Settings database, or export CZone configuration (CZone installation dependent). Choose the desired option and select the memory card destination.

#### Importing a database

Later, if the unit has been restored to factory defaults or user data is accidentally deleted, return to the files page, select the backed up file, and then **Import**. View file details for creation date.

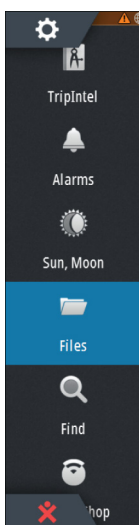

# 6

## Accessories

The most up-to-date accessories list is available at: [www.simrad-yachting.com](http://www.simrad-yachting.com)

### NSS evo3 accessories

Part number	Description
000-00129-001	NSS EVO3 & ZEUS3 - VIDEO/NMEA 0183 CABLE
000-13748-001	NSS EVO3 & ZEUS3 CHART CARD DOOR
000-13740-001	NSS7 EVO3 SUN COVER
000-13741-001	NSS9 EVO3 SUN COVER
000-13742-001	NSS12 EVO3 SUN COVER
000-13743-001	NSS16 EVO3 SUN COVER
000-13749-001	NSS7 EVO3 & ZEUS3 – 7 EDGE BEZELS
000-13750-001	NSS9 EVO3 & ZEUS3 – 9 EDGE BEZELS
000-13751-001	NSS12 EVO3 & ZEUS3 – 12 EDGE BEZELS
000-13752-001	NSS16 EVO3 & ZEUS3 – 16 EDGE BEZELS
000-13753-001	NSS7 EVO3 & ZEUS3 - 7 DASH MOUNT KIT
000-13754-001	NSS9 EVO3 & ZEUS3 - 9 DASH MOUNT KIT
000-13755-001	NSS12 EVO3 & ZEUS3 - 12 DASH MOUNT KIT
000-13756-001	NSS16 EVO3 & ZEUS3 - 16 DASH MOUNT KIT
000-13757-001	NSS7 EVO3 & ZEUS3 - 7 MOUNTING BRACKET
000-13758-001	NSS9 EVO3 & ZEUS3 - 9 MOUNTING BRACKET
000-13759-001	NSS12 EVO3 & ZEUS3-12 MOUNTING BRACKET
000-13760-001	NSS16 EVO3 & ZEUS3-16 MOUNTING BRACKET

# 7

## Supported data

---

### NMEA 2000 compliant PGN List

#### NMEA 2000 PGN (receive)

59392	ISO Acknowledgement
59904	ISO Request
60928	ISO Address Claim
126208	ISO Command Group Function
126992	System Time
126996	Product Info
127237	Heading/Track Control
127245	Rudder
127250	Vessel Heading
127251	Rate of Turn
127257	Attitude
127258	Magnetic Variation
127488	Engine Parameters, Rapid Update
127489	Engine Parameters, Dynamic
127493	Transmission Parameters, Dynamic
127503	AC input status
127504	AC Output Status
127505	Fluid Level
127506	DC Detailed Status
127507	Charger Status
127508	Battery Status
127509	Inverter Status
128259	Speed, Water referenced
128267	Water Depth
128275	Distance Log
129025	Position, Rapid Update
129026	COG & SOG, Rapid Update
129029	GNSS Position Data
129033	Time & Date
129038	AIS Class A Position Report
129039	AIS Class B Position Report
129040	AIS Class B Extended Position Report
129041	AIS aids to Navigation
129283	Cross Track Error
129284	Navigation Data
129539	GNSS DOPs
129540	AIS Class B Extended Position Report
129794	AIS aids to Navigation
129801	Cross Track Error
129283	Cross Track Error

129284	Navigation Data
129539	GNSS DOPs
129540	GNSS Sats in View
129794	AIS Class A Static and Voyage Related Data
129801	AIS Addressed Safety Related Message
129802	AIS Safety Related Broadcast Message
129808	DSC Call Information
129809	AIS Class B "CS" Static Data Report, Part A
129810	AIS Class B "CS" Static Data Report, Part B
130074	Route and WP Service - WP List - WP Name & Position
130306	Wind Data
130310	Environmental Parameters
130311	Environmental Parameters
130312	Temperature
130313	Humidity
130314	Actual Pressure
130576	Small Craft Status
130577	Direction Data

### **NMEA 2000 PGN (transmit)**

126208	ISO Command Group Function
126992	System Time
126996	Product Info
127237	Heading/Track Control
127250	Vessel Heading
127258	Magnetic Variation
128259	Speed, Water referenced
128267	Water Depth
128275	Distance Log
129025	Position, Rapid Update
129026	COG & SOG, Rapid Update
129029	GNSS Position Data
129283	Cross Track Error
129284	Navigation Data
129285	Route/Waypoint Data
129539	GNSS DOPs
129540	GNSS Sats in View
130074	Route and WP Service - WP List - WP Name & Position
130306	Wind Data
130310	Environmental Parameters
130311	Environmental Parameters
130312	Temperature
130577	Direction Data

## NMEA 0183 supported sentences

### TX / RX - GPS

<b>Receive</b>	GGA	GLL	GSA	GSV	VTG	ZDA	
<b>Transmit</b>	GGA	GLL	GSA	GSV	VTG	ZDA	GLC

### TX / RX - Navigation

<b>Receive</b>	RMC				
<b>Transmit</b>	AAM	APB	BOD	BWC	BWR

<b>Receive</b>					
<b>Transmit</b>	RMC	RMB	XTE	XDR	

### TX / RX - Sonar

<b>Receive</b>	DBT	DPT	MTW	VLW	VHM
<b>Transmit</b>	DBT	DPT	MTW	VLW	VHM

### TX / RX - Compass

<b>Receive</b>	HDG	HDT	HDM
<b>Transmit</b>	HDG		

### TX / RX - Wind

<b>Receive</b>	MWV	MWD
<b>Transmit</b>	MWV	MWD

### TX / RX - AIS / DSC

<b>Receive</b>	DSC	DSE	VDM
----------------	-----	-----	-----

→ **Note:** AIS sentences are not bridged to or from NMEA 2000.

### TX / RX - MARPA

<b>Transmit</b>	TLL	TTM
-----------------	-----	-----

→ **Note:** These are only output sentences.



# 8

## Technical specifications

→ **Note:** The most up-to-date specifications list is available at: [www.simrad-yachting.com](http://www.simrad-yachting.com)

### Technical specifications

<b>Approvals</b>	
<b>Compliance</b>	FCC, Industry Canada, Radio Equipment Directive, ACMA, RSM
<b>Display</b>	
<b>Resolution</b>	
7" unit	1024 x 600
9" unit	1280 x 720
12" unit	1280 x 800
16" unit	1920 x 1080
<b>Type</b>	High Visibility SolarMax HD® IPS optically bonded TFT
<b>Brightness</b>	1200 nits
<b>Touch screen</b>	Full touch screen (multi-touch)
<b>Viewing angles in degrees</b> (typical value @ contrast ratio = 10)	80° top/bottom, 80° left/right
<b>Electrical</b>	
<b>Supply voltage</b>	12/24 V DC (10 - 31.2 V DC min - max)
<b>Power consumption - Max</b>	
7" unit	20 W +- 4 W
9" unit	23 W +- 4 W
12" unit	30 W +- 5 W
16" unit	45 W +- 5 W
<b>Recommended fuse rating</b>	
7" unit	3 A
9" unit	3 A
12" unit	5 A
16" unit	5 A
<b>Environmental</b>	
<b>Operating temperature range</b>	-15°C to +55°C (5°F to 131°F)
<b>Storage temperature</b>	-20°C to +60°C (4°F to 140°F)
<b>Waterproof rating</b>	IPX 6 and 7
<b>Humidity</b>	IEC 60945 Damp heat 66°C (150°F) @ 95% relative (48 hr)
<b>Shock and vibration</b>	100 000 cycles of 20 G
<b>GPS</b>	10Hz high speed update. WASS, MSAS, EGNOS, GLONASS
<b>Interface/Connectivity</b>	
<b>Ethernet</b>	
7" unit	1 Port
9" unit	1 Port
12" unit	2 Ports

16" unit	2 Ports
<b>NMEA 2000</b>	Micro-C (1)
<b>NMEA 0183</b>	1 input/output. 4800, 9600, 19200, 38400 baud - via optional adaptor cable
<b>Video input</b>	2 x Composite video RCA - via optional adaptor cable
<b>Data card slot</b>	2x microSD
<b>Wireless</b>	Internal 802.11b/g/n
<b>Bluetooth</b>	Internal
<b>Physical</b>	
<b>Dimensions (W x H x D)</b>	Refer to "Dimensional drawings" on page 51
<b>Weight (display only)</b>	
7" unit	1.1 kg (2.42 lbs.)
9" unit	1.41 kg (3.11 lbs.)
12" unit	3.1 kg (6.83lbs.)
16" unit	4.65 kg (10.25lbs.)
<b>Compass Safe Distance - Metric, imperial</b>	50 cm
<b>Mounting type</b>	Bracket (Supplied) or panel mount
<b>Autopilot</b>	
<b>Manouveres / Turn patterns</b>	U-turn, Spiral-turn, C-turn, Zig-zag, Square-turn, Lazy S-turn, Depth contour tracking
<b>Steering modes</b>	Auto, Nav., No Drift, Follow up, Non-follow up, Turn patterns, Standby, *Wind, *Wind Nav. (*Boat type set to Sail)
<b>Sonar</b>	
<b>Sonar frequency</b>	40-250kHz 455-800kHz
<b>Sonar output power</b>	1kW RMS
<b>Warranty Period</b>	3 Years

# 9

## Dimensional drawings

### 7" Unit dimensions

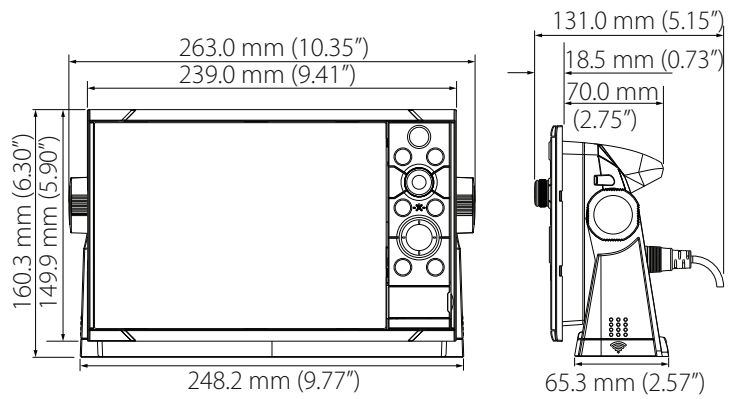

### 9" Unit dimensions

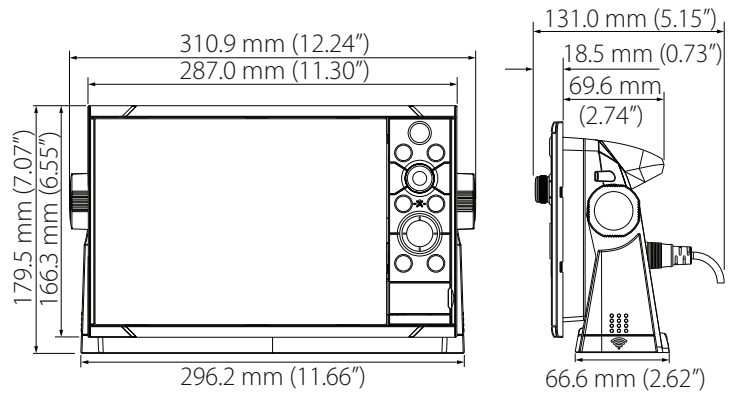

## 12" Unit dimensions

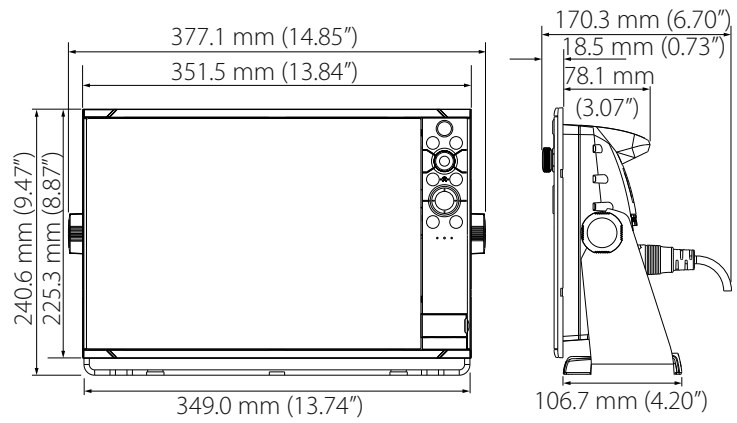

## 16" Unit dimensions

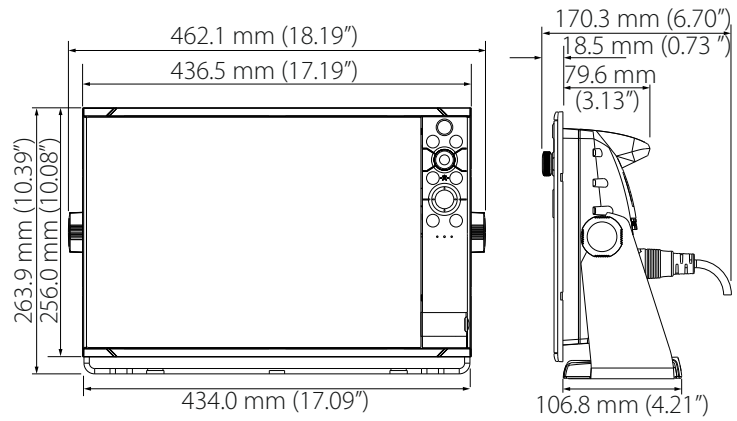

# Index

---

## A

- Advanced Source Selection 25
- Alarm
  - External Alarm Setup 27
- Auto select
  - sources 25

## B

- Back up
  - CZone configuration file 36
  - User data 44
- Backlight control
  - CZone 36
- Boat
  - Setup 33
- Bracket mounting 12

## C

- Calibrate
  - Fuel 34
- Card reader 10
- Channel
  - GoFree device 38
- Configuration file
  - CZone, Import and backup 36
- Countries of intended use in the EU 4
- CZone
  - Backlight control 36
  - Configuration 35
  - Dipswitch 36
  - Display at startup 36
  - Enabling 35
  - Export CZone config 44
  - Import and backup a configuration file 36
  - NMEA 2000 connection 21
  - Setup 35

## D

- Damping 27
- Data backup 43
- Data source selection 24
- Database
  - Backup 44
  - Export settings 44
  - Import 44
- Date format 24
- Depth offset 28
- Device list 26
- DHCP
  - Probe, wireless tool 39
- Diagnostics 26
- Dipswitch
  - CZone devices settings 36

## E

- Echosounder

- Depth offset 28
  - Setup 27
- Engines
  - Setup 33
- Ethernet expansion devices 22
- Export
  - Region 44
  - CZone config 44
  - Database backup 44
  - Database export settings 44
  - Waypoints, Routes, and Tracks 44

## F

- First time startup
  - Setup wizard 24
- Flow configuration
  - Fuel flow sensor 34
- Fuel
  - Calibrate 34
  - Flow sensor configuration 34
  - Level measure 35
  - Setup 33
  - Vessel setup 33

## G

- GoFree
  - Channel setting 38
  - DHCP Probe 39
  - Iperf tool 39
  - Remote controllers 37
  - Smartphone connection 37
  - Tablet connection 36
  - Wireless device setup (phone and tablet) 36
- Group
  - Source selection 25

## I

- Import
  - CZone configuration file 36
  - Database 44
  - User data 44
- Installation
  - Mounting 11
  - Transducer 14
  - Viewing angle 12
- Internet usage 4
- Iperf, wireless tool 39

## M

- Manual
  - About 5
  - Source selection 25
- Mounting
  - Bracket 12
  - Location 11

## N

- NMEA 2000
  - CZone connection 21
  - devices upgrades 44

## O

- Overlay downscan 28

## R

- Radar
  - Setup 30
- Remote controllers
  - GoFree, wireless 37

## S

- Setup wizard
  - First time startup 24
- SimNet Groups 26
- Smartphone connection 37
- Software
  - Setup 24
- Software
  - Updates 43
  - Upgrade 43
- Source selection
  - Advanced 25
  - Auto 25
  - Group 25
  - Manual 25
- StructureScan 30

## T

- Tablet connection
  - GoFree, wireless 36
- Technical specifications 49
- Time
  - Vessel location, format 24
- Tools
  - Wireless fault finding 39
- Transducer type 29
- Transducer
  - Installation 14
  - Location 13
  - Mounting location 13
  - Prepare for installation 13

## U

- Upgrade
  - Software 43
- Upgrade
  - MEA 2000 devices 44
- User data
  - back up 44
  - Importing 44

## V

- Vessel

- Setup 33
- Video in 23
- Viewing angle 12

## W

- Warning
  - User caution 3
- Warranty 3
- Water speed averaging 29
- Water speed calibration 29
- Water temperature calibration 29
- WheelKey
  - Configure 24
- Wireless
  - Device setup (phone and tablet) 36
  - Devices details 38
  - DHCP Probe 39
  - Fault finding tools 39
  - Iperf tool 39
  - Remote controllers 37
  - Setup 36
  - Smartphone connection 37
  - Tablet connection 36





**SIMRAD**